

Nucleon-nucleon scattering matrix and its N_c scaling

Thomas D. Cohen* and Vojtěch Krejčíř†

Maryland Center for Fundamental Physics, Department of Physics,
University of Maryland, College Park, MD 20742-4111

This paper focuses on the scaling of the S-matrix for elastic nucleon-nucleon scattering at large N_c . It is argued that the logarithm of a typical S-matrix element is proportional to N_c in the regime where the large N_c limit is taken with momentum of the incident nucleons proportional N_c . The suggested scaling was previously derived within the framework of potential scattering models for purely elastic scattering in which the parameters scale the same way as in large N_c QCD. A variety of heuristic arguments strongly suggest that the same scaling holds in the realistic case where both elastic and inelastic scattering are possible.

PACS numbers: 11.15.Pg, 12.38.Aw, 12.38.Lg, 21.45.Bc

I. INTRODUCTION

Quantum chromodynamics (QCD) is strongly coupled at low and medium energies. This means that the properties of hadrons cannot be straightforwardly described within the standard framework of perturbative expansion in the coupling constant. At present, it is possible to compute some hadronic properties directly from QCD using numerical methods on the lattice [1], and it will become increasingly possible to compute others with increasing computer power.

However, it is still useful to have analytical tools which give us insights into the underlying dynamics. One of the alternative approaches is to work in the limit of a large number of colors and identify the corrections using the $1/N_c$ expansion. This approach was originally suggested by 'tHooft [2] who realized that the number of colors may be treated as a free parameter and that in the limiting case of $N_c \rightarrow \infty$ many aspects of the QCD simplify due to the combinatoric properties of diagrams. The extension of the large N_c method to baryons was introduced by Witten [3].

Although the large N_c limit proved to be quite useful in understanding of qualitative—and in some cases semi-quantitative—aspects of the meson and baryon physics, its utility for the phenomenology of nuclear physics is far less clear [4]. The difficulty is the following: nuclear physics has scales which are much smaller than typical hadronic scales. So far we know that these scales result from delicate cancellations which occur at $N_c = 3$, but which are not expected to hold in general. A classic example is the deuteron—the only bound two-nucleon state. Its binding energy is only 2.2 MeV. Yet, by N_c counting rules one expects the deepest bound state to be bound by an energy of order N_c , *i.e.* of a similar scale to the nucleon mass.

Regardless of its phenomenological utility, it is interesting to consider nuclear phenomena at large N_c since

it may give insights into the nuclear problem in a regime where one has a systematic control parameter. In many ways, the most basic ingredient in nuclear physics is the interaction between nucleons and it is useful to understand such interactions at large N_c . However this raises an interesting question: how does one characterize the interaction in a form which has a well-defined scaling with N_c ?

To date there have been several ways proposed to characterize these interactions. The most straightforward way is via the nucleon-nucleon potential [5, 6]. The overall strength of the interaction is large, it scales with N_c . However, the potential has various spin-flavor structures and relative strength of these are fixed by the emergent contracted $SU(4)$ spin-flavor symmetry of baryons at large N_c [7–12]. The patterns of strengths seen in phenomenological nucleon-nucleon potential match these rather well. These patterns are precisely what one would expect from one-meson exchange potentials with appropriate symmetry structure [13]. It is interesting to ask whether a meson-exchange picture of nuclear interactions is consistent with large N_c dynamics. It has been shown that cancellations occur between the crossed diagram and retardation effects in the box graphs on the level of two-meson exchange; together with the contracted $SU(4)$ symmetry, these cancellations ensures that the desired large N_c behavior is preserved at the order of two-meson exchange [13]. The situation for higher meson exchange becomes quite complicated, but it appears that the meson-exchange picture is consistent with the N_c scaling of the potentials [14, 15].

However, there is an important drawback to the use of potentials as a way to characterize the N_c scaling behavior of nucleon-nucleon interactions. Potentials are not physical quantities by themselves. They are only inputs into a particular formalism for computing observables and unitarily equivalent theories can have potentials with completely different N_c scaling [15]. Clearly, it is important to determine the N_c scaling of physical quantities rather than of a theoretical construct—as is the case of the nucleon-nucleon potential. The analysis of behavior of physical observables in nucleon-nucleon scattering appears to be a sensible way to do this.

*Electronic address: cohen@physics.umd.edu

†Electronic address: vkrejcir@umd.edu

The first description of nucleon-nucleon scattering at large N_c comes from a classic paper of Witten [3]. He proposed the use of time-dependent mean-field theory (TDMFT) as the proper tool to study nucleon-nucleon scattering. In doing so he made a key observation, namely that a smooth large N_c limit does not emerge in TDMFT if one takes the incident momenta of the nucleons to be independent of N_c as in meson-meson scattering. Rather, to get a smooth large N_c limit one needs

$$p_{\text{incident}} \sim N_c, \quad (1)$$

which, given the N_c scaling of the mass, corresponds to fixed *velocity*.

TDMFT can be used to deduce the N_c scaling of physical observables. To get a sense of what can be deduced, consider a TDMFT for a model which embodies the N_c scaling—the Skyrme model [16]. TDMFT for the Skyrme model amounts to calculations in classical field theory. In such a model one needs to set up initial conditions of two solitons approaching each other with fixed impact parameter. As the two nucleons collide in such calculations, classical pion fields are radiated which corresponds to the emission of pions. By integrating over the impact parameter and initial spin-flavor orientations, one can deduce quantities such as the outward energy flow as a function of angle (which scales as N_c^1) or the baryon number flow (which scales as N_c^0) [13]. Since the baryon number is ultimately contained in single baryons and not in the mesons, one can describe the baryon flow in terms of an inclusive differential cross section [17]—namely the differential cross section for the baryon to end up in a certain direction averaging over all possible pion emission. One interesting result of such an analysis is that the N_c scaling depends on the spin and isospin of the incident nucleons [13, 17, 18] due to the contracted $SU(2N_f)$ symmetry which emerges in large N_c QCD [9].

However, TDMFT has a fundamental limitation: it cannot predict S-matrix elements. Since the S-matrix is at the core of quantum scattering theory, it is particularly important to make contact with it at large N_c . To understand the difficulty with TDMFT, consider again scattering in the context of a Skyrme model which, as noted above, involves the emission of classical pion fields corresponding to the radiation of physical pions. However, in the calculation one only has the classical pion field and thus the connection with the particular quantum channels involving the emission of pions is lost. Moreover, the strength of the pion field in such models is proportional to $\sqrt{N_c}$, the number of pions emitted is proportional to the field strength squared so the number of pions in a given process grows with N_c . Thus, the time-dependent-mean-field theory calculations describes an average over very different quantum processes as N_c is varied.

This paper focuses on the N_c dependence of the S-matrix for elastic scattering in Witten kinematics of Eq. (1). Although the nucleon-nucleon interaction is strong, scaling as N_c^1 , the S-matrix in any given partial wave clearly cannot scale linearly with N_c as this

would violate unitarity. Recently, it was argued [19] that S-matrix elements in any given partial wave are non-analytic in N_c —that they are scaling exponentially in N_c :

$$\log(S_{\tilde{J}}^{NN})_{c^i;c^f} \sim N_c, \quad (2)$$

where $\tilde{J} = J/N_c$ and J specify angular momentum; c^i and c^f represents the additional quantum number for the initial and final states. These include the spin projections of each of the two particles and the third component of the isospin for each of the two particles. This scaling is important. From this form it is possible to derive [19] the total nucleon-nucleon cross-section:

$$\sigma^{\text{total}} = \frac{2\pi \log^2(N_c)}{m_\pi^2}, \quad (3)$$

with the corrections of relative order $\log(\log(N_c))/\log(N_c)$.

The detailed analysis in Ref. [19] in which Eq. (2) was first derived is based on a very simplified model: that of spinless nucleons (as one would have for even N_c) in the nonrelativistic regime with momenta of order N_c and interacting via an elastic potential. The various quantities in the model are taken to scale as the analogous ones do in large N_c QCD. Clearly such a derivation is heuristic as applied to QCD. It was argued briefly in Ref. [19] that the scaling is generic and will continue to hold in large N_c QCD. For this to be true the complications introduced by large N_c QCD should not change the fundamental result. There are several of these complications. The most pressing of these is the existence of inelastic channels which renders the elastic S-matrix non-unitarity. Other complications include the spin of the nucleon (for N_c odd) and relativistic kinematics.

In this paper we present several arguments that Eq. (2) does in fact hold generally in large N_c QCD. All of the arguments are, to one extent or another, heuristic. Taken together, we believe that they form a compelling argument. This paper is organized as follows: In the next several sections, we will consider two-flavor QCD and take N_c to be even and nucleons to be spinless and isoscalar. This simplifies the discussion since the elastic S-matrix only depends on angle and a treatment via a partial wave analysis is simple. The first of these sections will give very simple heuristic arguments that both the real and imaginary part of the logarithm of the S-matrix scale as N_c . While these are not completely compelling, they are highly suggestive. These formulations while falling short of a mathematical proof should be sufficient to make it extremely plausible that the logarithm of the S-matrix in Witten kinematics scales as N_c . Following this, is a section in which it is shown that the inclusion of the nucleon's spin does not alter the results and thus Eq. (2) is justified. Finally, we conclude with a brief discussion of the results and their implications for phenomenology.

II. HEURISTIC ARGUMENTS

This section gives some simple heuristic arguments as to why the logarithm of the S-matrix in Witten kinematics scales as N_c . As noted above, we will assume for simplicity that N_c is even and that nucleons are, accordingly, spinless and isoscalar.

A. A simple scaling argument

At the simplest level, let us note that the the S-matrix can be expressed as [20]

$$\hat{S} = \lim_{t \rightarrow \infty} e^{i\hat{H}_0 t} e^{-2i\hat{H}t} e^{i\hat{H}_0 t}, \quad (4)$$

where \hat{H} is the QCD Hamiltonian which encodes the full interaction between hadrons. \hat{H}_0 is the “free hadronic Hamiltonian” which governs the propagation of hadrons that do not interact. This free Hamiltonian is free at the hadronic level and hence is an extremely complicated object in QCD—at the level of quarks and gluons. However, for our purposes we do not need to construct it explicitly—all that matters are its scaling properties. According to standard counting rules [3], both full Hamiltonian \hat{H} and non-interacting Hamiltonian \hat{H}_0 are linearly proportional to N_c when acting on the space of states which correspond at early times to wave packets for two nucleons propagating towards each other with Witten kinematics. Moreover, the difference between the full Hamiltonian \hat{H} and the non-interacting Hamiltonian \hat{H}_0 , which characterizes the interaction itself, is also of order N_c [3, 6]. It is accordingly useful to rewrite \hat{H}_0 as $N_c \hat{H}_0$ and \hat{H} as $N_c (\tilde{\hat{H}}_0 + \tilde{\hat{H}}_I)$ where the tildes indicate that the operators are independent of N_c . One thus is allowed to rewrite the S-matrix as

$$\hat{S} = \lim_{t \rightarrow \infty} e^{iN_c \hat{H}_0 t} e^{-2iN_c (\tilde{\hat{H}}_0 + \tilde{\hat{H}}_I) t} e^{iN_c \hat{H}_0 t}. \quad (5)$$

From Eq. (5), the interaction acts to affect the exponential of the S-matrix. Note, moreover, that the characteristic range of the nucleon-nucleon interaction is independent of N_c and that the velocity of nucleons in Witten kinematics is also independent of N_c . Thus during the collision process, the nucleons interact for a characteristic time which is independent of N_c . Since the effect of the interaction on the S matrix occurs during such a time of order one, and the strength of the interaction is of order N_c one expects an overall effect of the interaction—which occurs in the exponential of the S-matrix—to be order N_c .

Of course, the preceding argument is blatant hand-waving. The objects under study are quantum operators and one needs to worry that operator ordering effects could radically change the scaling behavior in the exponential. At the same time, this argument *is* rather suggestive.

B. A toy model

Consider a model in which only elastic nucleon-nucleon scattering is possible, the nucleons are spinless and the system is spherically symmetric so that the angular momentum is conserved. In the center-of-mass, the only relevant degrees of freedom are the three spatial components of the relative distance between the particles. Suppose further that an artificial parameter N_c is introduced and the parameters of the theory scale with N_c in the same way as do their counterparts in QCD: the mass and the the interaction strength (taken to be for a local interaction) both scale linearly with N_c . For simplicity, assume also that only the leading order behavior in N_c is retained. It is easy to see that the Hamiltonian for the theory is of the form:

$$H(\vec{q}, \vec{p}) = N_c \tilde{h}(\vec{q}, \vec{p}) \text{ with } \vec{p} \equiv \vec{p}/N_c. \quad (6)$$

This models differs from QCD in one profound way: it has no inelastic channels. However it is useful to analyze this model to get insights into scaling behavior at large N_c .

The model in Eq. (6) is quite similar to the model analyzed in detail in Ref. [19]; however, it is slightly generalized here in that it is not restricted to nonrelativistic kinematics. In this subsection, the scaling with N_c of the S-matrix for this model will be derived using a similar but somewhat more general formalism than was given in [19]; the formalism used here generalizes more straightforwardly to situations where inelasticity is included.

First, let us consider the classical equations of motion:

$$\begin{aligned} \dot{q}_i &= \frac{\partial \tilde{h}}{\partial \tilde{p}_i}, \\ \dot{\tilde{p}}_i &= -\frac{\partial \tilde{h}}{\partial q_i}. \end{aligned} \quad (7)$$

The important thing to notice is that the classical equation of motion for \vec{q} and \vec{p} are independent of N_c . Thus, classical scattering trajectories for fixed impact parameter b and fixed initial \tilde{p} —such as the one given in Fig. 1—are independent of N_c . One can calculate the differential cross section for the classical scattering by assuming a random initial distribution of impact parameters and matching the outgoing scattering angle to the incident impact parameter in the standard way [21]

$$\frac{d\sigma^{\text{classical}}}{d\Omega} = \frac{b(\theta)}{\sin(\theta)} |b'(\theta)|, \quad (8)$$

where $b(\theta)$ is the mapping from the scattering angle to the incident impact parameter. Thus the classical differential cross section is independent of N_c .

Quantum mechanically, the differential cross section *can* depend on N_c . However as $N_c \rightarrow \infty$, the Witten kinematics used here means that the typical momentum in the problem (which is of order N_c) is much larger than

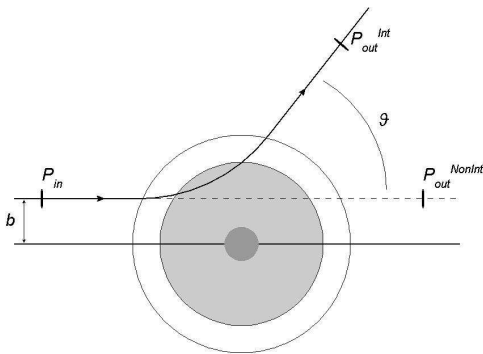

FIG. 1: A cartoon of the classical scattering.

the characteristic length scales. Thus, the large N_c limit is the semi-classical limit and one expects the classical and quantum differential cross sections to coincide (except for forward scattering which is outside the semi-classical regime). Of course, the differential cross section is determined by the S-matrix. However, the S-matrix contains phase information as well as information about the differential cross-section. Fortunately, these are related as can be seen by considering Hamilton's action integral along a fixed classical trajectory together with the general quantum mechanical form of the scattering amplitude.

Recall that for time-independent Hamiltonians in the semi-classical regime, the quantum phase in a solution of the time-independent Schrödinger equation associated with a classical trajectory is given (up to additive constants of order unity) by the action. More precisely, the phase is given by Hamilton's characteristic function $w(\vec{q}, \vec{a})$, where \vec{a} is a set of constants of motion fixed implicitly by the initial conditions. w is constructed so that $q_i = \partial_{a_i} w(\vec{q}, \vec{a})$ and $p_i = \partial_{q_i} w(\vec{q}, \vec{a})$. The classical equations of motion are fixed by a partial differential equation of the Hamilton-Jacobi form:

$$H(\vec{q}, \nabla_{\vec{q}} w(\vec{q}, \vec{a})) = E_0, \quad (9)$$

where E_0 is the energy. It is straightforward to see that for trajectories which solve the classical equations of motion, w is given by

$$w_{p,b}(\vec{q}_f) = w_0 + \int_{\vec{q}_0}^{\vec{q}_f} \vec{p} \cdot d\vec{q}, \quad (10)$$

where \vec{q}_0 is an arbitrary point chosen to be well before the scattering region, \vec{q}_f is the final point considered and w_0 is a constant depending on \vec{q}_0 and the constants of motion. Note that q_f must be along the path of interest, which depends on the angular momentum, $L = b p$. Quantum mechanically, L corresponds to a partial wave. The semi-classical phase shift for that partial wave is given by half the difference in phase between two paths—one for the actual path of the particles and the other assuming non-interacting particles, where both paths have

the particles coming in from far away with impact parameter b , momentum p and the same initial and final distances from the scattering centers. Thus, the semi-classical phase shift is given by

$$\delta_L = \lim_{R \rightarrow \infty} \left(\frac{1}{2} \int_{\hat{n}_0^R}^{\hat{n}_f^R} \vec{p} \cdot d\vec{q} - \frac{L R}{b} \right), \quad (11)$$

where \hat{n}_0^R and \hat{n}_f^R are unit vectors in the direction of the initial and final points in the path for any given R with fixed impact parameter b . Note that each term in Eq. (11) diverges but the difference is finite.

Now, consider the N_c scaling behavior of the semi-classical phase-shift. In Witten kinematics and with a fixed impact parameter, $|\vec{p}| \sim N_c$ for all points along the trajectory and $L \sim N_c$. Moreover, the region of integration where the interacting and non-interacting contributions to the action differ is independent of N_c . Thus one expects the semi-classical phase shift to be of order N_c in Witten kinematics. Moreover, Witten kinematics ensures that the system is in the semi-classical regime since the characteristic actions are much greater than unity. Thus in the large N_c and Witten kinematics with fixed L/N_c , $\delta \sim N_c$. For the case of a spineless system, this is identical to the scaling in Eq. (2) as desired. It is important to note that this is fully consistent with the result of Ref. [19].

C. Nonlocality, energy-dependence and the semi-classical limit

How generally does the analysis of the previous section apply? One important question is whether it should apply for nonlocal potentials. After all in the context of QCD the nucleon is an extended object with size of order N_c^0 and it would not be too surprising if, as a result, the potential generated between nucleons was naturally nonlocal as a result. However, the scaling result does not generally apply for nonlocal potentials—even ones with a strength of order N_c and a range of order N_c^0 .

To understand why, consider a very simple nonrelativistic Hamiltonian for a central local interaction. In terms of the relative coordinate

$$H = \frac{\vec{p}^2}{M_N} + N_c V(|\vec{x}|) = N_c \left(\frac{\vec{p}^2}{\tilde{M}} + V(|\vec{x}|) \right) \quad (12)$$

with $\tilde{M} = M_N/N_c$; the function V is independent of N_c . In Witten kinematics the energy is of order N_c^1 so one can write $E = \tilde{E} N_c$. One can postulate, that the time-independent Schrödinger equation $H\psi = E\psi$ has a solution with a wave function of the form $\psi(\vec{x}) = \langle \vec{x} | \psi \rangle = f(\vec{x}) \exp(i N_c w(\vec{x}))$ with f and w independent of N_c and verify its self-consistency. Note this form ultimately yields Eq. (2) since it has the phase proportional to N_c . Plugging this form into the the time-independent

Schrödinger equation and using our simple form of H yields:

$$\left\{ N_c^1 \left(\frac{(\vec{\nabla} w)^2}{\tilde{M}} + V(|\vec{x}|) - \tilde{E} \right) + N_c^0 \left(i \frac{\nabla^2 w + 2\vec{\nabla} w \cdot \vec{\nabla} \log(f)}{\tilde{M}} \right) + N_c^{-1} \left(-\frac{(\vec{\nabla} \log(f))^2 - \nabla^2 \log(f)}{\tilde{M}} \right) \right\} \psi = 0. \quad (13)$$

This *is* self consistent. The leading order part depends on w only. Thus, insistence that the order N_c^1 contribution vanishes allows for the solution of w given appropriate boundary conditions—one finds it is independent of N_c in both its overall size and its position dependence—as needed for self consistency. Indeed the equation for w *is* the classical Hamilton-Jacobi equation. Working at the next orders, N_c^0 and N_c^{-1} , allows one to use the previously solved w to solve for f . It too can be seen to be independent of N_c in both its overall size and its position dependence.

Now let us look at what happens for the case of a nonlocal potential of the form $N_c V(\vec{x}, \vec{x}')$ where the function $V(\vec{x}, \vec{x}')$ is independent of N_c . The time-independent Schrödinger equation is of the form,

$$-\frac{\nabla^2 \psi(\vec{x})}{N_c \tilde{M}} + N_c \int d^3 x' V(\vec{x}, \vec{x}') \psi(\vec{x}') = E \psi(\vec{x}). \quad (14)$$

If one again assumes $\psi(\vec{x}) = f(\vec{x}) \exp(i N_c w(\vec{x}))$, one finds that the potential term is of the form

$$N_c \left(\frac{\int d^3 x' V(\vec{x}, \vec{x}') f(\vec{x}') \exp(i N_c w(\vec{x}'))}{f(\vec{x}) \exp(i N_c w(\vec{x}))} \right) \psi(\vec{x}). \quad (15)$$

It is clear that the integral will suffer very large cancellations due to the oscillations induced by the complex exponential. The factor of N_c in the exponent means the rate of oscillation goes to infinity at large N_c leading to a total cancellation at the scale of the leading order. The actual order of the contribution depends on the detailed form of V , but whatever it is, it will be subleading. This is in sharp contrast to the case of a local potential where the potential contribution is of order N_c —*i.e.* leading order—and leading to phase-shifts which scale as N_c . The effect of interactions for problems with nonlocal potentials of the form $N_c V(\vec{x}, \vec{x}')$ with $V(\vec{x}, \vec{x}')$ independent of N_c is subleading and the phase shifts will not scale more slowly than N_c .

In a certain sense, this should not be too surprising. The analysis of the model in the previous section depends on the large N_c limit yielding the semi-classical limit. This is guaranteed to occur at large N_c for Hamiltonians whose leading scaling at large N_c is of the form of Eq. (6) for local interactions. However, non-local interactions do

not have a classical analog. Thus it is reasonable that the simple scaling in the classical limit induced at large N_c does not go through for nonlocal interactions.

However, this does not mean that there cannot be nonlocal interactions yielding the same N_c scaling for phase shifts as in the local case. For example, one can imagine making a class of unitary transformation of the theory that preserves the asymptotic wave functions for non-interacting particles (and hence the S-matrix) but which converts a local Hamiltonian which is of the form of Eq. (6) to one which is not. Thus, the condition for the phase shift to be proportional to N_c is not that the Hamiltonian is necessarily of the form of Eq. (6). The sufficient condition is that the Hamiltonian is unitarily equivalent to the one of that form (up to corrections which vanish at large N_c).

It is also useful to consider energy-dependent interactions. These arise naturally when degrees of freedom are integrated out. Since ultimately a two-nucleon potential in Witten kinematics must involve integrating out mesonic degrees of freedom, it is important to understand the scaling in this case too. It is straightforward to see that a theory in which the two-body wavefunction is determined by a local but energy-dependent interaction of the $N_c V(\vec{x}; E)$ in a Schrödinger equation of the form

$$\left\{ \frac{-\nabla^2}{M_n} + V(\vec{x}; E) \right\} \psi(\vec{x}) = \psi(\vec{x}) \quad (16)$$

will have the phase shifts consistent Eq. (2) since the scaling in Eq. (13) holds self-consistently—just as it does in the energy-independent case.

It is important to reconcile this scaling of the energy dependent potential with the results of Ref. [15]. In that work it was shown that, at the level of meson-exchange models, algorithms to extract the nucleon-nucleon potential from higher-order Feynman diagrams (three-meson exchange and above) did not generically respect the N_c counting for the potential of Ref. [5, 6] but that procedures which systematically remove the energy dependence had the correct scaling. It is likely, that this came about because these procedures also removed momentum dependence as a by-product.

D. Scaling for the inelasticity

One deficiency of the simple toy model of Subsection IIB is that, by construction, it contains only elastic scattering and thus purely real phase shifts. In this subsection, we give a general heuristic argument that even when inelasticity is included one also obtains scaling proposed in Eq. (2). That is, in the Witten regime with fixed impact parameter (*i.e.* fixed L/N_c), the imaginary part of the phase shift—like the real part—is of order N_c . Thus, the elastic cross-section in any given partial wave is exponentially suppressed at large N_c .

To see why this should be expected, consider the energy dissipated into the emission of mesons. It is relatively straightforward to see that in a collision in Witten kinematics, the fraction of the initial kinetic energy emitted into mesons becomes independent of N_c at large N_c —that is the total energy dissipated is of order N_c^1 since the initial energy is of order N_c^1 . Moreover, the energy distribution of the emitted mesons also becomes independent of N_c at large N_c . This means that the number of mesons emitted on average, n_{meson} , is of order N_c^1 . However, ultimately, the process is of quantum mechanical nature and thus probabilistic. In a crude sense, one might envision the system making some number of “attempts” to create a meson, n_a , each with a probability p of creating a meson within each attempt. Thus, $n_a p = n_{\text{meson}} \sim \mathcal{O}(N_c^1)$ and the probability that *no* meson is produced—*i.e.* that elastic scattering occurs—denoted P_{elastic} , is $(1-p)^{n_a} = (1-p)^{n_{\text{meson}}/p}$. Of course, there are not n_a discrete attempts. Rather there is a continuous emission of probability. One can obtain this by taking $n_a \rightarrow \infty$ and $p \rightarrow 0$ with n_{meson} fixed. This limit yields $P_{\text{elastic}} = e^{-n_{\text{meson}}}$. Thus one would expect $|S| = \exp(-n_{\text{meson}}/2)$ so that $\log |S| = -n_{\text{meson}}/2 \sim N_c$, which is in agreement with Eq. (2).

It is worth noting that the preceding argument is crude and not correct in detail. There are two aspects of the argument which are potentially problematic. The first is that quantum mechanics deals with probability amplitudes rather than probabilities. The second is that the probabilities considered are associated with the nucleons traveling on a classical trajectory associated with the emission of n_{meson} mesons on average. Whereas the relevant amplitudes should be associated with the path the nucleons follow when no mesons are emitted. These paths are different, while the emission of a single meson has a negligible effect on the path, the emission of order N_c mesons makes a change of order unity. As will be discussed below, these issues do change the value of the probability the reaction is inelastic—but do not alter fundamental scaling of Eq. (2).

Before addressing these issues, it is useful to verify that the number of mesons produced in this kinematic regime is of order N_c . An easy way to do so is via the Skyrme model [16], which is believed to capture correctly the N_c scaling behavior of QCD. The Skyrme model is given in terms of a nonlinear sigma model: its dynamical field for two-flavor QCD is a two-by-two unitary matrix U . It is easy to see that in Witten kinematics, classical equations for U with initial conditions for a two-baryon scattering problem are independent of N_c . The solutions involve the classical fields after the collision time having two solitons moving away from each other at some scattering angle and classical radiation of the U field away from the two solitons. It is straightforward to see that the fraction of energy carried away by such radiation is independent of N_c , as advertised, above yielding $n_{\text{meson}} \sim N_c$. Alternatively, one can see the result from the parametrization of U in terms of the pion field, $U = \exp\left(i\frac{(\vec{r}\cdot\pi)}{f_\pi}\right)$. From

this definition, it follows that the classical pion fields emitted in such a collision are proportional to f_π . Since $f_\pi \sim N_c^{1/2}$, it follows that the pion field strength is also $\sim N_c^{1/2}$. Since the particle number associated with the classical field is proportional to kinematic factors independent of N_c times the field strength squared, it follows that the particle number is proportional to N_c .

1. Amplitudes vs probability

The simple argument yielding $|S| = \exp(-n_{\text{meson}}/2)$ was based on a statistical treatment of independent “attempts” of the system to create mesons. However these attempts are quantum mechanical amplitudes and not independent probabilities. The difference between these is associated with quantum mechanical coherence. Thus one might worry that this fact might invalidate the result. However, this is not the case.

To see why consider a description of the scattering process in QCD in which the fundamental quark and gluon degrees of freedom are replaced by an effective hadronic theory. While such a theory will be complicated and embody nonlocalities, in principle such a description should be possible; it will correctly encode the large N_c scaling of the dynamics. Recall that the large N_c limit is essentially a classical one at the level of hadronic dynamics [3]. One might be tempted to take the classical nature of the large N_c dynamics as an indication that the quantum mechanical distinction between amplitudes and probabilities should be unimportant, thereby justifying the argument given above. However, this is not so obvious. In fact, to get an accurate description of quantum system in terms of classical meson fields one needs a very large measure of coherence at the quantum level. Indeed, one generally regards a Glauber coherent state [22] as the “most classical” quantum state with fixed expectation value for a field and its conjugate momentum. Given that we ignored coherence in the argument given above—focusing on probabilities and not amplitudes—one might worry that the derivation fails when there is significant coherence. In fact, suppose that we describe the final state in two-nucleon scattering in this hadronic language and, to capture the classical nature of the dynamics, model the mesonic sector of the quantum state after the scattering process as a coherent state. Doing so automatically yields $P_{\text{elastic}} = e^{-n_{\text{meson}}}$ for the probability that no mesons are present—precisely as found in the purely probabilistic calculation without coherence.

To illustrate this consider, a simplified model which contains only one species of meson which we take to be a scalar meson. The creation operator for a meson of momentum \vec{p} is denoted $a_{\vec{p}}^\dagger$, and it is normalized to satisfy the commutation relation $[a_{\vec{p}}, a_{\vec{p}'}^\dagger] = (2\pi)^3 \delta^3(\vec{p} - \vec{p}')$. The

most general coherent state is of the form

$$|f\rangle = \mathcal{N} \exp\left(\int \frac{d^3p}{(2\pi)^3} f(p) a_p^\dagger\right) |0\rangle$$

$$\mathcal{N} = \exp\left(-\frac{\left|\int \frac{d^3p}{(2\pi)^3} f(p)\right|^2}{2}\right) \quad (17)$$

The number operator \hat{n} is given by $\int \frac{d^3p}{(2\pi)^3} a_p^\dagger a_p$. Thus

$$n_{\text{meson}} \equiv \langle f | \hat{n} | f \rangle = \int \frac{d^3p}{(2\pi)^3} |f(p)|^2 \quad (18)$$

On the other hand, the probability that no meson exists in the state is simply $|\mathcal{N}|^2$ which is given by

$$|\mathcal{N}|^2 = \exp\left(-\left|\int \frac{d^3p}{(2\pi)^3} f(p)\right|^2\right) = \exp(-n_{\text{meson}}) . \quad (19)$$

As noted above, this is identical to the expression based on uncorrelated probabilities. Moreover, while this result was derived for a model with a single species of meson, it should be obvious that the result would be identical if the coherent state included multiple species of meson.

This result shows that coherence, *per se*, does not invalidate the result that the probability of producing no mesons is given by $\exp(-n_{\text{meson}})$. However, it does not demonstrate that the result is correct either. Indeed, the result is *not* correct in detail—although the exponential dependence on N_c is. *A priori* there is a reason to suspect that the coherent state is not adequate to describe this component of the wave function of the system. Recall, that the use of the coherent state here is as a quantum description of a semi-classical process. The true quantum description is expected to be much more complicated. However, the coherent state captures the dominant behavior of a system which creates many coherent mesons. The difficulty is that the component of the state in which no mesons are produced is an exponentially small fraction of the coherent state wave function and is thus a highly atypical configuration. There is no reason for the coherent state describing the behavior of typical components of the actual quantum state for the semi-classical process to accurately describe highly atypical ones. Moreover, as will be described below, based on a simple model developed in analogy to bremsstrahlung, there is a very good reason to believe that it does not.

2. Meson bremsstrahlung

The model discussed in this section is motivated by an analogy to electromagnetic bremsstrahlung: a process in which an ion undergoing some accelerated motion emits an electromagnetic radiation. Analogous methods may be used to analyze the emission of mesons from nucleons when they are scattered. In doing this we will assume

that the system is in the semi-classical regime. One can imagine forming an initial wave packet of each of the nucleons involved in the scattering. If the system is in the Witten limit, the wave packet should not disperse substantially over time scales of the scattering— $\mathcal{O}(N_c^0)$ —and hence acts like a classical source for the emission of mesons. For simplicity of illustration, we will analyze this process in a model with one type of mesons (a scalar) and a spinless nucleon. The model is designed to capture the N_c scaling of *QCD* by taking the meson mass to be of order N_c^0 , the nucleon mass to be of order N_c^1 and the coupling between them (which is taken to be of a Yukawa form) has a strength of order $N_c^{1/2}$. For simplicity we neglect meson-meson interactions. These simplifications should not alter the fundamental N_c scaling rules.

By assumption the system can be treated semi-classically since it is in the Witten limit. The semi-classical calculation has two parts coupled together—the mesons emission can be treated classically as arising from sources associated with the acceleration of nucleons and the nucleon's trajectory can be computed due to forces from the nucleon-nucleon interaction and from a back reaction from the mesons which are emitted. Note the analogy with bremsstrahlung: the accelerating ion in bremsstrahlung acts as a classical source for electromagnetic field whereas here an accelerating nucleon can be viewed as classical source for a meson field.

In studying the presented model, we start by focusing on half of the problem: the emission of mesons taking the nucleons trajectories to be fixed externally. Ultimately, one needs to choose these trajectories in a self-consistent manner: these trajectories need to be the ones which emerge taking into account the back reaction due to the emission of mesons. However, for the present purposes it is sufficient to assume that the path taken by the nucleons and the rate in which they follow the path are both independent of N_c at large N_c as expected in Witten kinematics [3]. The starting point for the analysis is a Lagrangian for a meson field in the presence of a classical source:

$$\mathcal{L} = \frac{1}{2} (\partial_\mu \phi)^2 - \frac{1}{2} m^2 \phi^2 - g J(x) \phi \quad (20)$$

where—and it is crucial—the scalar field's coupling to the external current g scales as $N_c^{1/2}$. The solution of the equation of motion for the meson field is:

$$\phi = g \int d^4x' \Delta_R(x-x') J(x'), \quad (21)$$

where $\Delta_R(x-x')$ is the retarded Green's function and $J(x')$ represents the source localized at the classical trajectory followed by the baryon in consideration.

On the classical level, the energy flux carried by the meson fields is given by the $(0i)^{\text{th}}$ component of the stress-energy tensor (the analog of the Poynting vector for the electromagnetic field):

$$S_i = \dot{\phi} \phi_{,i}, \quad (22)$$

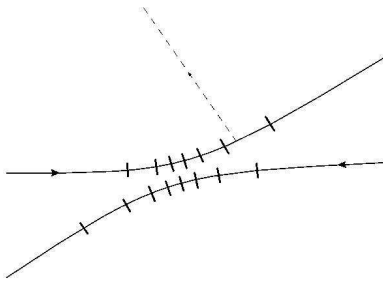

FIG. 2: A cartoon representing the classical path of the baryons during the scattering and an emission of one meson from one segment of the path

and the overall outgoing energy is calculated by integration over a surface surrounding the area of interest. The exact formula for the outgoing energy flux carried by mesons depends on the specific trajectory of the nucleon and is quite complicated. However, the N_c scaling can be deduced straightforwardly. Expression for the energy flux S_i (22) is quadratic in the field ϕ (21), which is linear in the coupling constant g . Since the trajectories are, by hypothesis, independent of N_c , g contains the only N_c dependence in the problem. From the scaling shown above, it directly follows that the energy flux is proportional to N_c :

$$\int_{\Omega} \vec{S} \sim g^2 \sim N_c. \quad (23)$$

The discussion above was based on the classical field theory point of view. Doing the proper quantization of the field in Eq. (21) is complicated and is beyond the scope of the presented paper. Fortunately, deducing the N_c scaling is possible and is precisely what was quoted earlier: the total energy carried by the field is of order N_c^1 . Since the mass and energy of a meson are of order N_c^0 in Witten kinematics, the number of particles emitted when baryon follows an accelerated classical trajectory must be of order N_c^1 .

To describe the emission process of individual mesons, let us divide the trajectory for the two baryons into s small segments each corresponding to a certain small time interval in such a way that the probability of emitting one meson p in this segment is small and probability of emitting more than one meson is negligible. One can choose the size of these segments as such that p is the same in each segment. The possible emission of a meson via bremsstrahlung in one of these segments is a concrete model for the “attempts” discussed earlier. The analysis goes through exactly as before: $n_{\text{meson}} = ps \sim N_c$ and $P_{\text{elastic}} = \exp(-n_{\text{meson}})$.

There is a subtlety which must be addressed, however. The preceding analysis was based on a fixed external trajectory for the baryons. Let us label the trajectory by T and the expected number of meson associated with that trajectory as n_{meson}^T . Note that n_{meson}^T describes

the number of mesons emitted on average if a source was forced to follow trajectory T —not necessarily the number of mesons created on average in the physical process. The precise value of n_{meson}^T clearly depends on *which* trajectory is chosen since the bremsstrahlung process depends on acceleration. However, it is also clear that provided that T is independent of N_c in both its path and the rate it follows the path, that $n_{\text{meson}}^T \sim N_c$ and thus $\log(P_{\text{elastic}}) \sim N_c$.

The correct choice for describing typical outcomes—those in which the number of mesons produced is close to the average produced by the process n_{meson} where by close we mean differing from it by order $n_{\text{meson}}^{1/2}$ —is quite clear. In that case, the correct path to use is the classical one, $T_{\text{classical}}$. This path includes the effects of the force due to the classical back reaction of the mesons on the nucleon. Thus in the large N_c limit, $n_{\text{meson}} = n_{\text{meson}}^{\text{classical}}$. However, this is clearly *not* the appropriate path to consider when describing purely elastic scattering. In the elastic scattering case, there is no back reaction and the initial and final kinetic energy of the nucleons are equal. The underlying quantum mechanical point is that the meson degrees of freedom and the baryon degrees of freedom are correlated. The correlations are such that for the bulk of the components in the state a semi-classical description is valid. However, if one were to focus on the small part of the state associated with elastic scattering, there is still a semi-classical description one could make for the motion of the nucleons. To find the classical trajectory, simply do the standard classical calculation but systematically remove the effects of back reaction. Let us denote this trajectory T_{nbr} , (where nbr stands for no back reaction). Let’s define the average number of mesons which *would have been* produced had the sources been forced to follow T_{nbr} as $n_{\text{meson}}^{T_{\text{nbr}}}$. Thus one sees that $P_{\text{elastic}} = \exp(-n_{\text{meson}}^{T_{\text{nbr}}}) \neq \exp(-n_{\text{meson}})$.

The result that $P_{\text{elastic}} \neq \exp(-n_{\text{meson}})$ is presumably generically correct. Nevertheless, note that in Witten kinematics T_{nbr} will be independent of N_c (just as $T_{\text{classical}}$ is) which in turn implies that $n_{\text{meson}}^{T_{\text{nbr}}} \sim N_c$. This in turn implies that $\log(P_{\text{elastic}}) \sim N_c$ as was true in the simple analysis yielding $P_{\text{elastic}} = \exp(-n_{\text{meson}})$. Thus, although the simple analysis yielding $P_{\text{elastic}} = \exp(-n_{\text{meson}})$ is not correct in detail, it does correctly describe the N_c scaling.

To summarize this line of reasoning, models at the hadronic level which encode the correct large N_c scaling of QCD but do not include spin and flavor degrees of freedom, when treated semi-classically reproduce the scaling in Eq. (2).

3. Complex Potentials

The preceding analysis of inelasticities was somewhat heuristic, thus it is useful to consider other ways to understand this scaling. A natural language to do so is in terms of potentials which are complex. By construc-

tion, a complex potential describes the elastic motion of the particles with a loss of flux due to inelasticity. This implies that the Hamiltonian for the system is energy-dependent. Both the non-Hermiticity and the energy-dependence arise from an underlying Hermitian and energy-independent Hamiltonian through the elimination of degrees of freedom. We note here that as a matter of principle it is always possible to describe 2-body scattering in such a language. That is, there exists a complex local but possibly energy-dependent potential which, when put into some suitable relativistic generalization of the Schrödinger equation for two body scattering, accurately reproduces all two-body observables including the S -matrix. Here, we argue that a complex potential treatment naturally gives rise to the scaling in Eq. (2). The argument has two parts: i) that *if* the imaginary part of the complex potential is of order N_c^1 then the imaginary part of $\log(S)$ is also of order N_c^1 as given in Eq. (2) and ii) that the imaginary part of the complex potential is, in fact, of order N_c^1 .

Let us begin by focusing on the first part of the argument. It starts with the fact that there exists a complex potential which accurately reproduces all two-body observables. Let us assume that in this system, the mass is of order N_c , the system is Witten kinematics and the real and imaginary part of the complex potentials are of order N_c . For simplicity, let us assume that nucleon spin and flavor play no role (an assumption we revisit in the next section). In essence, this is the model of Subsection II B, supplemented by an imaginary part of the potential to account for meson emission.

As in Subsection II B, the large N_c limit automatically pushes the system into the semi-classical regime. It is worth discussing precisely what this means in the context of a complex potential. Again one can associate the phase with Hamilton's characteristic function w for an equivalent classical problem. However, when using a complex potential, w is in general complex. The imaginary part of w —the imaginary part of the phase—characterizes the inelasticity. As in the case of a real potential, the dominant classical trajectory associated with the quantum wave function is one for which the quantum mechanical phase is stationary leading to constructive interference. This is given by the solution of the Hamilton-Jacobi equations using the real part of w . The values for the real and imaginary part of w for the trajectory which solves these with fixed l and p in Witten kinematics gives the real and imaginary part of the phase shift for large N_c dynamics. If both the real and imaginary parts of the potential are of order N_c it is clear that so is w and one obtains the scaling exactly as in Eq. (2).

The second part of the argument is that imaginary part of the complex potential is of order N_c^1 . A useful way to understand this is via the formalism of Feshbach projection operators [23]. In principle one can always reproduce the results of QCD with a hadronic model. We will take the Hamiltonian for this model to be Hermitian and independent of energy. The Hilbert space of such model

in the two baryon sector can be divided into two pieces: those components containing no mesons and those containing at least one meson. A states purely in one of these sectors are denoted $|\psi\rangle_{\text{nm}}$, and $|\psi\rangle_{\text{m}}$, respectively. By construction ${}_{\text{nm}}\langle\psi|\psi'\rangle_{\text{m}} = 0$ and the most general state in the space is of the form $|\psi\rangle = \alpha|\psi\rangle_{\text{nm}} + \beta|\psi\rangle_{\text{m}}$ with $\alpha^2 + \beta^2 = 1$. The Feshbach projection operator P projects onto the no meson space, while $Q = 1 - P$ projects onto the space containing at least one meson: $P|\psi\rangle = \alpha|\psi\rangle_{\text{nm}}$, $Q|\psi\rangle = \beta|\psi\rangle_{\text{m}}$. It is easy to show formally that if ψ solves a time dependent Schrödinger equation $H|\psi\rangle = E|\psi\rangle$, then $|\psi\rangle_{\text{nm}}$ satisfies:

$$\begin{aligned} (H_{\text{in}} + V_{\text{out}}(E))|\psi\rangle_{\text{nm}} &= E|\psi\rangle_{\text{nm}} \quad \text{with} \\ H_{\text{in}} &= 2M + T + V_{\text{in}} \equiv PHP, \\ V_{\text{out}}(E) &\equiv PHQ \frac{1}{E - H} QHP. \end{aligned} \quad (24)$$

H_{in} is the Hamiltonian acting directly in the no-meson space. It consists of a mass term for the two baryons, a kinetic energy and a potential associated with interactions which do not push the system out of the no-meson space. We will assume consistently with standard counting that V_{in} is local, with a strength of order N_c and range independent of N_c —or at any rate can be cast into that form by a unitary transformation acting in the two-nucleon space.

$V_{\text{out}}(E)$ corresponds to an interaction taking the system into the space containing mesons, propagating in that space and then another interaction taking the system back into no meson space; it is explicitly energy dependent. Unfortunately, as written V_{out} is ill-defined since the inverse operator depends on boundary conditions. The correct choice of boundary conditions should build in the fact that we are interested in propagation forward in time. This is achieved by adding an infinitesimal imaginary part to the denominator of the second term:

$$V_{\text{out}}(E) = PHQ \frac{1}{E - H + i\epsilon} QHP. \quad (25)$$

Note that from its structure $V_{\text{out}}(E)$ satisfies a dispersion type relation *at the operator level* in the two-nucleon space. In particular

$$\text{Re}(V_{\text{out}}(E)) = \int dE' \mathcal{P} \left(\frac{\text{Im}(V_{\text{out}}(E'))}{\pi(E - E')} \right), \quad (26)$$

where \mathcal{P} indicates principal part. This dispersion structure means that *if* $\text{Im}(V_{\text{out}}(E))$ is a local (or nearly local) operator in x for the two-nucleon space with a range independent of N_c and strength proportional to N_c —or can cast into such a form via a unitary transformation acting in the space containing at least one meson—then so is $\text{Re}(V_{\text{out}}(E))$. Since we expect the real part to satisfy such a behavior to reproduce the Witten scaling behavior (which as note in earlier does apply to energy dependent interactions), it is highly plausible that the imaginary

part does so as well. But this was precisely the last condition needed to show that imaginary part of the phase-shift, (*i.e.* the inelastic part of the S matrix) is consistent with Eq. (2).

4. Potential as a meson exchange

A general argument was just provided as to why it is natural for the imaginary part of the potential (and hence the imaginary part of the phase shift) in Witten kinematics to scale as N_c^1 . However, it is useful to see how this comes about in a concrete model. Here we use a simple meson-exchange picture that respects the underlying large N_c dynamics of QCD to infer the N_c scaling of both the real and the imaginary part the potential.

We start by reviewing some basic principles of a meson-exchange picture from the point of view of the N_c scaling [5, 6] and then study the role of the imaginary part. For simplicity, we will be focusing on the case of nonrelativistic kinematics. Various cancellations which occur in a transparent way in nonrelativistic systems are obscure in relativistic ones. Note, however, that at large N_c , the nucleon mass is of order N_c . Thus systems exist in which the incident nucleon velocity $v \ll 1$ but for which $M_N v^2 \sim N_c \Lambda_{\text{QCD}}^2$ and hence which are of order N_c above the elastic threshold and can emit an order of N_c mesons during a scattering process. Thus, this restriction should not alter the basic N_c counting. Similarly, for simplicity, we again will do the detailed analysis assuming only scalar mesons and only one species of these. We will also consider only the simplest type of Yukawa interaction. This simplification will not alter the N_c counting and the algebra is simple and traceable. Had we included mesons with other quantum numbers, the emergent spin-flavor contracted symmetry [7–12] would be needed to ensure the sorts of cancellations which naturally emerge with scalars [13].

The Feynman diagram representing one-meson exchange is in the Fig. 3. The N_c scaling of this diagram is given by the N_c scaling of the coupling constant standing in the meson-nucleon-nucleon vertex, which is of order $g \sim N_c^{1/2}$ [3]. Note that the characteristic momentum flowing through the meson is of order N_c^0 since the meson mass is independent of N_c which means that the propagator will cut off momenta which are characteristically larger. Since there are two vertices in Fig. 3, the amplitude coming from this diagram—which can be identified with the one-boson exchange contribution to the potential—is of order N_c . Note that this is precisely the scaling a nucleon-nucleon potential should obey according to the standard counting rules. Note that with elastic kinematics where the energy transfer is zero the kinematics are such that there is no intermediate state of a two nucleons plus meson and hence the imaginary part of the potential is zero.

On the other hand, the situation gets more complicated in a case of two meson exchange, as was discussed

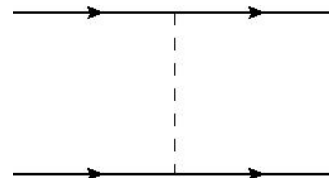

FIG. 3: A Feynman diagram of the one meson exchange part of the potential.

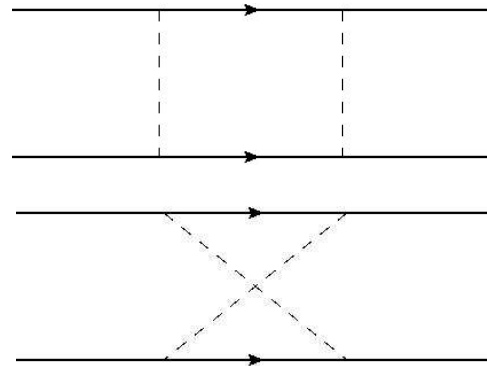

FIG. 4: A Feynman diagrams of the two-meson exchange interaction, one boxed and one crossed.

extensively in a paper of Banerjee et. al [13]. Relevant diagrams are summarized in Fig. 4. The naive counting of powers of N_c leads to an overall scaling N_c^2 , which is a problem, since the potential should be of order N_c^1 . However, a deeper analysis resolves the apparent problem in two steps. First, one observes that the baryon-pole contribution to the amplitude of the box diagram is exactly of the same form as a first iterate of a Lippmann-Schwinger equation with a potential given by one meson exchange. As such, it does not contribute to the potential so that double counting is avoided. Since potential is the quantity that should be of order N_c , the first iterate containing two potentials is then of order N_c^2 , as it should be. In the second step one is able to show that the meson-pole contribution of the box diagram (the retardation effect) and the crossed diagram differ only by sign at the leading order in $1/N_c$ expansion. Thus, they subtract exactly and the remaining piece, which is not an iterate and therefore genuinely enters the potential, does not spoil the overall N_c behavior. This exact cancellation at leading order occurs only to the extent that $v \ll 1$ and for this reason we focus on nonrelativistic dynamics. The connection between the potential picture and a meson-exchange picture is rather subtle at the level of three meson exchange as discussed in [14]. But with a sensible definition, the potential can be made to scale in a consistent way [15].

The imaginary part of the potential emerges naturally in a meson exchange picture. For simplicity we will focus on two-meson exchange since it is the lowest order

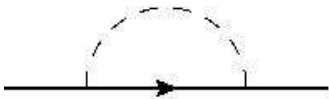

FIG. 5: A Feynman diagram of the one meson loop correction to the nucleon propagator.

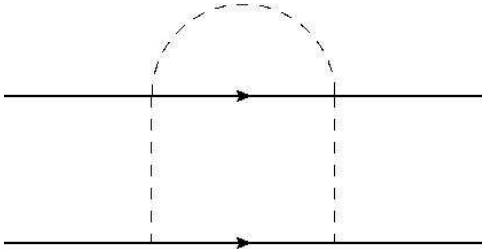

FIG. 6: A Feynman diagram which contributes to the imaginary part of the potential in the leading order.

interaction in which an imaginary part emerges. We will also not focus on the box and crossed box diagrams since these are subtle in that there are superleading contributions of order N_c^2 and the leading order result comes from a cancellation. It was discussed in the preceding section that a consistent meson-exchange picture for a nucleon-nucleon potential can be constructed. However, one can also construct a two-meson exchange diagram with a non-zero imaginary part in nonrelativistic kinematics and which does not depend on any cancellations.

Before investigating how an imaginary part emerges in the potential, let us first look at the simplest possible one loop diagram: the one meson loop correction to a baryon propagator, which is shown in Fig. 5.

In the nonrelativistic regime, the loop integral reads

$$\begin{aligned} I(k^0 - M) &= \int \frac{d^4 l}{(2\pi)^4} \frac{i}{l^2 - m_\pi^2 + i\epsilon} \frac{i}{k^0 - M + l^0 + i\epsilon} \\ &= \text{Re}(I) + i\pi\theta(k^0 - M - m_\pi), \end{aligned} \quad (27)$$

where k^0 is the zeroth component of the nucleon four-momentum. As one sees directly from (27), the integral acquires the imaginary part when the energy is sufficient to excite a meson. It is in agreement with the naive picture of what an imaginary part of an amplitude means: that a new particle can be produced.

It is natural to consider two-meson-exchange diagrams which contain this self energy as a subdiagram. Many of these require complicated cancellations of the sort discussed above. However, there exists a simple case where no cancellations occur. It is a two-meson exchange interaction with one extra loop on one of the nucleons. This is shown in Fig. 6.

It is easy to see that both the real and imaginary parts scale as N_c^1 . The key point is that the self energy subdiagram is connected to the system via a 2-nucleon-2-meson vertex. By standard Witten counting this scales

as N_c^0 . Again, the typical momentum transfer through exchanged mesons is order N_c^0 . However, there is also a possible energy transfer of the same order, yielding an on-shell configuration of two nucleons and a meson. Thus both the real and the imaginary parts are of order N_c^1 as one expects for a potential yielding an S-matrix consistent with the standard Witten counting.

There are other possible two-meson exchange diagrams which contain imaginary parts. In many of these the nominal N_c counting is higher than N_c^1 . However, we have verified that all of these contain cancellations analogous to that seen between the retardation effect in the box and crossed diagrams. Thus, we expect that in this kinematic regime the leading order will be of order N_c for the imaginary part. This model result is suggestive rather than decisive. Apart from the simplifications noted at the outset—that the analysis is in a particular kinematic regime and of a particularly simple model—the argument here was only for one type of diagram. Nevertheless it is useful check that it is consistent with our expectation from more general arguments.

5. Potential at a quark and gluon level

The previous discussion was formulated in the language of mesons and baryons. It was argued somewhat heuristically, that the proposed N_c scaling of both real and imaginary part of the potential, i.e. that they are both proportional to N_c , holds in the nucleon-nucleon scattering. In this section, we argue that the previous result is natural also at the level of quarks and gluons. We will again focus on diagrams which at the hadronic level look like Fig. 6.

Let us start by looking at the self-energy diagrams containing meson loops such as in Fig. 7. Note that this diagram was drawn to emphasize the fact that Feynman propagators contain backward going components, so that even without quark loops meson loops contribute at order N_c^1 , the leading order in the $1/N_c$ expansion [24]. With the appropriate kinematics such a meson can go on-shell. Now let us turn to Fig. 8, which shows diagrams analogous to Fig. 6. Note that the quark-antiquark pairs playing the role of the exchanged meson, couple to the same quark line in the upper nucleon or to quarks connected to it via gluons. The reason that this is required is the following: following the first exchange the nucleons can propagator either in their ground state or in an excited state. If the first exchange leaves both nucleon in their ground state, then it acts like an iterate of the potential. Thus such contributions to two meson exchange cannot be part of the potential itself. However, if one of the nucleons is excited by pushing one quark into an excited state that quark must be deexcited in the second exchange. This happens in the second exchange. It is a simple exercise in N_c counting to verify that both of these diagrams are of order N_c when combinatorics is appropriately taken into account. The key point is that the

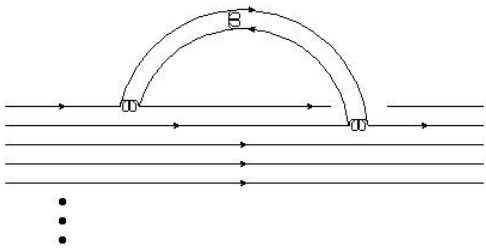

FIG. 7: A leading order diagram for the nucleon self energy.

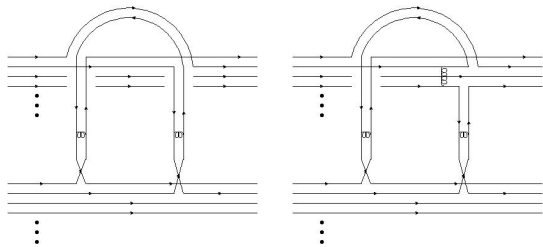

FIG. 8: Diagrams at the quark-gluon level analogous to Fig. 6.

restriction of the exchanges to the same quark line in the upper nucleon or to quarks connected to it via a gluon reduce the N_c counting by a factor of $1/N_c$ compared to a naive counting. In the case where the exchanges couple to the same quark line, there is a reduction of a combinatoric factor of N_c . In the case where quarks are connected via a gluon there is no reduction in combinatoric factors but there is an extra factor of $g^2 \sim 1/N_c$.

III. SPIN AND FLAVOR

Up to this point the analysis conveniently skipped the fact that nucleons have spin and isospin degrees of freedom. This enabled us to formulate the problem of finding the S-matrix as one of finding the real and imaginary parts of phase shifts for given orbital momentum partial wave. A variety of arguments indicate that these scale as N_c^1 . When spin and flavor are put back into the problem the S-matrix is a matrix for each angular momentum and flavor channel. This could represent a major complication since the analysis presented above was semi-classical in nature while spin and flavor degrees of freedom are intrinsically quantum mechanical in nature. One might worry that the gist of the argument could be spoiled for this intrinsically quantum system.

There is an additional complication. At large N_c , there is an emergent $SU(2N_f)$ spin-flavor symmetry [7–12] and the nucleon is part of a tower of nearly degenerate stable baryon states. If, for simplicity, one restricts attention to a world with 2 flavors, this tower consists of states with $I = J$ with $J \sim N_c^0$ (the case of three or more flavors adds technical complications but will not change the fundamental result). The Skyrmion [16] is

a concrete realization of this in the context of a simple model. The Skyrmion naturally gives isolated baryons in terms of hedgehog configurations which correlate directions in space and isospace. Since these break both rotational and isorotational symmetry, (iso)rotated skyrmions are also solutions to the equations and are equally good baryons. Such rotations depend on three Euler angles. At a quantum level, these hedgehogs are interpreted as superpositions of low lying states in the band with $I = J$. Note that the classical description in terms of Euler angles emerges naturally at large N_c regardless of whether one is using a Skyrme model—it holds directly in QCD. There is a strong analogy to deformed states in mean-field descriptions of nuclei. As with deformed nuclei one can project on to states with good quantum numbers to extract the physically relevant states. The process is in analogy with Peirls-Yacoz projection [25] and, as in that case, one does this by integrating the collective degrees of freedom—the Euler angles—weighted by Wigner D-matrices and an appropriate normalization constant.

Fortunately, this second complication allows one to deal with the first. The emergence of collective degrees of freedom associated with spin and flavor means that one can deal with these degrees of freedom in an essentially classical way. The approach is similar to the one in Ref. [17]. At large N_c one can consider the initial states in the scattering are not baryons with I and J quantum numbers but rotated hedgehogs specified by Euler angles. This is allowable in a quantum sense in that, as in all physical scattering processes, we consider incident wave packets coming in from asymptotic distances; in this case the wave packets contain a superposition of incident baryon states. Now, if we consider taking the large N_c prior to the long-distance limit in setting up the scattering problem the hedgehog remains coherent as it enters the scattering region and a classical picture emerges. The scattering process takes time of order N_c^0 . As the two hedgehogs leave the interaction region (we are now doing the analysis for the case in which no mesons have been emitted) they will presumably have been rotated but the amount of the rotation is not expected to scale with N_c but to go as N_c^0 . The reason for this is that the torques exerted on one hedgehog by the other should be of order N_c^1 by standard Witten counting but so is the moment of inertia and the time the torque is exerted is of order N_c^0 . Of course ultimately the wave packets associated with rotated hedgehogs will disperse and the various baryon types separate but if one takes the large N_c limit at the outset the time scale for this to happen goes to infinity. Thus the rotation angles experienced by the hedgehogs becomes arbitrarily well defined in the large N_c limit and are given by a classical analysis. The phase associated with this classical motion in both real space and collective coordinate space—including the imaginary part—is again given by Hamilton’s principle function. The arguments are essentially the same as in the case of a spinless particles.

We will denote this phase as $\delta_l(A_1^i, A_2^i; E)$ where A^i

denotes the initial set of collective angles for each particle where A has the norm $\int dA = (2\pi^2)^{-1}$. We note that we do not need to specify the final collective angles since the classical nature of the dynamics means that these are fixed by the initial ones. Thus there are functions $A_1^f(A_1^i, A_2^i)$ and $A_2^f(A_1^i, A_2^i)$ which specify outgoing collective variables. Note that from the arguments given

above we expect $\delta_l(A_1^i, A_2^i; E)$ to be of order N_c in Witten kinematics with $l = N_c \tilde{l}$ and $E = N_c \tilde{E}$. Thus we write $\delta_l(A_1^i, A_2^i; E) = N_c \tilde{\delta}_{\tilde{l}}(A_1^i, A_2^i; \tilde{E})$

Finally, we need to extract the nucleon-nucleon S-matrix from the classical result from these by projection. These are given by

$$S = \int dA_1 dA_2 D_{m_1, m_1^I(A_1)}^{1/2} D_{m_2, m_2^I(A_2)}^{1/2} D_{m_1, m_1^I(A_1^f, A_2^f)}^{*1/2} D_{m_2, m_2^I(A_2)}^{*1/2} e^{iN_c \tilde{\delta}_{\tilde{l}}(A_1^i, A_2^i; \tilde{E})} \quad (28)$$

Analytically continuing δ into the generalized complex plane allows this integral to be evaluated by steepest descents and this yields matrix elements which are power law in N_c times $\exp(N_c \tilde{\delta}_{\tilde{l}}(B_1^i, B_2^i; \tilde{E}))$ where B_1, B_2 are the complex values for A_1, A_2 where the derivative of δ vanishes. This result yields Eq. (2) including the full spin and isospin dependence.

IV. CONCLUSION

This paper has given a variety of arguments in support of Eq. (2)—the notion that both the real and the imaginary parts of the logarithm of the S-matrix scale with N_c . While all of these arguments were to some degree

heuristic, they all give the same result. Together, they comprise a rather compelling argument for the validity of Eq. (2). These arguments all exploit the semi-classical nature of large N_c dynamics in Witten kinematics. While the simplest formulation of these arguments was given in simplified models in which spin and flavor were neglected, it was shown in the last section that the collective spin and flavor rotations at large N_c allows these degrees of freedom to be included in the semi-classical analysis.

Acknowledgments

This work was supported by the U.S. Department of Energy through grant DE-FG02-93ER-40762.

V.K. also acknowledge the support of JSA/Jefferson Lab Graduate Fellowship.

-
- [1] *Proceedings of 29th International Symposium on Lattice field theory (Lattice 2011)*, ed. by Pavlos Vranas, PoS(Lattice 2011)
 - [2] G. t'Hooft, Nucl. Phys. B **72** 461 (1974).
 - [3] E. Witten, Nucl. Phys. B **160** 57 (1979).
 - [4] F. Gross, T.D. Cohen, E. Epelbaum, R. Machleidt, Few-Body Syst. **50** 31 (2011).
 - [5] D.B. Kaplan, M.J. Savage, Phys. Lett. B **365** 244 (1996).
 - [6] D.B. Kaplan, A.V. Manohar, Phys. Rev. C **56** 76 (1997).
 - [7] J.L. Gervais, B. Sakita, Phys. Rev. Lett. **52** (1984) 87.
 - [8] J.L. Gervais, B. Sakita, Phys. Rev. D **30** (1984) 1795.
 - [9] R.F. Dashen, A.V. Manohar, Phys. Lett. B **315** (1993) 425.
 - [10] R.F. Dashen, A.V. Manohar, Phys. Lett. B **315** (1993) 438.
 - [11] R.F. Dashen, E.E. Jenkins, A.V. Manohar, Phys. Rev. D **49** (1994) 4713.
 - [12] R.F. Dashen, E.E. Jenkins, A.V. Manohar, Phys. Rev. D **51** (1995) 3697.
 - [13] M.K. Banerjee, T.D. Cohen, B.A. Gelman, Phys. Rev. C **65** 034011 (2002).
 - [14] A.V. Belitsky, T.D. Cohen, Phys. Rev. C **65** 064008 (2002).
 - [15] T.D. Cohen, Phys. Rev. C **66** 064003 (2002).
 - [16] T.H.R. Skyrme, Proc. Roy. Soc. Lond. A **260** (1961) 127.
 - [17] T.D. Cohen, B.A. Gelman, Phys. Lett. B **540** 227 (2002).
 - [18] T.D. Cohen, B.A. Gelman, Phys. Rev. C **85** 024001 (2012).
 - [19] T.D. Cohen, Phys. Rev. Lett. **108** 262301 (2012).
 - [20] J.R. Taylor, *Scattering theory* (John Wiley & Sons, Inc., Boulder, 1972).
 - [21] H. Goldstein, C. Poole, J. Safko, *Classical Mechanics* (Addison-Wesley, San Francisco, CA).
 - [22] R.J. Glauber, Phys. Rev. **131** 2766 (1963)
 - [23] H. Feshbach, Ann. Phys. **19** 287 (1962)
 - [24] T.D. Cohen, D.B. Leinweber Comments Nucl. Part. Phys. **21** 137 (1993)
 - [25] R.E. Peierls, J. Yoccoz, Proc. Phys. Soc. **A70** 381 (1957)