

# Classical linear logic, cobordisms and categorial grammars

Sergey Slavnov

National Research University Higher School of Economics  
sslavnov@yandex.ru

November 12, 2019

## Abstract

We propose a categorial grammar based on classical multiplicative linear logic.

This can be seen as an extension of abstract categorial grammars (ACG) and is at least as expressive. However, constituents of *linear logic grammars (LLG)* are not abstract  $\lambda$ -terms, but simply tuples of words with labeled endpoints and supplied with specific *plugging instructions*: the sets of endpoints are subdivided into the *incoming* and the *outgoing* parts. We call such objects *word cobordisms*.

A key observation is that word cobordisms can be organized in a category, very similar to the familiar category of topological cobordisms. This category is symmetric monoidal closed and compact closed and thus is a model of linear  $\lambda$ -calculus and classical, as well as intuitionistic linear logic. This allows us using linear logic as a typing system for word cobordisms.

At least, this gives a concrete and intuitive representation of ACG.

We think, however, that the category of word cobordisms, which has a rich structure and is independent of any grammar, might be interesting on its own right.

## 1 Introduction

A prototypical example of categorial grammar is Lambek grammars [22]. These are based on logical *Lambek calculus*, which is, speaking in modern terms, a noncommutative variant of (intuitionistic) linear logic [14]. It is well known that Lambek grammars generate exactly the same class of languages as context-free grammars [34].

However, it is agreed that context-free grammar are, in general, not sufficient for modeling natural language. Linguists consider various more expressive formalisms. Lambek calculus is extended to different complex *multimodal*, *mixed commutative* and *mixed nonassociative* systems, see [28]. Many grammars operate with more complex constituents than just words. For example *displacement*

*grammars* [32], extending Lambek grammars, operate on discontinuous tuples of words.

*Abstract categorial grammars (ACG)* [12], on the other hand, are based on a more intuitive and familiar *commutative* logic, namely, the implicational fragment of linear logic. There are also other, very close to ACG formalisms such as  *$\lambda$ -grammars* [33] or *linear grammars* [27] developed in this setting. (We should mention *hybrid type logical grammars* [21] as well; these extend ACG, mixing them with Lambek grammars.)

ACG are very strong in their expressive power [42] and show remarkable flexibility in many aspects. (Yet, they have their own deficiencies from the point of view of natural language modeling as well, see [30]). However, in a striking difference from other formalisms, basic constituents of ACG used for syntax generation are just linear  $\lambda$ -terms. Unfortunately it is not so easy to identify  $\lambda$ -terms with any elements of language.

We should also mention another, very interesting approach based on commutative logic. It is the unifying approach of [29]. It turns out that many grammatical formalisms can be faithfully represented as fragments of first order multiplicative intuitionistic linear logic **MILL1**. This provides some common ground on which different systems can be compared.

In this work we propose one more categorial grammar based on a commutative system, namely on *classical* linear logic.

*Linear logic grammars (LLG)* of this paper can be seen as an extension of ACG to full multiplicative fragment. Although, the list of different formalisms is already sufficiently long, we think that our work deserves some interest at least for two reasons.

First, unlike the case of ACG, constituents of LLG are very simple. They are tuples of words with labeled endpoints, we call them *multiwords*. Multiwords are directly identified as basic elements of language, and apparently they are somewhat easier to deal with than abstract  $\lambda$ -terms. Each multiword of LLG is supplied with specific *plugging instructions*: the set of its endpoints is subdivided into the *incoming* and the *outgoing* parts (not to be confused with the subdivision into left and right endpoints). We call a multiword supplied with such a subdivision a *word cobordism*, and we usually abbreviate this title as *cowordism*, for a joke.

Word cobordisms can be composed by gluing outgoing parts (outputs) to the incoming ones (inputs). Word endpoints can also be moved from input to output and vice versa producing new word cobordisms; an operation directly corresponding to  $\lambda$ -abstraction.

ACG embed into LLG, so at least we give a concrete and intuitive *representation* of ACG. We don't know if LLG have stronger expressive power as ACG, or just the same. It can be observed though that the cowordism representation has been widely used in ACG anyway, but *implicitly*, under the title of *proof-nets*.

Second, we identify on the class of word cobordisms a fundamental algebraic structure, namely the structure of a *category* (in the mathematical, rather than linguistic sense of the word).

## 1.1 Abstract algebra point of view

The algebraic structure underlying linguistic interpretations of Lambek calculus is that of a monoid: the set of words over a given alphabet is a free monoid under concatenation, and Lambek calculus can be interpreted as a logic of the poset of this monoid subsets (i.e. of formal languages).

When constituents of a grammar are more complicated, such as word tuples, there is no unique concatenation, since tuples can be glued together in many ways. Thus the algebra is more complex.

When the constituents are word cobordisms, the underlying algebraic structure is a *category* (in the mathematical, rather than linguistic sense of the word).

Word cobordisms, just like ordinary topological cobordisms [3] form a category, which is *symmetric monoidal closed* and *compact closed*.

Thus, we shift from a non-commutative (“nonsymmetric”) monoid of words to a symmetric (“commutative”) monoidal category of *cowordisms*.

It is this categorical structure that allows us representing linear  $\lambda$ -calculus and ACG, as well as classical linear logic.

An LLG consists of the category of cowordisms, seen as a (degenerate) model of linear logic, supplied with a *lexicon*, which is a finite set of non-logical axioms, i.e. cowordisms together with their typing specifications.

Syntactic derivations from the lexicon directly translate to *cowordisms generated by the grammar*.

Comparing with Lambek calculus, we shift from a *poset* of formal languages to a *category* of cowordism types. If sequents in Lambek calculus simply represent inclusions between languages, typing judgements in LLG represent concrete cowordisms computed from syntactic derivations, in other words, nontrivial instructions how to glue (multi-)words together.

It should be observed that the category of cowordisms itself is independent of any grammar. Apparently, at least some other formalisms can be represented in this setting as well. Possibly, this can give some common reference for different systems. In this connection, it might be interesting to study relationship between LLG, as well as the category of cowordisms in general, and the first order linear logic framework for categorial grammars of [29]. (Apparently, cowordism endpoints correspond to first order variables and gluing, to variable unification.)

## 1.2 Syntax vs. semantics

Somewhat ironically, the word “semantics” in the context of categorial grammars can have different semantics .

On one hand, we have *denotational* semantics of logical systems. For example, Lambek grammars generate denotational models for Lambek calculus, and LLG of this work are models of linear logic and linear  $\lambda$ -calculus.

On the other hand, we can have models for semantics of languages generated by a grammar.

One of the main features making categorial grammars interesting is that they allow a bridge between language syntax and language semantics (see [31]).

In particular, ACG, apart from generating *syntactic* representation (which corresponds to string or tree object signatures), can also generate *meaning representation* by changing the object signature, provided that meaning is modeled by means of the same typing system, i.e., intuitionistic linear logic, as in [11]. (We do not discuss here the case of *non-linear* ACG.)

As for LLG, obviously, they do not generate any meaning representation. Word cobordisms are just specifically labeled tuples of words. (Speaking in more linguistic terms, LLG are related directly only to *surface* structures.) However, translating from ACG to LLG does not lead to any information loss: any semantic analysis of a language provided by an ACG remains available.

Indeed, ACG represent language generation in terms of  $\lambda$ -calculus typing derivations. These are mapped to a chosen meaning representation, thus providing a bridge with semantics. But ACG for syntactic representation translate to LLG *isomorphically*. All typing derivations are preserved and can be mapped to meaning representation equally well. LLG can be seen then as a simple and faithful representation of the syntactic (“surface”) part of ACG

Since the category of word cobordisms is compact closed, we would like to mention an interesting approach to language semantics, where the meaning representation model is compact closed as well, moreover, compactness plays a crucial role.

In *categorical compositional distributional models of meaning (DisCoCat)* [9], [10] it is proposed to model and analyze language semantics by a functorial mapping (“quantization”) of syntactic derivations in a categorial grammar to the (symmetric) compact closed category **FDVec** of finite-dimensional vector spaces. The approach has been developed so far mainly on the base of Lambek grammars or pregroup grammars (see [23]), which are, from the category-theoretical point of view, *non-symmetric monoidal closed* (non-symmetric compact closed, in the case of pregroups). On the other hand, the cwordism category is symmetric and compact closed, and in this sense it is a better mirror of **FDVec**. Thus it seems a more natural candidate for quantization. Possibly, cwordism representation may help to apply ideas of DisCoCat to LLG or ACG, thus going beyond context-free languages.

### 1.3 Background

We assume that the reader is familiar with  $\lambda$ -calculus (see [4]) and has at least some basic idea of sequent calculus and cut-elimination (see, for example, [41] or [16] for introduction.)

We also assume some basic acquaintance with categories, in particular, with monoidal categories, see [24] for background. However, we tried to separate concrete examples and definitions from general categorical discussion, so that the reader uncomfortable with “abstract nonsense” might hopefully still grasp what is going on. Categorical formalization is essential in order to guarantee soundness of our constructions without going through (rather routine) proofs by induction on syntactic derivations.

## 2 Word cobordisms

### 2.1 Multiwords

Let  $T$  be a finite alphabet. We denote the set of all finite words in  $T$  as  $T^*$  and the empty word, as  $\epsilon$ .

We are going to define *multiwords* over  $T$  as oriented bipartite graphs with edges labeled with words in  $T^*$ .

First we define *boundaries*, which represent ordered vertex sets.

**Definition 1.** A *boundary*  $X$  is a list (i.e. a finite sequence) of arbitrary elements, called *vertex labels* or, simply, *vertices*, together with a sublist (a subsequence)  $X_l$  of  $x$ , called the *left boundary* of  $X$ .

The subsequence of all elements not in the left boundary is denoted  $X_r$  and called the *right boundary* of  $X$ .

Elements of  $X_l$  are called *left endpoints* of  $X$  and are said to have *left polarity*. Accordingly, elements of  $X_r$  are *right endpoints* of  $X$  and have *right polarity*.

It is implied that a boundary parameterizes vertices of a directed bipartite graph whose edges are directed from left to right.

A *subboundary*  $X'$  of a boundary  $X = (x_0, \dots, x_n)$  is any list  $X' = (x_i, \dots, x_j)$ ,  $0 \leq i \leq j \leq n$  of consecutive elements of  $X$ .

**Definition 2.** A *regular multiword*  $M$  with boundary  $X$  over an alphabet  $T$  is a directed graph, whose edges are labelled with words in  $T^*$  and vertices are parameterized by  $X$  in such a way that each element of  $X$  is adjacent to exactly one edge (so that it is a perfect matching), and each edge starts at a left endpoint of  $X$  and ends at a right endpoint of  $X$ .

A basic operation on multiwords will be gluing along subboundaries. Since, in principle, such gluing can be done cyclically, it can result in objects that are not graphs at all.

For consistency of definitions we will also have to consider *cyclic words* and *singular multiwords*.

We say that two words in  $T^*$  are *cyclically equivalent* if they differ by a cyclic permutation of letters. A *cyclic word* over  $T$  is an equivalence class of cyclically equivalent words in  $T^*$ .

For  $w \in T^*$  we denote the corresponding cyclic word as  $[w]$ .

**Definition 3.** A *multiword*  $M$  with boundary  $X$  over the alphabet  $T$  is a pair  $M = (M_0, M_c)$ , where  $M_0$ , the *regular* part, is a regular multiword with boundary  $X$  over  $T$ , and  $M_c$ , the *singular* or *cyclic* part, is a finite multiset of cyclic words over  $T$ .

A multiword is *acyclic* or *regular* if its singular part is empty. Otherwise it is *singular*.

A general multiword  $M$  can be pictured geometrically as the edge-labelled graph  $M_0$  and a disjoint union of isolated loops (i.e. closed curves) labeled with elements of  $M_c$ . The underlying geometric object is no longer a graph, but it is a topological space, even a topological manifold with boundary.

### 2.1.1 Contractions

Let  $M$  be a multiword with boundary  $X$ , and let  $x, y$  be two consecutive elements of  $X$  having opposite polarities.

We define the *elementary contraction*  $\langle M \rangle_{x,y}$  of  $x$  and  $y$  in  $M$  as a multiword obtained by gluing the edges adjacent to  $x$  and  $y$ .

Let us give an accurate definition.

Let  $X'$  be the list obtained from  $X$  by removing  $x$  and  $y$ . Put  $X'_l = X_l \cap X'$ . This makes  $X'$  a new boundary.

The new multiword is obtained as follows.

In the case when  $x, y$  are connected by an edge in  $M_0$ , let  $e$  be this edge and  $w$  be the word labeling  $e$ . We remove  $x, y$  and  $(x, y)$  from  $M_0$ , which gives us a new edge-labelled graph  $M'_0$ , and we add to  $M_c$  the cyclic word  $[w]$ , which gives us a new multiset  $M'_c$ . We put  $\langle M \rangle_{x,y} = (M'_0, M'_c)$ .

In the case when  $x, y$  are not connected by an edge in  $M_0$ , and  $x$  is a right endpoint in  $X$  (hence  $y$  is a left endpoint), let  $z, t \in X$  be such that the edges  $(z, x)$  and  $(y, t)$  are in  $M_0$ . Let  $u$  be the word labeling  $(z, x)$  and  $v$  be the word labeling  $(y, t)$ . We construct a new edge-labelled graph  $M'_0$  by removing  $x$  and  $y$  together with their adjacent edges from  $M_0$  and drawing an edge from  $(z, t)$ . The new edge is labelled with the concatenation  $uv$ .

We put  $\langle M \rangle_{x,y} = (M'_0, M_c)$ .

In the case when  $x, y$  are not connected by an edge in  $M_0$ , and  $x$  is a left endpoint in  $X$ , the new multiword is constructed in the same way, with the roles of  $x$  and  $y$  interchanged.

Elementary contractions can be iterated.

Let us say that two subboundaries  $A = (a_0, \dots, a_n), B = (b_0, \dots, b_m)$  of the boundary  $X$  are *consecutive in  $X$*  if the elements  $a_n$  and  $b_0$  are consecutive in  $X$ .

Let us say that  $A$  and  $B$  have *opposite polarities* if they have the same length (i.e.  $n = m$ ), and for any  $i = 0, \dots, n$  the elements  $a_{n-i}, b_i$  have opposite polarities.

Then for any multiword  $M$  with the boundary  $X$  and any two consecutive subboundaries  $A = (a_0, \dots, a_n), B = (b_0, \dots, b_n)$  of  $X$  with opposite polarities we define the *contraction*  $\langle M \rangle_{A,B}$  of  $A$  and  $B$  in  $M$  as

$$\langle M \rangle_{A,B} = \langle \dots \langle M \rangle_{a_n, b_0} \dots \rangle_{a_0, b_n}.$$

### 2.1.2 Word cobordisms

We want to consider multiwords as morphisms between boundaries and compose them by gluing. So we want to organize multiwords in a category.

We remarked above that multiwords can be represented geometrically as very simple manifolds with boundary. Manifolds with boundary give rise to the category of *cobordisms*, see [3]. We will construct a similar category of *word cobordisms*. We find it amusing to abbreviate the latter term as *cowordism*, and we will do so.

In order to treat multiword as a morphism consistently, we need to subdivide its boundary into the *incoming* and the *outgoing* parts and to fix this subdivision. (It should not be confused with the subdivision into left and right endpoints.) A multiword equipped with such a subdivision will be called a cowordism.

Prior to giving a definition, it will be convenient to define some operations on boundaries.

Given two boundaries  $X$  and  $Y$ , we define the *tensor product*  $X \otimes Y$  by concatenation of lists:

$$X \otimes Y = (X, Y), \quad (X \otimes Y)_l = (X_l, Y_l).$$

Given a boundary  $X = (x_1, \dots, x_n)$ , we define the *dual boundary*  $X^\perp$  of  $X$  as the boundary obtained by reversing the list  $X$ , and changing polarities of its elements:

$$X^\perp = (x_n, \dots, x_1), \quad (X^\perp)_l = X_r.$$

Note that we have

$$(X \otimes Y)^\perp = Y^\perp \otimes X^\perp. \quad (1)$$

**Remark.** A reader familiar with compact categories (which will be discussed shortly) or cyclic linear logic might anticipate from formula (1) some sort of noncommutativity in the category of cowordisms. This is misleading. We will have a natural isomorphism between  $(A \otimes B)^\perp$  and  $A^\perp \otimes B^\perp$ , just not equality.

Tensor product readily extends from boundaries to multiwords.

Given two multiwords  $M = (M_0, M_c)$  and  $N = (N_0, N_c)$  with boundaries  $X$  and  $Y$  respectively, we define the *tensor product*  $M \otimes N$  as the disjoint union. Namely, the regular part  $(M \otimes N)_0$  is the disjoint union of edge-labeled graphs  $M_0, N_0$ , and the singular part  $(M \otimes N)_c$  is the sum of multisets  $M_c$  and  $N_c$ . The vertices of  $(M \otimes N)_0$  are parameterized by  $X \otimes Y$  in the obvious way, so we get indeed a multiword with the boundary  $X \otimes Y$ .

**Definition 4.** Given two boundaries  $X, Y$ , a *cowordism*

$$\sigma : X \rightarrow Y$$

over an alphabet  $T$  from  $X$  to  $Y$  is a multiword over  $T$  with boundary  $Y \otimes X^\perp$ .

In the above setting we say that  $X^\perp$  is the *incoming boundary* of  $\sigma$ , and  $Y$  is the *outgoing boundary*.

We say that a cowordism is *regular* if its underlying multiword is regular. Otherwise the cowordism is *singular*.

Matching cowordisms are composed by gluing incoming and outgoing boundaries.

Given boundaries  $X, Y, Z$  and cowordisms

$$\sigma : X \rightarrow Y, \quad \tau : Y \rightarrow Z,$$

the *composition*

$$\tau \circ \sigma : X \rightarrow Z$$

of  $\tau$  and  $\sigma$  is the cwordism defined by the iterated contraction

$$\tau \circ \sigma = \langle \tau \otimes \sigma \rangle_{Y^\perp, Y}.$$

The tensor product  $\tau \otimes \sigma$  in the above formula is the tensor product of the underlying multiwords, whose boundary  $B$ , by definition is

$$Z \otimes Y^\perp \otimes Y \otimes X.$$

Then the boundaries  $Y^\perp, Y$  are identified with subboundaries of  $B$ . It is easy to see that the subboundaries  $Y^\perp$  and  $Y$  are indeed consecutive and have opposite polarities in  $B$ , so the contraction is well-defined.

In order to discuss cwordisms in a greater detail it will be convenient to develop some systematic conventions for representing them geometrically. Indeed, cwordisms are, by definition, geometric objects, and a graphical language makes their properties very transparent.

### 3 Graphical language

When depicting a cwordism

$$\sigma : X \rightarrow Y \tag{2}$$

it is convenient to put the points of the boundary  $Y \otimes X^\perp$  on two parallel straight lines, reserving one line for the outgoing boundary  $Y$  and the other one for the incoming boundary  $X^\perp$ , and to place all edges and loops (if there is a singular part) that comprise  $\sigma$  between the two lines.

We will use either the *horizontal* or the *vertical* representation, the horizontal one being default.

In both cases we will depict left endpoints of the boundary of  $\sigma$  as small filled-in circles and right endpoints, as arrow heads.

In the horizontal representation we put the vertices of the outgoing boundary  $Y$  on one vertical line, with the order of list elements corresponding to the direction *up*, and we put the vertices of the incoming boundary  $X^\perp$  on a parallel line to the left, with the order of list elements corresponding to the direction *down*.

(Although, if we identify vertices of the incoming boundary  $X^\perp$  as vertices of  $X$  taken with opposite polarities, then the ordering on the incoming part is in the same direction as on the outgoing one.)

In the vertical representation we put the vertices of the outgoing boundary  $Y$  on one horizontal line, with the order of list elements corresponding to the direction *from right to left*, and we put the elements of the incoming boundary  $X^\perp$  on a parallel line below, with the order of list elements corresponding to the direction *from left to right*.

For example, if

$$X = (x_1, x_2, x_3, x_4), \quad X_L = \{x_2\}, \quad Y = (y_1, y_2, y_3, y_4), \quad Y_l = \{y_3\}, \tag{3}$$



then cwordism (2) will be depicted as

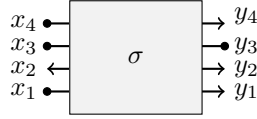

in the horizontal representation, or as

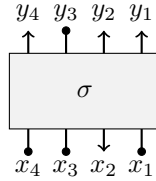

in the vertical representation.

Note that putting labels on vertices in the picture is redundant.

For example, if  $X, Y$  are as in (3), then the cwordism defined by edges

$$(x_1, y_4), (x_3, x_2), (x_4, y_1), (y_3, y_2)$$

labeled, respectively, with words  $b, a, \epsilon, \epsilon$  is unambiguously represented in the following picture.

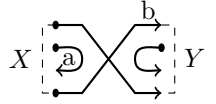

In general, when the detailed structure of the boundary is not important, we “squeeze” parallel edges into one and represent (2) schematically as a box with an incoming wire labeled with  $X$  and an outgoing wire labeled with  $Y$ .

$$\sigma : X \text{ --- } \boxed{\sigma} \text{ --- } Y$$

### 3.1 Composition

It is easy to see that, with our conventions, the composition of cwordisms

$$\sigma : X \rightarrow Y, \quad \tau : Y \rightarrow Z$$

corresponds to the following schematic picture.

$$\begin{array}{c} \sigma : X \text{ --- } \boxed{\sigma} \text{ --- } Y \quad \tau : Y \text{ --- } \boxed{\tau} \text{ --- } Z \\ \tau \circ \sigma : X \text{ --- } \boxed{\sigma} \text{ --- } \boxed{\tau} \text{ --- } Z \end{array}$$

We get a detailed, “full” picture by expanding each edge into as many parallel edges as there are points in the corresponding boundary.

For example, if  $X, Y$  are as in (3), then the above picture translates to the following.

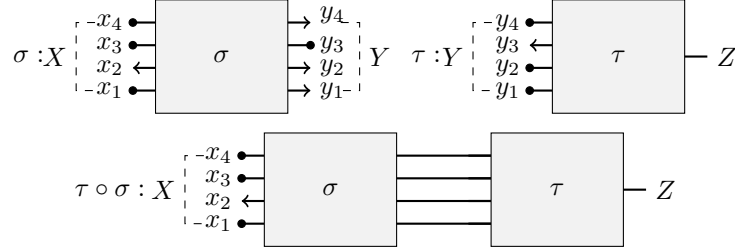

**Proposition 1.** *Composition of cowordisms is associative.*

*Proof.* Evident from geometric representation. □

### 3.1.1 Identities

In order to have a category of cowordisms, we also need identities

The *identity cowordism*

$$\text{id}_X : X \rightarrow X$$

is defined as follows.

Let  $X = (x_0, \dots, x_n)$ .

We write the list  $X \otimes X^\perp$  as

$$X \otimes X^\perp = (x_0, \dots, x_n, x'_n, \dots, x'_0).$$

A prime, obviously, denotes a copy of an element of  $X$  equipped with opposite polarity.

For each  $i = 0, \dots, n$  we draw an edge  $(x_i, x'_i)$ . This gives us a cowordism from  $X$  to  $X$ .

In a schematic, “squeezed” picture, the identity cowordism corresponds to a single wire.

$$\text{id}_X : X \text{ — } X$$

In the full picture there are as many parallel wires as there are points in  $X$ .

If  $X$  is as in (3), then the full picture is as follows.

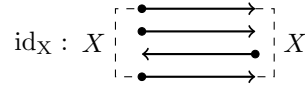

**Proposition 2.** *For all boundaries  $Y$  and cowordisms  $\sigma : X \rightarrow Y$  and  $\tau : Y \rightarrow X$  we have*

$$\sigma \circ \text{id}_X = \sigma, \quad \text{id}_X \circ \tau = \tau.$$

*Proof.* Evident from geometric representation. □

We say that a cowordism  $\sigma : X \rightarrow Y$  is *invertible* if there exists a cowordism  $\tau : Y \rightarrow X$  such that

$$\tau \circ \sigma = \text{id}_X, \quad \sigma \circ \tau = \text{id}_Y.$$

### 3.2 Tensor product

We have already defined tensor product on boundaries (and multiwords). Now we are going to establish conventions for depicting tensor product in the graphical language and then to extend it consistently to cwordisms.

Given boundaries

$$X_1, \dots, X_n, Y_1, \dots, Y_m,$$

we represent a cwordism

$$\sigma : X_1 \otimes \dots \otimes X_n \rightarrow Y_1 \otimes \dots \otimes Y_m \quad (4)$$

schematically as a box whose  $n$  incoming wires are labeled with  $X_i$ 's and  $m$  outgoing wires, labeled with  $Y_i$ 's.

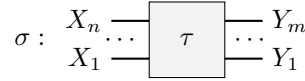

Note that the above “squeezed” picture is consistent with the full picture. If we “expand” each edge into parallel edges adjacent to points in the corresponding subboundary, we obtain a detailed picture of (4) according to our conventions.

The case when  $n$  or  $m$  in the above picture is 0 also makes sense.

**Definition 5.** The *unit boundary*  $\mathbf{1}$  is the empty list.

**Note 1.** For any boundary  $X$  we have  $X \otimes \mathbf{1} = \mathbf{1} \otimes X = X$ .  $\square$

When depicting a cwordism  $\sigma : \mathbf{1} \rightarrow X$ , respectively,  $\tau : X \rightarrow \mathbf{1}$  we do not have wires on the left, respectively, right.

Now let us define tensor product of cwordisms.

Let boundaries  $X, Y, Z, T$  and cwordisms

$$\sigma : X \rightarrow Y, \quad \tau : Z \rightarrow T$$

be given.

Let us write  $\sigma_0$ , respectively,  $\tau_0$  for the regular part of (the underlying multiword of)  $\sigma$ , respectively  $\tau$ , and let us write  $\sigma_c, \tau_c$  for the respective singular parts.

$$\text{Let } S = (Y \otimes T) \otimes (X \otimes Z)^\perp = Y \otimes T \otimes Z^\perp \otimes X^\perp.$$

Vertices of  $\sigma_0$  are parameterized by the disjoint union of  $Y$  and  $X^\perp$ , and vertices of  $\tau_0$ , by the disjoint union of  $T$  and  $Z^\perp$ . Since the boundaries  $Y, X^\perp, T, Z^\perp$  are obviously identified as pairwise disjoint subboundaries of  $S$ , the vertices in the disjoint union of edge-labelled graphs  $\sigma_0$  and  $\tau_0$  are parameterized by  $S$ , which gives us a regular multiword  $(\sigma \otimes \tau)_0$ .

The singular part  $(\sigma \otimes \tau)_c$  is defined as the sum of multisets  $\sigma_c$  and  $\tau_c$ .

This gives us a multiword  $\sigma \otimes \tau$  with the boundary  $S$ , i.e. a cwordism

$$\sigma \otimes \tau : X \otimes Z \rightarrow Y \otimes T.$$

In the graphical language, tensor product of cwordisms corresponds simply to putting two boxes side by side.

$$\sigma \otimes \tau : \begin{array}{c} Z \text{ --- } \boxed{\tau} \text{ --- } T \\ X \text{ --- } \boxed{\sigma} \text{ --- } Y \end{array}$$

**Proposition 3.** *Tensor product of cwordisms is functorial:*

$$(\tau_1 \otimes \tau_2) \circ (\sigma_1 \otimes \sigma_2) = (\tau_1 \circ \sigma_1) \otimes (\tau_2 \circ \sigma_2)$$

for all boundaries  $X_i, Y_i, Z_i$  and cwordisms

$$\sigma_i : X_i \rightarrow Y_i, \quad \tau_i : Y_i \rightarrow Z_i, \quad i = 1, 2.$$

*Proof.* Evident from geometric representation. □

### 3.2.1 Symmetries

Finally, let us define the *symmetry cwordism*

$$s_{X,Y} : X \otimes Y \rightarrow Y \otimes X$$

for boundaries  $X, Y$ .

Let  $X = (x_0, \dots, x_n), Y = (y_0, \dots, y_m)$ .

We write

$$(X \otimes Y) \otimes (Y \otimes X)^\perp = (x_0, \dots, x_n, y_0, \dots, y_m, x'_n, \dots, x'_0, y'_m, \dots, y'_0),$$

just as we did in the definition of the identity cwordism above.

For each  $i = 0, \dots, n$  we draw an edge  $(x_i, x'_i)$  and for each  $i = 0, \dots, m$  we draw an edge  $(y_i, y'_i)$ . This gives us a cwordism from  $X \otimes Y$  to  $Y \otimes X$ .

The schematic picture of  $s_{X,Y}$  is transparent.

$$s_{XY} : \begin{array}{c} Y \text{ --- } \diagdown \text{ --- } X \\ X \text{ --- } \diagup \text{ --- } Y \end{array}$$

**Proposition 4.** *For all boundaries  $X, Y$ , the symmetry cwordism is invertible, with  $s_{Y,X} \circ s_{X,Y} = \text{id}_{X \otimes Y}$ .*

*Proof.* Obvious. □

## 3.3 Duality

We have already defined the operation of duality on boundaries. Now we extend it to cwordisms.

Let  $X, Y$  be boundaries, and let  $\sigma : X \rightarrow Y$  be a cwordism.

Let  $X = (x_0, \dots, x_n)$  and  $Y = (y_0, \dots, y_m)$ .

The boundary of  $\sigma$  is  $Y \otimes X^\perp = (y_0, \dots, y_m, x_n, \dots, x_0)$ .  
 We want to define the dual cowordism

$$\sigma^\perp : Y^\perp \rightarrow X^\perp.$$

Then the boundary of  $\sigma^\perp$  must be

$$X^\perp \otimes Y^{\perp\perp} = X^\perp \otimes Y = (x_n, \dots, x_0, y_0, \dots, y_m).$$

We see that the two boundaries differ only by a cyclic permutation. Reparameterizing vertices of the regular part of  $\sigma$  we get the desired cowordism.

In a schematic picture, duality looks as follows.

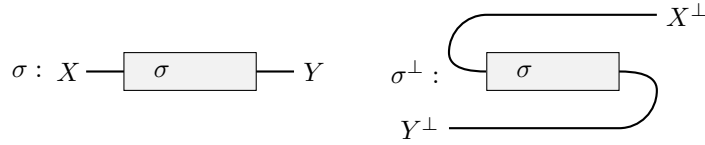

The full picture, again, can be recovered by expanding every wire into a parallel cluster.

For example, if  $X, Y$  are as in (3), the above picture translates to the following.

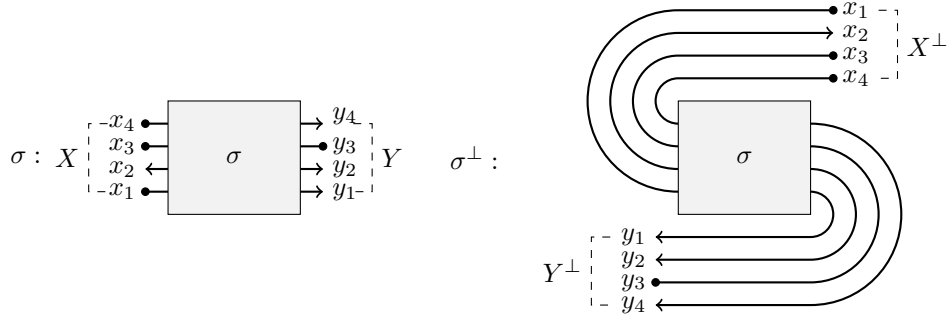

**Remark.** We defined duality on boundaries as not only flipping left endpoints with right endpoints, but also reversing the list of boundary elements precisely in order to have this consistency with “parallel wires substitution” in the graphical language. The price to pay for that is the twist of tensor factors in formula (1).

**Proposition 5.** *Formula (1) holds for cowordisms as well. For all cowordisms  $\sigma, \tau$  we have  $(\sigma \otimes \tau)^\perp = \tau^\perp \otimes \sigma$ .*

*Proof.* Evident from geometric representation. □

**Proposition 6.** *Duality is a contravariant functor: for all boundaries  $X, Y, Z$  and cowordisms*

$$\sigma : X \rightarrow Y, \quad \tau : Y \rightarrow Z$$

*we have  $(\tau \circ \sigma)^\perp = \sigma^\perp \circ \tau^\perp$ .*

*Proof.* Evident from geometric representation. □

## 4 Structure of cwordisms category

Since composition of cwordisms is associative and there are identities, as shown in the preceding section, it follows that cwordisms and boundaries form a category.

**Definition 6.** The *category*  $\mathbf{Cow}_T$  of cwordisms over an alphabet  $T$  has boundaries as objects and cwordisms over  $T$  as morphisms.

### 4.1 Over the empty alphabet

Even when the alphabet  $T$  is empty, the category of cwordisms is nontrivial.

In fact, it becomes equivalent to the category of oriented 1-dimensional topological cobordisms.

In the sequel we will use the term *cobordism* for a cwordism over the empty alphabet, and denote

$$\mathbf{Cow}_\emptyset = \mathbf{Cob}.$$

Given two boundaries  $X, Y$  and a cwordism  $\sigma : X \rightarrow Y$  over some alphabet  $T$ , we define the *pattern* of  $\sigma$  as the cobordism from  $X$  to  $Y$  obtained by erasing from  $\sigma$  all letters. Note that pattern is a functor (from cwordisms to cobordisms).

The category of cobordisms equipped with tensor product and duality has a rich structure, and this structure is inherited by categories of cwordisms over non-empty alphabets.

In particular, categories of cwordisms are *symmetric monoidal closed*, *\*-autonomous*, and *compact closed*. This makes them models of linear  $\lambda$ -calculus and of classical multiplicative linear logic, which is most relevant for our discussion.

Now we discuss this structure in a greater detail.

### 4.2 Zoo of monoidal closed categories

Recall that a *monoidal category*  $\mathbf{C}$  is a category equipped with a *tensor product* bifunctor

$$\otimes : \mathbf{C} \times \mathbf{C} \rightarrow \mathbf{C}$$

together with a *tensor unit*  $\mathbf{1}$  and natural *associativity* transformations (see [24] for details).

A monoidal category is *symmetric* if there exists a natural *symmetry* transformation

$$s_{X,Y} : X \otimes Y \rightarrow Y \otimes X$$

satisfying

$$s^2 = \text{id}.$$

A symmetric monoidal category is *closed* if it is equipped with a bifunctor  $- \circ -$ , contravariant in the first entry and covariant in the second entry, such that

there exists a natural bijection

$$\text{Hom}(X \otimes Y, Z) \cong \text{Hom}(X, Y \multimap Z). \quad (5)$$

The functor  $\multimap$  in the above definition is called *internal homs functor*.

A *\*-autonomous* category [5] is a symmetric monoidal category equipped with a contravariant functor  $(.)^\perp$ , such that there is a natural isomorphism

$$A^{\perp\perp} \cong A$$

and a natural bijection

$$\text{Hom}(X \otimes Y, Z) \cong \text{Hom}(X, (Y \otimes Z^\perp)^\perp). \quad (6)$$

Duality  $(.)^\perp$  equips a *\*-autonomous* category with a second monoidal structure. The *cotensor product*  $\wp$  is defined by

$$X \wp Y = (X^\perp \otimes Y^\perp)^\perp. \quad (7)$$

The neutral object for the cotensor product is

$$\perp = \mathbf{1}^\perp.$$

Any *\*-autonomous* category is monoidal closed. The internal homs functor is defined by

$$X \multimap Y = X^\perp \wp Y. \quad (8)$$

A *compact closed* or, simply, *compact category* is a *\*-autonomous* category for which duality commutes with tensor, i.e. such that there exist natural isomorphisms

$$X \wp Y \cong X \otimes Y, \quad \mathbf{1} \cong \perp.$$

**Remark.** Compact categories were defined in [20]. For the definition used above and its equivalence to the original definition of [20] see [2].

A prototypical example of a compact category is the category of finite-dimensional vector spaces with the usual tensor product and algebraic duality. Note, however, that in this case, as, in general, in the algebraic setting, duality is denoted as a star  $(.)^*$ .

The category of topological cobordisms is another widely used example of a compact category.

Compact categories are relevant for our discussion, because categories of cobordisms are compact, and compact structure provides a lot of important maps and constructions. A short and readable introduction into this subject can be found, for example, in [2]. We emphasize that our graphical language for cobordisms is adapted from the general *pictorial language* customarily used for general compact categories, see [38].

### 4.3 Cowordisms as a compact category

Tensor product equips the category of cowordisms with a monoidal structure, which is symmetric.

Indeed, tensor product is functorial and *strictly* associative, i.e.

$$(X \otimes Y) \otimes Z = X \otimes (Y \otimes Z),$$

moreover, the empty boundary  $\mathbf{1}$  is a *strict* tensor unit.

The symmetry transformation  $s_{X,Y}$  discussed in the preceding section is obviously natural and it squares to the identity (Proposition 4), as required.

**Proposition 7.** *Duality  $(\cdot)^\perp$  equips the category of cowordisms with a compact closed (hence monoidal closed and  $*$ -autonomous) structure.*

*Proof.* The set of cowordisms from  $X \otimes Y$  to  $Z$  is by definition the set of multiwords with the boundary  $Z \otimes (X \otimes Y)^\perp = Z \otimes Y^\perp \otimes X^\perp$ .

The set of cowordisms from  $X$  to  $(Y \otimes Z^\perp)^\perp$  is easily seen to be precisely the same set.

Thus formula (5) holds and the category of cowordisms is  $*$ -autonomous.

Also, the symmetry transformation gives us a natural isomorphism

$$s_{Y^\perp, X^\perp} : (X \otimes Y)^\perp \rightarrow X^\perp \otimes Y^\perp,$$

so the category of cowordisms is compact closed. □

The geometric meaning of bijection (6) is transparent.

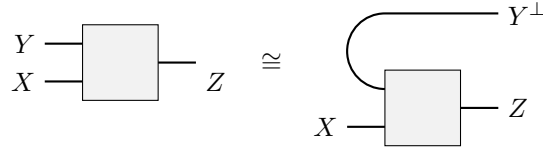

Since the category of cowordisms is also  $*$ -autonomous, it has the cotensor product and internal homs defined by (7) and (8).

It is easy to see that, in the category of cowordisms, we have

$$X \wp Y = Y \otimes X, \quad X \multimap Y = Y \otimes X^\perp.$$

This formula will be much used in the sequel.

As for the cotensor unit  $\perp$ , we have  $\perp = \mathbf{1}^\perp = \mathbf{1}$ .

Anticipating (linear) logic interpretation, we note that correspondence (6) together with the above picture simply express the possibility of moving formulas of a sequent between the right and the left sides of the turnstile.

We now discuss important constructions determined by the compact structure.



### 4.3.1 Names and conames

In any  $*$ -autonomous category there are operations of *naming* and *conaming* (the first one exists also in any monoidal closed category).

Let  $\sigma : X \rightarrow Y$  be a morphism in a monoidal closed category  $\mathbf{C}$ .

Correspondence (5) together with the isomorphism

$$X \cong \mathbf{1} \otimes X$$

yields the morphism

$$\lceil \sigma \rceil : \mathbf{1} \rightarrow X \multimap Y,$$

called the *name* of  $\sigma$ .

If  $\mathbf{C}$  is furthermore  $*$ -autonomous, then the name  $\lceil \sigma \rceil$  can be written as a morphism

$$\lceil \sigma \rceil : \mathbf{1} \rightarrow X^\perp \wp Y,$$

and the *coname*  $\lfloor \sigma \rfloor$  of  $\sigma$  is the morphism

$$\lfloor \sigma \rfloor : X \otimes Y^\perp \rightarrow \perp,$$

defined by  $\lfloor \sigma \rfloor = (\lceil \sigma^\perp \rceil)^\perp$ .

In the case of cwordisms, the name and the coname of a cwordism  $\sigma : X \rightarrow Y$  are represented by the following picture.

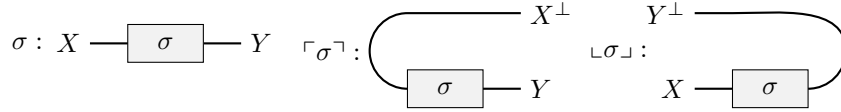

Again, in anticipation of linear logic interpretation, we note that naming and conaming of a morphism correspond simply to putting all formulas of a sequent to one side of the turnstile.

Especially important are the name and the coname of the identity, respectively, the *pairing*

$$\lfloor \text{id}_X \rfloor : X^\perp \otimes X \rightarrow \perp, \tag{9}$$

and the *copairing* maps

$$\lceil \text{id}_X \rceil : \mathbf{1} \rightarrow X^\perp \wp X \tag{10}$$

(existing in any  $*$ -autonomous category).

In the category of cwordisms these are represented by the following picture (note that wires are depicted in the correct order!).

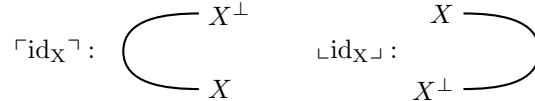

### 4.3.2 Evaluation and linear distributivity

In any monoidal closed category there exists a natural *evaluation* map

$$\text{ev}_{X,Y} : (X \multimap Y) \otimes X \rightarrow Y \quad (11)$$

obtained by correspondence (5) from  $\text{id}_{X \multimap Y}$ .

In the category of cwordisms evaluation is represented by the following picture.

$$\text{ev}_{X,Y} : \begin{array}{c} X \\ X^\perp \\ Y \end{array} \begin{array}{c} \text{---} \\ \text{---} \\ \text{---} \end{array} Y$$

Furthermore there is a natural map

$$(X \multimap Y) \otimes Z \rightarrow X \multimap (Y \otimes Z)$$

obtained from  $\text{ev}_{X,Y} \otimes \text{id}_Z$  using symmetries and (5), which, in the case when the category is  $*$ -autonomous, gives rise to the *linear distributivity* map [8]

$$\delta_{X,Y,Z} : (X \wp Y) \otimes Z \rightarrow X \wp (Y \otimes Z) \quad (12)$$

(substituting  $X$  for  $X^\perp$ ).

Linear distributivity by compositions with itself and symmetries gives rise to the *internal tensor*

$$\delta_{X,Y,Z,T} : (X \wp Y) \otimes (Z \wp T) \rightarrow X \wp (Y \otimes Z) \wp T. \quad (13)$$

and the *internal cotensor*

$$\epsilon_{X,Y,Z,T} = \delta_{X^\perp, Y^\perp, Z^\perp, T^\perp}^\perp : X \otimes (Y \wp Z) \otimes T \rightarrow (X \otimes Y) \wp (Z \otimes T) \quad (14)$$

maps.

In the case of cwordisms, where cotensor and tensor differ only by factors ordering, all three maps are just permutation maps obtained as compositions of symmetries.

### 4.3.3 Generalized compositions

Any  $*$ -autonomous category, and the category of cwordisms in particular, has a number of operations that can be considered as generalized composition in disguise.

First, in any monoidal category, given morphisms

$$\sigma : X \rightarrow Y, \quad \tau : Y \otimes T \rightarrow Z,$$

we can construct the *partial composition* of  $\sigma$  and  $\tau$  over  $T$

$$\tau \circ_Y \sigma : X \otimes T \rightarrow Z,$$

given as

$$\tau \circ_Y \sigma = \tau \circ (\sigma \otimes \text{id}_T).$$

In the case of cwordisms, partial composition is represented by the following picture.

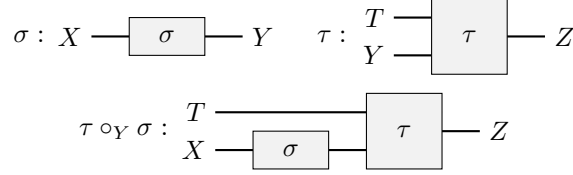

Note that usual composition is a particular case:  $\tau \circ \sigma = \tau \circ_{\mathbf{1}} \sigma$ .

If the category is furthermore  $*$ -autonomous, then, given two morphisms

$$\sigma : \mathbf{1} \rightarrow X \wp Y, \quad \tau : \mathbf{1} \rightarrow Y^\perp \wp Z,$$

we can define the *partial pairing* or the *cut*

$$\langle \sigma, \tau \rangle_Y : \mathbf{1} \rightarrow X \wp Z$$

of  $\sigma$  and  $\tau$  over  $Y$  by

$$\langle \sigma, \tau \rangle_Y = (\text{id}_X \wp (\text{Lid}_Y \lrcorner) \wp \text{id}_Z) \circ \delta_{X, Y, Y^\perp, Z} \circ (\sigma \otimes \tau).$$

In the case of cwordisms, cut is pictured as follows.

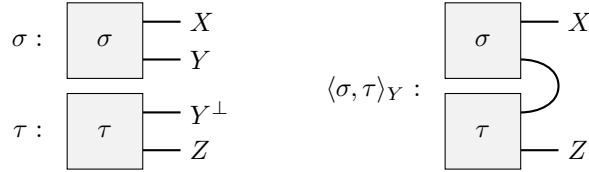

Partial pairing or cut can be understood as generalized composition in disguise because of the following observation.

**Proposition 8.** *For any two cwordisms*

$$\sigma : X \rightarrow Y, \quad \tau : Y \rightarrow Z,$$

it holds that

$$\lrcorner \tau \circ \sigma \lrcorner = \langle \lrcorner \sigma \lrcorner, \lrcorner \tau \lrcorner \rangle_Y. \quad \square$$

*Proof.* Evident from geometric representation. □

From (linear) logic point of view, partial composition corresponds to a cut between two-sided sequents, and partial pairing, to a cut between one-sided sequents. The above proposition expresses basic relation between one-sided and two-sided sequent calculus formulations.

**Remark.** Propositions of this section are, of course, true for any  $*$ -autonomous, let alone compact, category. In fact, it can be shown that graphical reasoning is valid for any compact category, see [38]. However, in the case of cwordisms, which are *defined* as geometric objects, graphical representation is *literal* and does not require further justification.

Also, in the end of this abstract section it might be reasonable to try to put our category of cwordisms into the general abstract context of compact categories.

It is easy to see that labeling and ordering boundary vertices is purely decorative; it allows us having better pictures. Eventually, if we define the size of a boundary  $X$  as a pair consisting of the size of the left part  $X_l$  and of the right part  $X_r$ , then it is the only invariant: all boundaries with the same size are (canonically) isomorphic.

Thus, up to equivalence of categories, we can consider boundaries to be just pairs of natural numbers. It can be shown then that the category of cwordisms over an alphabet  $T$  is equivalent to the *free compact category* (using definition in [1]) generated by the free monoid  $T^*$ , where  $T^*$  is considered as a category with one object.

## 5 Linear logic grammars

### 5.1 Linear logic

Strictly speaking, the system discussed below is *multiplicative linear logic*, a fragment of full linear logic. However, since we do not consider other fragments, the prefix “multiplicative” will be omitted. A more detailed introduction to linear logic can be found in [14], [15].

Given a set  $N$  of *positive literals*, we define the set  $N^\perp$  of *negative literals* as

$$N^\perp = \{X^\perp \mid X \in N\}.$$

Elements of  $N \cup N^\perp$  will be called *literals*.

The set  $Fm(N)$  of **LL** formulas (over the alphabet  $N$ ) is defined by the following induction.

- Any  $X \in N \cup N^\perp$  is a formula;
- if  $X, Y$  are formulas, then  $X \wp Y$  and  $X \otimes Y$  are formulas;

Connectives  $\otimes$  and  $\wp$  are called respectively *times* (also *tensor*) and *par* (also *cotensor*).

*Linear negation*  $A^\perp$  of a formula  $A$  is defined inductively as

$$(P^\perp)^\perp = P, \text{ for } P \in N,$$

$$(A \otimes B)^\perp = A^\perp \wp B^\perp, \quad (A \wp B)^\perp = A^\perp \otimes B^\perp.$$

It should be understood that linear negation  $(.)^\perp$  is not a connective of linear logic, but a shorthand notation for formulas, i.e. it belongs to the metalanguage.

Linear implication is defined as

$$A \multimap B = A^\perp \wp B. \quad (15)$$

Linear implication is not a connective either.

An **LL** *sequent* (over the alphabet  $N$ ) is a finite sequence of **LL** formulas (over  $N$ ).

The *sequent calculus* for **LL** is given by the following rules:

$$\begin{aligned} \vdash X^\perp, X \text{ (Id)}, \quad & \frac{\vdash \Gamma, X \quad \vdash X^\perp, \Delta}{\vdash \Gamma, \Delta} \text{ (Cut)}, \\ & \frac{\vdash \Gamma, X, Y, \Delta}{\vdash \Gamma, Y, X, \Delta} \text{ (Ex)}, \\ \frac{\vdash \Gamma, X, Y}{\vdash \Gamma, X \wp Y} \text{ } (\wp) \quad & \frac{\vdash \Gamma, X \quad \vdash Y, \Delta}{\vdash \Gamma, X \otimes Y, \Delta} \text{ } (\otimes). \end{aligned}$$

The *tensor* and *cotensor introduction* rules, respectively  $(\otimes)$  and  $(\wp)$  are called *logical* rules. Other rules are *structural*.

Notation (Ex) in the name of a rule stands for Exchange.

Linear logic enjoys the fundamental property of *cut-elimination*: any proof with cuts can be transformed to its *cut-free* form; cut-elimination is algorithmic and always terminates. This allows computational and categorical interpretations in the *proofs-as-programs* or *proofs-as-functions* paradigm.

## 5.2 Semantics

Categorical interpretation of proof theory is based on the idea that formulas should be understood as objects, and proofs as morphisms in a category, while composition of morphisms corresponds to cut-elimination.

In a two-sided sequent calculus, formulas are interpreted as objects in a monoidal category, and a proof of the sequent

$$X_1, \dots, X_n \vdash X$$

is interpreted as a morphism of type

$$X_1 \otimes \dots \otimes X_n \rightarrow X.$$

This includes the case  $n = 0$ , with the usual convention that the tensor of the empty collection of objects is the monoidal unit  $\mathbf{1}$ .

Then the Cut rule corresponds to (partial) composition. A crucial requirement is that the interpretation should be invariant under cut-elimination; a proof and its cut-free form are interpreted the same.

In the case of linear logic, whose sequents are one-sided, the appropriate setting for categorical interpretation is *\*-autonomous categories* [36], [26].

In this setting, a proof of the sequent

$$\vdash X_1, \dots, X_n$$

is interpreted as a morphism of type

$$\mathbf{1} \rightarrow X_1 \wp \dots \wp X_n.$$

The Cut rule corresponds to partial pairing, which can be understood as a symmetrized composition (Proposition 8).

We first describe interpretation of **LL** in a general  $*$ -autonomous category and then give explicit rules for the case of cwordisms.

Given a  $*$ -autonomous category  $\mathbf{C}$  and an alphabet  $N$  of positive literals, an interpretation of **LL** in  $\mathbf{C}$  consists in assigning to any positive literal  $A$  an object  $[A]$  of  $\mathbf{C}$ . The assignment of objects extends to all formulas in  $Fm(N)$  by the obvious induction

$$[A \otimes B] = [A] \otimes [B], \quad [A^\perp] = [A]^\perp.$$

A sequent  $\Gamma = A_1, \dots, A_n$  is interpreted as the object  $[\Gamma] = [A_1] \wp \dots \wp [A_n]$ .

Given interpretation of formulas, proofs are interpreted by induction on the rules so that a proof  $\pi$  of the sequent  $\Gamma$  is interpreted as a morphism  $[\pi]$  of the type  $\mathbf{1} \rightarrow [\Gamma]$ .

The axiom  $\vdash A^\perp, A$  is interpreted as copairing map (10)

$$\lceil \text{id}_{[A]} \rceil : \mathbf{1} \rightarrow [A]^\perp \wp [A].$$

The Cut rule corresponds to partial pairing, as stated above.

The Exchange rule corresponds to a symmetry transformation.

The  $(\wp)$  rule does strictly nothing. A proof of the sequent  $\vdash \Gamma, A, B$  has already been interpreted as a morphism of the type  $\mathbf{1} \rightarrow [\Gamma] \wp [A] \wp [B]$ , and this serves as the interpretation of the obtained proof of  $\vdash \Gamma, A \wp B$  as well.

The  $(\otimes)$  rule is interpreted using internal tensor (13). Namely, given proofs  $\pi$  and  $\rho$  of sequents  $\vdash \Gamma, A$  and  $\vdash B, \Delta$  respectively, the proof of  $\vdash \Gamma, A \otimes B, \Delta$  obtained from  $\pi$  and  $\rho$  is interpreted as  $\delta_{\Gamma, A, B, \Delta} \circ \pi \otimes \rho$ .

In general, it is quite customary in the literature to omit square brackets and denote a formula and its interpretation by the same expression, and we will follow this practice when convenient.

### 5.2.1 Interpretation in the category of cwordisms

We now specialize to the case of the  $*$ -autonomous category  $\mathbf{COW}_T$  of cwordisms over an alphabet  $T$ .

A proof  $\sigma$  of the sequent  $\vdash A_1, \dots, A_n$  is interpreted as a cwordism

$$\sigma : \mathbf{1} \rightarrow A_1 \wp \dots \wp A_n = A_n \otimes \dots \otimes A_1 \quad (16)$$

(we use the common convention that a formula or a proof is denoted same as its interpretation).

We will use *vertical* representation for depicting  $\sigma$ , with inputs below, and outputs above. Since there are no inputs,  $\sigma$  will be a box with only outgoing wires. Since, in the vertical representation, vertices of the outgoing boundary are depicted in the order from right to left, the wires to  $A_1, \dots, A_n$  will be depicted *in the same order* as in the sequent, as is evident from (16).

Rules for interpreting proofs in the category of cowordisms can be easily computed from the general prescription described above, using graphical representations of various natural maps computed in the preceding section. The result is represented in four pictures below. (No picture for the  $(\wp)$  rule, because it does not do anything, as noted above.)

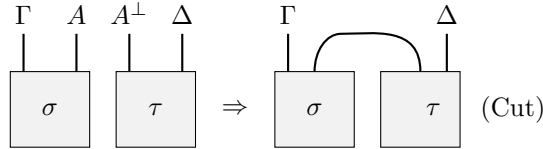
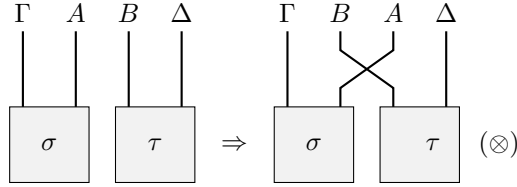
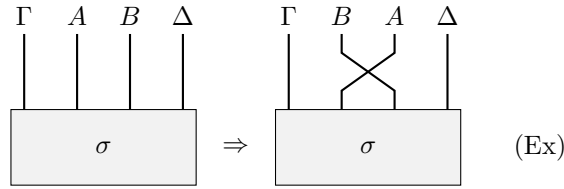

(Note that the order of wires on the righthand side of the  $(\otimes)$  rule picture is correct. The outgoing boundary is  $\Gamma \wp (A \otimes B) \wp \Delta = \Delta \otimes (A \otimes B) \otimes \Gamma$ , and according to our convention tensor factors are depicted in the opposite order.)

Observe that interpretations of proofs do not depend on the alphabet  $T$  at all. So it would be more honest to say that this is an interpretation in the category **Cob** of *cobordisms*. The alphabet comes into play if we add new axioms to the logic, which gives us a *linear logic grammar*.

**Remark.** It is important to note that the model of linear logic in the category of cowordisms, as well as in any other compact category, is *degenerate*. It identifies (up to a natural isomorphism) tensor and cotensor.

### 5.3 Adding lexicon

An **LL** grammar is an interpretation of **LL** in a category of cowordisms supplied with a set of axioms together with cowordisms representing their “proofs”.

So assume that an interpretation of **LL** in a category of cwordisms over an alphabet  $T$  is given. We will use the common convention that a formula, a sequent or a proof is denoted the same as its interpretation.

Let us say that a *cwordism typing judgement* (over  $N$  and  $T$ ) is an expression of the form

$$\frac{\sigma}{\vdash F},$$

where  $F$  is an **LL** sequent (over the alphabet  $N$ ), and

$$\sigma : \mathbf{1} \rightarrow F$$

is a cwordism over  $T$ .

**Definition 7.** A *cwordism signature*  $\Sigma$  is a tuple  $\Sigma = (N, T, \Xi)$ , where

- $N$  is a finite set of positive literals interpreted as boundaries;
- $T$  is a finite alphabet;
- $\Xi$  is a set of cwordism typing judgements over  $N$  and  $T$ , called *signature axioms* or, simply, *axioms*.

Given a cwordism signature  $\Sigma$ , any **LL** derivation from signature axioms gets an interpretation in the category of cwordisms by induction on the rules.

Let  $\Gamma$  be an **LL** sequent (or formula), and let  $\sigma : \mathbf{1} \rightarrow \Gamma$  be a cwordism.

We say that the cwordism typing judgement

$$\frac{\sigma}{\vdash \Gamma}$$

is *derivable in  $\Sigma$* , or that  $\Sigma$  *generates cwordism  $\sigma$  of type  $\Gamma$*  if there exists a derivation of  $\vdash \Gamma$  from axioms of  $\Sigma$  whose interpretation is  $\sigma$ . The *cwordism type  $\Gamma$  generated by  $\Sigma$* , or, simply, the *cwordism type  $\Gamma$  of  $\Sigma$* , is the set of all cwordisms of type  $\Gamma$  generated by  $\Sigma$ .

It is convenient to have an alternative characterization of derivability in an LLG.

For a sequent  $\Gamma = A_1, \dots, A_n$  let  $\Gamma^\perp$  denote the formula  $\Gamma^\perp = A_1^\perp \otimes \dots \otimes A_n^\perp$ . Then we have the following.

**Proposition 9.** *Let  $\Sigma$  be a cwordism signature.*

*A typing judgement*

$$\frac{\sigma}{\vdash \Gamma}$$

*is derivable in  $\Sigma$  iff there exist axioms*

$$\frac{\sigma_1}{\vdash \Gamma_1}, \dots, \frac{\sigma_k}{\vdash \Gamma_k}$$

*of  $\Sigma$  and an **LL** proof  $\pi$  (not using axioms of  $\Sigma$ ) of the sequent*

$$\vdash \Gamma_1^\perp, \dots, \Gamma_k^\perp, \Gamma$$



such that

$$\sigma = \pi \circ (\sigma_1 \otimes \dots \otimes \sigma_k)$$

(where  $\pi$  is identified with the corresponding cwordism).

*Proof.* By induction on derivation. □

**Corollary 1.** *If  $\Sigma = (N, T, \Xi)$  is a cwordism signature and there is an axiom in  $\Xi$  of the form*

$$\frac{\sigma}{\vdash \Gamma, A \wp B, \Delta}, \quad (17)$$

then we have a well-defined cwordism signature  $\Sigma'$  obtained from  $\Sigma$  by replacing (17) with

$$\frac{\sigma}{\vdash \Gamma, A, B, \Delta},$$

which generates same cwordism types as  $\Sigma$ . □

**Definition 8.** A linear logic grammar (LLG)  $G$  is a tuple  $G = (N, T, Lex, S)$ , where  $(N, T, Lex)$  is a cwordism signature, and  $S \in N$ , the *standard type*, is a literal interpreted as a boundary with exactly one left and one right endpoint.

The set  $Lex$  of the underlying signature axioms of  $G$  is called the *lexicon* of  $G$ .

We say that a typing judgement, respectively, cwordism type is generated by  $G$  if it is generated by the underlying cwordism signature.

Now, any regular cwordism of the standard type  $S$  generated by  $G$  is an edge-labeled graph containing a single edge labeled with a word over  $T$ . Thus the set of type  $S$  regular cwordisms can be identified with a set of words in  $T^*$ .

The *language*  $L(G)$  generated by  $G$  is the set of words labeling type  $S$  regular cwordisms generated by  $G$ .

**Remark.** We noted above that the model of linear logic in the category of cwordisms is degenerate.

However, given an LLG (or just a cwordism signature)  $G$ , we can consider a *refined* category of cwordisms, whose objects are types of  $G$  and morphisms are cwordisms generated by  $G$ . (More accurately, a morphism between types  $A$  and  $B$  is a cwordism  $\sigma : A \rightarrow B$  such that the name  $\ulcorner \sigma \urcorner$  is in the type  $A \multimap B$  of  $G$ .)

This gives us another model, which, in a generic case, will be nondegenerate.

Thus, from the point of view of **LL** model theory, an LLG (or a cwordism signature) is a way of refining compact closed structure in order to remove degeneracy of the model. This approach to constructing models is very common, see, for example, [40], [17].

### 5.3.1 Example

Consider the following alphabets  $N$ ,  $T$  of literals and terminal symbols respectively:

$$T = \{\text{John, Mary, leaves, loves, madly, who}\}, \quad N = \{\text{NP, S}\}.$$

We interpret both nonterminal symbols as the boundary  $(r, l)$  with the only left endpoint  $l$ .

Then we introduce the following lexicon:

$$\left\{ \frac{\text{JOHN} \quad \text{MARY} \quad \text{LEAVES}}{\vdash \text{NP} \quad \vdash \text{NP} \quad \vdash \text{NP}^\perp, \text{S}}, \right. \\ \left. \frac{\text{LOVES}}{\vdash \text{NP}^\perp, \text{NP}^\perp, \text{S}}, \frac{\text{MADLY}}{\vdash \text{NP} \otimes \text{S}^\perp, \text{NP}^\perp, \text{S}}, \frac{\text{WHO}}{\vdash \text{NP} \otimes \text{S}^\perp, \text{NP}^\perp, \text{NP}} \right\}.$$

Cowordisms of the lexicon are depicted below.

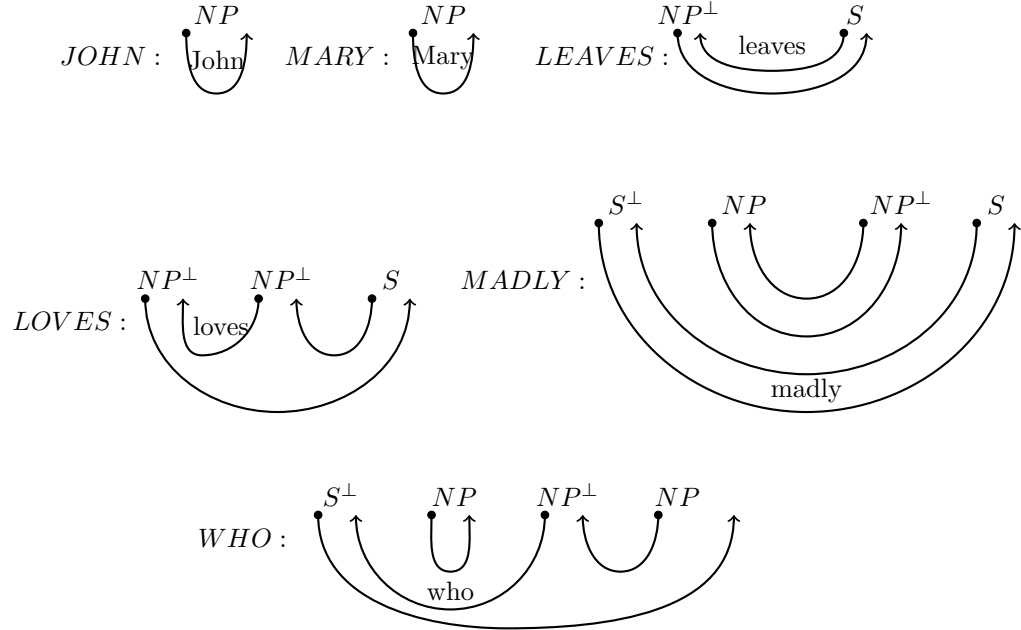

(Note that, if we identify a sequent with the cotensor of its formulas, then types in the above lexicon can be written using only linear implication (15):  $NP$ ,  $NP \multimap S$ ,  $NP \multimap NP \multimap S$ ,  $(NP \multimap S) \multimap NP \multimap S$  etc.)

This data defines an LLG.

Let us go through some derivation. We chose the following one.

$$\begin{array}{c}
 \text{LOVES} \\
 \hline
 \vdash NP^\perp, NP^\perp, S \\
 \hline
 \vdash NP^\perp, NP^\perp, \wp S^{(\wp)} \quad \text{MADLY} \\
 \hline
 \vdash NP \otimes S^\perp, NP^\perp, S \quad (\text{Cut}) \\
 \hline
 \text{JOHN} \quad \vdash NP^\perp, NP^\perp, S \\
 \hline
 \vdash NP \quad \vdash NP^\perp, NP^\perp, S \quad (\text{Ex}) \\
 \hline
 \vdash NP^\perp, S \quad (\text{Cut}) \\
 \hline
 \text{MARY} \quad \vdash NP^\perp, NP, NP \otimes S^\perp \quad (\text{Ex}) \quad \vdash NP^\perp, S \\
 \hline
 \vdash NP^\perp, NP \quad \vdash NP^\perp, \wp S \quad (\wp) \\
 \hline
 \vdash NP \quad \vdash NP^\perp, NP \quad (\text{Cut}) \\
 \hline
 \vdash NP \quad \vdash NP^\perp, S \quad (\text{Cut}) \\
 \hline
 \vdash S
 \end{array}$$

We start from axioms corresponding to *LOVES* and *MADLY*.

Then the first step is a cut between these two. This is interpreted by partial pairing, and the picture is the following.

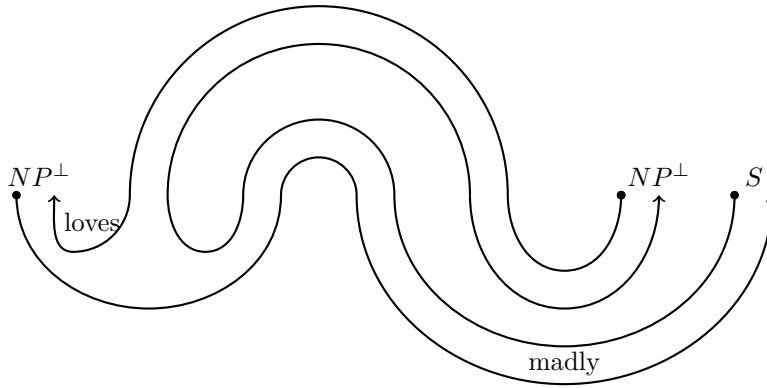

The result can be simplified.

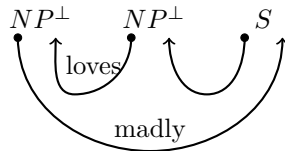

Applying to this the Exchange rule and cutting with *JOHN*, we get the follow-

ing.

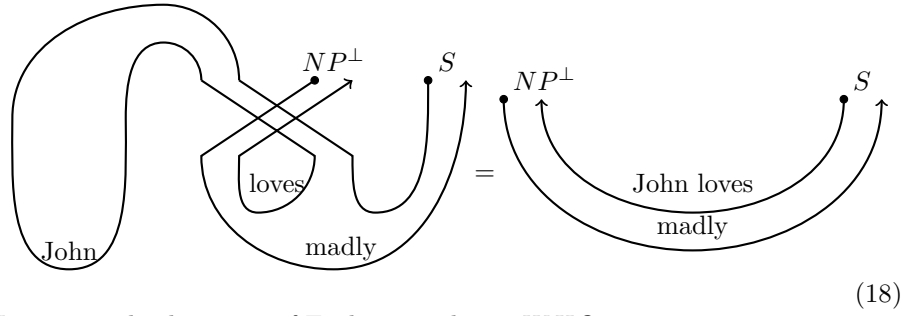

Now we apply the series of Exchange rules to *WHO*.

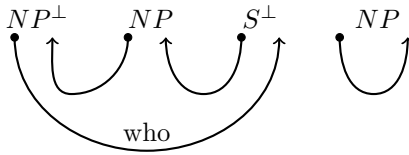

Then we cut the result with (18).

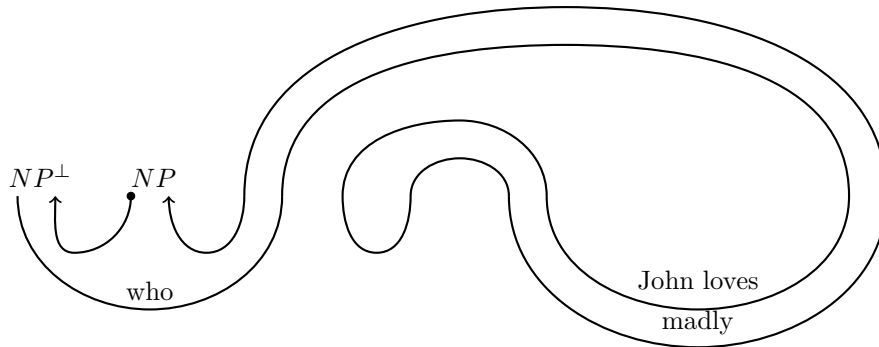

The result has a rather simple shape.

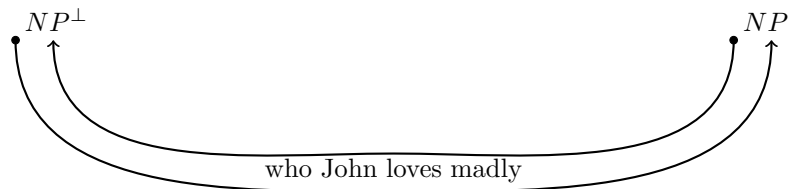

Now it must be clear that after remaining steps we obtain the string

Mary who John loves madly leaves.

**Remark.** We deliberately chose a rather non-optimal derivation in order to show symmetry transformations. The same string could be generated in the same grammar with fewer Exchange rules. Also, we chose types for lexicon entries which appear as translations of linear implicational types. If, on the other hand, we had, as the type for the transitive verb (i.e. *LOVES*), the sequent  $\vdash NP^\perp, S, NP^\perp$ , the analogous derivation would be shorter as well.

## 6 Encoding multiple context-free grammars

In this section, as an example, we establish a relationship between LLG and *multiple context-free grammars*.

### 6.1 Multiple context-free grammars

Multiple context-free grammars were introduced in [37]. We follow (with minor variations in notation) the presentation in [19].

**Definition 9.** A *multiple context free grammar (MCFG)*  $G$  is a tuple  $G = (N, T, S, P)$  where

- $N$  is a finite alphabet of nonzero arity predicate symbols called *nonterminal symbols* or *nonterminals*;
- $T$  is a finite alphabet of *terminal symbols* or *terminals*;
- $S \in N$ , the *start symbol*, is unary;
- $P$  is a finite set of sequents, called *productions*, of the form

$$B_1(x_1^1, \dots, x_{k_1}^1), \dots, B_n(x_1^n, \dots, x_{k_n}^n) \vdash A(s_1, \dots, s_k), \quad (19)$$

where

- (i)  $n \geq 0$  and  $A, B_1, \dots, B_n$  are nonterminals with arities  $k, k_1, \dots, k_n$  respectively;
- (ii)  $\{x_i^j\}$  are pairwise distinct variables not from  $T$ ;
- (iii)  $s_1, \dots, s_k$  are words built of terminals and  $\{x_i^j\}$ ;
- (iv) each of the variables  $x_i^j$  occurs exactly once in exactly one of the words  $s_1, \dots, s_k$ .

**Remark** Productions are often written in the opposite order in the literature; with  $A$  on the left and  $B_1, \dots, B_n$  on the right.

Also, our “non-erasing” condition (iv) in the definition of an MCFG, namely, that all  $x_i^j$  occurring on the left occur exactly once on the right, is too strong compared with original definitions in [37], [19]. Usually it is required only that each  $x_i^j$  should occur at most once on the right. However, it is known [37] that adding the non-erasing condition does not change the expressive power of MCFG, in the sense that the class of generated languages (see below) remains the same.

**Definition 10.** The set of *predicate formulas derivable in  $G$*  is defined by the following induction.

- (i) If a production  $\vdash A(s_1, \dots, s_k)$  is in  $P$ , then  $A(s_1, \dots, s_k)$  is derivable.
- (ii) For every production (19) in  $P$ , if
  - $B_1(s_1^1, \dots, s_{k_1}^1), \dots, B_n(s_1^n, \dots, s_{k_n}^n)$  are derivable,
  - $t_m$  is the result of substituting the word  $s_i^j$  for every variable  $x_i^j$  in  $s_m$ , for  $m = 1, \dots, k$ ,

then the formula  $A(t_1, \dots, t_k)$  is derivable.

**Remark.** Technically, condition (i) above is a particular case of (ii) when  $n = 0$ .

We use notation  $\vdash_G F$  to express that  $F$  is derivable in  $G$ .

**Definition 11.** The *language generated* by an MCFG  $G$  is the set of words  $w$  for which  $\vdash_G S(w)$ .

*Multiple context-free language* is a language generated by some MCFG.

When all predicate symbols in  $N$  are unary, the above definition reduces to the more familiar case of a *context free grammar* (CFG).

## 6.2 Cowordism representation of MCFG

### 6.2.1 Productions as cowordisms

**Definition 12.** Let  $C$  be a predicate symbol of arity  $k > 0$ .

The *carrier*  $[C]$  of  $C$  is the boundary

$$[C] = (l_1^C, r_1^C, \dots, l_k^C, r_k^C), \text{ with } [C]_l = (l_1^C, \dots, l_k^C). \quad (20)$$

The *pattern*  $Pat(C)$  of  $C$  is the cobordism

$$Pat(C) : \mathbf{1} \rightarrow [C]$$

with edges  $e_i^C = (l_i^C, r_i^C)$ ,  $i = 1, \dots, k$ .

If

$$C(s_1, \dots, s_k), \quad (21)$$

is a predicate formula, where  $s_1, \dots, s_k$  are words over some alphabet  $T$ , then the cowordism

$$[C(s_1, \dots, s_k)] : \mathbf{1} \rightarrow [C]$$

over  $T$  *representing formula* (21) is obtained from  $Pat(C)$  by labeling each edge  $e_i^C$  with  $s_i$ ,  $i = 1, \dots, k$ .

The above definition allows representing predicate formulas with variables as well. If some of  $s_1, \dots, s_k$  in (21) are not words, but variables from some set  $V$ , we simply consider the set  $T \cup V$  as a new alphabet.

Now assume that we are given an MCFG  $G = (N, T, S, P)$ .

We are going to represent productions of  $G$  as cowordisms as well.

**Definition 13.** Given a production  $p$  of form (19), a cwordism

$$[p] : [B_1] \otimes \dots \otimes [B_n] \rightarrow [A]$$

represents  $p$  if the following equation holds

$$[p] \circ ([B_1(x_1^1, \dots, x_{k_1}^1)] \otimes \dots \otimes [B_n(x_1^n, \dots, x_{k_n}^n)]) = [A(s_1, \dots, s_k)]. \quad (22)$$

Before giving a general construction of  $[p]$  we consider a simple example.

**Example.** Let  $T = \{a, b\}$  be the alphabet of terminals.

Consider nonterminals  $P$ ,  $Q$  and  $S$  of arities 2, 2 and 1 respectively, and the following six productions

$$\vdash P(\epsilon, \epsilon) \quad (1), \quad \vdash Q(\epsilon, \epsilon) \quad (2), \quad P(x, y) \vdash P(xa, yb) \quad (3),$$

$$Q(z, t) \vdash Q(za, ta) \quad (4), \quad Q(z, t) \vdash Q(zb, tb) \quad (5), \quad Q(z, t), P(x, y) \vdash S(zxty) \quad (6).$$

It is easy to see that the constructed MCFG generates the language

$$\{wa^nwb^n \mid w \in T^*, n \geq 0\}. \quad (23)$$

Now we construct cwordisms representing  $G$ . We will omit square brackets and use the same notation for a predicate symbol or a production and for its graphical representation.

We denote elements of carriers  $P$  and  $Q$  as

$$P = (x_l, x_r, y_l, y_r), \quad Q = (z_l, z_r, t_l, t_r).$$

Six cwordisms representing the productions are shown in the picture below

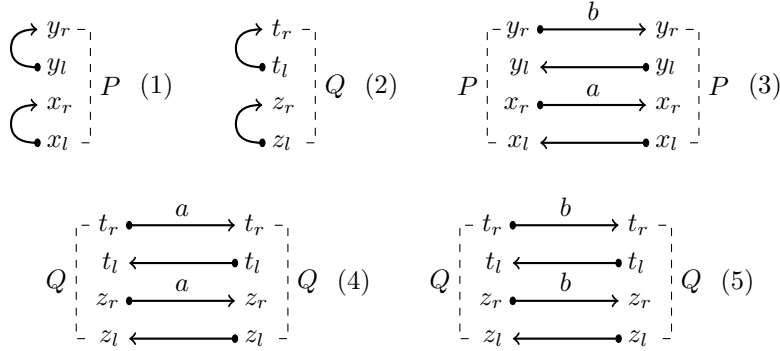

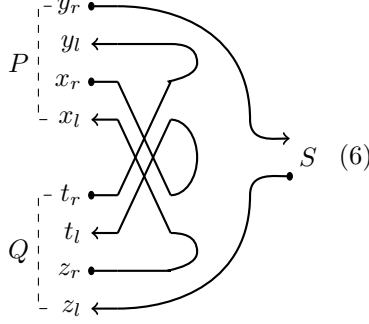

It is easy to see that the above cowordisms indeed are solutions of the corresponding equations of form (22).

Hopefully, it is also easy to convince oneself that these six cowordisms together with symmetry maps generate by composition and tensor product all cowordisms from  $\mathbf{1}$  to  $S$  representing words of (23) and no other words.

The solution of (22) is constructed as follows.

Let  $V$  be the set of all variables  $x_i^j$  occurring in  $p$ , and let  $E$  be the set of all edges  $e_i^j$  in patterns of  $B_1, \dots, B_n$ .

For each pair  $(i, j)$ ,  $i = 1, \dots, k_j$ ,  $j = 1, \dots, n$  we denote  $e_i^j = e_i^{B_j}$ .

This establishes a correspondence between sets  $V$  and  $E$ . Each cowordism

$$[B_j(x_1^j, \dots, x_{k_j}^j)]$$

is obtained by labeling the edge  $e_i^j \in E$  with  $x_i^j \in V$ .

For each  $y = x_i^j \in V$  we denote the left and right endpoints of the corresponding edge in  $E$  as  $l(y)$  and  $r(y)$  respectively, i.e

$$l(x_i^j) = l_i^{B_j}, \quad r(x_i^j) = r_i^{B_j}.$$

Now, each word  $s_m$ ,  $m = 1, \dots, k$ , on the righthand side of  $p$  is a concatenation of the form

$$s_m = w_m^0 y_m^1 w_m^1 \dots y_m^{\alpha_m} w_m^{\alpha_m},$$

where all

$$w_m^0, \dots, w_m^{\alpha_m}$$

are words in the alphabet  $T$  (possibly empty), and

$$y_m^1, \dots, y_m^{\alpha_m}$$

are variables from  $V$ . (With the convention that  $\alpha_m$  may equal zero, in which case  $s_m = w_m^0$ .)

We define the cowordism  $[p]$  by taking edges

$$p_m^0 = (l_m^A, l(y_m^1)), \quad p_m^i = (r(y_m^i), l(y_m^{i+1})),$$



$$p_m^{\alpha_m} = (r(y_m^{\alpha_m}), r_m^A)$$

and labeling each edge  $p_i^m$  with  $w_i^m$ ,  $i = 1, \dots, \alpha_m - 1$ ,  $m = 1, \dots, k$ .

This solves (22)

An immediate consequence of (22) is the following.

**Proposition 10.** *Let*

$$B(s_1^1, \dots, s_{\alpha_1}^1), \dots, B(s_n^1, \dots, s_{\alpha_n}^1)$$

*be predicate formulas, with arities  $k_1, \dots, k_m$  respectively.*

*Let  $t_m$  be the result of substituting the word  $s_i^j$  for every variable  $x_i^j$  in  $s_m$ , for  $m = 1, \dots, k$ ,*

*Then we have the identity*

$$[p] \circ ([B_1(s_1^1, \dots, s_{\alpha_1}^1)] \otimes \dots \otimes [B_n(s_n^1, \dots, s_{\alpha_n}^1)]) = [A(t_1, \dots, t_k)]. \quad \square$$

## 6.2.2 Context-free cwordism grammars

Now that we have represented MCFG productions as cwordisms, it will be convenient to reformulate (and slightly generalize) MCFG in the language of cwordisms directly.

**Definition 14.** A *context-free cwordism grammar (cwordism CFG)*  $G$  is a tuple  $G = (N, T, P, S)$ , where

- $N$  is a finite set of *types*, each type  $A$  being assigned a boundary  $[A]$ , the *carrier* of  $A$ ;
- $T$  is a finite alphabet of *terminal symbols*;
- $P$ , is a finite set of rules of the form

$$\sigma : A_1 \otimes \dots \otimes A_n \rightarrow A, \quad (24)$$

Where  $A_1, \dots, A_n, A$  are elements of  $N$ , and

$$\sigma : [A_1] \otimes \dots \otimes [A_n] \rightarrow [A].$$

is a cwordism;

- $S \in N$  is the *standard type*, with the carrier  $[S]$  having exactly one left endpoint and one right endpoint.

Elements of  $P$  are called *cwordism productions*.

Now, for any type  $A \in N$ , we will define the set of *type  $A$  cwordisms generated by  $G$* , or, simply, the *cwordism type  $A$  of  $G$* . We will write  $\vdash_G \sigma : A$  to express that  $\sigma$  is in the cwordism type  $A$  of  $G$ .

The set is defined by induction.

- If a cwordism production  $\sigma : \mathbf{1} \rightarrow A$  is in  $P$ , then  $\vdash_G \sigma : A$ .

- If a cwordism production

$$\sigma : A_1 \otimes \dots \otimes A_n \rightarrow A$$

is in  $P$ , and

$$\vdash_G \tau_i : A_i, \quad i = 1, \dots, n,$$

then  $\vdash_G \sigma \circ (\tau_1 \otimes \dots \otimes \tau_n) : A$ .

Any regular cwordism in the type  $S$  of  $G$  consists of exactly one edge labeled with a word in  $T^*$ . It is natural to identify the cwordism type  $S$  of  $G$  with the language generated by  $G$ .

**Definition 15.** The *language generated by the cwordism CFG*  $G$  or, simply, the *language of*  $G$  is the set of words occurring as edge labels in type  $S$  regular cwordisms generated by  $G$ .

We denote the language generated by  $G$  as  $L(G)$ .

Now, given an MCFG  $G = (N, T, P, S)$ , the cwordism representation described in the preceding section gives us a cwordism CFG.

We put  $G' = (N, T, P', S)$ , where each nonterminal  $C \in N$  is assigned its carrier  $[C]$  as in Definition 12, and  $P'$  is the set of cwordism productions representing elements of  $P$  in the sense of Definition 13:

$$P' = \{[p] \mid p \in P\}.$$

It is easy to see that  $G$  and  $G'$  are equivalent in all conceivable ways.

**Proposition 11.** *In notation as above, for any predicate symbol  $C \in N$  of arity  $k$  and words  $s_1, \dots, s_k \in T^*$  it holds that  $\vdash_G C(s_1, \dots, s_k)$  iff  $\vdash_{G'} [C(s_1, \dots, s_k)]$ . In particular,  $L(G) = L(G')$ .*

*Proof.* By induction on derivation using Proposition 10. □

### 6.2.3 From cwordism CFG to MCFG

Let  $G = (N, T, P, S)$  be a cwordism CFG.

For each  $A \in N$  and regular cwordism  $\sigma : \mathbf{1} \rightarrow [A]$  such that  $\vdash_G \sigma : A$  let  $Pat(\sigma)$  be the pattern of  $\sigma$ , i.e. the cobordism obtained from  $\sigma$  by erasing all labels from edges.

We say that  $Pat(\sigma)$  is a *possible pattern* of  $A$ .

We denote the set of possible patterns of  $A$  as  $Patt(A)$ . Note that this set is finite.

**Definition 16.** The cwordism CFG  $G$  is *simple*, if for any type  $A \in N$  the set  $Patt(A)$  contains at most one element.

It is easy to see that a cwordism CFG constructed from an MCFG is simple. Let us show that there is an inverse translation.

**Proposition 12.** *If a language is generated by a simple cwordism CFG, then it is also generated by MCFG.*

*Proof.* Let  $G = (N, T, P, S)$  be a cwordism CFG.

For each  $A \in N$ , choose an enumeration

$$e_1^A, \dots, e_k^A$$

of edges in  $Pat(A)$ . For each edge  $e_i^A$  let  $l_i^A, r_i^A$  denote its left and right endpoint respectively,  $i = 1, \dots, k$ .

Consider the boundary

$$[A]' = (l_1^A, r_1^A, \dots, l_k^A, r_k^A), \quad \text{with } [A]_l' = (l_1^A, \dots, l_k^A).$$

Obviously, the boundaries  $[A]$  and  $[A]'$  may differ only by a permutation of vertices.

In particular, they are isomorphic, i.e. there exist invertible cwordisms (even cobordisms)

$$\rho^A : [A] \rightarrow [A]', \quad \tau^A : [A]' \rightarrow [A]$$

with  $\tau^A \circ \rho^A = \text{id}_A$ ,  $\rho^A \circ \tau^A = \text{id}_{A'}$ .

It follows that we get an equivalent cwordism CFG by assigning to each  $A \in N$  the carrier  $[A]'$  and replacing, in each cwordism production of form (24), the cwordism  $\sigma$  with

$$\rho^A \circ \sigma \circ (\tau^{A_1} \otimes \dots \otimes \tau^{A_n}) : [A_1]' \otimes \dots \otimes [A_n]' \rightarrow [A]'$$

Without loss of generality we assume in the sequel that  $[A] = [A]'$  and omit primes.

Then for each  $A \in N$  we introduce a predicate symbol  $A$  of arity  $k$ , where  $n$  is the number of edges in  $Pat(A)$  (the abuse of notation is deliberate).

Now let  $P_0 \subseteq P$  be the set of cwordism productions that participate in generation of  $L(G)$ .

All cwordisms occurring in  $P_0$  are regular, because elements of  $L(G)$  are defined by regular cwordisms.

For each element  $p \in P_0$  of form (24) we write an MCFG production  $p'$  as follows.

Let  $e_i^j = e_i^{A_j}$  be the  $i$ th edge in  $Pat(A_j)$  and let  $k_j$  be the number of edges in  $Pat(A_j)$ ,  $j = 1, \dots, n$ .

Let  $V$  be the set of variables  $x_i^j$ ,  $i = 1, \dots, k_j$ ,  $j = 1, \dots, n$ .

Labeling each edge  $e_i^j$  with  $x_i^j$ , we obtain  $n$  regular cwordisms over  $T \cup V$

$$\sigma_j : \mathbf{1} \rightarrow [A_j],$$

with  $Pat(\sigma_j) = Pat(A_j)$  and, in fact,

$$\sigma_j = [A_j(x_1^j, \dots, x_{k_j}^j)]$$

in the sense of Definition 12,  $j = 1, \dots, n$ .

It follows that the pattern of

$$\tau = \sigma \circ (\sigma_1 \otimes \dots \otimes \sigma_n)$$

coincides with  $Pat(A)$ , hence  $\tau$  represents, in the sense of Definition 12 some formula

$$A(s_1, \dots, s_k),$$

where  $s_1, \dots, s_k \in T \cup V$  and  $k$  is the number of edges in  $Pat(A)$ .

We write  $p'$  as

$$A_1(x_1^1, \dots, x_{k_1}^1), \dots, A_n(x_1^n, \dots, x_{k_n}^n) \vdash A(s_1, \dots, s_k).$$

Thus we obtain an MCFG  $G' = (N, T, P', S)$ , where

$$P' = \{p' \mid p \in P_0\}.$$

By induction on derivations similar to Proposition 11, we establish that  $G'$  generates the same language as  $G$ .  $\square$

Now we generalise the above to arbitrary cwordism CFG  $G$ .

**Lemma 1.** *For any cwordism CFG  $G$  there exists a simple cwordism CFG  $G'$  generating the same language.*

*Proof.* Let  $G = (N, T, P, S)$ . Without loss of generality we may assume that  $L(G)$  is nonempty, otherwise the statement is obvious. (We can take  $G'$  with no productions at all.)

We construct a new cwordism CFG  $G'$  as follows.

For any type  $A \in N$  and any possible pattern  $\pi$  of  $A$  we introduce a new symbol  $(A, \pi)$ .

We define the set  $N'$  of types of  $G'$  as

$$N' = \{(A, \pi) \mid A \in N, \pi \in Patt(A)\}.$$

Interpretation of types is given by

$$[A, \pi] = [A].$$

For any cwordism production

$$\sigma : A_1 \otimes \dots \otimes A_n \rightarrow A$$

of  $G$  we consider all possible cwordism productions of the form

$$\sigma' : (A_1, \pi_1) \otimes \dots \otimes (A_n, \pi_n) \rightarrow (A, \pi), \quad (25)$$

where

$$\pi_i \in Patt(A_i), \quad i = 1, \dots, n,$$

and  $\pi \in \text{Patt}(A)$  is constructed as the composition

$$\tau = \text{Pat}(\sigma) \circ (\pi_1 \otimes \dots \otimes \pi_n).$$

The set  $P'$  of productions for  $G'$  consists of all cwordism productions of form (25). Again, there are only finitely many of them.

Since the set  $L(G)$  is assumed nonempty, the set  $\text{Patt}(S)$  is a singleton. We denote  $S' = (S, e)$ , where  $e$  is the only element of  $\text{Patt}(S)$ .

We define  $G'$  as  $G' = (N', T, L', S')$ .

It is immediate that  $G'$  is simple and generates the same language as  $G$ .  $\square$

Combining the above with the preceding lemma, we obtain the following.

**Lemma 2.** *A language is multiple context-free iff it is generated by a cwordism CFG.  $\square$*

## 6.3 Embedding in LLG

### 6.3.1 From cwordism CFG to LLG

Any cwordism CFG (hence any MCFG) gives rise to an LLG.

Let  $G = (N, T, P, S)$  be a cwordism CFG.

We consider each type  $A \in N$  as a positive literal, whose interpretation is its carrier  $[A]$ .

Then we define an LLG  $G' = (N, T, P', S)$  where the lexicon  $P'$  consists of expressions

$$\frac{\ulcorner \sigma \urcorner}{\vdash \Gamma}$$

such that

$$\Gamma = A_1^\perp, \dots, A_n^\perp, A \tag{26}$$

and there is a production  $\sigma : A_1 \otimes \dots \otimes A_n \rightarrow A$  in  $P$ .

Note that the grammar is well defined. The sequent  $\Gamma$  is interpreted as the boundary  $[\Gamma] = [A_1]^\perp \wp \dots \wp [A_n]^\perp \wp [A]$ , and the name  $\ulcorner \sigma \urcorner$ , by definition, is a cwordism from the empty boundary  $\mathbf{1}$  to  $[\Gamma]$ .

It is immediate from Proposition 10 that the language generated by  $G$  is a subset of the language generated by  $G'$ .

Let us prove the opposite inclusion

Note that the constructed LLG  $G'$  has a particularly simple lexicon: formulas in the lexicon do not contain any logical connective. Let us call such lexicons *logic-free*.

**Proposition 13.** *Let  $H$  be an LLG with a logic-free lexicon.*

*Let  $\Gamma$  be a sequent not containing logical connectives, and let*

$$\frac{\sigma}{\vdash \Gamma}$$

*be a typing judgement derivable in  $H$ .*

*Then  $\sigma$  is an interpretation of a derivation  $\pi$  of  $\Gamma$  from axioms of  $H$  such that  $\pi$  does not contain any logical rules.*

*Proof.* Let  $\pi$  be a derivation of  $\Gamma$  from axioms of  $H$  whose interpretation is  $\sigma$ .

Since interpretation is invariant under cut-elimination, and cut-elimination for **LL** always terminates, we may assume that no step of the cut-elimination algorithm can be applied to transform  $\pi$ .

Assume that there is an occurrence of a logical rule in  $\pi$ .

Any logical rule introduces a logical connective. It follows that there is an application of the Cut rule afterwards that eliminates this connective, because  $\Gamma$  is connective-free. This cut is on a compound formula, so none of its premises is an axiom. But then the cut-elimination algorithm applies, and  $\pi$  can be transformed.  $\square$

Coming back to our cwordism CFG  $G$  and corresponding LLG  $G'$ , we have the following.

**Corollary 2.** *Let*

$$\Gamma = A_1^\perp, \dots, A_n^\perp, A$$

where  $A_1, \dots, A_n, A \in N$ , and let

$$\frac{\sigma}{\vdash \Gamma}$$

be a typing judgement derivable in  $G'$ ,

If

$$\sigma_i : \mathbf{1} \rightarrow A_i$$

are cwordisms such that

$$\vdash_G \sigma_i : A_i, \quad i = 1, \dots, n,$$

then

$$\vdash_G \langle \sigma_1 \otimes \dots \otimes \sigma_n, \sigma \rangle_{A_1 \otimes \dots \otimes A_n} : A.$$

*Proof.* By induction on a  $G'$  derivation without logical rules.  $\square$

**Corollary 3.** *The language of  $G'$  coincides with the language of  $G$ .  $\square$*

Thus we have established the following.

**Lemma 3.** *If a language is generated by a cwordism CFG, then it is generated by an LLG.  $\square$*

The converse of Lemma 3 is false, as we will show later.

It is not hard to see though that it holds when the lexicon of an LLG is logic free.

In fact, we can be less restrictive and require that the lexicon has no occurrence of the  $\otimes$ -connective. We will call such lexicons  $\otimes$ -free.

### 6.3.2 From $\otimes$ -free lexicon to cwordism CFG

A  $\otimes$ -free lexicon is essentially a logic free lexicon.

**Proposition 14.** *Any  $\otimes$ -free LLG  $G$  can be replaced with an LLG  $G'$  whose lexicon is logic free and which generates same types as  $G$ .*

*Proof.* Immediate from Corollary 1. □

So it is sufficient to consider an LLG  $G = (T, N, Lex, S)$  whose lexicon  $Lex$  is logic free.

For each axiom

$$\frac{\sigma}{\vdash A_1, \dots, A_n} \in Lex,$$

where  $A_1, \dots, A_n$  are literals, consider  $n$  cwordisms

$$\sigma_i : A_{i+1}^\perp \otimes \dots \otimes A_n^\perp \otimes A_1^\perp \otimes \dots \otimes A_{i-1}^\perp \rightarrow A_i, \quad i = 1, \dots, n \quad (27)$$

obtained from  $\sigma$  using correspondence (6) and symmetry transformations.

We take the set of literals

$$N' = N \cup N^\perp$$

as the set of types for a cwordism CFG and the set  $P$  of all cwordisms of form (27) as the set of cwordism productions.

This gives us a cwordism CFG  $G'$ .

By an easy induction on derivation  $G'$  we establish that  $L(G') \subseteq L(G)$ .

For the opposite inclusion we have the following.

**Proposition 15.** *Let*

$$\Gamma = A_1, \dots, A_n$$

where  $A_1, \dots, A_n$  are literals, and let

$$\frac{\sigma}{\vdash \Gamma}$$

be a typing judgement derivable in  $G$ ,

If

$$\sigma_i : \mathbf{1} \rightarrow A_i$$

are cwordisms such that

$$\vdash_{G'} \sigma_i : A_i, \quad i = 1, \dots, n-1$$

then

$$\vdash_{G'} \langle \sigma_1 \otimes \dots \otimes \sigma_{n-1}, \sigma \rangle_{A_1 \otimes \dots \otimes A_{n-1}} : A_n.$$

*Proof.* By induction on a  $G$  derivation without logical rules. □

**Corollary 4.** *The language of  $G'$  coincides with the language of  $G$ . □*

Summing up, we have established the following.

**Lemma 4.** *A language  $L$  is generated by a cowordism CFG iff  $L$  is generated by an  $\otimes$ -free LLG.  $\square$*

Putting the above and Lemma 2 together we obtain the following.

**Theorem 1.** *A language is multiple context-free iff it is generated by an LLG with a  $\otimes$ -free lexicon.  $\square$*

## 7 Representing abstract categorial grammars

Abstract categorial grammars (ACG) were introduced in [12]. They are based on the purely implicational fragment of linear logic, and **LL** grammars of this paper can be seen as a representation and extension of ACG.

In this section we assume that the reader is familiar with basic notions of  $\lambda$ -calculus, see [4] for a reference. We use [7] as a reference for syntax and semantics of linear  $\lambda$ -calculus and intuitionistic linear logic. We note though that we consider only the simplest, implicational fragment, while definitions and results in [7] are formulated for the full system. In fact, theorems of [7] that we cite are rather straightforward in the purely implicational case.

### 7.1 Implicational logic and Linear $\lambda$ -calculus

#### 7.1.1 Linear $\lambda$ -calculus

Given a set  $N$  of *literals*, the set  $Fm_{\multimap}(N)$  of *implicational linear logic (ILL)* formulas (over  $N$ ), also denoted as  $Tp(N)$  and called the set of *linear implicational types* (over  $N$ ), is defined by induction.

- Any  $A \in N$  is in  $Fm_{\multimap}(N)$ ;
- if  $A, B \in Fm_{\multimap}(N)$ , then  $(A \multimap B) \in Fm_{\multimap}(N)$ .

**ILL** formulas, seen as types, are used for typing *linear  $\lambda$ -terms*, which are  $\lambda$ -terms where each variable occurs exactly once.

More accurately, given a set  $X$  of *variables* and a set  $C$  of *constants*, with  $C \cap X = \emptyset$ , the set  $\Lambda(X, C)$  of *linear  $\lambda$ -terms* is defined by the following.

- Any  $a \in X \cup C$  is in  $\Lambda(X, C)$ ;
- if  $t, s \in \Lambda(X, C)$  are linear  $\lambda$ -terms whose sets of free variables are disjoint then  $(t \cdot s) \in \Lambda(X, C)$ ;
- if  $t \in \Lambda(X, C)$ , and  $x \in X$  occurs freely in  $t$  exactly once then  $(\lambda x.t) \in \Lambda(X, C)$ .



We use common notational conventions such as omitting dots and outermost brackets and writing iterated applications as

$$(tsk) = (ts)k. \quad (28)$$

A *typing judgement* is a sequent of the form

$$x_1 : A_1, \dots, x_n : A_n \vdash t : A,$$

where  $x_1, \dots, x_n \in X$  are pairwise distinct ( $n$  may be zero),  $t \in \Lambda(X, C)$ , and  $A_1, \dots, A_n, A \in Tp(N)$ .

Typing judgements are derived from the following type inference rules.

$$x : A \vdash x : A \text{ (Id)},$$

$$\frac{\Gamma \vdash t : A \multimap B \quad \Delta \vdash s : A}{\Gamma, \Delta \vdash (ts) : B} \text{ (}\multimap\text{ E)}, \quad \frac{\Gamma, x : A, \Delta \vdash t : B}{\Gamma, \Delta \vdash (\lambda x.t) : A \multimap B} \text{ (}\multimap\text{ I)}.$$

An **ILL** *sequent* is an expression of the form  $A_1, \dots, A_n \vdash A$ , where  $A_1, \dots, A_n$  and  $A$  are **ILL** formulas.

*Natural deduction* formulation of **ILL** is given by rules of linear  $\lambda$ -calculus with all terms erased.

Thus, linear  $\lambda$ -calculus, from a proof-theoretical point of view, is a way to label **ILL** proofs. The following is a “linear” case of *Curry-Howard isomorphism*.

**Proposition 16** ([7]). *There is a one-to-one correspondence between **ILL** natural deduction proofs and derivable typing judgements.*  $\square$

**Definition 17.** A *linear signature*, or, simply, a *signature*,  $\Sigma$  is a triple  $\Sigma = (N, C, \mathfrak{T})$ , where  $N$  is a finite set of atomic types,  $C$  is a finite set of constants and  $\mathfrak{T}$  is a function assigning to each constant  $c \in C$  a linear implicational type  $\mathfrak{T}(c) \in Tp(N)$ .

Typing judgements of the form

$$\vdash c : \mathfrak{T}(c), \quad (29)$$

where  $c \in C$ , are called *signature axioms* of  $\Sigma$ .

Given a signature  $\Sigma$ , we say that a typing judgement is *derivable in*  $\Sigma$  if it is derivable from axioms of  $\Sigma$  by rules of linear  $\lambda$ -calculus. We write in this case  $\Gamma \vdash_{\Sigma} t : A$ .

### 7.1.2 Semantics

Let  $\mathbf{C}$  be a symmetric monoidal category, and  $N$  be a set of literals.

An interpretation of linear types (or **ILL** formulas) over  $N$  in  $\mathbf{C}$  consists in assigning to each atomic type  $A \in N$  an object  $[A] \in \mathbf{C}$ . This is extended to all types in  $Tp(N)$  by the obvious induction:

$$[A \multimap B] = [A] \multimap [B].$$

The interpretation extends to all derivable typing judgements (respectively, all **ILL** natural deduction proofs).

To each derivable typing judgement  $\sigma$  of the form

$$x_1 : A_1, \dots, x_n : A_n; A_m \vdash A$$

(respectively, to an **ILL** natural deduction proof of the corresponding sequent) we assign a **C**-morphism

$$[\sigma] : [A_1] \otimes \dots \otimes [A_n] \rightarrow [A],$$

if  $n > 0$ , or

$$[\sigma] : \mathbf{1} \rightarrow [A],$$

if  $n = 0$ , by induction on type inference rules.

If  $\sigma$  is  $x : A \vdash x : A$  is the (Id) axiom, then  $[\sigma] = \text{id}_{[A]}$ .

If  $\sigma$  is obtained from a derivable judgement  $\sigma'$  by the  $(\multimap I)$  rule, then  $[\sigma]$  is obtained from  $[\sigma']$  using symmetry and correspondence (5).

If  $\sigma$  is obtained from derivable judgements

$$\sigma_1 = \Gamma_1 \vdash t : A \multimap B, \quad \sigma_2 = \Gamma_2 \vdash s : A$$

by the  $(\multimap E)$  rule, then

$$[\sigma] = \text{ev}_{[A],[B]} \circ ([\sigma_1] \otimes [\sigma_2])$$

(see (11) for notation).

We now specialize the general construction concretely to the category of coidisms, which is monoidal closed.

Interpretation of rules is shown on the following picture (in the horizontal representation; square brackets are omitted).

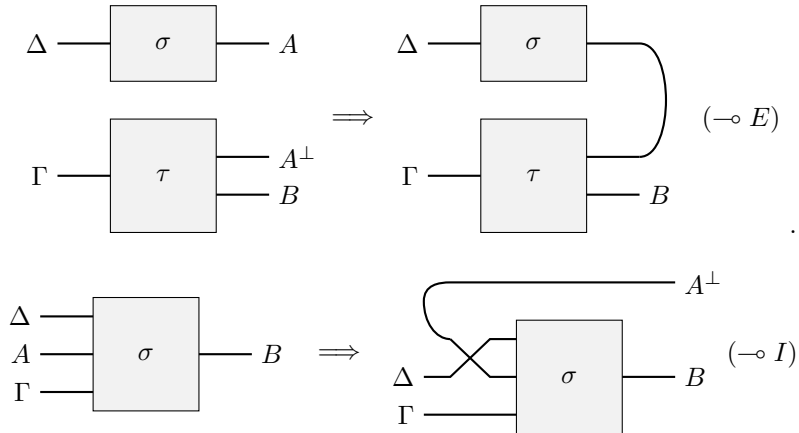

Now, assume that we are given a signature  $\Sigma = (N, C, \mathfrak{F})$ .

An interpretation of the signature  $\Sigma$  in a monoidal closed category  $\mathbf{C}$  consists of an interpretation of  $Tp(N)$  in  $\mathbf{C}$  together with a function assigning to each signature axiom (29) a morphism

$$[c] : \mathbf{1} \rightarrow [\mathfrak{T}(c)]. \quad (30)$$

The interpretation then extends to all typing judgements derivable in  $\Sigma$  by the same rules.

In accordance with notation in (30), we will denote the cwordism interpretation of a derivable typing judgement of the form  $\vdash t : F$  as  $[t] = [\vdash t : F]$ .

(The notation is slightly ambiguous, because the type  $F$ , in general, is not uniquely determined by the term  $t$ , but this will not lead to a confusion.)

It might be evident from the geometric representation that the interpretation is invariant, say, under  $\beta$ -reduction: an introduction rule ( $\multimap$  I) followed by an elimination ( $\multimap$  E) amounts to partial composition of cwordisms, i.e. to substitution. In any case we have the following.

**Lemma 5** ([7]). *Let  $\Sigma$  be a signature interpreted in a monoidal closed category  $\mathbf{C}$ .*

*If*

$$\Gamma \vdash t : A, \quad \Gamma \vdash s : A$$

*are typing judgements derivable in  $\Sigma$ , and the terms  $t, s$  are  $\beta\eta$ -equivalent, then the interpretations coincide,*

$$[\Gamma \vdash t : A] = [\Gamma \vdash s : A];$$

### 7.1.3 Sequent calculus formulation

The *sequent* formulation of linear  $\lambda$ -calculus is given by the following rules:

$$\begin{aligned} x : A \vdash x : A \text{ (Id)}, \quad & \frac{\Gamma \vdash t : A \quad x : A, \Delta \vdash s : B}{\Gamma, \Delta \vdash s[x := t] : B} \text{ (Cut)}, \\ & \frac{\Gamma, x : A, y : B, \Delta \vdash t : C}{\Gamma, y : B, x : A, \Delta \vdash C} \text{ (Ex)}, \\ & \frac{\Gamma \vdash x : A \quad y : B, \Delta \vdash s : C}{\Gamma, f : A \multimap B, \Delta \vdash s[y := (fx)]C} (\multimap \text{L}), \quad \frac{\Gamma, x : A \vdash t : B}{\Gamma \vdash \lambda x. t : A \multimap B} (\multimap \text{R}). \end{aligned}$$

The *sequent calculus* formulation of **ILL** is obtained from the above by erasing all terms in typing judgements.

The sequent calculus formulation of **ILL** is cut-free with algorithmic cut-elimination, similarly to ordinary (*classical*) **LL**.

It is well known that natural deduction and sequent calculus formulations are equivalent.

**Lemma 6** ([7]). *A typing judgement (respectively, an **ILL** sequent) is derivable in natural deduction iff it is derivable in sequent calculus.*

*Moreover, there exists a translation from natural deduction proofs to sequent calculus proofs and vice versa.  $\square$*

Any interpretation of linear types (**ILL** formulas) in a monoidal closed category gives rise to an interpretation of sequent calculus proofs as well.

Specifically, the Cut is interpreted as partial composition, the Exchange, as a symmetry transformation, while the (Id) axiom and the  $(\multimap R)$  rule are already present in the natural deduction.

For the sake of illustration let us compute the interpretation of the  $(\multimap L)$  rule. (We specialize to the case of cowordisms below, although the statement is true for any  $*$ -autonomous category). We will use the usual convention and not distinguish notationally a formula or a proof from its interpretation.

**Lemma 7.** *If  $\sigma$  and  $\tau$  are cowordisms representing proofs of sequents*

$$\Gamma \vdash A, \quad B, \Delta \vdash C$$

*respectively, then the proof of the sequent*

$$\Gamma, A \multimap B, \Delta \vdash C$$

*obtained from  $\sigma$  and  $\tau$  by the  $(\multimap L)$  rule is interpreted as the cowordism*

$$(\llcorner \sigma \lrcorner \tau) \circ \epsilon_{\Gamma, A^\perp, B, \Delta} \quad (31)$$

(see (14) for notation), shown in the following picture.

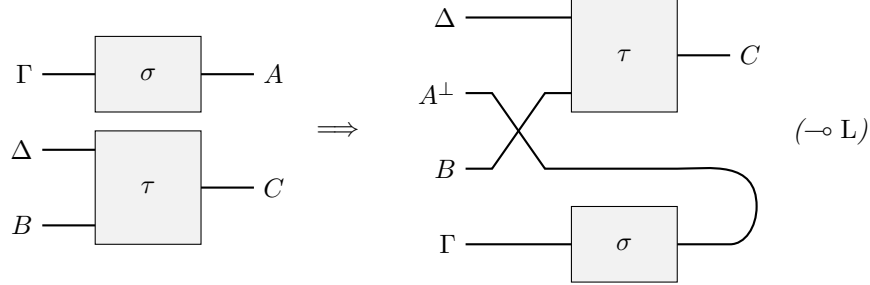

*Proof.* The  $(\multimap L)$  rule is emulated using Exchange, Cut and the natural deduction rule  $(\multimap E)$  by means of the following derivation:

$$\frac{\frac{\frac{A \multimap B \vdash A \multimap B \quad \frac{\sigma}{\Gamma \vdash A}}{A \multimap B, \Gamma \vdash B} (\multimap E)}{\Gamma, A \multimap B \vdash B} (\text{Ex}) \quad \frac{\tau}{B, \Delta \vdash C} (\text{Cut})}{\Gamma, A \multimap B, \Delta \vdash C.}$$

The interpretation of the above proof is computed in the following picture.

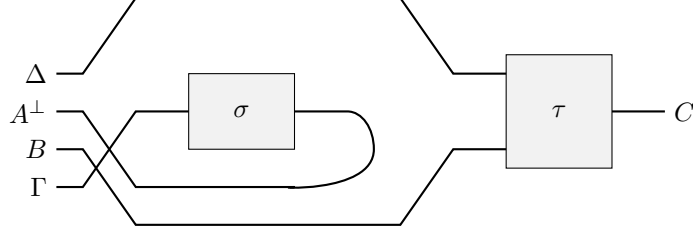

On the other hand, computing the cwordism in (31) directly from its expression we get the alternative picture.

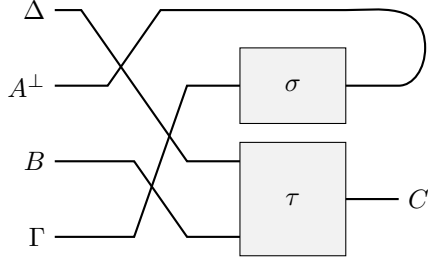

Both alternatives represent the same graph as depicted in the formulation of the lemma.  $\square$

Similarly to the case of classical **LL**, interpretations of **ILL** in monoidal closed categories, in particular, in categories of cwordisms are invariant under cut-elimination [7].

The following proposition, similar to Proposition 9, will be useful.

**Proposition 17.** *Let  $\Sigma$  be a linear signature and let an interpretation of  $\Sigma$  in the category of cwordisms be given.*

*A typing judgement  $\sigma$  of the form  $\Gamma \vdash t : A$  is derivable in  $\Sigma$  iff there exist signature axioms*

$$\vdash c_1 : \mathfrak{T}(c_1), \dots, \vdash c_n : \mathfrak{T}(c_n),$$

*a term  $t'$  and a typing judgement  $\sigma'$  of the form*

$$x_1 : \mathfrak{T}(c_1), \dots, \vdash x_n : \mathfrak{T}(c_n), \Gamma \vdash t' : A$$

*(where  $x_1, \dots, x_n$  do not occur in  $\sigma$ ) derivable in linear  $\lambda$ -calculus (not using axioms of  $\Sigma$ ) such that*

$$\sigma = \sigma' \circ (\sigma_1 \otimes \dots \otimes \sigma_n),$$

*where  $\sigma_i = [c_i]$ ,  $i = 1, \dots, n$ , (see (30) for notation).*

*Proof.* By induction on derivation.  $\square$

## 7.2 Embedding into LL

**ILL** can also be faithfully represented as a fragment of classical **LL**.

Given an alphabet  $N$  of literals, the set  $Fm_{\multimap}(N)$  of implicational formulas over  $N$  is mapped to the set  $Fm(N)$  of classical formulas over  $N$  by means of translation (15).

Next, an **ILL** sequent

$$A_1, \dots, A_n \vdash A$$

is mapped to the **LL** sequent

$$\vdash A_1^\perp, \dots, A_n^\perp, A.$$

**ILL** sequent proofs translate to **LL** proofs in a straightforward way, with the  $(\multimap R)$  rule corresponding to the  $(\wp)$  rule, the  $(\multimap L)$  rule corresponding to the  $(\otimes)$  rule, while Identity, Cut and Exchange of **ILL** translate to Identity, Cut and Exchange of **LL** respectively.

It is very easy to check that this embedding is *conservative* [39]: a sequent is cut-free derivable in **ILL** iff its translation is cut-free derivable in **LL**. Moreover, **ILL** proofs of an **ILL** sequent and **LL** proofs of its translation are in a one-to-one correspondence modulo some inessential permutations of rules. On the semantic side this is reflected in the following.

**Lemma 8.** *Let an alphabet  $N$  of literals and an interpretation of elements of  $N$  as boundaries be given.*

*Let  $A_1, \dots, A_n, A \in Fm_{\multimap}(N)$ .*

*There exists an **LL** proof  $\pi$  of the sequent*

$$\vdash A_1^\perp, \dots, A_n^\perp, A$$

*iff there is an **ILL** proof  $\pi'$  of the sequent*

$$A_1, \dots, A_n \vdash A$$

*such that the interpretation  $\sigma$  of  $\pi$  equals the name of the interpretation  $\sigma'$  of  $\pi'$ ,  $\sigma = \ulcorner \sigma' \urcorner$ .*

*Proof.* By induction on cut-free derivations using straightforward manipulations with pictures as in Lemma 7.  $\square$

### 7.2.1 Representing linear signatures

Thanks to the embedding of **ILL** to **LL**, we can represent linear signatures in **LL** as well.

Let  $\Sigma = (N, C, \mathfrak{A})$  be a linear signature and assume that an interpretation of  $\Sigma$  in the category of cwordisms over some alphabet  $T$  is given.

As previously, we consider atomic types of  $\Sigma$  as literals and this gives us an interpretation of **LL** as well.

We then translate  $\Sigma$  to an equivalent cwordism signature  $\Sigma'$  as follows.

We define the set  $\Xi$  of axioms as

$$\Xi = \left\{ \frac{[c]}{\vdash \mathfrak{F}(c)} \mid c \in C \right\}.$$

(See (30) for notation.) In other words, elements of  $\Xi$  are signature axioms of  $\Sigma$  taken together with their interpretations.

The cwordism signature  $\Sigma'$  is defined as  $\Sigma' = (N, T, \Xi)$ .

**Lemma 9.** *Let  $A_1, \dots, A_n, A \in Tp(N)$ , and*

$$\sigma : \mathbf{1} \rightarrow [A_1]^\perp \wp \dots \wp [A_n]^\perp \wp [A]$$

*be a cwordism over  $T$ .*

*The typing judgement*

$$\frac{\sigma}{\vdash A_1^\perp, \dots, A_n^\perp, A}$$

*is derivable in  $\Sigma'$  iff there is some term  $t$  such that*

$$x_1 : A_1, \dots, x_n : A_n \vdash_\Sigma t : A \tag{32}$$

*and  $\sigma$  is the name of the cwordism*

$$[x_1 : A_1, \dots, x_n : A_n \vdash t : A] : [A_1] \otimes \dots \otimes [A_n] \rightarrow [A]$$

*corresponding to (32).*

*Proof.* Proposition 17, Lemma 8 and Proposition 9. □

We say that the cwordism signature  $\Sigma'$  is the *cwordism representation* of the linear signature  $\Sigma$  induced by the given interpretation of types.

### 7.3 Abstract categorial grammars

Given two linear signatures  $\Sigma_i = (N_i, C_i, \mathfrak{F}_i)$ ,  $i = 1, 2$ , a *map of signatures*

$$\phi : \Sigma_1 \rightarrow \Sigma_2$$

is a pair  $\phi = (F, G)$ , where

- $F : Tp(\Sigma_1) \rightarrow Tp(\Sigma_2)$  is a function satisfying the homomorphism property

$$F(A \multimap B) = F(A) \multimap F(B),$$

- $G : C_1 \rightarrow \Lambda(X, C_2)$  is a function such that for any  $c \in C_1$  it holds that  $\vdash_{\Sigma_2} G(c) : F(\mathfrak{F}(c))$ .

The map  $G$  above extends inductively to a map

$$G : \Lambda(X, C_1) \rightarrow \Lambda(X, C_1)$$

by

$$\begin{aligned} G(x) &= x, \quad x \in X, \\ G(ts) &= (G(t)G(s)), \quad G(\lambda x.t) = (\lambda x.G(t)). \end{aligned}$$

For economy of notation, we write  $\phi(A)$  for  $F(A)$  when  $A \in Tp(C_1)$ , and we write  $\phi(t)$  for  $G(t)$  when  $t \in \Lambda(X, C_1)$ .

**Definition 18.** An *abstract categorial grammar (ACG)*  $G$  is a tuple  $G = (\Sigma_{abstr}, \Sigma_{obj}, \phi, S)$ , where

- $\Sigma_{abstr}, \Sigma_{obj}$ , are linear signatures, respectively, the *abstract* and the *object* signature;
- $\phi : \Sigma_{abstr} \rightarrow \Sigma_{obj}$ , the *lexicon*, is a map of signatures;
- $S$ , the *standard type*, is an atomic type of  $\Sigma_{abstr}$ .

The *abstract* and the, *object* language, respectively,  $L_{abstr}(G)$  and  $L_{obj}(G)$  generated by  $G$  are defined as the sets of terms for which

$$\vdash_{\Sigma_{abstr}} t : S, \text{ respectively, } \vdash_{\Sigma_{obj}} t : \phi(S).$$

In the context of formal languages, the object language generated by an ACG should be understood as a representation of syntax.

## 7.4 Representing as LLG

Let  $G = (\Sigma_{abstr}, \Sigma_{obj}, \phi, S)$  be an ACG, and assume that an interpretation of the object signature  $\Sigma_{obj}$  in the category of cwordisms is given.

This gives us immediately an interpretation of the abstract signature as well.

Indeed, types and signature axioms of  $\Sigma_{abstr}$ , are mapped by the lexicon  $\phi$  to types and derivable typing judgements of  $\Sigma_{obj}$ , and these are mapped to boundaries and cwordisms by the given interpretation. Composing the two we get the desired interpretation of  $\Sigma_{abstr}$ .

Thus, to any type  $A \in Tp(\Sigma_{abstr})$  we assign the boundary

$$[A] = [\phi(A)],$$

and to any signature axiom  $\vdash c : \mathfrak{T}(c)$  of  $\Sigma_{abstr}$  we assign the cwordism

$$[c] = [\phi(c)] : \mathbf{1} \rightarrow [\phi(\mathfrak{T}(c))] = [\mathfrak{T}(c)].$$

**Proposition 18.** *Let  $\sigma$  be a typing judgement*

$$x_1 : A_1, \dots, x_n : A_n \vdash t : A$$



derivable in  $\Sigma_{abstr}$ . Then the interpretation  $[\sigma]$  of  $\sigma$  coincides with the interpretation of the typing judgement

$$x_1 : \phi(A_1), \dots, x_n : \phi(A_n) \vdash \phi(t) : \phi(A)$$

(which is derivable in  $\Sigma_{obj}$ ).

*Proof.* By induction on derivation. □

It follows that we have a cowordism signature  $\Sigma'$  representing the abstract signature  $\Sigma_{abstr}$  as described in Section 7.2.1.

We define the LLG  $G'$  representing  $G$  by  $G' = (\Sigma', S)$ .

Lemma 9 and Proposition 18 immediately imply that the LLG  $G'$  is a translation of the ACG  $G$ .

**Lemma 10.** *In notation as above, let  $A_1, \dots, A_n, A \in Tp(\Sigma_{abstr})$ .*

*A typing judgement*

$$\frac{\sigma}{\vdash A_1^\perp, \dots, A_n^\perp, A}$$

*for some cowordism  $\sigma$  is derivable in  $G'$  iff there exists a term  $t$  such that the typing judgement*

$$x : A_1, \dots, A_n \vdash t : A$$

*is derivable in the abstract signature  $\Sigma_{abstr}$ .*

*Furthermore, if all cowordisms of type  $S$  generated by  $G'$  are regular, then there are translations*

$$L_{abstr}(G) \rightarrow L(G), \quad L_{obj}(G) \rightarrow L(G)$$

*of both the abstract and the object language of  $G$  to the language of  $G'$ , sending a term  $t \in L_{abstr}(G)$  (respectively,  $t \in L_{obj}(G)$ ) to the interpretation  $[t]$  of the corresponding typing judgement  $\vdash t : S$  (respectively,  $\vdash t : \phi(S)$ ). □*

Whether the translation of grammars is *faithful* and the generated languages are *isomorphic* depends, of course, on the chosen interpretation of the object signature in the cowordism category. (In general, the interpretation can be *degenerate*, i.e. not injective, or it can map the object language to singular cowordisms.)

We now discuss the cases of *string* and *tree* ACG, relevant for analysis of syntax generation, where the translation is indeed a transparent isomorphism.

## 8 Encoding string and tree ACG

### 8.1 Encoding string ACG

#### 8.1.1 String signature

Let  $T$  be a finite alphabet.

The *string signature*  $Str_T$  over  $T$  is the linear signature with a single atomic type  $O$ , the alphabet  $T$  as the set of constants and the typing assignment

$$\mathfrak{T}(c) = O \multimap O \quad \forall c \in T.$$

We denote the type  $O \multimap O$  as *str*.

If  $t$  is a closed (i.e. not having free variables) term such that  $\vdash_{Str_T} t : str$ , we say that  $t$  is a *string term*.

Any word  $a_1 \dots a_n$  in the alphabet  $T$  can be represented as the string term

$$\rho(a_1 \dots a_n) = (\lambda x. a_1(\dots(a_n(x))\dots)). \quad (33)$$

It is not hard to see that, if we identify  $\beta\eta$ -equivalent terms, the map  $\rho$  has an inverse.

**Lemma 11.** *Any string term  $t$  is  $\beta\eta$ -equivalent to the term  $\rho(w)$  for some  $w \in T^*$ .*

*Proof.* (i) There is no  $\lambda$ -term  $t$  such that  $\vdash_{Str_T} t : O$  (for example, because any derivable typing judgement has an even number of  $O$  occurrences).

(ii) Using (i), we prove by induction on type inference that if  $t$  is a  $\beta$ -normal term such that  $\vdash_{Str_T} t : F$  for some type  $F$ , then  $t$  is either a constant  $t \in T$ , or an abstraction,  $t = (\lambda x. t')$  for some variable  $x$  and term  $t'$ .

(iii) Using (ii), we prove by induction on type inference that for any derivable typing judgement  $x : O \vdash_{Str_T} t : O$ , where  $t$  is a  $\beta$ -normal term, it holds that  $t = c_1(\dots(c_n(x))\dots)$  for some constants  $c_1, \dots, c_n \in T$ .

Now without loss of generality we can assume that  $t$  in the hypothesis of the lemma is  $\beta$ -normal.

If  $t$  is a constant then  $t$  is  $\beta\eta$ -equivalent to  $\rho(t)$ . Otherwise claim (ii) implies that the last rule in the derivation of the typing judgement  $t : O \multimap O$  is  $(\multimap E)$ . Then the statement of the lemma follows from (iii).  $\square$

In the setting of Lemma 11, we say that the word  $w$  is *represented* by the string term  $t$ .

### 8.1.2 Cowordism representation of the string signature

Let us interpret the atomic type  $O$  as the one-point boundary

$$[O] = [O]_l = \{l\}.$$

By induction this gives us an interpretation of all types in  $Tp(Str_T)$  as boundaries.

We note that any regular cowordism  $\sigma : O \rightarrow O$  is a graph consisting of a single edge labeled with some word  $w \in T^*$ . We denote such a cowordism as  $[w]$  and call it the *cowordism representation* of  $w$ .

We interpret each signature axiom  $\vdash c : O \multimap O$ , where  $c \in T$ , as the corresponding regular cwordism  $[c] : \mathbf{1} \rightarrow [O] \multimap [O]$ .

This gives us an interpretation of the signature  $Str_T$  in the category of cwordisms over  $T$ .

We call this interpretation the *cwordism representation of the string signature*.

Lemma 11 easily leads us to the following.

**Proposition 19.** *For any string term  $t$ , the cwordism representation  $[t]$  of the corresponding typing judgement  $\vdash t : str$  coincides with the cwordism representation  $[w]$  of the word  $w \in T^*$  represented by  $t$ ,  $[t] = [w]$ .*

*Proof.* By Lemma 5, the cwordism representation does not distinguish  $\beta\eta$ -equivalent terms, hence, by Lemma 11, we can identify  $t$  with  $\rho(w)$ .

Induction on the length of  $w$ .

For the empty word the statement is clear.

Otherwise  $w = w'c$ , where  $w' \in T^*$ ,  $c \in T$ .

Then the term  $t = \rho(w)$  is  $\beta\eta$ -equivalent to  $t' = \lambda x.(\rho(w)c)$ , and the typing judgement  $\vdash_{Str_T} t' : str$  is derived as follows

$$\frac{\frac{\vdash \rho(w') : O \multimap O \quad \frac{\vdash c : O \multimap O \quad x : O \vdash x : O}{x : O \vdash cx : O} (\multimap E)}{x : O \vdash (\rho(w'))(cx) : c : O} (\multimap E)}{\vdash t' : O \multimap O} (\multimap I).$$

Applying the induction hypothesis to  $\rho(w')$  we immediately compute the interpretation of  $\vdash t : str$  as  $[w]$ . Computation is shown in the picture below (with two elimination rules done at one step).

$$\begin{array}{c} O \longleftarrow O \\ \begin{array}{c} \xrightarrow{c} O^\perp \\ \xrightarrow{w'} O^\perp \end{array} \end{array} \Rightarrow \begin{array}{c} O \longleftarrow \\ \begin{array}{c} \xrightarrow{c} \\ \xrightarrow{w'} \end{array} \end{array} = O \xleftarrow{w'c} O \Rightarrow \begin{array}{c} \xrightarrow{w'c} O^\perp \\ \xrightarrow{\quad} O \end{array}$$

Since cwordism representation does not distinguish  $\beta\eta$ -equivalent terms, the statement is proven.  $\square$

## 8.2 Encoding string ACG

A *string ACG*  $G$  is an ACG whose object signature is the string signature over some alphabet  $T$ ,  $G = (\Sigma, Str_T, \phi, S)$ .

The *string language*  $L(G)$  generated by a string ACG  $G$  is the set of words

$$L(G) = \{w \in T^* \mid \rho(w) \in L_{obj}(G)\}.$$

Now let a string ACG  $G$  be given.

We have an LLG  $G'$  representing the ACG  $G$  as described in Section 7.4.

It follows from Lemma 19 that all cowordisms of type  $str$  generated by  $G'$  are regular. Hence by Lemma 10 we have a translation of  $L_{abstr}$  and  $L_{obj}(G)$  to  $L(G)$ . Lemma 19 guarantees that this translation is one-to-one on the level of strings, i.e. the string language  $L(G)$  generated by  $G$  coincides with the language  $L(G')$  generated by  $G'$ .

We summarise.

**Theorem 2.** *If a language is generated by a string ACG then it is also generated by an LLG.  $\square$*

It seems an interesting question whether the converse is true or not. We would expect that the two types of grammars generate the same class of languages.

**Remark.** Since MCFG embed into string ACG [13], Theorem 2 on encoding ACG in LLG grammars implies that MCFG embed into LLG. However it does not imply the converse statement (Theorem 1, that any  $\otimes$ -free lexicon gives rise to an MCFG).

On the other hand it is not hard to see that Theorem 1 together with Theorem 2 do imply the known result [35] that any second order string ACG generates a multiple context-free language. Thus we gave another, possibly more “geometric” proof of this result.

### 8.3 Tree ACG

Linguists often represent natural language in terms of *labeled trees* rather than just strings and consider formal *tree languages* and corresponding formal grammars, such as *tree adjoining grammars* [18]. We now discuss how to represent tree languages and tree ACG in the setting of cowordisms.

#### 8.3.1 Tree language

In what follows, a tree means a *rooted planar tree*.

We assume that we are given an alphabet  $N$  of *node labels*, and we will consider *labeled trees* whose nodes are labeled with elements of  $N$ . We denote the set of all such trees as  $Tr(N)$ .

**Remark.** The alphabet of node labels is often subdivided further into alphabets of terminal and nonterminal symbols, but this is a purely cosmetic detail, and constructions that we discuss below can be easily adapted to this setting.

It is convenient to introduce “elementary building blocks” for constructing elements of  $Tr(N)$ .

Let us say that an *elementary tree*  $A_k$ , where  $A \in N$ , is a planar rooted tree consisting of the root labeled with  $A$  and its  $k$  children, which are unlabeled.

Each elementary tree  $A_k$  can be identified with a  $k$ -ary functional symbol. Then trees over  $N$  can be identified with terms constructed from these functional symbols.

Namely, the tree with a single vertex labeled with  $A \in N$  corresponds to the constant  $A_0$ , and the tree  $\alpha \in N$  obtained by attaching trees  $\alpha_1, \dots, \alpha_k$  to a root labeled with  $A \in N$  corresponds to the term  $A_k(\alpha_1, \dots, \alpha_k)$ .

Now, given a tree  $\alpha$ , we say that the *branching* of a node  $v$  of  $\alpha$  is the number of children of  $v$ . The *branching* of  $\alpha$  is the maximal branching of its nodes.

We denote the set of all labeled trees over  $N$  with branching less or equal to  $n$  as  $Tr(N, n)$ .

A *tree language* over alphabet  $N$  is a set of planar rooted trees whose nodes are labeled with elements of  $N$ .

We say that a tree language  $L$  has *bounded branching* if there is  $n$  such that the branching of all trees in  $L$  have branching less or equal to  $n$ ,  $L \subseteq Tr(N, n)$ . In this case we say that  $n$  is the *maximal branching* of  $L$ , if all trees in  $L$  have branching less or equal to  $n$  and there is  $\alpha \in L$  whose branching is  $n$ .

### 8.3.2 Encoding tree languages

The set  $Tr(N)$  of labeled trees can be conveniently encoded into words over a certain alphabet. If, furthermore, we restrict to the set  $Tr(N, n)$  of trees with bounded branching, then the alphabet for the encoding is finite.

Given an alphabet  $N$  of node labels and a maximal branching  $n$ , let us put

$$T(N, n) = \{A_i^k \mid A \in N, 0 \leq i \leq k, 0 \leq k \leq n\}.$$

We encode each element  $\alpha \in Tr(N, n)$  as a word  $[\alpha] \in (T(N, n))^*$  inductively as follows (identifying labeled trees with functional terms):

$$[A_0] = A_0^0, \quad [A_k(\alpha_1, \dots, \alpha_k)] = A_k^0[\alpha_1]A_k^1[\alpha_2] \dots A_k^{k-1}[\alpha_k]A_k^k.$$

Given a tree language  $L$  over  $N$  with branching  $n$ , we denote as  $[L]$  the image of  $L$  in  $(T(N, n))^*$  under the above encoding. Note that the encoding map from  $L$  to  $[L]$  is a bijection.

Apart from representing “finished” trees we also need to represent trees “under construction” and operations on them. For that purpose we will encode elementary trees as cowordisms over  $T(N, n)$ .

We introduce the boundary

$$\mathcal{T} = \{l, r\}, \quad \mathcal{T}_l = \{l\} \tag{34}$$

and map each elementary tree  $A_k$  to the *elementary tree cowordism*

$$[A_k] : \underbrace{\mathcal{T} \otimes \dots \otimes \mathcal{T}}_{k \text{ times}} \rightarrow \mathcal{T}$$

over  $T(N, n)$ , whose edges are labeled with the words  $A_k^0, \dots, A_k^k$ , defined by

the following picture (in the vertical representation).

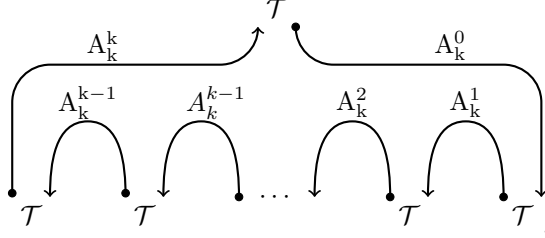

The case  $k = 0$  corresponds to the tree  $A_0$  with a single vertex labeled with  $A$ , and the cowordism

$$[A_0] : \mathbf{1} \rightarrow \mathcal{T}$$

consists of a single edge labeled with  $A_0^0$ .

For a “finished tree”  $\alpha \in Tr(N, n)$  we identify its encoding word  $[\alpha] \in (T(N, n))^*$  with the corresponding regular cowordism from  $\mathbf{1}$  to  $\mathcal{T}$  whose only edge is labeled with  $[\alpha]$ .

It is easy to see then that this encoding is a sound representation of elementary trees considered as functional symbols, i.e.

$$[A_k(\alpha_1, \dots, \alpha_k)] = [A_k] \circ ([\alpha_1] \otimes \dots \otimes [\alpha_k]).$$

## 8.4 Tree signature

(Tree signatures and tree ACG were defined in [6] without special names.)

Labeled trees with bounded branching, being, essentially, functional terms, can be represented as linear  $\lambda$ -terms in the obvious way.

Let an alphabet  $N$  and a maximal branching  $n$  be given.

The *tree signature*  $Tree_{N, n}$  has unique atomic type  $\mathcal{T}$  (notational clash with (34) is intentional), the set of constants  $C = \{A_k \mid A \in N, k \leq n\}$  (another intentional abuse of notation!) and signature axioms

$$\vdash A_k : \underbrace{\mathcal{T} \multimap \dots \multimap \mathcal{T}}_{k \text{ times}} \multimap \mathcal{T}, \quad (35)$$

where  $A \in N$ ,  $k \leq n$ .

If  $t$  is a closed (i.e. not having free variables) term such that  $\vdash_{Tree_{N, n}} t : \tau$ , we say that  $t$  is a *tree term*.

A labeled tree  $\alpha \in Tr(N, n)$  is represented as a tree term  $\rho(\alpha)$  defined by induction:

$$\rho(A_0) = A_0 \quad \rho(A_k(\alpha_1, \dots, \alpha_k)) = A_k \rho(\alpha_1) \dots \rho(\alpha_k),$$

where notational convention (28) is used.

It is not hard to show that any tree term represents an element of  $Tr(N, n)$  up to a  $\beta\eta$ -equivalence.

Let us introduce some terminology.

We define *open tree types* by the following induction:

- $\mathcal{T}$  is the open tree type with 0 *hanging vertices*;
- if  $F$  is the open tree type with  $m$  hanging vertices, then  $\mathcal{T} \multimap F$  is the open tree type with  $m + 1$  *hanging vertices*.

And *open tree terms* are defined by the following:

- any  $\beta$ -normal term built from constants and variables using only application is an open tree term with 0 *bound leaves*;
- a term  $\lambda x.t$ , where  $t$  is an open tree term with  $k$  bound leaves, is an open tree term with  $k + 1$  *bound leaves*.

**Lemma 12.** *Any tree term  $t$ , is  $\beta\eta$ -equivalent to the term  $\rho(\alpha)$  for some  $\alpha \in Tr(N, n)$ .*

*Proof.* Without loss of generality, the term  $t$  is  $\beta$ -normal.

Then the statement follows from the following more general statement, which is proven by induction on derivation.

Assume that

$$x_1 : \mathcal{T}, \dots, x_n : \mathcal{T} \vdash_{Tree_{N,n}} t : F,$$

where  $t$  is  $\beta$ -normal.

- (i) If  $F$  is an open tree type with  $m$  hanging vertices, then there exists  $k \leq m$  such that  $t$  is an open tree term with  $k$  bound leaves.
- (ii) If  $t$  is not of the form  $t = \lambda y.t'$ , then  $F$  is an open tree type and  $t$  is an open tree term with no bound vertices.

□

In the setting of Lemma 20 we say that  $\alpha$  is the tree *represented* by the term  $t$ .

#### 8.4.1 Cowordism representation of the tree signature

An interpretation of the tree signature, essentially, has already been constructed in Section 8.3.2.

Let us interpret the atomic type  $\mathcal{T}$  as the corresponding boundary  $\mathcal{T}$  defined in (34).

By induction this gives us an interpretation of all types in  $Tp(\mathcal{T})$  as boundaries.

We interpret each signature axiom of form (35) as the elementary tree cowordism  $[A_i]$ .

This gives us an interpretation of the signature  $Tree_{N,n}$  in the category of cowordisms over  $T(N, n)$ .

We call this interpretation the *cowordism representation* of tree signature.

We have the following proposition, identical in form to Proposition 19

**Proposition 20.** *For any tree term  $t$ , the cwordism representation  $[t]$  of the corresponding typing judgement  $\vdash_{Tree_{N,n}} t : \mathcal{T}$  coincides with the cwordism representation  $[\alpha]$  of the tree  $\alpha \in Tr(N, n)$  represented by  $t$ ,  $[t] = [\alpha]$ .*

*Proof.* Similar to Proposition 19.

Without loss of generality, the term  $t$  can be assumed  $\beta$ -normal, then, by Lemma 12,  $t$  is  $\beta\eta$ -equivalent to  $\rho(\alpha)$  for some  $\alpha \in Tr(N, n)$ , we use induction on  $\alpha$ .  $\square$

## 8.5 Encoding tree ACG

Tree abstract categorial grammars (tree ACG) are defined similarly to string ACG.

A tree ACG  $G$  is an ACG whose object signature is the tree signature over some alphabet  $N$  of node labels with maximal branching  $n$ ,

$$G = (\Sigma, Tree_{N,n}, \phi, S).$$

The tree language  $L(G)$  generated by a tree ACG  $G$  is the set of trees

$$L(G) = \{\alpha \in Tr(N, n) \mid \rho(w) \in L_{obj}(G)\}.$$

Tree ACG are encoded in LLG in the same way as string ACG.

Let a tree ACG  $G$  be given.

The cwordism representation of the tree signature is an interpretation of the object signature in the category of cwordisms. Hence we have an LLG  $G'$  representing the ACG  $G$  as described in Section 7.4.

Lemma 10 and Lemma 20 immediately imply that the encoding  $[L(G)]$  of the tree language  $L(G)$  generated by  $G$  coincides with the language  $L(G')$  generated by  $G'$ .

We summarise.

**Theorem 3.** *If a tree language  $L$  is generated by a tree ACG then its encoding  $[L]$  is generated by an LLG.  $\square$*

## 9 Encoding backpack problem

It is known that ACG, in general, can generate NP-complete languages [42] (and for unlexicalized ACG, even decidability is an open question).

It seems natural to expect that LLG can generate NP-complete languages as well. In this last section we show how an LLG can generate solutions of the backpack problem. Our purpose here is mainly illustrative. We try to convince the reader that the geometric language of cwordisms is indeed intuitive and convenient for analysing language generation.

We consider backpack problem in the form of the *subset sum problem*.

**Definition 19. Subset sum problem (SSP):** Given a finite sequence  $s$  of integers, determine if there is a subsequence  $s' \subseteq s$  such that  $\sum_{z \in s'} z = 0$ .



SSP is known to be NP-complete, see [25].

We now define a language representing solutions of SSP.

We represent integers as words in the alphabet  $\{+, -\}$ , we call them *numerals*. An integer  $z$  is represented (non-uniquely) as a word for which the difference of  $+$  and  $-$  occurrences equals  $z$ .

We say that a numeral is *irreducible*, if it consists only of pluses or only of minuses.

We represent finite sequences of integers as words in the alphabet  $T = \{+, -, \bullet\}$ , with  $\bullet$  interpreted as a separation sign. Thus a word in this alphabet should be read as a list of numerals separated by bullets.

When all numerals in the list are irreducible, we say that the list is irreducible. Note that any sequence of integers has unique representation as an irreducible list.

We now construct a system of cowordisms over  $T$  which (together with symmetry transformations) generates solutions of SSP.

We will use four atomic boundaries  $E, P, H, S$ , each of them having one point in the left boundary and one point in the right boundary.

First we construct a system which generates lists of numerals representing sequences that sum to zero.

We define four cowordisms

$$cons : S \otimes S \rightarrow S, \quad open : H \rightarrow S$$

$$push : H \otimes H \rightarrow H \otimes H, \quad close : \mathbf{1} \rightarrow H$$

in the graphical language as follows.

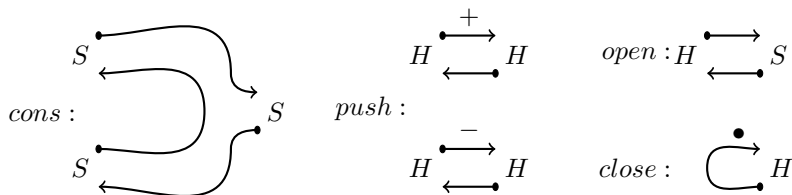

The cowordism *cons*, by iterated compositions with itself, generates lists with arbitrary many empty slots. Then the cowordism *open* converts them into slots that can be filled with pluses and minuses. Then *push* fill the slots (always in pairs), and *close* closes them.

It is easy to see that all cowordisms from  $\mathbf{1}$  to  $S$  generated by the above system (together with symmetry transformations) represent sequences of integers summing to zero, and vice versa, for any sequence summing to zero, its irreducible list representation is generated by the above.

Now, in order to generate solutions of SSP we need some extra “deceptive” slots, which contain elements not summing to zero. These slots will be represented by the boundary  $P$ .

We define cwordisms

$$\begin{aligned} open_P : P \otimes S \rightarrow S, \quad close_P : \mathbf{1} \rightarrow P, \\ push_+ : P \rightarrow P, \quad push_- : P \rightarrow P \end{aligned}$$

as follows.

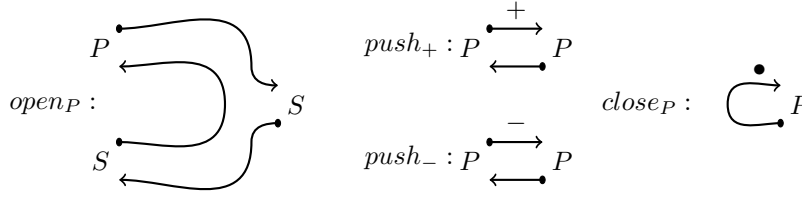

The cwordism  $open_P$  adds deceptive slots to the list,  $push_-$  and  $push_+$  fill them with arbitrary numerals, and  $close_P$  closes them.

Let us denote the set of cwordisms from  $\mathbf{1}$  to  $S$  generated by the above system and symmetry as  $L_0$ .

It is easy to see that  $L_0$  membership problem is, essentially, SSP. In particular, a sequence  $s$  of integers is a solution of SSP iff the corresponding irreducible list is in  $L_0$ . It follows that  $L_0$  is NP-hard.

It is also easy to show that  $L_0$  membership problem is itself in NP, hence  $L_0$  is, in fact, NP-complete.

Let us define an LLG  $G$  by a lexicon consisting of names of the above cwordisms.

It is easy to see that  $G$  generates  $L_0$ . This can be established by reasoning similar to that in Lemma 9. We omit a proof because of space limitation.

(This example shows also that the generative power of LLG is strictly greater than MCFG, because multiple context-free languages are effectively decidable.)

## References

- [1] S. Abramsky, “Abstract scalars, loops, free traced and strongly compact closed categories”, Proceedings of CALCO 2005, Springer Lecture Notes in Computer Science, 3629, pp. 1-31, 2005.
- [2] S. Abramsky, B. Coecke. “Categorical quantum mechanics”, in Handbook of quantum logic and quantum structures: quantum logic, pp. 261-324, 2008.
- [3] J. C. Baez and J. Dolan, “Higher-dimensional Algebra and Topological Quantum Field Theory”, J.Math.Phys. 36, pp. 6073-6105, 1995.

- [4] H.P. Barendregt, “The Lambda Calculus Its Syntax and Semantics”. Studies in Logic and the Foundations of Mathematics. 103. Amsterdam: North-Holland, 1985.
- [5] M. Barr. “\*-Autonomous Categories”, Lecture Notes in Mathematics 752, Springer, 1979.
- [6] Ph. de Groote, “Tree-Adjoining Grammars as Abstract Categorical Grammars”, In: TAG+6, Proceedings of the sixth International Workshop on Tree Adjoining Grammars and Related Frameworks, pp. 145-150, 2001.
- [7] N. Benton, G. Bierman, J. Hyland, V. de Paiva, ”Term assignment for Intuitionistic Linear Logic”, Report 262, Computer Laboratory, University of Cambridge, 1992.
- [8] R. Cockett, R. Seely, “Weakly Distributive Categories”, Journal of Pure and Applied Algebra, 114(2), pp 133-173, 1997.
- [9] B. Coecke, M. Sadrzadeh, S. Clark, “Mathematical Foundations for a Compositional Distributional Model of Meaning”. Lambek Festschrift, special issue of Linguistic Analysis, 2010.
- [10] B. Coecke, M. Sadrzadeh, M. Sadrzadeh, “Lambek vs. Lambek: Functorial Vector Space Semantics and String Diagrams for Lambek Calculus”, Annals of Pure and Applied Logic, 164(11), 1079-1100, 2013.
- [11] M. Dalrymple., J. Lamping, F. Pereira, F., V. Saraswat, Linear logic for meaning assembly, in Proceedings of CLNLP, Edinburgh, South Queensferry: ELSNET, 1995.
- [12] P. de Groote, Towards Abstract Categorical Grammars, in , Proceedings of the 39th Annual Meeting on Association for Computational Linguistics, ACL '01, pp.148-155, 2001.
- [13] P. de Groote, S. Pogodalla, On the expressive power of abstract categorical grammars: Representing context-free formalisms. Journal of Logic, Language and Information 13(4):421-438, 2004.
- [14] Jean-Yves Girard, “Linear logic”, Theoretical Computer Science, 50:1-102, 1987.
- [15] Jean-Yves Girard, “Linear logic: its syntax and semantics”, in J.-Y.Girard, Y.Lafont and L.Regnier, eds. Advances in Linear Logic, 1-42, Cambridge University Press, 1995, Proc. of the Workshop on Linear Logic, Ithaca, New York, June, 1993.
- [16] J.-Y. Girard, P. Taylor, and Y. Lafont, “Proofs and Types”, Cambridge University Press, New York, NY, USA, 1989.
- [17] M. Hyland and A. Schalk, “Glueing and Orthogonality for Models of Linear Logic”, Theoretical Computer Science 294, pp. 183–231, 2003.

- [18] A.K. Joshi, L.S. Levy, M. Takahashi, “Tree adjunct grammars”, *Journal of Computer Systems Science*, 10 (1), pp. 136-163, 1975.
- [19] M. Kanazawa, “The Pumping Lemma for Well-Nested Multiple Context-Free Languages”, in *Developments in Language Theory, 13th International Conference, DLT 2009, Stuttgart, Germany, June 30 - July 3, 2009. Proceedings, Lecture Notes in Computer Science 5583*, pp. 312-325, 2009.
- [20] G.M. Kelly, M.L. Laplaza, “Coherence for compact closed categories”. *Journal of Pure and Applied Algebra*. 19: 193-213, 1980.
- [21] Y. Kubota, R. Levine, “Gapping as like-category coordination”, in D. Béchet & A. Dikovsky, eds, ‘Logical Aspects of Computational Linguistics’, Vol. 7351 of *Lecture Notes in Computer Science*, Springer, Nantes, pp. 135-150, 2012.
- [22] J. Lambek, Joachim, ”The mathematics of sentence structure”, *Amer. Math. Monthly*, 65: 154-170, 1958.
- [23] J. Lambek. “Type grammar revisited”, *Logical Aspects of Computational Linguistics*, 1582, 1999.
- [24] S. Mac Lane, “Categories for the working mathematician”, Springer-Verlag, 1971.
- [25] S. Martello, P. Toth, “4 Subset-sum problem”. *Knapsack problems: Algorithms and computer interpretations*, Wiley-Interscience. pp. 105-136, 1990.
- [26] P.-A. Melliés, “Categorical semantics of linear logic”, in: *Interactive Models of Computation and Program Behaviour, Panoramas et Synthèses 27*, Société Mathématique de France 1-196, 2009.
- [27] V. Mihaliček, C. Pollard, “Distinguishing phenogrammar from tectogrammar simplifies the analysis of interrogatives.” In *Proceedings of the 15th and 16th International Conference on Formal Grammar (FG’10/FG’11)*, 130-145. Springer 2012.
- [28] M. Moortgat, “Categorial type logics”, in Johan van Benthem and Alice ter Meulen, eds., *Handbook of Logic and Language*, chapter 2, pp. 93-178, Elsevier, MIT Press, 1997.
- [29] R. Moot, “Comparing and evaluating extended Lambek calculi” . In Kubota, Y. and Levine, R., editors, *Proceedings for ESSLLI 2015 Workshop Empirical Advances in Categorial Grammar*, University of Tsukuba and Ohio State, pp. 108-131, 2015.
- [30] R. Moot, “Hybrid type-logical grammars, 1rst-order linear logic and the descriptive inadequacy of lambda grammars”, <https://hal.archives-ouvertes.fr/hal-00996724>, 2014.

- [31] R. Moot, C. Retoré, "The Logic of Categorical Grammars: A Deductive Account of Natural Language Syntax and Semantics", Lecture Notes in Artificial Intelligence, Springer, 2012.
- [32] G. Morrill, O. Valentín, M. Fadda, "The displacement calculus", *Journal of Logic, Language and Information* 20(1), 1-48, 2011.
- [33] R. Muskens, "Separating syntax and combinatorics in categorial grammar", *Research on Language and Computation* 5(3), 267-285, 2007.
- [34] M. Pentus, "Lambek Grammars Are Context Free", in *Proceedings of the Eighth Annual Symposium on Logic in Computer Science (LICS '93)*, Montreal, Canada, June 19-23, 1993, pp. 429-433, 1993.
- [35] S. Salvati, "Encoding second order string ACG with deterministic tree walking transducers". In S. Wintner, ed., *Proceedings of FG 2006: The 11th conference on Formal Grammar*, FG Online Proceedings, pages 143-156. CSLI Publications, 2017.
- [36] R.A.G. Seely, "Linear logic, \*-autonomous categories and cofree coalgebras", in: J.Gray and A.Scudrov (editors), *Categories in Computer Science and Logic*, Contemporary Mathematics 92, 371-382, Amer. Math. Soc., 1989.
- [37] H. Seki, T. Matsumura, M. Fujii, and T. Kasami, "On multiple context-free grammars", *Theoretical Computer Science* 88(2):191-229, 1991.
- [38] P. Selinger, "A survey of graphical languages for monoidal categories", in: B. Coecke (ed.), *New Structures for Physics*, 275-337, Springer-Verlag, 2011.
- [39] H. Schellinx, "Some Syntactical Observations on Linear Logic", *Journal of Logic and Computation* 1, 4, 537-559, 1991.
- [40] A.M. Tan, "Full completeness for Models of Linear Logic", PhD. Thesis, Cambridge, 1997.
- [41] A. S. Troelstra and H. Schwichtenberg, "Basic Proof Theory", Cambridge University Press, New York, NY, USA, 1996.
- [42] R. Yoshinaka, M. Kanazawa, "The Complexity and Generative Capacity of Lexicalized Abstract Categorical Grammars". In: Blache P., Stabler E., Busquets J., Moot R. (eds) *Logical Aspects of Computational Linguistics*. LACL. Lecture Notes in Computer Science, vol 3492. Springer, Berlin, Heidelberg, 2005.