

STRUCTURED COSPANS

John C. Baez

Department of Mathematics
University of California
Riverside CA, USA 92521
and
Centre for Quantum Technologies
National University of Singapore
Singapore 117543

Kenny Courser

Department of Mathematics
University of California
Riverside CA, USA 92521

email: baez@math.ucr.edu, courser@math.ucr.edu

January 7, 2020

ABSTRACT. One goal of applied category theory is to better understand networks appearing throughout science and engineering. Here we introduce ‘structured cospans’ as a way to study networks with inputs and outputs. Given a functor $L: \mathbf{A} \rightarrow \mathbf{X}$, a structured cospan is a diagram in \mathbf{X} of the form $L(a) \rightarrow x \leftarrow L(b)$. If \mathbf{A} and \mathbf{X} have finite colimits and L is a left adjoint, we obtain a symmetric monoidal category whose objects are those of \mathbf{A} and whose morphisms are isomorphism classes of structured cospans. This is a hypergraph category. However, it arises from a more fundamental structure: a symmetric monoidal double category where the horizontal 1-cells are structured cospans. We show how structured cospans solve certain problems in the closely related formalism of ‘decorated cospans’, and explain how they work in some examples: electrical circuits, Petri nets, and chemical reaction networks.

1. INTRODUCTION

Structured cospans are a framework for dealing with open networks: that is, networks with inputs and outputs. Networks arise in many areas of science and engineering and come in many kinds, but a companion paper illustrates the general framework developed here with the example of open Petri nets [5], so let us consider those.

Petri nets are important in computer science, chemistry and other subjects. For example, the chemical reaction that takes two atoms of hydrogen and one atom of oxygen and produces a molecule of water can be represented by this very simple Petri net:

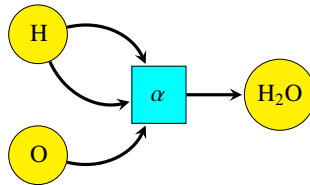

Here we have a set of ‘places’ (or in chemistry, ‘species’) drawn in yellow and a set of ‘transitions’ (or ‘reactions’) drawn in blue. The disjoint union of these two sets then forms the vertex set of a directed bipartite graph, which is one description of a Petri net.

Networks can often be seen as pieces of larger networks. This naturally leads to the idea of an *open* Petri net, meaning that the set of places is equipped with ‘inputs’ and ‘outputs’. We can do this by prescribing two functions into the set of places that pick out these inputs and outputs. For example:

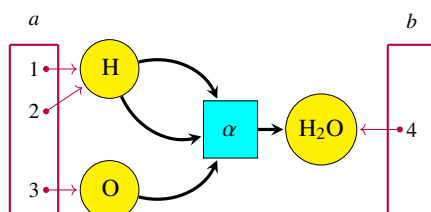

The inputs and outputs let us compose open Petri nets. For example, suppose we have another open Petri net that represents the chemical reaction of two molecules of water turning into hydronium and hydroxide:

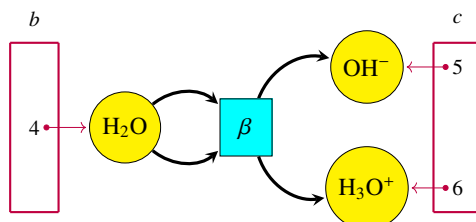

Since the outputs of the first open Petri net coincide with the inputs of the second, we can compose them by identifying the outputs of the first with the inputs of the second:

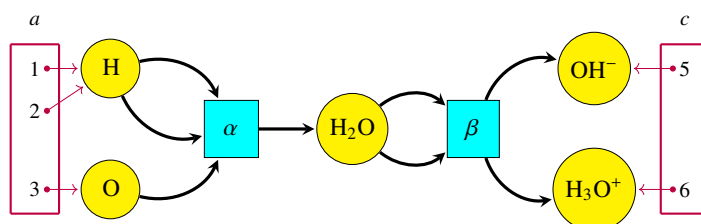

Similarly we can ‘tensor’ two open Petri nets by placing them side by side:

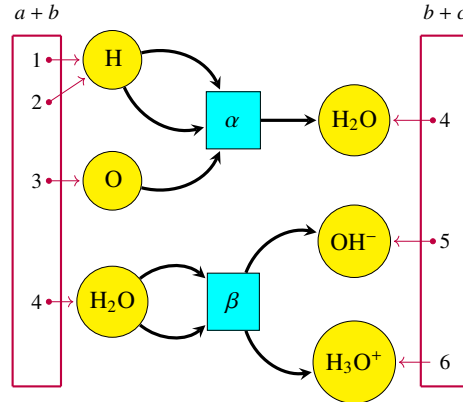

We can formalize this example using ‘structured cospans’. Given a functor $L: \mathbf{A} \rightarrow \mathbf{X}$, a **structured cospan** is a diagram in \mathbf{X} of the form

$$\begin{array}{ccc} & x & \\ i \nearrow & & \nwarrow o \\ L(a) & & L(b) \end{array}$$

The objects a and b are called the **input** and **output**, respectively, while x is called the **apex** and the morphisms i and o are called the **legs** of the cospan.

For example, there is a category \mathbf{Petri} with Petri nets as objects and a functor $L: \mathbf{Set} \rightarrow \mathbf{Petri}$ sending any set to the Petri net with that set of species and no transitions. In this case a structured cospan is just an open Petri net. Furthermore, in this case L is a left adjoint, so it preserves colimits. This occurs in many examples.

Given a functor $L: \mathbf{A} \rightarrow \mathbf{X}$, we can compose structured cospans whenever \mathbf{X} has pushouts. In Cor. 2.5 we show this gives a category ${}_L\mathbf{Csp}(\mathbf{X})$ with:

- objects of \mathbf{A} as objects,
- isomorphism classes of structured cospans as morphisms.

Here we say two structured cospans $L(a) \rightarrow x \leftarrow L(b)$ and $L(a) \rightarrow y \leftarrow L(b)$ are **isomorphic** if there is an isomorphism $f: x \rightarrow y$ such that the diagram

$$\begin{array}{ccc} & x & \\ \nearrow & \downarrow f & \nwarrow \\ L(a) & & L(b) \\ \searrow & & \swarrow \\ & y & \end{array}$$

commutes. In Cor. 3.11 we show this category ${}_L\mathbf{Csp}(\mathbf{X})$ becomes symmetric monoidal when \mathbf{A} and \mathbf{X} have finite colimits and L preserves them. Under these assumptions, in Thm. 3.12 we prove that ${}_L\mathbf{Csp}(\mathbf{X})$ is actually a special sort of symmetric monoidal category called a ‘hypergraph category’ [17]. These are important in the theory of networks [13, 14].

Sometimes it is inconvenient to work with isomorphism classes of structured cospans. For example, in an open Petri net we can refer to a particular species or transition; in an isomorphism class of open Petri nets we cannot. To use actual structured cospans as morphisms we need a higher categorical structure, because composing them is associative

only up to isomorphism. Indeed, in Cor. 2.4 we show that for any functor $L: \mathbf{A} \rightarrow \mathbf{X}$, if \mathbf{X} has pushouts there is a bicategory ${}_L\mathbf{Csp}(\mathbf{X})$ with:

- objects of \mathbf{A} as objects,
- structured cospans as 1-morphisms,
- commutative diagrams

$$\begin{array}{ccc} & x & \\ L(a) & \begin{array}{c} \nearrow \\ \searrow \end{array} & L(b) \\ & f & \\ & y & \end{array}$$

as 2-morphisms.

In Cor. 3.10 we show that the bicategory ${}_L\mathbf{Csp}(\mathbf{X})$ is symmetric monoidal when \mathbf{A} and \mathbf{X} have finite colimits and L preserves them. However, the coherence laws for a symmetric monoidal bicategory are rather complicated [33]. As Shulman pointed out, it is often easier to work with a symmetric monoidal *double* category [32]. Thus we show in Thm. 2.3 that for any functor $L: \mathbf{A} \rightarrow \mathbf{X}$, if \mathbf{X} has pushouts there is a double category ${}_L\mathbf{Csp}(\mathbf{X})$ with:

- objects of \mathbf{A} as objects,
- morphisms of \mathbf{A} as vertical 1-morphisms,
- structured cospans as horizontal 1-cells,
- commutative diagrams

$$\begin{array}{ccccc} L(a) & \xrightarrow{i} & x & \xleftarrow{o} & L(b) \\ L(a) \downarrow & & f \downarrow & & \downarrow L(\beta) \\ L(a') & \xrightarrow{i'} & x' & \xleftarrow{o'} & L(b') \end{array}$$

as 2-morphisms.

Note that vertical composition in this double category is strictly associative, while horizontal composition is not. In Thm. 3.9 we show that that ${}_L\mathbf{Csp}(\mathbf{X})$ is a symmetric monoidal double category when \mathbf{A} and \mathbf{X} have finite colimits and L preserves them. Using Shulman's work, we conclude in Cor. 3.10 that the bicategory ${}_L\mathbf{Csp}(\mathbf{X})$ is symmetric monoidal bicategory under the same conditions.

The reader familiar with decorated cospans may wonder why we need structured cospans. Recall that Fong [13] constructed a category of ‘decorated cospans’ $FCospan(\mathbf{A})$ from any category \mathbf{A} with finite colimits together with a lax symmetric monoidal functor $F: (\mathbf{A}, +) \rightarrow (\mathbf{Set}, \times)$. The objects of $FCospan(\mathbf{A})$ are those of \mathbf{A} , while the morphisms are equivalence classes of F -decorated cospans. Here an **F -decorated cospan** is a pair

$$a \xrightarrow{i} s \xleftarrow{o} b, \quad d \in F(s).$$

The element d , called the **decoration**, serves as a way to equip the apex s with extra structure. The above decorated cospan is equivalent to

$$a \xrightarrow{i} s' \xleftarrow{o} b, \quad d' \in F(s')$$

iff there an isomorphism $f: s \rightarrow s'$ in \mathbf{A} making this diagram commute:

$$\begin{array}{ccccc}
 & & s & & \\
 & i \nearrow & \downarrow f & \nwarrow o & \\
 a & & & & b \\
 & i' \searrow & \downarrow & \swarrow o' & \\
 & & s' & &
 \end{array}$$

and such that $F(f)(d) = d'$.

Both decorated and structured cospans are ways to describe a cospan whose apex is equipped with extra structure. Since the theory of decorated cospans is already well-developed, what is the point of another formalism? One reason is that structured cospans are a bit simpler: instead of a lax symmetric monoidal functor $F: \mathbf{A} \rightarrow \mathbf{Set}$ assigning to each object of \mathbf{A} the set of possible structures we can put on it, we can simply use an arbitrary functor L from \mathbf{A} to any category \mathbf{X} . Another reason is that structured cospans solve a certain technical problem with decorated cospans.

In some applications of decorated cospans, the isomorphism classes turn out to be too small. That is, two decorated cospans that morally ‘should be’ isomorphic are not. This problem becomes even more apparent when decorated cospan categories are promoted to decorated cospan double categories, or bicategories [10]. We discuss this problem, and how structured cospans gets around it, in Sec. 5. Finally, in Sec. 6, we study applications of structured cospans to electrical circuits, open Petri nets and chemical reaction networks.

Conventions. In this paper, ‘double category’ means ‘pseudo double category’, as in Defn. A.1. Following Shulman [32], vertical composition in our double categories is strictly associative, while horizontal composition need not be. We use sans-serif font like \mathbf{C} for categories, boldface like \mathbf{B} for bicategories or 2-categories, and blackboard bold like \mathbb{D} for double categories. We also use blackboard bold for weak category objects in any 2-category. For double categories with names having more than one letter, like $\mathbb{C}\mathbf{sp}(\mathbf{X})$, only the first letter is in blackboard bold. A double category \mathbb{D} has an category of objects and a category of arrows, and we call these \mathbb{D}_0 and \mathbb{D}_1 despite the fact that they are categories.

Acknowledgements. The authors would like to thank Christina Vasilakopoulou for the clever idea of replacing the category of objects of some double category by some other category. We would also like to thank Marco Grandis and Robert Paré for pointing out the importance of double categories with double colimits, and Mike Shulman for catching an error.

2. STRUCTURED COSPANS

Given a functor $L: \mathbf{A} \rightarrow \mathbf{X}$, a **structured cospan** is a cospan in \mathbf{X} whose feet come from objects in \mathbf{A} :

$$\begin{array}{ccc} & x & \\ & \nearrow & \nwarrow \\ L(a) & & L(b). \end{array}$$

When L has a right adjoint $R: \mathbf{X} \rightarrow \mathbf{A}$ we can also think of this as a cospan in \mathbf{A} ,

$$\begin{array}{ccc} & R(x) & \\ & \nearrow & \nwarrow \\ a & & b, \end{array}$$

where the apex is equipped with extra structure, namely an object $x \in \mathbf{X}$ that it comes from. However, treating structured cospans as living in \mathbf{X} is technically more convenient, since then we only need \mathbf{X} to have pushouts to compose them.

In Thm. 2.3 we show that when \mathbf{X} has pushouts, structured cospans are the horizontal 1-cells of a double category ${}_{L}\mathbf{Csp}(\mathbf{X})$. To prove this we begin by recalling the double category of cospans in \mathbf{X} . For the definition of double category see Appendix A.

Lemma 2.1. *Given a category \mathbf{X} with chosen pushouts, there exists a unique double category $\mathbf{Csp}(\mathbf{X})$ such that:*

- an object is an object of \mathbf{X} ,
- a vertical 1-morphism is a morphism of \mathbf{X} ,
- a horizontal 1-cell from x_1 to x_2 is a cospan in \mathbf{X} :

$$x_1 \xrightarrow{i} y \xleftarrow{o} x_2$$

- a 2-morphism is a commutative diagram in \mathbf{X} of this form:

$$\begin{array}{ccccc} x_1 & \xrightarrow{i} & y & \xleftarrow{o} & x_2 \\ f_1 \downarrow & & g \downarrow & & \downarrow f_2 \\ x'_1 & \xrightarrow{i'} & y' & \xleftarrow{o'} & x'_2 \end{array}$$

- composition of vertical 1-morphisms is composition in \mathbf{X} ,
- composition of horizontal 1-cells is done using the chosen pushouts in \mathbf{X} :

$$\begin{array}{ccccc} & & y +_{x_2} z & & \\ & & \nearrow j_y & & \nwarrow j_z \\ & y & & & z \\ \nearrow i_1 & & \nwarrow o_1 & & \nearrow i_2 \\ x_1 & & x_2 & & x_3 \\ & & \nwarrow o_2 & & \end{array}$$

where j_y and j_z are the canonical morphisms from y and z into the pushout,

- the horizontal composite of two 2-morphisms:

$$\begin{array}{ccc}
 x_1 & \xrightarrow{i_1} & y \longleftarrow^{o_1} x_2 \\
 f_1 \downarrow & & g \downarrow \quad \downarrow f_2 \\
 x'_1 & \xrightarrow{i'_1} & y' \longleftarrow^{o'_1} x'_2
 \end{array}
 \quad
 \begin{array}{ccc}
 x_2 & \xrightarrow{i_2} & z \longleftarrow^{o_2} x_3 \\
 f_2 \downarrow & & h \downarrow \quad \downarrow f_3 \\
 x'_2 & \xrightarrow{i'_2} & z' \longleftarrow^{o'_2} x'_3
 \end{array}$$

is given by

$$\begin{array}{ccc}
 x_1 & \xrightarrow{j_y i_1} & y +_{x_2} z \longleftarrow^{j_z o_2} x_3 \\
 f_1 \downarrow & & g +_{f_2} h \downarrow \quad \downarrow f_3 \\
 x'_1 & \xrightarrow{j_{y'} i'_1} & y' +_{x'_2} z' \longleftarrow^{j_{z'} o'_2} x'_3.
 \end{array}$$

- the vertical composite of two 2-morphisms:

$$\begin{array}{ccc}
 x_1 & \xrightarrow{i} & y \longleftarrow^o x_2 \\
 f_1 \downarrow & & g \downarrow \quad \downarrow f_2 \\
 x'_1 & \xrightarrow{i'} & y' \longleftarrow^{o'} x'_2 \\
 \\
 x'_1 & \xrightarrow{i'} & y' \longleftarrow^{o'} x'_2 \\
 f'_1 \downarrow & & g' \downarrow \quad \downarrow f'_2 \\
 x''_1 & \xrightarrow{i''} & y'' \longleftarrow^{o''} x''_2
 \end{array}$$

is given by

$$\begin{array}{ccc}
 x_1 & \xrightarrow{i} & y \longleftarrow^o x_2 \\
 f'_1 f_1 \downarrow & & g' g \downarrow \quad \downarrow f'_2 f_2 \\
 x''_1 & \xrightarrow{i''} & y'' \longleftarrow^{o''} x''_2
 \end{array}$$

- the associator and unitors are defined using the universal property of pushouts.

Proof. This is well known [10, 29]. \square

We expect that a different choice of pushouts in \mathbb{X} will give an equivalent double category $\mathbf{Csp}(\mathbb{X})$, since pushouts are unique up to canonical isomorphism.

To build structured cospan double categories, we use a trick we learned from Christina Vasilakopoulou for taking a double category \mathbb{X} and replacing its objects and vertical 1-morphisms with the objects and morphisms of some category \mathbf{A} . In Appendix A, we recall that any double category \mathbb{X} has a category \mathbb{X}_0 called its **category of objects**, whose objects are those of \mathbb{X} and whose morphisms are the vertical 1-morphisms of \mathbb{X} . We can replace the category of objects by \mathbf{A} using a functor $L: \mathbf{A} \rightarrow \mathbb{X}_0$.

Lemma 2.2. *Given a double category \mathbb{X} , a category \mathbf{A} and a functor $L: \mathbf{A} \rightarrow \mathbb{X}_0$, there exists a unique double category ${}_L\mathbb{X}$ for which:*

- an object is an object of \mathbf{A} ,
- a vertical 1-morphism is a morphism of \mathbf{A} ,
- a horizontal 1-cell from a to a' is a horizontal 1-cell $L(a) \xrightarrow{M} L(a')$ of \mathbb{X} ,
- a 2-morphism is a 2-morphism in \mathbb{X} of the form:

$$\begin{array}{ccc} L(a) & \xrightarrow{M} & L(b) \\ L(f) \downarrow & \Downarrow \alpha & \downarrow L(g) \\ L(a') & \xrightarrow{N} & L(b'), \end{array}$$

- composition of vertical 1-morphisms is composition in \mathbf{A} ,
- composition of horizontal 1-morphisms are defined as in \mathbb{X} ,
- vertical and horizontal composition of 2-morphisms is defined as in \mathbb{X} ,
- the associator and unitors are defined as in \mathbb{X} .

Proof. It is easy to check the double category axioms using the fact that \mathbb{X} is a double category and L is a functor. \square

Putting the above lemmas together, we obtain our double category of structured cospans. We describe it quite explicitly for reference purposes:

Theorem 2.3. *Let $L: \mathbf{A} \rightarrow \mathbf{X}$ be a functor where \mathbf{X} is a category with chosen pushouts. Then there exists a unique double category ${}_L\mathbf{Csp}(\mathbf{X})$ for which:*

- an object is an object of \mathbf{A} ,
- a vertical 1-morphism is a morphism of \mathbf{A} ,
- a horizontal 1-cell from a to b is a diagram in \mathbf{X} of this form:

$$L(a) \xrightarrow{i} x \xleftarrow{o} L(b)$$

- a 2-morphism is a commutative diagram in \mathbf{X} of this form:

$$\begin{array}{ccccc} L(a) & \xrightarrow{i} & x & \xleftarrow{o} & L(b) \\ L(\alpha) \downarrow & & f \downarrow & & \downarrow L(\beta) \\ L(a') & \xrightarrow{i'} & x' & \xleftarrow{o'} & L(b') \end{array}$$

- composition of horizontal 1-cells is done using the chosen pushouts in \mathbf{X} :

$$\begin{array}{ccccc} & & x +_{L(b)} y & & \\ & \nearrow j_x & & \nwarrow j_y & \\ & x & & y & \\ i_1 \nearrow & & \swarrow o_1 & & \nwarrow o_2 \\ L(a) & & L(b) & & L(c) \end{array}$$

where j_x and j_y are the canonical morphisms from x and y into the pushout,

- identity horizontal 1-cells are diagrams of this form:

$$L(a) \xrightarrow{1} L(a) \xleftarrow{1} L(a)$$

- the horizontal composite of two 2-morphisms:

$$\begin{array}{ccc}
 L(a) & \xrightarrow{i_1} x & \xleftarrow{o_1} L(b) \\
 L(\alpha) \downarrow & f \downarrow & \downarrow L(\beta) \\
 L(a') & \xrightarrow{i'_1} x' & \xleftarrow{o'_1} L(b')
 \end{array}
 \quad
 \begin{array}{ccc}
 L(b) & \xrightarrow{i_2} y & \xleftarrow{o_2} L(c) \\
 L(\beta) \downarrow & g \downarrow & \downarrow L(\gamma) \\
 L(b') & \xrightarrow{i'_2} y' & \xleftarrow{o'_2} L(c')
 \end{array}$$

is given by

$$\begin{array}{ccc}
 L(a) & \xrightarrow{j_x i_1} x +_{L(b)} y & \xleftarrow{j_y o_2} L(c) \\
 L(\alpha) \downarrow & f +_{L(\beta)} g \downarrow & \downarrow L(\gamma) \\
 L(a') & \xrightarrow{j_{x'} i'_1} x' +_{L(b')} y' & \xleftarrow{j_{y'} o'_2} L(c')
 \end{array}$$

- the identities for horizontal composition of 2-morphisms are diagrams of this form:

$$\begin{array}{ccc}
 L(a) & \xrightarrow{1} L(a) & \xleftarrow{1} L(a) \\
 L(\alpha) \downarrow & L(\alpha) \downarrow & \downarrow L(\alpha) \\
 L(a') & \xrightarrow{1} L(a') & \xleftarrow{1} L(a')
 \end{array}$$

- the vertical composite of two 2-morphisms:

$$\begin{array}{ccc}
 L(a) & \xrightarrow{i} y & \xleftarrow{o} L(b) \\
 L(\alpha) \downarrow & f \downarrow & \downarrow L(\beta) \\
 L(a') & \xrightarrow{i'} y' & \xleftarrow{o'} L(b')
 \end{array}$$

$$\begin{array}{ccc}
 L(a') & \xrightarrow{i''} y'' & \xleftarrow{o''} L(b'') \\
 L(\alpha') \downarrow & f' \downarrow & \downarrow L(\beta') \\
 L(a'') & \xrightarrow{i'''} y''' & \xleftarrow{o'''} L(b''')
 \end{array}$$

is given by

$$\begin{array}{ccc}
 L(a) & \xrightarrow{i} y & \xleftarrow{o} L(b) \\
 L(\alpha' \alpha) \downarrow & f' f \downarrow & \downarrow L(\beta' \beta) \\
 L(a'') & \xrightarrow{i''} y'' & \xleftarrow{o''} L(b'')
 \end{array}$$

- the associator and unitors are defined using the universal property of pushouts.

Proof. We apply Lemma 2.2 to the double category $\mathbb{C}\mathbf{sp}(X)$ of Lemma 2.1. \square

From the double category ${}_L\mathbf{Csp}(X)$ we can extract a bicategory ${}_L\mathbf{Csp}(X)$ and then a category ${}_L\mathbf{Csp}(X)$. In many applications all we need is a bicategory or even a mere category of structured cospans, so the reader should not get the misimpression that working with structured cospans *requires* using double categories. We begin with the bicategory:

Corollary 2.4. *Let $L: A \rightarrow X$ be a functor where X is a category with chosen pushouts. Then there exists a unique bicategory ${}_L\mathbf{Csp}(X)$ for which:*

- an object is an object of A ,
- a morphism from a to b is a diagram in X of this form:

$$L(a) \xrightarrow{i} x \xleftarrow{o} L(b)$$

- a 2-morphism is a commutative diagram in X of this form:

$$\begin{array}{ccc} & x & \\ L(a) & \begin{array}{c} \nearrow i \\ \searrow f \\ \downarrow \\ \searrow i' \\ \downarrow \\ x' \end{array} & \begin{array}{c} \nwarrow o \\ \swarrow o' \\ \downarrow \\ \swarrow o' \\ \downarrow \\ x' \end{array} & L(b) \\ & x' & \end{array}$$

- composition of morphisms is done using the chosen pushouts in X ,
- identity morphisms are of this form:

$$L(a) \xrightarrow{1} L(a) \xleftarrow{1} L(a)$$

- the horizontal composite of 2-morphisms:

$$\begin{array}{ccc} & x & \\ L(a) & \begin{array}{c} \nearrow i_1 \\ \searrow f \\ \downarrow \\ \searrow i'_1 \\ \downarrow \\ x' \end{array} & L(b) \\ & x' & \end{array} \quad \begin{array}{ccc} & y & \\ L(b) & \begin{array}{c} \nearrow i_2 \\ \searrow g \\ \downarrow \\ \searrow i'_2 \\ \downarrow \\ y' \end{array} & L(c) \\ & y' & \end{array}$$

is given by

$$\begin{array}{ccc} & x +_{L(b)} y & \\ L(a) & \begin{array}{c} \nearrow j_x i_1 \\ \searrow f +_{L(b)} g \\ \downarrow \\ \searrow j_y o_2 \\ \downarrow \\ x' +_{L(b)} y' \end{array} & L(c) \\ & x' +_{L(b)} y' & \end{array}$$

where j_x and j_y are the canonical morphisms from x and y into the pushout $x +_{L(b)} y$, and similarly for $j_{x'}$ and $j_{y'}$,

- the vertical composite of two 2-morphisms:

$$\begin{array}{ccc} & y & \\ L(a) & \begin{array}{c} \nearrow i \\ \searrow f \\ \downarrow \\ \searrow i' \\ \downarrow \\ y' \end{array} & L(b) \\ & y' & \end{array} \quad \begin{array}{ccc} & y'' & \\ L(a) & \begin{array}{c} \nearrow i' \\ \searrow f' \\ \downarrow \\ \searrow i'' \\ \downarrow \\ y'' \end{array} & L(b) \\ & y'' & \end{array}$$

is given by

$$\begin{array}{ccc}
 & y & \\
 i \nearrow & & \nwarrow o \\
 L(a) & & L(b) \\
 i'' \searrow & f' f \downarrow & \swarrow o'' \\
 & y'' &
 \end{array}$$

- the associator and unitors are defined using the universal property of pushouts.

Proof. As noted for example by Shulman [32], any double category \mathbb{X} gives rise to a bicategory \mathbf{X} with

- objects given by objects of \mathbb{X} ,
- morphisms given by horizontal 1-cells of \mathbb{X} ,
- 2-morphisms given by **globular** 2-morphisms of \mathbb{X} , meaning 2-morphisms whose source and target vertical 1-morphisms are identities,
- composition of morphisms given by horizontal composition of horizontal 1-cells in \mathbb{X} ,
- vertical and horizontal composition of 2-morphisms given by vertical and horizontal composition of 2-morphisms in \mathbb{X} .

Applying this to ${}_L\mathbf{Csp}(X)$ we obtain ${}_L\mathbf{Csp}(X)$. \square

Corollary 2.5. *Let $L: A \rightarrow X$ be a functor where X is a category with pushouts. Then there exists a unique category ${}_L\mathbf{Csp}(X)$ for which:*

- an object is an object of A ,
- a morphism from a to b is an isomorphism class of diagrams in X of this form:

$$L(a) \xrightarrow{i} x \xleftarrow{o} L(b)$$

where $L(a) \xrightarrow{i} x \xleftarrow{o} L(b)$ and $L(a) \xrightarrow{i'} x' \xleftarrow{o'} L(b)$ are isomorphic iff there is an isomorphism $f: x \rightarrow x'$ making this diagram commute:

$$\begin{array}{ccc}
 & x & \\
 i \nearrow & & \nwarrow o \\
 L(a) & & L(b) \\
 i' \searrow & f \downarrow & \swarrow o' \\
 & x' &
 \end{array}$$

- composition of morphisms is done using pushouts in X .

Proof. By decategorifying a bicategory \mathbf{B} we obtain a category \mathbf{B} with the same objects, whose morphisms are isomorphism classes of 1-morphisms in \mathbf{B} . Applying this to ${}_L\mathbf{Csp}(X)$ we obtain ${}_L\mathbf{Csp}(X)$. Note that this category is independent of our choice of pushouts in X , since pushouts are unique up to isomorphism. \square

In the next section we give simple conditions under which the double category ${}_L\mathbf{Csp}(X)$, the bicategory ${}_L\mathbf{Csp}(X)$ and the category ${}_L\mathbf{Csp}(X)$ all become symmetric monoidal.

3. SYMMETRIC MONOIDAL DOUBLE CATEGORIES OF STRUCTURED COSPANS

We have seen that if X has pushouts and $L: A \rightarrow X$ is any functor then there is a double category of structured cospans ${}_L\mathbf{Csp}(X)$. In Thm. 3.9 we show that ${}_L\mathbf{Csp}(X)$ becomes symmetric monoidal when A and X have finite colimits and L preserves these. The monoidal

structure describes our ability to take two structured cospans:

$$\begin{array}{ccc} & x & \\ i \nearrow & & \nwarrow o \\ L(a) & & L(b) \end{array} \qquad \begin{array}{ccc} & x' & \\ i' \nearrow & & \nwarrow o' \\ L(a') & & L(b') \end{array}$$

and form a new one via coproduct:

$$\begin{array}{ccc} & x + x' & \\ i + i' \nearrow & & \nwarrow o + o' \\ L(a) + L(a') & & L(b) + L(b') \\ \cong \nearrow & & \nwarrow \cong \\ L(a + a') & & L(b + b') \end{array}$$

One can check that this operation makes ${}_L\mathbf{Csp}(X)$ into a monoidal double category simply by verifying that a rather large number of diagrams commute. This is the approach taken in [11]. There is nothing tricky about it. Indeed, requiring that L preserve finite colimits is overkill: it suffices for L to preserve finite coproducts. Thus, for most readers the best thing to do at this point would be to review the definition of ‘symmetric monoidal double category’ in Appendix A, look at the statement of Thm. 3.9, and move on to the next section.

However, it is a bit irksome to check that all the necessary diagrams commute, especially since one gets the feeling that there must be a simple underlying reason. So, we decided to give a more conceptual proof. While perhaps harder to digest, this gives us more—at least when F preserves finite colimits. In this case we can do much more than take binary coproducts of structured cospans: we can take finite colimits of them! This means that we can glue together structured cospans in more interesting ways than merely composing them end to end or setting them side by side. Thus, we prove Thm. 3.9 as a consequence of a stronger result, Thm. 3.7, which captures the full range of ways we can take finite colimits of structured cospans.

The key concept we need is that of a ‘weak category’ or ‘pseudocategory’ in a 2-category. This is a slight generalization of the concept of double category.

Definition 3.1. *Given a 2-category \mathbf{C} , a **weak category** \mathbb{D} in \mathbf{C} consists of:*

- *an **object of objects** $\mathbb{D}_0 \in \mathbf{C}$ and an **object of arrows** $\mathbb{D}_1 \in \mathbf{C}$,*
- ***source and target morphisms***

$$S, T: \mathbb{D}_1 \rightarrow \mathbb{D}_0,$$

- *an **identity-assigning morphism***

$$U: \mathbb{D}_0 \rightarrow \mathbb{D}_1,$$

- *and a **composition morphism***

$$\odot: \mathbb{D}_1 \times_{\mathbb{D}_0} \mathbb{D}_1 \rightarrow \mathbb{D}_1$$

$$\text{where the pullback is taken over } \mathbb{D}_1 \xrightarrow{T} \mathbb{D}_0 \xleftarrow{S} \mathbb{D}_1,$$

such that:

- the source and target morphisms behave as expected for identities:

$$S \circ U = 1_{\mathbb{D}_0} = T \circ U$$

and for composition:

$$S \circ \circ = S \circ p_1, \quad T \circ \circ = T \circ p_2$$

where $p_1, p_2: \mathbb{D}_1 \times_{\mathbb{D}_0} \mathbb{D}_1 \rightarrow \mathbb{D}_1$ are projections to the two factors;

- composition is associative up to a 2-isomorphism called the **associator**:

$$\begin{array}{ccc} \mathbb{D}_1 \times_{\mathbb{D}_0} \mathbb{D}_1 \times_{\mathbb{D}_0} \mathbb{D}_1 & \xrightarrow{1 \times \circ} & \mathbb{D}_1 \times_{\mathbb{D}_0} \mathbb{D}_1 \\ \circ \times 1 \downarrow & \alpha \Downarrow & \downarrow \circ \\ \mathbb{D}_1 \times_{\mathbb{D}_0} \mathbb{D}_1 & \xrightarrow{\circ} & \mathbb{D}_1 \end{array}$$

- composition obeys the left and right unit laws up to 2-isomorphisms called the **left** and **right unitors**:

$$\begin{array}{ccccc} \mathbb{D}_0 \times_{\mathbb{D}_0} \mathbb{D}_1 & \xrightarrow{U \times_{\mathbb{D}_0} 1} & \mathbb{D}_1 \times_{\mathbb{D}_0} \mathbb{D}_1 & \xleftarrow{1 \times_{\mathbb{D}_0} U} & \mathbb{D}_1 \times_{\mathbb{D}_0} \mathbb{D}_0 \\ & \searrow \lambda \Downarrow & \downarrow \circ & \swarrow \rho \Downarrow & \\ & p_2 & \mathbb{D}_1 & p_1 & \end{array}$$

- α, λ and ρ obey the pentagon identity and triangle identity.

In this definition we assume that the necessary pullbacks exist; if \mathbf{C} has pullbacks this is automatic.

Consulting Appendix A, the reader can check that a weak category in \mathbf{Cat} is the same as a double category. We need weak categories in the following 2-categories as well:

Definition 3.2. Let \mathbf{Rex} be the 2-category with:

- categories with finite colimits as objects,
- functors preserving finite colimits as morphisms,
- natural transformations as 2-morphisms.

The word ‘rex’ is an abbreviation of ‘right exact’, which is another term for ‘preserving finite colimits’.

Definition 3.3. Let $\mathbf{SymMonCat}$ be the 2-category with:

- symmetric monoidal categories as objects,
- (strong) symmetric monoidal functors as morphisms,
- monoidal natural transformations as 2-morphisms.

Our plan now proceeds as follows. First, in Thm. 3.7, we show that when \mathbf{X} is a category with finite colimits, the double category ${}_L\mathbf{Csp}(\mathbf{X})$ is not merely a weak category in \mathbf{Cat} , but actually a weak category in \mathbf{Rex} . Next, there is a 2-functor $\Phi: \mathbf{Rex} \rightarrow \mathbf{SymMonCat}$ sending any category with finite colimits to the symmetric monoidal category where the tensor product is a chosen coproduct. In Thm. 3.8 we show that applying this to ${}_L\mathbf{Csp}(\mathbf{X})$ we obtain a weak category in $\mathbf{SymMonCat}$.

Finally, from this weak category in $\mathbf{SymMonCat}$, we wish to get a symmetric monoidal double category. Here we need the concept of a ‘symmetric pseudomonoid’ [34]. To understand the following definitions the reader should keep in mind the example where

\mathbf{B} is \mathbf{Cat} made into a symmetric monoidal bicategory using cartesian products. Then a pseudomonoid in \mathbf{B} is a monoidal category, a braided pseudomonoid is a braided monoidal category, and a symmetric pseudomonoid is a symmetric monoidal category.

Definition 3.4. A pseudomonoid in a monoidal bicategory \mathbf{B} is an object $M \in \mathbf{B}$ equipped with 1-morphisms called the **multiplication** $m: M \otimes M \rightarrow M$ and **unit** $i: I \rightarrow M$ that obey associativity and the left and right unit laws up to 2-isomorphisms called the **associator** and left and right **unitors**, that in turn obey the pentagon identity and triangle identity.

Definition 3.5. A pseudomonoid M in a braided monoidal bicategory \mathbf{B} is **braided** if it is equipped with a 2-isomorphism

$$b: m \circ \beta \xrightarrow{\sim} m$$

where $\beta: M \otimes M \rightarrow M \otimes M$ is the braiding in \mathbf{B} , and b obeys the hexagon identities.

Definition 3.6. A braided pseudomonoid M in a symmetric monoidal bicategory \mathbf{B} is called **symmetric** if

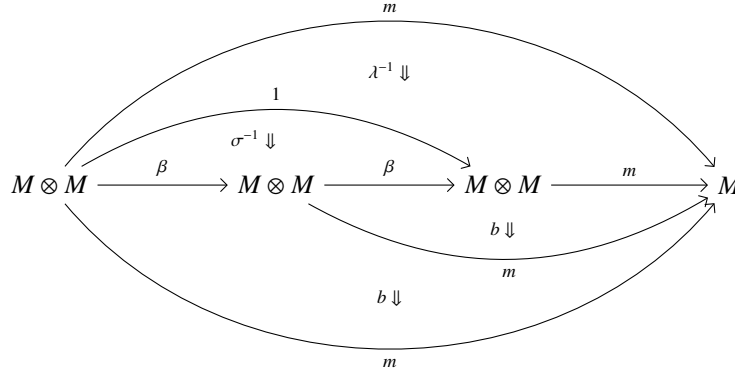

is the identity 2-morphism from m to m . Here λ is the left unitor for composition of 1-morphisms in \mathbf{B} and $\sigma: \beta^2 \Rightarrow 1$ is the syllepsis for \mathbf{B} .

Readers unfamiliar with these concepts may be relieved to learn that the syllepsis in \mathbf{Cat} is the identity; in a general symmetric monoidal bicategory the square of the braiding may be only *isomorphic* to the identity, and this isomorphism is called the syllepsis.

The plan continues as follows. Having shown that ${}_L\mathbf{Csp}(X)$ is a weak category in $\mathbf{SymMonCat}$, we notice that such a thing is

a weak category in [symmetric pseudomonoids in \mathbf{Cat}].

By ‘commutativity of internalization’ we could hope that this is the same as

a symmetric pseudomonoid in [weak categories in \mathbf{Cat}].

But the latter is precisely a symmetric double category. So, ${}_L\mathbf{Csp}(X)$ should be a symmetric monoidal double category.

Unfortunately, this hope is a bit naive. Shulman explains the reason [32]:

The general yoga of internalization says that an X internal to Y s internal to Z s is equivalent to a Y internal to X s internal to Z s, but this is only strictly true when the internalizations are all strict. We have defined a symmetric monoidal double category to be a (pseudo) symmetric monoid internal to (pseudo) categories internal to categories, but one could also consider a

(pseudo) category internal to (pseudo) symmetric monoids internal to categories, i.e. a pseudo internal category in the 2-category **SymMonCat** of symmetric monoidal categories and strong symmetric monoidal functors. This would give *almost* the same definition, except that S and T would only be strong monoidal (preserving \otimes up to isomorphism) rather than strict monoidal.

Luckily, the difference between the two definitions is quite small, so with a bit of care we can arrange for ${}_L\mathbf{Csp}(X)$ to be a symmetric monoidal double category.

We begin as follows:

Theorem 3.7. *Given a morphism $L: A \rightarrow X$ in **Rex**, the double category ${}_L\mathbf{Csp}(X)$ is a weak category object in **Rex**.*

Proof. In the double category ${}_L\mathbf{Csp}(X)$,

- the category of objects ${}_L\mathbf{Csp}(X)_0$ is A , while
- the category of arrows ${}_L\mathbf{Csp}(X)_1$ has structured cospans

$$L(a) \xrightarrow{i} x \xleftarrow{o} L(b)$$

as objects and commutative diagrams of this form:

$$\begin{array}{ccccc} L(a) & \xrightarrow{i} & x & \xleftarrow{o} & L(b) \\ L(a) \downarrow & & f \downarrow & & \downarrow L(b) \\ L(a') & \xrightarrow{i'} & x' & \xleftarrow{o'} & L(b') \end{array}$$

as morphisms.

We need to verify that ${}_L\mathbf{Csp}(X)_0$ and ${}_L\mathbf{Csp}(X)_1$ have finite colimits and that the source and target functors

$$S, T: {}_L\mathbf{Csp}(X)_1 \rightarrow {}_L\mathbf{Csp}(X)_0,$$

the identity-assigning functor

$$U: {}_L\mathbf{Csp}(X)_0 \rightarrow {}_L\mathbf{Csp}(X)_1,$$

and the composition functor

$$\circ: {}_L\mathbf{Csp}(X)_1 \times_{{}_L\mathbf{Csp}(X)_0} {}_L\mathbf{Csp}(X)_1 \rightarrow {}_L\mathbf{Csp}(X)_1$$

are right exact. We also need to check that all the pullbacks in **Cat** used to define the double category ${}_L\mathbf{Csp}(X)$ are also pullbacks in **Rex**.

The category of objects ${}_L\mathbf{Csp}(X)_0 = A$ has finite colimits by hypothesis. The category of arrows ${}_L\mathbf{Csp}(X)_1$ has finite colimits because L preserves finite colimits and these colimits are computed pointwise in X . The functors S, T and U are right exact, again because colimits in ${}_L\mathbf{Csp}(X)_1$ are computed pointwise in X . The functor \circ sends a composable pair of structured cospans to their composite, which is defined using a pushout. This functor is right exact as a consequence of colimits commuting with other colimits.

We also need to check that the category

$$Z = {}_L\mathbf{Csp}(X)_1 \times_{{}_L\mathbf{Csp}(X)_0} {}_L\mathbf{Csp}(X)_1,$$

defined as a pullback in **Cat**, is also a pullback in **Rex**. Note that objects of **Z** are composable pairs of structured cospans:

$$L(a) \rightarrow x \leftarrow L(b) \rightarrow y \leftarrow L(c),$$

while morphisms are commuting diagrams of the form

$$\begin{array}{ccccccccc} L(a) & \longrightarrow & x & \longleftarrow & L(b) & \longrightarrow & y & \longleftarrow & L(c) \\ L(\alpha) \downarrow & & f \downarrow & & L(\beta) \downarrow & & g \downarrow & & L(\gamma) \downarrow \\ L(a') & \longrightarrow & x' & \longleftarrow & L(b') & \longrightarrow & y' & \longleftarrow & L(c'). \end{array}$$

Because **A** and **X** have finite colimits and L preserves them, **Z** has finite colimits computed pointwise. Consider the pullback square in **Cat** defining **Z**:

$$\begin{array}{ccc} \mathbf{Z} & \xrightarrow{P_2} & {}_L\mathbf{Csp}(X)_1 \\ P_1 \downarrow & & \downarrow T \\ {}_L\mathbf{Csp}(X)_1 & \xrightarrow{S} & {}_L\mathbf{Csp}(X)_0 \end{array}$$

where P_1 picks out the first structured cospan of an object in **Z**, and P_2 picks out the second. All the arrows here are right exact because colimits are computed pointwise. Suppose next that F and G below are right exact:

$$\begin{array}{ccccc} & & \mathbf{Q} & \xrightarrow{G} & \\ & & \downarrow Q & & \\ & & \mathbf{Z} & \xrightarrow{P_2} & {}_L\mathbf{Csp}(X)_1 \\ & & P_1 \downarrow & & \downarrow T \\ & & {}_L\mathbf{Csp}(X)_1 & \xrightarrow{S} & {}_L\mathbf{Csp}(X)_0. \\ & F \nearrow & & & \end{array}$$

Then there exists a unique functor Q making the diagram commute, and Q can be seen to be right exact because its composites with P_1 and P_2 are. The other pullbacks used in defining the double category ${}_L\mathbf{Csp}(X)$, such as the pullback ${}_L\mathbf{Csp}(X)_1 \times_{{}_L\mathbf{Csp}(X)_0} {}_L\mathbf{Csp}(X)_1 \times_{{}_L\mathbf{Csp}(X)_0} {}_L\mathbf{Csp}(X)_1$ used in defining the associator, are also pullbacks in **Rex** for the same sort of reason. \square

Next we make ${}_L\mathbf{Csp}(X)$ into a weak category in **SymMonCat**. We do this by applying a 2-functor

$$\Phi: \mathbf{Rex} \rightarrow \mathbf{SymMonCat}$$

to all the objects, morphisms and 2-morphisms that constitute the weak category in **Rex** constructed in Thm. 3.7. This 2-functor works as follows. We make each category $\mathbf{C} \in \mathbf{Rex}$ into a symmetric monoidal category by arbitrarily choosing an initial object $0_{\mathbf{C}}$ to be the unit object and choosing a binary coproduct for each pair of objects to be their tensor product; the rest of the symmetric monoidal category structure is then canonically determined. Each right exact functor $F: \mathbf{C} \rightarrow \mathbf{C}'$ between categories $\mathbf{C}, \mathbf{C}' \in \mathbf{Rex}$ then becomes symmetric monoidal in a canonical way, and each natural transformation between

right exact functors becomes monoidal. While Φ depends on our choices of initial object and binary coproducts for each $\mathbf{C} \in \mathbf{Rex}$, different choices lead to naturally isomorphic 2-functors.

Theorem 3.8. *Given a morphism $L: \mathbf{A} \rightarrow \mathbf{X}$ in \mathbf{Rex} , the functor $\Phi: \mathbf{Rex} \rightarrow \mathbf{SymMonCat}$ maps the weak category ${}_L\mathbf{Csp}(X)$ in \mathbf{Rex} to a weak category in $\mathbf{SymMonCat}$.*

Proof. We need to show that the various pullbacks in \mathbf{Rex} used to make ${}_L\mathbf{Csp}(X)$ into a weak category in \mathbf{Rex} are mapped by Φ to pullbacks in $\mathbf{SymMonCat}$. We do this only for the pullback $Z = {}_L\mathbf{Csp}(X)_1 \times_{{}_L\mathbf{Csp}(X)_0} {}_L\mathbf{Csp}(X)_1$, since the others are similar. To show that $\Phi(Z)$ is the pullback of the following square in $\mathbf{SymMonCat}$:

$$\begin{array}{ccc} \Phi(Z) & \xrightarrow{\Phi(P_2)} & \Phi({}_L\mathbf{Csp}(X)_1) \\ \Phi(P_1) \downarrow & & \downarrow \Phi(T) \\ \Phi({}_L\mathbf{Csp}(X)_1) & \xrightarrow{\Phi(S)} & \Phi({}_L\mathbf{Csp}(X)_0) \end{array}$$

we need to show that for any symmetric monoidal category \mathbf{Q} and symmetric monoidal functors $F, G: \mathbf{Q} \rightarrow \Phi({}_L\mathbf{Csp}(X)_1)$ with $\Phi(S)F = \Phi(T)G$, there exists a unique symmetric monoidal functor Q making this diagram commute:

$$\begin{array}{ccccc} & & \mathbf{Q} & & \\ & & \downarrow Q & & \downarrow G \\ & & \Phi(Z) & \xrightarrow{\Phi(P_2)} & \Phi({}_L\mathbf{Csp}(X)_1) \\ & & \downarrow \Phi(P_1) & & \downarrow \Phi(T) \\ & & \Phi({}_L\mathbf{Csp}(X)_1) & \xrightarrow{\Phi(S)} & \Phi({}_L\mathbf{Csp}(X)_0) \\ & \uparrow F & & & \\ & & \mathbf{Q} & & \end{array}$$

By Thm. 3.7 there exists a unique right exact functor Q making the underlying diagram of functors commute. We now show that this Q can be made symmetric monoidal in such a way that the diagram commutes in $\mathbf{SymMonCat}$.

First, let $0_{\mathbf{Q}}$ be the monoidal unit of \mathbf{Q} . Since $F: \mathbf{Q} \rightarrow \Phi({}_L\mathbf{Csp}(X)_1)$ is symmetric monoidal, we have an isomorphism between monoidal units:

$$F_0: 0_{\Phi({}_L\mathbf{Csp}(X)_1)} \xrightarrow{\sim} F(0_{\mathbf{Q}})$$

where $0_{\Phi({}_L\mathbf{Csp}(X)_1)}$ is initial in $\Phi({}_L\mathbf{Csp}(X)_1)$. Similarly we have an isomorphism

$$G_0: 0_{\Phi({}_L\mathbf{Csp}(X)_1)} \xrightarrow{\sim} G(0_{\mathbf{Q}}).$$

It follows that $Q(0_{\mathbf{Q}})$ is a pair of composable initial cospans in \mathbf{X} so there is a unique isomorphism

$$Q_0: 0_Z \xrightarrow{\sim} Q(0_{\mathbf{Q}}).$$

Next, given two objects a_1 and a_2 in \mathbf{Q} , we have a natural isomorphism

$$F_{a_1, a_2}: F(a_1) + F(a_2) \xrightarrow{\sim} F(a_1 \otimes a_2)$$

as F is symmetric monoidal, and similarly for G . We know that as objects, $F(a_1)$ and $F(a_2)$ are simply cospans in \mathbf{X} with $F(a_1) + F(a_2)$ their chosen coproduct. We also know

that $Q(a_1)$ is a pair of composable cospans $(F(a_1), G(a_1))$ and likewise $Q(a_2)$ is a pair of composable cospans $(F(a_2), G(a_2))$. This results in a natural isomorphism

$$Q_{a_1, a_2}: Q(a_1) + Q(a_2) \rightarrow Q(a_1 \otimes a_2)$$

given by the composite

$$(F(a_1), G(a_1)) + (F(a_2), G(a_2)) \xrightarrow{\sim} (F(a_1) + F(a_2), G(a_1) + G(a_2)) \xrightarrow{(F_{a_1, a_2}, G_{a_1, a_2})} (F(a_1 \otimes a_2), G(a_1 \otimes a_2)).$$

One can check that this family of natural isomorphisms Q_{a_1, a_2} together with the natural isomorphism Q_0 give Q the structure of a symmetric monoidal functor, and that the above diagram then commutes in **SymMonCat**. It follows that $\Phi(Z)$ is a pullback square in **SymMonCat**, as was to be shown. \square

In Thm. 3.8 we made ${}_L\mathbb{C}\mathbf{sp}(X)$ into a weak category in **SymMonCat** by *arbitrarily* choosing an initial object and binary coproducts for both ${}_L\mathbb{C}\mathbf{sp}(X)_0$ and ${}_L\mathbb{C}\mathbf{sp}(X)_1$. If we choose them a bit more carefully, ${}_L\mathbb{C}\mathbf{sp}(X)$ can be made into a symmetric monoidal double category. To do this, first arbitrarily choose an initial object and binary coproducts for \mathbf{A} and \mathbf{X} . Then, use these choices to define symmetric monoidal structures on ${}_L\mathbb{C}\mathbf{sp}(X)_0$ and ${}_L\mathbb{C}\mathbf{sp}(X)_1$. We obtain the following result:

Theorem 3.9. *Suppose \mathbf{A} and \mathbf{X} have finite colimits and $L: \mathbf{A} \rightarrow \mathbf{X}$ preserves them. Choose finite colimits in \mathbf{A} and \mathbf{X} . Then the double category ${}_L\mathbb{C}\mathbf{sp}(X)$ becomes symmetric monoidal where:*

- the tensor product of objects a_1, a_2 is their chosen coproduct $a_1 + a_2$ in \mathbf{A} ,
- the unit object is the chosen initial object $0_{\mathbf{A}}$ in \mathbf{A} ,
- the tensor product of two vertical 1-morphisms is given by

$$\begin{array}{ccc} a_1 & & a_2 \\ \downarrow f_1 & \otimes & \downarrow f_2 \\ b_1 & & b_2 \end{array} = \begin{array}{c} a_1 + a_2 \\ \downarrow f_1 + f_2 \\ b_1 + b_2 \end{array}$$

- the tensor product of horizontal 1-cells is given by

$$\begin{array}{ccc} & x & \\ & \nearrow i & \nwarrow o \\ L(a) & & L(b) \end{array} \otimes \begin{array}{ccc} & x' & \\ & \nearrow i' & \nwarrow o' \\ L(a') & & L(b') \end{array} = \begin{array}{ccc} & x + x' & \\ & \nearrow i + i' & \nwarrow o + o' \\ L(a + a') & & L(b + b') \end{array}$$

where $i + i'$ and $o + o'$ are defined using the fact that L preserves coproducts,

- the unit horizontal 1-cell is given by

$$L(0_{\mathbf{A}}) \xrightarrow{i} 0_{\mathbf{X}} \xleftarrow{o} L(0_{\mathbf{A}})$$

where $0_{\mathbf{X}}$ is the chosen initial object in \mathbf{X} ,

- the tensor product of two 2-morphisms is given by:

$$\begin{array}{ccc}
L(a_1) \xrightarrow{i_1} x_1 \xleftarrow{o_1} L(b_1) & & L(a'_1) \xrightarrow{i'_1} x'_1 \xleftarrow{o'_1} L(b'_1) \\
L(f) \downarrow \quad \alpha \downarrow \quad L(g) \downarrow & \otimes & L(f') \downarrow \quad \alpha' \downarrow \quad L(g') \downarrow \\
L(a_2) \xrightarrow{i_2} x_2 \xleftarrow{o_2} L(b_2) & & L(a'_2) \xrightarrow{i'_2} x'_2 \xleftarrow{o'_2} L(b'_2)
\end{array}$$

$$= \begin{array}{ccc}
L(a_1 + a'_1) \xrightarrow{i_1 + i'_1} x_1 + x'_1 \xleftarrow{o_1 + o'_1} L(b_1 + b'_1) & & \\
L(f + f') \downarrow \quad \alpha + \alpha' \downarrow \quad L(g + g') \downarrow & & \\
L(a_2 + a'_2) \xrightarrow{i_2 + i'_2} x_2 + x'_2 \xleftarrow{o_2 + o'_2} L(b_2 + b'_2), & &
\end{array}$$

and the associators, left and right unitors, and braidings are defined using the universal properties of binary coproducts and unit objects.

Proof. By Thm. 3.8, ${}_L\mathbb{C}\mathbf{sp}(X)$ is a weak category object in $\mathbf{SymMonCat}$, so both its category of objects and category of arrows are symmetric monoidal. To show that it is a symmetric monoidal double category, we need only show that the source and target functors

$$S, T: {}_L\mathbb{C}\mathbf{sp}(X)_1 \rightarrow {}_L\mathbb{C}\mathbf{sp}(X)_0$$

are *strict* symmetric monoidal [32, Remark 2.12]. This follows because S and T simply pick out the input and output of a structured cospan, and we are using the same chosen binary coproducts and initial object in \mathbf{A} in defining the monoidal structures on both ${}_L\mathbb{C}\mathbf{sp}(X)_0$ and ${}_L\mathbb{C}\mathbf{sp}(X)_1$. \square

In fact, to make ${}_L\mathbb{C}\mathbf{sp}(X)$ into a symmetric monoidal double category it suffices for X to have finite coproducts, \mathbf{A} to have finite colimits, and L to preserve coproducts. For a proof see [11]. But in the examples we have studied, \mathbf{A} and X have finite colimits, and L , being a left adjoint, preserves all of these.

Next we take the symmetric monoidal double category ${}_L\mathbb{C}\mathbf{sp}(X)$ and water it down, obtaining first a symmetric monoidal bicategory and then a symmetric monoidal category.

Corollary 3.10. *If \mathbf{A} and X have finite colimits, $L: \mathbf{A} \rightarrow X$ preserves them, and we choose finite colimits in both \mathbf{A} and X , then the bicategory ${}_L\mathbb{C}\mathbf{sp}(X)$ of Cor. 2.4 becomes symmetric monoidal as follows:*

- the tensor product of objects a_1 and a_2 is their chosen coproduct $a_1 + a_2$ in \mathbf{A} ,
- the unit for the tensor product is the chosen initial object $0_{\mathbf{A}}$ in \mathbf{A} ,
- the tensor product of 1-morphisms is given by

$$\begin{array}{ccc}
\begin{array}{ccc} & x & \\ i \nearrow & & \nwarrow o \\ L(a) & & L(b) \end{array} & \otimes & \begin{array}{ccc} & x' & \\ i' \nearrow & & \nwarrow o' \\ L(a') & & L(b') \end{array} \\
= & & \begin{array}{ccc} & x + x' & \\ i + i' \nearrow & & \nwarrow o + o' \\ L(a + a') & & L(b + b') \end{array}
\end{array}$$

- the tensor product of 2-morphisms is given by

$$\begin{array}{ccc}
 \begin{array}{ccc}
 & x_1 & \\
 i_1 \nearrow & \downarrow & \nwarrow o_1 \\
 L(a_1) & \alpha_1 & L(a'_1) \otimes L(a_2) \\
 i'_1 \searrow & \downarrow & \swarrow o'_1 \\
 & x'_1 &
 \end{array}
 &
 \begin{array}{ccc}
 & x_2 & \\
 i_2 \nearrow & \downarrow & \nwarrow o_2 \\
 L(a_2) & \alpha_2 & L(a'_2) \\
 i'_2 \searrow & \downarrow & \swarrow o'_2 \\
 & x'_2 &
 \end{array}
 & = &
 \begin{array}{ccc}
 & x_1 + x_2 & \\
 i_1 + i_2 \nearrow & \downarrow & \nwarrow o_1 + o_2 \\
 L(a_1 + a_2) & \alpha_1 + \alpha_2 & L(a'_1 + a'_2) \\
 i'_1 + i'_2 \searrow & \downarrow & \swarrow o'_1 + o'_2 \\
 & x'_1 + x'_2 &
 \end{array}
 \end{array}$$

- the associators, unitors, symmetries, and other structures of a symmetric monoidal bicategory are constructed using the universal properties of binary coproducts and initial objects.

Proof. The definition of a symmetric monoidal bicategory is nicely presented by Stay [33], who recalls how this definition was gradually discovered by a series of authors. Shulman [32] provided a convenient way to construct symmetric monoidal bicategories from symmetric monoidal double categories. He defines a double category \mathbb{D} be isofibrant if every vertical 1-isomorphism has a ‘companion’ and a ‘conjoint’. He proves that if \mathbb{D} is symmetric monoidal and isofibrant, then \mathbf{D} becomes symmetric monoidal in a canonical way.

A **companion** of a vertical 1-morphism $f: a \rightarrow b$ is a horizontal 1-cell $\hat{f}: a \rightarrow b$ equipped with 2-morphisms

$$\begin{array}{ccc}
 a & \xrightarrow{\hat{f}} & b \\
 f \downarrow & \alpha \Downarrow & \downarrow 1 \\
 b & \xrightarrow{U_b} & b
 \end{array}
 \quad \text{and} \quad
 \begin{array}{ccc}
 a & \xrightarrow{U_a} & a \\
 1 \downarrow & \beta \Downarrow & \downarrow f \\
 a & \xrightarrow{\hat{f}} & b
 \end{array}$$

that obey these equations:

$$(1) \quad
 \begin{array}{ccc}
 a & \xrightarrow{U_a} & a \\
 1 \downarrow & \beta \Downarrow & \downarrow f \\
 a & \xrightarrow{\hat{f}} & b \\
 f \downarrow & \alpha \Downarrow & \downarrow 1 \\
 b & \xrightarrow{U_b} & b
 \end{array}
 =
 \begin{array}{ccc}
 a & \xrightarrow{U_a} & a \\
 f \downarrow & \Downarrow U_f & \downarrow f \\
 b & \xrightarrow{U_b} & b
 \end{array}
 \quad \text{and} \quad
 \begin{array}{ccc}
 a & \xrightarrow{U_a} & a & \xrightarrow{\hat{f}} & b \\
 1 \downarrow & \beta \Downarrow f \downarrow & \alpha \Downarrow & \downarrow 1 & \\
 a & \xrightarrow{\hat{f}} & b & \xrightarrow{U_b} & b \\
 1 \downarrow & \lambda_{\hat{f}} \Downarrow & \downarrow 1 & & \\
 a & \xrightarrow{\hat{f}} & b & &
 \end{array}
 =
 \begin{array}{ccc}
 a & \xrightarrow{U_a} & a & \xrightarrow{\hat{f}} & b \\
 1 \downarrow & \rho_f \Downarrow & & \downarrow 1 & \\
 a & \xrightarrow{\hat{f}} & b & &
 \end{array}$$

A **conjoint** of f is a horizontal 1-cell $\check{f}: b \rightarrow a$ that is a companion of f in the ‘horizontal opposite’ of the double category in question. Since ${}_L\mathbf{Csp}(X)$ is its own horizontal opposite, we only need to check the existence of companions.

A vertical 1-isomorphism in ${}_L\mathbf{Csp}(X)$ is an isomorphism $f: a \rightarrow b$ in \mathbf{A} . We take its companion \hat{f} to be the structured cospan

$$L(a) \xrightarrow{L(f)} L(b) \xleftarrow{1} L(b).$$

The unit horizontal 1-cells U_a and U_b are given respectively by

$$L(a) \xrightarrow{1} L(a) \xleftarrow{1} L(a) \quad \text{and} \quad L(b) \xrightarrow{1} L(b) \xleftarrow{1} L(b)$$

and the accompanying 2-morphisms α and β are given by

$$\begin{array}{ccc} L(a) & \xrightarrow{L(f)} & L(b) \xleftarrow{1} L(b) \\ \downarrow L(f) & & \downarrow 1 \quad \downarrow 1 \\ L(b) & \xrightarrow{1} & L(b) \xleftarrow{1} L(b) \end{array} \quad \text{and} \quad \begin{array}{ccc} L(a) & \xrightarrow{1} & L(a) \xleftarrow{1} L(a) \\ \downarrow 1 & & \downarrow L(f) \quad \downarrow L(f) \\ L(a) & \xrightarrow{L(f)} & L(b) \xleftarrow{1} L(b) \end{array}$$

respectively. An easy calculation verifies Eqs. (1). \square

Corollary 3.11. *If \mathbf{A} and \mathbf{X} have finite colimits, $L: \mathbf{A} \rightarrow \mathbf{X}$ preserves them, and we choose binary coproducts and an initial object in \mathbf{A} , then the category ${}_L\mathbf{Csp}(\mathbf{X})$ of Cor. 2.5 becomes symmetric monoidal as follows:*

- the tensor product of objects a_1 and a_2 is their chosen coproduct $a_1 + a_2$ in \mathbf{A} ,
- the unit for the tensor product is the chosen initial object $0_{\mathbf{A}}$ in \mathbf{A} ,
- the tensor product of morphisms is given by

$$\begin{array}{ccc} & x & \\ i \nearrow & & \nwarrow o \\ L(a) & & L(b) \end{array} \otimes \begin{array}{ccc} & x' & \\ i' \nearrow & & \nwarrow o' \\ L(a') & & L(b') \end{array} = \begin{array}{ccc} & x + x' & \\ i + i' \nearrow & & \nwarrow o + o' \\ L(a + a') & & L(b + b') \end{array}$$

where in each case the cospan actually denotes an isomorphism class of cospans,

- the associator, left and right unitors, and symmetry are constructed using the universal properties of binary coproducts and initial objects.

Proof. It can be checked by inspecting the definitions that any symmetric monoidal bicategory \mathbf{B} gives rise to a symmetric monoidal category \mathbf{B} where:

- the objects of \mathbf{B} are those of \mathbf{B} ,
- the morphisms of \mathbf{B} are isomorphism classes of morphisms of \mathbf{B} ,
- the unit object and the tensor product of objects are those of \mathbf{B} ,
- the tensor product of morphisms, the associator, the left and right unitor, and the symmetry of \mathbf{B} arise from those of \mathbf{B} by taking isomorphism classes.

Applying this ‘decategorification’ construction to the symmetric monoidal bicategory ${}_L\mathbf{Csp}(\mathbf{X})$ gives the symmetric monoidal category ${}_L\mathbf{Csp}(\mathbf{X})$. Note that the result is independent of the choice of colimits in either \mathbf{A} or \mathbf{X} , since these are unique up to isomorphism. \square

A hypergraph category is one where each object has the structure of a special commutative Frobenius monoid in a way that is compatible with tensor products but not necessarily preserved by morphisms [13]. Such categories are ubiquitous in network theory, where Frobenius structure allows us to split, join, start and terminate strings in string diagrams [14]. While the definition of hypergraph category may seem awkward at first, Fong and Spivak have clarified this concept using operads [17].

Theorem 3.12. *If \mathbf{A} and \mathbf{X} have finite colimits, $L: \mathbf{A} \rightarrow \mathbf{X}$ preserves them, and we choose binary coproducts and an initial object in \mathbf{A} , then the symmetric monoidal category ${}_L\mathbf{Csp}(\mathbf{X})$ is a hypergraph category where each object $a \in \mathbf{A}$ is a special commutative Frobenius monoid as follows:*

- The multiplication is given by the structured cospan

$$L(a + a) \xrightarrow{L(\nabla)} L(a) \xleftarrow{1} L(a).$$

where $\nabla: a + a \rightarrow a$ is the fold map.

- The unit is given by

$$L(0) \xrightarrow{L(!)} L(a) \xleftarrow{1} L(a).$$

where $!: 0 \rightarrow a$ is the unique morphism.

- The comultiplication is given by

$$L(a) \xrightarrow{1} L(a) \xleftarrow{L(\nabla)} L(a + a).$$

- The counit is given by

$$L(a) \xrightarrow{1} L(a) \xleftarrow{L(!)} L(0).$$

Proof. Whenever $F: \mathbf{C} \rightarrow \mathbf{D}$ is a symmetric monoidal functor bijective on objects and \mathbf{C} is a hypergraph category, there is a unique way to make \mathbf{D} into a hypergraph category such that F is a hypergraph functor. To see this, first note that F equips each object of \mathbf{D} with the structure of a special commutative Frobenius monoid, coming from its structure in \mathbf{C} . These Frobenius structures are compatible with tensor product because they were in \mathbf{C} and F is symmetric monoidal. Thus, \mathbf{D} becomes a hypergraph category. By construction $F: \mathbf{C} \rightarrow \mathbf{D}$ preserves the Frobenius structures on objects, so F is a hypergraph functor. Moreover, the Frobenius structures on objects of \mathbf{D} are uniquely determined by this requirement.

Let $\mathbf{Csp}(\mathbf{A})$ be the symmetric monoidal category whose morphisms are isomorphism classes of cospans in \mathbf{A} . Since L preserves finite colimits, there is a symmetric monoidal functor $F: \mathbf{Csp}(\mathbf{A}) \rightarrow {}_L\mathbf{Csp}(\mathbf{X})$ given as follows:

$$\begin{array}{ccc} & c & \\ & \nearrow i & \nwarrow o \\ a & & b \end{array} \mapsto \begin{array}{ccc} & L(c) & \\ & \nearrow L(i) & \nwarrow L(o) \\ L(a) & & L(b). \end{array}$$

This is bijective on objects, and $\mathbf{Csp}(\mathbf{A})$ is a hypergraph category [13], so ${}_L\mathbf{Csp}(\mathbf{X})$ has a unique hypergraph category structure making F into a hypergraph functor. This is given as in the statement of the theorem. \square

4. MAPS BETWEEN STRUCTURED COSPAN DOUBLE CATEGORIES

In this section we show how to construct maps between structured cospan categories, or bicategories, or double categories. As before, it is best to start with double categories and work our way down. A map between double categories is called a ‘double functor’, and these are defined in Defn. A.3. Suppose that we have structured cospan double categories coming from functors $L: \mathbf{A} \rightarrow \mathbf{X}$ and $L': \mathbf{A}' \rightarrow \mathbf{X}'$, where \mathbf{X} and \mathbf{X}' have pushouts. Then

we get a double functor between these double categories from a diagram of this form:

$$\begin{array}{ccc} \mathbf{A} & \xrightarrow{L} & \mathbf{X} \\ F_0 \downarrow & \alpha \not\cong & \downarrow F_1 \\ \mathbf{A}' & \xrightarrow{L'} & \mathbf{X}' \end{array}$$

where α is a natural isomorphism. We prove this in Thm. 4.2. Furthermore, if all four categories involved have finite colimits and L and L' preserve these, then this double functor is symmetric monoidal—a concept defined in Defn. A.7. We prove this in Thm. 4.3.

Definition 4.1. *Given a 2-category \mathbf{C} and two weak categories \mathbb{D} and \mathbb{D}' in \mathbf{C} , a weak functor $\mathbb{F}: \mathbb{D} \rightarrow \mathbb{D}'$ in \mathbf{C} consists of:*

- a morphism of objects $\mathbb{F}_0: \mathbb{D}_0 \rightarrow \mathbb{D}'_0$,
- a morphism of arrows $\mathbb{F}_1: \mathbb{D}_1 \rightarrow \mathbb{D}'_1$,

such that:

- \mathbb{F} preserves the source and target morphisms: $S' \circ \mathbb{F}_1 = \mathbb{F}_0 \circ S$ and $T' \circ \mathbb{F}_1 = \mathbb{F}_0 \circ T$,
- composition and the identity-assigning morphism are preserved up to 2-isomorphisms \mathbb{F}_\circ and \mathbb{F}_U , respectively:

$$\begin{array}{ccc} \mathbb{D}_1 \times_{\mathbb{D}_0} \mathbb{D}_1 & \xrightarrow{\circ} & \mathbb{D}_1 \\ \mathbb{F}_1 \times_{\mathbb{F}_0} \mathbb{F}_1 \downarrow & \mathbb{F}_\circ \not\cong & \downarrow \mathbb{F}_1 \\ \mathbb{D}'_1 \times_{\mathbb{D}'_0} \mathbb{D}'_1 & \xrightarrow{\circ'} & \mathbb{D}'_1 \end{array} \quad \begin{array}{ccc} \mathbb{D}_0 & \xrightarrow{U} & \mathbb{D}_1 \\ \mathbb{F}_0 \downarrow & \mathbb{F}_U \not\cong & \downarrow \mathbb{F}_1 \\ \mathbb{D}'_0 & \xrightarrow{U'} & \mathbb{D}'_1 \end{array}$$

- the 2-isomorphisms \mathbb{F}_\circ and \mathbb{F}_U satisfy the hexagon and square identities familiar from the definition of a monoidal functor.

A weak functor in **Cat** is the same as a double functor, and one can consult Defn. A.3 to see the hexagon and square identities in this case. We will also need weak functors in **Rex** and **SymMonCat**.

We begin by getting double functors between structured cospan double categories.

Theorem 4.2. *Suppose we have a square in **Cat**:*

$$\begin{array}{ccc} \mathbf{A} & \xrightarrow{L} & \mathbf{X} \\ F_0 \downarrow & \alpha \not\cong & \downarrow F_1 \\ \mathbf{A}' & \xrightarrow{L'} & \mathbf{X}' \end{array}$$

where \mathbf{X} and \mathbf{X}' have chosen pushouts and α is a natural isomorphism. Then there exists a unique double functor $\mathbb{F}: {}_L\mathbf{Csp}(\mathbf{X}) \rightarrow {}_{L'}\mathbf{Csp}(\mathbf{X}')$ such that:

- $\mathbb{F}_0 = F_0$.
- \mathbb{F}_1 acts as follows on objects:

$$L(a) \xrightarrow{i} x \xleftarrow{o} L(b) \quad \mapsto \quad L'(F_0(a)) \xrightarrow{F_1(i)\alpha_a} F_1(x) \xleftarrow{F_1(o)\alpha_b} L'(F_0(b))$$

and as follows on morphisms:

$$\begin{array}{ccc}
L(a) \xrightarrow{i} x \xleftarrow{o} L(b) & & L'(F_0(a)) \xrightarrow{F_1(i)\alpha_a} F_1(x) \xleftarrow{F_1(o)\alpha_b} L'(F_0(b)) \\
L(f) \downarrow \quad \gamma \downarrow \quad \downarrow L(g) & \mapsto & L'(F_0(f)) \downarrow \quad F_1(\gamma) \downarrow \quad \downarrow L'(F_0(g)) \\
L(a') \xrightarrow{i'} x' \xleftarrow{o'} L(b') & & L'(F_0(a')) \xrightarrow{F_1(i')\alpha_{a'}} F_1(x') \xleftarrow{F_1(o')\alpha_{b'}} L'(F_0(b'))
\end{array}$$

- Given composable structured cospans in ${}_L\mathbf{Csp}(X)$:

$$L(a) \xrightarrow{i} x \xleftarrow{o} L(b) \quad L(b) \xrightarrow{i'} y \xleftarrow{o'} L(c)$$

the natural isomorphism $\mathbb{F}_\odot: \mathbb{F}_1(M) \odot \mathbb{F}_1(N) \rightarrow \mathbb{F}_1(M \odot N)$ is given by this map of cospans:

$$\begin{array}{ccc}
L'(F_0(a)) \xrightarrow{\Psi_{j_{F_1(x)}F_1(i)\alpha_a}} F_1(x) +_{L'(F_0(b))} F_1(y) \xleftarrow{\Psi_{j_{F_1(y)}F_1(o')\alpha_a}} L'(F_0(c)) & & \\
1 \downarrow \quad \quad \quad \phi_{M,N} \downarrow \quad \quad \quad 1 \downarrow & & \\
L'(F_0(a)) \xrightarrow{F_1(\psi_{j_x i}\alpha_a)} F_1(x +_{L(b)} y) \xleftarrow{F_1(\psi_{j_y o'}\alpha_a)} L'(F_0(c)) & &
\end{array}$$

Here $j_x: x \rightarrow x+y$ is the natural map into a coproduct, and likewise for $j_y, j_{F_1(x)}, j_{F_1(y)}$, $\psi: x+y \rightarrow x+_{L(b)}y$ is the natural map from a coproduct to a pushout and likewise for Ψ , and $\phi_{M,N}: F_1(x) +_{L'(F_0(b))} F_1(y) \rightarrow F_1(x +_{L(b)} y)$ is given by the composite

$$F_1(x) +_{L'(F_0(b))} F_1(y) \xrightarrow{\text{id} +_{\alpha_b} \text{id}} F_1(x) +_{F_1(L(b))} F_1(y) \xrightarrow{\kappa} F_1(x +_{L(b)} y)$$

where κ is the natural isomorphism arising from F_1 preserving pushouts.

- Given an object $a \in A$, the natural isomorphism $\mathbb{F}_U: U'(\mathbb{F}_0(a)) \rightarrow \mathbb{F}_1(U(a))$ is given by this map of cospans:

$$\begin{array}{ccc}
L'(F_0(a)) \xrightarrow{1} L'(F_0(a)) \xleftarrow{1} L'(F_0(a)) & & \\
1 \downarrow \quad \quad \quad \alpha_a \downarrow \quad \quad \quad 1 \downarrow & & \\
L'(F_0(a)) \xrightarrow{\alpha_a} F_1(L(a)) \xleftarrow{\alpha_a} L'(F_0(a)) & &
\end{array}$$

Proof. The diagram in the definition of \mathbb{F}_\odot commutes as

$$F_1(\psi_{j_x i}\alpha_a) = F_1(\psi)F_{1_{x,y}}j_{F_1(x)}F_1(i)\alpha_a = \phi_{M,N}\Psi_{j_{F_1(x)}F_1(i)\alpha_a}$$

where $F_{1_{x,y}}: F_1(x) + F_1(y) \rightarrow F_1(x+y)$ is the natural isomorphism arising from F_1 preserving binary coproducts. One can check that the natural isomorphisms \mathbb{F}_\odot and \mathbb{F}_U satisfy the left and right unit squares and laxator hexagon of a monoidal functor. \square

Theorem 4.3. Suppose we have a weakly commuting square in \mathbf{Rex} :

$$\begin{array}{ccc}
A & \xrightarrow{L} & X \\
F_0 \downarrow & \alpha \not\cong & \downarrow F_1 \\
A' & \xrightarrow{L'} & X'
\end{array}$$

Then the double functor $\mathbb{F}: {}_L\mathbf{Csp}(X) \rightarrow {}_{L'}\mathbf{Csp}(X')$ is a weak functor between weak category objects in \mathbf{Rex} . Moreover, if we make ${}_L\mathbf{Csp}(X)$ and ${}_{L'}\mathbf{Csp}(X')$ into symmetric monoidal

double categories as in Thm. 3.9, then $\mathbb{F}: {}_L\mathbf{Csp}(X) \rightarrow {}_{L'}\mathbf{Csp}(X')$ can be given the structure of a symmetric monoidal double functor.

Proof. This is a straightforward but lengthy verification. \square

We can then water down this result, obtaining maps between symmetric monoidal bicategories or categories:

Theorem 4.4. A symmetric monoidal double functor $\mathbb{F}: {}_L\mathbf{Csp}(X) \rightarrow {}_{L'}\mathbf{Csp}(X')$ induces a symmetric monoidal functor $\mathbf{F}: {}_L\mathbf{Csp}(X) \rightarrow {}_{L'}\mathbf{Csp}(X')$.

Proof. See Hansen and Shulman [22] for details of how this works, and a proof. \square

Theorem 4.5. A symmetric monoidal functor between bicategories $\mathbf{F}: {}_L\mathbf{Csp}(X) \rightarrow {}_{L'}\mathbf{Csp}(X')$ induces a symmetric monoidal functor between categories $F: {}_L\mathbf{Csp}(X) \rightarrow {}_{L'}\mathbf{Csp}(X')$.

Proof. This is a straightforward decategorification process. \square

5. STRUCTURED VERSUS DECORATED COSPANS

We can illustrate some of the advantages of structured over decorated categories with an example that is fundamental in the study of networks: the double category with open graphs as morphisms. An ‘open graph’ consists of a graph together with maps from two sets into its set of nodes:

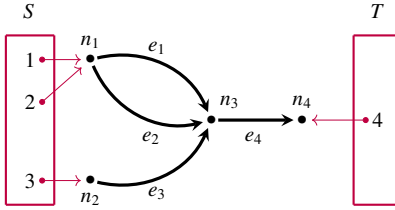

As usual in category theory, by ‘graph’ we mean a directed multigraph or quiver. In what follows we restrict attention to finite graphs because these are the most important in applications.

Definition 5.1. A **graph** is a pair of functions $s, t: E \rightarrow N$ where E and N are finite sets. We call elements of E **edges** and elements of N **nodes**. We say that the edge $e \in E$ has **source** $s(e)$ and **target** $t(e)$, and say that e is an edge **from** $s(e)$ **to** $t(e)$. A **morphism** from the graph $s, t: E \rightarrow N$ to the graph $s', t': E' \rightarrow N'$ is a pair of functions $f: E \rightarrow E'$, $g: N \rightarrow N'$ such that these diagrams commute:

$$\begin{array}{ccc} E & \xrightarrow{s} & N \\ f \downarrow & & \downarrow g \\ E' & \xrightarrow{s'} & N' \end{array} \quad \begin{array}{ccc} E & \xrightarrow{t} & N \\ f \downarrow & & \downarrow g \\ E' & \xrightarrow{t'} & N' \end{array}$$

Definition 5.2. Let **Graph** be the category of graphs and morphisms between them, with composition defined by

$$(f, g) \circ (f', g') = (f \circ f', g \circ g').$$

There is a functor $U: \mathbf{Graph} \rightarrow \mathbf{FinSet}$ that takes a graph $s, t: E \rightarrow N$ to its underlying set of nodes N . This has a left adjoint $L: \mathbf{FinSet} \rightarrow \mathbf{Graph}$ sending any set to the graph with that set of nodes and no edges. Both \mathbf{FinSet} and \mathbf{Graph} have finite colimits, and L ,

being a left adjoint, preserves them. Thus Thm. 3.9 gives us a symmetric monoidal double category ${}_L\mathbf{Csp}(\mathbf{Graph})$ where:

- an object is a finite set,
- a vertical 1-morphism is a function between finite sets,
- a horizontal 1-cell from S to T is an **open graph**, meaning a cospan in \mathbf{Graph} of this form:

$$L(S) \longrightarrow G \longleftarrow L(T),$$

- a 2-morphism is a **map of open graphs**, meaning a commutative diagram in \mathbf{Graph} of this form:

$$\begin{array}{ccccc} L(S) & \longrightarrow & G & \longleftarrow & L(T) \\ L(f) \downarrow & & \downarrow h & & \downarrow L(g) \\ L(S') & \longrightarrow & G' & \longleftarrow & L(T') \end{array}$$

Applying Cor. 3.10 we obtain a symmetric monoidal bicategory ${}_L\mathbf{Csp}(\mathbf{Graph})$ where the objects are finite sets, the morphisms are open graphs, and the 2-morphisms are commutative diagrams in \mathbf{Graph} of this form:

$$\begin{array}{ccccc} & & G & & \\ & i \nearrow & \downarrow h & \nwarrow o & \\ L(S) & & & & L(T) \\ & i' \searrow & \downarrow h & \nwarrow o' & \\ & & G' & & \end{array}$$

We can go further and apply Cor. 3.11 to obtain a symmetric monoidal category ${}_L\mathbf{Csp}(\mathbf{Graph})$ where the objects are finite sets and the morphisms are *isomorphism classes* of open graphs. An isomorphism of open graphs is a diagram as above where h is an isomorphism. Below is a pair of isomorphic open graphs.

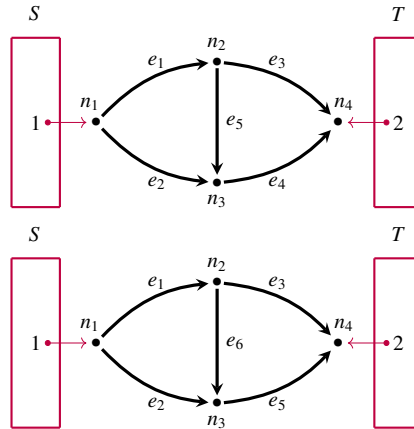

These differ only in that the edges e_4 and e_5 have been renamed e_5 and e_6 . We could also rename nodes, but we chose this example for a specific reason. We can define a similar category of open graphs using the machinery of decorated cospans. The morphisms in this other category are again equivalence classes of open graphs—but with a finer equivalence relation, for which the above open graphs are *not* equivalent! Indeed, this other notion of equivalence between open graphs only allows us to rename nodes, not edges.

Let us examine this in detail. In the decorated cospan approach to open graphs, we start with a lax symmetric monoidal functor $F: \mathbf{FinSet} \rightarrow \mathbf{Set}$ that assigns to any finite set N the collection of all **graph structures** on N , meaning graphs whose set of nodes is N . A small issue presents itself: as described, $F(N)$ is actually a proper class. We can get around this in various ways. For example, we can replace \mathbf{FinSet} by an equivalent small category, and define a finite graph to be a diagram $s, t: E \rightarrow N$ in this category. Henceforth we consider this done.

We then make F into a functor as follows: given any function $f: N \rightarrow N'$, we say that $F(f): F(N) \rightarrow F(N')$ maps $G \in F(N)$, say $G = (s, t: E \rightarrow N)$, to

$$F(f)(G) = (f \circ s, f \circ t: E \rightarrow N').$$

Thus, we use f to rename the nodes and let the edges ‘go along for the ride’. We can also make F into a lax symmetric monoidal functor from $(\mathbf{FinSet}, +)$ to (\mathbf{Set}, \times) , since graph structures on N and N' induce a graph structure on $N + N'$ using the coproduct of graphs.

The theory of decorated cospans thus produces a symmetric monoidal category $FCospan$. An object of $FCospan$ is a finite set, while a morphism is an equivalence class of F -decorated cospans

$$S \xrightarrow{i} N \xleftarrow{o} T, \quad G \in F(N).$$

Such an F -decorated cospan is just another way of describing an open graph from S to T . However, two such F -decorated cospans, say the above one and this:

$$S \xrightarrow{i'} N' \xleftarrow{o'} T, \quad G' \in F'(N),$$

are equivalent iff there is a bijection $f: N \rightarrow N'$ making this diagram commute:

$$\begin{array}{ccc} & N & \\ & \nearrow i & \nwarrow o \\ S & & T \\ & \searrow i' & \swarrow o' \\ & N' & \end{array}$$

and such that $F(f)(G) = G'$. It follows that the graphs $G = (s, t: E \rightarrow N)$ and $G' = (s', t': E' \rightarrow N')$ are isomorphic, but in a specific way: we must have $E' = E$, $s' = f \circ s$, and $t' = f \circ t$. Thus, two open graphs with different edge sets cannot be equivalent!

In short, the decorated cospan category resembles the structured cospan category—but the former has many morphisms for each morphism in the latter, for no particularly useful reason. This ‘redundancy’ is eliminated by the functor $J: FCospan \rightarrow {}_L\mathbf{Csp}(\mathbf{Graph})$ that is the identity on objects and identifies isomorphic open graphs. This functor J is symmetric monoidal, and indeed it becomes a hypergraph functor if we use the standard hypergraph structures on structured and decorated cospan categories.

In applications, we often use a decorated cospan category as the ‘syntax’ for open systems of a particular kind, with the ‘semantics’ given by a symmetric monoidal functor out of this category [14]. Often this functor factors through a structured cospan category that eliminates the redundancy in the morphisms of the structured cospan category. We give some examples in the next section.

On the other hand, there are also useful decorated cospan categories that do not suffer from this redundancy problem. Some appear not to be structured cospan categories. An example is the category of open dynamical systems described in Section 6.3. Furthermore, the theory of decorated cospans plays an important role in the more general theory of

decorated corelations [15, 16]. So, it is also interesting to see if we can improve the theory of decorated cospans a bit to eliminate the redundancy problem when it occurs.

In the case of open graphs, one cheap solution is to use a different lax symmetric monoidal functor, say $F' : (\mathbf{FinSet}, +) \rightarrow (\mathbf{Set}, \times)$, that sends any finite set N to the set of *isomorphism classes* of graph structures on N . Here given two graph structures $s, t : E \rightarrow N$ and $s', t' : E' \rightarrow N$ on N , we define a **morphism** from the first to the second to be a function $f : E \rightarrow E'$ such that these diagrams commute:

$$\begin{array}{ccc} E & \xrightarrow{s} & N \\ f \downarrow & & \downarrow 1 \\ E' & \xrightarrow{s'} & N \end{array} \quad \begin{array}{ccc} E & \xrightarrow{t} & N \\ f \downarrow & & \downarrow 1 \\ E' & \xrightarrow{t'} & N \end{array}$$

We obtain a category of graph structures on N in this way, allowing us to define isomorphism classes of these. One can check that using the theory of decorated cospans we obtain a symmetric monoidal category $F'\mathbf{Cospans}$ that is equivalent to ${}_L\mathbf{Csp}(\mathbf{Graph})$.

However, working with isomorphism classes of graph structures does not give a double category of decorated cospans that is equivalent to ${}_L\mathbf{Csp}(\mathbf{Graph})$. We should really work with the *category* of graph structures, not isomorphism classes of graph structures! A clue to a better approach is to note that the forgetful functor $U : \mathbf{Graph} \rightarrow \mathbf{FinSet}$ is an opfibration, and the category of graph structures on a finite set N is the fiber of this opfibration over N . Thus, the inverse Grothendieck construction gives a pseudofunctor $\tilde{F} : \mathbf{FinSet} \rightarrow \mathbf{Cat}$ sending each finite set N to the category of graph structures on N . Moreover, \tilde{F} is lax symmetric monoidal.

In a forthcoming paper with Christina Vasilakopoulou [1], we extend the theory of decorated cospans to handle this sort of data. That is, given a category \mathbf{A} with finite colimits and a lax symmetric monoidal pseudofunctor $\tilde{F} : (\mathbf{A}, +) \rightarrow (\mathbf{Cat}, \times)$, we construct a symmetric monoidal double category $\tilde{F}\mathbf{Cospans}$ with decorated cospans as horizontal 1-cells. Any such pseudofunctor also gives an opfibration $R : \mathbf{X} \rightarrow \mathbf{A}$ where $\mathbf{X} = \int \tilde{F}$ is defined by the Grothendieck construction. If R has a left adjoint $L : \mathbf{A} \rightarrow \mathbf{X}$, we can also construct the symmetric monoidal double category ${}_L\mathbf{Csp}(\mathbf{X})$. We show that under certain mild conditions, which hold in most examples so far, the symmetric monoidal double categories $\tilde{F}\mathbf{Cospans}$ and ${}_L\mathbf{Csp}(\mathbf{X})$ are equivalent. Thus, we reconcile the theory of structured cospans and the theory of decorated cospan categories by enhancing the latter.

6. APPLICATIONS

Decorated cospans have already been used to study electrical circuits [3], Markov processes [4], and chemical reaction networks [6], while structured cospans have been used to study electrical circuits [2] and Petri nets [5]. Here we revisit this work and show that structured cospans can take the place of decorated cospans in many of these applications. For structured cospans in graph rewriting, see Cicala's thesis [9].

6.1. Circuits. Building on work with Fong [3], Coya, Rebro and the first author have used structured cospans to describe electrical circuits with inputs and outputs [2]. The key idea is to use graphs with labeled edges. The edge labels can stand for resistors with any chosen resistance, capacitors with any chosen capacitance, inductors with any chosen inductance, or other circuit elements such as voltage sources, current sources, transistors, and so on. To study such circuits quite generally we start by fixing any set \mathcal{L} to serve as edge labels.

Definition 6.1. Given a set \mathcal{L} of labels, an \mathcal{L} -graph is a graph $s, t: E \rightarrow N$ equipped with a function $\ell: E \rightarrow \mathcal{L}$. A **morphism** from the \mathcal{L} -graph

$$\mathcal{L} \xleftarrow{\ell} E \begin{array}{c} \xrightarrow{s} \\ \xrightarrow{t} \end{array} N$$

to the \mathcal{L} -graph

$$\mathcal{L} \xleftarrow{\ell'} E' \begin{array}{c} \xrightarrow{s'} \\ \xrightarrow{t'} \end{array} N'$$

is a pair of functions $f: E \rightarrow E'$, $g: N \rightarrow N'$ such that these diagrams commute:

$$\begin{array}{ccc} E & \xrightarrow{s} & N \\ f \downarrow & & \downarrow g \\ E' & \xrightarrow{s'} & N' \end{array} \quad \begin{array}{ccc} E & \xrightarrow{t} & N \\ f \downarrow & & \downarrow g \\ E' & \xrightarrow{t'} & N' \end{array} \quad \begin{array}{ccc} & & E \\ & \swarrow \ell & \downarrow f \\ \mathcal{L} & & E' \\ & \nwarrow \ell' & \end{array}$$

We say such a morphism is **determined by its action on nodes** if $E' = E$, $s' = s \circ f$, and $t' = t \circ f$.

Definition 6.2. We define $\text{Graph}_{\mathcal{L}}$ to be the category of \mathcal{L} -graphs and morphisms between them, with composition given by

$$(f, g) \circ (f', g') = (f \circ f', g \circ g').$$

When $\mathcal{L} = 1$, an \mathcal{L} -graph reduces to a graph and $\text{Graph}_{\mathcal{L}}$ reduces to the category Graph discussed in Sec. 5. We now generalize the key ideas of that section from graphs to \mathcal{L} -graphs. Everything works the same way, but following previous work [2] we call an open \mathcal{L} -graph an ‘ \mathcal{L} -circuit’.

There is a functor $U: \text{Graph}_{\mathcal{L}} \rightarrow \text{FinSet}$ that takes an \mathcal{L} -graph to its underlying set of nodes. This has a left adjoint $L: \text{FinSet} \rightarrow \text{Graph}_{\mathcal{L}}$ sending any set to the \mathcal{L} -graph with that set of nodes and no edges. Both FinSet and $\text{Graph}_{\mathcal{L}}$ have colimits, and L preserves them. Thus Thm. 3.9 gives us a symmetric monoidal double category ${}_{L}\text{Csp}(\text{Graph}_{\mathcal{L}})$. Alternatively, we can use Cor. 3.11 to create a symmetric monoidal category ${}_{L}\text{Csp}(\text{Graph}_{\mathcal{L}})$ where:

- an object is a finite set,
- a morphism is an isomorphism class of \mathcal{L} -circuits, where an \mathcal{L} -circuit is a cospan in $\text{Graph}_{\mathcal{L}}$ of this form:

$$L(S) \longrightarrow G \longleftarrow L(T),$$

and an **isomorphism** of \mathcal{L} -circuits is a commutative diagram in $\text{Graph}_{\mathcal{L}}$ of this form:

$$\begin{array}{ccccc} & & G & & \\ & i \nearrow & \downarrow h & \nwarrow o & \\ L(S) & & & & L(T) \\ & i' \searrow & \downarrow h & \swarrow o' & \\ & & G' & & \end{array}$$

where h is an isomorphism.

This category has a nice universal property, found by Rosebrugh, Sabadini and Walters [30]. To state this, it is convenient to use the language of props.

Recall that a **prop** is a strict symmetric monoidal category whose objects are natural numbers, with tensor product of objects given by addition. An **algebra** of a prop T in a

strict symmetric monoidal category \mathbf{C} is a strict symmetric monoidal functor $A: \mathbb{T} \rightarrow \mathbf{C}$. A **morphism** from the algebra $A: \mathbb{T} \rightarrow \mathbf{C}$ to the algebra $A': \mathbb{T} \rightarrow \mathbf{C}$ is a monoidal natural transformation $\alpha: A \Rightarrow A'$.

Lemma 6.3. *As a symmetric monoidal category, ${}_{\mathcal{L}}\text{Csp}(\text{Graph}_{\mathcal{L}})$ is equivalent to a prop $\text{Circ}_{\mathcal{L}}$.*

Proof. This is [2, Prop. 4.3]. \square

Proposition 6.4. *An algebra of $\text{Circ}_{\mathcal{L}}$ in a strict symmetric monoidal category \mathbf{C} is a special commutative Frobenius monoid in \mathbf{C} whose underlying object x is equipped with an endomorphism $\ell: x \rightarrow x$ for each element $\ell \in \mathcal{L}$. A morphism of algebras of $\text{Circ}_{\mathcal{L}}$ in \mathbf{C} is a morphism of special commutative Frobenius monoids that also preserves all these endomorphisms.*

Proof. This was proved by Rosebrugh, Sabadini and Walters [30], and appears in the above form in [2, Prop. 7.2]. \square

In applications to circuits, the morphisms $\ell: x \rightarrow x$ describe different circuit elements, while the special commutative Frobenius monoid structure is used to split and join wires. This framework is used to study a wide variety of electrical circuits in a paper with Coya and Rebro [2], so the reader can turn there for details. To illustrate the ideas let us consider circuits of resistors, where a label in $\mathcal{L} = (0, \infty)$ serves to indicate the resistance of a resistor. In this case a typical morphism from 1 to 3 in $\text{Circ}_{\mathcal{L}}$ looks like this:

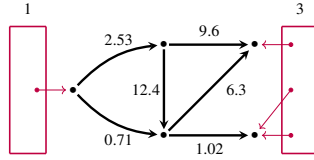

The edges here represent wires, and the positive real numbers labeling them describe the resistance of the resistor on each wire. The points in the boxes represent ‘terminals’: that is, points where we allow ourselves to attach a wire from another circuit. The points in the left box are called ‘inputs’ and the points in the right box are called ‘outputs’. In electrical engineering we associate two real numbers to each terminal, called ‘potential’ and ‘current’. Any circuit of resistors imposes a specific relation between the potentials and currents at its inputs and those at its outputs. All these relations, for all circuits of resistors, can be described using a single functor as follows.

There is a symmetric monoidal category $\text{FinRel}_{\mathbb{R}}$ where the objects are finite-dimensional real vector spaces and a morphism from V to W is a **linear relation** from V to W : that is, a relation $L \subseteq V \times W$ that is a linear subspace of $V \times W$. Composition in $\text{FinRel}_{\mathbb{R}}$ is the usual composition of relations, and the symmetric monoidal structure is provided by direct sum.

There is a symmetric monoidal functor

$$\blacksquare: \text{Circ}_{\mathcal{L}} \rightarrow \text{FinRel}_{\mathbb{R}}$$

sending any circuit of resistors to the relation it imposes between the potentials and currents at its inputs and those at its outputs [2, Sec. 9]. We can construct this using Prop. 6.4, by choosing a special commutative Frobenius monoid in $\text{FinRel}_{\mathbb{R}}$ whose underlying object is equipped with an endomorphism for each resistance $R \in (0, \infty)$. The object $\mathbb{R}^2 \in \text{FinRel}_{\mathbb{R}}$ is a special commutative Frobenius monoid in a standard way [2, Sec. 8], so we choose

this one. To define $\blacksquare: \text{Circ}_{\mathcal{L}} \rightarrow \text{FinRel}_{\mathbb{R}}$ it then suffices to choose for each $R \in (0, \infty)$ a linear relation from \mathbb{R}^2 to itself. We use this:

$$\{(\phi_1, I_1, \phi_2, I_2) : I_1 = I_2, \phi_2 - \phi_1 = RI_1\} \subseteq \mathbb{R}^2 \times \mathbb{R}^2.$$

This expresses two laws of electrical engineering. Kirchoff's current law says that the current flowing into a wire equals the current flowing out: $I_1 = I_2$. Ohm's law says that the voltage across a wire with a resistor on it, $\phi_2 - \phi_1$, is equal to the current flowing through the wire times the resistance R of that resistor.

Earlier work with Fong studied circuits using decorated rather than structured cospans [3]. We make no attempt to explain the results here, but we can quickly summarize one of the technical differences in this approach. For any set \mathcal{L} , define an \mathcal{L} -**graph structure** on a finite set N to be an \mathcal{L} -graph whose set of nodes is N . There is a lax symmetric monoidal functor

$$F_{\mathcal{L}}: (\text{FinSet}, +) \rightarrow (\text{Set}, \times)$$

assigning to each finite set N the collection of all \mathcal{L} -graph structures on N . The theory of decorated cospans thus gives a symmetric monoidal category $F_{\mathcal{L}}\text{Cospan}$ where:

- an object is a finite set,
- a morphism is an equivalence class of \mathcal{L} -circuits

$$L(S) \longrightarrow G \longleftarrow L(T)$$

where two are equivalent if there is a commutative diagram in $\text{Graph}_{\mathcal{L}}$ of this form:

$$\begin{array}{ccc} & G & \\ L(S) & \begin{array}{c} \xrightarrow{i} \\ \downarrow h \\ \xrightarrow{i'} \end{array} & L(T) \\ & G' & \end{array}$$

with h an isomorphism that is determined by its action on nodes in the sense of Defn. 6.2.

The restriction that h be determined by its action on nodes means that isomorphic \mathcal{L} -circuits can give different morphisms in $F_{\mathcal{L}}\text{Cospan}$. However, there is a functor

$$J: F_{\mathcal{L}}\text{Cospan} \rightarrow \text{Circ}_{\mathcal{L}}$$

that eliminates this redundancy: it is the identity on objects, and it maps each open circuit to its isomorphism class.

6.2. Petri nets. Petri nets are widely used by computer scientists as a simple model of distributed, concurrent computation [18, 28]. From the viewpoint of a category theorist, a Petri net is a convenient way to present a simple sort of symmetric monoidal category: namely, a *commutative* monoidal category—a commutative monoid object in \mathbf{Cat} —that is free on some objects and morphisms [27]. Recently Master and the first author studied ‘open’ Petri nets using structured cospans [5]. By composing and tensoring open Petri nets, we can build complicated Petri nets out of smaller pieces. As we shall see, the semantics of open Petri nets is a nice illustration of our main method of describing maps between structured cospan categories, Thm. 4.3.

To define Petri nets we start with the monad for commutative monoids, $\mathbb{N}: \text{Set} \rightarrow \text{Set}$. Concretely, $\mathbb{N}[X]$ is the set of formal finite linear combinations of elements of X with natural number coefficients. The set X naturally includes in $\mathbb{N}[X]$, and for any function $f: X \rightarrow Y$, there is a unique monoid homomorphism $\mathbb{N}[f]: \mathbb{N}[X] \rightarrow \mathbb{N}[Y]$ extending f .

Definition 6.5. We define a **Petri net** to be a pair of functions of the following form:

$$T \begin{array}{c} \xrightarrow{s} \\ \xrightarrow{t} \end{array} \mathbb{N}[S].$$

We call T the set of **transitions**, S the set of **places**, s the **source function** and t the **target function**. A **morphism** from the Petri net $s, t: T \rightarrow \mathbb{N}[S]$ to the Petri net $s', t': T' \rightarrow \mathbb{N}[S']$ is a pair of functions $f: T \rightarrow T', g: S \rightarrow S'$ such that the following diagrams commute:

$$\begin{array}{ccc} T & \xrightarrow{s} & \mathbb{N}[S] \\ f \downarrow & & \downarrow \mathbb{N}[g] \\ T' & \xrightarrow{s'} & \mathbb{N}[S'] \end{array} \quad \begin{array}{ccc} T & \xrightarrow{t} & \mathbb{N}[S] \\ f \downarrow & & \downarrow \mathbb{N}[g] \\ T' & \xrightarrow{t'} & \mathbb{N}[S'] \end{array}$$

Let **Petri** be the category of Petri nets and Petri net morphisms, with composition defined by

$$(f, g) \circ (f', g') = (f \circ f', g \circ g').$$

We can draw a Petri net as a bipartite graph with the species as circles and the transitions as squares:

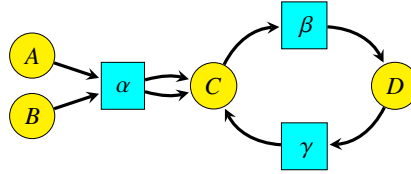

However, we must bear in mind that the edges in this graph are merely a device for describing the source and target of each transition. For example, α above is a transition with $s(\alpha) = A + B$ and $t(\alpha) = 2C$.

Any Petri net has an underlying set of species. Indeed there is a functor $R: \text{Petri} \rightarrow \text{Set}$ that acts as follows on Petri nets and Petri net morphisms:

$$\begin{array}{ccc} T \begin{array}{c} \xrightarrow{s} \\ \xrightarrow{t} \end{array} \mathbb{N}[S] & & S \\ f \downarrow & & \downarrow g \\ T' \begin{array}{c} \xrightarrow{s'} \\ \xrightarrow{t'} \end{array} \mathbb{N}[S] & \mapsto & S' \end{array}$$

To build a structured cospan category we use the left adjoint of R , and we need **Petri** to have finite colimits.

Lemma 6.6. The functor R has a left adjoint $L: \text{Set} \rightarrow \text{Petri}$ defined on sets and functions as follows:

$$\begin{array}{ccc} X & & \emptyset \begin{array}{c} \xrightarrow{\quad} \\ \xrightarrow{\quad} \end{array} \mathbb{N}[X] \\ f \downarrow & \mapsto & \downarrow \quad \quad \downarrow \mathbb{N}[f] \\ Y & & \emptyset \begin{array}{c} \xrightarrow{\quad} \\ \xrightarrow{\quad} \end{array} \mathbb{N}[Y] \end{array}$$

where the unlabeled maps are the unique maps of that type.

Proof. This is [5, Lem. 11]. □

Lemma 6.7. The category **Petri** has small colimits.

Proof. This is [5, Lem. 15]. □

Thanks to these lemmas, Thm. 3.9 gives us a symmetric monoidal double category ${}_L\mathbf{Csp}(\mathbf{Petri})$, or $\mathbb{O}\mathbf{pen}(\mathbf{Petri})$ for short, for which:

- an object is a set,
- a vertical 1-morphism is a function,
- a horizontal 1-cell from X to Y is an **open Petri net**, meaning a cospan in \mathbf{Petri} of this form:

$$L(X) \longrightarrow P \longleftarrow L(Y),$$

- a 2-morphism is a **map of open Petri nets**, meaning a commutative diagram in \mathbf{Petri} of this form:

$$\begin{array}{ccccc} L(X) & \longrightarrow & P & \longleftarrow & L(Y) \\ L(f) \downarrow & & h \downarrow & & \downarrow L(g) \\ L(X') & \longrightarrow & P' & \longleftarrow & L(Y'). \end{array}$$

We can draw an open Petri net as a Petri net with maps from sets X and Y into its set of species:

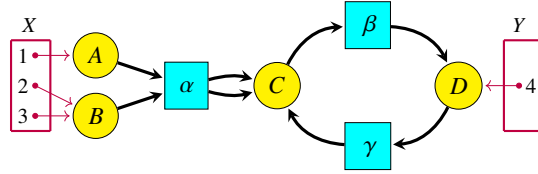

We explained composition and tensoring of open Petri nets using pictures in Sec. 1.

Now we construct a structured cospan category $\mathbb{O}\mathbf{pen}(\mathbf{CMC})$ of ‘open commutative monoidal categories’ and a map

$$\mathbb{O}\mathbf{pen}(F): \mathbb{O}\mathbf{pen}(\mathbf{Petri}) \rightarrow \mathbb{O}\mathbf{pen}(\mathbf{CMC}).$$

Definition 6.8. A **commutative monoidal category** is a strict symmetric monoidal category where all the braidings $a \otimes b \rightarrow b \otimes a$ are identities. A **morphism** of commutative monoidal categories is a strict symmetric monoidal functor.

Definition 6.9. Let \mathbf{CMC} be the category of commutative monoidal categories and morphisms between them.

Any commutative monoidal category has an underlying set of objects. Let $R': \mathbf{CMC} \rightarrow \mathbf{Set}$ be the functor sending any commutative monoidal category to its underlying set of objects and any morphism to its underlying function on objects. To build a structured cospan category of open commutative monoidal categories we use a left adjoint of R' , and we need \mathbf{CMC} to have finite colimits.

Lemma 6.10. The functor R' has a left adjoint $L': \mathbf{Set} \rightarrow \mathbf{CMC}$ sending any set S to the commutative monoidal category with $\mathbb{N}[S]$ as its commutative monoid of objects and with only identity morphisms.

Proof. This is [5, Lem. 9]. □

Lemma 6.11. The category \mathbf{CMC} has small colimits.

Proof. This can be shown in various ways; see [5, Thm. 16] for two. □

Thanks to these lemmas, Thm. 3.9 gives us a symmetric monoidal double category $L'\mathbf{Csp}(\mathbf{CMC})$, or $\mathbf{Open}(\mathbf{CMC})$ for short, in which:

- an object is a set,
- a vertical 1-morphism is a function,
- a horizontal 1-cell from X to Y is an **open commutative monoidal category**, meaning a cospan in \mathbf{CMC} of this form:

$$L'(X) \longrightarrow P \longleftarrow L'(Y),$$

- a 2-morphism is a **map of open commutative monoidal categories**, meaning a commutative diagram in \mathbf{CMC} of this form:

$$\begin{array}{ccccc} L'(X) & \longrightarrow & P & \longleftarrow & L'(Y) \\ L'(f) \downarrow & & h \downarrow & & \downarrow L'(g) \\ L'(X') & \longrightarrow & P' & \longleftarrow & L'(Y'). \end{array}$$

We can turn a Petri net $P = (s, t: T \rightarrow \mathbb{N}[S])$ into a commutative monoidal category FP as follows. We take the commutative monoid of objects $\text{Ob}(FP)$ to be the free commutative monoid on S . We construct the commutative monoid of morphisms $\text{Mor}(FP)$ as follows. First we generate morphisms recursively:

- for every transition $\tau \in T$ we include a morphism $\tau: s(\tau) \rightarrow t(\tau)$;
- for any object a we include a morphism $1_a: a \rightarrow a$;
- for any morphisms $f: a \rightarrow b$ and $g: a' \rightarrow b'$ we include a morphism denoted $f + g: a + a' \rightarrow b + b'$ to serve as their tensor product;
- for any morphisms $f: a \rightarrow b$ and $g: b \rightarrow c$ we include a morphism $g \circ f: a \rightarrow c$ to serve as their composite.

Then we mod out by an equivalence relation on morphisms that imposes the laws of a commutative monoidal category, obtaining the commutative monoid $\text{Mor}(FP)$.

Let $F: \text{Petri} \rightarrow \mathbf{CMC}$ be the functor that makes the following assignments on Petri nets and morphisms:

$$\begin{array}{ccc} T \begin{array}{c} \xrightarrow{s} \\ \xrightarrow{t} \end{array} \mathbb{N}[S] & & FP \\ f \downarrow & \mathbb{N}[g] \downarrow & \downarrow F(f,g) \\ T' \begin{array}{c} \xrightarrow{s'} \\ \xrightarrow{t'} \end{array} \mathbb{N}[S'] & \mapsto & FP'. \end{array}$$

Here $F(f, g): FP \rightarrow FP'$ is defined on objects by $\mathbb{N}[g]$. On morphisms, $F(f, g)$ is the unique map extending f that preserves identities, composition, and the tensor product.

Lemma 6.12. *The functor*

$$F: \text{Petri} \rightarrow \mathbf{CMC}$$

is a left adjoint.

Proof. This is a special case of [26, Thm. 5.1]. □

We thus obtain a triangle of left adjoint functors, which commutes up to natural isomorphism:

$$\begin{array}{ccc}
 \text{Set} & \xrightarrow{L} & \text{Petri} \\
 & \searrow \alpha \not\cong & \downarrow F \\
 & & \text{CMC} \\
 & \swarrow L' & \\
 & &
 \end{array}$$

As a result we obtain:

Theorem 6.13. *There is a symmetric monoidal double functor*

$$\mathbb{O}pen(F): \mathbb{O}pen(\text{Petri}) \rightarrow \mathbb{O}pen(\text{CMC})$$

that is the identity on objects and vertical 1-morphisms and makes the following assignments on horizontal 1-cells and 2-morphisms:

$$\begin{array}{ccc}
 \begin{array}{ccccc}
 LX & \xrightarrow{i} & P & \xleftarrow{o} & LY \\
 \downarrow Lf & & \downarrow \alpha & & \downarrow Lg \\
 LX' & \xrightarrow{i'} & P' & \xleftarrow{o'} & LY'
 \end{array} & \mapsto &
 \begin{array}{ccccc}
 L'X & \xrightarrow{Fi} & FP & \xleftarrow{Fo} & L'Y \\
 \downarrow L'f & & \downarrow F\alpha & & \downarrow L'g \\
 L'X' & \xrightarrow{Fi'} & FP' & \xleftarrow{Fo'} & L'Y'
 \end{array}
 \end{array}$$

Proof. The triangle above is a degenerate case of the square studied in Thm. 4.2:

$$\begin{array}{ccc}
 \text{Set} & \xrightarrow{L} & \text{Petri} \\
 \downarrow 1 & \alpha \not\cong & \downarrow F \\
 \text{Set} & \xrightarrow{L'} & \text{CMC}
 \end{array}$$

and applying that theorem we obtain the desired result. \square

In the language of computer science, the commutative monoidal category FP provides an ‘operational semantics’ for the Petri net P : morphisms in this category are processes allowed by the Petri net. The above theorem says that this semantics is compositional. That is, if we write P as a composite (or tensor product) of smaller open Petri nets, FP will be the composite (or tensor product) of the corresponding open commutative monoidal categories.

6.3. Petri nets with rates. Chemists often describe collections of chemical reactions using ‘reaction networks’. They have a standard formalism for obtaining a dynamical system from any reaction network where each reaction is labeled by a positive real number called its ‘rate constant’ [23]. Reaction networks equipped with rate constants are equivalent to Petri nets where every transition is labeled by a positive real number. These are sometimes called ‘stochastic’ Petri nets, and they are used not only in chemistry but also biology and other fields [21, 25].

Pollard and the first author studied ‘open’ reaction networks using decorated cospans [6]. Here we show how to translate some of that work into the language of structured cospans. We need a finiteness condition in many applications, so we include that from the start.

Definition 6.14. A **Petri net with rates** is a Petri net $s, t: T \rightarrow \mathbb{N}[S]$ where S and T are finite sets, together with a function $r: T \rightarrow (0, \infty)$. We call $r(\tau)$ the **rate constant** of the transition $\tau \in T$. A **morphism** from the Petri net with rates

$$(0, \infty) \xleftarrow{r} T \xrightleftharpoons[s]{t} \mathbb{N}[S]$$

to the Petri net with rates

$$(0, \infty) \xleftarrow{r'} T' \xrightleftharpoons[s']{t'} \mathbb{N}[S']$$

is a morphism $f: T \rightarrow T', g: S \rightarrow S'$ of the underlying Petri nets such that the following diagram also commutes:

$$\begin{array}{ccc} & T & \\ & \swarrow r & \downarrow f \\ (0, \infty) & & T' \\ & \nwarrow r' & \end{array}$$

Let Petri_r be the category of Petri nets with rates and morphisms between them, with composition defined by

$$(f, g) \circ (f', g') = (f \circ f', g \circ g').$$

There is a functor $R: \text{Petri}_r \rightarrow \text{Set}$ that sends any Petri net with rates to its underlying set of species:

$$\begin{array}{ccc} (0, \infty) \xleftarrow{r} T \xrightleftharpoons[s]{t} \mathbb{N}[S] & & S \\ \downarrow 1 & \downarrow f & \downarrow \mathbb{N}[g] \quad \mapsto \quad \downarrow g \\ (0, \infty) \xleftarrow{r'} T' \xrightleftharpoons[s']{t'} \mathbb{N}[S] & & S' \end{array}$$

To build a structured cospan category we use the left adjoint of R , and we need Petri_r to have finite colimits.

Lemma 6.15. The functor R has a left adjoint $L: \text{Set} \rightarrow \text{Petri}_r$ defined on sets and functions as follows:

$$\begin{array}{ccc} X & (0, \infty) \xleftarrow{r} \emptyset \xrightleftharpoons{\quad} \mathbb{N}[X] & \\ \downarrow f & \downarrow 1 & \downarrow \mathbb{N}[f] \\ Y & (0, \infty) \xleftarrow{r'} \emptyset \xrightleftharpoons{\quad} \mathbb{N}[Y] & \end{array}$$

where the unlabeled maps are the unique maps of that type.

Proof. This is easily checked from the definitions. \square

Lemma 6.16. The category Petri_r has finite colimits.

Proof. Note that Petri_r is equivalent to the comma category f/g where $f: \text{FinSet} \rightarrow \text{FinSet}$ is the identity and $g: \text{FinSet} \rightarrow \text{FinSet}$ is $(0, \infty) \times \mathbb{N}[-]^2$. Whenever A and B have finite colimits, $f: A \rightarrow C$ preserves finite colimits and $g: B \rightarrow C$ is any functor, then f/g has finite colimits [8, Thm. 3, Sec. 5.2]. \square

As a consequence of these lemmas, Cor. 3.11 gives a symmetric monoidal category ${}_L\text{Csp}(\text{Petri}_r)$, or $\text{Open}(\text{Petri}_r)$ for short, for which:

- an object is a finite set,

- a morphism is an isomorphism class of open Petri nets with rates, where an **open Petri net with rates** is a cospan in \mathbf{Petri}_r of this form:

$$L(X) \longrightarrow P \longleftarrow L(Y),$$

and an **isomorphism** of such is a commutative diagram in \mathbf{Petri}_r of this form:

$$\begin{array}{ccc} & P & \\ i \nearrow & & \nwarrow o \\ L(X) & & L(Y) \\ i' \searrow & & \swarrow o' \\ & P' & \\ & h \downarrow & \end{array}$$

where h is an isomorphism.

Pollard and the first author [6] used decorated cospans to construct a symmetric monoidal category \mathbf{RxNet} equivalent to $\mathbf{Open}(\mathbf{Petri}_r)$. They avoided the ‘redundancy problem’ using the trick explained in Sec. 5. Namely, they used a lax symmetric monoidal functor $F': (\mathbf{FinSet}, +) \rightarrow (\mathbf{Set}, \times)$ sending any finite set S to the set of *isomorphism classes* of Petri nets with rates having S as their set of species.

Pollard and the first author then constructed a symmetric monoidal functor from \mathbf{RxNet} to a category \mathbf{Dynam} of ‘open dynamical systems’, and a further symmetric monoidal functor from \mathbf{Dynam} assigning to each open dynamical system the relation between its input and outputs that holds in steady state. Thanks to the equivalence between \mathbf{RxNet} and $\mathbf{Open}(\mathbf{Petri}_r)$, these functors can also be construed as functors out of the structured cospan category $\mathbf{Open}(\mathbf{Petri}_r)$. Thus, structured cospans can be used to study both the dynamics and the steady states of open systems of chemical reactions.

APPENDIX A. DOUBLE CATEGORIES

What follows is a brief review of double categories. A more detailed exposition can be found in the work of Grandis and Paré [19, 20], and for monoidal double categories the work of Hansen and Shulman [22, 31, 32]. We use ‘double category’ to mean what earlier authors called a ‘pseudo double category’.

Definition A.1. A *double category* is a weak category in \mathbf{Cat} . More explicitly, a double category \mathbb{D} consists of:

- a **category of objects** \mathbb{D}_0 and a **category of arrows** \mathbb{D}_1 ,
- **source and target functors**

$$S, T: \mathbb{D}_1 \rightarrow \mathbb{D}_0,$$

an **identity-assigning functor**

$$U: \mathbb{D}_0 \rightarrow \mathbb{D}_1,$$

and a **composition functor**

$$\odot: \mathbb{D}_1 \times_{\mathbb{D}_0} \mathbb{D}_1 \rightarrow \mathbb{D}_1$$

where the pullback is taken over $\mathbb{D}_1 \xrightarrow{T} \mathbb{D}_0 \xleftarrow{S} \mathbb{D}_1$, such that

$$S(U_A) = A = T(U_A), \quad S(M \odot N) = SN, \quad T(M \odot N) = TM,$$

- natural isomorphisms called the **associator**

$$\alpha_{N,N',N''} : (N \odot N') \odot N'' \xrightarrow{\sim} N \odot (N' \odot N''),$$

the **left unitor**

$$\lambda_N : U_{T(N)} \odot N \xrightarrow{\sim} N,$$

and the **right unitor**

$$\rho_N : N \odot U_{S(N)} \xrightarrow{\sim} N$$

such that $S(\alpha), S(\lambda), S(\rho), T(\alpha), T(\lambda)$ and $T(\rho)$ are all identities and such that the standard coherence axioms hold: the pentagon identity for the associator and the triangle identity for the left and right unitor.

If α, λ and ρ are identities, we call \mathbb{D} a **strict double category**.

Objects of \mathbb{D}_0 are called **objects** and morphisms in \mathbb{D}_0 are called **vertical 1-morphisms**. Objects of \mathbb{D}_1 are called **horizontal 1-cells** of \mathbb{D} and morphisms in \mathbb{D}_1 are called **2-morphisms**. A morphism $\alpha : M \rightarrow N$ in \mathbb{D}_1 can be drawn as a square:

$$\begin{array}{ccc} a & \xrightarrow{M} & b \\ f \downarrow & \Downarrow \alpha & \downarrow g \\ c & \xrightarrow{N} & d \end{array}$$

where $f = S\alpha$ and $g = T\alpha$. If f and g are identities we call α a **globular 2-morphism**. These give rise to a bicategory:

Definition A.2. Let \mathbb{D} be a double category. Then the **horizontal bicategory** of \mathbb{D} , denoted $H(\mathbb{D})$, is the bicategory consisting of objects, horizontal 1-cells and globular 2-morphisms of \mathbb{D} .

We have maps between double categories, and also transformations between maps:

Definition A.3. Let \mathbb{A} and \mathbb{B} be double categories. A **double functor** $\mathbb{F} : \mathbb{A} \rightarrow \mathbb{B}$ consists of:

- functors $\mathbb{F}_0 : \mathbb{A}_0 \rightarrow \mathbb{B}_0$ and $\mathbb{F}_1 : \mathbb{A}_1 \rightarrow \mathbb{B}_1$ obeying the following equations:

$$S \circ \mathbb{F}_1 = \mathbb{F}_0 \circ S, \quad T \circ \mathbb{F}_1 = \mathbb{F}_0 \circ T,$$

- natural isomorphisms called the **composition comparison**:

$$\phi(N, N') : \mathbb{F}_1(N) \odot \mathbb{F}_1(N') \xrightarrow{\sim} \mathbb{F}_1(N \odot N')$$

and the **unit comparison**:

$$\phi_A : U_{\mathbb{F}_0(A)} \xrightarrow{\sim} \mathbb{F}_1(U_A)$$

whose components are globular 2-morphisms,

such that the following diagram commutes:

- a diagram expressing compatibility with the associator:

$$\begin{array}{ccc}
(\mathbb{F}_1(N) \odot \mathbb{F}_1(N')) \odot \mathbb{F}_1(N'') & \xrightarrow{\alpha} & \mathbb{F}_1(N) \odot (\mathbb{F}_1(N') \odot \mathbb{F}_1(N'')) \\
\downarrow \phi(N, N') \odot 1 & & \downarrow 1 \odot \phi(N', N'') \\
\mathbb{F}_1(N \odot N') \odot \mathbb{F}_1(N'') & & \mathbb{F}_1(N) \odot \mathbb{F}_1(N' \odot N'') \\
\downarrow \phi(N \odot N', N'') & & \downarrow \phi(N, N' \odot N'') \\
\mathbb{F}_1((N \odot N') \odot N'') & \xrightarrow{\mathbb{F}_1(\alpha)} & \mathbb{F}_1(N \odot (N' \odot N''))
\end{array}$$

- two diagrams expressing compatibility with the left and right unitors:

$$\begin{array}{ccc}
\mathbb{F}_1(N) \odot U_{\mathbb{F}_0(A)} & \xrightarrow{\rho_{\mathbb{F}_1(N)}} & \mathbb{F}_1(N) \\
\downarrow 1 \odot \phi_A & & \uparrow \mathbb{F}_1(\rho_N) \\
\mathbb{F}_1(N) \odot \mathbb{F}_1(U_A) & \xrightarrow{\phi(N, U_A)} & \mathbb{F}_1(N \odot U_A)
\end{array}$$

$$\begin{array}{ccc}
U_{\mathbb{F}_0(B)} \odot \mathbb{F}_1(N) & \xrightarrow{\lambda_{\mathbb{F}_1(N)}} & \mathbb{F}_1(N) \\
\downarrow \phi_B \odot 1 & & \uparrow \mathbb{F}_1(\lambda_N) \\
\mathbb{F}_1(U_B) \odot \mathbb{F}_1(N) & \xrightarrow{\phi(U_B, N)} & \mathbb{F}_1(U_B \odot N)
\end{array}$$

If the 2-morphisms $\phi(N, N')$ and ϕ_A are identities for all $N, N' \in \mathbb{A}_1$ and $A \in \mathbb{A}_0$, we say $\mathbb{F}: \mathbb{A} \rightarrow \mathbb{B}$ is a **strict** double functor. If on the other hand we drop the requirement that these 2-morphisms be invertible, we call \mathbb{F} a **lax** double functor.

Definition A.4. Let $\mathbb{F}: \mathbb{A} \rightarrow \mathbb{B}$ and $\mathbb{G}: \mathbb{A} \rightarrow \mathbb{B}$ be lax double functors. A **transformation** $\beta: \mathbb{F} \Rightarrow \mathbb{G}$ consists of natural transformations $\beta_0: \mathbb{F}_0 \Rightarrow \mathbb{G}_0$ and $\beta_1: \mathbb{F}_1 \Rightarrow \mathbb{G}_1$ (both usually written as β) such that

- $S(\beta_M) = \beta_{S_M}$ and $T(\beta_M) = \beta_{T_M}$ for any $M \in \mathbb{A}_1$,
- β preserves the composition comparison, and
- β preserves the unit comparison.

Shulman defines a 2-category **Dbl** of double categories, double functors, and transformations [32]. This has finite products. In any 2-category with finite products we can define a pseudomonoid [12].

Definition A.5. A **monoidal double category** is a pseudomonoid in **Dbl**. Explicitly, a monoidal double category is a double category equipped with double functors $\otimes: \mathbb{D} \times \mathbb{D} \rightarrow \mathbb{D}$ and $I: 1 \rightarrow \mathbb{D}$ where 1 is the terminal double category, along with invertible transformations called the **associator**:

$$\alpha: \otimes \circ (1_{\mathbb{D}} \times \otimes) \Rightarrow \otimes \circ (\otimes \times 1_{\mathbb{D}}),$$

left unitor:

$$\ell: \otimes \circ (1_{\mathbb{D}} \times I) \Rightarrow 1_{\mathbb{D}},$$

and **right unitor**:

$$r: \otimes \circ (I \times 1_{\mathbb{D}}) \Rightarrow 1_{\mathbb{D}}$$

satisfying the pentagon axiom and triangle axioms.

This definition neatly packages a large quantity of information. In detail, a double category \mathbb{D} is monoidal if:

- (1) \mathbb{D}_0 and \mathbb{D}_1 are both monoidal categories (with tensor product denoted \otimes , associator a , left unitor ℓ and right unitor r).
- (2) If I is the monoidal unit of \mathbb{D}_0 , then U_I is the monoidal unit of \mathbb{D}_1 .
- (3) The functors S and T are strict monoidal.
- (4) \otimes is a double functor. In other words, it is equipped with invertible globular 2-morphisms

$$\chi: (M_1 \otimes N_1) \odot (M_2 \otimes N_2) \xrightarrow{\sim} (M_1 \odot M_2) \otimes (N_1 \odot N_2)$$

$$\mu: U_{A \otimes B} \xrightarrow{\sim} (U_A \otimes U_B)$$

making these diagrams commute:

$$\begin{array}{ccc} ((M_1 \otimes N_1) \odot (M_2 \otimes N_2)) \odot (M_3 \otimes N_3) & \xrightarrow{\chi \circ 1} & ((M_1 \odot M_2) \otimes (N_1 \odot N_2)) \odot (M_3 \otimes N_3) \\ \downarrow \alpha & & \downarrow \chi \\ (M_1 \otimes N_1) \odot ((M_2 \otimes N_2) \odot (M_3 \otimes N_3)) & & ((M_1 \odot M_2) \odot M_3) \otimes ((N_1 \odot N_2) \odot N_3) \\ \downarrow 1 \odot \chi & & \downarrow a \otimes \alpha \\ (M_1 \otimes N_1) \odot ((M_2 \odot M_3) \otimes (N_2 \odot N_3)) & \xrightarrow{\chi} & (M_1 \odot (M_2 \odot M_3)) \otimes (N_1 \odot (N_2 \odot N_3)) \end{array}$$

$$\begin{array}{ccc} (M \otimes N) \odot U_{C \otimes D} & \xrightarrow{1 \odot \mu} & (M \otimes N) \odot (U_C \otimes U_D) \\ \downarrow \rho & & \downarrow \chi \\ M \otimes N & \xleftarrow{\rho \otimes \rho} & (M \odot U_C) \otimes (N \odot U_D) \end{array}$$

$$\begin{array}{ccc} U_{A \otimes B} \odot (M \otimes N) & \xrightarrow{\mu \circ 1} & (U_A \otimes U_B) \odot (M \otimes N) \\ \downarrow \lambda & & \downarrow \chi \\ M \otimes N & \xleftarrow{\lambda \otimes \lambda} & (U_A \odot M) \otimes (U_B \odot N) \end{array}$$

- (5) The associator and left and right unitors for the tensor product in \mathbb{D} are transformations between double functors. In other words, the following six diagrams commute:

$$\begin{array}{ccc} ((M_1 \otimes N_1) \otimes P_1) \odot ((M_2 \otimes N_2) \otimes P_2) & \xrightarrow{a \circ a} & (M_1 \otimes (N_1 \otimes P_1)) \odot (M_2 \otimes (N_2 \otimes P_2)) \\ \downarrow \chi & & \downarrow \chi \\ ((M_1 \otimes N_1) \odot (M_2 \otimes N_2)) \otimes (P_1 \odot P_2) & & (M_1 \odot M_2) \otimes ((N_1 \otimes P_1) \odot (N_2 \otimes P_2)) \\ \downarrow \chi \circ 1 & & \downarrow 1 \otimes \chi \\ ((M_1 \odot M_2) \otimes (N_1 \odot N_2)) \otimes (P_1 \odot P_2) & \xrightarrow{a} & (M_1 \odot M_2) \otimes ((N_1 \odot N_2) \otimes (P_1 \odot P_2)) \end{array}$$

$$\begin{array}{ccc}
U_{(A \otimes B) \otimes C} & \xrightarrow{U_a} & U_{A \otimes (B \otimes C)} \\
\downarrow \mu & & \downarrow \mu \\
U_{A \otimes B} \otimes U_C & & U_A \otimes U_{B \otimes C} \\
\downarrow \mu \otimes 1 & & \downarrow 1 \otimes \mu \\
(U_A \otimes U_B) \otimes U_C & \xrightarrow{a} & U_A \otimes (U_B \otimes U_C)
\end{array}$$

$$\begin{array}{ccc}
(U_I \otimes M) \odot (U_I \otimes N) & \xrightarrow{x} & (U_I \odot U_I) \otimes (M \odot N) \\
\downarrow \ell \otimes \ell & & \downarrow 1 \otimes 1 \\
M \odot N & \xleftarrow{\ell} & U_I \otimes (M \odot N)
\end{array}$$

$$\begin{array}{ccc}
U_{I \otimes A} & \xrightarrow{\mu} & U_I \otimes U_A \\
& \searrow U_\ell & \downarrow \ell \\
& & U_A
\end{array}$$

$$\begin{array}{ccc}
(M \otimes U_I) \odot (N \otimes U_I) & \xrightarrow{x} & (M \odot N) \otimes (U_I \odot U_I) \\
\downarrow r \circ r & & \downarrow 1 \otimes \rho \\
M \odot N & \xleftarrow{r} & (M \odot N) \otimes U_I
\end{array}$$

$$\begin{array}{ccc}
U_{A \otimes I} & \xrightarrow{\mu} & U_A \otimes U_I \\
& \searrow U_r & \downarrow r \\
& & U_A
\end{array}$$

Definition A.6. A **braided monoidal double category** is a braided pseudomonoid in **Dbl**. Explicitly, it is a monoidal double category equipped with an invertible transformation

$$\beta: \otimes \Rightarrow \otimes \circ \tau$$

called the **braiding**, where $\tau: \mathbb{D} \times \mathbb{D} \rightarrow \mathbb{D} \times \mathbb{D}$ is the twist double functor sending pairs in the object and arrow categories to the same pairs in the opposite order. The braiding is required to satisfy the two usual hexagon identities. If the braiding is self-inverse we say that \mathbb{D} is a **symmetric monoidal double category**.

Definition A.7. A **monoidal lax double functor** $\mathbb{F}: \mathbb{C} \rightarrow \mathbb{C}'$ between monoidal double categories \mathbb{C} and \mathbb{C}' is a lax double functor $\mathbb{F}: \mathbb{C} \rightarrow \mathbb{C}'$ such that

- \mathbb{F}_0 and \mathbb{F}_1 are monoidal functors,
- $S' \mathbb{F}_1 = \mathbb{F}_0 S$ and $T' \mathbb{F}_1 = \mathbb{F}_0 T$ are equations between monoidal functors, and
- the composition and unit comparisons $\phi(N_1, N_2): \mathbb{F}_1(N_1) \odot \mathbb{F}_1(N_2) \rightarrow \mathbb{F}_1(N_1 \odot N_2)$ and $\phi_A: U_{\mathbb{F}_0(A)} \rightarrow \mathbb{F}_1(U_A)$ are monoidal natural transformations.

The monoidal lax double functor is **braided** if \mathbb{F}_0 and \mathbb{F}_1 are braided monoidal functors and **symmetric** if they are symmetric monoidal functors.

We also have transformations between double functors:

Definition A.8. A double transformation $\Phi: \mathbb{F} \Rightarrow \mathbb{G}$ between two double functors $\mathbb{F}: \mathbb{X} \rightarrow \mathbb{X}'$ and $\mathbb{G}: \mathbb{X} \rightarrow \mathbb{X}'$ consists of two natural transformations $\Phi_0: \mathbb{F}_0 \Rightarrow \mathbb{G}_0$ and $\Phi_1: \mathbb{F}_1 \Rightarrow \mathbb{G}_1$ such that for all horizontal 1-cells M we have that $S(\Phi_{1M}) = \Phi_{0S(M)}$ and $T(\Phi_{1M}) = \Phi_{0T(M)}$ and for composable horizontal 1-cells M and N , we have

$$\begin{array}{ccc}
 \begin{array}{ccc}
 \mathbb{F}(x) & \xrightarrow{\mathbb{F}(M)} & \mathbb{F}(y) & \xrightarrow{\mathbb{F}(N)} & \mathbb{F}(z) \\
 \downarrow 1 & & \Downarrow \mathbb{F}_{M,N} & & \downarrow 1 \\
 \mathbb{F}(x) & \xrightarrow{\mathbb{F}(M \circ N)} & \mathbb{F}(z) & & \\
 \downarrow \Phi_{0x} & & \Downarrow \Phi_{1M \circ N} & & \downarrow \Phi_{0z} \\
 \mathbb{G}(x) & \xrightarrow{\mathbb{G}(M \circ N)} & \mathbb{G}(z) & &
 \end{array} & = &
 \begin{array}{ccc}
 \mathbb{F}(x) & \xrightarrow{\mathbb{F}(M)} & \mathbb{F}(y) & \xrightarrow{\mathbb{F}(N)} & \mathbb{F}(z) \\
 \downarrow \Phi_{0x} & & \Downarrow \Phi_{1M} & \Phi_{0y} & \Downarrow \Phi_{1N} & \Phi_{0z} \\
 \mathbb{G}(x) & \xrightarrow{\mathbb{G}(M)} & \mathbb{G}(y) & \xrightarrow{\mathbb{G}(N)} & \mathbb{G}(z) \\
 \downarrow 1 & & \Downarrow \mathbb{G}_{M,N} & & \downarrow 1 \\
 \mathbb{G}(x) & \xrightarrow{\mathbb{G}(M \circ N)} & \mathbb{G}(z) & &
 \end{array} \\
 \\
 \begin{array}{ccc}
 \mathbb{F}(x) & \xrightarrow{U_{\mathbb{F}(x)}} & \mathbb{F}(x) \\
 \downarrow 1 & & \Downarrow \mathbb{F}_U \\
 \mathbb{F}(x) & \xrightarrow{\mathbb{F}(U_x)} & \mathbb{F}(x) \\
 \downarrow \Phi_{0x} & & \Downarrow \Phi_{1U_x} \\
 \mathbb{G}(x) & \xrightarrow{\mathbb{G}(U_x)} & \mathbb{G}(x)
 \end{array} & = &
 \begin{array}{ccc}
 \mathbb{F}(x) & \xrightarrow{U_{\mathbb{F}(x)}} & \mathbb{F}(x) \\
 \downarrow \Phi_{0x} & & \Downarrow U_{\Phi_{0x}} \\
 \mathbb{G}(x) & \xrightarrow{U_{\mathbb{G}(x)}} & \mathbb{G}(x) \\
 \downarrow 1 & & \Downarrow \mathbb{G}_U \\
 \mathbb{G}(x) & \xrightarrow{\mathbb{G}(U_x)} & \mathbb{G}(x)
 \end{array}
 \end{array}$$

We call Φ_0 the **object component** and Φ_1 the **arrow component** of the double transformation Φ .

One can also define monoidal, braided monoidal and symmetric monoidal double transformations, but since we do not use these, we refer the reader to Hansen and Shulman for the details [22, Defn. 2.15].

REFERENCES

- [1] J. C. Baez, K. Courser and C. Vasilakopoulou, Structured versus decorated cospans. Manuscript in preparation. (Referred to on page 28.)
- [2] J. C. Baez, B. Coya and F. Rebro, Props in circuit theory, *Theor. Appl. Categ.* **33** (2018), 727–783. Available as [arXiv:1707.08321](https://arxiv.org/abs/1707.08321). (Referred to on page 28, 29, 30.)
- [3] J. C. Baez and B. Fong, A compositional framework for passive linear networks, *Theor. Appl. Categ.* **33** (2018), 1158–1222. Available as [arXiv:1504.05625](https://arxiv.org/abs/1504.05625). (Referred to on page 28, 31.)
- [4] J. C. Baez, B. Fong and B. Pollard, A compositional framework for Markov processes, *Jour. Math. Phys.* **57** (2016), 033301. Available as [arXiv:1508.06448](https://arxiv.org/abs/1508.06448). (Referred to on page 28.)
- [5] J. C. Baez and J. Master, Open Petri nets. Available as [arXiv:1808.05415](https://arxiv.org/abs/1808.05415). (Referred to on page 1, 28, 31, 32, 33.)
- [6] J. C. Baez and B. Pollard, A compositional framework for chemical reaction networks, *Rev. Math. Phys.* **29** (2017), 1750028. (Referred to on page 28, 35, 37.)
- [7] J. Bénabou, Introduction to bicategories, in *Reports of the Midwest Category Seminar*, Lecture Notes in Mathematics **47**, Springer, Berlin, 1967, pp. 1–77. (Referred to on page .)
- [8] R. M. Burstall and D. E. Rydeheard, *Computational Category Theory*, Prentice Hall, Englewood Cliffs, 1988. (Referred to on page 36.)
- [9] D. Cicala, *Rewriting Structured Cospans: A Syntax For Open Systems*, Ph.D. thesis, Department of Mathematics, U. C. Riverside, 2019. Available at [arXiv:1906.05443](https://arxiv.org/abs/1906.05443). (Referred to on page 28.)
- [10] K. Courser, A bicategory of decorated cospans, *Theor. Appl. Categ.* **32** (2017), 995–1027. Also available as [arXiv:1605.08100](https://arxiv.org/abs/1605.08100). (Referred to on page 5, 7.)

- [11] K. Courser, *Open Systems: a Double Categorical Perspective*, Ph.D. thesis, Department of Mathematics, U. C. Riverside, 2019. Available at http://math.ucr.edu/home/baez/thesis_courser.pdf. (Referred to on page 12, 19.)
- [12] B. Day and R. Street, Monoidal bicategories and Hopf algebroids, *Adv. Math.* **129** (1997), 99–157. (Referred to on page 39.)
- [13] B. Fong, Decorated cospans, *Theor. Appl. Categ.* **30** (2015), 1096–1120. Also available as [arXiv:1502.00872](https://arxiv.org/abs/1502.00872). (Referred to on page 3, 4, 21, 22.)
- [14] B. Fong, *The Algebra of Open and Interconnected Systems*, Ph.D. thesis, Computer Science Department, University of Oxford, 2016. Available as [arXiv:1609.05382](https://arxiv.org/abs/1609.05382). (Referred to on page 3, 21, 27.)
- [15] B. Fong, Decorated corelations, *Theory Appl. Categ.*, **33** (2018), 608–643. Also available as [arXiv:1703.09888](https://arxiv.org/abs/1703.09888). (Referred to on page 28.)
- [16] B. Fong and M. Sarazola, A recipe for black box functors. Available as [arXiv:1812.03601](https://arxiv.org/abs/1812.03601). (Referred to on page 28.)
- [17] B. Fong and D. Spivak, Hypergraph categories. Available as [arXiv:1806.08304](https://arxiv.org/abs/1806.08304). (Referred to on page 3, 21.)
- [18] C. Girault and R. Valk, *Petri Nets for Systems Engineering: a Guide to Modeling, Verification, and Applications*, Springer, Berlin, 2013. (Referred to on page 31.)
- [19] M. Grandis and R. Paré, Limits in double categories, *Cah. Top. Géom. Diff.* **40** (1999), 162–220. (Referred to on page 37.)
- [20] M. Grandis and R. Paré, Adjoints for double categories, *Cah. Top. Géom. Diff.* **45** (2004), 193–240. (Referred to on page 37.)
- [21] P. J. Haas, *Stochastic Petri Nets: Modelling, Stability, Simulation*, Springer, Berlin, 2002. (Referred to on page 35.)
- [22] L. W. Hansen and M. Shulman, Constructing symmetric monoidal bicategories functorially. Available as [arXiv:1910.09240](https://arxiv.org/abs/1910.09240). (Referred to on page 25, 37, 42.)
- [23] F. Horn and Roy Jackson, General mass action kinetics, *Arch. Ration. Mech. An.*, **47**, 81–116, 1972. (Referred to on page 35.)
- [24] S. Lack, A coherent approach to pseudomonads, *Adv. Math.* **152** (2000), 179–202. (Referred to on page .)
- [25] M. A. Marsan, G. Balbo, G. Conte, S. Donatelli and G. Franceschinis, *Modelling with Generalized Stochastic Petri Nets*, Wiley, New York, 1995. (Referred to on page 35.)
- [26] J. Master, Generalized Petri nets. Available as [arXiv:1904.09091](https://arxiv.org/abs/1904.09091). (Referred to on page 34.)
- [27] J. Meseguer and U. Montanari, Petri nets are monoids, *Information and Computation* **88** (1990), 105–155. (Referred to on page 31.)
- [28] J. L. Peterson, *Petri Net Theory and the Modeling of Systems*, Prentice–Hall, New Jersey, 1981. (Referred to on page 31.)
- [29] S. Niefield, Span, cospan, and other double categories, *Theor. Appl. Categ.* **26** (2012), 729–742. Available as [arXiv:1201.3789](https://arxiv.org/abs/1201.3789). (Referred to on page 7.)
- [30] R. Rosebrugh, N. Sabadini and R. F. C. Walters, Generic commutative separable algebras and cospans of graphs, *Theor. Appl. Categ.* **15** (2005), 164–177. Available at <http://www.tac.mta.ca/tac/volumes/15/6/15-06.pdf>. (Referred to on page 29, 30.)
- [31] M. Shulman, Framed bicategories and monoidal fibrations. Available as [arXiv:0706.1286](https://arxiv.org/abs/0706.1286). (Referred to on page 37.)
- [32] M. Shulman, Constructing symmetric monoidal bicategories. Available as [arXiv:1004.0993](https://arxiv.org/abs/1004.0993). (Referred to on page 4, 5, 11, 14, 19, 20, 37, 39.)
- [33] M. Stay, Compact closed bicategories, *Theor. Appl. Categ.* **31** (2016), 755–798. Available as [arXiv:1301.1053](https://arxiv.org/abs/1301.1053). (Referred to on page 4, 20.)
- [34] D. Verdon, Coherence for braided and symmetric pseudomonoids. Available at [arXiv:1705.09354](https://arxiv.org/abs/1705.09354). (Referred to on page 13.)