

# The nucleus of an adjunction and the Street monad on monads

Dusko Pavlovic\*

University of Hawaii, Honolulu HI

dusko@hawaii.edu

Dominic J. D. Hughes

Apple Inc., Cupertino CA and UC Berkeley, Berkeley CA<sup>†</sup>

dominic@theory.stanford.edu

## Abstract

An adjunction is a pair of functors related by a pair of natural transformations, and relating a pair of categories. It displays how a structure, or a concept, projects from each category to the other, and back. Adjunctions are the common denominator of Galois connections, representation theories, spectra, and generalized quantifiers. We call an adjunction nuclear when its categories determine each other. We show that every adjunction can be resolved into a nuclear adjunction. This resolution is idempotent in a strong sense. The nucleus of an adjunction displays its conceptual core, just as the singular value decomposition of an adjoint pair of linear operators displays their canonical bases.

The two composites of an adjoint pair of functors induce a monad and a comonad. Monads and comonads generalize the closure and the interior operators from topology, or modalities from logic, while providing a saturated view of algebraic structures and compositions on one side, and of coalgebraic dynamics and decompositions on the other. They are resolved back into adjunctions over the induced categories of algebras and of coalgebras. The nucleus of an adjunction is an adjunction between the induced categories of algebras and coalgebras. It provides new presentations for both, revealing the meaning of constructing algebras for a comonad and coalgebras for a monad.

In his seminal early work, Ross Street described an adjunction between monads and comonads in 2-categories. Lifting the nucleus construction, we show that the resulting Street monad on monads is strongly idempotent, and extracts the nucleus of a monad. A dual treatment achieves the same for comonads. Applying a notable fragment of pure 2-category theory on an acute practical problem of data analysis thus led to new theoretical result.

---

\*Supported by NSF and AFOSR.

<sup>†</sup>Visiting scholar, Logic Group. Many thanks to Wes Holliday and Dana Scott for inviting me.

# Contents

<b>1</b>	<b>Introduction</b>	<b>5</b>
1.1	Nuclear adjunctions and the adjunction nuclei . . . . .	5
1.1.1	Definition. . . . .	5
1.1.2	Result . . . . .	5
1.1.3	Upshot . . . . .	6
1.1.4	Background . . . . .	7
1.1.5	Terminology . . . . .	8
1.1.6	Schema . . . . .	8
1.2	The Street monad . . . . .	10
1.3	What about the 2-categorical aspects? . . . . .	10
1.4	Overview of the paper . . . . .	11
<b>2</b>	<b>Example 1: Tight bicompletions and Formal Concept Analysis</b>	<b>11</b>
2.1	From context matrices to concept lattices, intuitively . . . . .	11
2.2	Formalizing concept analysis . . . . .	12
2.3	Summary . . . . .	15
<b>3</b>	<b>Example 2: Nuclei of linear operators and Latent Semantic Analysis</b>	<b>16</b>
3.1	Matrices and linear operators . . . . .	16
3.2	Nucleus as an automorphism of the rank space of a linear operator . . . . .	17
3.2.1	Hilbert space adjoints: Notation and construction . . . . .	18
3.2.2	Factorizations . . . . .	19
3.3	Nucleus as matrix diagonalization . . . . .	19
3.4	Summary . . . . .	21
<b>4</b>	<b>Example 3: Nuclear Chu spaces</b>	<b>22</b>
4.1	Abstract matrices . . . . .	22
4.1.1	Posets . . . . .	22
4.1.2	Linear spaces . . . . .	23
4.1.3	Categories . . . . .	23
4.2	Representability and completions . . . . .	23
4.3	Abstract adjunctions . . . . .	23
4.3.1	The Chu-construction . . . . .	24
4.3.2	Representing matrices as adjunctions . . . . .	24
4.3.3	Separated and extensional adjunctions . . . . .	25
4.4	What does the separated-extensional nucleus capture in examples 4.1? . . . . .	26
4.4.1	Posets . . . . .	26
4.4.2	Linear spaces . . . . .	26
4.4.3	Categories . . . . .	26
4.5	Discussion: Combining factorization-based approaches . . . . .	26
4.5.1	How nuclei depend on factorizations? . . . . .	27

4.5.2	Exercise . . . . .	28
4.5.3	Workout . . . . .	28
4.6	Towards the categorical nucleus . . . . .	31
<b>5</b>	<b>Example <math>\infty</math>: Setting for categorical nuclei</b>	<b>33</b>
5.1	The categories . . . . .	33
5.1.1	Matrices between categories (a.k.a. distributors, profunctors, bimodules) . . . . .	33
5.1.2	Adjunctions . . . . .	34
5.1.3	Monads . . . . .	35
5.1.4	Comonads . . . . .	36
5.2	The functors . . . . .	37
5.2.1	Comprehending presheaves and matrices as discrete fibrations . . . . .	37
5.2.2	From matrices to adjunctions . . . . .	38
5.2.3	From adjunctions to monads and comonads, and back . . . . .	39
5.3	Absolute (Cauchy) completions and weak (Morita) equivalences . . . . .	41
5.3.1	Idempotent splitting. . . . .	41
5.3.2	Absolute and Cauchy completions. . . . .	42
5.3.3	Weak (Morita) equivalences. . . . .	42
5.3.4	Absolute reflections. . . . .	43
<b>6</b>	<b>Theorem</b>	<b>43</b>
<b>7</b>	<b>Propositions</b>	<b>45</b>
7.1	The adjunction of coalgebras and algebras . . . . .	45
7.2	The adjunction of coalgebras and algebras is nuclear . . . . .	49
<b>8</b>	<b>Simple nucleus</b>	<b>57</b>
8.1	Simple nucleus of an adjunction . . . . .	58
8.2	Simple nucleus of a monad or a comonad . . . . .	61
<b>9</b>	<b>Little nucleus</b>	<b>62</b>
<b>10</b>	<b>Example 0: The Kan adjunction</b>	<b>68</b>
10.1	Simplices and the simplex category . . . . .	68
10.2	Kan adjunctions and extensions . . . . .	69
10.3	Troubles with localizations . . . . .	70
<b>11</b>	<b>What?</b>	<b>73</b>
11.1	What we did . . . . .	73
11.2	What we did not do . . . . .	73
11.3	What remains to be done . . . . .	74
11.4	What are categories and what are their model structures? . . . . .	74
	<b>Appendices</b>	<b>84</b>

<b>A</b>	<b>Factorizations</b>	<b>84</b>
<b>B</b>	<b>Morphing adjunctions, monads, comonads</b>	<b>86</b>
B.1	The bireflections $AC : \text{Adj} \rightarrow \text{Cmn}$ and $AM : \text{Adj} \rightarrow \text{Mnd}$ . . . . .	86
B.2	The initial resolutions $KM : \text{Mnd} \rightarrow \text{Adj}$ and $KC : \text{Cmn} \rightarrow \text{Adj}$ . . . . .	87
B.3	The final resolutions $EM : \text{Mnd} \rightarrow \text{Adj}$ and $EC : \text{Cmn} \rightarrow \text{Adj}$ . . . . .	89
<b>C</b>	<b>Split equalizers</b>	<b>90</b>

# 1 Introduction

This section provides an informal overview of the main results. Sections 2–5 describe some of the motivating examples. The results are stated and proved in Sections 6–9. Some readers may prefer to read the main results first and come back as needed. The tools and notations are introduced in Sec. 5, and in the Appendices.

## 1.1 Nuclear adjunctions and the adjunction nuclei

### 1.1.1 Definition.

We say that an adjunction  $F = (F^* \dashv F_* : \mathbb{B} \rightarrow \mathbb{A})$  is *nuclear* when the right adjoint  $F_*$  is monadic and the left adjoint  $F^*$  is comonadic. This means that the categories  $\mathbb{A}$  and  $\mathbb{B}$  determine one another, and can be reconstructed from each other:

- $F_*$  is monadic when  $\mathbb{B}$  is equivalent to the category  $\mathbb{A}^{\overleftarrow{F}}$  of algebras for the monad  $\overleftarrow{F} = F_*F^* : \mathbb{A} \rightarrow \mathbb{A}$ , whereas
- $F^*$  is comonadic when  $\mathbb{A}$  is equivalent to the category  $\mathbb{B}^{\overrightarrow{F}}$  of coalgebras for the comonad  $\overrightarrow{F} = F^*F_* : \mathbb{B} \rightarrow \mathbb{B}$ .

The situation is reminiscent of Maurits Escher’s “*Drawing hands*” in Fig.1.

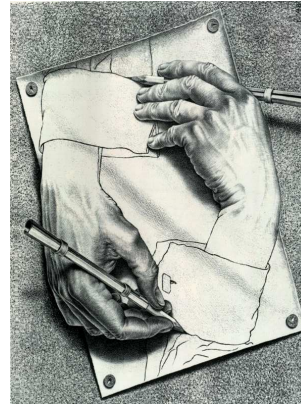
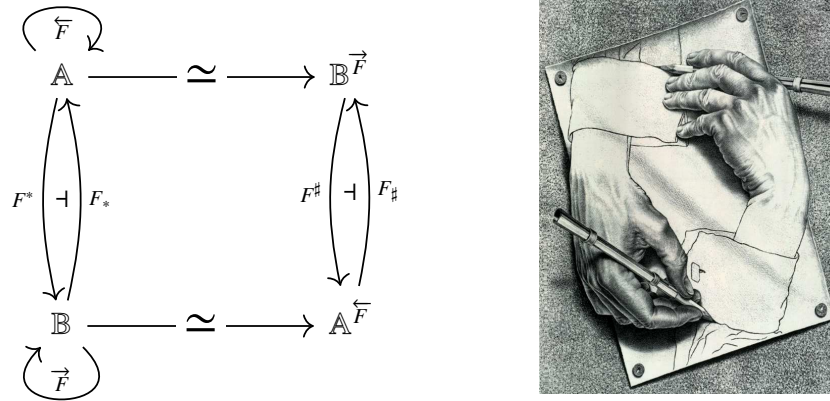

Figure 1: An adjunction  $(F^* \dashv F_*)$  is nuclear when  $\mathbb{A} \simeq \mathbb{B}^{\overrightarrow{F}}$  and  $\mathbb{B} \simeq \mathbb{A}^{\overleftarrow{F}}$ .

### 1.1.2 Result

The nucleus construction  $\overleftarrow{\mathfrak{N}}$  extracts from any adjunction  $F$  its nucleus  $\overleftarrow{\mathfrak{N}}F$

$$\frac{F = (F^* \dashv F_* : \mathbb{B} \rightarrow \mathbb{A})}{\overleftarrow{\mathfrak{N}}F = (F^\# \dashv F_\# : \mathbb{A}^{\overleftarrow{F}} \rightarrow \mathbb{B}^{\overrightarrow{F}})} \quad (1)$$

The functor  $F_{\#}$  is formed by composing the forgetful functor  $\mathbb{A}^{\overleftarrow{F}} \rightarrow \mathbb{A}$  with the comparison functor  $\mathbb{A} \rightarrow \mathbb{B}^{\overrightarrow{F}}$ , whereas  $F^{\#}$  is the composite of the forgetful functor  $\mathbb{B}^{\overrightarrow{F}} \rightarrow \mathbb{B}$  with the comparison functor  $\mathbb{B} \rightarrow \mathbb{A}^{\overleftarrow{F}}$ . Hence the left-hand square in Fig. 2. We show that the functors  $F^{\#}$  and  $F_{\#}$  are adjoint,

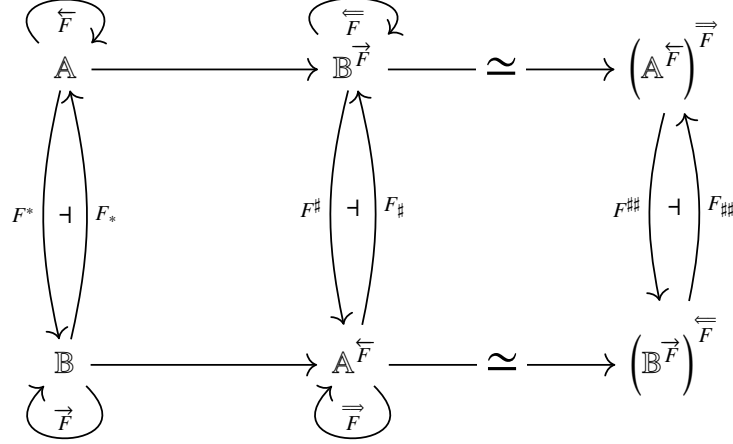

Figure 2: The nucleus construction induces an idempotent monad on adjunctions.

which means that we can iterate the nucleus construction  $\overleftarrow{\mathfrak{N}}$  in (1) and induce a tower of adjunctions

$$F \rightarrow \overleftarrow{\mathfrak{N}}F \rightarrow \overleftarrow{\mathfrak{N}}\overleftarrow{\mathfrak{N}}F \rightarrow \overleftarrow{\mathfrak{N}}\overleftarrow{\mathfrak{N}}\overleftarrow{\mathfrak{N}}F \rightarrow \dots \quad (2)$$

We show that  $\overleftarrow{\mathfrak{N}}F = (F^{\#} \dashv F_{\#})$  is a *nuclear* adjunction, which means that the right-hand square in Fig. 2 is an equivalence of adjunctions. The tower in (2) thus settles at the second step. The  $\overleftarrow{\mathfrak{N}}$ -construction is an *idempotent monad* on adjunctions. Since the adjunctions form a 2-category,  $\overleftarrow{\mathfrak{N}}$  is a 2-monad. We emphasize that its idempotence is *strong*, i.e. (up to a natural family of equivalences), and not *lax* (up to a natural family of adjunctions). While lax idempotence is frequently encountered and well-studied in categorical algebra [52, 54, 90, 94]<sup>1</sup>, strongly idempotent categorical constructions are relatively rare, and occur mostly in the context of absolute completions. The nucleus construction suggests a reason [82].

### 1.1.3 Upshot

Any adjunction  $F^* \dashv F_* : \mathbb{B} \rightarrow \mathbb{A}$ , induces an adjunction  $F^{\#} \dashv F_{\#} : \mathbb{A}^{\overleftarrow{F}} \rightarrow \mathbb{B}^{\overrightarrow{F}}$  between the category of  $\overleftarrow{F}$ -algebras  $\mathbb{A}^{\overleftarrow{F}}$  and the category of  $\overrightarrow{F}$ -coalgebras  $\mathbb{B}^{\overrightarrow{F}}$ , such that the former can be reconstructed as the category  $(\mathbb{B}^{\overrightarrow{F}})^{\overleftarrow{F}}$  of  $\overleftarrow{F}$ -algebras for  $\overleftarrow{F} = F_{\#}F^{\#}$ , whereas the former can be reconstructed as

<sup>1</sup>Monads over 2-categories and bicategories have been called *doctrines* [62], and the lax idempotent ones are often called the *Kock-Zöberlein doctrines* [90].

$(\mathbb{A}^{\overleftarrow{F}})^{\overrightarrow{F}}$  of  $\overrightarrow{F}$ -algebras for  $\overrightarrow{F} = F^\#F_\#$ . They are thus an instance of the Escher situation in Fig. 1. Simplifying these mutual reconstructions provides a new view of the final resolutions of monads and comonads, complementing the original Eilenberg-Moore construction [28]. It was described in [83] as a programming tool and it is in use as a mathematical tool in [82]. Presenting algebras and coalgebras as idempotents reconstructs monadicity and comonadicity in terms of idempotent splittings, echoing Paré’s explanations in terms of absolute colimits [72, 73], and in contrast with Beck’s fascinating but somewhat mysterious proof of his fundamental theorem in terms of split coequalizers [14, 15]. The applications branch in many directions, some of which are described below.

### 1.1.4 Background

Nuclear adjunctions have been studied since the early days of category theory, albeit without a name. The problem of characterizing situations when the left adjoint of a monadic functor is comonadic is the topic of Michael Barr’s paper in the proceedings of the legendary Battelle conference [8]. From a different direction, in his seminal work on the formal theory of monads, Ross Street identified the 2-adjunction between the 2-categories of monads and of comonads [89, Sec. 4]. This adjunction induces the Street monad from the title of the paper. On the side of applications, the quest for comonadic adjoints of monadic functors continued in descent theory, and an important step towards characterizing them was made by Mesablishvili in [70]. Coalgebras over algebras, and algebras over coalgebras, have also been regularly used for a variety of modeling purposes in the semantics of computation (see e.g. [7, 43, 45], and the references therein).

As the vanishing point of monadic descent, nuclear adjunctions arise in many branches of geometry, tacitly or explicitly. In abstract homotopy theory, they are tacitly in [47, 86], and explicitly in [1]. There are, however, different ways in which monad-comonad couplings may arise. In [1], Applegate and Tierney formed such couplings on the two sides of comparison functors and their adjoints, and they found that such monad-comonad couplings generally induce further monad-comonad couplings along the further comparison functors, and may form towers of transfinite length. We describe this in more detail in Sec. 10. Confusingly, the Applegate-Tierney towers of monad-comonad couplings *formed by comparison functor adjunctions* left a false impression that the monad-comonad couplings *formed by the adjunctions between categories of algebras over coalgebras, of coalgebras over algebras, etc.* also lead to towers of transfinite length. This impression blended into folklore, and the towers of alternating monads over coalgebras and comonads over algebras, extending out of sight, persist in categorical literature.<sup>2</sup>

---

<sup>2</sup>There is an interesting exception outside the categorical literature. In a fax message sent to Paul Taylor on 9/9/99 [57], a copy of which was kindly provided after the present paper appeared on arxiv, Steve Lack set out to determine the conditions under which the tower of coalgebras over algebras, which "a priori continues indefinitely", settles to equivalence at a finite stage. Within 7 pages of diagrams, the question was reduced to splitting a certain idempotent. While the argument is succinct, it does seem to prove a claim which, together with its dual, implies our Prop. 7.4. The claim was, however, not pursued in further work. This amusing episode from the early life of the nucleus underscores its message: that a concept is technically within reach whenever there is an adjunction, but it does need to be spelled out and applied to be recognized.

### 1.1.5 Terminology

Despite all of their roles and avatars, the adjunctions where the right adjoint is monadic and the left adjoint is comonadic were not given a name. We call them nuclear because of the link with nuclear operators on Banach spaces, which generalize the spectral decomposition of hermitians and the singular value decomposition of linear operators. The terminology was introduced in Grothendieck’s thesis [36]. We describe this conceptual link in Sec. 3, for the very special case of finite-dimensional Hilbert spaces.

### 1.1.6 Schema

Fig. 3 maps the paths that lead to the nucleus. We trace them through examples from lattice theory,

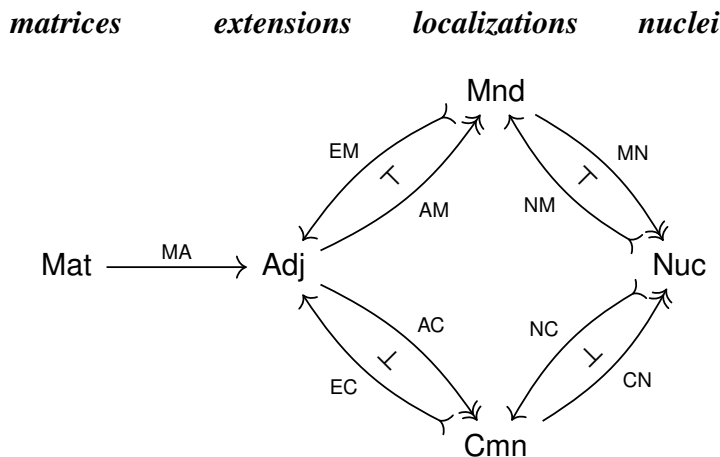

Figure 3: The nucleus setting

linear algebra, and categorical structures in Sections 2–4, and study where they lead in general in the rest of the paper. Most definitions are in Sec. 5. Some readers may wish to skip the rest of the present section, have a look at the examples, and come back as needed. For others we provide here an informal overview of the terminology, mostly just naming names.

**Who is who.** While the production line of mathematical tools is normally directed from theory to applications, ideas often flow in the opposite direction. Data analysis and concept mining gave rise to several forms of nucleus extraction [5, 18, 21, 33, 46] but a general approach to source dependencies has remained elusive [50]. Data analysis usually begins by tabulating some observations into matrices of numbers. Categorical matrices, where two categories act on the matrix entries along the two dimensions, go under a variety of names: profunctors, distributors, categorical bimodules. We persist in calling them matrices, to emphasize the link with the applications, and view them as objects of a category  $\text{Mat}$ . The upshot of the step from matrices of numbers to the categorical matrices is that is that the usual matrix multiplication (summing up the products of entries) imposes the assumption that the sources of the matrix entries are independent, whereas the categorical matrix multiplication (based on the coend operation) captures the dependencies of the entries.



In any case, to be analyzed, the data matrices are usually completed or *extended* into some sort of *adjunctions*, which we view as objects of a category  $\text{Adj}$ . This echoes the extension of the matrices of numbers into adjoint operators in linear algebra. The functor  $\text{MA} : \text{Mat} \rightarrow \text{Adj}$  represents the categorical version of this extension. The adjunctions are then *localized* along the functors  $\text{AM} : \text{Adj} \rightarrow \text{Mnd}$  and  $\text{AC} : \text{Adj} \rightarrow \text{Cmn}$  at *monads* and *comonads*, which form the categories  $\text{Mnd}$  and  $\text{Cmn}$ . In some areas and periods of category theory, a functor was called a localization when it has a full and faithful adjoint. The functors  $\text{AM}$  and  $\text{AC}$  in Fig. 3 have both full and faithful right adjoints  $\text{EM}$  and  $\text{EC}$ . The composites induce the monads  $\overleftarrow{\text{EM}} = \text{EM} \circ \text{AM}$  and  $\overleftarrow{\text{EC}} = \text{EC} \circ \text{AC}$  over  $\text{Adj}$ , which respectively represent monads as monadic adjunctions and comonads as comonadic adjunctions. The category  $\text{Nuc}$  of nuclear adjunctions is the intersection of the two. It can thus be thought of as the intersection of  $\text{Mnd}$  and  $\text{Cmn}$ , as embedded into  $\text{Adj}$ . This paper can be viewed as a report on an effort to construct and understand this intersection.

**Unity and identity of resolutions.** The localizations  $\text{AM}$  and  $\text{AC}$  actually have not only the right adjoints, displayed in Fig. 3, but also the left adjoints, as displayed in Fig. 4. The double adjunc-

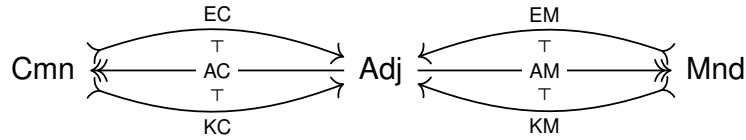

Figure 4: Relating adjunctions, monads and comonads

tions  $\text{KM} \dashv \text{AM} \dashv \text{EM}$  and  $\text{KC} \dashv \text{AC} \dashv \text{EC}$  display the Kleisli constructions  $\text{KM}$  and  $\text{KC}$  as the initial resolutions, respectively, of monads and comonads, and the Eilenberg-Moore constructions  $\text{EM}$  and  $\text{EC}$  as the final resolutions. We call an adjunction  $F = (F^* \dashv F_*)$  a *resolution* of the monad  $\overleftarrow{T}$  when  $\overleftarrow{T} = F_* F^*$  and of the comonad  $\overrightarrow{T}$  when  $\overrightarrow{T} = F^* F_*$ . Monads and comonads over posets, familiar as the closure operators and the interior operators in topology, have unique resolutions, induced by the inclusions of the closed elements and of the open elements, respectively. Monads and comonads over general categories have unique resolutions if and only if they are idempotent. General monads and comonads have entire gamuts of different resolutions. The monad resolutions are localized along the functor  $\text{AM} : \text{Adj} \rightarrow \text{Mnd}$ ; the comonad resolutions along  $\text{AC} : \text{Adj} \rightarrow \text{Cmn}$ , in the sense that  $F$  is a resolution of  $\overleftarrow{T}$  and of  $\overrightarrow{T}$  if  $\text{AM}(F) = \overleftarrow{T}$  and  $\text{AC}(F) = \overrightarrow{T}$ . In general, the category  $\text{Mnd}$  is thus embedded into  $\text{Adj}$  in two extremal ways, along its initial and final resolutions  $\text{KM}$  and  $\text{EM}$ ; the category  $\text{Cmn}$  along  $\text{KC}$  and  $\text{EC}$ . The double adjunctions  $\text{KM} \dashv \text{AM} \dashv \text{EM}$  and  $\text{KC} \dashv \text{AC} \dashv \text{EC}$  are thus examples of Lawvere's *unity and identity of the opposites* [51, 64, 65]. Given an adjunction  $F = (F^* \dashv F_*)$ , we can first construct its monadic resolution  $\overleftarrow{\text{EM}}(F)$  and then its comonadic resolution  $\overleftarrow{\text{EC}} \circ \overleftarrow{\text{EM}}(F)$ ; or we can first construct  $\overleftarrow{\text{EC}}(F)$  and then  $\overleftarrow{\text{EM}} \circ \overleftarrow{\text{EC}}(F)$ . The outcomes turn out to be equivalent, and also equivalent to  $\overleftarrow{\text{EC}} \circ \overrightarrow{\text{KM}}(F)$  and  $\overleftarrow{\text{EM}} \circ \overrightarrow{\text{KC}}(F)$  for  $\overrightarrow{\text{KM}} = \text{KM} \circ \text{AM}$  and  $\overrightarrow{\text{KC}} = \text{KC} \circ \text{AC}$ . All these constructions yield the nucleus of  $F$ , just assuming that enough idempotents split. One way to understand why all paths lead to the same place is to follow through Fig. 4 the paths from  $\text{Mnd}$  to  $\text{Cmn}$  and back that yield a monad on monads.

## 1.2 The Street monad

The composites  $\mathcal{C}^* = \text{AM} \circ \text{KC}$  and  $\mathcal{C}_* = \text{AC} \circ \text{EM}$  in Fig. 3 are adjoint to one another, and thus form a monad  $\overleftarrow{\mathcal{C}} = \mathcal{C}_* \circ \mathcal{C}^*$  on the category  $\text{Cmn}$  of comonads, and a comonad  $\overrightarrow{\mathcal{C}} = \mathcal{C}^* \circ \mathcal{C}_*$  on the category  $\text{Mnd}$  of monads. The initial (Kleisli) resolution  $\text{KM}$  of the monads and the final (Eilenberg-Moore) resolution  $\text{EC}$  of comonads give the adjoints  $\mathfrak{M}^* = \text{AC} \circ \text{KM}$  and  $\mathfrak{M}_* = \text{AM} \circ \text{EC}$ , which form a monad  $\overleftarrow{\mathfrak{M}} = \mathfrak{M}_* \circ \mathfrak{M}^*$  on the category  $\text{Mnd}$  of monads, and a comonad  $\overrightarrow{\mathfrak{M}} = \mathfrak{M}^* \circ \mathfrak{M}_*$  on the category  $\text{Cmn}$  of comonads. See Fig. 16 for a summary. In Ross Street’s paper on the *Formal theory of monads*, the latter adjunction between monads and comonads was spelled out directly, without going through  $\text{Adj}$  [89, Thm. 11]. This was the main result of that seminal analysis, and it remains the central theorem of the theory. We prove that Street’s monad is strongly idempotent. The monads that it fixes are nuclear, in the sense that their final resolutions are also final resolutions of the comonads induced over their algebras. The category of nuclear monads is thus equivalent with the category  $\text{Nuc}$  of nuclear adjunctions. Ditto for the analogous category of nuclear comonads. Hence the adjunctions  $\text{NM} \dashv \text{MN}$  and  $\text{NC} \dashv \text{CN}$ . There are still more equivalent views of  $\text{Nuc}$ , but even this many is probably too many for this overview, so we leave them for Sec. 9. The nucleus is a very robust and useful phenomenon. The wrinkle of idempotency nudges Street’s monad from a formal theory towards an important application.

## 1.3 What about the 2-categorical aspects?

All of the above categories, constructed over the 2-category of categories  $\text{Cat}$ , naturally arise with 2-cells. The early accounts were [4, 89]. The results of the present paper were originally written down as 2-categorical statements. They lingered in manuscripts for many years because we never found a way to display the 2-categorical details without losing the forest for the trees. Giving up on the 2-cells not only made the presentation tractable (to some extent), but also shed light on a remarkable phenomenon. As a tight, strongly idempotent construction, the nucleus is not just independent of the 2-dimensional structure, but seems to filter it out. For one thing, the conceptual content of adjunctions captured by their nuclei is in each case completely summarized by an ordinary category [81]. This is related to the fact that the nucleus construction and the Street monads are idempotent up to equivalences and invertible 2-cells, and not up to adjunctions and general 2-cells [54, 90, 94]. Moreover, the 2-cells up to which the 1-cells studied in [4, 56, 87, 89] preserve adjunctions, monads, and comonads must be invertible in order to support the double adjunctions  $\text{KM} \dashv \text{AM} \dashv \text{EM}$  and  $\text{KC} \dashv \text{AC} \dashv \text{EC}$ , needed for extracting the nuclei. Although imposing the invertibility requirement on the 2-cells within the 1-cells between monads does limit their expressiveness (and in fact precludes some of the morphisms used in functional programming for monads over a fixed category [14, Ch. 3, Sec. 6]), in concept mining applications this limitation is a feature, not a bug, as it imposes the task of dimensionality reduction, always at the heart in data analysis, addressed e.g. in linear algebra by the diagonal matrices of singular values. The theoretical work on understanding this practical feature is ongoing.

## 1.4 Overview of the paper

We begin with examples and progress towards general constructions. Over posets, nuclei are familiar as lattices of fixpoints of Galois connections, used in Formal Concept Analysis. Its main ideas are described in Sec. 2. In linear algebra, nuclei are familiar as the diagonal matrices of singular values, used in Latent Semantic Analysis, an even more popular approach to concept mining. It is described in Sec. 3. An abstract nucleus idea emerged in the framework of \*-autonomous categories and semantics of linear logic, as the separated-extensional core of the Chu construction. This example is presented in Sec. 4. We discuss a modification that combines the separated-extensional core with the spectral decomposition of matrices and refers back to the conceptual roots in early studies of topological vector spaces. In Sec. 5, we list the categorical tools and concepts needed to construct the nuclei of general adjunctions. The main theorem is stated in Sec. 6. Its proof is built through a series of propositions in Sec. 7. Sec. 8 presents a simplified description of the nucleus, arising as a corollary of the main theorem. It also provides alternative descriptions of categories of algebras for a monad and of coalgebras for comonads in terms of each other. These presentations are used in a weaker version of the nucleus construction, described in Sec. 9. Although a weak nucleus is equivalent to the strong one only when the adjunction happens to be reflective or coreflective, the categories of strongly nuclear and of weakly nuclear adjunctions turn out to be equivalent. In Sec. 10, we discuss how the nucleus approach compares and contrasts with the traditional localization-based methods of homotopy theory, from which the entire apparatus of adjunctions originally emerged. In the final section of the paper, we discuss some of the open problems.

## 2 Example 1: Tight bicompletions and Formal Concept Analysis

### 2.1 From context matrices to concept lattices, intuitively

Consider a market with  $A$  sellers and  $B$  buyers. Their interactions are recorded in an adjacency matrix  $A \times B \xrightarrow{\Phi} 2$ , where  $2$  is the set  $\{0, 1\}$ , and the entry  $\Phi_{ab}$  is 1 if the seller  $a \in A$  at some point sold goods to the buyer  $b \in B$ ; otherwise it is 0. Equivalently, a matrix  $A \times B \xrightarrow{\Phi} 2$  can be viewed as the binary relation  $\widehat{\Phi} = \{\langle a, b \rangle \in A \times B \mid \Phi_{ab} = 1\}$ , in which case we write  $a\widehat{\Phi}b$  instead of  $\Phi_{ab} = 1$ . In Formal Concept Analysis [18, 33, 32], such matrices or relations are called *contexts*, and used to extract some relevant *concepts*.

The idea is illustrated in Fig. 5. The binary relation  $\widehat{\Phi} \subseteq A \times B$  is displayed as a bipartite graph. If buyers  $a_0$  and  $a_4$  have farms, and sellers  $b_1, b_2$  and  $b_3$  sell farming equipment, but seller  $b_0$  does not, then the sets  $X = \{a_0, a_4\}$  and  $Y = \{b_1, b_2, b_3\}$  form a complete subgraph  $\langle X, Y \rangle$  of the bipartite graph  $\widehat{\Phi}$ , which corresponds to the concept "*farming*". If the buyers from the set  $X' = \{a_0, a_1, a_2, a_3\}$  have cars, but the buyer  $a_4$  does not, and the sellers  $Y' = \{b_0, b_1, b_2\}$  sell car accessories, but the seller  $b_3$  does not then  $\langle X', Y' \rangle$  is another complete subgraph, corresponding to the concept "*car*". The idea is thus that a context is viewed as a bipartite graph, and the concepts are then extracted as

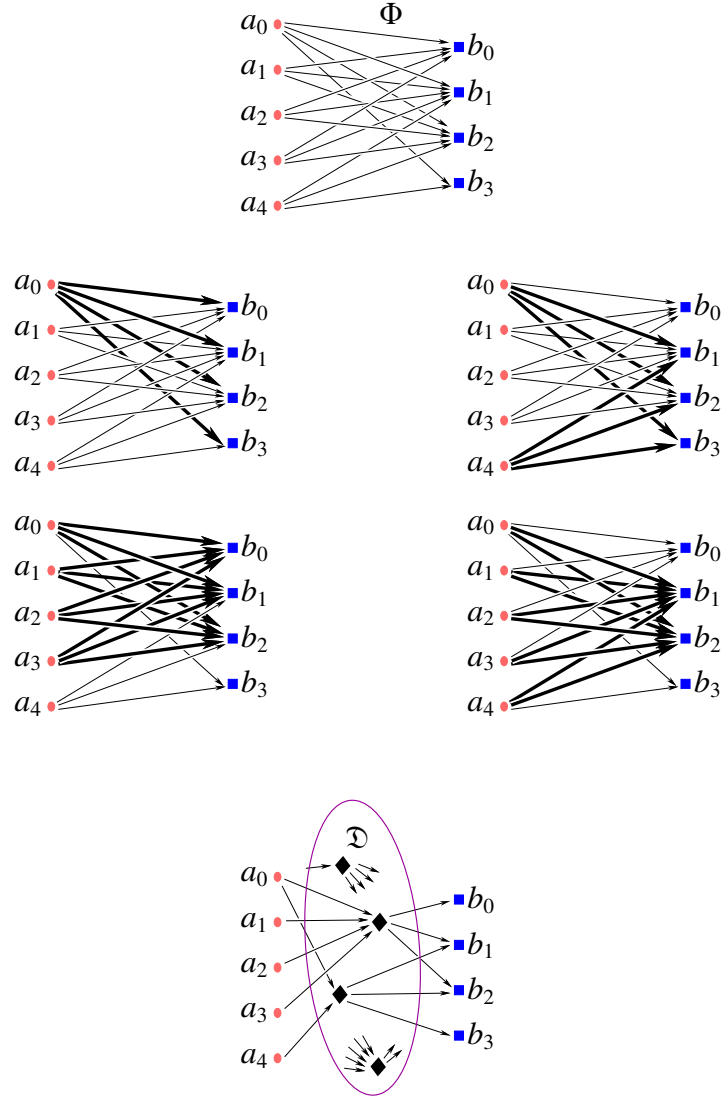

Figure 5: A context  $\Phi$ , its four concepts, and their concept lattice

its complete bipartite subgraphs.

## 2.2 Formalizing concept analysis

A pair  $\langle U, V \rangle \in \wp A \times \wp B$  forms a complete subgraph of a bipartite graph  $\widehat{\Phi} \subseteq A \times B$  if

$$U = \bigcap_{v \in V} \{x \in A \mid x \widehat{\Phi} v\} \quad V = \bigcap_{u \in U} \{y \in B \mid u \widehat{\Phi} y\}$$

It is easy to see that such pairs are ordered by the relation

$$\langle U, V \rangle \leq \langle U', V' \rangle \iff U \subseteq U' \wedge V \supseteq V' \quad (3)$$

and that they in fact form a lattice, which is a retract of the lattice  $\wp A \times \wp^o B$ , where  $\wp A$  is the set of subsets of  $A$  ordered by the inclusion  $\subseteq$ , while  $\wp^o B$  is the set of subsets of  $B$  ordered by reverse inclusion  $\supseteq$ . This is the *concept lattice*  $\mathfrak{D}$  induced by the *context matrix*  $\widehat{\Phi} \subseteq A \times B$ , along the lines of Fig. 3.

In general, the sets  $A$  and  $B$  may already carry partial orders, e.g. from earlier concept analyses. The category of context matrices is thus

$$|\text{Mat}_0| = \prod_{A, B \in \text{Pos}} \text{Pos}(A^o \times B, \mathfrak{2}) \quad (4)$$

$$\text{Mat}_0(\Phi, \Psi) = \{ \langle h, k \rangle \in \text{Pos}(A, C) \times \text{Pos}(B, D) \mid \Phi(a, b) = \Psi(ha, kb) \}$$

where  $\Phi \in \text{Pos}(A^o \times B, \mathfrak{2})$  and  $\Psi \in \text{Pos}(C^o \times D, \mathfrak{2})$  are matrices with entries from the poset  $\mathfrak{2} = \{0 < 1\}$ . When working with matrices in general, it is often necessary or convenient to use their *comprehensions*, i.e. to move along the correspondence

$$\begin{array}{ccc} \text{Pos}(A^o \times B, \mathfrak{2}) & \begin{array}{c} \xrightarrow{(-)} \\ \cong \\ \xleftarrow{x} \end{array} & \text{Sub} / A \times B^o \\ \Phi & \mapsto & \{\Phi\} = \{ \langle x, y \rangle \in A \times B^o \mid \Phi(x, y) = 1 \} \\ \chi_S(x, y) = \begin{cases} 1 & \text{if } \langle x, y \rangle \in S \\ 0 & \text{otherwise} \end{cases} & \leftarrow & (S \subseteq A \times B^o) \end{array} \quad (5)$$

A comprehension  $\{\Phi\}$  of a matrix  $\Phi$  is thus lower-closed in the first component, and upper-closed in the second:

$$a \leq a' \wedge a' \widehat{\Phi} b' \wedge b' \leq b \implies a \widehat{\Phi} b \quad (6)$$

To extract the concepts from a context  $\widehat{\Phi} \subseteq A \times B$ , we thus need to explore the candidate lower-closed subsets of  $A$ , and the upper-closed subsets of  $B$ , which form complete semilattices  $(\Downarrow A, \nabla)$  and  $(\Uparrow B, \blacktriangle)$ , where

$$\Downarrow A = \{ L \subseteq A \mid a \leq a' \in L \implies a \in L \} \quad (7)$$

$$\Uparrow B = \{ U \subseteq B \mid U \ni b' \leq b \implies U \ni b \} \quad (8)$$

so that  $\nabla$  in  $\Downarrow A$  and  $\blacktriangle$  in  $\Uparrow B$  are both set union. It is easy to see that the embedding  $A \xrightarrow{\nabla} \Downarrow A$ , mapping  $a \in A$  into the lower set  $\nabla a = \{x \in A \mid x \leq a\}$ , is the join completion of the poset  $A$ , whereas  $B \xrightarrow{\blacktriangle} \Uparrow B$ , mapping  $b \in B$  into the upper set  $\blacktriangle b = \{y \in B \mid b \leq y\}$ , is the meet completion of the poset  $B$ . These semilattice completions support the context matrix extension  $\overline{\Phi} \subseteq \Downarrow A \times \Uparrow B$  defined by

$$L \overline{\Phi} U \iff \forall a \in L \forall b \in U. a \widehat{\Phi} b \quad (9)$$

As a matrix between complete semilattices,  $\overline{\Phi}$  is representable in the form

$$\Phi^* L \subseteq U \iff L \overline{\Phi} U \iff L \supseteq \Phi_* U \quad (10)$$

where the adjoints now capture the *complete-bipartite-subgraph* idea from Fig. 5:

$$\begin{array}{ccc}
 L & \Downarrow A & \bigcap_{y \in U} \bullet \Phi y \\
 \downarrow & \Phi^* \dashv \Phi_* & \uparrow \\
 \bigcap_{x \in L} x \Phi \bullet & \Uparrow B & U
 \end{array} \quad (11)$$

Here  $\bullet \Phi y = \{x \in A \mid x \Phi y\}$  and  $x \Phi \bullet = \{y \in B \mid x \widehat{\Phi} y\}$  define the transposes  $\bullet \Phi : B \rightarrow \Downarrow A$  and  $\Phi \bullet : A \rightarrow \Uparrow B$  of  $\Phi : A \times B \rightarrow \mathbb{2}$ . Poset adjunctions like (11) are often also called *Galois connections*. They form the category

$$|\text{Adj}_0| = \coprod_{A, B \in \text{Pos}} \{(\Phi^*, \Phi_*) \in \text{Pos}(A, B) \times \text{Pos}(B, A) \mid \Phi^* x \leq y \iff x \leq \Phi_* y\} \quad (12)$$

$$\text{Adj}_0(\Phi, \Psi) = \{ \langle H, K \rangle \in \text{Pos}(A, C) \times \text{Pos}(B, D) \mid K \Phi^* = \Psi^* H \wedge H \Phi_* = \Psi_* H \}$$

The first step of concept analysis is thus the matrix extension

$$\begin{aligned}
 \text{MA}_0 : \text{Mat}_0 &\rightarrow \text{Adj}_0 \\
 \Phi &\mapsto (\Phi^* \dashv \Phi_* : \Uparrow B \rightarrow \Downarrow A) \text{ as in (11)}
 \end{aligned} \quad (13)$$

To complete the process of concept analysis, we use the full subcategories of  $\text{Adj}_0$  spanned by the closure and the interior operators, respectively:

$$\text{Mnd}_0 = \{(\Phi^* \dashv \Phi_*) \in \text{Adj}_0 \mid \Phi^* \Phi_* = \text{id}\} \quad (14)$$

$$\text{Cmn}_0 = \{(\Phi^* \dashv \Phi_*) \in \text{Adj}_0 \mid \Phi_* \Phi^* = \text{id}\} \quad (15)$$

It is easy to see that

- $\text{Mnd}_0$  is equivalent with the category of posets  $A$  equipped with closure operators, i.e. monotone maps  $A \xrightarrow{\overleftarrow{\Phi}} A$  such that  $x \leq \overleftarrow{\Phi} x = \overleftarrow{\Phi} \overleftarrow{\Phi} x$ , for  $\overleftarrow{\Phi} = \Phi_* \Phi^*$ ; while
- $\text{Cmn}_0$  is equivalent with the category of posets  $B$  equipped with interior operators, i.e. monotone maps  $B \xrightarrow{\overrightarrow{\Phi}} B$  such that  $y \geq \overrightarrow{\Phi} y = \overrightarrow{\Phi} \overrightarrow{\Phi} y$ , for  $\overrightarrow{\Phi} = \Phi^* \Phi_*$ .

The functors  $\text{AM}_0 : \text{Adj}_0 \rightarrow \text{Mnd}_0$  and  $\text{AC}_0 : \text{Adj}_0 \rightarrow \text{Cmn}_0$  are thus inclusions, and their resolu-

tions are

$$\text{EM}_0 : \text{Mnd}_0 \rightarrow \text{Adj}_0 \quad (16)$$

$$\left( A \xrightarrow{\overleftarrow{\Phi}} A \right) \mapsto \left( \Downarrow A \xrightleftharpoons[\tau]{\tau} \Downarrow A^{\overleftarrow{\Phi}} \right)$$

$$\text{where } \Downarrow A^{\overleftarrow{\Phi}} = \{ U \in \Downarrow A \mid U = \overleftarrow{\Phi} U \}$$

$$\text{KC}_0 : \text{Cmn}_0 \rightarrow \text{Adj}_0 \quad (17)$$

$$\left( B \xrightarrow{\overrightarrow{\Phi}} B \right) \mapsto \left( \Uparrow B^{\overrightarrow{\Phi}} \xrightleftharpoons[\tau]{\tau} \Uparrow B \right)$$

$$\text{where } \Uparrow B^{\overrightarrow{\Phi}} = \{ V \in \Uparrow B \mid \overrightarrow{\Phi} V = V \}$$

$\text{Mnd}_0$  thus turns out to be a reflective subcategory of  $\text{Adj}_0$ , and  $\text{Cmn}_0$  coreflective. The category  $\text{Nuc}_0$  of concept lattices is their intersection, thus is coreflective in  $\text{Mnd}_0$  and reflective in  $\text{Cmn}_0$ . In fact, these posetal resolutions turn out to be adjoint to the inclusions both on the left and on the right; but that is a peculiarity of the posetal case. Another posetal quirk is that the category  $\text{Nuc}_0$  boils down to the category  $\text{Pos}$  of posets, because an operator that is both a closure and an interior must be an identity. That will not happen in general.

### 2.3 Summary

Going from left to right through Fig. 3 with the categories defined in (4), (12), (14) and (15), and reflecting everything back into  $\text{Adj}_0$ , we made the following steps

$$\begin{array}{c} \Phi : A^o \times B \rightarrow \mathbb{2} \\ \hline \Phi_* = \text{MA}_0\Phi = \left( \Downarrow A \xrightleftharpoons[\Phi_*]{\Phi_*} \Uparrow B \right) \\ \hline \overleftarrow{\text{EM}}_0\Phi_* = \left( \Downarrow A \xrightleftharpoons[\tau]{\tau} \Downarrow A^{\overleftarrow{\Phi}} \right) \qquad \overrightarrow{\text{KC}}_0\Phi_* = \left( \Uparrow B^{\overrightarrow{\Phi}} \xrightleftharpoons[\tau]{\tau} \Uparrow B \right) \\ \hline \overleftarrow{\mathfrak{N}}_0\Phi = \left( \Uparrow B^{\overrightarrow{\Phi}} \xrightleftharpoons[\Phi^\#]{\Phi^\#} \Downarrow A^{\overleftarrow{\Phi}} \right) \end{array} \quad (18)$$

where  $\overleftarrow{\text{EM}}_0 = \text{EM}_0 \circ \text{AM}_0$ , and  $\overrightarrow{\text{KC}}_0 = \text{KC}_0 \circ \text{AC}_0$ , and  $\overleftarrow{\mathfrak{N}}_0$  defines the poset nucleus (which will be subsumed under the general definition in Sec. 6). For posets, the final step happens to be trivial, because of the order isomorphisms

$$\Downarrow A^{\overleftarrow{\Phi}} \cong \mathfrak{D} \cong \Uparrow B^{\overrightarrow{\Phi}} \quad (19)$$

where  $\mathfrak{D}$

$$\mathfrak{D} = \{ \langle L, U \rangle \in \Downarrow A \times \Uparrow B \mid L = \Phi_* U \wedge \Phi^* L = U \} \quad (20)$$

is the familiar lattice of *Dedekind cuts*. The images of the context  $\Phi$  in  $\text{Mnd}_0$ ,  $\text{Cmn}_0$  and  $\text{Nuc}_0$  thus give three isomorphic views of the concept lattice. But this is a degenerate case.

**Comment.** The situation when the two resolutions of an adjunction (the one in  $\text{Mnd}$  and the one in  $\text{Cmn}$ ) are isomorphic is very special. E.g., when  $A = B = \mathbb{Q}$  is the field of rational numbers, and  $\Phi = (\leq)$  is their partial order, then  $\text{MA}_1^* \Phi$  is the set of pairs  $\langle L, U \rangle$ , where  $L$  is an open and closed lower interval,  $U$  is an open or closed upper interval, and  $L \leq U$ . The resolutions eliminate the rational points between  $L$  and  $U$ , by requiring that  $L$  contains all lower bounds of  $U$  and  $U$  all upper bounds of  $L$ . The nucleus then comprises the Dedekind cuts. But any Dedekind cut  $\langle L, U \rangle$  is also completely determined by  $L$  alone, and by  $U$  alone. Hence the isomorphisms (19). The same generalizes when  $A = B$  is a partial order, and the nucleus yields its Dedekind-MacNeille completion: it adjoins all joins and meets that are missing while preserving those that already exist. When  $A$  and  $B$  are different posets, and  $\Phi$  is a nontrivial context between them, we are in the business of concept analysis, and generate the concept lattice — with similar generation and preservation requirements like for the Dedekind-MacNeille completion. In a sense, the posets  $A$  and  $B$  are "glued together" along the context  $\widehat{\Phi} \subseteq A \times B$  into the joint completion  $\mathfrak{D}$ , where the joins are generated from  $A$ , and the meets from  $B$ . On the other hand, any meets that may have existed in  $A$  are preserved in  $\mathfrak{D}$ ; as are any joins that may have existed in  $B$ .

It is a remarkable fact of category theory that no such tight bicompletion exists in general, when the poset  $P$  is generalized to a category [59, 42]. It also is well known that this phenomenon is closely related to the idempotent monads induced by adjunctions, and by profunctors in general [1].

The phenomenon is, however, quite general, and in a sense, hides in plain sight.

## 3 Example 2: Nuclei of linear operators and Latent Semantic Analysis

### 3.1 Matrices and linear operators

The nucleus examples in this section take us back to undergraduate linear algebra. The first part is in fact even more basic. To begin, we consider matrices  $\dot{A} \times \dot{B} \rightarrow R$ , where  $R$  is an arbitrary ring, and  $\dot{A}, \dot{B}$  are *finite* sets. We denote the category of all sets by  $\text{Set}$ , its full subcategory spanned by finite sets by  $\dot{\text{Set}}$ , and generally use the dot to mark finiteness, so that  $\dot{A}, \dot{B} \in \dot{\text{Set}} \subset \text{Set}$ . Viewing both finite sets  $\dot{A}, \dot{B}$  and the ring  $R$  together in the category of sets, we define

$$\begin{aligned} |\text{Mat}_1| &= \coprod_{\dot{A}, \dot{B} \in \dot{\text{Set}}} \text{Set}(\dot{A} \times \dot{B}, R) \\ \text{Mat}_1(\Phi, \Psi) &= \{ \langle H, K \rangle \in R^{\dot{A} \times \dot{C}} \times R^{\dot{B} \times \dot{D}} \mid K\Phi = \Psi H \} \end{aligned} \quad (21)$$



where  $R^{\dot{A} \times \dot{C}}$  abbreviates  $\text{Set}(\dot{A} \times \dot{C}, R)$ , and ditto  $R^{\dot{B} \times \dot{D}}$ . The matrix composition is written left to right

$$\begin{aligned} R^{\dot{X} \times \dot{Y}} \times R^{\dot{Y} \times \dot{Z}} &\longrightarrow R^{\dot{X} \times \dot{Z}} \\ \langle F, G \rangle &\mapsto (GF)_{ik} = \sum_{j \in B} F_{ij} \cdot G_{jk} \end{aligned}$$

When  $R$  is a field,  $\text{Mat}_1$  is the arrow category of finite-dimensional  $R$ -vector spaces with chosen bases. When  $R$  is a general ring,  $\text{Mat}_1$  is the arrow category free  $R$ -modules with finite generators. When  $R$  is not even a ring, but say the *rig* ("a ring without the negatives")  $\mathbb{N}$  of natural numbers, then  $\text{Mat}_1$  is the arrow category of free commutative monoids. Sec. 3.2 applies to all these cases, and Sec. 3.3 applies to real closed fields. Since the goal of this part of the paper is to recall familiar examples of the nucleus construction, we can just as well assume that  $R$  is the field of real numbers. The full generality of the construction will emerge in the end.

### 3.2 Nucleus as an automorphism of the rank space of a linear operator

Since finite-dimensional vector spaces always carry a separable inner product, the category  $\text{Mat}_1$  over the field of real numbers  $R$  is equivalent to the arrow category over finite-dimensional real Hilbert spaces *with chosen bases*. This assumption yields a canonical matrix representation for each linear operator. Starting, on the other hand, from the category  $\text{Hilb}$  of finite-dimensional Hilbert spaces *without* chosen bases, we define the category  $\text{Adj}_1$  as the arrow category  $\text{Hilb}/\text{Hilb}$  of linear operators and their commutative squares, i.e.

$$\begin{aligned} |\text{Adj}_1| &= \coprod_{\mathbb{A}, \mathbb{B} \in \text{Hilb}} \text{Hilb}(\mathbb{A}, \mathbb{B}) \quad (22) \\ \text{Adj}_1(\Phi, \Psi) &= \{ \langle H, K \rangle \in \text{Hilb}(\mathbb{A}, \mathbb{C}) \times \text{Hilb}(\mathbb{B}, \mathbb{D}) \mid K\Phi = \Psi H \} \end{aligned}$$

The finite-dimensional Hilbert spaces  $\mathbb{A}$  and  $\mathbb{B}$  are still isomorphic to  $R^{\dot{A}}$  and  $R^{\dot{B}}$  for some finite spaces  $\dot{A}$  and  $\dot{B}$  of basis vectors; but the particular isomorphisms would choose a standard basis for each of them, so now we are not given such isomorphisms. This means that the linear operators like  $H$  and  $K$  in (22) do not have standard matrix representations, but are given as linear functions between the entire spaces. The categories  $\text{Mnd}_1$  and  $\text{Cmn}_1$  will be the full subcategories of  $\text{Adj}_1$  spanned by

$$\text{Mnd}_1 = \{ \Phi \in \text{Adj}_1 \mid \Phi \text{ is surjective} \} \quad (23)$$

$$\text{Cmn}_1 = \{ \Phi \in \text{Adj}_1 \mid \Phi^\ddagger \text{ is surjective} \} \quad (24)$$

where  $\Phi^\ddagger$  is the adjoint of  $\Phi \in \text{Hilb}(\mathbb{A}, \mathbb{B})$ , i.e. the operator  $\Phi^\ddagger \in \text{Hilb}(\mathbb{B}, \mathbb{A})$  satisfying

$$\langle b \mid \Phi a \rangle_{\mathbb{B}} = \langle \Phi^\ddagger b \mid a \rangle_{\mathbb{A}}$$

where  $\langle - \mid - \rangle_{\mathbb{H}}$  denotes the inner product on the space  $\mathbb{H}$ .

### 3.2.1 Hilbert space adjoints: Notation and construction

In the presence of inner products<sup>3</sup>  $\langle - | - \rangle : \mathbb{A} \times \mathbb{A} \rightarrow R$ , it is often more convenient to use the bra-ket notation, where a vector  $\vec{a} \in \mathbb{A}$  is written as a "bra"  $\langle a |$ , and the corresponding linear functional  $\vec{a}^\ddagger = \langle \vec{a} | - \rangle \in \mathbb{A}^*$  is written as the "ket"  $|a\rangle$ . If  $\mathbb{A}$  is the  $A$ -dimensional space  $R^A$ , then the basis vectors  $\vec{e}_i$ ,  $i = 1, 2, \dots, A$  are written  $|1\rangle, |2\rangle, \dots, |A\rangle$ , whereas the basis vectors of  $\mathbb{A}^*$  are  $\langle 1|, \langle 2|, \dots, \langle A|$ , and the base decompositions become

- $|a\rangle = \sum_{i=1}^A |i\rangle \langle i|a\rangle$  instead of  $\vec{a} = \sum_{i=1}^A a_i \vec{e}_i$ , and
- $\langle a| = \sum_{i=1}^A \langle a|i\rangle \langle i|$  instead of  $\vec{a}^\ddagger = \sum_{i=1}^A a_i \vec{e}_i^\ddagger$ .

For convenience, here we assume that the finite sets  $A, B, \dots \in \mathbb{S}et$  are ordered, i.e. reduce  $\mathbb{S}et$  to  $\mathbb{N}$ . In practice, the difference between  $\mathbb{A}$  and  $\mathbb{A}^*$  is often ignored, because any basis induces a linear isomorphism  $\mathbb{A}^* \cong \mathbb{A}$ , and is uniquely determined by it [20]; but it creeps from under the carpet when vector spaces are combined or aligned with other structures, as we will see further on.

Writing  $\langle j|\Phi|i\rangle$  for the entries  $\Phi_{ji}$  of a matrix  $\Phi = (\Phi_{ji})_{n \times \dot{A}}$  gives

- $\langle j|\Phi|a\rangle = \sum_{i=1}^A \langle j|\Phi|i\rangle \langle i|a\rangle$  instead of  $(\Phi \vec{a})_j = \sum_{i=1}^A \Phi_{ji} a_i$ ,
- $\langle b|\Phi|i\rangle = \sum_{j=1}^B \langle b|j\rangle \langle j|\Phi|i\rangle$  instead of  $(\vec{b}^\ddagger \Phi)_i = \sum_{j=1}^B b_j \Phi_{ji}$ , and
- $\langle b|\Phi|a\rangle = \sum_{i=1}^A \sum_{j=1}^B \langle b|j\rangle \langle j|\Phi|i\rangle \langle i|a\rangle$  instead of  $\vec{b}^\ddagger \Phi \vec{a} = \sum_{i=1}^A \sum_{j=1}^B b_j \Phi_{ji} a_i$

and hence the inner-product adjunction

$$\langle b|\Phi a\rangle_{\mathbb{B}} = \langle b|\Phi|a\rangle = \langle \Phi^\ddagger b|a\rangle_{\mathbb{A}} \quad (25)$$

where we adhere to the usual abuse of notation, and denote both the matrix and the induced linear operator by  $\Phi$ . The dual matrix and the induced adjoint operator are  $\Phi^\ddagger$ . If (25) is the Hilbert space version of (10), then (11) becomes

$$\begin{array}{ccc}
 |a\rangle & & \sum_{j=1}^B \langle b|j\rangle \langle j|\Phi \bullet \\
 \downarrow & \begin{array}{c} R^A \\ \Phi \quad \Phi^\ddagger \\ R^B \end{array} & \uparrow \\
 \sum_{i=1}^A \bullet \Phi |i\rangle \langle i|a\rangle & & \langle b|
 \end{array} \quad (26)$$

Here  $\bullet \Phi |i\rangle = \sum_{j=1}^B \langle j|\langle j|\Phi|i\rangle$  is the  $i$ -th column of  $\Phi$ , transposed into a row, whereas  $\langle j|\Phi \bullet = \sum_{i=1}^A \langle j|\Phi|i\rangle \langle i|$  is its  $j$ -th row vector, transposed into a column.

<sup>3</sup>If  $R$  were not a *real* closed field, the inner product would involve a conjugate in the first argument. Although this is for most people the more familiar situation, the adjunctions here do not depend on conjugations, so we omit them.

### 3.2.2 Factorizations

The maps in (26) induce the functor  $MA_1 : \text{Mat}_1 \rightarrow \text{Adj}_1$ , for  $\mathbb{A} = R^A$  and  $\mathbb{B} = R^B$ . This functor is, of course, tacit in the practice of representing linear operators by matrices, and identifying them notationally. The functors  $AM_1 : \text{Adj}_1 \rightarrow \text{Mnd}_1$  and  $AC_1 : \text{Adj}_1 \rightarrow \text{Cmn}_1$ , on the other hand, require factoring linear operators through their rank spaces:

$$\begin{array}{ccc}
 & \mathbb{A} & \xleftarrow{U} \mathbb{B}^{\vec{\Phi}} \\
 & \uparrow \text{AM}_1(\Phi) & \nearrow \text{AC}_1(\Phi)^\ddagger \\
 \mathbb{A}^{\overleftarrow{\Phi}} & \xrightarrow{V} \mathbb{B} & 
 \end{array}
 \quad \text{with} \quad
 \begin{array}{c}
 \Phi \\
 \dashv \\
 \Phi^\ddagger
 \end{array}
 \quad (27)$$

where we define

$$\begin{aligned}
 \mathbb{B}^{\vec{\Phi}} &= \{ \Phi^\ddagger | b \rangle \mid |b\rangle \in \mathbb{B} \} \quad \text{with} \quad \langle x | y \rangle_{\mathbb{B}^{\vec{\Phi}}} = \langle Ux | Uy \rangle_{\mathbb{A}} \\
 \mathbb{A}^{\overleftarrow{\Phi}} &= \{ \Phi | a \rangle \mid |a\rangle \in \mathbb{A} \} \quad \text{with} \quad \langle x | y \rangle_{\mathbb{A}^{\overleftarrow{\Phi}}} = \langle Vx | Vy \rangle_{\mathbb{B}}
 \end{aligned}$$

It is easy to see that the adjoints  $EM_1 : \text{Mnd}_1 \rightarrow \text{Adj}_1$  and  $KC_1 : \text{Cmn}_1 \rightarrow \text{Adj}_1$  can be viewed as inclusions. To define  $MN_1 : \text{Mnd}_1 \rightarrow \text{Nuc}_1$  and  $CN_1 : \text{Cmn}_1 \rightarrow \text{Nuc}_1$ , note that

$$\langle U^\ddagger Ux | y \rangle_{\mathbb{B}^{\vec{\Phi}}} = \langle Ux | Uy \rangle_{\mathbb{A}} = \langle x | y \rangle_{\mathbb{B}^{\vec{\Phi}}}$$

Since finite-dimensional Hilbert spaces are separable, this implies that  $U^\ddagger U = \text{id}$  and that  $U^\ddagger$  is thus a surjection. So we have two factorizations of  $\Phi$

$$\begin{array}{ccc}
 \mathbb{A} & \xrightarrow{U^\ddagger} & \mathbb{B}^{\vec{\Phi}} \\
 \downarrow \text{AC}_1(\Phi) & \nearrow \text{CN}_1 \circ \text{AC}_1(\Phi) = \text{MN}_1 \circ \text{AM}_1(\Phi) & \downarrow \text{AM}_1(\Phi) \\
 \mathbb{A}^{\overleftarrow{\Phi}} & \xrightarrow{V} & \mathbb{B}
 \end{array}
 \quad (28)$$

The definitions of  $CN_1$  and  $MN_1$  for general objects of  $\text{Cmn}_1$  and  $\text{Mnd}_1$  proceed similarly, by factoring the adjoints.

### 3.3 Nucleus as matrix diagonalization

When the field  $R$  supports spectral decomposition, the above factorizations can be performed directly on matrices. The nucleus of a matrix then arises as its diagonal form. In linear algebra, the process of the nucleus extraction thus boils down to the Singular Value Decomposition (SVD) of a matrix [34, Sec. 2.4], which is yet another tool of concept analysis [5, 21].

To set up this version of the nucleus setting we take  $\text{Adj}_2 = \text{Mat}_2 = \text{Mat}_1$  and let  $\text{MA}_2 : \text{Mat}_2 \rightarrow \text{Adj}_2$  be the identity. The categories  $\text{Mnd}_2$  and  $\text{Cmn}_2$  will again be full subcategories of  $\text{Adj}_2$ , this time spanned by

$$\text{Mnd}_2 = \{ \Phi \in \text{Set}(\dot{A} \times \dot{B}, R) \mid \langle k | \vec{\Phi} | \ell \rangle = \lambda_k \langle k | \ell \rangle \} \quad (29)$$

$$\text{Cmn}_2 = \{ \Phi \in \text{Set}(\dot{A} \times \dot{B}, R) \mid \langle i | \overleftarrow{\Phi} | j \rangle = \lambda_j \langle i | j \rangle \} \quad (30)$$

where

- $\vec{\Phi} = \Phi \Phi^\ddagger$  and  $\overleftarrow{\Phi} = \Phi^\ddagger \Phi$ , with the entries  $\langle k | \vec{\Phi} | \ell \rangle = \vec{\Phi}_{k\ell} \langle i | \overleftarrow{\Phi} | j \rangle = \overleftarrow{\Phi}_{ij}$ ,

- $\langle i | j \rangle = \begin{cases} 1 & \text{if } i = j \\ 0 & \text{otherwise} \end{cases}$ , and

- $\lambda_k$  and  $\lambda_j$  are scalars.

In the theory of Banach spaces, operators that yield to this type of representation have been called nuclear since [36]. Hence our terminology. For finite-dimensional spaces, definitions (29-30) say that for a matrix  $\Phi \in \text{Mat}_2$  holds that

$$\begin{aligned} \Phi \in \text{Mnd}_2 &\iff \vec{\Phi} \text{ is diagonal} \\ \Phi \in \text{Cmn}_2 &\iff \overleftarrow{\Phi} \text{ is diagonal} \end{aligned}$$

Since both  $\overleftarrow{\Phi}$  and  $\vec{\Phi}$  are self-adjoint:

$$\begin{aligned} \langle \Phi^\ddagger \Phi a \mid a' \rangle &= \langle \Phi a \mid \Phi a' \rangle = \langle \Phi^\ddagger \ddagger a \mid \Phi a' \rangle = \langle a \mid \Phi^\ddagger \Phi a' \rangle \\ \langle b \mid \Phi \Phi^\ddagger b' \rangle &= \langle \Phi^\ddagger b \mid \Phi^\ddagger b' \rangle = \langle \Phi^\ddagger b \mid \Phi^\ddagger \ddagger b' \rangle = \langle \Phi^\ddagger \ddagger b \mid b' \rangle = \langle \Phi \Phi^\ddagger b \mid b' \rangle \end{aligned}$$

their spectral decompositions yield real eigenvalues  $\lambda$ . Assuming for simplicity that each of their eigenvalues has a one-dimensional eigenspace, we define

$$\dot{A}^{\overleftarrow{\Phi}} = \{ |v\rangle \in R^{\dot{B}} \mid \langle v | v \rangle = 1 \wedge \exists \lambda_v. \overleftarrow{\Phi} |v\rangle = \lambda_v |v\rangle \} \quad (31)$$

$$\dot{B}^{\vec{\Phi}} = \{ |u\rangle \in R^{\dot{A}} \mid \langle u | u \rangle = 1 \wedge \exists \lambda_u. \vec{\Phi} |u\rangle = \lambda_u |u\rangle \} \quad (32)$$

Hence the matrices

$$\begin{array}{ccccc} \dot{B}^{\vec{\Phi}} \times \dot{A} & \xrightarrow{U} & R & \xleftarrow{V} & \dot{A}^{\overleftarrow{\Phi}} \times \dot{B} \\ \langle |u\rangle, i \rangle & \mapsto & u_i & v_\ell & \langle |v\rangle, \ell \rangle \end{array}$$

which isometrically embed  $\dot{B}^{\vec{\Phi}}$  into  $\mathbb{A} = R^{\dot{A}}$  and  $\dot{A}^{\overleftarrow{\Phi}}$  into  $\mathbb{B} = R^{\dot{B}}$ . It is now straightforward to show that  $\text{AM}_2 : \text{Adj}_2 \rightarrow \text{Mnd}_2$  and  $\text{AC}_2 : \text{Adj}_2 \rightarrow \text{Cmn}_2$  are still given according to the schema in (27), i.e. by

$$\check{\Phi} = \text{AM}_2(\Phi) = V^\ddagger \Phi \quad (33)$$

$$\hat{\Phi} = \text{AC}_2(\Phi) = \Phi U \quad (34)$$

They satisfy not only the requirements that  $\check{\Phi}^\dagger \check{\Phi}$  and  $\hat{\Phi} \hat{\Phi}^\ddagger$  be diagonal, as required by (29) and (30), but also that

$$\check{\Phi} \check{\Phi}^\dagger = \Phi \Phi^\dagger = \overleftarrow{\Phi} \qquad \hat{\Phi}^\dagger \hat{\Phi} = \Phi^\dagger \Phi = \overrightarrow{\Phi}$$

Repeating the diagonalization process on each of them leads to the following refinement of (27):

$$\begin{array}{ccccc}
 \dot{A} & \xleftarrow{U} & \dot{B}^{\overrightarrow{\Phi}} & \xleftarrow{\sim} & (\dot{A}^{\overleftarrow{\Phi}})^{\overrightarrow{\Phi}} \\
 \downarrow \Phi & \searrow \hat{\Phi} & \downarrow \check{\Phi} & \searrow \check{\Phi} & \downarrow \\
 \dot{B} & \xrightarrow{V^\ddagger} & \dot{A}^{\overleftarrow{\Phi}} & \xleftarrow{\sim} & (\dot{B}^{\overrightarrow{\Phi}})^{\overleftarrow{\Phi}} \\
 & & \downarrow \check{\Phi} & & \downarrow \\
 & & \text{MN}_2(\hat{\Phi}) & & \\
 & & \text{CN}_2(\check{\Phi}) & & 
 \end{array} \tag{35}$$

This diagram displays a bijection between the eigenvertors in  $\dot{B}^{\overrightarrow{\Phi}}$  and  $\dot{A}^{\overleftarrow{\Phi}}$ . The diagonal matrix between them is the nucleus of  $\Phi$ . The singular values along its diagonal measure, in a certain sense, how much the operators  $\overleftarrow{\Phi}$  and  $\overrightarrow{\Phi}$ , induced by composing  $\Phi$  and  $\Phi^\ddagger$ , deviate from being projectors onto the respective rank spaces.

### 3.4 Summary

The path from a matrix to its nucleus can now be summarized by

$$\begin{array}{c}
 \Phi : \dot{A} \times \dot{B} \rightarrow R \\
 \hline
 \begin{array}{ccc}
 R^{\dot{A}} & \xleftarrow{\Phi^\ddagger} & R^{\dot{B}} \\
 & \xrightarrow{\Phi} & 
 \end{array} \\
 \hline
 \begin{array}{ccc}
 R^{\dot{A}} & \xleftarrow{U = \mathfrak{M}_2 \Phi} & \dot{A}^{\overleftarrow{\Phi}} \\
 & \xrightarrow{\quad} & 
 \end{array}
 \qquad
 \begin{array}{ccc}
 \dot{B}^{\overrightarrow{\Phi}} & \xrightarrow{V = \mathfrak{C}_2 \Phi} & R^{\dot{B}} \\
 & \xrightarrow{\quad} & 
 \end{array} \\
 \hline
 \begin{array}{ccc}
 \dot{B}^{\overrightarrow{\Phi}} & \xrightarrow{\overleftarrow{\mathfrak{N}}_2 \Phi} & \dot{A}^{\overleftarrow{\Phi}} \\
 \uparrow U^\ddagger & & \downarrow V \\
 R^{\dot{A}} & \xrightarrow{\Phi} & R^{\dot{B}}
 \end{array}
 \end{array}$$

Note that the isomorphisms from (19) are now replaced by the diagonal matrix  $\overleftarrow{\mathfrak{N}}_1 \Phi : \dot{B}^{\overrightarrow{\Phi}} \xrightarrow{\sim} \dot{A}^{\overleftarrow{\Phi}}$ , which is still invertible as a linear operator, and provides a bijection between the bases  $\dot{B}^{\overrightarrow{\Phi}}$  and  $\dot{A}^{\overleftarrow{\Phi}}$  of the rank spaces of  $\Phi$  and of  $\Phi^\ddagger$ , respectively. But the singular values along the diagonal of

$\overleftarrow{\mathfrak{N}}_1\Phi$  quantify the relationships between the corresponding elements of  $\vec{B}^{\Phi}$  and  $\vec{A}^{\Phi}$ . This is, on the one hand, the essence of the concept analysis by singular value decomposition [60]. Even richer conceptual correspondences will, on the other hand, emerge in further examples.

## 4 Example 3: Nuclear Chu spaces

### 4.1 Abstract matrices

So far we have considered matrices in specific frameworks, first of posets, then of Hilbert spaces. In this section, we broaden the view, and study an abstract framework of matrices. Suppose that  $\mathcal{S}$  is a category with finite products,  $R \in \mathcal{S}$  is an object, and  $\dot{\mathcal{S}} \subseteq \mathcal{S}$  is a full subcategory. The objects of  $\dot{\mathcal{S}}$  are also marked by a dot, and are thus written  $\dot{A}, \dot{B}, \dots, \dot{X} \in \dot{\mathcal{S}}$ . Now consider the following variation on the theme of (4) and (21):

$$|\text{Mat}_3| = \coprod_{\dot{A}, \dot{B} \in \dot{\mathcal{S}}} \mathcal{S}(\dot{A} \times \dot{B}, R) \quad (36)$$

$$\text{Mat}_3(\Phi, \Psi) = \{ \langle f^*, f_* \rangle \in \dot{\mathcal{S}}(\dot{A}, \dot{C}) \times \dot{\mathcal{S}}(\dot{D}, \dot{B}) \mid \Phi(a, f_*d) = \Psi(f^*a, d) \}$$

where  $\Psi \in \mathcal{S}(\dot{C} \times \dot{D}, R)$ , as illustrated in Fig. 6. We consider a couple of examples.

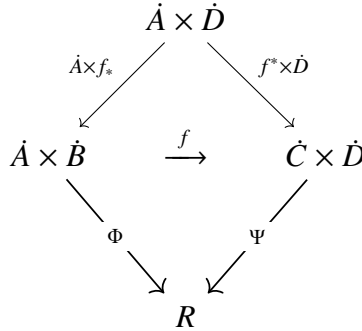

Figure 6: A Chu-morphism  $f = \langle f^*, f_* \rangle : \Phi \rightarrow \Psi$  in  $\text{Mat}_3$

#### 4.1.1 Posets

Let the category  $\mathcal{S} = \dot{\mathcal{S}}$  be the category  $\text{Pos}$  of posets, and let  $R$  be the poset  $\mathbb{2} = \{0 < 1\}$ . The poset matrices in  $\text{Mat}_3^{\text{Pos}}$  then differ from those in  $\text{Mat}_0$  by the fact that they are covariant in both arguments, i.e. they satisfy  $a' \widehat{\Phi} b' \wedge a' \leq a \wedge b' \leq b \implies a \widehat{\Phi} b$  instead of (6). Any poset  $A$  is represented both in  $\text{Mat}_0$  and in  $\text{Mat}_3^{\text{Pos}}$  by the matrix  $\binom{A}{\leq} : A^o \times A \rightarrow \mathbb{2}$ . But they are quite different objects in the different categories. If  $\binom{B}{\leq} : B^o \times B \rightarrow \mathbb{2}$  is another such matrix, then

- in  $\text{Mat}_0$ , a morphism in the form  $\langle h, k \rangle$  is required to satisfy  $x \stackrel{A}{\leq} x' \iff hx \stackrel{B}{\leq} kx'$  for all  $x, x' \in A$ , whereas
- in  $\text{Mat}_3^{\text{Pos}}$ , a morphism in the form  $\langle f^*, f_* \rangle$  is required to satisfy  $x \leq f_* y \iff f^* x \leq y$  for all  $x \in A$  and  $y \in B$ .

The  $\text{Mat}_3^{\text{Pos}}$  isomorphisms are thus the poset adjunctions (a.k.a. Galois connections), whereas the  $\text{Mat}_0$ -morphisms in the form  $\langle h, h \rangle$  are the order isomorphisms.

#### 4.1.2 Linear spaces

Let  $\mathcal{S}$  be the category **Set** of sets,  $\dot{\mathcal{S}}$  the category  $\dot{\mathbf{S}}\text{et}$  of finite sets, and let  $R$  be the set of real numbers. Then the objects of  $\text{Mat}_3^{\text{Lin}}$  are the real matrices, just like in  $\text{Mat}_1$ , but the morphisms in  $\text{Mat}_3^{\text{Lin}}$  are a very special case of those in  $\text{Mat}_1$ . A  $\text{Mat}_1$ -morphism  $\langle H, K \rangle$  from (21) boils down to a pair of functions  $\langle f^*, f_* \rangle$  from (36) precisely when the matrices  $H$  and  $K$  comprise of 0s, except that  $H$  has precisely one 1 in every row, and  $K$  has precisely one 1 in every column. With such constrained morphisms,  $\text{Mat}_3^{\text{Lin}}$  does not support the factorizations on which the constructions in  $\text{Mat}_1$  were based. The completions will afford it more flexible morphisms.  $\text{Mat}_1$ 's morphisms are already complete matrices, which is why we were able to take  $\text{Adj}_2 = \text{Mat}_2 = \text{Mat}_1$ .

#### 4.1.3 Categories

Let  $\mathcal{S}$  be the category **CAT** of categories, small or large; let  $R$  be the category **Set** of sets; and let  $\dot{\mathcal{S}}$  be the category **Cat** of small categories. The matrices in  $\text{Mat}_3^{\text{CAT}}$  are then distributors [16, Vol. I, Sec. 7.8], also called profunctors, or bimodules. The  $\text{Mat}_3^{\text{CAT}}$ -morphisms are generalized adjunctions, as discussed in [50]. Any small category  $\dot{\mathbb{A}}$  occurs as the matrix  $\text{hom}_{\dot{\mathbb{A}}} \in \text{CAT}(\dot{\mathbb{A}}^o \times \dot{\mathbb{A}}, \text{Set})$  in  $\text{Mat}_3^{\text{CAT}}$ . The  $\text{Mat}_3^{\text{CAT}}$ -morphisms between the matrices in the form  $\text{hom}_{\dot{\mathbb{A}}}$  and  $\text{hom}_{\dot{\mathbb{B}}}$  are precisely the adjunctions between the categories  $\dot{\mathbb{A}}$  and  $\dot{\mathbb{B}}$ .

### 4.2 Representability and completions

A matrix  $\Phi : \dot{A} \times \dot{B} \rightarrow R$  is said to be *representable* when there are matrices  $\mathbb{A} : \dot{A} \times \dot{A} \rightarrow R$  and  $\mathbb{B} : \dot{B} \times \dot{B} \rightarrow R$  and a morphism  $f = \langle f^*, f_* \rangle \in \text{Mat}_3(\mathbb{A}, \mathbb{B})$  such that  $\Phi = \mathbb{A} \circ (\dot{A} \times f_*) = \mathbb{B}(f^* \times \dot{B})$ . Inside the category  $\text{Mat}_3$ , this means that the morphism  $f$  can be factorized through  $\Phi$ , as displayed in Fig. 7. Inside  $\text{Mat}_3^{\text{CAT}}$ , a distributor  $\Phi : \dot{\mathbb{A}}^o \times \mathbb{B} \rightarrow \text{Set}$  is representable if and only if there is an adjunction  $F^* \dashv F_* : \mathbb{B} \rightarrow \dot{\mathbb{A}}$  such that  $\mathbb{A}(x, F_* y) = \Phi(x, y) = \mathbb{B}(F^* x, y)$ .

### 4.3 Abstract adjunctions

In the category of adjunctions  $\text{Adj}_3$ , all matrices from  $\text{Mat}_3$  become representable. This is achieved by dropping the "finiteness" requirement  $\dot{A}, \dot{B}, \dot{C}, \dot{D} \in \dot{\mathcal{S}}$  from  $\text{Mat}_3$ , and defining

$$\begin{aligned}
|\text{Adj}_3| &= \coprod_{A, B \in \mathcal{S}} \mathcal{S}(A \times B, R) \\
\text{Adj}_3(\Phi, \Psi) &= \{ \langle f^*, f_* \rangle \in \mathcal{S}(A, C) \times \mathcal{S}(D, B) \mid \Psi(f^* a, d) = \Phi(a, f_* d) \}
\end{aligned} \tag{37}$$

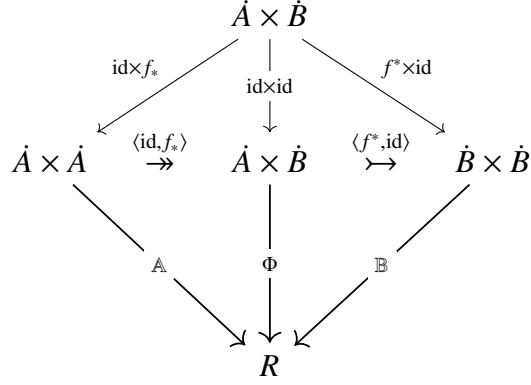

Figure 7: A matrix  $\Phi$  representable in  $\text{Mat}_3$  by factoring  $\langle f^*, f_* \rangle = \left( \mathbb{A} \xrightarrow{\langle \text{id}, f_* \rangle} \Phi \xrightarrow{\langle f^*, \text{id} \rangle} \mathbb{B} \right)$

### 4.3.1 The Chu-construction

The readers familiar with the Chu-construction will recognize  $\text{Adj}_3$  as  $\text{Chu}(\mathcal{S}, R)$ . The Chu-construction is a universal embedding of monoidal categories with a chosen dualizing object into  $*$ -autonomous categories. It was spelled out by Barr and his student Chu [9], and extensively studied in topological duality theory and in semantics of linear logic [10, 11, 12, 13, 22, 68, 77, 84]. Its conceptual roots go back to the early studies of infinite-dimensional vector spaces [68]. Our category  $\text{Mat}_3$  can be viewed as a "finitary" part of a Chu-category, where an abstract notion of "finiteness" is imposed by requiring that the matrices are sized by a "finite" category  $\dot{\mathcal{S}} \subset \mathcal{S}$ .

### 4.3.2 Representing matrices as adjunctions

The functor  $\text{MA}_3 : \text{Mat}_3 \rightarrow \text{Adj}_3$  will be the obvious embedding. When  $\dot{\mathcal{S}} = \mathcal{S}$ , it boils down to the identity. The difference between (36) and (37) is technically, of course, a minor wrinkle. But when the object  $R$  is exponentiable, in the sense that there is a functor  $R^{(-)} : \dot{\mathcal{S}}^o \rightarrow \mathcal{S}$  such that

$$\mathcal{S}(\dot{A} \times \dot{B}, R) \cong \mathcal{S}(\dot{A}, R^{\dot{B}}) \quad (38)$$

holds naturally in  $\dot{A}$  and  $\dot{B}$ , then the  $\text{Mat}_3$ -matrices can be represented as  $\text{Adj}_3$ -morphisms. Each matrix appears in four avatars

$$\begin{array}{cccc} \mathcal{S}(\dot{A}, R^{\dot{B}}) & \cong & \mathcal{S}(\dot{A} \times \dot{B}, K) & \cong & \mathcal{S}(\dot{B} \times \dot{A}, K) & \cong & \mathcal{S}(\dot{B}, R^{\dot{A}}) \\ \Downarrow & & \Downarrow & & \Downarrow & & \Downarrow \\ \Phi^* & & \Phi & & \Phi^\ddagger & & \Phi_* \end{array} \quad (39)$$

and the leftmost and the rightmost represent it as the abstract adjunction in Fig. 8. The objects  $R^{\dot{A}}$  and  $R^{\dot{B}}$ , that live in  $\mathcal{S}$  but not in  $\dot{\mathcal{S}}$  will play a similar role to  $\Downarrow A$  and  $\Uparrow B$  in Sec. 2, and to the eponymous Hilbert spaces Sec. 3. They are the abstract "completions". We come back to this in Sec. 4.5.



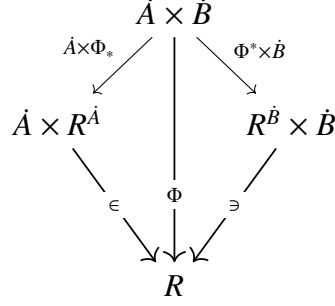

Figure 8: The adjunction  $(\Phi^* \dashv \Phi_*) \in \text{Adj}_3(\in_A, \ni_B)$  representing the matrix  $\Phi : A \times B \rightarrow R$  from  $\text{Mat}_3$

### 4.3.3 Separated and extensional adjunctions

The correspondences in (39) assert that any matrix  $\Phi : A \times B \rightarrow R$  can be viewed as

- a map  $A \xrightarrow{\Phi^*} R^B$ , assigning a "matrix row"  $\Phi^*(a)$  to each basis element  $a \in A$ ;
- a map  $B \xrightarrow{\Phi_*} R^A$ , assigning a "matrix column"  $\Phi_*(b)$  to each basis element  $b \in B$ .

The elements  $a$  and  $a'$  are indistinguishable for  $\Phi$  if  $\Phi^*(a) = \Phi^*(a')$ ; and the elements  $b$  and  $b'$  are distinguishable for  $\Phi$  if  $\Phi_*(b) = \Phi_*(b')$ . The idea of Barr's *separated-extensional* Chu construction [10, 12] is to quotient out any indistinguishable elements. A Chu space is called

- *separated* if  $\Phi^*(a) = \Phi^*(a') \Rightarrow a = a'$ , and
- *extensional* if  $\Phi_*(b) = \Phi_*(b') \Rightarrow b = b'$ .

To formalize this idea, we assume the category  $\mathcal{S}$  is given with a family  $\mathcal{M}$  of abstract monics, so that  $\Phi$  is separated if  $\Phi^* \in \mathcal{M}$  and extensional if  $\Phi_* \in \mathcal{M}$ . To extract such an  $\mathcal{M}$ -separated-extensional nucleus from any given  $\Phi$ , the family  $\mathcal{M}$  is given as a part of a *factorization system*  $\mathcal{E} \wr \mathcal{M}$ , such that  $R^{\mathcal{E}} \subseteq \mathcal{M}$ . For convenience, an overview of factorization systems is given in Appendix A. The construction yields an instance of Fig. 3 for the full subcategories of  $\text{Adj}_3$  defined by

$$\text{Mnd}_3 = \{\Phi \in \text{Adj}_3 \mid \Phi^* \in \mathcal{M}\} = \text{Chu}_s(\mathcal{S}, R) \quad (40)$$

$$\text{Cmn}_3 = \{\Phi \in \text{Adj}_3 \mid \Phi_* \in \mathcal{M}\} = \text{Chu}_e(\mathcal{S}, R) \quad (41)$$

$$\text{Nuc}_3 = \{\Phi \in \text{Adj}_3 \mid \Phi^*, \Phi_* \in \mathcal{M}\} = \text{Chu}_{se}(\mathcal{S}, R) \quad (42)$$

where  $\text{Chu}_s(\mathcal{S}, R)$  and  $\text{Chu}_e(\mathcal{S}, R)$  are the full subcategories of  $\text{Chu}(\mathcal{S}, R)$  spanned, respectively, by the separated and the extensional Chu spaces, as constructed in [10, 12]. The reflections and coreflections, induced by the factorization, have been analyzed in detail there. The separated-extensional nucleus of a matrix is constructed through the factorizations displayed in Fig. 9, where we use Barr's notation. The functor  $\text{AM}_3$  corresponds to Barr's  $\text{Chu}_s$ , the functor  $\text{AC}_3$  to  $\text{Chu}_e$ . Proving that  $A' \cong A''$  and  $B' \cong B''$  gives the nucleus  $\text{Chu}_{se}(\Phi) = \text{Chu}_{es}(\Phi)$  in  $\text{Nuc}_3$ .

$$\begin{array}{c}
A \times B \xrightarrow{\Phi} R \\
\hline
A \xrightarrow{\Phi^*} R^B \quad B \xrightarrow{\Phi_*} R^A \\
\hline
A \xrightarrow{\mathcal{E}(\Phi^*)} \gg A' \xrightarrow{\text{Chu}_s(\Phi)} R^B \quad B \xrightarrow{\mathcal{E}(\Phi_*)} \gg B' \xrightarrow{\text{Chu}_e(\Phi)} R^A \\
\hline
B \xrightarrow{\mathcal{E}(\text{Chu}_s(\Phi))} \gg B'' \xrightarrow{\text{Chu}_w(\Phi)} R^{A'} \quad A \xrightarrow{\mathcal{E}(\text{Chu}_e(\Phi))} \gg A'' \xrightarrow{\text{Chu}_w(\Phi)} R^{B'}
\end{array}$$

Figure 9: Overview of the separated-extensional Chu construction

## 4.4 What does the separated-extensional nucleus capture in examples 4.1?

### 4.4.1 Posets

Restricted to the poset matrices in the form  $A^o \times B \xrightarrow{\Phi} \mathbb{2}$ , as explained in Sec. 4.1.1, the separated-extensional nucleus construction gives the same output as the concept lattice construction in Sec. 2. The factorizations  $\text{Chu}_s$  and  $\text{Chu}_e$  in Fig. 9 correspond to the extensions  $\Phi^*$  and  $\Phi_*$  in (11).

### 4.4.2 Linear spaces

Extended from finite bases to the entire spaces generated by them, the Chu view of the linear algebra example in 4.1.2 captures the rank space factorization and  $\text{NUC}_1$ , but the spectral decomposition into  $\text{NUC}_2$  requires a suitable completeness assumption on  $R$ .

### 4.4.3 Categories

The separated-extensional nucleus construction does not seem applicable to the categorical example in 4.1.3 directly, as none of the familiar functor factorization systems satisfy the requirement  $R^\mathcal{E} \subseteq \mathcal{M}$ . This provides an opportunity to explore the role of factorizations in extracting the nuclei. In Sec. 4.5 we explore a variation on the theme of the factorization-based nucleus. In Sec. 4.6 we spell out a modified version of the separated-extensional nucleus construction that does apply to the categorical example in 4.1.3.

## 4.5 Discussion: Combining factorization-based approaches

Some factorization-based nuclei, in the situations when the requirement  $R^\mathcal{E} \subseteq \mathcal{M}$  is not satisfied, arise from a combination of the separated-extensional construction from Sec. 4.3.1 and the diagonalization factoring from Sec. 3.

### 4.5.1 How nuclei depend on factorizations?

As explained in the Appendix, every factorization system  $\mathcal{E} \wr \mathcal{M}$  in any category  $\mathcal{S}$  can be viewed as an algebra for the Arr-monad, where  $\text{Arr}(\mathcal{S}) = \mathcal{S}/\mathcal{S}$  is the category consisting of the  $\mathcal{S}$ -arrows as objects, and the pairs of arrows forming commutative squares as the morphisms. An arbitrary factorization system  $\mathcal{E} \wr \mathcal{M}$  on  $\mathcal{S}$  thus corresponds to an algebra  $\wr : \mathcal{S}/\mathcal{S} \rightarrow \mathcal{S}$ ; and a factorization system that satisfies the requirements for the separated-extensional Chu construction lifts to an algebra  $\wr : \text{Adj}_3/\text{Adj}_3 \rightarrow \text{Adj}_3$ . To see this, note the natural bijection  $\mathcal{S}(A \times B, R) \cong \mathcal{S}(A, R^B)$  induces an isomorphism of  $\text{Adj}_3 = \text{Chu}(\mathcal{S}, R)$  with the comma category  $\mathcal{S}R = \mathcal{S}/R^{(-)}$ , whose arrows are in the form

$$\begin{array}{ccc}
 A & \xrightarrow{f^*} & C \\
 \varphi \downarrow & & \downarrow \psi \\
 R^B & \xrightarrow{R^{f^*}} & R^D \\
 B & \xleftarrow{f} & D
 \end{array} \tag{43}$$

Such squares permit  $\mathcal{E} \wr \mathcal{M}$ -factorization whenever  $R^{\mathcal{E}} \subseteq \mathcal{M}$ . If we now set

$$\text{Mat}_4 = \text{Adj}_3 \tag{44}$$

$$\text{Adj}_4 = \text{Adj}_3/\text{Adj}_3 \tag{45}$$

then the isomorphism  $\text{Adj}_3 \cong \mathcal{S}R$  lifts to  $\text{Adj}_4 \cong \mathcal{S}R/\mathcal{S}R$ . The objects of  $\text{Adj}_4$  can thus be viewed as the squares in the form (43), and the object part of the abstract completion functor  $\text{MA}_4 : \text{Mat}_4 \rightarrow \text{Adj}_4$  can be defined as in Fig. 10. One immediate consequence is that the two factorization

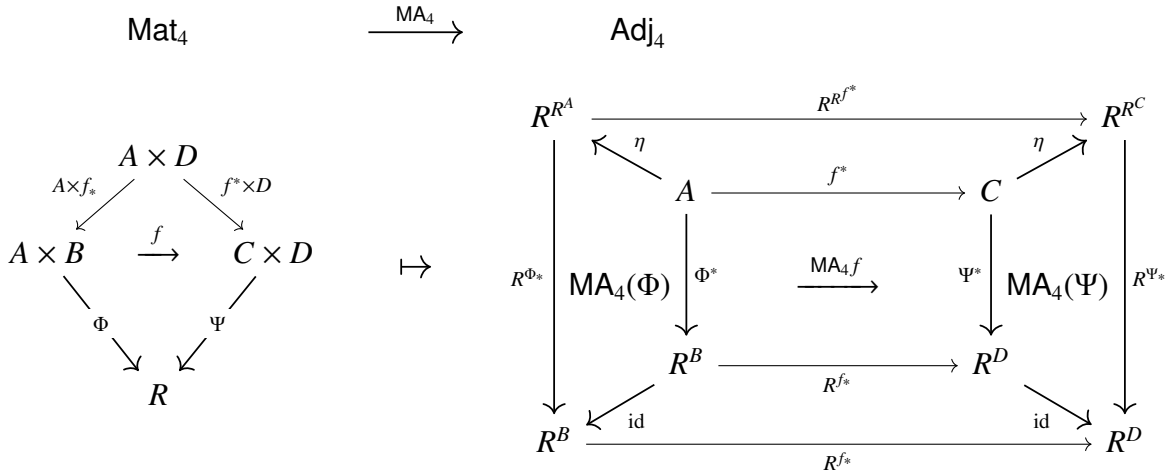

Figure 10: The abstract completion functor  $\text{MA}_4 : \text{Mat}_4 \rightarrow \text{Adj}_4$

steps of the two-step separated-and-extensional construction  $\overleftarrow{\mathfrak{N}}_3 = \text{Chu}_{se}$ , summarized in Fig. 9,

can now be obtained in a single sweep, by directly composing the completion with the factorization

$$\overleftarrow{\mathfrak{N}}_3 = \left( \text{Adj}_3 \xrightarrow{\text{MA}_4} \text{Adj}_3 / \text{Adj}_3 \xrightarrow{\wr} \text{Adj}_3 \right) \quad (46)$$

The fixed points of this functor are just the separated-extensional nuclei. This is, of course, just another presentation of the same thing; and perhaps a wrongheaded one, as it folds the two steps of the nucleus construction into one. These two steps are displayed as the two paths from left to right through Fig. 3, corresponding to the two orders in which the steps can be taken; and of course as the separate part and the extensional part of the separate-extensional Chu-construction. The commutativity of the two steps is, in a sense, the heart of the matter. However, packaging a nucleus construction into one step allows packaging two such constructions into one. What might that be useful for?

When  $\mathcal{S}$  is, say, a category of topological spaces, and  $\mathcal{E} \wr \mathcal{M}$  the the dense-closed factorization, then it may happen that the separated-extensional nucleus of a space is much bigger than the original space. If the nucleus  $\overleftarrow{\mathfrak{N}}_3\Phi : A' \times B' \rightarrow R$  of a matrix  $\Phi : A \times B \rightarrow R$  is constructed by factoring  $A \xrightarrow{\Phi^*} R^B$  and  $B \xrightarrow{\Phi_*} R^A$  into

$$A \twoheadrightarrow A' \xrightarrow{\overleftarrow{\mathfrak{N}}_3\Phi^*} R^{B'} \twoheadrightarrow R^B \quad B \twoheadrightarrow B' \xrightarrow{\overleftarrow{\mathfrak{N}}_3\Phi_*} R^{A'} \twoheadrightarrow R^A$$

as in Fig. 9, then  $A$  and  $B$  can be dense spaces of rational numbers, and  $A'$  and  $B'$  can be their closures in the space of real numbers, representable within both  $R^A$  and  $R^B$  for a cogenerator  $R$ . The same effect occurs if we take  $\mathcal{S}$  to be posets, and in many other situations where the  $\mathcal{E}$ -maps are not quotients. One way to sidestep the problem might be to strengthen the requirements.

#### 4.5.2 Exercise

Given a matrix  $A \times B \xrightarrow{\Phi} R$ , find a nucleus  $A' \times B' \xrightarrow{L\Phi} R$  such that

- (a)  $A \twoheadrightarrow A'$  and  $B \twoheadrightarrow B'$  are quotients, whereas
- (b)  $A' \xrightarrow{\Phi^*} R^{B'}$  and  $B' \xrightarrow{\Phi_*} R^{A'}$  are closed embeddings.

Requirement (b) is from the separated-extensional construction in Sec. 4.3.1, whereas requirement (a) is from the diagonalization factoring in Sec. 3).

#### 4.5.3 Workout

Suppose that category  $\mathcal{S}$  supports two factorization systems:

- $\mathcal{E} \wr \mathcal{M}^\bullet$ , where  $\mathcal{M}^\bullet \subseteq \mathcal{M}$  are the regular monics (embeddings, equalizers), and
- $\mathcal{E}^\bullet \wr \mathcal{M}$ , where  $\mathcal{E}^\bullet \subseteq \mathcal{E}$  are the regular epis (quotients, coequalizers).

In balanced categories, these factorizations would coincide, because  $\mathcal{M}^\bullet = \mathcal{M}$  and  $\mathcal{E}^\bullet = \mathcal{E}$ , and we would be back to the situation where the separated-extensional construction applies. In general, the two factorizations can be quite different, like in the category of topological spaces. Nevertheless, since homming into the exponentiable object  $R$  is a contravariant right adjoint functor, it maps coequalizers to equalizers. Assuming that  $R$  is an injective cogenerator, it also maps general epis to monics, and vice versa. So we have

$$R^{\mathcal{E}^\bullet} \subseteq \mathcal{M}^\bullet \qquad R^{\mathcal{E}} \subseteq \mathcal{M} \qquad R^{\mathcal{M}} \subseteq \mathcal{E} \qquad (47)$$

However,  $\mathcal{E}^\bullet$  and  $\mathcal{M}^\bullet$  generally do not form a factorization system, because there are maps that do not have a quotient-embedding decomposition; and  $\mathcal{E}$  and  $\mathcal{M}$  do not form a factorization system because there are maps whose epi-mono decomposition is not unique. The factorization  $\mathcal{E}^\bullet \wr \mathcal{E}$  does satisfy  $R^{\mathcal{E}^\bullet} \subseteq \mathcal{M}$ , but does not lift from  $\mathcal{S}/\mathcal{S} \rightarrow \mathcal{S}$  to  $\text{Chu}/\text{Chu} \rightarrow \text{Chu}$ .

Our next nucleus setting will be full subcategories again:

$$\text{Mnd}_4 = \{ \langle f^*, f_* \rangle \in \text{Adj}_4 \mid f^* \in \mathcal{M}, f_* \in \mathcal{E} \} \qquad (48)$$

$$\text{Cmn}_4 = \{ \langle f^*, f_* \rangle \in \text{Adj}_4 \mid f^* \in \mathcal{E}, f_* \in \mathcal{M} \} \qquad (49)$$

These two categories are dual, just like  $\text{Mnd}_1$  and  $\text{Cmn}_1$  were dual. In both cases, they are in fact the same category, since switching between  $\Phi$  and  $\Phi^\ddagger$  in (23-24) and between  $f^*$  and  $f_*$  in (48-49) is a matter of notation. But distinguishing the two copies of the category on the two ends of the duality makes it easier to define one as a reflexive and the other one as a coreflexive subcategory of the category of adjunctions.

The functors  $\text{EM}_4 : \text{Mnd}_4 \hookrightarrow \text{Adj}_4$  and  $\text{KC}_4 : \text{Cmn}_4 \hookrightarrow \text{Adj}_4$  are again the obvious inclusions. The reflection  $\text{AM}_4 : \text{Adj}_4 \twoheadrightarrow \text{Mnd}_4$  and the coreflection  $\text{AC}_4 : \text{Adj}_4 \twoheadrightarrow \text{Cmn}_4$  are constructed in Fig. 11. The factoring triangles on are related in a similar way to the two factoring triangles in (27). The nucleus is obtained by composing them, in either order. More precisely, the coreflection  $\text{NM}_4 : \text{Mnd}_4 \twoheadrightarrow \text{Nuc}_4$  is obtained by restricting the coreflection  $\text{AC}_4 : \text{Adj}_4 \twoheadrightarrow \text{Cmn}_4$  along the inclusion  $\text{EM}_4 : \text{Mnd}_4 \hookrightarrow \text{Adj}_4$ ; the reflection  $\text{NC}_4 : \text{Cmn}_4 \twoheadrightarrow \text{Nuc}_4$  is obtained by restricting  $\text{AM}_4 : \text{Adj}_4 \twoheadrightarrow \text{Mnd}_4$  along the inclusion  $\text{KC}_4 : \text{Cmn}_4 \hookrightarrow \text{Adj}_4$ . The outcome is in Fig. 12. The category of nuclear Chu spaces is thus the full subcategory spanned by

$$\text{Nuc}_4 = \{ \langle f^*, f_* \rangle \in \text{Adj}_4 \mid f^*, f_* \in \mathcal{E} \cap \mathcal{M} \} \qquad (50)$$

If a factorization does not support the separated-extensional Chu-construction because it is not stable under dualizing, but if it is dual with another factorization, like e.g. the isometric-diagonal factorization in the category of finite-dimensional Hilbert spaces in Sec. 3, then the nucleus can still be constructed, albeit not as a subcategory of the original category, but of its arrow category. While the original separated-extensional Chu-construction yields a full subcategory  $\text{Chu}_{se} \subseteq \text{Chu}$ , here we get the Chu-nucleus as a full subcategory  $\overleftarrow{\mathfrak{N}}_4 \subseteq \text{Chu}/\text{Chu}$ . A Chu-nucleus is thus an arrow  $\langle \mathcal{EM}(\Phi^*), \mathcal{EM}(\Phi_*) \rangle \in \text{Chu}(\Phi', \Phi'')$ , as seen in Fig. 12, such that

- (a)  $A \twoheadrightarrow A'$  and  $B \twoheadrightarrow B''$  are in  $\mathcal{E}^\bullet$ ,
- (b)  $B' \xleftarrow{\tilde{\Phi}'} R^{A'}$  and  $A'' \xleftarrow{\Phi''} R^{B''}$  are in  $\mathcal{M}^\bullet$ ,

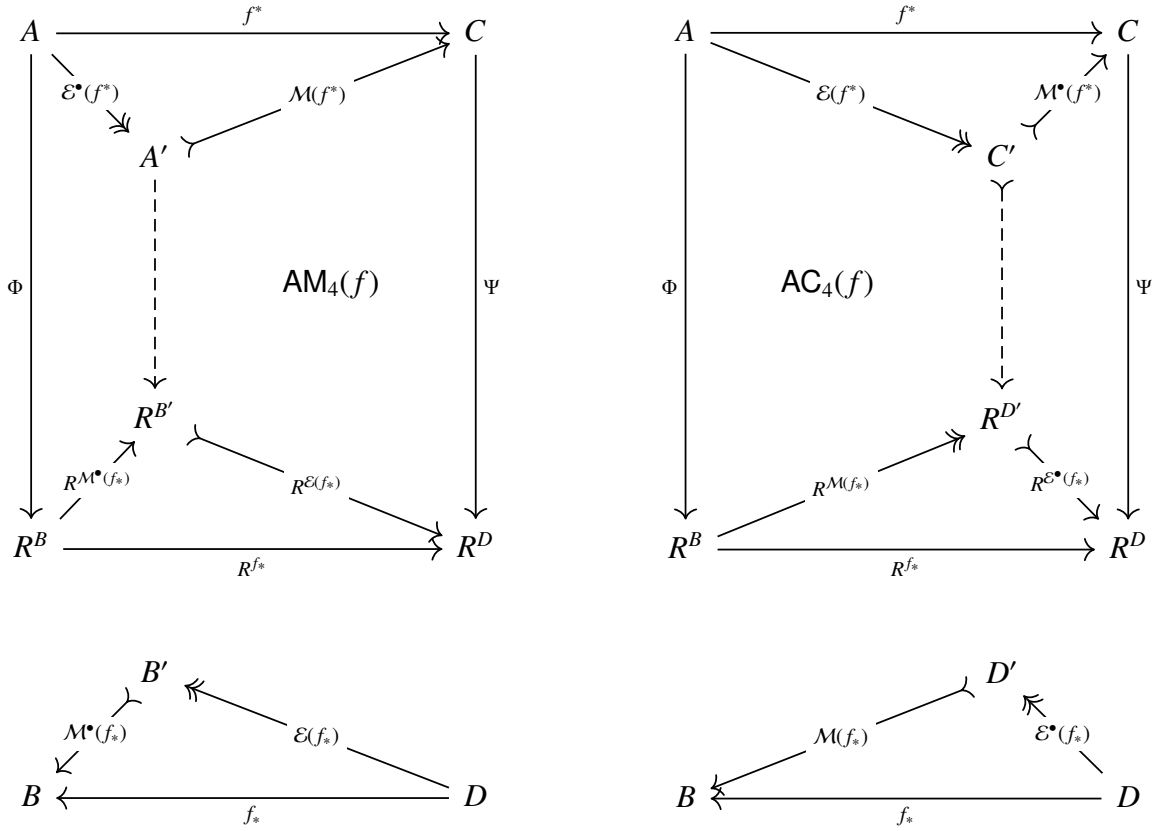

Figure 11: The object parts of the functors  $AM_4 : \text{Adj}_4 \rightarrow \text{Mnd}_4$  and  $AC_4 : \text{Adj}_4 \rightarrow \text{Cmn}_4$

(c)  $A' \xrightarrow{\Phi'} R^{B'}$  and  $B'' \xrightarrow{\tilde{\Phi}''} R^{A''}$  are in  $\mathcal{M}$ ,

(d)  $\mathcal{EM}(\Phi^*)$  and  $\mathcal{EM}(\Phi_*)$  are in  $\mathcal{E} \cap \mathcal{M}$ .

where  $B' \xrightarrow{\tilde{\Phi}'} R^{A'}$  is the transpose of  $A' \xrightarrow{\Phi'} R^{B'}$ , and  $B'' \xrightarrow{\tilde{\Phi}''} R^{A''}$  is the transpose of  $A'' \xrightarrow{\Phi''} R^{B''}$ . According to (d), Chu spaces  $\mathcal{EM}(\Phi^*)$  and  $\mathcal{EM}(\Phi_*)$  are thus monics in one factorization system and epis in another one, like the diagonalizations were in diagram (28) in Sec. 3. According to (a) and (b),  $\mathcal{EM}(\Phi^*)$  and  $\mathcal{EM}(\Phi_*)$  are moreover the best such approximations of  $\Phi^*$  and  $\Phi_*$ , as their largest quotients and embeddings, like the diagonalizations were, according to (27) and (35). The difference between the current situation and the one in one in Sec. 3, is that the diagonal nucleus there was self-dual, whereas  $\mathcal{EM}(\Phi^*)$  and  $\mathcal{EM}(\Phi_*)$  are not, but they are rather dual to one another. It also transposes  $\Phi'$  and  $\Phi''$ , and the transposition does not preserve regularity, but in this case it switches the  $\mathcal{M}^*$ -map with the  $\mathcal{M}$ -map. Intuitively, the nucleus  $\overleftarrow{\mathfrak{N}}_4\Phi$  can thus be thought as the best approximation of a diagonalization, in situations when the spectra of the two self-adjoints induced by a matrix are not the same; or the best approximation of a separated-extensional core when  $\text{Chu}_{se}$  and  $\text{Chu}_{eS}$  do not coincide.



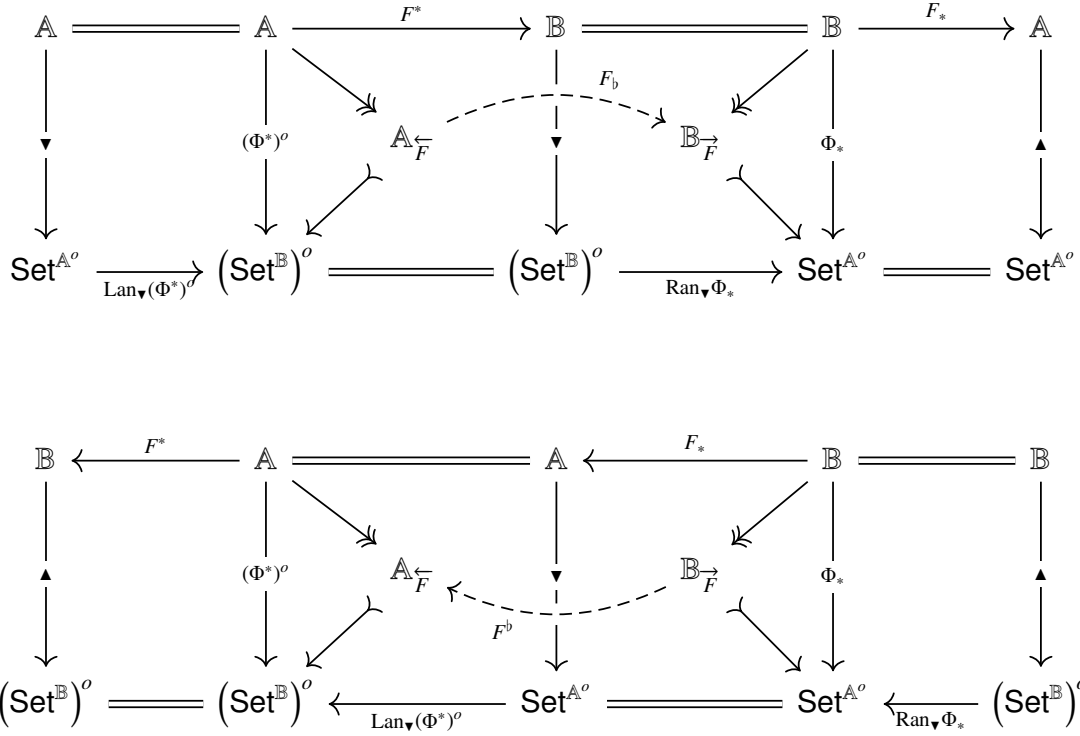

Figure 13: Separated-extensional nucleus + Kan extensions = Kleisli resolutions

- $\mathcal{M} = \text{Ffa} = \text{full-and-faithful functors}$

gives rise to the Kleisli categories  $\mathbb{A}_{\overleftarrow{F}}$  and  $\mathbb{B}_{\overrightarrow{F}}$  for the monad  $\overleftarrow{F} = F_*F^*$  and the comonad  $\overrightarrow{F} = F^*F_*$ , since

$$\begin{aligned}
 |\mathbb{A}_{\overleftarrow{F}}| &= |\mathbb{A}| & |\mathbb{A}_{\overrightarrow{F}}| &= |\mathbb{B}| \\
 \mathbb{A}_{\overleftarrow{F}}(x, x') &= \mathbb{B}(F^*x, F^*x') & \mathbb{B}_{\overrightarrow{F}}(y, y') &= \mathbb{A}(F_*y, F_*y')
 \end{aligned} \tag{51}$$

It is easy to see that this is equivalent to the usual Kleisli definitions, since  $\mathbb{B}(F^*x, F^*x') \cong \mathbb{A}(x, F_*F^*x')$  and  $\mathbb{A}(F_*y, F_*y') \cong \mathbb{B}(F^*F_*y, y')$ . The functors  $F_b$  and  $F^b$  induced in Fig. 13 by the factorization form the adjunction displayed in Fig. 14, because

$$\mathbb{A}_{\overleftarrow{F}}(F_*y, x) = \mathbb{B}(F^*F_*y, F^*x) \cong \mathbb{A}(F_*y, F_*F^*x) = \mathbb{B}_{\overrightarrow{F}}(y, F^*x)$$

While this construction is universal, it is not idempotent, as the adjunctions between the categories of free algebras over cofree coalgebras and of cofree coalgebras over free algebras often form transfinite embedding chains. The idempotent nucleus construction is just a step further. Remarkably, categorical localizations turn out to arise beyond factorizations.



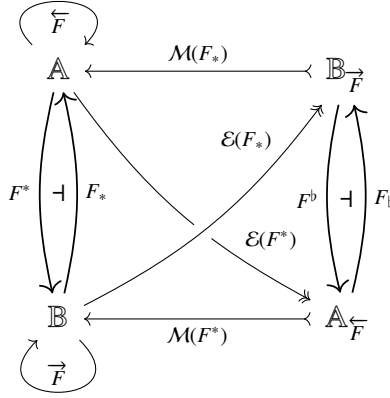

Figure 14: A nucleus  $F^\flat \dashv F_\flat$  spanned by the initial resolutions of the adjunction  $F^* \dashv F_*$

## 5 Example $\infty$ : Setting for categorical nuclei

### 5.1 The categories

Here we list the dramatis personae from Fig. 3. The equivalent forms of the category Nuc will arise as full subcategories of Adj, Mnd, and Cmn in Sections 6–9.

#### 5.1.1 Matrices between categories (a.k.a. distributors, profunctors, bimodules)

$$\begin{aligned}
 |\text{Mat}| &= \coprod_{A, B \in \text{CAT}} \text{CAT}(A^o \times B, \text{Set}) & (52) \\
 \text{Mat}(\Phi, \Psi) &= \coprod_{\substack{H \in \text{CAT}(A, C) \\ K_* \in \text{CAT}(B, D)}} \{ \gamma \in \text{Nis}(\Phi, \Psi(H^o \times K)) \}
 \end{aligned}$$

where  $\Phi : A^o \times B \rightarrow \text{Set}$ ,  $\Psi : C^o \times D \rightarrow \text{Set}$ , and  $\text{Nis}(X, Y)$  denotes a family of natural isomorphisms of  $X$  and  $Y$ .

### 5.1.2 Adjunctions

$$|\text{Adj}| = \coprod_{\mathbf{A}, \mathbf{B} \in \text{CAT}} \coprod_{\substack{F^* \in \text{CAT}(\mathbf{A}, \mathbf{B}) \\ F_* \in \text{CAT}(\mathbf{B}, \mathbf{A})}} \left\{ \langle \eta, \varepsilon \rangle \in \text{Nat}(\text{Id}, F_* F^*) \times \text{Nat}(F^* F_*, \text{Id}) \mid \right.$$

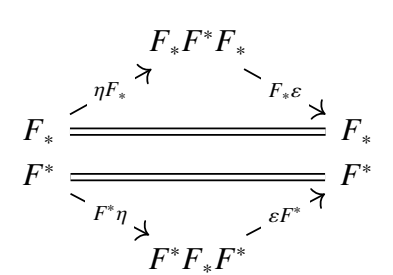
(53)

$$\left. \right\}$$

$$\text{Adj}(F, G) = \coprod_{\substack{H \in \text{CAT}(\mathbf{A}, \mathbf{C}) \\ K \in \text{CAT}(\mathbf{B}, \mathbf{D})}} \left\{ \langle \nu^*, \nu_* \rangle \in \text{Nis}(KF^*, G^*H) \times \text{Nis}(HF_*, G_*K) \mid \right.$$

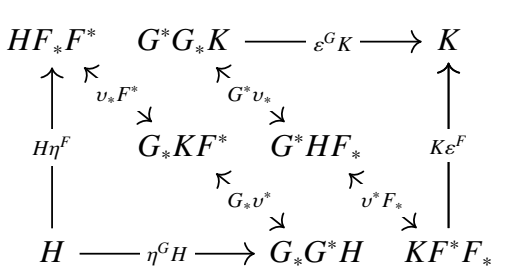

$$\left. \right\}$$

where  $\text{Nat}(X, Y)$  denotes a family of natural transformations from  $X$  to  $Y$ .

### 5.1.3 Monads

$$|\text{Mnd}| = \coprod_{\mathbb{A} \in \text{CAT}} \coprod_{\overleftarrow{T} \in \text{CAT}(\mathbb{A}, \mathbb{A})} \left\{ \langle \eta, \mu \rangle \in \text{Nat}(\text{Id}, \overleftarrow{T}) \times \text{Nat}(\overleftarrow{T}\overleftarrow{T}, \overleftarrow{T}) \mid \right.$$
$$\left. \right\} \quad (54)$$

$$\text{Mnd}(\overleftarrow{S}, \overleftarrow{T}) = \coprod_{H \in \text{CAT}(\mathbb{C}, \mathbb{A})} \left\{ \chi \in \text{Nis}(\overleftarrow{T}H, H\overleftarrow{S}) \mid \right.$$
$$\left. \right\}$$

where  $\overleftarrow{S} : \mathbb{C} \rightarrow \mathbb{C}$  and  $\overleftarrow{T} : \mathbb{A} \rightarrow \mathbb{A}$ .

### 5.1.4 Comonads

$$|\text{Cmn}| = \coprod_{\mathbb{B} \in \text{CAT}} \coprod_{\vec{T} \in \text{CAT}(\mathbb{B}, \mathbb{B})} \left\{ \langle \varepsilon, \nu \rangle \in \text{Nat}(\vec{T}, \text{Id}) \times \text{Nat}(\vec{T}, \vec{T}\vec{T}) \mid \right.$$
$$\left. \right\} \quad (55)$$

$$\text{Cmn}(\vec{S}, \vec{T}) = \coprod_{K \in \text{CAT}(\mathbb{B}, \mathbb{D})} \left\{ \kappa \in \text{Nis}(K\vec{S}, \vec{T}K) \mid \right.$$
$$\left. \right\}$$

where  $\vec{S} : \mathbb{D} \rightarrow \mathbb{D}$  and  $\vec{T} : \mathbb{B} \rightarrow \mathbb{B}$ .

**What about the 2-cells?** All of the above categories, constructed over the 2-category of categories  $\text{Cat}$ , naturally arise as 2-categories. Their 2-dimensional structures were introduced and studied [4, 56, 87, 89]. The results of the present paper were originally written down as 2-categorical statements. But we never found a way to present the 2-categorical details without losing the forest for the trees. Giving up on that not only made this presentation tractable (to some extent), but also shed light on a remarkable phenomenon. As a tight, strongly idempotent construction, the nucleus is not just independent on the 2-dimensional structure, but seems to filter it out. For one thing, it turned out that the conceptual content of adjunctions captured by their nuclei is in each case completely summarized by an ordinary category, which we call the *concept category* [81]. This is related to the fact that the nucleus construction and the Street monads are idempotent in the strong sense, i.e. up to equivalences, with invertible 2-cells, and not in the 2-categorical sense, up to general adjunctions, with non-invertible 2-cells [54, 90, 94]. The price to be paid is that even the natural transformations  $\nu$ ,  $\chi$ , and  $\kappa$  that come about in the adjunction, monad, and comonad homomorphisms above must be invertible to allow the adjunctions  $KM \dashv AM \dashv EM$  and  $KC \dashv AC \dashv EC$ , from which the nuclei arise. While requiring that the 2-cells within the 1-cells

between monads are invertible limits their expressiveness, at least in the practical applications in concept mining, this limitation seems to be a dimensionality reduction feature, and not a bug. The theoretical work on understanding this feature is ongoing.

## 5.2 The functors

### 5.2.1 Comprehending presheaves and matrices as discrete fibrations

Following the step from (4) to (52), the comprehension correspondence (5) now lifts to

$$\begin{array}{ccc} \text{Cat}(\mathbb{A}^o \times \mathbb{B}, \text{Set}) & \begin{array}{c} \xrightarrow{\{-\}} \\ \xrightarrow{\simeq} \\ \xleftarrow{\Xi} \end{array} & \text{Dfib} / \mathbb{A} \times \mathbb{B}^o \end{array} \quad (56)$$

$$\begin{array}{ccc} \left( \mathbb{A}^o \times \mathbb{B} \xrightarrow{\Phi} \text{Set} \right) & \mapsto & \left( \int \Phi \xrightarrow{\{\Phi\}} \mathbb{A} \times \mathbb{B}^o \right) \\ \left( \mathbb{A}^o \times \mathbb{B} \xrightarrow{\Xi_E} \text{Set} \right) & \leftarrow & \left( \mathbb{E} \xrightarrow{E} \mathbb{A} \times \mathbb{B}^o \right) \end{array}$$

Transposing the arrow part of  $\Phi$ , which maps every pair  $f \in \mathbb{A}(a, a')$  and  $g \in \mathbb{B}(b', b)$  into  $\Phi(a', b') \xrightarrow{\Phi_{fg}} \Phi(a, b)$ , the closure property expressed by the implication in (6) becomes the mapping

$$\mathbb{A}(a, a') \times \Phi(a', b') \times \mathbb{B}(b', b) \longrightarrow \Phi(a, b) \quad (57)$$

The *lower-upper* closure property expressed by (6) is now captured as the structure of the total category  $\int \Phi$ , defined as follows:

$$\begin{aligned} |\int \Phi| &= \coprod_{\substack{a \in \mathbb{A} \\ b \in \mathbb{B}}} \Phi(a, b) \\ \int \Phi(x_{ab}, x'_{a'b'}) &= \{ \langle f, g \rangle \in \mathbb{A}(a, a') \times \mathbb{B}(b', b) \mid x = \Phi_{fg}(x') \} \end{aligned} \quad (58)$$

It is easy to see that the obvious projection

$$\begin{array}{ccc} \int \Phi & \xrightarrow{\{\Phi\}} & \mathbb{A} \times \mathbb{B}^o \\ x_{ab} & \mapsto & \langle a, b \rangle \end{array} \quad (59)$$

is a discrete fibration, i.e., an object of  $\text{Dfib} / \mathbb{A} \times \mathbb{B}^o$ . In general, a functor  $\mathbb{F} \xrightarrow{F} \mathbb{C}$  is a discrete fibration over  $\mathbb{C}$  when for all  $x \in \mathbb{F}$  the obvious induced functors  $\mathbb{F}/x \xrightarrow{F_x} \mathbb{C}/Fx$  are isomorphisms. In other words, for every  $x \in \mathbb{F}$  and every morphism  $c \xrightarrow{t} Fx$  in  $\mathbb{C}$ , there is a unique lifting  $t^1 x \xrightarrow{\theta^t} x$  of  $t$  to  $\mathbb{F}$ , i.e., a unique  $\mathbb{F}$ -morphism into  $x$  such that  $F(\theta^t) = t$ . For a discrete fibration  $\mathbb{E} \xrightarrow{E} \mathbb{A} \times \mathbb{B}^o$ , such liftings induce the arrow part of the corresponding presheaf

$$\begin{array}{ccc} \Xi_E: \mathbb{A}^o \times \mathbb{B} & \rightarrow & \text{Set} \\ \langle a, b \rangle & \mapsto & \{x \in \mathbb{E} \mid Ex = \langle a, b \rangle\} \end{array}$$

because any pair of morphisms  $\langle f, g \rangle \in \mathbb{A}(a, a') \times \mathbb{B}^o(b, b')$  lifts to a function  $\Xi_E(f, g) = \langle f, g \rangle^! : \Xi_E(a', b') \rightarrow \Xi_E(a, b)$ . The equivalences in (56) thus yield an equivalent version of the category  $\text{Mat}$  of matrices:

$$|\text{Mat}| = \coprod_{\mathbb{A}, \mathbb{B} \in \text{CAT}} \text{Dfib} / \mathbb{A} \times \mathbb{B}^o \quad (60)$$

$$\text{Mat}(\Phi, \Psi) = \coprod_{\substack{H \in \text{CAT}(\mathbb{A}, \mathbb{C}) \\ K \in \text{CAT}(\mathbb{B}, \mathbb{D})}} \left( \text{Dfib} / \mathbb{A} \times \mathbb{B}^o \right) \left( \Phi, (H \times K^o)^* \Psi \right)$$

where  $\Phi \in \text{Dfib} / \mathbb{A} \times \mathbb{B}^o$ ,  $\Psi \in \text{Dfib} / \mathbb{C} \times \mathbb{D}^o$ , and  $(H \times K^o)^* \Psi$  is a pullback of  $\Psi$  along

$$(H \times K^o) : \mathbb{A} \times \mathbb{B}^o \longrightarrow \mathbb{C} \times \mathbb{D}^o$$

The notational abuse of  $\text{Mat}$  to denote both (52) and (60) is not just technically harmless, but its tacit identification of the two sides of (56) is conceptually justified by the recurring theme of categorical comprehension, used already in the next section.

**Background.** Fibrations go back to Grothendieck [37, 38]. Overviews can be found in [44, 74]. With (4) generalized to (52), and (5) to (56), (7–8) become

$$\Downarrow \mathbb{A} = \text{Dfib} / \mathbb{A} \simeq \text{Set}^{\mathbb{A}^o} \quad (61)$$

$$\Uparrow \mathbb{B} = (\text{Dfib} / \mathbb{B}^o)^o \simeq (\text{Set}^{\mathbb{B}})^o \quad (62)$$

Just like the poset embeddings  $A \xrightarrow{\blacktriangledown} \Downarrow A$  and  $B \xrightarrow{\blacktriangle} \Uparrow B$  were the join and the meet completions, the Yoneda embeddings  $\mathbb{A} \xrightarrow{\blacktriangledown} \Downarrow \mathbb{A}$  and  $\mathbb{B} \xrightarrow{\blacktriangle} \Uparrow \mathbb{B}$ , where  $\blacktriangledown a = \left( \mathbb{A}/a \xrightarrow{\text{Dom}} \mathbb{A} \right)$  and  $\blacktriangle b = \left( b/\mathbb{B} \xrightarrow{\text{Cod}} \mathbb{B} \right)$  are the colimit and the limit completions, respectively.

### 5.2.2 From matrices to adjunctions

In the enriched settings, the matrix completions have been analyzed in [78, 79]. In the categorical setting, a matrix  $\Phi : \mathbb{A}^o \times \mathbb{B} \rightarrow \text{Set}$  is extended along the Yoneda embeddings  $\mathbb{A} \xrightarrow{\blacktriangledown} \text{Set}^{\mathbb{A}^o}$  and  $\mathbb{B} \xrightarrow{\blacktriangle} (\text{Set}^{\mathbb{B}})^o$  into the adjunction  $\Phi^* \dashv \Phi_* : (\text{Set}^{\mathbb{B}})^o \rightarrow \text{Set}^{\mathbb{A}^o}$  as follows:

$$\frac{\Phi : \mathbb{A}^o \times \mathbb{B} \rightarrow \text{Set}}{\frac{\Phi_\bullet : \mathbb{A} \rightarrow (\text{Set}^{\mathbb{B}})^o \quad \bullet\Phi : \mathbb{B} \rightarrow \text{Set}^{\mathbb{A}^o}}{\Phi^* : \text{Set}^{\mathbb{A}^o} \rightarrow (\text{Set}^{\mathbb{B}})^o \quad \Phi_* : (\text{Set}^{\mathbb{B}})^o \rightarrow \text{Set}^{\mathbb{A}^o}}} \quad (63)$$

The adjoint functors  $\Phi^*$  and  $\Phi_*$  are the Kan extensions. Mapped along the comprehension (56), the same derivation becomes

$$\frac{\Phi \in \text{Dfib} / \mathbb{A} \times \mathbb{B}^o}{\frac{\Phi_\bullet : \mathbb{A} \rightarrow \Uparrow \mathbb{B} \quad \bullet\Phi : \mathbb{B} \rightarrow \Downarrow \mathbb{A}}{\Phi^* : \Downarrow \mathbb{A} \rightarrow \Uparrow \mathbb{B} \quad \Phi_* : \Uparrow \mathbb{B} \rightarrow \Downarrow \mathbb{A}}} \quad (64)$$

Here the Kan extensions are easily derived as liftings of (11) from posets to categories:

$$\begin{array}{ccc}
\begin{array}{c} \mathbb{L} \xrightarrow{L} \mathbb{A} \\ \downarrow \\ \varprojlim (\mathbb{L}^o \xrightarrow{L^o} \mathbb{A}^o \xrightarrow{\Phi_\bullet} (\uparrow\mathbb{B})^o) \end{array} & \begin{array}{c} \Downarrow \mathbb{A} \\ \uparrow \Phi^* \quad \downarrow \Phi_* \\ \Uparrow \mathbb{B} \end{array} & \begin{array}{c} \varprojlim (\mathbb{U} \xrightarrow{U} \mathbb{B} \xrightarrow{\Phi_\bullet} \Downarrow \mathbb{A}) \\ \uparrow \\ \mathbb{U} \xrightarrow{U} \mathbb{B} \end{array} \\
& & (65)
\end{array}$$

The fact that  $\mathbb{A} \xrightarrow{\nabla} \Downarrow \mathbb{A}$  is a colimit completion means that every  $L \in \Downarrow \mathbb{A}$  is generated by the representables, i.e.  $L = \varinjlim (\mathbb{L} \xrightarrow{L} \mathbb{A} \xrightarrow{\nabla} \Downarrow \mathbb{A})$ . Any  $\varinjlim$ -preserving functor  $\Phi^* : \Downarrow \mathbb{A} \rightarrow \Uparrow \mathbb{B}$  thus satisfies

$$\Phi^*(L) = \Phi^*\left(\varinjlim (\mathbb{L} \xrightarrow{L} \mathbb{A} \xrightarrow{\nabla} \Downarrow \mathbb{A})\right) = \varinjlim (\mathbb{L} \xrightarrow{L} \mathbb{A} \xrightarrow{\Phi_\bullet^o} \Uparrow \mathbb{B}) = \varprojlim (\mathbb{L}^o \xrightarrow{L^o} \mathbb{A}^o \xrightarrow{\Phi_\bullet} (\uparrow\mathbb{B})^o)$$

Analogous reasoning goes through for  $\Phi_*$ . This completes the definition of the object part of  $\text{MA} : \text{Mat} \rightarrow \text{Adj}$ . The arrow part is completely determined by the object part.

**Remark.** The limits in  $\Downarrow \mathbb{A} \simeq \text{Set}^{\mathbb{A}^o}$  and in  $(\uparrow\mathbb{B})^o \simeq \text{Set}^{\mathbb{B}}$  are pointwise, which means that for any  $b \in \mathbb{B}$  and diagram  $\mathbb{D} \xrightarrow{D} \text{Set}^{\mathbb{B}}$ , the Yoneda lemma implies

$$\left(\varprojlim D\right)b = \text{Set}^{\mathbb{B}}\left(\blacktriangle b, \varprojlim D\right) = \text{Cones}(b, \{D\})$$

In words, the limit of  $D$  at a point  $b$  is the set of commutative cones in  $\mathbb{B}$  from  $b$  to a diagram  $\{D\} : \int D \rightarrow \mathbb{B}$  constructed by a lifting like (58).

### 5.2.3 From adjunctions to monads and comonads, and back

The projections of adjunctions onto monads and comonads, and the embeddings that arise as their left and right adjoints, all displayed in Fig. 4, are one of the centerpieces of the categorical toolkit for concept mining. Here we list the object parts of all functors, mainly for naming purposes.

- $\text{EC}(\overrightarrow{F} : \mathbb{B} \rightarrow \mathbb{B}) = (V^* \dashv V_* : \mathbb{B} \rightarrow \mathbb{B}^{\overrightarrow{F}})$   $\Leftarrow$  all coalgebras (Eilenberg-Moore)
- $\text{AC}(F^* \dashv F_* : \mathbb{B} \rightarrow \mathbb{A}) = (F^* F_* : \mathbb{B} \rightarrow \mathbb{A})$   $\Leftarrow$  adjunction-induced comonad
- $\text{KC}(\overrightarrow{F} : \mathbb{B} \rightarrow \mathbb{B}) = (L^* \dashv L_* : \mathbb{B} \rightarrow \mathbb{B}_{\overrightarrow{F}})$   $\Leftarrow$  cofree coalgebras (Kleisli)
- $\text{EM}(\overleftarrow{F} : \mathbb{A} \rightarrow \mathbb{A}) = (U^* \dashv U_* : \mathbb{A}^{\overleftarrow{F}} \rightarrow \mathbb{A})$   $\Leftarrow$  all algebras (Eilenberg-Moore)
- $\text{AM}(F^* \dashv F_* : \mathbb{B} \rightarrow \mathbb{A}) = (F_* F^* : \mathbb{A} \rightarrow \mathbb{A})$   $\Leftarrow$  adjunction-induced monad

$$\bullet \text{KM}(\overleftarrow{F} : \mathbb{A} \rightarrow \mathbb{A}) = (J^* \dashv J_* : \mathbb{A}_{\overleftarrow{F}} \rightarrow \mathbb{A}) \quad \rightsquigarrow \text{free algebras (Kleisli)}$$

The object parts of the functors **AM** and **AC**, which derive monads and comonads from adjunctions, the Kleisli constructions **KM** and **KC**, which produce the initial resolutions of monads and comonads as adjunctions, and the Eilenberg-Moore constructions, which produce the final resolutions, are presented in most category theory textbooks. The arrow parts are summarized in Appendix B.

**Unifying the initial and the final resolutions.** As seen in Appendix B.2, the arrow part of the initial (Kleisli) resolution functor  $\text{KM} : \text{Mnd} \rightarrow \text{Adj}$  requires a distributivity law in the form  $\chi : H\overleftarrow{S} \rightarrow \overleftarrow{T}H$ . Appendix B.3, on the other hand, shows that the arrow part of the final (Eilenberg-Moore) resolution functor **EM** requires a distributivity law  $\chi : \overleftarrow{T}H \rightarrow H\overleftarrow{S}$ , going in the opposite direction. The monad morphisms with general 2-cells, as studied in [56, 89], thus permit *either* the adjunction **KM**  $\dashv$  **AM**, if the distributive laws in the **Mnd**-morphisms and in the **Adj**-morphisms are taken in one direction, *or* the adjunction **AM**  $\dashv$  **EM** if the distributive laws are taken in the other direction. To unify both adjunctions into a double reflection  $\text{KM} \dashv \text{AM} \dashv \text{EM} : \text{Mnd} \rightrightarrows \text{Adj}$  the **Mnd**-morphisms and the **Adj**-morphisms must be restricted to *invertible* distributivity laws, as we did in the arrow parts of (53) and (54). A dual pair of opposite requirements on the distributivity law  $\kappa$  is imposed by the Kleisli and the Eilenberg-Moore resolutions on the comonad morphisms, and hence the invertible distributivity requirements in the arrow part of (55). Such double reflections were studied in [51, 64, 65].

Recalling that each of the monad, comonad, and adjunction morphisms consist of functors and distributivity laws, we emphasize that the invertibility requirement on the distributivity laws does not make the morphisms themselves invertible. Indeed, the comparison functor  $K_\eta$  from an adjunction  $F = (F^* \dashv F_*)$  to the final resolution  $U = (U^* \dashv U_*) = \text{EM}(\overleftarrow{F})$  of the induced monad  $\overleftarrow{F} = F_*F^*$  is only invertible if  $F_*$  is monadic. The comparison functor  $K^\varepsilon$  from the initial resolution  $J = (J^* \dashv J_*) = \text{KM}(\overleftarrow{F})$  to the adjunction  $F = (F^* \dashv F_*)$  is only invertible if  $F^*$  is essentially surjective, and enough idempotents split in  $\mathbb{A}$ . The two comparison functors become adjoint only if the monad  $\overleftarrow{F}$  is idempotent. None of this is generally the case. In general, the comparison functor  $K_\eta$  induces the unit  $\eta$  of the reflection **AM**  $\dashv$  **EM**, whereas  $K^\varepsilon$  induces the counit  $\varepsilon$  of the coreflection **KM**  $\dashv$  **AM**. The double reflection equipment of **KM**  $\dashv$  **AM**  $\dashv$  **EM** is displayed in Fig. 15. Using the comparison functors, defined on the objects by  $K^\varepsilon x = F^*x$  and  $K_\eta y = (F_*F^*F_*y \xrightarrow{F_*\varepsilon} F_*y)$ , the counit of **KM**  $\dashv$  **AM** is defined to be  $\varepsilon_F = \langle \text{Id}_{\mathbb{A}}, K^\varepsilon, \text{id}_{F^*}, \text{id}_{J_*} \rangle$  and the unit of **AM**  $\dashv$  **EM** is  $\eta_F = \langle \text{Id}_{\mathbb{A}}, K_\eta, \text{id}_{U^*}, \text{id}_{F_*} \rangle$ , as displayed in Fig. 15. Using the dual comparison functors  $H_\varepsilon$  and  $H^\eta$  for comonads, the counit of the double reflection **KC**  $\dashv$  **AC**  $\dashv$  **EC** is defined to be  $\varepsilon_F = \langle H_\varepsilon, \text{Id}_{\mathbb{B}}, \text{id}_{L^*}, \text{id}_{F_*} \rangle$  whereas its unit is  $\eta_F = \langle H^\eta, \text{Id}_{\mathbb{B}}, \text{id}_{F^*}, \text{id}_{V_*} \rangle$ .

Note that the nucleus setting in Fig. 3 only uses a half of the above double reflections of monads and comonads in adjunctions: the final resolution **AM**  $\dashv$  **EM** of monads, and the initial resolution **KC**  $\dashv$  **AC** of comonads. Dually, nuclei could also be built by composing the initial resolution **KM**  $\dashv$  **AM** of monads and the final resolution **AC**  $\dashv$  **EC** of comonads. The two choices induce two Street monads, as displayed in Fig. 16. They will turn out to be idempotent up to weak equivalence, i.e. up to strong equivalence of absolute completions. Before we land on proving this, we first spell out the terms.



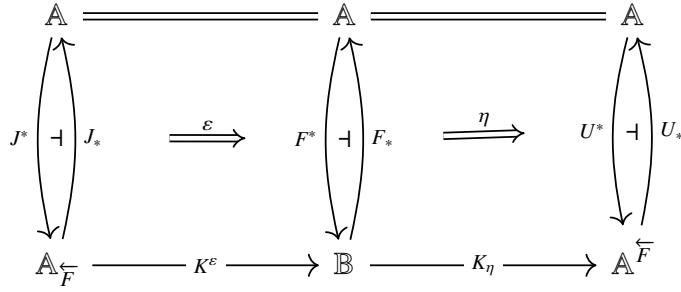
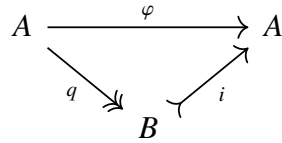

Figure 15: The counit  $K_M \circ AM(F) \xrightarrow{\varepsilon} F$  and the unit of  $F \xrightarrow{\eta} EM \circ AM(F)$

### 5.3 Absolute (Cauchy) completions and weak (Morita) equivalences

#### 5.3.1 Idempotent splitting.

An endomorphism  $\varphi : A \rightarrow A$  is *idempotent* if  $\varphi \circ \varphi = \varphi$ . A *splitting* of an idempotent  $\varphi$  is its epi-mono (quotient-injective) factorization



It was proved in [3, Sec. IV.7.5] that the following statements are equivalent:

- (a)  $\varphi \circ \varphi = \varphi$
- (b)  $q \circ i = \text{id}$
- (c)  $i$  is an equalizer and  $q$  is a coequalizer of  $\varphi$  and the identity

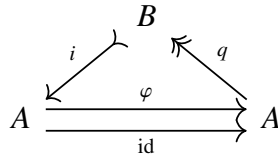

Such splittings are often drawn in the form  $A \begin{matrix} \xrightarrow{q} \\ \xleftarrow{i} \end{matrix} B$ , suggesting that  $i \circ q = \varphi$  and  $q \circ i = \text{id}$ . Since the idempotent splittings are characterized by such equations, and functors preserve equations, the idempotent splittings are preserved by all functors. A categorical property that is preserved by all functors is called *absolute*. The idempotent splittings are thus examples of absolute equalizers and absolute coequalizers. It was shown in [73] that these are the only absolute limits or colimits. Completing a category under all absolute limits and colimits boils down to adjoining the idempotent splittings.

### 5.3.2 Absolute and Cauchy completions.

For an arbitrary category  $\mathbb{C}$ , the absolute completion  $\underline{\mathbb{C}}$  consists of the  $\mathbb{C}$ -idempotents as the objects, and the idempotent-preserving homomorphisms:

$$|\underline{\mathbb{C}}| = \coprod_{A \in |\mathbb{C}|} \{A \xrightarrow{\varphi} A \mid \varphi \circ \varphi = \varphi\} \quad (66)$$

$$\underline{\mathbb{C}}(A \xrightarrow{\varphi} A, B \xrightarrow{\psi} B) = \left\{ f \in \mathbb{C}(A, B) \mid \begin{array}{ccc} A & \xrightarrow{f} & B \\ \downarrow \varphi & & \uparrow \psi \\ A & \xrightarrow{f} & B \end{array} \right\} \quad (67)$$

Note that the homomorphism condition  $\psi \circ f \circ \varphi = f$  is equivalent to the conjunction of  $f \circ \varphi = f$  and  $\psi \circ f = f$ . In [3, Sec. IV.7.5], the construction of the category  $\underline{\mathbb{C}}$  was attributed to Max Karoubi, so it came to be called the *Karoubi envelope*. It also appeared as exercise 2–B in [30, p. 61].

A category  $\mathbb{C}$  is said to be *Cauchy complete* if every matrix  $\mathbb{C}^o \xrightarrow{\Gamma} \mathbf{Set}$  with a right adjoint  $\mathbb{C} \xrightarrow{\Gamma_*} \mathbf{Set}$ , where  $\Gamma_*(x)$  is the set of cocones from  $\Gamma$  to  $x$ , is representable by some  $c \in \mathbb{C}$  as  $\Gamma(x) = \mathbb{C}(x, c)$ . The name is motivated by the observation that the corresponding property in metric spaces, viewed as enriched categories, characterizes the convergence of Cauchy sequences [63]. See [16, Vol. 1, Sec. 7.9] and [17] for categorical treatments. The following statements are equivalent for any category  $\mathbb{C}$ :

- (a)  $\mathbb{C}$  is Cauchy complete,
- (b)  $\mathbb{C}$  is absolutely complete,
- (c) all idempotents split in  $\mathbb{C}$ ,
- (d) the embedding  $\mathbb{C} \hookrightarrow \underline{\mathbb{C}}$  is an equivalence of categories.

### 5.3.3 Weak (Morita) equivalences.

Categories  $\mathbb{C}$  and  $\mathbb{D}$  are said to be *weakly equivalent* when their absolute completions are strongly equivalent; i.e.,  $\mathbb{C} \sim \mathbb{D}$  means that  $\underline{\mathbb{C}} \simeq \underline{\mathbb{D}}$ . The weak equivalence is often named the *Morita equivalence of categories* because it is also characterized by the strong equivalence of the categories  $\mathbf{Set}^{\mathbb{C}} \simeq \mathbf{Set}^{\mathbb{D}}$ . A proof can be found in [16, Vol. 1, Sec. 7.9]. This terminology is justified by the analogy of the categories  $\mathbf{Set}^{\mathbb{C}}$  and  $\mathbf{Set}^{\mathbb{D}}$  with the abelian categories  $\mathbf{Ab}^R$  and  $\mathbf{Ab}^S$  of  $R$ -modules and  $S$ -modules, whose equivalence was studied by Morita.<sup>4</sup> All of our results are valid up to weak equivalence of categories, or can be construed as speaking of absolute completions. To shorten proofs, we take the latter approach, introduce absolute completions in the statements, and prove strong equivalences. Omitting this would lead to shorter statements, longer proofs, and essentially equivalent theory.

<sup>4</sup>Neither Morita nor Cauchy were involved with the categorical liftings of the concepts that carry their names. History is often forgotten, but it is sometimes useful for mnemonic purposes.

### 5.3.4 Absolute reflections.

Let  $\underline{\text{Cat}}$  denote the full subcategory of  $\text{Cat}$  spanned by absolutely complete categories  $\underline{\mathbb{A}}, \underline{\mathbb{B}}$ , etc. Checking that the idempotent splitting construction in (66) induces a left adjoint to the inclusion  $\underline{\text{Cat}} \hookrightarrow \text{Cat}$  is a standard exercise. Any functor  $F : \mathbb{A} \rightarrow \mathbb{B}$  lifts to  $\underline{F} : \underline{\mathbb{A}} \rightarrow \underline{\mathbb{B}}$ , where  $\underline{F}x = Fx$ , whether  $x$  is an idempotent or a homomorphism of idempotents. Any natural transformation  $\tau : F \rightarrow G$  between any pair of functors  $F, G : \mathbb{A} \rightarrow \mathbb{B}$  lifts to a natural family  $\underline{\tau} : \underline{F} \rightarrow \underline{G}$  comprised of

$$\left(\underline{F}\varphi \xrightarrow{\underline{\tau}_\varphi} \underline{G}\varphi\right) = \left(FA \xrightarrow{F\varphi} FA \xrightarrow{\tau_A} GA \xrightarrow{G\varphi} GA\right) \quad (68)$$

The naturality of  $\tau$  implies not only the naturality of the family  $\underline{\tau}$ , but also the functoriality of the induced mappings  $\text{Cat}(\mathbb{A}, \mathbb{B}) \rightarrow \text{Cat}(\underline{\mathbb{A}}, \underline{\mathbb{B}})$ . The idempotent splitting in (66) thus induces a 2-functor  $\text{Cat} \rightarrow \underline{\text{Cat}}$ . This means that any monad  $(\overleftarrow{T}, \eta, \mu)$  on  $\mathbb{A}$  lifts to a monad  $(\overleftarrow{\underline{T}}, \underline{\eta}, \underline{\mu})$  on  $\underline{\mathbb{A}}$ . Ditto for any comonad, adjunction, matrix, etc. Hence the corresponding 2-categories  $\underline{\text{Mnd}}, \underline{\text{Cmn}}, \underline{\text{Adj}}$ , etc., of the various categorical structures lifted to absolute completions, in all cases fully embedded into the general categorical structures.

**Notational economy.** Since all of the embeddings  $\underline{\text{Cat}} \hookrightarrow \text{Cat}$ ,  $\underline{\text{Mnd}} \hookrightarrow \text{Mnd}$ , etc., are conservative, all of the structures lift to the underlined versions uniquely, and the underlinings of structures provides no additional information, as soon as it is understood that their domains are absolutely complete. To minimize notational clutter, we omit the underlinings whenever the confusion seems unlikely, and write, e.g.,  $F^* \dashv F_* : \underline{\mathbb{B}} \rightarrow \underline{\mathbb{A}}$  instead of  $\underline{F}^* \dashv \underline{F}_* : \underline{\mathbb{B}} \rightarrow \underline{\mathbb{A}}$ .

## 6 Theorem

The Street monads  $\overleftarrow{\mathfrak{M}} : \text{Mnd} \rightarrow \text{Mnd}$  and  $\overleftarrow{\mathfrak{C}} : \text{Cmn} \rightarrow \text{Cmn}$  are defined by applying the adjoint functors from Fig. 16 to the absolute completions of monads and comonads as follows

$$\overleftarrow{\mathfrak{M}}(\overleftarrow{T}) = \text{AM} \circ \text{EC} \circ \text{AC} \circ \text{KM}(\overleftarrow{T}) \quad (69)$$

$$\overleftarrow{\mathfrak{C}}(\overleftarrow{T}) = \text{AC} \circ \text{EM} \circ \text{AM} \circ \text{KC}(\overleftarrow{T}) \quad (70)$$

Both Street monads are idempotent, in the sense that iterating them leads to natural equivalences

$$\overleftarrow{\mathfrak{M}} \overset{\eta}{\simeq} \overleftarrow{\mathfrak{M}} \circ \overleftarrow{\mathfrak{M}} \qquad \overleftarrow{\mathfrak{C}} \overset{\eta}{\simeq} \overleftarrow{\mathfrak{C}} \circ \overleftarrow{\mathfrak{C}}$$

Moreover, the induced categories of algebras coincide, in the sense that there are equivalences

$$\text{Cmn}^{\overleftarrow{\mathfrak{C}}} \simeq \text{Nuc} \simeq \text{Mnd}^{\overleftarrow{\mathfrak{M}}} \quad (71)$$

where

$$\text{Cmn}^{\overleftarrow{\mathfrak{C}}} = \left\{ \overleftarrow{T} \in \text{Cmn} \mid \overleftarrow{T} \overset{\eta}{\simeq} \overleftarrow{\mathfrak{C}}(\overleftarrow{T}) \right\} \quad (72)$$

$$\text{Nuc} = \left\{ F \in \text{Adj} \mid F \overset{\eta}{\simeq} \overleftarrow{\text{EM}}(F) \wedge F \overset{\eta}{\simeq} \overleftarrow{\text{EC}}(F) \right\} \quad (73)$$

$$\text{Mnd}^{\overleftarrow{\mathfrak{M}}} = \left\{ \overleftarrow{T} \in \text{Mnd} \mid \overleftarrow{T} \overset{\eta}{\simeq} \overleftarrow{\mathfrak{M}}(\overleftarrow{T}) \right\} \quad (74)$$

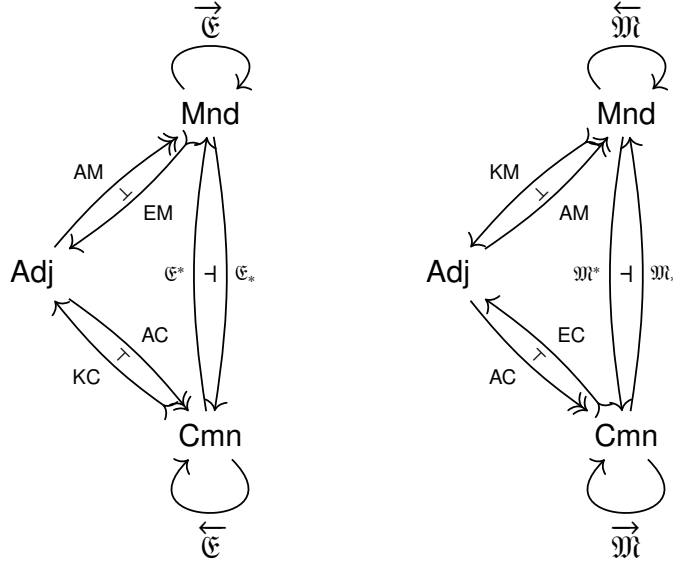

Figure 16: Monads and comonads on Cmn and Mnd induced by the localizations in Fig. 4

for  $\overleftarrow{EM}(F) = EM \circ AM(\underline{F})$  and  $\overleftarrow{EC}(F) = EC \circ AC(\underline{F})$ .

**Terminology.** The objects of the equivalent categories  $\text{Nuc} \subset \text{Adj}$ ,  $\text{Mnd}^{\overleftarrow{\mathfrak{M}}} \subset \text{Mnd}$ , and  $\text{Cmn}^{\overleftarrow{\mathfrak{C}}} \subset \text{Cmn}$  are *nuclear* adjunctions, monads, or comonads, respectively. They are the *nuclei* of the corresponding adjunctions, monads, comonads.

**Remarks.** Note that the monad  $\overleftarrow{T}$  in (69) and the comonad  $\overrightarrow{T}$  in (70) are first completed to  $\overleftarrow{\underline{T}}$  and  $\overrightarrow{\underline{T}}$  before the algebra constructions are applied. Without these completions, the claims of the Theorem hold up to weak equivalence. The completions simplify the presentation by displaying the strong equivalences behind the weak equivalences. For an adjunction  $F = (F^* \dashv F_*)$ , the condition  $F \overset{\eta}{\simeq} \overleftarrow{EM}(F)$  implies that  $F_*$  is monadic, whereas  $F \overset{\eta}{\simeq} \overleftarrow{EC}(F)$  implies that  $F^*$  is comonadic. Equation (73) thus provides a formal view of the nuclear adjunctions discussed the Introduction. The category Nuc is thus specified as an intersection of Mnd and Cmn as reflective subcategories of Adj. To ensure the soundness of such a definition, one should prove that the two reflections commute, i.e., spell out a distributive law for  $\overleftarrow{EM}$  and  $\overleftarrow{EC}$ . Without it, the two reflections could generate chains of alternating images. The distributive law  $\overleftarrow{EM} \circ \overleftarrow{EC} \simeq \overleftarrow{EC} \circ \overleftarrow{EM}$  is spelled out in Corollary 7.9. It arises from the nucleus monad  $\overleftarrow{\mathfrak{M}} : \text{Adj} \rightarrow \text{Adj}$ , which is presented in the next section.

## 7 Propositions

### 7.1 The adjunction of coalgebras and algebras

**Proposition 7.1** *Let  $F = (F^* \dashv F_* : \mathbb{B} \rightarrow \mathbb{A})$  be an arbitrary adjunction, which induces*

- *the monad  $\overleftarrow{F} = F_*F^*$  with the (Eilenberg-Moore) category of algebras  $\mathbb{A}^{\overleftarrow{F}}$  and the final adjunction resolution  $U = (U^* \dashv U_* : \mathbb{A}^{\overleftarrow{F}} \rightarrow \mathbb{A})$ , and*
- *the comonad  $\overrightarrow{F} = F^*F_*$  with the (Eilenberg-Moore) category of coalgebras  $\mathbb{B}^{\overrightarrow{F}}$  and the final resolution  $V = (V^* \dashv V_* : \mathbb{B} \rightarrow \mathbb{B}^{\overrightarrow{F}})$ .*

*The fact that  $U$  and  $V$  are final resolutions of the monad  $\overleftarrow{F}$  and the comonad  $\overrightarrow{F}$ , respectively, means that there are unique comparison functors from the adjunction  $F$  to each of them, and these functors are:*

- $H^0 : \mathbb{A} \rightarrow \mathbb{B}^{\overrightarrow{F}}$ , such that  $F^* = V^* \circ H^0$  and  $F_* \circ H^0 = V_*$ ,
- $H_1 : \mathbb{B} \rightarrow \mathbb{A}^{\overleftarrow{F}}$ , such that  $F_* = U_* \circ H_1$  and  $H_1 \circ F^* = U^*$ .

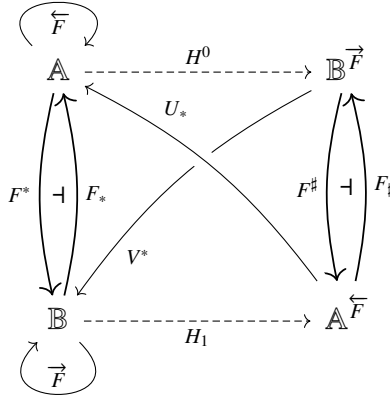

Figure 17: The adjunction  $F^* \dashv F_*$  induces  $F^\# \dashv F_\#$  induced where  $F^\# = H_1 \circ V^*$  and  $F_\# = H^0 \circ U_*$

*Then the functors  $F^\# = H_1 \circ V^*$  and  $F_\# = H^0 \circ U_*$  defined in Fig. 17 form the adjunction  $F^\# \dashv F_\# : \mathbb{A}^{\overleftarrow{F}} \rightarrow \mathbb{B}^{\overrightarrow{F}}$ .*

**Proof.** We assume that  $\mathbb{A} = \underline{\mathbb{A}}$  and  $\mathbb{B} = \underline{\mathbb{B}}$  and work with objects rather than idempotents. The object parts of the definitions of the functors  $F_\#$  and  $F^\#$  are unfolded in Fig. 18. The arrow part of

$$\begin{array}{ccc}
x \dashrightarrow \left( \begin{array}{c} F^*x \\ \downarrow F^*\eta \\ F_*F_*F^*x \end{array} \right) & \longleftarrow & \left( \begin{array}{c} F_*F^*x \\ \downarrow \alpha \\ x \end{array} \right) \\
\mathbb{A} \xrightarrow{H^0} \mathbb{B}^{\vec{F}} & \xleftarrow{F^\sharp} & \mathbb{A}^{\overleftarrow{F}} \\
& \searrow U_* & \\
& & \mathbb{B} \xleftarrow{H_1} \mathbb{A}^{\overleftarrow{F}} \xleftarrow{F^\sharp} \mathbb{B}^{\vec{F}} \\
& \swarrow V^* & \\
y \dashrightarrow \left( \begin{array}{c} F_*F^*F_*y \\ \downarrow F_*\varepsilon \\ F_*y \end{array} \right) & \longleftarrow & \left( \begin{array}{c} y \\ \downarrow \beta \\ F_*F_*y \end{array} \right)
\end{array}$$

Figure 18: The definitions of  $F^\sharp$  and  $F^\sharp$

$F^\sharp$  is  $F^*$  and the arrow part of  $F^\sharp$  is  $F_*$ . For these  $F^\sharp$  and  $F^\sharp$ , we shall prove that the correspondence

$$\begin{aligned}
\mathbb{A}^{\overleftarrow{F}}(F^\sharp\beta, \alpha) &\cong \mathbb{B}^{\vec{F}}(\beta, F^\sharp\alpha) \\
f &\mapsto \bar{f} = F^*f \circ \beta
\end{aligned} \tag{75}$$

is a natural bijection. More precisely, the claim is that

- a)  $f$  is an algebra homomorphism if and only if  $\bar{f}$  is a coalgebra homomorphism: each of the following squares commutes if and only if the other one commutes

$$\begin{array}{ccc}
F_*F^*F_*y \xrightarrow{F_*F^*f} F_*F^*x & & F^*F_*y \xrightarrow{F^*F_*\bar{f}} F^*F_*F^*x \\
\downarrow F_*\varepsilon = F^\sharp\beta & \iff & \uparrow \beta \\
F_*y \xrightarrow{f} x & & y \xrightarrow{\bar{f}} F^*x \\
& & \uparrow F^\sharp\alpha = F^*\eta
\end{array} \tag{76}$$

- b) the map  $f \mapsto \bar{f}$  is a bijection, natural along the coalgebra homomorphisms on the left and along the algebra homomorphisms on the right.

Claim (a) is proved as Lemma 7.3. The bijection part of claim (b) is proved as Lemma 7.2. The naturality part is straightforward.  $\square$

**Lemma 7.2** For an arbitrary adjunction  $F = F^* \dashv F_* : \mathbb{B} \rightarrow \mathbb{A}$ , any algebra  $F_*F^*x \xrightarrow{\alpha} x$ , and any coalgebra  $y \xrightarrow{\beta} F^*F_*y$  in  $\mathbb{B}$ , the mappings

$$\mathbb{A}(F_*y, x) \begin{array}{c} \xrightarrow{\overline{(-)}} \\ \xleftarrow{\underline{(-)}} \end{array} \mathbb{B}(y, F^*x)$$

defined by

$$\overline{f} = F^*f \circ \beta \qquad \underline{g} = \alpha \circ F_*g$$

induce a bijection between the subsets

$$\{f \in \mathbb{A}(F_*y, x) \mid f = \alpha \circ F_*F^*f \circ F_*\beta\} \cong \{g \in \mathbb{B}(y, F^*x) \mid g = F^*\alpha \circ F^*F_*g \circ \beta\}$$

illustrated in the following diagram.

$$\begin{array}{ccc} F_*F^*F_*y & \xrightarrow{F_*F^*f} & F_*F^*x \\ \uparrow F_*\beta & \nearrow F_*g & \downarrow \alpha \\ F_*y & \xrightarrow{f} & x \end{array} \quad \Leftrightarrow \quad \begin{array}{ccc} F^*F_*y & \xrightarrow{F^*F_*g} & F^*F_*F^*x \\ \uparrow \beta & \searrow F^*f & \downarrow F_*\alpha \\ y & \xrightarrow{g} & F^*x \end{array}$$

**Proof.** Following each of the mappings "there and back" gives

$$\begin{array}{lcl} f & \mapsto & \overline{f} = F^*f \circ \beta \quad \mapsto \quad \underline{\overline{f}} = \alpha \circ F_*F^*f \circ F_*\beta = f \\ g & \mapsto & \underline{g} = \alpha \circ F_*g \quad \mapsto \quad \overline{\underline{g}} = F^*\alpha \circ F^*F_*g \circ \beta = g \end{array}$$

□

**Lemma 7.3** For any adjunction  $F = F^* \dashv F_* : \mathbb{B} \rightarrow \mathbb{A}$ , algebra  $F_*F^*x \xrightarrow{\alpha} x$  in  $\mathbb{A}$ , coalgebra  $y \xrightarrow{\beta} F^*F_*y$  in  $\mathbb{B}$ , arrow  $f \in \mathbb{A}(F_*y, x)$  and  $\overline{f} = F^*f \circ \beta \in \mathbb{B}(y, F^*x)$ , if any of the squares (1-4) in Fig. 19 commutes, then they all commute. In particular, a square on one side of any of the equivalences (a-c) commutes if and only if the square on the other side of the equivalence commutes.

**Proof.** The claims are established as follows.

(1)  $\stackrel{(a)}{\Rightarrow}$  (2): Using the commutativity of (1) and (\*) the counit equation  $\varepsilon \circ \beta = \text{id}$  for the coalgebra  $\beta$ , we derive (2) as

$$\alpha \circ F_*F^*f \circ F_*\beta \stackrel{(1)}{=} f \circ F_*\varepsilon \circ F_*\beta \stackrel{(*)}{=} f$$

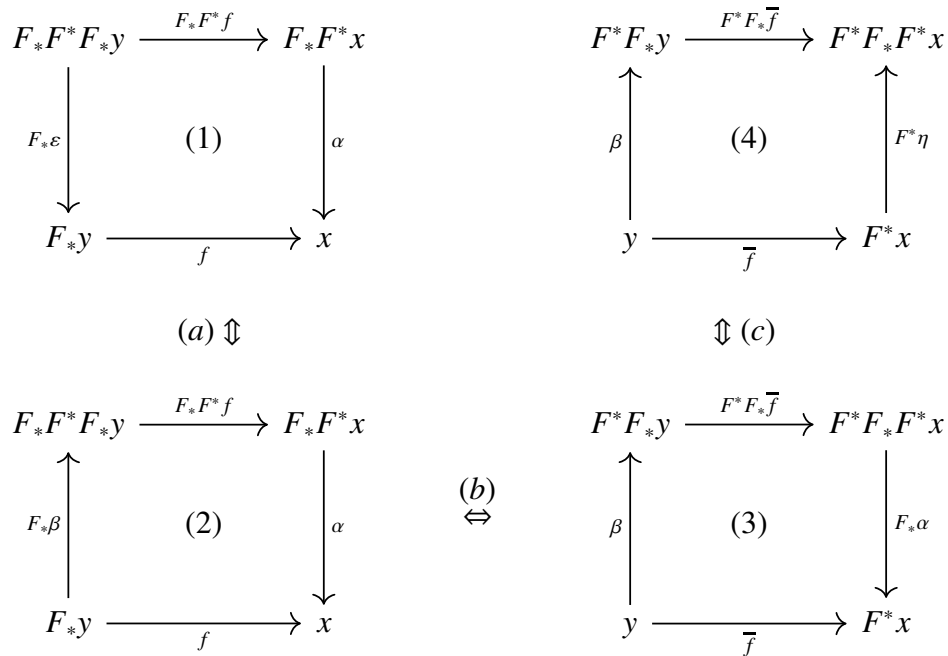
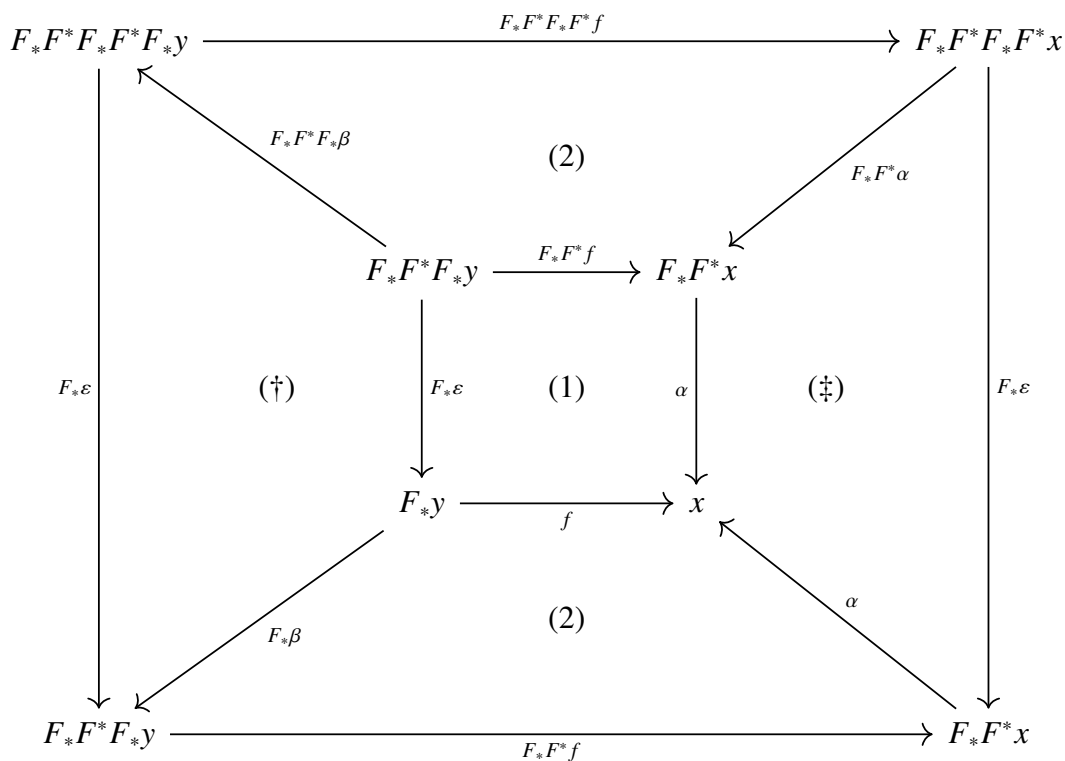

Figure 19: Proof schema for (76)

(2)  $\stackrel{(a)}{\Rightarrow}$  (1) is proved by chasing the following diagram:





The top and the bottom trapezoids commute by assumption (2), whereas the left hand trapezoid (denoted ( $\dagger$ )) and the outer square (denoted ( $\square$ )) commute by the naturality of  $\varepsilon$ . The right hand trapezoid (denoted ( $\ddagger$ )) commutes by the cochain condition for the algebra  $\alpha$ . It follows that the inner square (denoted (1)) must also commute:

$$\begin{aligned}
f \circ F_* \varepsilon &\stackrel{(2)}{=} \alpha \circ F_* F^* f \circ F_* \beta \circ F_* \varepsilon \\
&\stackrel{(\dagger)}{=} \alpha \circ F_* F^* f \circ F_* \varepsilon \circ F_* F^* F_* \beta \\
&\stackrel{(\square)}{=} \alpha \circ F_* \varepsilon \circ F_* F^* F_* F^* f \circ F_* F^* F_* \beta \\
&\stackrel{(\ddagger)}{=} \alpha \circ F_* \alpha^* \circ F_* F^* F_* F^* f \circ F_* F^* F_* \beta \\
&\stackrel{(2)}{=} \alpha \circ F_* F^* f
\end{aligned}$$

(4)  $\stackrel{(c)}{\Leftrightarrow}$  (3) is proven dually to (1)  $\stackrel{(a)}{\Leftrightarrow}$  (2) above. The duality consists of reversing the arrows, switching  $F_*$  and  $F^*$ , and also  $\alpha$  and  $\beta$ , and replacing  $\varepsilon$  with  $\eta$ .

(2)  $\stackrel{(b)}{\Leftrightarrow}$  (3) follows from Lemma 7.2. □

## 7.2 The adjunction of coalgebras and algebras is nuclear

**Proposition 7.4** *Consider an arbitrary adjunction  $F^* \dashv F_* : \mathbb{B} \rightarrow \mathbb{A}$  and its lifting to absolute completions  $F^* \dashv F_* : \underline{\mathbb{B}} \rightarrow \underline{\mathbb{A}}$ . The adjunction  $F^\sharp \dashv F_\sharp : \underline{\mathbb{A}}^{\overleftarrow{F}} \rightarrow \underline{\mathbb{B}}^{\overrightarrow{F}}$  constructed in Prop. 7.1 is nuclear:*

- $F^\sharp : \underline{\mathbb{B}}^{\overrightarrow{F}} \rightarrow \underline{\mathbb{A}}^{\overleftarrow{F}}$  is comonadic, and
- $F_\sharp : \underline{\mathbb{A}}^{\overleftarrow{F}} \rightarrow \underline{\mathbb{B}}^{\overrightarrow{F}}$  is monadic.

**Proof.** It is easy to see that the construction of  $\overleftarrow{\mathfrak{N}}F = (F^\sharp \dashv F_\sharp)$  in Prop. 7.1 is functorial, and that the comparison functors as used in Fig. 17 provide the monad unit  $F \xrightarrow{\eta} \overleftarrow{\mathfrak{N}}F$ . We show that  $\overleftarrow{\mathfrak{N}}F \xrightarrow{\overleftarrow{\mathfrak{N}}\eta} \overleftarrow{\mathfrak{N}}\overleftarrow{\mathfrak{N}}F$  is always an equivalence. This means that the comparison functors from  $\overleftarrow{\mathfrak{N}}F$  to  $\overleftarrow{\mathfrak{N}}\overleftarrow{\mathfrak{N}}F$  are equivalences. These comparison functors are constructed in Fig. 20, still under the names  $H^0$  and  $H_1$ , lifting the construction from Fig. 17. is an equivalence of categories. We prove this only for  $H^0$ . The argument for  $H_1$  is dual. Instantiating the usual definition of the comparison

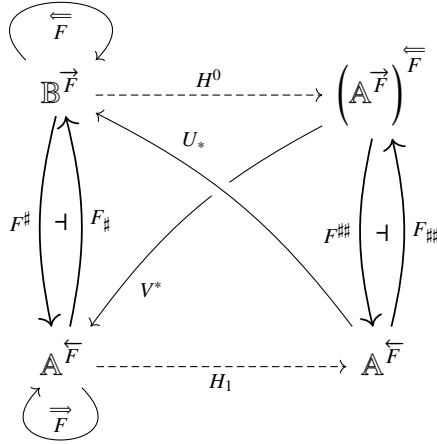

Figure 20: The construction of the nucleus  $\overleftarrow{\mathfrak{N}}\overleftarrow{\mathfrak{N}}F = (F^{\sharp\sharp} \dashv F_{\sharp\sharp})$  of nucleus  $\overleftarrow{\mathfrak{N}}F = (F^\sharp \dashv F_\sharp)$

functor for the comonad  $\overrightarrow{F} : \mathbb{A}^{\overleftarrow{F}} \rightarrow \mathbb{B}^{\overrightarrow{F}}$  to the resolution  $F^\sharp \dashv F_\sharp$ , we get

$$\begin{array}{ccc}
 \mathbb{B}^{\overrightarrow{F}} & \xrightarrow{H^0} & (\mathbb{A}^{\overleftarrow{F}})^{\overleftarrow{F}} \\
 \\
 \begin{array}{c} y \\ \downarrow \beta \\ F^*F_*y \end{array} & \mapsto & \begin{array}{ccc}
 F_*F^*F_*y & \xrightarrow{F_*\varepsilon_y =} & F_*y \\
 \downarrow F_*F^*F_*\beta & & \downarrow F_*\beta \\
 F_*F^*F_*F^*F_*y & \xrightarrow{F^\sharp F_\sharp F^\sharp \beta} & F_*F^*F_*y \\
 & = F_*\varepsilon_{\overrightarrow{F}y} & 
 \end{array}
 \end{array} \tag{77}$$

Since by assumption the idempotents split in  $\mathbb{B}$ , the comparison functor  $H^0$  also has a right adjoint





In  $\mathbb{A}$ , the split equalizer (81) unfolds to the lower squares of the following diagram

$$\begin{array}{ccccc}
 & & & & F_*\varepsilon \\
 & & & & \curvearrowright \\
 & & & & F_*F^*d \\
 x & \xrightarrow{d} & F_*F^*x & \xrightarrow{F_*F^*d} & F_*F^*F_*F^*x \\
 & \searrow \alpha & & \searrow F_*F^*\eta & \\
 & & & & F_*F^*\eta \\
 & & & & \curvearrowright \\
 & & & & F^*F_*\varepsilon \\
 F_*F^*x & \xrightarrow{F_*F^*d} & F_*F^*F_*x & \xrightarrow{F_*F^*F_*d} & F_*F^*F_*F^*F_*x \\
 & \searrow F_*F^*\alpha & & \searrow F_*F^*F_*\eta & \\
 & & & & F_*\varepsilon \\
 & & & & \curvearrowright \\
 & & & & F_*\varepsilon \\
 x & \xrightarrow{d} & F_*F^*x & \xrightarrow{F_*F^*d} & F_*F^*F_*F^*x \\
 & \searrow \alpha & & \searrow F_*F^*\eta & \\
 & & & & F_*\varepsilon
 \end{array} \tag{82}$$

Since the upper right-hand squares also commute (by the naturality of  $\eta$ ), they also induce the factoring of the split equalizers in the upper left-hand square. But the upper right-hand squares in (82) are identical to the right-hand squares in (80). The fact that both  $F_*y \xrightarrow{F_*e} F_*F^*x$  and  $x \xrightarrow{d_*} F_*F^*x$  are split equalizers of the same pair yields the isomorphism  $F_*y \xrightarrow{\iota} x$  in  $\mathbb{A}$ , which turns out to be a coalgebra isomorphism  $H^0H_0\delta \xrightarrow{\iota} \delta$  in  $(\mathbb{A}^{\overline{F}})^{\overline{F}}$ , as shown in (83).

$$\begin{array}{ccccc}
 F_*F^*x & \xrightarrow{\alpha} & & & x \\
 & \searrow F_*F^*\iota & & & \downarrow d \\
 & & F_*F^*F_*y & \xrightarrow{F_*\varepsilon} & F_*y \\
 & & \downarrow F_*F^*F_*H_0\delta & & \downarrow F_*H_0\delta \\
 & & F_*F^*F_*F_*y & \xrightarrow{F_*\varepsilon} & F_*F^*F_*y \\
 & \searrow F_*F^*F_*\iota & & & \downarrow F_*F^*\iota \\
 F_*F^*F_*F^*x & \xrightarrow{F_*\varepsilon} & & & F_*F^*x
 \end{array} \tag{83}$$

Here the outer square is  $\delta$ , as in (78) on the left, whereas the inner square is  $H^0H_0\delta$ , as in (80) on the left. The right-hand trapezoid commutes because the middle square in (80) commutes, and can

be chased down to (84) using the fact that  $\iota$  is defined by  $F_*e = d \circ \iota$ .

$$\begin{array}{ccc}
 & \xrightarrow{F_*e} & \\
 F_*y & \xrightarrow{\iota} x \xrightarrow{\delta} & F_*F^*x \\
 \downarrow F_*H_0\delta & & \downarrow F_*F^*\eta \\
 F_*F^*F_*F^*y & \xrightarrow{F_*F^*\iota} F_*F^*x \xrightarrow{F_*F^*\delta} & F_*F^*F_*F^*x \\
 & \xrightarrow{F_*F^*F_*e} & 
 \end{array}
 \tag{84}$$

The commutativity of the left-hand trapezoid in (83) follows, because it is an  $F_*F^*$ -image of the right-hand trapezoid. The bottom trapezoid commutes by the naturality of  $\varepsilon$ . The top trapezoid commutes because everything else commutes, and  $d$  is a monic. The commutative diagram in (83) thus displays the claimed isomorphism  $H^0H_0\delta \xrightarrow{\iota} \delta$ . This completes the proof that  $H^0H_0 \cong \text{id}$ . Together with the proof that  $H_0H^0 \cong \text{id}$ , as seen in (79), this also completes the proof that

$H = \left( H^0 \dashv H_0 : \left( \mathbb{A}^{\overleftarrow{F}} \right)^{\overrightarrow{F}} \rightarrow \mathbb{B}^{\overrightarrow{F}} \right)$  is an equivalence. We have thus shown that  $F^\sharp : \mathbb{B}^{\overrightarrow{F}} \rightarrow \mathbb{A}^{\overleftarrow{F}}$  is comonadic. The proof that  $F_\sharp : \mathbb{A}^{\overleftarrow{F}} \rightarrow \mathbb{B}^{\overrightarrow{F}}$  can be constructed as a mirror image.  $\square$

**Corollary 7.5** *For any adjunction  $F = (F^* \dashv F_* : \mathbb{B} \rightarrow \mathbb{A})$  over absolutely complete categories, with the nucleus  $\overleftarrow{\mathfrak{N}}(F) = (F^\sharp \dashv F_\sharp : \mathbb{A}^{\overleftarrow{F}} \rightarrow \mathbb{B}^{\overrightarrow{F}})$ , the induced monad  $\overleftarrow{F} = F_\sharp F^\sharp$  on  $\mathbb{B}^{\overrightarrow{F}}$  and the comonad  $\overrightarrow{F} = F^\sharp F_\sharp$  on  $\mathbb{A}^{\overleftarrow{F}}$  are isomorphic with those induced by the final resolutions of  $F$ , i.e.*

$$\begin{aligned}
 \overleftarrow{F} &\cong \left( \mathbb{B}^{\overrightarrow{F}} \xrightarrow{V^*} \mathbb{B} \xrightarrow{V_*} \mathbb{B}^{\overrightarrow{F}} \right) \\
 \overrightarrow{F} &\cong \left( \mathbb{A}^{\overleftarrow{F}} \xrightarrow{U_*} \mathbb{A} \xrightarrow{U^*} \mathbb{A}^{\overleftarrow{F}} \right)
 \end{aligned}$$

The monad  $\overleftarrow{F}$  on  $\mathbb{B}^{\overrightarrow{F}}$  therefore only depends on the comonad  $\overrightarrow{F} = F^*F_*$  on  $\mathbb{B}$ , whereas the comonad  $\overrightarrow{F}$  on  $\mathbb{A}^{\overleftarrow{F}}$  only depends on the monad  $\overleftarrow{F} = F_*F^*$  on  $\mathbb{A}$ . Neither of them depends on the particular resolutions  $F^* \dashv F_*$  of  $\overrightarrow{F}$  or  $\overleftarrow{F}$ .

**Proof.** Using the definitions  $F_\sharp = H^0U_*$  and  $F^\sharp = H_1F^*$ , and chasing Fig. 17 gives

$$\begin{aligned}
 \overleftarrow{F} &= F_\sharp F^\sharp = H^0U_*H_1V^* = H^0F_*V^* = V_*V^* \\
 \overrightarrow{F} &= F^\sharp F_\sharp = H_1V^*H^0U_* = H_1F^*V_* = U^*U_*
 \end{aligned}$$

$\square$

**Corollary 7.6** *All resolutions of a monad over an absolutely complete category induce equivalent categories of coalgebras. More precisely, for any given monad  $\overleftarrow{T} : \underline{\mathbb{A}} \rightarrow \underline{\mathbb{A}}$  any pair of adjunctions  $F^* \dashv F_* : \underline{\mathbb{B}} \rightarrow \underline{\mathbb{A}}$  and  $G^* \dashv G_* : \underline{\mathbb{D}} \rightarrow \underline{\mathbb{A}}$  holds*

$$\overleftarrow{F} \cong \overleftarrow{T} \cong \overleftarrow{G} \implies \underline{\mathbb{B}}^{\overrightarrow{F}} \simeq \underline{\mathbb{D}}^{\overrightarrow{G}} \quad (85)$$

where  $\overleftarrow{F} = F^*F_*$ ,  $\overrightarrow{F} = F^*F_*$ ,  $\overleftarrow{G} = G^*G_*$  and  $\overrightarrow{G} = G^*G_*$ . The equivalences are natural with respect to the monad morphisms. Comonads satisfy the dual claim.

**Proof.** By Corollary 7.5, the comonads  $\overrightarrow{F}$  and  $\overrightarrow{G}$  on the category  $\underline{\mathbb{A}}^{\overleftarrow{F}} \simeq \underline{\mathbb{A}}^{\overleftarrow{T}} \simeq \underline{\mathbb{A}}^{\overleftarrow{G}}$  do not depend on the particular resolutions  $F^* \dashv F_*$  and  $G^* \dashv G_*$ , but depend only on the monad  $\overleftarrow{F} \cong \overleftarrow{T} \cong \overleftarrow{G}$ , and must be in the form  $\overrightarrow{F} \cong \overrightarrow{G} \cong \overrightarrow{T} = \left( \underline{\mathbb{A}}^{\overleftarrow{T}} \xrightarrow{U_*} \underline{\mathbb{A}} \xrightarrow{U^*} \underline{\mathbb{A}}^{\overleftarrow{T}} \right)$ . Hence

$$\underline{\mathbb{B}}^{\overrightarrow{F}} \simeq \left( \underline{\mathbb{A}}^{\overleftarrow{F}} \right)^{\overrightarrow{F}} \simeq \left( \underline{\mathbb{A}}^{\overleftarrow{T}} \right)^{\overrightarrow{T}} \simeq \left( \underline{\mathbb{A}}^{\overleftarrow{G}} \right)^{\overrightarrow{G}} \simeq \underline{\mathbb{C}}^{\overrightarrow{G}}$$

where Prop. 7.4 is used at the first and at the last step, and Corollary 7.5 in the middle.  $\square$

**Corollary 7.7** *For any adjunction  $F^* \dashv F_* : \underline{\mathbb{B}} \rightarrow \underline{\mathbb{A}}$  over absolutely complete categories, monad  $\overleftarrow{F}$ , and comonad  $\overrightarrow{F}$  holds*

$$\left( \underline{\mathbb{A}}^{\overleftarrow{F}} \right)^{\overrightarrow{F}} \simeq \left( \underline{\mathbb{A}}_{\overleftarrow{F}} \right)^{\overrightarrow{F}} \quad \left( \underline{\mathbb{B}}^{\overrightarrow{F}} \right)^{\overleftarrow{F}} \simeq \left( \underline{\mathbb{B}}_{\overrightarrow{F}} \right)^{\overleftarrow{F}}$$

where  $\underline{\mathbb{A}}_{\overleftarrow{F}}$  is the (Kleisli-)category of free  $\overleftarrow{F}$ -algebras,  $\underline{\mathbb{A}}^{\overleftarrow{F}}$  is the (Eilenberg-Moore-)category of all  $\overleftarrow{F}$ -algebras, and similarly  $\underline{\mathbb{B}}_{\overrightarrow{F}}$  and  $\underline{\mathbb{B}}^{\overrightarrow{F}}$ . These equivalences induce the natural correspondences

$$\text{EC} \circ \text{AC} \circ \text{KM} \cong \text{EC} \circ \text{AC} \circ \text{EM} \quad (86)$$

$$\text{EM} \circ \text{AM} \circ \text{KC} \cong \text{EM} \circ \text{AM} \circ \text{EC} \quad (87)$$

over  $\underline{\text{Mnd}}$  and  $\underline{\text{Cmn}}$ , respectively.

**Proof.** The claims are special cases of Corollary 7.6, obtained by taking pairs of resolutions considered there to be the initial resolution, into free algebras (or cofree coalgebras), and the final resolution, into all algebras (resp. coalgebras).  $\square$

**Corollary 7.8** *The construction in Prop. 7.1 induces the monad*

$$\begin{aligned} \overleftarrow{\mathfrak{N}} : \text{Adj} &\longrightarrow \text{Adj} \\ (F^* \dashv F_* : \underline{\mathbb{B}} \rightarrow \underline{\mathbb{A}}) &\longmapsto (F^\# \dashv F_\# : \underline{\mathbb{A}}^{\overleftarrow{F}} \rightarrow \underline{\mathbb{B}}^{\overrightarrow{F}}) \end{aligned}$$

*This monad is strongly idempotent, in the sense that there is a natural equivalence*

$$\overleftarrow{\mathfrak{N}} \cong \eta \circ \overleftarrow{\mathfrak{N}} \circ \overleftarrow{\mathfrak{N}}$$

**Proof.** The monad unit  $(F^* \dashv F_*) \xrightarrow{\eta} (\underline{F}^\# \dashv \underline{F}_\#)$  consists of the comparison functors, as imposed by the definition of  $\underline{F}^*$  and  $\underline{F}_*$  in the statement of Prop. 7.1, Fig. 17. The naturality follows directly from the definitions. The fact that both comparison functors are equivalences was proved in Prop. 7.4 for absolutely complete categories. Since the absolute completion is also idempotent, the claim that  $\eta$  is an equivalence for any adjunction  $F$  follows.  $\square$

**Corollary 7.9** *The distributive law between the idempotent monads  $\overleftarrow{\text{EM}}, \overleftarrow{\text{EC}} : \text{Adj} \rightarrow \text{Adj}$ , where  $\overleftarrow{\text{EM}}(F) = \text{EM} \circ \text{AM}(F)$  and  $\overleftarrow{\text{EC}}(F) = \text{EC} \circ \text{AC}(F)$ , arises from the fact that applying both in any order yields the nucleus:*

$$\overleftarrow{\text{EM}} \circ \overleftarrow{\text{EC}} \simeq \overleftarrow{\mathfrak{N}} \simeq \overleftarrow{\text{EC}} \circ \overleftarrow{\text{EM}} \tag{88}$$

**Proof.** The distributivity law is displayed in Fig. 21. The comonad on  $\underline{\underline{A}}^{\overleftarrow{F}}$  and the monad on  $\underline{\underline{B}}^{\overrightarrow{F}}$  have just been spelled out in Corollary 7.5.  $\square$

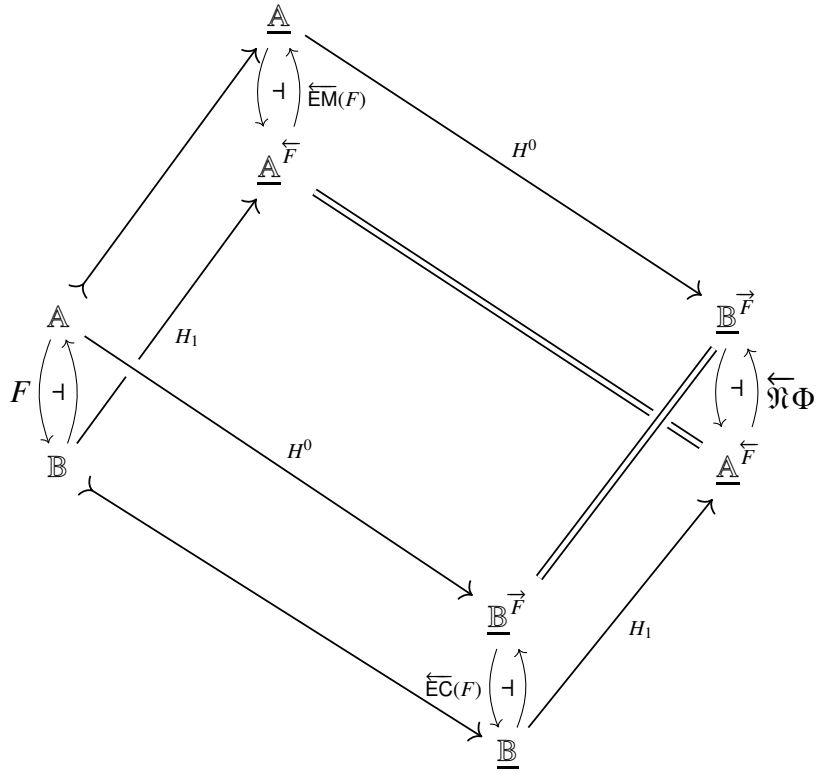

Figure 21: The nucleus construction  $\overleftarrow{\mathfrak{N}}$  factorized into  $\overleftarrow{\text{EM}} \circ \overleftarrow{\text{EC}} \cong \overleftarrow{\text{EC}} \circ \overleftarrow{\text{EM}}$

**Remark.** Note that Fig. 21 the commutative square from Fig. 3 inside the category  $\text{Adj}$ .



**Proof of Thm. 6.** The following derivations show that the Street monads  $\overleftarrow{\mathfrak{M}}$  and  $\overleftarrow{\mathfrak{C}}$  are retracts of the nucleus monad  $\overleftarrow{\mathfrak{N}}$  from Adj to Mnd and to Cmn, respectively.

$$\begin{aligned}
\overleftarrow{\mathfrak{M}}(\overleftarrow{T}) &= \text{AM} \circ \text{EC} \circ \text{AC} \circ \text{KM}(\overleftarrow{T}) & \overleftarrow{\mathfrak{C}} &= \text{AC} \circ \text{EM} \circ \text{AM} \circ \text{KC}(\overleftarrow{T}) \\
&\stackrel{(86)}{\cong} \text{AM} \circ \text{EC} \circ \text{AC} \circ \text{EM}(\overleftarrow{T}) & &\stackrel{(87)}{\cong} \text{AC} \circ \text{EM} \circ \text{AM} \circ \text{EC}(\overleftarrow{T}) \\
&\stackrel{(\dagger)}{\cong} \text{AM} \circ \text{EC} \circ \text{AC} \circ \text{EM} \circ \text{AM} \circ \text{EM}(\overleftarrow{T}) & &\stackrel{(\dagger)}{\cong} \text{AC} \circ \text{EM} \circ \text{AM} \circ \text{EC} \circ \text{AC} \circ \text{EC}(\overleftarrow{T}) \\
&= \text{AM} \circ \overleftarrow{\text{EC}} \circ \overleftarrow{\text{EM}} \circ \text{EM}(\overleftarrow{T}) & &= \text{AC} \circ \overleftarrow{\text{EM}} \circ \overleftarrow{\text{EC}} \circ \text{EC}(\overleftarrow{T}) \\
&\stackrel{(88)}{\cong} \text{AM} \circ \overleftarrow{\mathfrak{N}} \circ \text{EM}(\overleftarrow{T}) & &\stackrel{(88)}{\cong} \text{AC} \circ \overleftarrow{\mathfrak{N}} \circ \text{EC}(\overleftarrow{T})
\end{aligned}$$

At step  $(\dagger)$ , we use the fact that the monads  $\overleftarrow{\text{EM}}(F) = \text{EM} \circ \text{AM}(F)$  and  $\overleftarrow{\text{EC}}(F) = \text{EC} \circ \text{AC}(F)$  are idempotent. The natural isomorphisms  $\overleftarrow{\mathfrak{M}} \cong \overleftarrow{\mathfrak{M}} \circ \overleftarrow{\mathfrak{N}}$  and  $\overleftarrow{\mathfrak{C}} \cong \overleftarrow{\mathfrak{C}} \circ \overleftarrow{\mathfrak{N}}$  are derived from  $\overleftarrow{\mathfrak{N}} \cong \overleftarrow{\mathfrak{N}} \circ \overleftarrow{\mathfrak{N}}$  and either  $\overleftarrow{\text{EM}} \cong \overleftarrow{\text{EM}} \circ \overleftarrow{\text{EM}}$  or  $\overleftarrow{\text{EC}} \cong \overleftarrow{\text{EC}} \circ \overleftarrow{\text{EC}}$ , and retracting to Mnd or Cmn, respectively. The equivalences  $\text{Mnd}^{\overleftarrow{\mathfrak{M}}} \simeq \text{Adj}^{\overleftarrow{\mathfrak{N}}} \simeq \text{Cmn}^{\overleftarrow{\mathfrak{C}}}$  arise from these derivations. The fact that  $\text{Adj}^{\overleftarrow{\mathfrak{N}}}$  is equivalent with the category Nuc, defined in (73), and used in (71), follows from Corollary 7.9.  $\square$

## 8 Simple nucleus

Monads and comonads fold algebraic and coalgebraic constructions into functors and natural transformations. The adjunctions  $F^* \dashv F_* : \mathbb{B} \rightarrow \mathbb{A}$  where  $F_* F^* \cong \overleftarrow{F}$  resolve the algebraic constructions folded within the monad  $\overleftarrow{F}$ , and the coalgebraic constructions folded within the comonad  $\overrightarrow{F}$ . The categories  $\mathbb{A}_{\overleftarrow{F}}$  of free  $\overleftarrow{F}$ -algebras and the category  $\mathbb{A}^{\overleftarrow{F}}$  of all  $\overleftarrow{F}$ -algebras frame all resolutions of the monad  $\overleftarrow{F}$ , since  $\mathbb{A}_{\overleftarrow{F}}$  is initial one and  $\mathbb{A}^{\overleftarrow{F}}$  is final [14, 28, 53]. Corollary 7.6 says that all such resolutions also induce categories of coalgebras which are, assuming just the absolute completeness, equivalent to  $\left(\underline{\mathbb{A}}^{\overleftarrow{F}}\right)^{\overrightarrow{F}}$ . Any monad  $\overleftarrow{F}$  thus induces two final resolutions:

- the final algebraic resolution  $\mathbb{A}^{\overleftarrow{F}}$  and
- the final coalgebraic resolution  $\left(\underline{\mathbb{A}}^{\overleftarrow{F}}\right)^{\overrightarrow{F}}$ .

The latter was called the *category of coalgebras for the monad  $\overleftarrow{F}$*  in [83]. Dually, any comonad  $\overrightarrow{F} : \mathbb{B} \rightarrow \mathbb{B}$  induces a category of algebras  $\left(\underline{\mathbb{B}}^{\overrightarrow{F}}\right)^{\overleftarrow{F}}$ . The notation shows that  $\left(\underline{\mathbb{A}}^{\overleftarrow{F}}\right)^{\overrightarrow{F}}$  and  $\left(\underline{\mathbb{B}}^{\overrightarrow{F}}\right)^{\overleftarrow{F}}$  are built in two layers. The two-layer presentation contains redundancies, since the algebra conditions depend on the coalgebra conditions, and vice versa. Removing the redundancies yields a structure that turns out to be simpler not only than the composite, but also simpler than either of the components.

## 8.1 Simple nucleus of an adjunction

As a notational convenience, we fix a resolution  $F^* \dashv F_* : \underline{\mathbb{B}} \rightarrow \underline{\mathbb{A}}$  of a given monad  $\overleftarrow{F} = F_*F^*$ . The following was spelled out in [83] for a particular application.

**Proposition 8.1** *Given an adjunction  $F = (F^* \dashv F_* : \underline{\mathbb{B}} \rightarrow \underline{\mathbb{A}})$ , consider the categories*

$$|\underline{\mathbb{A}}^{\overleftarrow{F}}| = \coprod_{x \in |\underline{\mathbb{A}}|} \left\{ \alpha_x \in \underline{\mathbb{B}}(F^*x, F^*x) \mid \begin{array}{ccccc} F^*x & F_*F^*x & \xrightarrow{\quad} & x & \\ \downarrow \alpha_x & \searrow \alpha_x & & \searrow F_*\alpha_x & \downarrow \tilde{\alpha}_x \\ F^*x & \xrightarrow{\alpha_x} & F^*x & & F_*F^*x \end{array} \right\} \quad (89)$$

$$\underline{\mathbb{A}}^{\overleftarrow{F}}(\alpha_x, \gamma_z) = \left\{ f \in \underline{\mathbb{A}}(x, z) \mid \begin{array}{ccc} F^*x & \xrightarrow{F^*f} & F^*z \\ \downarrow \alpha_x & & \downarrow \gamma_z \\ F^*x & \xrightarrow{F^*f} & F^*z \end{array} \right\}$$

$$|\underline{\mathbb{B}}^{\overleftarrow{F}}| = \coprod_{u \in |\underline{\mathbb{B}}|} \left\{ \beta^u \in \underline{\mathbb{A}}(F_*u, F_*u) \mid \begin{array}{ccccc} F_*x & F_*F_*u & \xrightarrow{\tilde{\beta}^u} & u & \\ \downarrow \beta^u & \searrow \beta^u & & \searrow F^*\beta^u & \downarrow \\ F_*u & \xrightarrow{\beta^u} & F_*u & & F^*F_*u \end{array} \right\} \quad (90)$$

$$\underline{\mathbb{B}}^{\overleftarrow{F}}(\beta^u, \delta^w) = \left\{ g \in \underline{\mathbb{B}}(u, w) \mid \begin{array}{ccc} F_*u & \xrightarrow{F_*g} & F_*w \\ \downarrow \beta^u & & \downarrow \delta^w \\ F_*u & \xrightarrow{F_*g} & F_*w \end{array} \right\}$$

where  $x \xrightarrow{\tilde{\alpha}_x} F_*F^*x$  is the transpose of  $F^*x \xrightarrow{\alpha_x} F^*x$ , and  $F^*F_*u \xrightarrow{\tilde{\beta}^u} u$  is the transpose of  $F_*u \xrightarrow{\beta} F_*u$ .

The adjunction  $F^\natural \dashv F_\natural : \underline{\mathbb{B}}^{\overleftarrow{F}} \rightarrow \underline{\mathbb{A}}^{\overleftarrow{F}}$  defined in Fig. 22 with the comparison functors

$$K^0 : \underline{\mathbb{A}} \longrightarrow \underline{\mathbb{A}}^{\overleftarrow{F}} \qquad K_1 : \underline{\mathbb{B}} \longrightarrow \underline{\mathbb{B}}^{\overleftarrow{F}}$$

$$x \mapsto \left\langle F_*F^*x, \begin{array}{c} F_*F_*F^*x \\ \varepsilon F^* \downarrow \\ F^*x \\ F^*\eta \downarrow \\ F_*F_*F^*x \end{array} \right\rangle \qquad u \mapsto \left\langle F^*F_*u, \begin{array}{c} F_*F_*F_*u \\ F_*\varepsilon \downarrow \\ F_*u \\ \eta F_* \downarrow \\ F_*F_*F_*u \end{array} \right\rangle$$

is equivalent to the nucleus, i.e.

$$\overleftarrow{\mathfrak{N}}(F^* \dashv F_*) \simeq (F^\natural \dashv F_\natural)$$

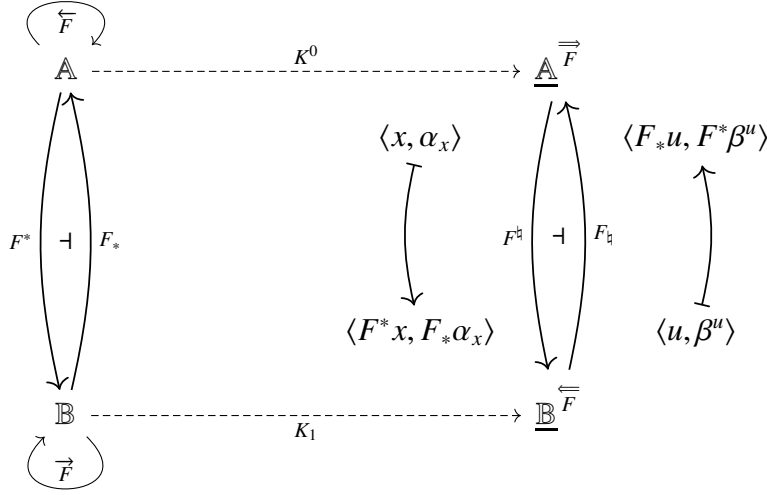

Figure 22: The simple nucleus  $F^\sharp \dashv F_\sharp$  of  $F^* \dashv F_*$

**Lemma 8.2** If  $\left(F_*F^*x \xrightarrow{F_*\alpha_x} F_*F^*x\right) = \left(F_*F^*x \xrightarrow{\alpha^x} x \xrightarrow{\tilde{\alpha}_x} F_*F^*x\right)$ , where  $\tilde{\alpha}_x = F_*\alpha_x \circ \eta_x$  is a monic and  $\alpha^x$  is an epi, then  $\alpha^x \circ \eta_x = \text{id}$ .

**Proof.**  $\tilde{\alpha}_x \circ \alpha^x = F_*\alpha_x \circ \eta_x \circ \alpha^x = \tilde{\alpha}_x \circ \alpha^x \circ \eta_x \circ \alpha^x$  implies  $\alpha^x = \alpha^x \circ \eta_x \circ \alpha^x$  because  $\tilde{\alpha}_x$  is a monic, and  $\text{id} = \alpha^x \circ \eta_x$  because  $\alpha^x$  is epi.  $\square$

**Proof of Prop. 8.1.** Still writing  $F_*F^*x \xrightarrow{\alpha^x} x \xrightarrow{\tilde{\alpha}_x} F_*F^*x$ , like in Lemma 8.2, for the splitting of the idempotent  $F_*F^*x \xrightarrow{F_*\alpha_x} F_*F^*x$ , the equations

$$\alpha^x \circ \tilde{\alpha}_x = \text{id}_x \quad \text{and} \quad \alpha^x \circ \eta_x = \text{id}_x \quad (91)$$

follow. Analogous reasoning proves

$$\begin{aligned} \alpha^x \circ F_*F^*\alpha^x &= \alpha^x \circ F_*\varepsilon_{F_*x} \\ \tilde{\alpha}_x \circ \alpha^x &= F_*\varepsilon_{F_*x} \circ F_*F^*\tilde{\alpha}_x \end{aligned}$$

Together with (91), these equations say that  $F_*F^*x \xrightarrow{\alpha^x} x$  is an algebra in  $\underline{\underline{A}}^{\overline{\overline{F}}}$  and that  $\tilde{\alpha}_x \in \underline{\underline{A}}^{\overline{\overline{F}}}(\alpha^x, \mu_x)$  is an algebra homomorphism, and moreover a coalgebra over  $\alpha^x$  in  $\left(\underline{\underline{A}}^{\overline{\overline{F}}}\right)^{\overline{\overline{F}}}$ . Hence a functor  $\underline{\underline{A}}^{\overline{\overline{F}}} \rightarrow \left(\underline{\underline{A}}^{\overline{\overline{F}}}\right)^{\overline{\overline{F}}}$ . Similar construction yields a similar functor  $\underline{\underline{B}}^{\overline{\overline{F}}} \rightarrow \left(\underline{\underline{B}}^{\overline{\overline{F}}}\right)^{\overline{\overline{F}}}$ . Hence the equivalences

$$\underline{\underline{A}}^{\overline{\overline{F}}} \simeq \left(\underline{\underline{A}}^{\overline{\overline{F}}}\right)^{\overline{\overline{F}}} \quad \underline{\underline{B}}^{\overline{\overline{F}}} \simeq \left(\underline{\underline{B}}^{\overline{\overline{F}}}\right)^{\overline{\overline{F}}}$$

The equivalences

$$\underline{\mathbb{A}}^{\overrightarrow{F}} \simeq \underline{\mathbb{B}}^{\overrightarrow{F}} \qquad \underline{\mathbb{B}}^{\overleftarrow{F}} \simeq \underline{\mathbb{A}}^{\overleftarrow{F}}$$

have been verified in [83]. Every object  $\langle x, F^*x \xrightarrow{\alpha_x} F^*x \rangle$  of  $\underline{\mathbb{A}}^{\overrightarrow{F}}$  was shown to be isomorphic to one in the form  $\langle F_*y, F^*F_* \xrightarrow{\varepsilon} y \xrightarrow{\beta} F^*F_*y \rangle$ , where  $\beta$  is a coalgebra in  $\underline{\mathbb{B}}^{\overrightarrow{F}}$ . It follows that both squares in the following diagram commute

$$\begin{array}{ccc}
F^*x & \xrightarrow{F^*\eta} & F^*F_*F^*x \\
\downarrow \alpha_x & \swarrow F^*\iota & \downarrow \alpha_x \\
& F^*F_*y & \xrightarrow{F^*\eta F_*} & F^*F_*F^*F_*y \\
& \downarrow \varepsilon & & \downarrow F^*F_*\varepsilon \\
& y & \xrightarrow{\beta} & F^*F_*y \\
& \downarrow \beta & & \downarrow F^*F_*\beta \\
& F^*F_*y & \xrightarrow{F^*\eta F_*} & F^*F_*F^*F_*y \\
\downarrow \alpha_x & \swarrow F^*\iota & \downarrow \alpha_x & \swarrow F^*F_*\iota \\
F^*x & \xrightarrow{F^*\eta} & F^*F_*F^*x
\end{array} \tag{92}$$

where  $x \leftarrow \iota \rightarrow F_*y$  an isomorphism in  $\mathbb{A}$ . Transferring the nuclear adjunction  $F^\natural \dashv F_\sharp : \underline{\mathbb{A}}^{\overleftarrow{F}} \rightarrow \underline{\mathbb{B}}^{\overleftarrow{F}}$  along the equivalences yields the nuclear adjunction  $F^\natural \dashv F_\natural : \underline{\mathbb{B}}^{\overleftarrow{F}} \rightarrow \underline{\mathbb{A}}^{\overleftarrow{F}}$ , with the natural correspondence

$$\begin{aligned}
\underline{\mathbb{B}}^{\overleftarrow{F}}(F^\natural \alpha_x, \beta^u) &\cong \underline{\mathbb{A}}^{\overleftarrow{F}}(\alpha_x, F_\natural \beta^u) \\
(F^*x \xrightarrow{f} u) &\mapsto \tilde{f} = \left( x \xrightarrow{\eta} F_*F^*x \xrightarrow{F_*f} F_*u \right)
\end{aligned}$$

The adjunction correspondence  $F^* \dashv F_* : \mathbb{B} \rightarrow \mathbb{A}$  lifts to  $F^\natural \dashv F_\natural : \underline{\mathbb{B}}^{\overleftarrow{F}} \rightarrow \underline{\mathbb{A}}^{\overleftarrow{F}}$  because each of the following squares commutes if and only if the other one does:

$$\begin{array}{ccc}
F_*F^*x & \xrightarrow{F_*f} & F_*u \\
\downarrow F_*\alpha_x & & \downarrow \beta^u \\
F_*F^*x & \xrightarrow{F_*f} & F_*u \\
\iff & & \\
F^*x & \xrightarrow{F^*(\tilde{f})} & F^*F_*u \\
\downarrow \alpha_x & & \downarrow F^*\beta^u \\
F^*x & \xrightarrow{F^*(\tilde{f})} & F^*F_*u
\end{array} \tag{93}$$

To see this, suppose that the left-hand side square commutes. Take the  $F^*$ -image of the right-hand side square and precompose it with the outer square from (92), as in the following diagram.

$$\begin{array}{ccccc}
 & & F^*(\tilde{f}) & & \\
 & \searrow & \xrightarrow{\quad} & \searrow & \\
 F^*x & \xrightarrow{F^*\eta} & F^*F_*F^*x & \xrightarrow{F^*F_*f} & F^*F_*u \\
 \downarrow \alpha_x & & \downarrow F^*F_*\alpha_x & & \downarrow F^*\beta^u \\
 F^*x & \xrightarrow{F^*\eta} & F^*F_*F^*x & \xrightarrow{F^*F_*f} & F^*F_*u \\
 & \swarrow & \xrightarrow{\quad} & \swarrow & \\
 & & F^*(\tilde{f}) & & 
 \end{array} \tag{94}$$

The two outer paths around this diagram are the paths around right-hand square in (93). The right-to-left implication is analogous.  $\square$

## 8.2 Simple nucleus of a monad or a comonad

The simple nucleus of a monad  $\overleftarrow{T}$  or of a comonad  $\overrightarrow{T}$  can be extrapolated by applying the construction from Sec. 8.1 to constructions to the initial (Kleisli) or the final (Eilenberg-Moore) resolutions. Corollary 7.6 guarantees that either will do. The initial resolution gives a smaller object class, but that is not always an advantage. In any case, some resolutions do give simpler-looking simple nuclei. The objects of the category  $\underline{\mathbb{A}}^{\overleftarrow{F}}$  built over the Eilenberg-Moore resolution of a monad  $\overleftarrow{F}$  turn out to be the projective  $\overleftarrow{F}$ -algebras, but the morphisms are not just the  $\overleftarrow{F}$ -algebra homomorphisms, but also the homomorphisms of  $\overrightarrow{F}$ -coalgebras. The objects can be viewed as triples in the form  $\langle x, \alpha^x, \tilde{\alpha}_x \rangle$  which make the following diagrams commute.

$$\begin{array}{ccc}
 x \xrightarrow{\tilde{\alpha}_x} \overleftarrow{F}x & & \overleftarrow{F}\overleftarrow{F}x \xrightarrow{\overleftarrow{F}\alpha^x} \overleftarrow{F}x \xrightarrow{\overleftarrow{F}\tilde{\alpha}_x} \overleftarrow{F}\overleftarrow{F}x \\
 \eta \searrow & & \downarrow \mu \quad \downarrow \alpha^x \quad \downarrow \mu \\
 & & \overleftarrow{F}x \xrightarrow{\alpha^x} x \xrightarrow{\tilde{\alpha}_x} \overleftarrow{F}x \\
 \text{id} \searrow & & \\
 & & x
 \end{array} \tag{95}$$

Here we do not display just (89) instantiated to  $U^* \dashv U_* : \underline{\mathbb{A}}^{\overleftarrow{F}} \rightarrow \underline{\mathbb{A}}$ , but also the data that are implicit there, *viz* the middle filling in the rectangle on the right. It must be  $\alpha^x$  because  $\overleftarrow{F}\eta$  is the splitting of both  $\overleftarrow{F}\alpha^x$  and  $\mu$ . This assures that  $\alpha^x$  is an  $\overleftarrow{F}$ -algebra, whereas  $\tilde{\alpha}_x$  is an algebra homomorphism that embeds it as a subalgebra of the free  $\overleftarrow{F}$ -algebra  $\mu$ . So  $\alpha^x$  is a projective

algebra. On the other hand,  $\tilde{\alpha}_x$  is also an  $\overrightarrow{F}$ -coalgebra structure over the  $\overleftarrow{F}$ -algebra  $\alpha^x$ . An  $\underline{\mathbb{A}}^{\overrightarrow{F}}$ -morphism from  $\langle x, \alpha^x, \tilde{\alpha}_x \rangle$  to  $\langle z, \gamma^z, \tilde{\gamma}_z \rangle$  is an arrow  $f \in \underline{\mathbb{A}}(x, z)$  that makes the following diagram commute.

$$\begin{array}{ccccc}
 \overleftarrow{F}x & \xrightarrow{\alpha^x} & x & \xrightarrow{\tilde{\alpha}_x} & \overleftarrow{F}x \\
 \overleftarrow{F}f \downarrow & & \downarrow f & & \downarrow \overleftarrow{F}f \\
 \overleftarrow{F}z & \xrightarrow{\gamma^z} & z & \xrightarrow{\tilde{\gamma}_z} & \overleftarrow{F}z
 \end{array} \tag{96}$$

The left-hand square says that  $f$  is an  $\overleftarrow{F}$ -algebra homomorphism. The right-hand square says that it is also an  $\overrightarrow{F}$ -coalgebra homomorphism. So we are not looking at a category of projective algebras in  $\underline{\mathbb{A}}^{\overrightarrow{F}}$ , but at a category of  $\overrightarrow{F}$ -coalgebras over it, which turns out to be equivalent to  $\underline{\mathbb{B}}^{\overrightarrow{F}}$ , as Prop. 7.4 established. The conundrum that  $\overrightarrow{F}$ -coalgebras boil down to projective  $\overleftarrow{F}$ -algebras, but that the  $\overrightarrow{F}$ -coalgebra homomorphisms satisfy just two out of three conditions required from the  $\overleftarrow{F}$ -algebra homomorphisms was discussed and used in [83].

## 9 Little nucleus

Monads and comonads have initial (Kleisli) and final (Eilenberg-Moore) resolutions. The Street monads combine the final resolutions to extract the nuclei. The idea of the little nucleus is to combine the initial resolutions in a similar way. Towards a formalization of this idea, we call an adjunction  $F^* \dashv F_* : \mathbb{B} \rightarrow \mathbb{A}$  *subnuclear* if its two categories can be reconstructed from each other as initial resolutions of the induced monad and comonad:  $\mathbb{A}$  is equivalent to the cofree coalgebra (Kleisli) category  $\mathbb{B}_{\overrightarrow{F}}$  for the comonad  $\overrightarrow{F} = F^*F_* : \mathbb{B} \rightarrow \mathbb{B}$ , whereas  $\mathbb{B}$  is equivalent to the free algebra (Kleisli) category  $\mathbb{A}_{\overleftarrow{F}}$  for the monad  $\overleftarrow{F} = F_*F^* : \mathbb{A} \rightarrow \mathbb{A}$ . The comparison functors  $\mathbb{B}_{\overrightarrow{F}} \xrightarrow{E_0} \mathbb{A}$  and  $\mathbb{A}_{\overleftarrow{F}} \xrightarrow{E^1} \mathbb{B}$  are thus required to be equivalences. If the two initial resolutions are presented using the essentially surjective / fully faithful factorizations

$$\begin{aligned}
 F^* &= \left( \mathbb{A} \xrightarrow{U^b} \mathbb{A}_{\overleftarrow{F}} \xrightarrow{E^1} \mathbb{B} \right) \\
 F_* &= \left( \mathbb{B} \xrightarrow{V_b} \mathbb{B}_{\overrightarrow{F}} \xrightarrow{E_0} \mathbb{A} \right)
 \end{aligned}$$

(see Fig. 14), then the requirement that  $E^1$  and  $E_0$  are equivalences means that  $F^*$  and  $F_*$  in a subnuclear adjunction must be essentially surjective. We saw in Sec. 4.6 that the adjoint functors induced between the two initial (Kleisli) resolutions are indeed essentially surjective, and their adjunction is thus subnuclear; *but* that the further initial resolutions of this adjunction are not. The little nucleus, as the initial nucleus construction, therefore needs to be extracted from the

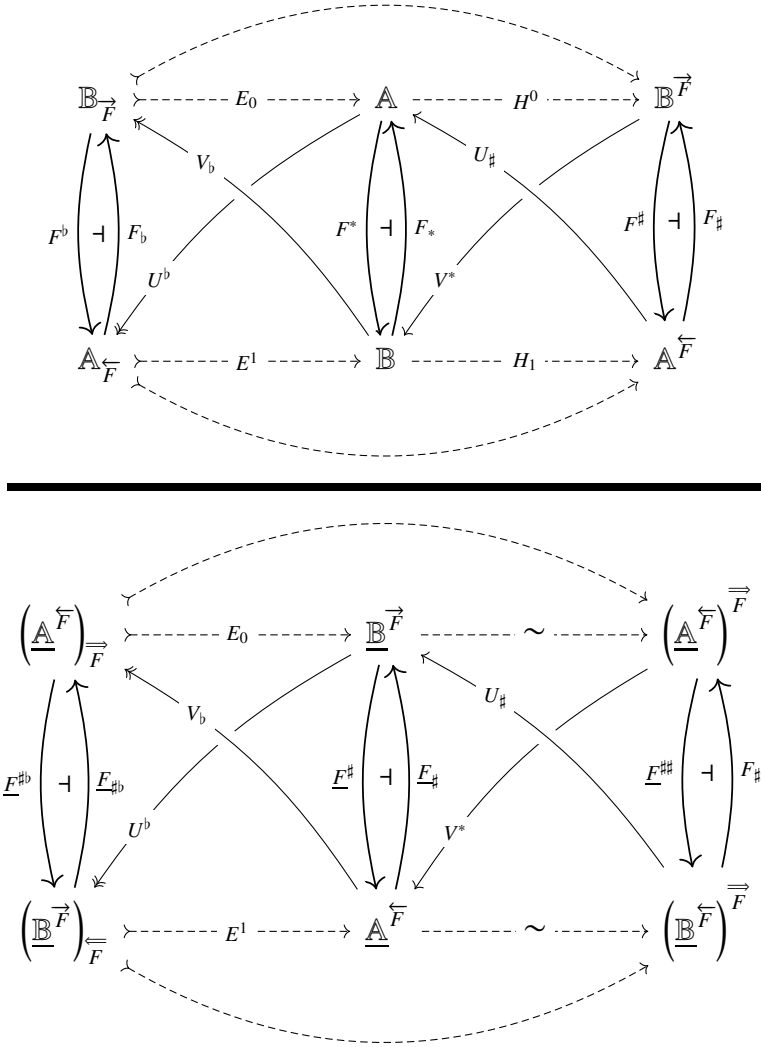

Figure 23: The resolutions of an adjunction  $F = (F^* \dashv F_*)$  and of its nucleus  $\overleftarrow{\mathfrak{N}}F = (\underline{F}^\# \dashv \underline{F}_\#)$

big nucleus. The situation is summarized in Fig. 23. The little nucleus thus arises as the initial resolution

$$\overrightarrow{\mathfrak{N}}(F^* \dashv F_* : \mathbb{B} \rightarrow \mathbb{A}) = \left( \underline{F}^{\#b} \dashv \underline{F}_{\#b} : \left( \underline{\mathbb{B}}^{\overrightarrow{F}} \right)_{\overleftarrow{F}} \rightarrow \left( \underline{\mathbb{A}}^{\overleftarrow{F}} \right)_{\overrightarrow{F}} \right)$$

of the (big) nucleus

$$\overleftarrow{\mathfrak{N}}(F^* \dashv F_* : \mathbb{B} \rightarrow \mathbb{A}) = \left( \underline{F}^\# \dashv \underline{F}_\# : \underline{\mathbb{A}}^{\overleftarrow{F}} \rightarrow \underline{\mathbb{B}}^{\overrightarrow{F}} \right)$$

which is itself the final resolution of the absolute completion of  $F = (F^* \dashv F_*)$ . Since Corollary 7.7 implies  $\overleftrightarrow{\mathfrak{N}}\overleftrightarrow{\mathfrak{N}}(F) \simeq \overleftarrow{\mathfrak{N}}\overleftarrow{\mathfrak{N}}(F)$ , and Prop. 7.4 says that  $\overleftarrow{\mathfrak{N}}$  is idempotent, tracking the equivalences through

$$\begin{array}{ccc}
 \overleftrightarrow{\mathfrak{N}}\overleftrightarrow{\mathfrak{N}}(F) & \xrightarrow{\simeq} & \overleftarrow{\mathfrak{N}}\overleftarrow{\mathfrak{N}}(F) \\
 \downarrow \simeq & & \downarrow \simeq \\
 \overrightarrow{\mathfrak{N}}\overrightarrow{\mathfrak{N}}(F) & \xrightarrow{\simeq} & \overleftarrow{\mathfrak{N}}\overleftarrow{\mathfrak{N}}(F) \\
 \downarrow \simeq & & \downarrow \simeq \\
 \overrightarrow{\mathfrak{N}}(F) & \xrightarrow{\simeq} & \overleftarrow{\mathfrak{N}}(F)
 \end{array} \tag{97}$$

yields a natural family  $\overrightarrow{\mathfrak{N}}\overrightarrow{\mathfrak{N}}(F) \simeq \overrightarrow{\mathfrak{N}}(F)$ . But spelling out these equivalences of categories of coalgebras over algebras and algebras over coalgebras is an unwieldy task. The flood of structure can be dammed by reducing the (big) nucleus to the simple form from Sec. 8

$$\overleftarrow{\mathfrak{N}}(F^* \dashv F_* : \mathbb{B} \rightarrow \mathbb{A}) = (F^{\natural} \dashv F_{\natural} : \underline{\mathbb{B}}^{\overleftarrow{F}} \rightarrow \underline{\mathbb{A}}^{\overleftarrow{F}})$$

and then defining the little nucleus in the simple form

$$\overrightarrow{\mathfrak{N}}(F^* \dashv F_* : \mathbb{B} \rightarrow \mathbb{A}) = (F^{\flat} \dashv F_{\flat} : \mathbb{A}_{\overrightarrow{F}} \rightarrow \mathbb{B}_{\overrightarrow{F}})$$

where the categories  $\mathbb{A}_{\overrightarrow{F}}$  and  $\mathbb{B}_{\overrightarrow{F}}$  are defined by the factorizations in Fig. 24. The category  $\mathbb{B}_{\overleftarrow{F}}$

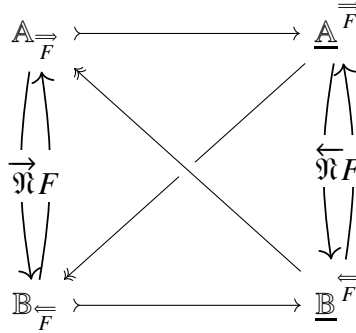

Figure 24: Little nucleus  $\overrightarrow{\mathfrak{N}}F$  defined by factoring simple nucleus  $\overleftarrow{\mathfrak{N}}F$

thus consists of  $\underline{\mathbb{A}}^{\overleftarrow{F}}$ -objects and  $\underline{\mathbb{B}}^{\overleftarrow{F}}$ -morphisms, whereas  $\mathbb{A}_{\overrightarrow{F}}$  is the other way around<sup>5</sup>. Unpacking

<sup>5</sup>A very careful reader may at this point think that we got the notation wrong way around, because  $\mathbb{B}_{\overrightarrow{F}}$  consists of  $\mathbb{B}$ -objects and  $\mathbb{A}$ -morphisms, whereas  $\mathbb{A}_{\overrightarrow{F}}$  consists of  $\mathbb{A}$ -objects and  $\mathbb{B}$ -morphisms. Fig. 25 explains the choice of notation.



the definitions gives:

$$|\mathbb{B}_{\overleftarrow{F}}| = \coprod_{x \in |\underline{\mathbb{A}}|} \left\{ \alpha_x \in \underline{\mathbb{B}}(F^*x, F^*x) \mid \begin{array}{ccccc} F^*x & F_*F^*x & \xrightarrow{\quad} & \twoheadrightarrow & x \\ \downarrow \alpha_x & \searrow \alpha_x & & \searrow F_*\alpha_x & \downarrow \tilde{\alpha}_x \\ F^*x & \xrightarrow{\alpha_x} & F^*x & & F_*F^*x \end{array} \right\} \quad (98)$$

$$\mathbb{B}_{\overleftarrow{F}}(\alpha_x, \gamma_z) = \left\{ g \in \underline{\mathbb{B}}(F^*x, F^*z) \mid \begin{array}{ccc} F_*F^*x & \xrightarrow{F_*g} & F_*F^*z \\ \downarrow F_*\alpha_x & & \downarrow F_*\gamma_z \\ F^*F^*x & \xrightarrow{F_*g} & F^*F^*z \end{array} \right\}$$

$$|\mathbb{A}_{\overrightarrow{F}}| = \coprod_{u \in |\underline{\mathbb{B}}|} \left\{ \beta^u \in \underline{\mathbb{A}}(F_*u, F_*u) \mid \begin{array}{ccccc} F_*x & F^*F_*u & \xrightarrow{\quad} & \twoheadrightarrow & u \\ \downarrow \beta^u & \searrow \beta^u & & \searrow F^*\beta^u & \downarrow \\ F_*u & \xrightarrow{\beta^u} & F_*u & & F^*F_*u \end{array} \right\} \quad (99)$$

$$\mathbb{A}_{\overrightarrow{F}}(\beta^u, \delta^w) = \left\{ f \in \underline{\mathbb{A}}(F_*u, F_*w) \mid \begin{array}{ccc} F^*F_*u & \xrightarrow{F^*f} & F^*F_*w \\ \downarrow F^*\beta^u & & \downarrow F^*\delta^w \\ F_*u & \xrightarrow{F^*f} & F^*F_*w \end{array} \right\}$$

The adjunction  $F^b \dashv F_b : \mathbb{B}_{\overleftarrow{F}} \rightarrow \mathbb{A}_{\overrightarrow{F}}$  is obtained by restricting  $F^b \dashv F_b : \underline{\mathbb{B}}^{\overleftarrow{F}} \rightarrow \underline{\mathbb{A}}^{\overrightarrow{F}}$  along the embeddings  $\mathbb{B}_{\overleftarrow{F}} \hookrightarrow \underline{\mathbb{B}}^{\overleftarrow{F}}$  and  $\mathbb{A}_{\overrightarrow{F}} \hookrightarrow \underline{\mathbb{A}}^{\overrightarrow{F}}$ . Hence the functor

$$\overrightarrow{\mathfrak{N}}(F^* \dashv F_* : \mathbb{B} \rightarrow \mathbb{A}) = (F^b \dashv F_b : \mathbb{B}_{\overleftarrow{F}} \rightarrow \mathbb{A}_{\overrightarrow{F}}) \quad (100)$$

To see that this is an idempotent comonad, in addition to the natural equivalences  $\overrightarrow{\mathfrak{N}}\overrightarrow{\mathfrak{N}}(F) \simeq \overrightarrow{\mathfrak{N}}(F)$  from (97), we need a counit  $\overrightarrow{\mathfrak{N}}(F) \xrightarrow{\varepsilon} F$ . The salient feature of the presentation in (99–98) is that it shows the forgetful functors  $\mathbb{B}_{\overleftarrow{F}} \rightarrow \underline{\mathbb{A}}_{\overleftarrow{F}}$  and  $\mathbb{A}_{\overrightarrow{F}} \rightarrow \underline{\mathbb{B}}_{\overrightarrow{F}}$ , which supplement the equivalences  $\underline{\mathbb{B}}^{\overleftarrow{F}} \simeq \underline{\mathbb{A}}^{\overleftarrow{F}}$  and  $\underline{\mathbb{A}}^{\overrightarrow{F}} \simeq \underline{\mathbb{B}}^{\overrightarrow{F}}$ , proved in Sec. 8.1. Both are used in Fig. 25, relating the counit  $\varepsilon$  of the little nucleus comonad with the unit  $\eta$  of the big nucleus monad. The figure also shows that the counit  $\overrightarrow{\mathfrak{N}}(F) \xrightarrow{\varepsilon} F$  genuinely requires that the adjunction  $F$  is on absolutely complete categories. The little nucleus construction is thus a comonad only for adjunctions over absolutely complete categories.

**Notation.** The subcategories of Adj, Mnd, and Cmn spanned over absolutely complete categories are denoted Adj, Mnd and Cmn.

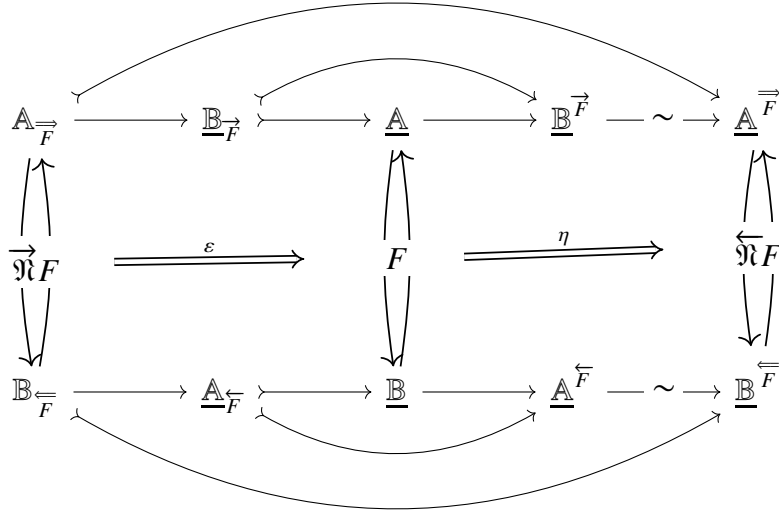

Figure 25: The counit  $\overrightarrow{\mathfrak{N}}F \xrightarrow{\varepsilon} F$  and the unit of  $F \xrightarrow{\eta} \overleftarrow{\mathfrak{N}}F$

**Proposition 9.1** *The little nucleus construction*

$$\overrightarrow{\mathfrak{N}} : \underline{\text{Adj}} \longrightarrow \underline{\text{Adj}} \quad (101)$$

$$(F^* \dashv F_* : \mathbb{B} \rightarrow \mathbb{A}) \longmapsto (F^{\flat} \dashv F_{\flat} : \mathbb{B}_{\overleftarrow{F}} \rightarrow \mathbb{A}_{\overleftarrow{F}}) \quad (102)$$

is an idempotent comonad. An adjunction is subnuclear if and only if it is fixed by this comonad. The category of subnuclear adjunctions

$$\text{Luc} = \left\{ F \in \underline{\text{Adj}} \mid \overrightarrow{\mathfrak{N}}(F) \stackrel{\varepsilon}{\cong} F \right\} \quad (103)$$

is equivalent to the category of nuclear adjunctions:

$$\text{Luc} \simeq \text{Nuc}$$

**Proof.** The only claim of the Proposition that was not proved before the statement is the equivalence  $\text{Luc} \simeq \text{Nuc}$ . The functor  $\text{Luc} \rightarrow \text{Nuc}$  can be realized by restricting  $\overleftarrow{\mathfrak{N}}$  from  $\underline{\text{Adj}}$  to  $\text{Luc} \subset \underline{\text{Adj}} \subset \text{Adj}$ . The functor  $\text{Nuc} \rightarrow \text{Luc}$  can be realized by restricting  $\overrightarrow{\mathfrak{N}}$  from  $\underline{\text{Adj}}$  to  $\text{Nuc} \subset \underline{\text{Adj}} \subset \text{Adj}$ . We note that both  $\text{Luc}$  and  $\text{Nuc}$  are contained in  $\underline{\text{Adj}}$  by definition, but for different reasons: whereas  $\overrightarrow{\mathfrak{N}}$  is only defined on  $\underline{\text{Adj}}$ ,  $\overleftarrow{\mathfrak{N}}$  is defined on  $\text{Adj}$ , but all of its images land in  $\underline{\text{Adj}}$ . The idempotency of both restrictions implies that they form an equivalence.  $\square$

**Theorem 9.2** The comonads  $\overrightarrow{\mathfrak{M}} : \underline{\mathbf{Mnd}} \rightarrow \underline{\mathbf{Mnd}}$  and  $\overleftarrow{\mathfrak{C}} : \underline{\mathbf{Cmn}} \rightarrow \underline{\mathbf{Cmn}}$ , defined

$$\overrightarrow{\mathfrak{M}}(\overleftarrow{T}) = \text{AM} \circ \text{KC} \circ \text{AC} \circ \text{EM}(\overleftarrow{T}) \quad (104)$$

$$\overleftarrow{\mathfrak{C}}(\overrightarrow{T}) = \text{AC} \circ \text{KM} \circ \text{AM} \circ \text{EC}(\overrightarrow{T}) \quad (105)$$

are idempotent. Iterating them leads to the natural equivalences

$$\overrightarrow{\mathfrak{M}} \circ \overrightarrow{\mathfrak{M}} \simeq \overrightarrow{\mathfrak{M}} \quad \overleftarrow{\mathfrak{C}} \circ \overleftarrow{\mathfrak{C}} \simeq \overleftarrow{\mathfrak{C}}$$

Moreover, their categories of coalgebras are equivalent:

$$\underline{\mathbf{Cmn}}^{\overrightarrow{\mathfrak{M}}} \simeq \text{Luc} \simeq \underline{\mathbf{Mnd}}^{\overleftarrow{\mathfrak{C}}} \quad (106)$$

with Luc as defined in (103), and

$$\underline{\mathbf{Cmn}}^{\overleftarrow{\mathfrak{C}}} = \left\{ \overrightarrow{F} \in \underline{\mathbf{Cmn}} \mid \overleftarrow{\mathfrak{C}}(\overrightarrow{F}) \simeq \overrightarrow{F} \right\} \quad (107)$$

$$\underline{\mathbf{Mnd}}^{\overrightarrow{\mathfrak{M}}} = \left\{ \overleftarrow{F} \in \underline{\mathbf{Mnd}} \mid \overrightarrow{\mathfrak{M}}(\overleftarrow{F}) \simeq \overleftarrow{F} \right\} \quad (108)$$

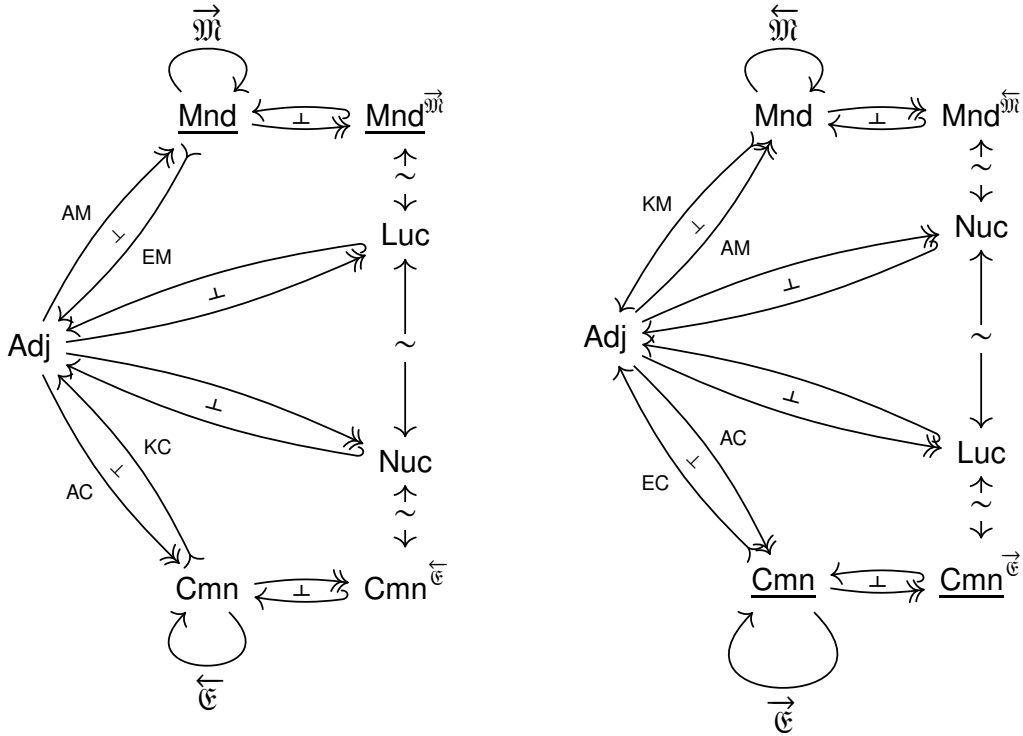

Figure 26: Relating little and big nuclei

The **proof** boils down to straightforward verifications with the simple nucleus formats. Fig. 26 summarizes and aligns the claims of Theorems 6 and 9.2.

## 10 Example 0: The Kan adjunction

Our final example of a nucleus arises from the first example of a categorical adjunction. The idea of adjunction goes back at least to Évariste Galois, or, depending on how you think of it, as far back as to Heraclitus [58], and into the roots of logic [61]. Yet the categorical definition of an adjunction as two categories, two functors, and two natural transformations goes back to the late 1950s, to Daniel Kan's work in homotopy theory [47]. Kan defined the Kan extensions to capture a particular adjunction, perhaps like Eilenberg and MacLane defined categories and functors to define certain natural transformations.

### 10.1 Simplices and the simplex category

One of the seminal ideas of algebraic topology arose from Eilenberg's computations of homology groups of topological spaces by decomposing them into simplices [25]. An  $m$ -simplex is the set

$$\Delta_{[m]} = \left\{ \vec{x} \in [0, 1]^{m+1} \mid \sum_{i=0}^m x_i = 1 \right\} \quad (109)$$

with the product topology induced by the open intervals on  $[0, 1]$ . The relevant structure of a topological space  $X$  is captured by families of continuous maps  $\Delta_m \rightarrow X$ , for all  $m \in \mathbb{N}$ . Some such maps do not *embed* simplices into a space, like triangulations do, but contain degeneracies, or singularities. Nevertheless, considering the entire family of such maps to  $X$  makes sure that any simplices that can be embedded into  $X$  will be embedded by some of them. Since the simplicial structure is captured by each  $\Delta_{[m]}$ 's projections onto all  $\Delta_{[\ell]}$ s for  $\ell < m$ , and by  $\Delta_{[m]}$ 's embeddings into all  $\Delta_{[n]}$ s for  $n > m$ , a coherent simplicial structure corresponds to a functor of the form  $\Delta_{[-]} : \Delta \rightarrow \mathbf{Esp}$ , where  $\mathbf{Esp}$  is the category of topological spaces and continuous maps<sup>6</sup>, and  $\Delta$  is the simplex category. Its objects are finite ordinals

$$[m] = \{0 < 1 < 2 < \dots < m\}$$

while its morphisms are the order-preserving functions [29]. All information about the simplicial structure of topological spaces is thus captured in the matrix

$$\begin{aligned} \Upsilon : \Delta^o \times \mathbf{Esp} &\rightarrow \mathbf{Set} \\ [m] \times X &\mapsto \mathbf{Esp}(\Delta_{[m]}, X) \end{aligned} \quad (110)$$

This is, in a sense, the "*context matrix*" of homotopy theory, if it were to be translated to the language of Sec. 2, and construed as a geometric "*concept analysis*".

---

<sup>6</sup>We denote the category of topological spaces by the abbreviation  $\mathbf{Esp}$  of the French word *espace*, not just because there are other things called  $\mathbf{Top}$  in the same contexts, but also as authors' reminder-to-self of the tacit sources of the approach [38, 3].

## 10.2 Kan adjunctions and extensions

Daniel Kan's work was mainly concerned with computing homotopy groups in combinatorial terms [48]. That led to the discovery of categorical adjunctions as a tool for Kan's extensions of the simplicial approach [47]. Applying the toolkit from Sec. 5.2, the matrix  $\Upsilon$  from (110) gives rise to the following functors

$$\begin{array}{c} \Upsilon: \Delta^o \times \text{Esp} \rightarrow \text{Set} \\ \hline \Upsilon_\bullet: \Delta \rightarrow \uparrow\text{Esp} \qquad \bullet\Upsilon: \text{Esp} \rightarrow \downarrow\Delta \\ \hline \Upsilon^*: \downarrow\Delta \rightarrow \uparrow\text{Esp} \qquad \Upsilon_*: \uparrow\text{Esp} \rightarrow \downarrow\Delta \end{array} \quad (111)$$

where

- $\downarrow\Delta = \text{Dfib}/\Delta \simeq \text{Set}^{\Delta^o}$  is the category of simplicial sets  $K: \Delta^o \rightarrow \text{Set}$ , or equivalently of complexes  $\int K: \{K\} \rightarrow \Delta$ , comprehended along the lines of Sec. 5.2.1;
- $\uparrow\text{Esp} = (\text{Ofib}/\text{Esp})^o$  is the opposite category of discrete opfibrations over  $\text{Esp}$ , i.e. of functors  $\mathcal{D} \xrightarrow{D} \text{Esp}$  which establish isomorphisms between the coslices  $x/\mathcal{D} \cong Dx/\text{Esp}$ .

The Yoneda embedding  $\Delta \xrightarrow{\blacktriangledown} \downarrow\Delta$  makes  $\downarrow\Delta$  into a colimit-completion of  $\Delta$ , and induces the extension  $\Upsilon^*: \downarrow\Delta \rightarrow \uparrow\text{Esp}$  of  $\Upsilon_\bullet: \Delta \rightarrow \uparrow\text{Esp}$ . The Yoneda embedding  $\text{Esp} \xrightarrow{\blacktriangle} \uparrow\text{Esp}$  makes  $\uparrow\text{Esp}$  into a limit-completion of  $\text{Esp}$ , and induces the extension  $\Upsilon_*: \uparrow\text{Esp} \rightarrow \downarrow\Delta$  of  $\bullet\Upsilon: \text{Esp} \rightarrow \downarrow\Delta$ .

However,  $\text{Esp}$  is a large category, and the category  $\uparrow\text{Esp}$  lives in another universe. Moreover,  $\text{Esp}$  already has limits, and completing it to  $\uparrow\text{Esp}$  obliterates them, and adjoins the formal ones. Kan's original extension was defined using the original limits in  $\text{Esp}$ , and there was no need to form  $\uparrow\text{Esp}$ . Using the standard notation  $\text{sSet}$  for simplicial sets  $\text{Set}^{\Delta^o}$ , or equivalently for complexes  $\downarrow\Delta$ , Kan's original adjunction boils down to

$$\begin{array}{ccc} \mathbb{K} \xrightarrow{K} \Delta & \text{sSet} & \left( \Delta_{[-1]}/X \xrightarrow{\text{Dom}} \Delta \right) \\ \downarrow & \left( \Upsilon^* \dashv \Upsilon_* \right) & \uparrow \\ \varinjlim \left( \mathbb{K} \xrightarrow{K} \Delta \xrightarrow{\Delta_{[-1]}} \text{Esp} \right) & \text{Esp} & X \end{array} \quad (112)$$

where

- $\Upsilon_\bullet = \left( \Delta \xrightarrow{\Delta_{[-1]}} \text{Esp} \xrightarrow{\blacktriangle} \uparrow\text{Esp} \right)$ , is truncated to  $\Delta \xrightarrow{\Delta_{[-1]}} \text{Esp}$ ;
- $\bullet\Upsilon: \uparrow\text{Esp} \rightarrow \downarrow\Delta$  from (65), restricted to  $\text{Esp}$  leads to

$$\varprojlim \left( 1 \xrightarrow{X} \text{Esp} \xrightarrow{\bullet\Upsilon} \text{Dfib}/\Delta \right) = \left( \Delta_{[-1]}/X \xrightarrow{\text{Dom}} \Delta \right)$$

The adjunction  $\text{MA}(\Upsilon) = (\Upsilon^* \dashv \Upsilon_* : \text{Esp} \rightarrow \text{sSet})$ , displayed in (112), has been studied for many years. The functor  $\Upsilon^* : \text{sSet} \rightarrow \text{Esp}$  is usually called the geometric realization [71], whereas  $\Upsilon_* : \text{Esp} \rightarrow \text{sSet}$  is the singular decomposition on which Eilenberg's singular homology was based [25]. Kan spelled out the concept of adjunction from the relationship between these two functors [47, 49].

The overall idea of the approach to homotopies through adjunctions was that recognizing this abstract relationship between  $\Upsilon^*$  and  $\Upsilon_*$  should provide a general method for transferring the invariants of interest between a geometric and an algebraic or combinatorial category. For a geometric realization  $\Upsilon^*K \in \text{Esp}$  of a complex  $K \in \text{sSet}$ , the homotopy groups can be computed in purely combinatorial terms, from the structure of  $K$  alone [48]. Indeed, the spaces in the form  $\Upsilon^*K$  boil down to Whitehead's CW-complexes [71, 92]. What about the spaces that do not happen to be in this form?

### 10.3 Troubles with localizations

The upshot of Kan's adjunction  $\Upsilon^* \dashv \Upsilon_* : \text{Esp} \rightarrow \text{sSet}$  is that for any space  $X$ , we can construct a CW-complex  $\overrightarrow{\Upsilon}X = \Upsilon^*\Upsilon_*X$ , with a continuous map  $\overrightarrow{\Upsilon}X \xrightarrow{\varepsilon} X$ , that arises as the counit of Kan's adjunction. In a formal sense, this counit is the best approximation of  $X$  by a CW-complex. When do such approximations preserve the geometric invariants of interest? By the late 1950s, it was already known that such combinatorial approximations work in many special cases, certainly whenever  $\varepsilon$  is invertible. But in general, even  $\overrightarrow{\Upsilon}\overrightarrow{\Upsilon}X \xrightarrow{\varepsilon} \overrightarrow{\Upsilon}X$  is not always invertible. The idea of approximating topological spaces by combinatorial complexes thus grew into a quest for making the units or the counits of adjunctions invertible. Which spaces have the same invariants as the geometric realizations of their singular<sup>7</sup> decompositions? For particular invariants, there are direct answers [26, 27]. In general, though, localizing at suitable spaces along suitable reflections or coreflections aligns (111) with (18) and algebraic topology can be construed as a geometric extension of concept analysis from Sec. 2, extracting concept nuclei from context matrices as the invariants of adjunctions that they induce. Some of the most influential methods of algebraic topology can be interpreted in this way. Grossly oversimplifying, we mention three approaches.

The direct approach [31, 16, Vol. I, Ch. 5] was to enlarge the given category by formal inverses of a family of arrows, usually called weak equivalences, and denoted by  $\Sigma$ . The elements of  $\Sigma$  are thus made invertible in a category of fractions just like the non-zero integers are made invertible in the field of rationals. Applying this categorical calculus of fractions to a large category like  $\mathbf{E}$  usually involves proper classes of arrows, and the resulting category of fractions often has large hom-sets.

Another approach [23, 86] is to factor out the  $\Sigma$ -arrows using two factorization systems. This approach is similar to the constructions outlined in Sections 3 and 4.5.3, but the factorizations of continuous maps that arise in this framework are not unique: they comprise families of fibrations and cofibrations, which are orthogonal by lifting and descent, thus only weakly. Abstract homotopy

---

<sup>7</sup>The word "singular" here means that the simplices, into which space may be decomposed, do not have to be embedded into it, which would make the decomposition *regular*, but that the continuous maps from their geometric realizations may have *singularities*.

models in categories thus lead to pairs of *weak* factorization systems. Sticking with the notation  $\mathcal{E}^\bullet \wr \mathcal{M}$  and  $\mathcal{E} \wr \mathcal{M}^\bullet$  for such weak factorization systems, the idea is thus that the family  $\Sigma$  is now generated by composing the elements of  $\mathcal{E}^\bullet$  and  $\mathcal{M}^\bullet$ . Localizing at the arrows from  $\mathcal{E} \cap \mathcal{M}$ , that are orthogonal to both  $\mathcal{M}^\bullet$  and  $\mathcal{E}^\bullet$ , makes  $\Sigma$  invertible. It turns out that suitable factorizations can be found both in  $\mathbf{Esp}$  and in  $\mathbf{sSet}$ , to make the adjunction between spaces and complexes into an equivalence. This was Dan Quillen's approach [85, 86].

The third approach [1, 2] tackles the task of making the arrows  $\vec{\Upsilon}X \xrightarrow{\varepsilon} X$  invertible by modifying the comonad  $\vec{\Upsilon}$  until it becomes idempotent and then localizing at the coalgebras of this idempotent comonad. Note that this approach does not tamper with the continuous maps in  $\mathbf{Esp}$ , be it to make some of them formally invertible, or to factor them out. The idea is that an idempotent comonad, call it  $\vec{\Upsilon}_\infty : \mathbf{Esp} \rightarrow \mathbf{Esp}$ , should localize any space  $X$  at a space  $\vec{\Upsilon}_\infty X$  such that  $\vec{\Upsilon}_\infty \vec{\Upsilon}_\infty X \cong \vec{\Upsilon}_\infty X$ . That means that  $\Upsilon_\infty$  is an idempotent monad. The quest for such a monad is illustrated in Fig. 27.  $\mathbf{Esp}^{\vec{\Upsilon}}$  denotes the category of coalgebras for the comonad  $\vec{\Upsilon} = \Upsilon^* \Upsilon_*$ , the

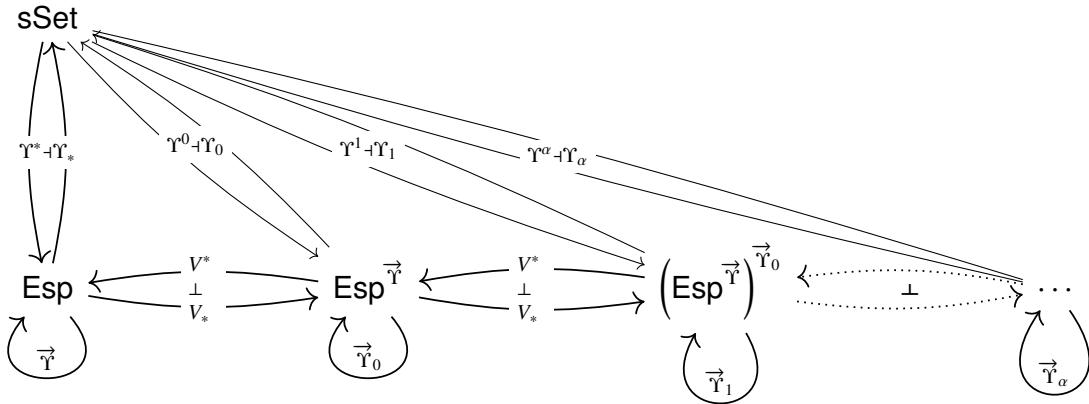

Figure 27: Iterating the comonad resolutions for  $\vec{\Upsilon}$

adjunction  $V^* \dashv V_* : \mathbf{Esp} \rightarrow \mathbf{Esp}^{\vec{\Upsilon}}$  is the final resolution of this comonad, and  $\Upsilon^0$  is the couniversal comparison functor into this resolution mapping a complex  $K$  to the coalgebra  $\Upsilon^* K \xrightarrow{\eta^*} \Upsilon^* \Upsilon_* \Upsilon^* K$ . Since  $\mathbf{sSet}$  is a complete category,  $\Upsilon^0$  has a right adjoint  $\Upsilon_0$ , and they induce the comonad  $\vec{\Upsilon}_0$  on  $\mathbf{Esp}^{\vec{\Upsilon}}$ . If  $\vec{\Upsilon}$  was idempotent, then the final resolution  $V^* \dashv V_*$  would be a coreflection, and the comonad  $\vec{\Upsilon}_0$  would be (isomorphic to) the identity. But  $\vec{\Upsilon}$  is not idempotent, and the construction can be applied to  $\vec{\Upsilon}_0$  again, leading to  $(\mathbf{Esp}^{\vec{\Upsilon}})^{\vec{\Upsilon}_0}$ , with the final resolution generically denoted  $V^* \dashv V_* : \mathbf{Esp}^{\vec{\Upsilon}} \rightarrow (\mathbf{Esp}^{\vec{\Upsilon}})^{\vec{\Upsilon}_0}$ , and the comonad  $\vec{\Upsilon}_1$  on  $(\mathbf{Esp}^{\vec{\Upsilon}})^{\vec{\Upsilon}_0}$ . Remarkably, Applegate and Tierney [1] found that the process needs to be repeated *transfinitely* before the idempotent monad  $\vec{\Upsilon}_\infty$  is reached. At each step, some parts of a space that are not combinatorially approximable are

eliminated, but that causes some other parts, that were previously approximable, to cease being so. And this may still be the case after infinitely many steps. A transfinite induction becomes necessary. The situation is similar to Cantor's quest for accumulation points of the convergence domains of Fourier series, which led him to discover transfinite induction in the first place.

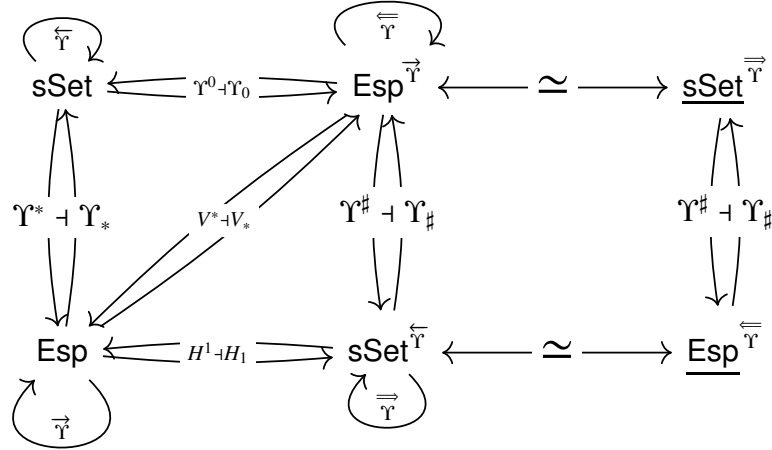

Figure 28: The nucleus of the Kan adjunction

The nucleus of the same adjunction is displayed in Fig. 28. The category  $\text{Esp}^{\overrightarrow{\Upsilon}}$  comprises spaces that may not be homeomorphic with a geometric realization of a complex, but are their retracts, projected along the counit  $\overrightarrow{\Upsilon}X \xrightarrow{\varepsilon} X$ , and included along the structure coalgebra  $X \rightarrow \overrightarrow{\Upsilon}X$ . But the projection does not preserve simplicial decompositions; i.e., it is not an  $\overrightarrow{\Upsilon}$ -coalgebra homomorphism. The transfinite construction of the idempotent monad  $\overrightarrow{\Upsilon}_\infty$  was thus needed to extract just those spaces where the projection boils down to a homeomorphism. But Prop. 8.1 implies that simplicial decompositions of spaces in  $\text{Esp}^{\overrightarrow{\Upsilon}}$  can be equivalently viewed as objects of the simple nucleus category  $\underline{\text{sSet}}^{\overline{\overrightarrow{\Upsilon}}}$ . Any space  $X$  decomposed along a coalgebra  $X \rightarrow \overrightarrow{\Upsilon}X$  in  $\text{Esp}^{\overrightarrow{\Upsilon}}$  can be equivalently viewed in  $\underline{\text{sSet}}^{\overline{\overrightarrow{\Upsilon}}}$  as a complex  $K$  with an idempotent  $\Upsilon^*K \xrightarrow{\varphi} \Upsilon^*K$ . This idempotent secretly splits on  $X$ , but the category  $\underline{\text{sSet}}^{\overline{\overrightarrow{\Upsilon}}}$  does not know that. It does know that the object  $\varphi_K = \langle K, \Upsilon^*K \xrightarrow{\varphi} \Upsilon^*K \rangle$  is a retract of  $\overrightarrow{\Upsilon}\varphi_K$ ; and  $\overrightarrow{\Upsilon}\varphi_K$  secretly splits on  $\overrightarrow{\Upsilon}X$ . The space  $X$  is thus represented in the category  $\underline{\text{sSet}}^{\overline{\overrightarrow{\Upsilon}}}$  by the idempotent  $\varphi_K$ , which is a retract of  $\overrightarrow{\Upsilon}\varphi_K$ , representing  $\overrightarrow{\Upsilon}X$ . Simplicial decompositions of spaces along coalgebras in  $\text{Esp}^{\overrightarrow{\Upsilon}}$  can thus be equivalently captured as idempotents over simplicial sets within the simple nucleus category  $\underline{\text{sSet}}^{\overline{\overrightarrow{\Upsilon}}}$ . The idempotency of the nucleus construction can be interpreted as a suitable completeness claim for such representations.

**To be continued.** How is it possible that  $X$  is not a retract of  $\overrightarrow{\Upsilon}X$  in  $\text{Esp}^{\overrightarrow{\Upsilon}}$ , but the object  $\varphi_K$ , representing  $X$  in the equivalent category  $\underline{\text{sSet}}^{\overline{\overrightarrow{\Upsilon}}}$ , is recognized as a retract of the object  $\overrightarrow{\Upsilon}\varphi_K$ ,



representing  $\vec{\Upsilon}X$ ? The answer is that the retractions occur at different levels of the representation. Recall, first of all, that  $\underline{\text{sSet}}^{\vec{\Upsilon}}$  is a simplified form of  $(\text{sSet}^{\overleftarrow{\Upsilon}})^{\vec{\Upsilon}}$ . The reader familiar with Beck's Theorem, this time applied to comonadicity, will remember that  $X$  can be extracted from  $\vec{\Upsilon}X$  using an equalizer that splits in  $\text{Esp}$ , when projected along a forgetful functor  $V^* : \text{Esp}^{\vec{\Upsilon}} \rightarrow \text{Esp}$ . This split equalizer in  $\text{Esp}$  lifts back along the comonadic  $V^*$  to an equalizer in  $\text{Esp}^{\vec{\Upsilon}}$ , which is generally not split. On the other hand, the splitting of this equalizer occurs in  $(\text{sSet}^{\overleftarrow{\Upsilon}})^{\vec{\Upsilon}}$  as the algebra carrying the corresponding coalgebra. In  $\underline{\text{sSet}}^{\vec{\Upsilon}}$ , this splitting is captured as the idempotent that it induces. We have shown, of course, that all three categories are equivalent. But  $\underline{\text{sSet}}^{\vec{\Upsilon}}$  internalizes the absolute limits that get reflected along the forgetful functor  $V^*$ . It makes them explicit, and available for computations. But they have to be left for after the break.

## 11 What?

### 11.1 What we did

We studied the nuclear adjunctions. To garner intuition, we considered some examples. The chosen examples reflect the fact that the presented general approach to the nucleus construction was driven by particular applications in data analysis. Since every adjunction has a nucleus, reader's favorite adjunctions will provide further examples, and further applications that may be of greater interest. Our crucial application is presented in [82]. Many variations on the same theme have been presented elsewhere [50, 78, 79, 80, 83, 91, 93]. Last but not least, the nucleus construction itself also is an example of itself, as it provides the nuclei of the adjunctions between monads and comonads, which induce the Street monads on monads and on comonads [89, Sec. 4].

### 11.2 What we did not do

We studied adjunctions, monads, and comonads in terms of adjunctions, monads, and comonads. We took category theory as a language and analyzed it in that same language. We preached what we practice. There is, of course, nothing unusual about that. There are many papers about the English language that are written in English. But self-applications of category theory do tend to get complicated. They sometimes cause chain reactions. Categories and functors form a category, but natural transformations make them into a 2-category. 2-categories form a 3-category, 3-categories a 4-category, and so on. Unexpected things start to happen already at level 3 [35, 40]. Strictly speaking, the theory of categories is not a part of category theory, but of *higher* category theory [6, 66, 67, 88]. Grothendieck's *homotopy hypothesis* [39, 69] made higher category theory into an expansive geometric pursuit, subsuming homotopy theory. While most theories grow to be simpler as they solve their problems, and the dimensionality reduction is one of the main tenets of statistics, machine learning, and data analysis, higher category theory has made the route through

higher dimensions into a principle of the method. This opens up the realm of applications in modern physics but presents a challenge for the language of modern mathematics.

Category theory reintroduced diagrams and geometric interactions as first-class citizens of the mathematical discourse, after several centuries of the prevalence of algebraic prose, driven by the facility of printing. Categories were invented to dam the flood of structure in algebraic topology, but they also geometrized algebra. In some areas, though, they produced their own flood of structure. Since the diagrams in higher categories are of higher dimensions, and the compositions are not mere sequences of arrows, diagram chasing became a problem. While it is naturally extended into cell pasting by filling 2-cells into commutative polygons, diagram pasting does not boil down to a directed form of diagram chasing, as one would hope. The reason is that 1-cell composition does not extend into 2-cell composition freely, but modulo the *middle-two interchange* law (a.k.a. *Godement's naturality* law). A 2-cell can thus have many geometrically different representatives. This factoring is easier to visualize using string diagrams, which are the Poincaré duals of the pasting diagrams. The duality maps 2-cells into vertices, and 0-cells into faces of string diagrams. Chasing 2-categorical string diagrams is thus a map-coloring activity.

In earlier versions of this paper, the nucleus was presented as a 2-categorical construction. We spent several years validating some of the results at that level of generality, drawing string diagrams as colored maps to make them communicable. Introducing a new idea in a new language requires bootstrapping. We know from programming that bootstrapping is possible when the boots are built and strapped, but not before that. At least in our early presentations, the concept of nucleus and its 2-categorical context gave rise to two new narratives. This paper became possible when we separated them, and factored out the 2-categorical view of the nucleus for the sake of first presenting the categorical view.

### 11.3 What remains to be done

In view of Sec. 10, a higher categorical analysis of the nucleus construction seems to be important and interesting. The standard reference for the 2-categories of monads and comonads is [89], extended in [56]. The adjunction morphisms were introduced in [4]. Their 1-cells, which we sketch in the Appendix, are the lax versions of the morphisms we use in Sec. 5. The 2-cells are easy to derive from the structure preservation requirement, though less easy to draw, and often even more laborious to read. Understanding is a process that unfolds at many levels. The language of categories facilitates understanding by its flexibility, but it can also obscure its subject when imposed rigidly. The quest for categorical methods of geometry has grown into a quest for geometric methods of category theory. There is a burgeoning new scene of diagrammatic tools [19, 41]. If pictures help us understand categories, then categories will help us to speak in pictures, and the nuclear methods will help us mine concepts as invariants.

### 11.4 What are categories and what are their model structures?

Category theory is many things to many people, but the one thing that they share is that they treat their objects as black boxes, with the morphisms as the input and the output interfaces. If the same discipline is applied to categories themselves, then they should also be viewed as black boxes,

with the functors as the input and the output interfaces. But a functor is specified as a mapping on objects, and a family of mappings on the morphisms. The decomposition into the black-box objects and their interfaces persists. Any functor  $G : \mathbb{A} \rightarrow \mathbb{B}$  can be factorized<sup>8</sup> into a surjection on the objects and an injection on the arrows, as displayed in Fig. 29, through a category  $\mathbb{A}_G$ , with the objects of  $\mathbb{A}$  and the arrows of  $\mathbb{B}$ . The orthogonality of the essentially surjective functors  $E \in \text{Ess}$



Figure 29: Factoring of an arbitrary functor  $G$  through  $(\text{Ess} \wr \text{Ffa})$

and full-and-faithful functors  $M \in \text{Ffa}$ , is displayed in Fig. 30. Since  $E$  is essentially surjective, for any object  $y$  in  $\mathbb{B}$  there is some  $x$  in  $\mathbb{A}$  such that  $Ex \cong y$ , so we take  $Hy = Ux$ . If  $Ex' \cong y$  also holds for some other  $x'$  in  $\mathbb{A}$  then  $MUx \cong VEx \cong Vy \cong VEx' \cong MUx'$  implies  $Ux \cong Ux'$ , because  $M$  is full-and-faithful. The arrow part is defined using the bijections between the hom-sets provided by  $M$ . The factorization system  $(\text{Ess} \wr \text{Ffa})$  can be used as a stepping stone into category theory. It confirms that functors see categories as comprised of objects and arrows.

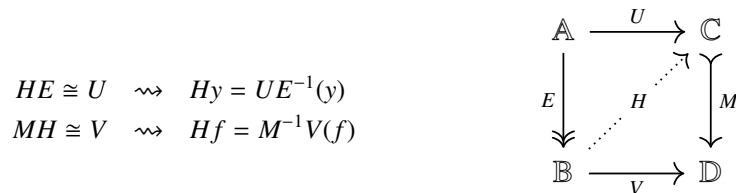

Figure 30: The orthogonality of an essential surjection  $E \in \text{Ess}$  and a full-and-faithful  $M \in \text{Ffa}$

**Functors are not the only available morphisms between categories.** Many mathematical theories study objects that are instances of categories, but require morphisms for which the functoriality is not enough. E.g., a topology is a lattice of open sets, and a lattice is, of course, a special kind of category. A continuous map between two topological spaces is an adjunction between the lattices of opens: the requirement that the inverse image of a continuous map preserves the unions of the opens means that it has a right adjoint. The general functors between topologies, i.e. merely monotone maps between the lattices of opens, are seldom studied because they do not capture continuity, which is the subject of topology. For an even more general example, consider basic set theory. Functions are defined as total and single-valued relations. A total and single-valued relation between two sets is an adjunction between the two lattices of subsets: the totality is the

<sup>8</sup>Appendix A provides an overview of factorization systems.

unit of the adjunction, and the single-valuedness is the counit [76]. A general relation induces a monotone map, i.e. a functor between the lattices of subsets. But studying functions means studying adjunctions. There are many mathematical theories where the objects of study are categories of some sort, and the morphisms between them are adjunctions.

**What are categories in terms of adjunctions?** We saw in Sec. 4.6 that applying the factorization system  $(\text{Ess} \wr \text{Ffa})$  to a pair of adjoint functors gives rise to the two initial resolutions of the adjunction: the (Kleisli) categories of free algebras and coalgebras. Completing them to the final resolutions lifts Fig. 29 to Fig. 31. This lifting is yet another perspective on the equivalences

$$\begin{array}{ccc}
 \begin{array}{l}
 |\underline{\mathbb{A}}^{\overline{F}}| = \coprod_{x \in |\mathbb{A}|} \{F^*x \xrightarrow{\alpha_x} F_*x \mid (89)\} \\
 \underline{\mathbb{A}}^{\overline{F}}(\alpha_x, \gamma_z) = \underline{\mathbb{B}}^{\overline{F}}(R^*\alpha_x, R^*\gamma_z)
 \end{array} &
 \begin{array}{c}
 \begin{array}{ccc}
 \underline{\mathbb{A}}^{\overline{F}} & \xleftarrow{C^\bullet(F)} & \mathbb{A} \\
 \downarrow \mathcal{F}(F) & \nearrow F^* & \downarrow C(F) \\
 \mathbb{B} & \dashv & \mathbb{B} \\
 \downarrow \mathcal{F}^\bullet(F) & & \downarrow \\
 \underline{\mathbb{B}}^{\overline{F}} & & \mathbb{B}
 \end{array}
 \end{array} &
 \begin{array}{l}
 |\underline{\mathbb{B}}^{\overline{F}}| = \coprod_{u \in |\mathbb{B}|} \{F_*u \xrightarrow{\beta^u} F_*u \mid (90)\} \\
 \underline{\mathbb{B}}^{\overline{F}}(\beta^u, \delta^w) = \underline{\mathbb{A}}^{\overline{F}}(L_*\beta^u, L_*\delta^w)
 \end{array}
 \end{array}$$

Figure 31: Factoring the adjunction  $F = (F^* \dashv F_*)$  through  $(C^\bullet \wr \mathcal{F})$  and  $(C \wr \mathcal{F}^\bullet)$

$R^* : \underline{\mathbb{A}}^{\overline{F}} \rightarrow \underline{\mathbb{B}}^{\overline{F}}$  and  $L_* : \underline{\mathbb{B}}^{\overline{F}} \rightarrow \underline{\mathbb{A}}^{\overline{F}}$  from Sec. 8 and [83, Theorems III.2 and III.3]. Note that the adjunctions are here viewed as morphisms in the direction of their lefth-hand component (like functions, and unlike the continuous maps). But the functors  $C(F)$  and  $\mathcal{F}^\bullet(F)$  in Fig. 31, as components of a right adjoint, are displayed in the opposite direction. That is why the  $C$ -component is drawn with a tail, although in the context of left-handed adjunctions it plays the role of an abstract epi. The weak factorization systems  $(C^\bullet \wr \mathcal{F})$  and  $(C \wr \mathcal{F}^\bullet)$  are comprised of the families

- $\sim \mathcal{F} = \{(F^* \dashv F_*) \mid F^* \text{ is comonadic}\},$
- $\sim C^\bullet = \{(F^* \dashv F_*) \mid F^* \text{ is a comparison functor for a comonad}\},$
- $\sim C = \{(F^* \dashv F_*) \mid F_* \text{ is monadic}\},$
- $\sim \mathcal{F}^\bullet = \{(F^* \dashv F_*) \mid F_* \text{ is a comparison functor for a monad}\}.$

To see how these factorizations are related with  $(\text{Ess} \wr \text{Ffa})$ , and how Fig. 31 arises from Fig. 29, recall from Sec. 4.6 that the  $(\text{Ess} \wr \text{Ffa})$ -decomposition of  $F^*$  gives the initial resolution  $\underline{\mathbb{A}}_{\overline{F}}$ , whereas the  $(\text{Ess} \wr \text{Ffa})$ -decomposition of  $F_*$  gives the initial resolution  $\underline{\mathbb{B}}_{\overline{F}}$ . However,  $\underline{\mathbb{A}}_{\overline{F}} \hookrightarrow \underline{\mathbb{A}}^{\overline{F}} \simeq \underline{\mathbb{B}}^{\overline{F}}$  factors through the  $(C \wr \mathcal{F}^\bullet)$ -decomposition of  $F_*$ , whereas  $\underline{\mathbb{B}}_{\overline{F}} \hookrightarrow \underline{\mathbb{B}}^{\overline{F}} \simeq \underline{\mathbb{A}}^{\overline{F}}$  factors through the  $(C^\bullet \wr \mathcal{F})$ -decomposition of  $F^*$ . In particular, while

- a) the  $\text{Ess}$ -image  $\underline{\mathbb{A}}_{\overline{F}}$  of  $\mathbb{A}$  in  $\mathbb{B}$  along  $F^*$  is spanned by isomorphisms in the form  $y \cong F^*x$ ,

b) the  $\mathcal{C}^\bullet$ -image  $\underline{\mathbb{A}}^{\overrightarrow{F}}$  of  $\mathbb{A}$  in  $\mathbb{B}$  along  $F^*$  is spanned by retractions in the form  $y \xrightarrow{\leftarrow} F^*x$ .

We have seen in Sec. 8 that such retractions correspond to  $\overrightarrow{F}$ -coalgebras. The correspondence between the two is the equivalence  $R^*: \underline{\mathbb{A}}^{\overrightarrow{F}} \simeq \mathbb{B}^{\overrightarrow{F}}$ . Looking at the  $(\mathcal{C}^\bullet \wr \mathcal{F})$ -decompositions from the two sides of this equivalence aligns the orthogonality of  $\mathcal{C}^\bullet$  and  $\mathcal{F}$  with the orthogonality of  $\text{Ess}$  and  $\text{Ffa}$ , as indicated in Fig. 32. Since any object  $\alpha_x$  of  $\underline{\mathbb{A}}^{\overrightarrow{F}}$  induces a retraction  $\overleftarrow{F}x \xrightarrow{\tilde{\alpha}_x} x \xrightarrow{\alpha_x} \overleftarrow{F}x$ ,

$$\begin{array}{l}
 HE \cong U \quad \rightsquigarrow \quad H\alpha_x = \left( V\alpha_x \xrightarrow[V\alpha^x]{V\tilde{\alpha}_x} VEx \cong MUx \right) \\
 MH \cong V \quad \rightsquigarrow \quad Hf = V(f)
 \end{array}
 \qquad
 \begin{array}{ccc}
 \mathbb{A} & \xrightarrow{U} & \mathbb{D}^{\overrightarrow{G}} \\
 E \downarrow & \nearrow H & \downarrow M \\
 \underline{\mathbb{A}}^{\overrightarrow{F}} & \xrightarrow{V} & \mathbb{D}
 \end{array}$$

Figure 32: The orthogonality of a comparison functor  $E \in \mathcal{C}^\bullet$  and a comonadic  $M \in \mathcal{F}$

and the comparison functor  $E$  maps  $x$  to  $Ex = \left\langle \overleftarrow{F}x, F^*\overleftarrow{F}x \xrightarrow{\varepsilon_{F^*}} F^*x \xrightarrow{F^*\eta} F^*\overleftarrow{F}x \right\rangle$ , the image  $V\alpha_x$  splits into  $VEx \xrightarrow{V\tilde{\alpha}_x} V\alpha_x \xrightarrow{V\alpha^x} VEx$ . But the isomorphism  $VEx \cong MUx$  and the comonadicity of  $M$  imply that the  $M$ -split equalizer  $V\alpha_x \xrightarrow{V\alpha^x} VEx \cong MUx$  lifts to  $\mathbb{D}^{\overrightarrow{G}}$ . This lifting determines  $H\alpha_x$ . The conservativity of  $M$  assures that  $H$  is well-defined, and that the  $V$ -images of the  $\underline{\mathbb{A}}^{\overrightarrow{F}}$ -morphisms in  $\mathbb{D}$  lift to coalgebra homomorphisms in  $\mathbb{D}^{\overrightarrow{G}}$ .

**Moral.** Lifting the canonical factorization ( $\text{Ess} \wr \text{Ffa}$ ) of functors to the canonical factorizations  $(\mathcal{C}^\bullet \wr \mathcal{F})$  and  $(\mathcal{C} \wr \mathcal{F}^\bullet)$  of adjunctions boils down to generalizing *from isomorphisms to retractions* and *from equivalences to weak equivalences* of categories [16, Vol. 1, Sec. 7.9]. We were led to this generalization by applying categorical concept mining [50] in data analysis, where the nucleus construction extracts concepts from matrices. Here we preached about that practice. Time to practice what what we preached.

## References

- [1] H. Applegate and Myles Tierney. Categories with models. In Eckmann and Tierney [24], pages 156–244. Reprinted in *Theory and Applications of Categories* 18(2008).
- [2] H. Applegate and Myles Tierney. Iterated cotriples. In S. et al MacLane, editor, *Reports of the Midwest Category Seminar IV*, pages 56–99, Berlin, Heidelberg, 1970. Springer.
- [3] Michael Artin, Alexander Grothendieck, and Jean-Louis Verdier, editors. *Séminaire de Géométrie Algébrique: Théorie des Topos et Cohomologie Étale des Schemas (SGA 4)*, volume 269,270,305 of *Lecture Notes in Mathematics*. Springer-Verlag, 1964. Second edition, 1972.

- [4] Claude Auderset. Adjonctions et monades au niveau des 2-catégories. *Cahiers de Topologie et Géométrie Différentielle Catégoriques*, 15(1):3–20, 1974.
- [5] Yossi Azar, Amos Fiat, Anna Karlin, Frank McSherry, and Jared Saia. Spectral analysis of data. In *Proceedings of the thirty-third annual ACM Symposium on Theory of Computing, STOC '01*, pages 619–626, New York, NY, USA, 2001. ACM.
- [6] John C. Baez and J. Peter May. *Towards Higher Categories*, volume 152 of *IMA Volumes in Mathematics and its Applications*. Springer, 2009.
- [7] Adriana Balan and Alexander Kurz. On coalgebras over algebras. *Theoretical Computer Science*, 412(38):4989 – 5005, 2011. CMCS Tenth Anniversary Meeting.
- [8] Michael Barr. Coalgebras in a category of algebras. In *Category Theory, Homology Theory and their Applications I*, volume 86 of *Lecture Notes in Mathematics*, pages 1–12. Springer, 1969.
- [9] Michael Barr. *\*-Autonomous Categories*. Number 752 in *Lecture Notes in Mathematics*. Springer-Verlag, 1979.
- [10] Michael Barr. \*-Autonomous categories and linear logic. *Mathematical Structures in Computer Science*, 1(2):159–178, 1991.
- [11] Michael Barr. The Chu Construction. *Theory and Applications of Categories*, 2(2):17–35, 1996.
- [12] Michael Barr. The separated extensional Chu category. *Theory and Applications of Categories*, 4(6):137–147, 1998.
- [13] Michael Barr. The Chu construction: history of an idea. *Theory and Applications of Categories*, 17(1):10–16, 2006.
- [14] Michael Barr and Charles Wells. *Toposes, Triples, and Theories*. Number 278 in *Grundlehren der mathematischen Wissenschaften*. Springer-Verlag, 1985. Republished in: *Reprints in Theory and Applications of Categories*, No. 12 (2005).
- [15] Jonathan Mock Beck. *Triples, Algebras and Cohomology*. PhD thesis, Columbia University, 1967. Reprinted in *Theory and Applications of Categories*, No. 2, 2003, pp. 1–59.
- [16] Francis Borceux. *Handbook of Categorical Algebra*. Number 50 in *Encyclopedia of Mathematics and its Applications*. Cambridge University Press, 1994. Three volumes.
- [17] Marta Bunge. Tightly bounded completions. *Theory and Applications of Categories*, 28(8):213–240, 2013.
- [18] Claudio Carpineto and Giovanni Romano. *Concept Data Analysis: Theory and Applications*. John Wiley & Sons, 2004.

- [19] Bob Coecke and Aleks Kissinger. *Picturing Quantum Processes: A First Course in Quantum Theory and Diagrammatic Reasoning*. Cambridge University Press, 2017.
- [20] Bob Coecke, Dusko Pavlovic, and Jamie Vicary. A new description of orthogonal bases. *Math. Structures in Comp. Sci.*, 23(3):555–567, 2013. [arxiv.org:0810.0812](https://arxiv.org/abs/0810.0812).
- [21] Scott C. Deerwester, Susan T. Dumais, Thomas K. Landauer, George W. Furnas, and Richard A. Harshman. Indexing by Latent Semantic Analysis. *Journal of the American Society of Information Science*, 41(6):391–407, 1990.
- [22] Harish Devarajan, Dominic Hughes, Gordon Plotkin, and Vaughan Pratt. Full completeness of the multiplicative linear logic of Chu spaces. In *Proceedings of the 14th Symposium on Logic in Computer Science (LICS)*, pages 234–243. IEEE, 1999.
- [23] William G. Dwyer, Philip S. Hirschhorn, Daniel M. Kan, and Jeffrey H. Smith. *Homotopy Limit Functors on Model Categories and Homotopical Categories*, volume 113 of *Mathematical surveys and monographs*. American Mathematical Society, 2005.
- [24] Beno Eckmann and Myles Tierney, editors. *Seminar on Triples and Categorical Homology Theory*, number 80 in *Lecture Notes in Mathematics*. Springer-Verlag, 1969. Reprinted in *Theory and Applications of Categories* 18(2008).
- [25] Samuel Eilenberg. Singular homology theory. *Annals of Mathematics*, 45(3):407–447, 1944.
- [26] Samuel Eilenberg and Saunders MacLane. Relations between homology and homotopy groups of spaces. *Annals of Mathematics*, 46(3):480–509, 1945.
- [27] Samuel Eilenberg and Saunders MacLane. Relations between homology and homotopy groups of spaces. II. *Annals of Mathematics*, 51(3):514–533, 1950.
- [28] Samuel Eilenberg, John C Moore, et al. Adjoint functors and triples. *Illinois Journal of Mathematics*, 9(3):381–398, 1965.
- [29] Samuel Eilenberg and Joseph A Zilber. Semi-simplicial complexes and singular homology. *Annals of Mathematics*, 51(3):499–513, 1950.
- [30] Peter Freyd. *Abelian Categories: an Introduction to the Theory of Functors*. Harper and Row, 1964. Republished in: *Reprints in Theory and Applications of Categories*, No. 3 (2003).
- [31] Peter Gabriel and Michel Zisman. *Calculus of fractions and homotopy theory*, volume 35 of *Ergebnisse der Mathematik und ihrer Grenzgebiete*. Springer-Verlag, 2012.
- [32] Bernhard Ganter, Gerd Stumme, and Rudolf Wille, editors. *Formal Concept Analysis, Foundations and Applications*, volume 3626 of *Lecture Notes in Computer Science*. Springer, 2005.
- [33] Bernhard Ganter and Rudolf Wille. *Formal Concept Analysis: Mathematical Foundations*. Springer, Berlin/Heidelberg, 1999.

- [34] Gene H. Golub and Charles F. van Loan. *Matrix computations*, volume 3. JHU press, 2012.
- [35] Robert Gordon, A. John Power, and Ross Street. *Coherence for Tricategories*, volume 558 of *Memoirs of the American Mathematical Society*. American Mathematical Society, 1995.
- [36] Alexander Grothendieck. *Produits tensoriels topologiques et espaces nucléaires*, volume 16 of *Memoirs of the American Mathematical Soc.* AMS, 1955.
- [37] Alexander Grothendieck. Technique de descente et théorèmes d’existence en géométrie algébrique. i. généralités. descente par morphismes fidèlement plats. In *Séminaire Bourbaki : années 1958/59 - 1959/60, exposés 169-204*, number 5 in Séminaire Bourbaki, pages 299–327. Société mathématique de France, 1960. talk:190.
- [38] Alexander Grothendieck. *Revêtement étales et groupe fondamental (SGA1)*, volume 224 of *Lecture Notes in Mathematics*. Springer, 1971.
- [39] Alexander Grothendieck. Pursuing stacks. <http://thescrivener.github.io/PursuingStacks/ps-on> 1983.
- [40] Nick Gurski. *Coherence in Three-Dimensional Category Theory*, volume 201 of *Cambridge Tracts in Mathematics*. Cambridge University Press, 2013.
- [41] Ralph Hinze and Dan Marsden. *The Art of Category Theory Part I: Introducing String Diagrams*, 2019. Completed book, under review.
- [42] John R. Isbell. Small categories and completeness. *Mathematical Systems Theory*, 2(1):27–50, 1968.
- [43] Bart Jacobs. Coalgebras and approximation. In A. Nerode and Yu. V. Matiyasevich, editors, *International Symposium on Logical Foundations of Computer Science*, volume 813 of *Lecture Notes in Computer Science*, pages 173–183. Springer, 1994.
- [44] Bart Jacobs. *Categorical Logic and Type Theory*. Studies in logic and the foundations of mathematics. Elsevier, 2001.
- [45] Bart Jacobs. Bases as coalgebras. *Logical Methods in Computer Science*, 9(3), 2013.
- [46] Ian T. Jolliffe. *Principal Component Analysis*. Springer Series in Statistics. Springer, 1986.
- [47] Daniel M. Kan. Adjoint functors. *Transactions of the American Mathematical Society*, 87(2):294–329, 1958.
- [48] Daniel M Kan. A combinatorial definition of homotopy groups. *Annals of Mathematics*, 67(2):282–312, 1958.
- [49] Daniel M. Kan. Functors involving c.s.s. complexes. *Transactions of the American Mathematical Society*, 87(2):330–346, 1958.



- [50] Toshiaki Kataoka and Dusko Pavlovic. Towards Concept Analysis in Categories: Limit Inferior as Algebra, Limit Superior as Coalgebra. In L.S. Moss and P. Sobocinski, editors, *Proceedings of CALCO 2015*, volume 35 of *LIPICs*, pages 130–155, Dagstuhl, Germany, 2015. Leibniz-Zentrum für Informatik. arxiv:1505.01098.
- [51] G. Max Kelly and F. William Lawvere. On the complete lattice of essential localizations. *Bull. Soc. Math. de Belgique*, 41:289–319, 1989.
- [52] G.M. Kelly and Stephen Lack. On property-like structures. *Theory and Applications of Categories*, 3(9):213–250, 1997.
- [53] Heinrich Kleisli. Every standard construction is induced by a pair of adjoint functors. *Proceedings of the American Mathematical Society*, pages 544–546, 1965.
- [54] Anders Kock. Monads for which structures are adjoint to units. *J. Pure Appl. Algebra*, 104:41–59, 1995.
- [55] Mareli Korostenski and Walter Tholen. Factorization systems as Eilenberg-Moore algebras. *Journal of Pure and Applied Algebra*, 85(1):57 – 72, 1993.
- [56] Stephen Lack and Ross Street. The formal theory of monads II. *Journal of Pure and Applied Algebra*, 175(1):243–265, 2002.
- [57] Steve Lack. Facsimile of 9/9/99, sent to Paul Taylor. 8 pages; provided by Ross Street.
- [58] Jim Lambek. The influence of Heraclitus on modern mathematics. In J. Agassi et al., editor, *Scientific Philosophy Today: : Essays in Honor of Mario Bunge*, pages 111–121. Springer, 1981.
- [59] Joachim Lambek. *Completions of categories : seminar lectures given 1966 in Zurich*. Number 24 in Springer Lecture Notes in Mathematics. Springer-Verlag, 1966.
- [60] Thomas K. Landauer and Susan T. Dumais. A solution to Plato’s problem: The latent semantic analysis theory of acquisition, induction, and representation of knowledge. *Psychological review*, 104(2):211, 1997.
- [61] F. William Lawvere. Adjointness in foundations. *Dialectica*, 23:281–296, 1969. reprint in *Theory and Applications of Categories*, No. 16, 2006, pp.1–16.
- [62] F. William Lawvere. Ordinal sums and equational doctrines. In Eckmann and Tierney [24], pages 141–155. Reprinted in *Theory and Applications of Categories* 18(2008).
- [63] F. William Lawvere. Metric spaces, generalised logic, and closed categories. In *Rendiconti del Seminario Matematico e Fisico di Milano*, volume 43. Tipografia Fusi, Pavia, 1973. Reprinted in *Theory and Applications of Categories*, No. 1, 2002, pp. 1–37.

- [64] F. William Lawvere. Display of graphics and their applications, as exemplified by 2-categories and the hegelian 'taco'. In Teodor Rus, editor, *Proceedings of AMAST 1989*, pages 51–74. University of Iowa, 1989.
- [65] F William Lawvere. Unity and identity of opposites in calculus and physics. *Applied categorical structures*, 4(2):167–174, 1996.
- [66] Tom Leinster. *Higher Operads, Higher Categories*, volume 298 of *London Mathematical Society Lecture Note*. Cambridge University Press, 2004.
- [67] Jacob Lurie. *Higher Topos Theory*, volume 170 of *Annals of Mathematics Studies*. Princeton University Press, 2009.
- [68] George W. Mackey. On infinite dimensional linear spaces. *Proc. of the National Academy of Sciences*, 29(7):155–207, 1943.
- [69] Georges Maltsiniotis. *La théorie de l'homotopie de Grothendieck*, volume 301 of *Astérisque*. Société mathématique de France, 2005.
- [70] Bachuki Mesablishvili. Monads of effective descent type and comonadicity. *Theory Appl. Categ*, 16(1):1–45, 2006.
- [71] John Milnor. The geometric realization of a semi-simplicial complex. *Annals of Mathematics*, 65(2):357–362, 1957.
- [72] Robert Paré. Absolute coequalizers. In *Category Theory, Homology Theory and their Applications I*, volume 86 of *Lecture Notes in Mathematics*, pages 132–145. Springer, 1969.
- [73] Robert Paré. On absolute colimits. *J. Alg.*, 19:80–95, 1971.
- [74] Dusko Pavlovic. *Predicates and Fibrations*. PhD thesis, Rijksuniversiteit Utrecht, 1990. <http://dusko.org/math-and-computation/>.
- [75] Dusko Pavlovic. Maps I: relative to a factorisation system. *J. Pure Appl. Algebra*, 99:9–34, 1995.
- [76] Dusko Pavlovic. Maps II: Chasing diagrams in categorical proof theory. *J. of the IGPL*, 4(2):1–36, 1996.
- [77] Dusko Pavlovic. Chu I: cofree equivalences, dualities and \*-autonomous categories. *Math. Structures in Comp. Sci.*, 7(2):49–73, 1997.
- [78] Dusko Pavlovic. Quantitative Concept Analysis. In Florent Domenach, Dmitry I. Ignatov, and Jonas Poelmans, editors, *Proceedings of ICFCA 2012*, volume 7278 of *Lecture Notes in Artificial Intelligence*, pages 260–277. Springer Verlag, 2012. arXiv:1204.5802.

- [79] Dusko Pavlovic. Bicompletions of distance matrices. In Bob Coecke, Luke Ong, and Prakash Panangaden, editors, *Computation, Logic, Games and Quantum Foundations. The Many Facets of Samson Abramsky*, volume 7860 of *Lecture Notes in Computer Science*, pages 291–310. Springer Verlag, 2013.
- [80] Dusko Pavlovic. Towards a science of trust. In *Proceedings of the 2015 Symposium and Bootcamp on the Science of Security*, HotSoS '15, pages 3:1–3:9, New York, NY, USA, 2015. ACM. arxiv.org:1503.03176.
- [81] Dusko Pavlovic and Dominic J.D. Hughes. Concept categories: Mining information from adjunctions. in preparation.
- [82] Dusko Pavlovic and Dominic J.D. Hughes. Tight bicompletions of categories: The Lambek monad.
- [83] Dusko Pavlovic and Peter-Michael Seidel. Quotients in monadic programming: Projective algebras are equivalent to coalgebras. In *32nd Annual ACM/IEEE Symposium on Logic in Computer Science, LICS 2017, Reykjavik, Iceland, June 20-23, 2017*, pages 1–12. IEEE Computer Society, 2017. arxiv:1701.07601.
- [84] Vaughan R. Pratt. Chu spaces and their interpretation as concurrent objects. In J. van Leeuwen, editor, *Computer Science Today: Recent Trends and Developments*, volume 1000 of *Lecture Notes in Computer Science*, pages 392–405. Springer-Verlag, 1995.
- [85] Daniel Quillen. Rational homotopy theory. *Annals of Mathematics*, pages 205–295, 1969.
- [86] Daniel G. Quillen. *Homotopical algebra*, volume 43 of *Lecture Notes in Mathematics*. Springer, 1967.
- [87] Stephen Schanuel and Ross Street. The free adjunction. *Cahiers de topologie et géométrie différentielle catégoriques*, 27(1):81–83, 1986.
- [88] Carlos Simpson. *Homotopy Theory of Higher Categories*, volume 19 of *New Mathematical Monographs*. Cambridge University Press, 2011.
- [89] Ross Street. The formal theory of monads. *Journal of Pure and Applied Algebra*, 2(2):149–168, 1972.
- [90] Ross Street. Fibrations in bicategories. *Cahiers de Topologie et Géométrie Différentielle Catégoriques*, 21(2):111–160, 1980.
- [91] Vladimir Vovk and Dusko Pavlovic. Universal probability-free prediction. *Ann. Math. Artif. Intell.*, 81(1-2):47–70, 2017. arxiv.org:1603.04283.
- [92] John H.C. Whitehead. Combinatorial homotopy. I and II. *Bulletin of the American Mathematical Society*, 55(3, 5):213–245, 453–496, 1949.

[93] Simon Willerton. Tight spans, Isbell completions and semi-tropical modules. *Theory and Applications of Categories*, 28(22):696–732, 2013.

[94] Volker Zöberlein. Doctrines on 2-categories. *Math. Zeitschrift*, 148:267–279, 1976.

## Appendices

### A Factorizations

**Definition A.1** A factorization system  $(\mathcal{E} \wr \mathcal{M})$  in a category  $\mathcal{C}$  a pair of subcategories  $\mathcal{E}, \mathcal{M} \subseteq \mathcal{C}$ , which contain all isomorphisms, and satisfy the following requirements:

- $\mathcal{C} = \mathcal{M} \circ \mathcal{E}$ : for every  $f \in \mathcal{C}$  there are  $e \in \mathcal{E}$  and  $m \in \mathcal{M}$  such that  $f = m \circ e$ , and
- $\mathcal{E} \perp \mathcal{M}$ : for every  $e \in \mathcal{E}$  and  $m \in \mathcal{M}$ , and for any  $f, g \in \mathcal{C}$  such that  $mu = ve$  there is a unique  $h \in \mathcal{C}$  such that  $u = he$  and  $v = mh$ , as displayed in (113).

$$\begin{array}{ccc}
 A & \xrightarrow{u} & C \\
 e \downarrow & \nearrow h & \downarrow m \\
 B & \xrightarrow{v} & D
 \end{array} \tag{113}$$

If  $h$  is not uniquely determined by this property, then the factorization system is weak. The elements of  $\mathcal{E}$  and of  $\mathcal{M}$  are respectively called (abstract) epis and monics.

**Proposition A.2** In every factorization system  $\mathcal{E} \wr \mathcal{M}$ , the families of abstract epis and monics determine each other by

$$\mathcal{E} = {}^\perp \mathcal{M} = \{e \in \mathcal{C} \mid e \perp \mathcal{M}\} \quad \text{and} \quad \mathcal{M} = \mathcal{E}^\perp = \{m \in \mathcal{C} \mid \mathcal{E} \perp m\}$$

where  $e \perp m$  means that  $e$  and  $m$  satisfy (113) for all  $u, v$ , and  $e \perp X$  and  $X \perp m$  mean that  $e \perp x$  and  $x \perp m$  hold for all  $x \in X$ .

**Proposition A.3** Factorization systems in any category form a complete lattice with respect to the ordering

$$(\mathcal{E} \wr \mathcal{M}) \leq (\mathcal{E}' \wr \mathcal{M}') \iff \mathcal{E} \subseteq \mathcal{E}' \wedge \mathcal{M} \supseteq \mathcal{M}' \tag{114}$$

The suprema and the infima in this lattice are respectively in the forms

- $\bigwedge_{j \in J} (\mathcal{E}_j \wr \mathcal{M}_j) = (\hat{\mathcal{E}} \wr \hat{\mathcal{M}})$  where  $\hat{\mathcal{E}} = \bigcap_{j \in J} \mathcal{E}_j$ , and  $\hat{\mathcal{M}} = \hat{\mathcal{E}}^\perp$ ,
- $\bigvee_{j \in J} (\mathcal{E}_j \wr \mathcal{M}_j) = (\check{\mathcal{E}} \wr \check{\mathcal{M}})$  is determined by  $\check{\mathcal{M}} = \bigcap_{j \in J} \mathcal{M}_j$  and  $\check{\mathcal{E}} = {}^\perp \check{\mathcal{M}}$ .

**Remark.** If the category  $\mathcal{C}$  is large, the lattice of its factorization systems is also large.

**Definition A.4** The arrow monad  $\text{Arr} : \text{CAT} \rightarrow \text{CAT}$  maps every category  $C$  to the induced arrow category  $\text{Arr}(C) = C/C$ , supported by the monad structure

$$\begin{array}{ccc}
 C & \xrightarrow{\eta} & \text{Arr}(C) & \xleftarrow{\mu} & \text{Arr}(\text{Arr}(C)) \\
 \\
 A & \mapsto & \begin{array}{c} A \\ | \\ \text{id} \\ \downarrow \\ A \end{array} & \begin{array}{c} A \\ | \\ g\varphi = \psi f \\ \downarrow \\ D \end{array} & \longleftarrow & \begin{array}{ccc} A & \xrightarrow{f} & C \\ \varphi \downarrow & & \downarrow \psi \\ B & \xrightarrow{g} & D \end{array}
 \end{array}$$

**Proposition A.5** Algebras for the arrow monad  $\text{Arr}(C) = C/C$  [55, 75] monad  $\text{Arr} : \text{CAT} \rightarrow \text{CAT}$  correspond to factorization systems.

**Proof.** The free Arr-algebra  $C/C$  comes with the canonical factorization system  $\Delta \wr \nabla$ , where

$$\Delta = \{ \langle \iota, f \rangle \in C^2 \mid \iota \in \text{Iso} \} \qquad \nabla = \{ \langle f, \iota \rangle \in C^2 \mid \iota \in \text{Iso} \}$$

where  $\text{Iso}$  is the family of all isomorphisms in  $C$ . The canonical factorization of a morphism  $\langle f, g \rangle \in \text{Arr}(C)(\varphi, \psi)$  thus splits its commutative square into two triangles, along the main diagonal  $g \circ \varphi = \psi \circ f$ , which is the canonical  $(\Delta, \nabla)$ -image of the factored morphism:

$$\begin{array}{ccc}
 A & \xlongequal{\quad} & A & \xrightarrow{f^*} & C \\
 \varphi \downarrow & & R^{f^*} \circ \Phi = \downarrow \Psi \circ f^* & & \downarrow \Psi \\
 R^B & \xrightarrow{R^{f^*}} & R^D & \xlongequal{\quad} & R^D \\
 \\
 B & \xleftarrow{f_*} & D & \xlongequal{\quad} & D
 \end{array} \tag{115}$$

A Chu-algebra  $\text{Chu}(\mathbb{C}) \xrightarrow{\alpha} \mathbb{C}$  determines a matrix factorization in  $\mathbb{C}$  by

$$\mathcal{E} = \{ \alpha(e) \mid e \in \Delta \} \qquad \mathcal{M} = \{ \alpha(m) \mid m \in \nabla \}$$

The other way around, any matrix  $\Phi \in \mathbb{C}(A, R^B)$  lifts to  $\text{Chu}(\mathbb{C})$  as the morphism  $\langle \Phi, \Phi^o \rangle \in \text{Chu}(\mathbb{C})(\eta_A, \text{id}_{R^A})$ , which is factorized in the form

$$\begin{array}{ccc}
 A & \xlongequal{\quad} & A & \xrightarrow{\Phi} & R^B \\
 \eta \downarrow & & \downarrow \Phi & & \downarrow \text{id} \\
 R^{R^A} & \xrightarrow{R^{\Phi^o}} & R^B & \xlongequal{\quad} & R^B \\
 \\
 R^A & \xleftarrow{\Phi^o} & B & \xlongequal{\quad} & B
 \end{array} \tag{116}$$

The factorization of  $\Phi$  in  $\mathbb{C}$  is now induced by the algebra  $\text{Chu}(\mathbb{C}) \xrightarrow{\alpha} \mathbb{C}$ . The cochain condition for this algebra gives

$$\alpha(A, A \xrightarrow{\eta} R^{R^A}, R^A) = A \quad \text{and} \quad \alpha(R^B, R^B \xrightarrow{\text{id}} R^B, B) = B$$

The factorization  $\eta_A \xrightarrow{\langle \text{id}, \Phi^o \rangle} \Phi \xrightarrow{\langle \Phi, \text{id} \rangle} \text{id}_{R^B}$  is then projected by  $\alpha$  from  $\text{Chu}(\mathbb{C})$  to  $\mathbb{C}$ , and the induced factorization is thus

$$\begin{array}{ccc} A & \xrightarrow{\Phi} & R^B \\ \alpha(\text{id}, \Phi^o) \searrow & & \swarrow \alpha(\Phi, \text{id}) \\ & \alpha(\Phi) & \end{array} \quad (117)$$

□

For a more detailed overview of abstract factorization systems, see [16, Vol. I, Sec. 5.5].

## B Morphing adjunctions, monads, comonads

In this section we supply some of the details omitted in Sec. 5.2.3.

### B.1 The bireflections $\text{AC} : \text{Adj} \rightarrow \text{Cmn}$ and $\text{AM} : \text{Adj} \rightarrow \text{Mnd}$

It was mentioned in the beginning that any adjunction  $F = (F^* \dashv F_* : \mathbb{B} \rightarrow A)$  induces the monad and the comonad

$$\text{AC}(F) = \left( \overrightarrow{F}, \varepsilon, \nu \right) \quad \text{AM}(F) = \left( \overleftarrow{F}, \eta, \mu \right)$$

where  $\overrightarrow{F} = F^* F_*$  and  $\overleftarrow{F} = F_* F^*$ , the counit  $\varepsilon$  and the unit  $\eta$  come from the adjunction, and

$$\nu_y = \left( \overrightarrow{F} y \xrightarrow{F^* \eta_{F_* y}} \overrightarrow{F} \overrightarrow{F} y \right) \quad \mu_x = \left( \overleftarrow{F} \overleftarrow{F} x \xrightarrow{F_* \varepsilon_{F^* x}} \overleftarrow{F} x \right)$$

Given another adjunction  $G = (G^* \dashv G_* : \mathbb{D} \rightarrow \mathbb{C})$ , an adjunction morphism  $(H, K, v^*, v_*) \in \text{Adj}(F, G)$ , as in Sec. 5.1.2, will be mapped to the comonad and a monad morphism

$$\text{AC}(H, K, v^*, v_*) = (K, \kappa) \quad \text{AM}(H, K, v^*, v_*) = (H, \chi)$$

which are determined by

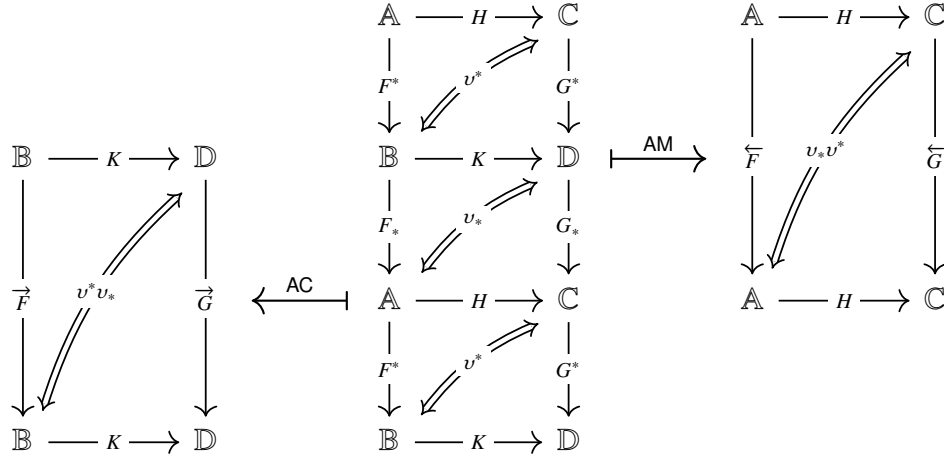

where

$$\kappa = \left( KF^*F_* \xleftrightarrow{u^*F_*} G^*HF_* \xleftrightarrow{G^*u_*} G^*G_*K \right) \quad \chi = \left( HF_*F^* \xleftrightarrow{u_*F^*} G_*KF^* \xleftrightarrow{G_*u^*} G_*G^*H \right)$$

## B.2 The initial resolutions $KM : \text{Mnd} \rightarrow \text{Adj}$ and $KC : \text{Cmn} \rightarrow \text{Adj}$

The Kleisli construction assigns to a monad  $\overleftarrow{T} : \mathbb{A} \rightarrow \mathbb{A}$  and a comonad  $\overrightarrow{T} : \mathbb{B} \rightarrow \mathbb{B}$  the initial resolutions

$$KM(\overleftarrow{T}) = (J^* \dashv J_* : \mathbb{A}_{\overleftarrow{T}} \rightarrow \mathbb{A}) \quad KC(\overrightarrow{T}) = (L^* \dashv L_* : \mathbb{B} \rightarrow \mathbb{B}_{\overrightarrow{T}})$$

where

$$\begin{aligned} |\mathbb{A}_{\overleftarrow{T}}| &= |\mathbb{A}| & |\mathbb{B}_{\overrightarrow{T}}| &= |\mathbb{B}| \\ \mathbb{A}_{\overleftarrow{T}}(x, x') &= \mathbb{A}(x, \overleftarrow{T}x') & \mathbb{B}_{\overrightarrow{T}}(y, y') &= \mathbb{B}(\overrightarrow{T}y, y') \end{aligned}$$

The composition operation in  $\mathbb{A}_{\overleftarrow{T}}$  is

$$\begin{aligned} \mathbb{A}_{\overleftarrow{T}}(x, x') \times \mathbb{A}_{\overleftarrow{T}}(x', x'') &\xrightarrow{\circ} \mathbb{A}_{\overleftarrow{T}}(x, x'') \\ \langle x \xrightarrow{f} \overleftarrow{T}x', x' \xrightarrow{g} \overleftarrow{T}x'' \rangle &\mapsto (x \xrightarrow{f} \overleftarrow{T}x' \xrightarrow{\overleftarrow{T}g} \overleftarrow{T}\overleftarrow{T}x'' \xrightarrow{\mu} \overleftarrow{T}x'') \end{aligned}$$

and in  $\mathbb{B}_{\overrightarrow{T}}$  it is dual. The role of the identity on  $x$  in  $\mathbb{A}_{\overleftarrow{T}}$  is played by the monad unit  $\eta_x$ , and on  $y$  in  $\mathbb{B}_{\overrightarrow{T}}$  by the comonad counit  $\varepsilon$ . The adjunction  $J = (J^T \dashv J_T : \mathbb{A}_{\overleftarrow{T}} \rightarrow \mathbb{A})$  is comprised of

- $J^T : \mathbb{A} \rightarrow \mathbb{A}_{\overleftarrow{T}}$ , which is identity on the objects, and maps a morphism  $f \in \mathbb{A}(x, x')$  to  $(x \xrightarrow{f} x' \xrightarrow{\eta} \overleftarrow{T}x')$ , and

- $J_T : \mathbb{A}_{\overleftarrow{T}} \rightarrow \mathbb{A}$  where  $J_T x = \overleftarrow{T}x$  on the objects,  $h \in \mathbb{A}_{\overleftarrow{T}}(x, x') = \mathbb{A}(x, Tx')$  lifts to  $J_T h = \left( \overleftarrow{T}x \xrightarrow{\overleftarrow{T}h} \overleftarrow{T}Tx \xrightarrow{\mu} \overleftarrow{T}x \right)$ .

The initial resolution  $L^T \dashv L_T : \mathbb{B} \rightarrow \mathbb{B}_{\overrightarrow{T}}$  of the comonad  $\overrightarrow{T}$  is dual again. We spell out the arrow part of the functor  $\text{KM} : \text{Mnd} \rightarrow \text{Adj}$ . Given a monad  $\overleftarrow{S}$  on  $\mathbb{C}$  and a monad morphism  $(H, \chi) \in \text{Mnd}(\overleftarrow{S}, \overleftarrow{T})$  like in Sec. 5.1.3, the arrow part

$$\text{KM}(H, \chi) = (H, H_\chi, \text{id}_H, \chi)$$

is determined using

$$\begin{array}{ccc}
 \begin{array}{ccc} \mathbb{C} & \xrightarrow{H} & \mathbb{A} \\ \downarrow & \nearrow \chi & \downarrow \\ \overleftarrow{S} & & \overleftarrow{T} \\ \downarrow & \nearrow \chi & \downarrow \\ \mathbb{C} & \xrightarrow{H} & \mathbb{A} \end{array} & \xrightarrow{\text{KM}} & \begin{array}{ccc} \mathbb{C} & \xrightarrow{H} & \mathbb{A} \\ \downarrow J^S & \nearrow \text{id} & \downarrow J^T \\ \overleftarrow{S} & \xrightarrow{H_\chi} & \overleftarrow{T} \\ \downarrow J_S & \nearrow \chi & \downarrow J_T \\ \mathbb{C} & \xrightarrow{H} & \mathbb{A} \end{array}
 \end{array}$$

where  $H_\chi u = Hu$  on the objects and  $f \in \mathbb{C}_{\overleftarrow{S}}$  is mapped to  $H_\chi f \in \mathbb{A}_{\overleftarrow{T}}$  by

$$\frac{f : u \rightarrow \overleftarrow{S}v}{H_\chi f = \left( Hu \xrightarrow{Hf} H\overleftarrow{S}v \xrightarrow{\chi} \overleftarrow{T}Hv \right)}$$

so that

$$v^*u = \left( H_\chi J^S u = Hu \xrightarrow{\text{id}} Hu = J^T Hu \right) \quad v_*u = \left( HJ_S u = H\overleftarrow{S}u \xrightarrow{\chi} \overleftarrow{T}Hu = \overleftarrow{T}H_\chi u \right)$$

The arrow part of  $\text{KC} : \text{Cmn} \rightarrow \text{Adj}$  is in the form  $\text{KC}(K, \kappa) = (K_\kappa, K, \kappa, \text{id}_K)$  for  $(K, \kappa) \in \text{Cmn}(\overrightarrow{S}, \overrightarrow{T})$  as defined in Sec. 5.1.4.



### B.3 The final resolutions $\text{EM} : \text{Mnd} \rightarrow \text{Adj}$ and $\text{EC} : \text{Cmn} \rightarrow \text{Adj}$

The Eilenberg-Moore construction assigns to the monad  $\overleftarrow{T} : \mathbb{A} \rightarrow \mathbb{A}$  the resolution  $U^* \dashv U_* : \mathbb{A}^{\overleftarrow{T}} \rightarrow \mathbb{A}$  where

$$|\mathbb{A}^{\overleftarrow{T}}| = \coprod_{a \in |\mathbb{A}|} \left\{ \alpha \in \mathbb{A}(\overleftarrow{T}a, a) \mid \begin{array}{ccc} \overleftarrow{T}\overleftarrow{T}a & \xrightarrow{\mu} & \overleftarrow{T}a \xleftarrow{\eta} a \\ \downarrow \overleftarrow{T}\alpha & & \downarrow \alpha \\ \overleftarrow{T}a & \xrightarrow{\alpha} & a \end{array} \right\} \quad (118)$$

$$\mathbb{A}^{\overleftarrow{T}}(\alpha, \gamma) = \left\{ h \in \mathbb{A}(a, c) \mid \begin{array}{ccc} \overleftarrow{T}a & \xrightarrow{\overleftarrow{T}h} & \overleftarrow{T}c \\ \downarrow \alpha & & \downarrow \gamma \\ a & \xrightarrow{h} & c \end{array} \right\}$$

The final resolution  $\text{EM}(\overleftarrow{T}) = (U^T \dashv U_T : \mathbb{A}^{\overleftarrow{T}} \rightarrow \mathbb{A})$  is comprised of

$$U^T : \mathbb{A} \rightarrow \mathbb{A}^{\overleftarrow{T}} \qquad U_T : \mathbb{A}^{\overleftarrow{T}} \rightarrow \mathbb{A}$$

$$x \mapsto \left( \overleftarrow{T}\overleftarrow{T}x \xrightarrow{\mu} \overleftarrow{T}x \right) \qquad \left( \overleftarrow{T}x \xrightarrow{\alpha} x \right) \mapsto x$$

For a monad  $\overleftarrow{S}$  on  $\mathbb{C}$ , a monad morphism  $(H, \chi) \in \text{Mnd}(\overleftarrow{S}, \overleftarrow{T})$  will now be mapped to

$$\text{EM}(H, \chi) = (H, H^\chi, \chi, \text{id}_H)$$

is determined using

$$\begin{array}{ccc} \begin{array}{ccc} \mathbb{C} & \xrightarrow{H} & \mathbb{A} \\ \downarrow \overleftarrow{S} & \nearrow \chi & \downarrow \overleftarrow{T} \\ \mathbb{C} & \xrightarrow{H} & \mathbb{A} \end{array} & \xrightarrow{\text{EM}} & \begin{array}{ccc} \mathbb{C} & \xrightarrow{H} & \mathbb{A} \\ \downarrow U^S & \nearrow \chi & \downarrow U^T \\ \mathbb{C}^{\overleftarrow{S}} & \xrightarrow{H^\chi} & \mathbb{A}^{\overleftarrow{T}} \\ \downarrow U_S & \nearrow \text{id} & \downarrow U_T \\ \mathbb{C} & \xrightarrow{H} & \mathbb{A} \end{array} \end{array}$$

where the object part of  $H^\chi$  maps

$$H^\chi \alpha = \left( \overleftarrow{T}Hu \xleftarrow{\chi} H\overleftarrow{S}u \xrightarrow{H\alpha} Hu \right)$$

the arrow part is  $H^\chi f = Hf$ , and the natural isomorphisms

$$v^*u = \left( H^\chi U^S u \xleftarrow{\chi} U^T H u \right) \quad v_*\alpha = \left( H U_S \alpha = H u \xleftarrow{\text{id}} H u = U_T H^\chi u \right)$$

The component  $v^*u$  is well-typed because (54) assures that  $\chi$  connects  $H\mu^S$  and  $\mu^T H$ , as shown in the following diagram.

$$\begin{array}{ccccc}
 \overleftarrow{H\overline{S}}\overleftarrow{S}u & \xleftarrow{\overleftarrow{\chi\overline{S}}} & \overleftarrow{T}\overleftarrow{H}\overleftarrow{S}u & \xleftarrow{\overleftarrow{\chi}} & \overleftarrow{T}\overleftarrow{T}Hu \\
 \searrow H\mu_u^S & & \downarrow H^\chi U^S u & & \downarrow U^T H u = \mu_{Hu}^{\overleftarrow{T}} \\
 & & \overleftarrow{H\overline{S}}u & \xleftarrow{\overleftarrow{\chi}} & \overleftarrow{T}Hu
 \end{array}$$

The Eilenberg-Moore construction for a comonad is dual, and the final resolution for  $\overrightarrow{T}$  on  $\mathbb{B}$  in the form  $\text{EC}(\overrightarrow{T}) = (V^T \dashv V_T : \mathbb{B} \rightarrow \mathbb{B}^{\overrightarrow{T}})$  is comprised of the forgetful functor  $V^T$  and the cofree functor  $V_T$  mapping  $y \in \mathbb{B}$  to  $\overrightarrow{T}y \xrightarrow{V} \overrightarrow{T}\overrightarrow{T}y$ . The arrow part is in the form  $\text{EM}(K, \kappa) = (K^\kappa, K, \text{id}_K, \kappa)$ , for  $(K, \kappa) \in \text{Cmn}(\overrightarrow{S}, \overrightarrow{T})$  as in Sec. 5.1.4.

## C Split equalizers

Split equalizers and coequalizers[14, 15] are conventionally written as *partially* commutative diagrams: the straight arrows commute, the epi-mono splittings compose to identities on the quotient side, and to equal idempotents on the other side.

**Proposition C.1** *Consider the split equalizer diagram*

$$\begin{array}{ccc}
 A & \begin{array}{c} \xrightarrow{i} \\ \xleftarrow{q} \end{array} & B & \begin{array}{c} \xrightarrow{f} \\ \xleftarrow{j} \\ \xleftarrow{r} \end{array} & C
 \end{array} \tag{119}$$

where

$$q \circ i = \text{id}_A \quad r \circ j = \text{id}_B \quad f \circ r \circ f = j \circ r \circ f$$

Then

- $r \circ f$  is idempotent and
- $i$  is the equalizer of  $f$  and  $j$  if and only if  $i \circ q = r \circ f$ .