

# Bounds for Multiple Packing and List-Decoding Error Exponents

Yihan Zhang\* Shashank Vatedka†

\*Faculty of Computer Science, Technion Israel Institute of Technology

†Department of Electrical Engineering, Indian Institute of Technology Hyderabad

## Abstract

We revisit the problem of high-dimensional multiple packing in Euclidean space. Multiple packing is a natural generalization of sphere packing and is defined as follows. Let  $N > 0$  and  $L \in \mathbb{Z}_{\geq 2}$ . A multiple packing is a set  $\mathcal{C}$  of points in  $\mathbb{R}^n$  such that any point in  $\mathbb{R}^n$  lies in the intersection of at most  $L - 1$  balls of radius  $\sqrt{nN}$  around points in  $\mathcal{C}$ . We study the multiple packing problem for both bounded point sets whose points have norm at most  $\sqrt{nP}$  for some constant  $P > 0$  and unbounded point sets whose points are allowed to be anywhere in  $\mathbb{R}^n$ . Given a well-known connection with coding theory, multiple packings can be viewed as the Euclidean analog of list-decodable codes, which are well-studied for finite fields. In this paper, we derive various bounds on the largest possible density of a multiple packing in both bounded and unbounded settings. A related notion called average-radius multiple packing is also studied. Some of our lower bounds exactly pin down the asymptotics of certain ensembles of average-radius list-decodable codes, e.g., (expurgated) Gaussian codes and (expurgated) Poisson Point Processes. To this end, we apply tools from high-dimensional geometry and large deviation theory. Some of our lower bounds on the optimal multiple packing density are the best known lower bounds. These bounds are obtained via a proxy known as error exponent. The latter quantity is the best exponent of the probability of list-decoding error when the code is corrupted by a Gaussian noise. We establish a curious inequality which relates the error exponent, a quantity of average-case nature, to the list-decoding radius, a quantity of worst-case nature. We derive various bounds on the error exponent in both bounded and unbounded settings which are of independent interest beyond multiple packing.

## CONTENTS

<b>I</b>	<b>Introduction</b>	<b>4</b>
<b>II</b>	<b>Related works</b>	<b>5</b>
<b>III</b>	<b>Our results</b>	<b>6</b>
<b>IV</b>	<b>Our techniques</b>	<b>7</b>
<b>V</b>	<b>Organization of the paper</b>	<b>11</b>
<b>VI</b>	<b>Notation</b>	<b>12</b>
<b>VII</b>	<b>Preliminaries</b>	<b>13</b>
<b>VIII</b>	<b>Basic definitions and facts</b>	<b>16</b>
	VIII-A Different notions of density of unbounded packings . . . . .	19
	VIII-B Density of bounded and unbounded packings . . . . .	20
	VIII-C Chebyshev radius and average radius . . . . .	21
	VIII-C1 Another representation of the Chebyshev radius . . . . .	22
	VIII-C2 Higher-order approximations to the Chebyshev radius . . . . .	22
	VIII-C3 More representations of the average radius . . . . .	22
	VIII-D Reduction from ball codes to spherical codes . . . . .	24
<b>IX</b>	<b>Random coding with expurgation</b>	<b>25</b>
<b>X</b>	<b>Lower bounds via Gaussian codes</b>	<b>26</b>
<b>XI</b>	<b>Lower bounds via spherical codes</b>	<b>28</b>
	XI-A Proof via normal approximation . . . . .	29
	XI-B Proof via Khinchin’s inequality . . . . .	30
	XI-C Ball codes . . . . .	32
<b>XII</b>	<b>Lower bounds via Poisson Point Processes (PPPs)</b>	<b>32</b>
	XII-A Large deviation principle . . . . .	33
	XII-B Laplace’s method . . . . .	34
	XII-C Putting things together . . . . .	35
	XII-D Connections . . . . .	36
	XII-E Mistakes in [Bli05b] . . . . .	37
<b>XIII</b>	<b>Lower bounds via reduction to sphere packing</b>	<b>37</b>
<b>XIV</b>	<b>Lower bounds via error exponents</b>	<b>38</b>
	XIV-A Special case where $L - 1 = 2$ . . . . .	40
	XIV-A1 Voronoi partition and higher-order Voronoi partition . . . . .	40
	XIV-A2 The largest angle of the triangle spanned by $\underline{x}_1, \underline{x}_2, \underline{x}_3$ is acute or right . . . . .	41
	XIV-A3 The largest angle of the triangle spanned by $\underline{x}_1, \underline{x}_2, \underline{x}_3$ is obtuse or flat . . . . .	43
	XIV-B General case where $L - 1 \geq 2$ . . . . .	44
	XIV-C Putting things together . . . . .	48
	XIV-D Mistakes in [Bli99] . . . . .	50
	XIV-E Unbounded packings . . . . .	50

<b>XV</b>	<b>Upper bounds</b>	<b>51</b>
XV-A	Plotkin bound . . . . .	52
XV-B	Elias–Bassalygo bound . . . . .	55
<b>XVI</b>	<b>List-decoding capacity for large <math>L</math></b>	<b>56</b>
<b>XVII</b>	<b>List-decoding error exponents</b>	<b>57</b>
XVII-A	Random coding exponent . . . . .	58
XVII-B	Expurgated exponent . . . . .	60
XVII-C	Input constraints . . . . .	62
XVII-D	Continuous alphabets . . . . .	63
XVII-E	Random coding exponent for AWGN channels with input constraints . . . . .	63
XVII-F	Expurgated exponent for AWGN channels with input constraints . . . . .	66
XVII-G	List-decoding error exponents vs. unique-decoding error exponents . . . . .	68
<b>XVIII</b>	<b>List-decoding error exponents of AWGN channels without input constraints</b>	<b>69</b>
XVIII-A	Random coding exponent . . . . .	69
XVIII-B	Expurgated exponent . . . . .	73
XVIII-C	List-decoding error exponents vs. unique-decoding error exponents . . . . .	77
<b>XIX</b>	<b>Open questions</b>	<b>77</b>
<b>XX</b>	<b>Acknowledgement</b>	<b>79</b>
	<b>References</b>	<b>79</b>

## I. INTRODUCTION

We revisit the problem of *multiple packing*, a natural generalization of the sphere packing problem. Let  $P, N > 0$  and  $L \in \mathbb{Z}_{\geq 2}$ . We say that a point set  $\mathcal{C}$  in  $\mathcal{B}^n(\sqrt{nP})$ <sup>1</sup> forms a  $(P, N, L - 1)$ -multiple packing if any point in  $\mathbb{R}^n$  lies in the intersection of at most  $L - 1$  balls of radius  $\sqrt{nN}$  around points in  $\mathcal{C}$ . Equivalently, the radius of the smallest ball containing any size- $L$  subset of  $\mathcal{C}$  is larger than  $\sqrt{nN}$ . The former quantity is known as the *Chebyshev radius* of the  $L$ -sized subset. If  $L = 2$ , then  $\mathcal{C}$  forms a *sphere packing*, i.e., a point set such that balls of radius  $\sqrt{nN}$  around points in  $\mathcal{C}$  are disjoint, or equivalently, the pairwise distance of points in  $\mathcal{C}$  is larger than  $2\sqrt{nN}$ . The density of  $\mathcal{C}$  is measured by its *rate* defined as

$$R(\mathcal{C}) := \frac{1}{n} \ln |\mathcal{C}|. \quad (1)$$

Denote by  $C_{L-1}(P, N)$  the largest rate of a  $(P, N, L - 1)$ -multiple packing as  $n \rightarrow \infty$ . Note that  $C_{L-1}(P, N)$  depends on  $P$  and  $N$  only through their ratio  $N/P$  which we call the *noise-to-signal ratio*. The goal of this paper is to advance the understanding of  $C_{L-1}(P, N)$ .

The problem of multiple packing is closely related to the *list-decoding* problem [Eli57], [Woz58] in coding theory. Indeed, a multiple packing can be seen exactly as the *Euclidean* analog of a list-decodable code. We will interchangeably use the terms “packing” and “code” to refer to the point set of interest. To see the connection, note that if any point in a multiple packing is transmitted through an adversarial channel that can inflict an arbitrary additive noise of length at most  $\sqrt{nN}$ , then given the distorted transmission, one can decode to a list of the nearest  $L - 1$  points which is guaranteed to contain the transmitted one. The quantity  $C_{L-1}(P, N)$  can therefore be interpreted as the capacity of this channel.

The  $L = 2$  case has a long history since at least the Kepler conjecture [Kep11] in 1611. The best known lower bound is due to Blachman in 1962 [Bla62] using a simple volume packing argument. The best known upper bound is due to Kabatiansky and Levenshtein in 1978 [KL78] using the seminal Delsarte’s linear programming framework [Del73] from coding theory. These bounds meet nowhere except at two points  $N/P = 0$  (where  $C_{L-1}(P, N) = \infty$ ) and  $N/P = 1/2$  (where  $C_{L-1}(P, N) = 0$ ).

For  $L > 2$ , Blinovsky [Bli99] claimed a lower bound (Equation (6)) on  $C_{L-1}(P, N)$  with a non-rigorous proof (see Section XIV-D). We prove this bound in this paper which turns out to be the best known lower bound on  $C_{L-1}(P, N)$ . In the same paper, Blinovsky [Bli99] also rederived an upper bound using the ideas of the Plotkin bound [Plo60] and the Elias–Bassalygo bound [Bas65] in coding theory. This bound was originally shown by Blachman and Few [BF63] using a more involved approach. Blinovsky and Litsyn [BL11] later improved this bound in the low-rate regime by a recursive application of a bound on the distance distribution by Ben-Haim and Litsyn [BHL08]. The latter bound in turn relies on the Kabatiansky–Levenshtein linear programming bound [KL78]. Blinovsky and Litsyn [BL11] numerically verified that their bounds improve previous ones when the rate is sufficiently low, but no explicit expression was given.

The above notion of  $(P, N, L - 1)$ -multiple packing also makes sense if we remove the restriction that all points lie in  $\mathcal{B}^n(\sqrt{nP})$  and allow the packing to contain points anywhere in  $\mathbb{R}^n$ . This leads to the notion of  $(N, L - 1)$ -multiple packing. The density of an unbounded packing is measured by the (normalized) number of points per volume

$$R(\mathcal{C}) := \limsup_{K \rightarrow \infty} \frac{1}{n} \ln \frac{|\mathcal{C} \cap \mathcal{B}^n(K)|}{|\mathcal{B}^n(K)|}. \quad (2)$$

With slight abuse of terminology, we call  $R(\mathcal{C})$  the *rate* of the unbounded packing  $\mathcal{C}$ , a.k.a. the *normalized logarithmic density (NLD)*. The largest density of unbounded multiple packings as  $n \rightarrow \infty$  is denoted by  $C_{L-1}(N)$ .

For  $L = 2$ , the unbounded sphere packing problem was extensively studied in the mathematics community. The best known lower bound is given by an awkwardly naive volume packing argument. The best known upper bound is obtained by reducing it to the bounded case for which we have the Kabatiansky–Levenshtein linear programming-type bound [KL78]. For  $L > 2$ , Blinovsky [Bli05b] claimed a lower bound by analyzing an (expurgated) Poisson Point Process (PPP). However, we noticed some flaws in the proof (see Section XII-E). We give a complete and rigorous proof in Section XII which gives the same bound as claimed in [Bli05b]. The paper [Bli05b] also presented an Elias–Bassalygo-type bound without a proof. We present a proof for it in Section XV-B for completeness.

<sup>1</sup>Here we use  $\mathcal{B}^n(r)$  to denote an  $n$ -dimensional Euclidean ball of radius  $r$  centered at the origin.

For the multiple packing problem with  $L > 2$ , many existing lower bounds (for both bounded and unbounded settings) are obtained under a stronger notion known as the *average-radius* multiple packing. Denote by  $\overline{C}_{L-1}(P, N)$  and  $\overline{C}_{L-1}(N)$  the largest density of average-radius multiple packings in the bounded and unbounded cases, respectively. In this paper, we treat them as different notions from  $C_{L-1}(P, N)$  and  $C_{L-1}(N)$ , and we study both notions. For any finite  $L \in \mathbb{Z}_{\geq 2}$ , it is unknown whether the largest multiple packing density under the regular notion is the same as that under the average-radius variant.

For  $L \rightarrow \infty$ , Zhang and Vatedka [ZV19] determined the limiting value of  $C_{L-1}(N)$ . It follows from results in this paper that  $\overline{C}_{L-1}(N)$  converges to the same value as  $L \rightarrow \infty$ . The limit of  $C_{L-1}(P, N)$  as  $L \rightarrow \infty$  is a folklore in the literature and a proof can be found in [ZVJS18]. However, as far as we know, it is not known whether  $\overline{C}_{L-1}(P, N)$  converges to the same value as  $C_{L-1}(P, N)$ .

Very little is known about structured packings. Grigorescu and Peikert [GP12] initiated the study of list-decodability of lattices. Zhang and Vatedka [ZV19] had results on list-decodability of random lattices.

## II. RELATED WORKS

For  $L = 2$ , the problem of (unbounded) sphere packing has a long history and has been extensively studied, especially for small dimensions. The largest packing density is open for almost every dimension, except for  $n = 1$  (trivial), 2 ([Thu11], [Tót40]), 3 (the Kepler conjecture, [Hal98], [HAB<sup>+</sup>17]), 8 ([Via17]) and 24 ([CKM<sup>+</sup>17]). For  $n \rightarrow \infty$ , the best lower and upper bounds remain the trivial sphere packing bound and Kabatiansky–Levenshtein’s linear programming bound [KL78]. This paper is only concerned with (multiple) packings in high dimensions and we measure the density in the normalized way as mentioned in Section I.

There is a parallel line of research in combinatorial coding theory. Specifically, a uniquely-decodable code (resp. list-decodable code) is nothing but a sphere packing (resp. multiple packing) which has been extensively studied for  $\mathbb{F}_q^n$  equipped with the Hamming metric. Empirically, it seems that the problem is harder for smaller field sizes  $q$ .

We first list the best known results for sphere packing (i.e.,  $L = 2$ ) in Hamming spaces. For  $q = 2$ , the best lower and upper bounds are the Gilbert–Varshamov bound [Gil52], [Var57] proved using a trivial volume packing argument and the second MRRW bound [MRRW77] proved using the seminal Delsarte’s linear programming framework [Del73], respectively. Surprisingly, the Gilbert–Varshamov bound can be improved using algebraic geometry codes [Gop77], [TVZ82] for  $q \geq 49$ , a phenomenon that is absent in  $\mathbb{R}^n$ . For  $q \geq n$ , the largest packing density is known to exactly equal the Singleton bound [Kom53], [Jos58], [Sin64] which is met by, for instance, the Reed–Solomon code [RS60].

Less is known for multiple packing in Hamming spaces. We first discuss the binary case (i.e.,  $q = 2$ ). For every  $L \in \mathbb{Z}_{\geq 2}$ , the best lower bound appears to be Blinovsky’s bound [Bli12, Theorem 2, Chapter 2] proved under the stronger notion of average-radius list-decoding. The best upper bound for  $L = 3$  is due to Ashikhmin, Barg and Litsyn [ABL00] who combined the MRRW bound [MRRW77] and Litsyn’s bound [Lit99] on distance distribution. For any  $L \geq 4$ , the best upper bound is essentially due to Blinovsky again [Bli86], [Bli12, Theorem 3, Chapter 2], though there are some partial improvements. In particular, the idea in [ABL00] was recently generalized to larger  $L$  by Polyanskiy [Pol16] who improved Blinovsky’s upper bound for *even*  $L$  (i.e., odd  $L - 1$ ) and sufficiently large  $R$ . Similar to [ABL00], the proof also makes use of a bound on distance distribution due to Kalai and Linial [KL95] which in turn relies on Delsarte’s linear programming bound. For larger  $q$ , Blinovsky’s lower and upper bounds [Bli05a], [Bli08], [AB08, Chapter III, Lecture 9, §1 and 2] remain the best known.

As  $L \rightarrow \infty$ , the limiting value of the largest multiple packing density is a folklore in the literature known as the “list-decoding capacity” theorem<sup>2</sup>. Moreover, the limiting value remains the same under the average-radius notion.

The problem of list-decoding was also studied for settings beyond the Hamming errors, e.g., list-decoding against erasures [Gur06], [BADTS20], insertions/deletions [GHS20], asymmetric errors [PZ21], etc. Zhang et al. considered list-decoding over general adversarial channels [ZBJ20]. List-decoding against other types of adversaries with *limited* knowledge such as oblivious or myopic adversaries were also considered in the literature [Hug97], [SG12], [ZJB20], [ZVJS18]. The current paper can be viewed as a collection of results for list-decodable codes for adversarial channels over  $\mathbb{R}$  with  $\ell_2$  constraints.

<sup>2</sup>It is an abuse of terminology to use “list-decoding capacity” here to refer to the large  $L$  limit of the  $(L - 1)$ -list-decoding capacity.

### III. OUR RESULTS

We derive upper and lower bounds on the largest multiple packing density in both bounded and unbounded settings. We compare various bounds that appear in this paper. Let  $C_{L-1}(P, N)$  and  $\overline{C}_{L-1}(P, N)$  denote the largest density of multiple packings under the standard and the average-radius notions, respectively. Let  $C_{L-1}(N)$  and  $\overline{C}_{L-1}(N)$  denote the largest density of unbounded multiple packings under the standard and the average-radius notions, respectively.

We first focus on the  $(P, N, L-1)$ -multiple packing problem. Since average-radius multiple packing is stronger than the standard multiple packing,  $C_{L-1}(P, N) \geq \overline{C}_{L-1}(P, N)$  for any  $L \in \mathbb{Z}_{\geq 2}$  and  $P, N > 0$ . Therefore any lower bound on  $\overline{C}_{L-1}(P, N)$  automatically holds for  $C_{L-1}(P, N)$  and any upper bound on  $C_{L-1}(P, N)$  automatically holds for  $\overline{C}_{L-1}(P, N)$ . Similar statements also hold for  $C_{L-1}(N)$  vs.  $\overline{C}_{L-1}(N)$ .

In **Theorem 23**, we obtain the *exact* asymptotics of (expurgated) Gaussian codes under  $(P, N, L-1)$ -average-radius list-decoding which serves as a lower bound on  $\overline{C}_{L-1}(P, N)$ :

$$\overline{C}_{L-1}(P, N) \geq \frac{1}{2} \left[ \ln \frac{(L-1)P}{LN} + \frac{LN}{(L-1)P} + 1 \right]. \quad (3)$$

In **Theorem 26**, we obtain a lower bound on the rate that can be achieved by (expurgated) spherical codes under  $(P, N, L-1)$ -average-radius list-decoding:

$$\overline{C}_{L-1}(P, N) \geq \frac{1}{2} \left[ 1 - \frac{LN}{(L-1)P} + \frac{1}{L-1} \ln \frac{P}{L(P-N)} \right]. \quad (4)$$

The following bound was initially proved by Blachman and Few [BF63] for  $C_{L-1}(P, N)$ . In **Theorem 34**, we simplify their proof and strengthen it so that it holds for  $\overline{C}_{L-1}(P, N)$ :

$$\overline{C}_{L-1}(P, N) \geq \frac{1}{2} \ln \frac{(L-1)^2 P^2}{LN(2(L-1)P - LN)}. \quad (5)$$

The idea due to Blachman and Few is to reduce the multiple packing problem to sphere packing. In **Theorem 40**, we obtain a lower bound on the  $(P, N, L-1)$ -list-decoding capacity via error exponents:

$$C_{L-1}(P, N) \geq \frac{1}{2} \left[ \ln \frac{(L-1)P}{LN} + \frac{1}{L-1} \ln \frac{P}{L(P-N)} \right]. \quad (6)$$

The above bound was claimed by Blinovskiy [Bli99] without a rigorous proof (see **Section XIV-D**). In the same paper, Blinovskiy also claimed the following upper bound on  $C_{L-1}(P, N)$ :

$$C_{L-1}(P, N) \leq \frac{1}{2} \ln \frac{(L-1)P}{LN}. \quad (7)$$

We make Blinovskiy's arguments for the above bound fully rigorous and complete and present a cleaner proof in **Theorem 51**. Finally, it is a folklore (whose proof can be found in [ZVJS18]) that as  $L \rightarrow \infty$ ,  $C_{L-1}(P, N)$  converges to the following expression:

$$C_{LD}(P, N) = \frac{1}{2} \ln \frac{P}{N}. \quad (8)$$

It remains an intriguing open question whether  $\overline{C}_{L-1}(P, N)$  converges to the same expression as  $L \rightarrow \infty$  (see **Item 3** in **Section XIX**).

Our upper and lower bounds are nowhere tight except for  $N = \frac{L-1}{L}P$  at which point both the upper and lower bounds vanish. We refer to this threshold  $\frac{N}{P} = \frac{L-1}{L}$  as the *Plotkin point*. As  $L \rightarrow \infty$ , the Plotkin point increases from  $1/2$  to  $1$ .

All the above bounds for  $(P, N, L-1)$ -multiple packing are plotted in **Figure 1** with  $L = 5$ . The horizontal axis is the noise-to-signal ratio  $N/P$  and the vertical axis is the value of various bounds. The largest lower bound turns out to be **Equation (6)** proved using error exponents as a proxy. We observe that the bound **Equation (4)** given by spherical codes is the second largest lower bound for sufficiently large rates. Indeed, the only difference between these two bounds **Equations (4)** and **(6)** is that

$$1 - \frac{LN}{(L-1)P} \leq \ln \frac{(L-1)P}{LN}, \quad (9)$$

where the LHS appears in Equation (4) and the RHS appears in Equation (6). The above inequality follows from the elementary inequality  $\ln x \leq x - 1$  for any  $x > 0$ . In fact, the LHS forms the first two terms of the Taylor series of the RHS at  $N/P = 0$ . However, Equation (4) gets worse quickly as  $N/P$  decreases, as plotted in Figures 1b and 1c. We also plot the best lower bound Equation (4) together with the Elias–Bassalygo-type upper bound Equation (7) in Figure 2 for  $L = 3, 4, 5$ . They both converge from below to Equation (8) as  $L$  increases.

We then juxtapose various bounds for the  $(N, L - 1)$ -multiple packing problem. In Theorem 46, the following lower bound (Equation (10)) on  $C_{L-1}(N)$  is obtained via the connection with error exponents. Furthermore, in Theorem 31, it is shown that the same bound is in fact the *exact* asymptotics of an (expurgated) PPP under  $(N, L - 1)$ -average-radius list-decoding (which is stronger than  $(N, L - 1)$ -list-decoding):

$$\bar{C}_{L-1}(N) \geq \frac{1}{2} \ln \frac{L-1}{2\pi eNL} - \frac{\ln L}{2(L-1)}. \quad (10)$$

In [Bli05b], Blinovskiy also considered PPPs and arrived at the same bound. However, the proof has some flaws (see Section XII-E). The techniques in [BF63] can be adapted to the unbounded setting and be strengthened to work for the stronger notion of *average-radius* multiple packing. They yield the following lower bound on  $\bar{C}_{L-1}(N)$ :

$$\bar{C}_{L-1}(N) \geq \frac{1}{2} \ln \frac{L-1}{4\pi eNL}. \quad (11)$$

As for upper bound, the techniques in Theorem 51 can be adapted to the unbounded setting as well which yield the following upper bound on  $C_{L-1}(N)$ :

$$C_{L-1}(N) \leq \frac{1}{2} \ln \frac{L-1}{2\pi eNL}. \quad (12)$$

Finally, it is known (see, e.g., [ZV19]) that as  $L \rightarrow \infty$ ,  $C_{L-1}(N)$  converges to the following expression:

$$C_{LD}(N) = \frac{1}{2} \ln \frac{1}{2\pi eN}. \quad (13)$$

Note that, by the lower and upper bounds (Equations (10) and (12)) on  $\bar{C}_{L-1}(N)$  for finite  $L$ , the limiting value of  $\bar{C}_{L-1}(N)$  as  $L \rightarrow \infty$  is also the above expression.

All the above bounds for  $(N, L - 1)$ -multiple packing are plotted in Figure 3 with  $L = 5$ . The horizontal axis is  $N$  and the vertical axis is the value of various bounds. The largest lower bound turns out to be Equation (10) given by (expurgated) PPPs.

#### IV. OUR TECHNIQUES

We summarize our techniques below.

For lower bounds, our basic strategy is random coding with expurgation, a standard tool from information theory. To show the existence of a list-decodable code of rate  $R$ , we simply randomly sample  $e^{nR}$  points independently each according to a certain distribution. There might be bad lists of size  $L$  that violates the multiple packing condition. We then throw away (a.k.a. expurgate) one point from each of the bad lists. By carefully analyzing the error event and choosing a proper rate, we can guarantee that the remaining code has essentially the same rate after the removal process. We then get a list-decodable code of rate  $R$  by noting that the remaining code contains no bad lists.

In the above framework, the key ingredient is a good estimate on the probability of the error event, i.e., the probability that the *list-decoding radius* of a size- $L$  list is smaller than  $\sqrt{nN}$ . Under the standard notion of multiple packing, the list-decoding radius is the *Chebyshev radius* of the list, i.e., the radius of the smallest ball containing the list. Under the average-radius notion of multiple packing, the list-decoding radius is the *average radius* of the list, i.e., the average distance from each point in the list to the centroid of the list. Due to the analytic simplicity of the average-radius variant, we manage to obtain the *exact* rate of certain ensembles of average-radius list-decodable codes. In particular, we get the exact rate of expurgated Gaussian codes in the bounded setting and expurgated Poisson Point Processes (PPPs) in the unbounded setting. The exact exponents of the probability of the error event are obtained using Cramér’s large deviation principle and the Laplace’s method. Leveraging tools from high-dimensional probability including Khinchin’s inequality and normal approximation, we also have bounds for other ensembles of codes such as (expurgated) spherical codes and (expurgated) ball codes.



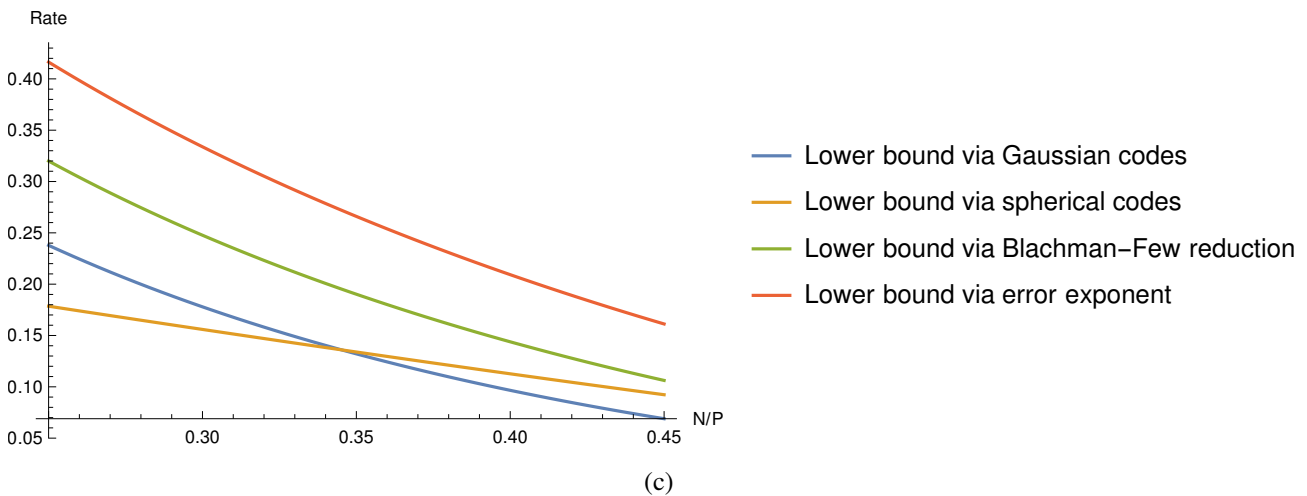
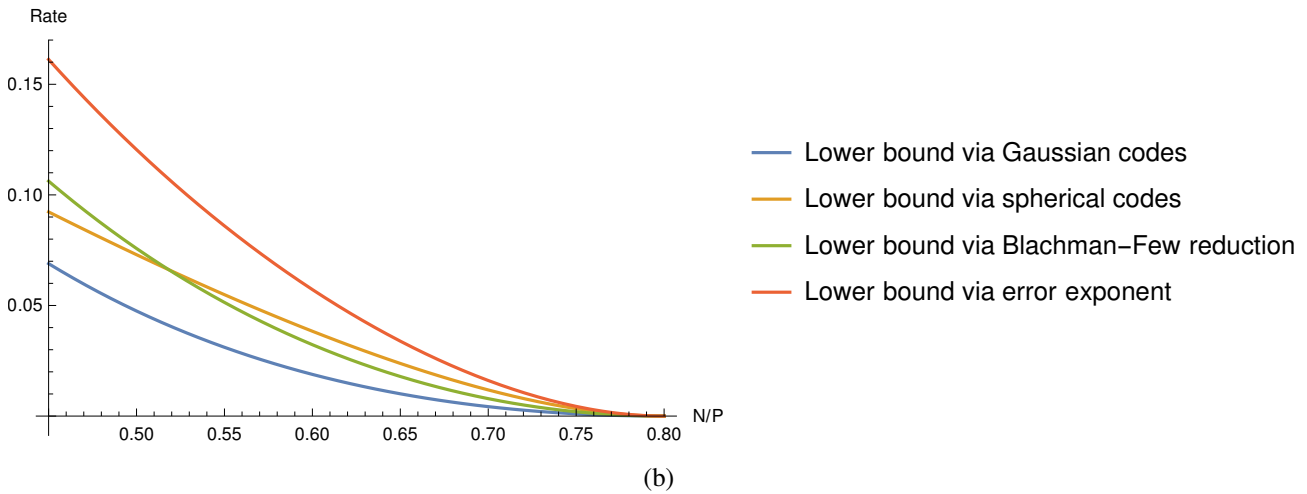
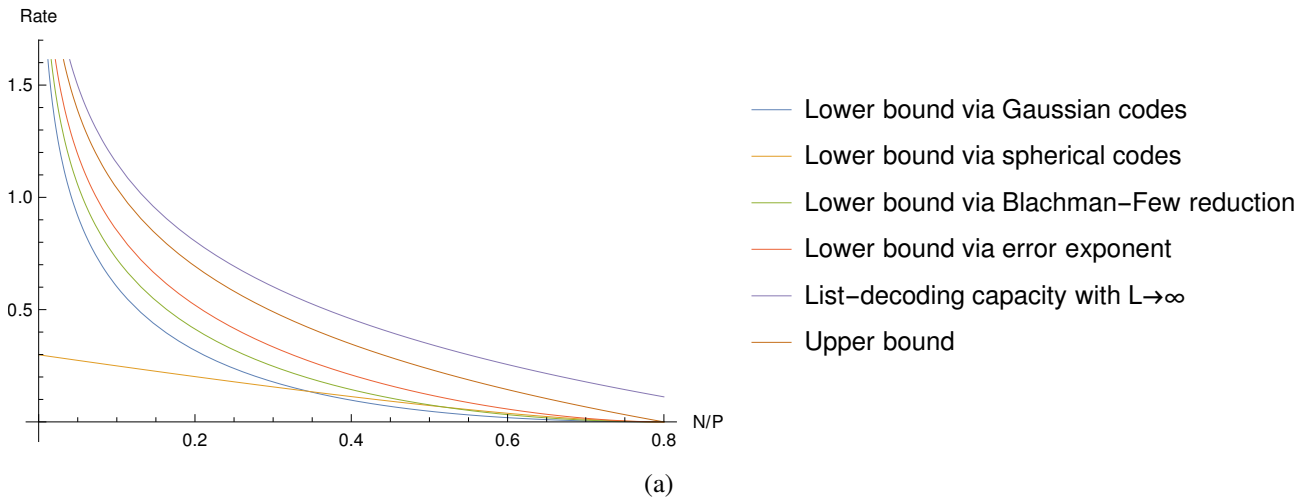
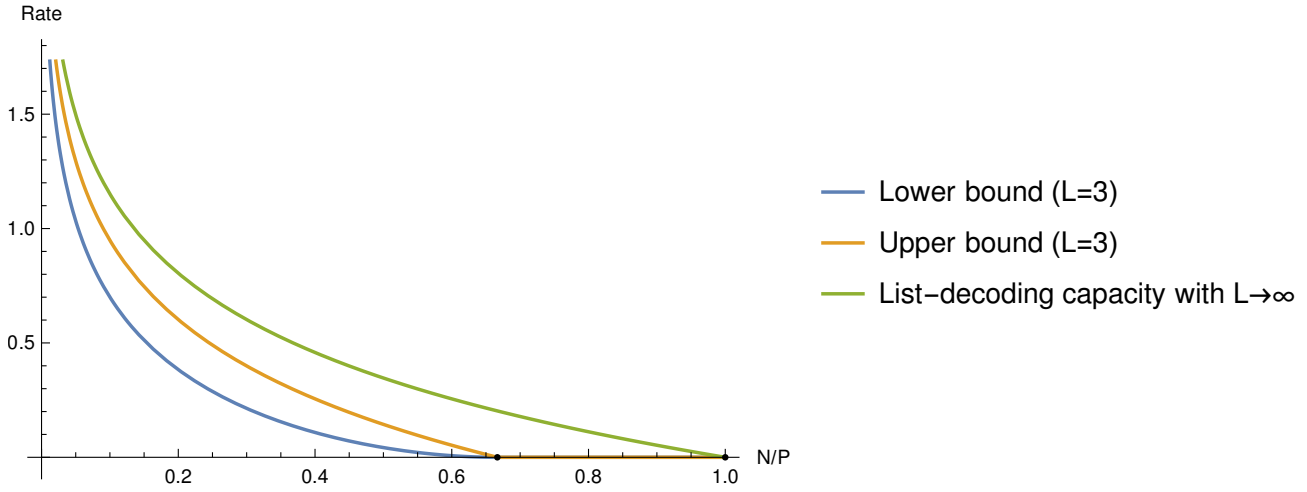
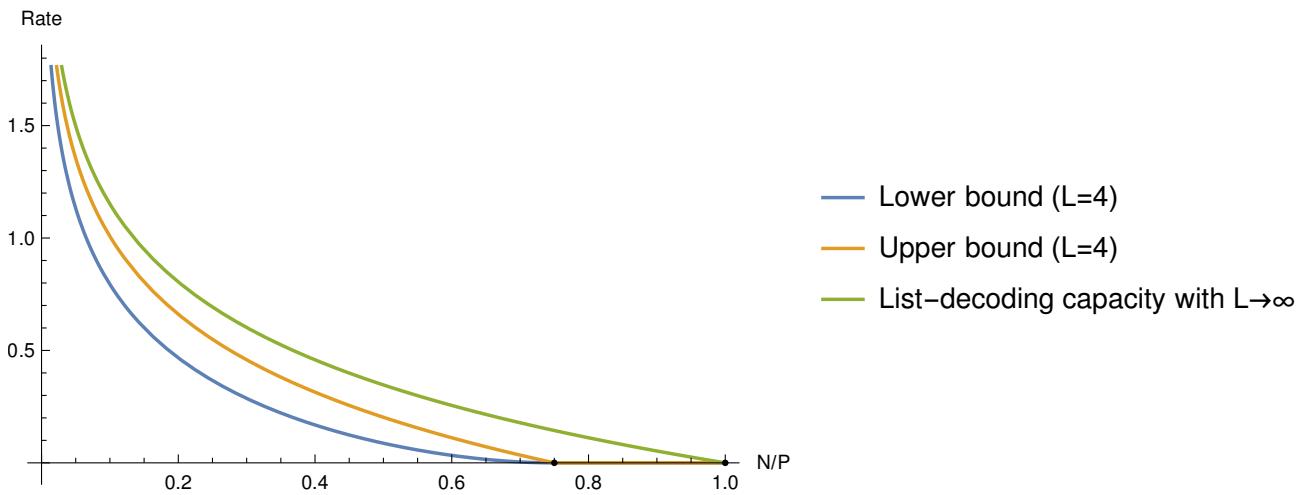

Fig. 1: Comparison of different bounds for the  $(P, N, L - 1)$ -list-decoding problem. The horizontal axis is  $N/P$  and the vertical axis is the value of various bounds. Recall that the rate (Equation (1)) of a bounded packing is defined as its normalized cardinality. We plot bounds for  $L = 5$ . The expressions for all bounds in Figure 1a can be found in Equations (3) to (8). These bounds intersect with each other in a sophisticated manner. Therefore, we zoom in on the low rate regime in Figure 1b and on the middle rate regime in Figure 1c.





(a)



(b)

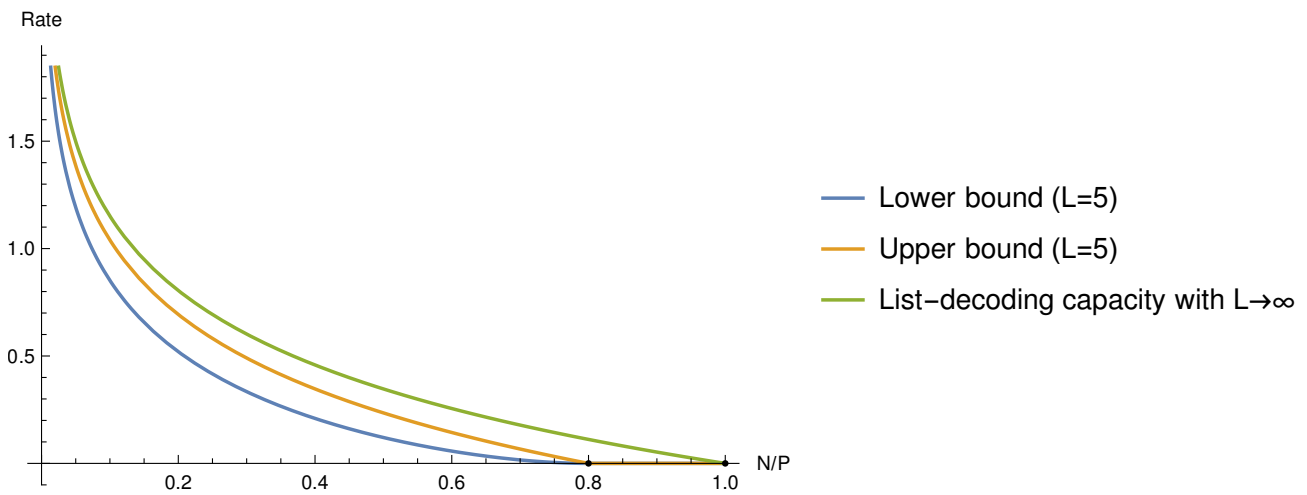

(c)

Fig. 2: Plots of the best known lower bound (Equation (6)) on  $C_{L-1}(P, N)$  and the Elias-Bassalygo-type upper bound (Equation (7)) for  $L = 3, 4, 5$ . As  $L$  increases, they both converge from below to  $C_{LD}(P, N)$  (Equation (8)). Curiously, the lower bound Equation (6) is proved using error exponents as a proxy.

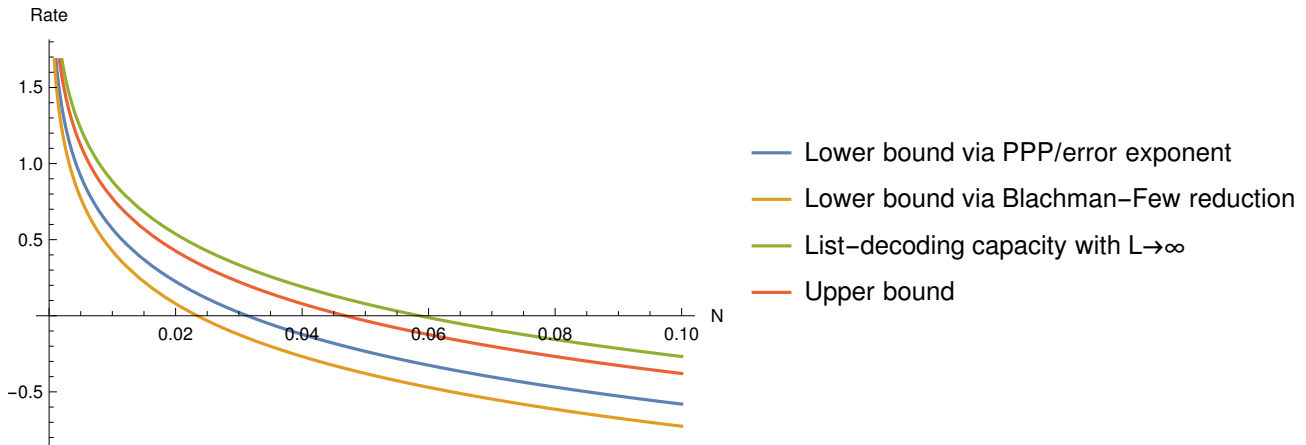

Fig. 3: Comparison of different bounds for the  $(N, L - 1)$ -list-decoding problem. The horizontal axis is  $N$  and the vertical axis is the value of bounds. We plot bounds for  $L = 5$ . Recall that the rate (Equation (2)) of an unbounded packing is defined as the (normalized) number of points per volume which can be negative. The expressions for all bounds can be found in Equations (10) to (13).

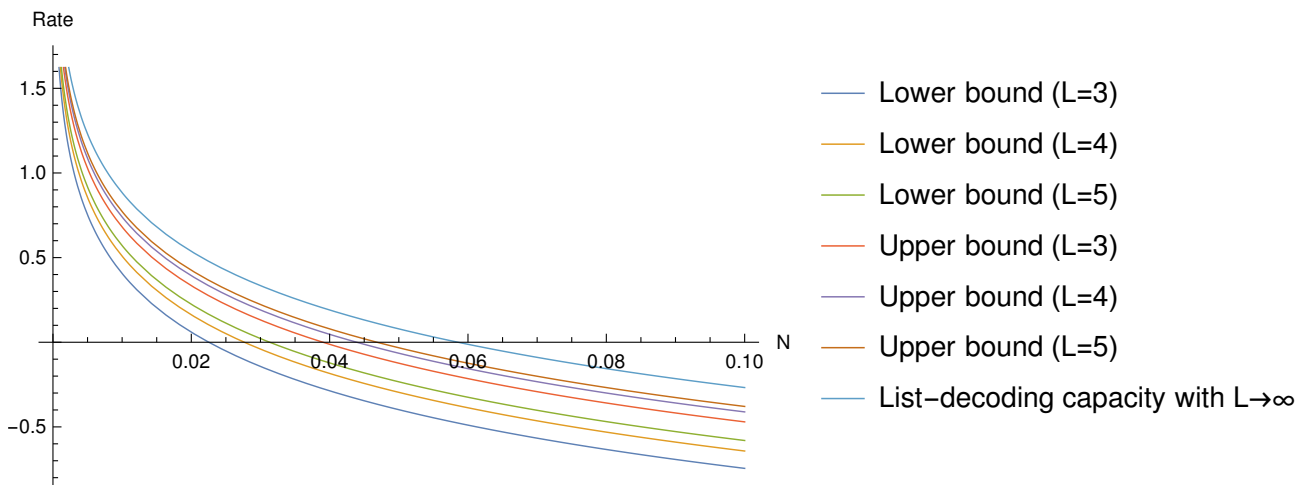

Fig. 4: Plots of the best known lower bound (Equation (10)) on  $C_{L-1}(N)$  and the Elias–Bassalygo-type upper bound for  $L = 3, 4, 5$ . As  $L$  increases, they both converge from below to  $C_{LD}(N)$  (Equation (13)). The lower bound Equation (10) can be obtained using the connection with error exponents. Moreover, it is actually the exact asymptotics of expurgated PPPs under the *average-radius* notion of unbounded multiple packing.

Unlike the average-radius notion which admits a clean expression, the standard notion of multiple packing is much more tricky to work with since the Chebyshev radius is a minimax expression. We do not know how to directly analyze the tail probability of the Chebyshev radius of an  $L$ -tuple of random points. Instead, we take a different approach which bypasses it via a proxy known as the *error exponent*. The latter quantity is the optimal exponent of the probability of list-decoding error of a code used over a Gaussian channel which inflicts an additive white Gaussian noise. We establish a curious inequality which relates the Chebyshev radius of lists in a code to the error exponent of the code. This inequality appeared in [Bli99] without a proof (see Section XIV-D). We present a complete proof in Section XIV which turns out to be highly nontrivial. Towards this end, we provide geometric understanding of the higher-order Voronoi partition induced by  $L$ -lists which naturally arises as the error regions under maximum likelihood list-decoding. We obtain sharp estimates on the Gaussian measure of the higher-order Voronoi region associated with a list which relates the error probability to the Chebyshev radius of the list. This inequality bridges two quantities of fundamentally different natures. The Chebyshev radius of is a combinatorial characteristic of a code against worst-case errors, whereas the error exponent is a probabilistic characteristic of a

code against average-case errors. The multiple packing problem then reduces to bounding the error exponent.

Our results on list-decoding error exponents of Gaussian channels are of independent interest beyond the study of multiple packing. We borrow a set of techniques from information theory to prove bounds on list-decoding error exponents. Specifically, in the bounded case, we follow Gallager’s approach [Gal65], [Gal68] and analyze random spherical codes; in the unbounded case, we mix the ideas in [IZF12], [AB10] and analyze PPPs and their expurgated versions (known as Matérn processes) using tools from stochastic geometry, e.g., the Slivnyak’s theorem and the Campbell’s theorem. It has been long known that list-decoding with any subexponential (in  $n$ ) list-sizes does not increase the capacity of any discrete memoryless channel (DMC) or Gaussian channel. Our results further show that list-decoding with constant list-sizes does not even improve the error exponent of capacity-achieving codes. In fact, for any  $L \in \mathbb{Z}_{\geq 2}$  and any rate  $R$  above a certain critical rate  $R_{\text{crit},1}$  below the capacity, the  $(L-1)$ -list-decoding error exponent coincides with the unique-decoding error exponent (i.e., when  $L = 2$ ). However, the error exponent *does* strictly increase under list-decoding when  $R$  is below  $R_{\text{crit},1}$ . By carefully analyzing the aforementioned ensembles of random codes and solving delicate optimization problems coming out of the analysis, we obtain explicit bounds on the list-decoding error exponent of Gaussian channels with or without input constraints. These expressions, to the best of our knowledge, are not known before. Moreover, they recover prior results by Gallager [Gal65], [Gal68, Theorem 7.4.4] (in the bounded case) and Poltyrev [Pol94] (in the unbounded case) for  $L = 2$ .

The upper bounds in this paper are neither novel nor sharp. They were sketched in Blinovsky’s works [Bli99], [Bli05b] and were improved in followup works [BL11]. The purpose of presenting them here is to provide a unified exposition and to clean up the literature. We fix the minor mistakes in Blinovsky’s proof and simplify it. As an ingredient for the Elias–Bassalygo-type bound, an explicit Plotkin-type bound on the optimal code size above the so-called *Plotkin point* is presented. Specifically, it is known (and also follows from our bounds) that as  $n \rightarrow \infty$ , the largest  $(P, N, L-1)$ -multiple packing has size  $\mathcal{O}(1)$  as long as  $N > \frac{L-1}{L}P$ . The threshold  $\frac{N}{P} = \frac{L-1}{L}$  is called the Plotkin point. We present bounds on the optimal code size as a function of  $\rho > 0$  when  $N = \frac{L-1}{L}P(1 + \rho)$ . Our bound reads as  $F(\rho^{-1} + 1)$  where  $F(\cdot)$  scales like the Ramsey number. This bound is far from being tight and indeed it was recently improved by Alon, Bukh and Polyanskiy [ABP18]. The exact dependence on  $\rho$  of the optimal size of codes above the Plotkin point is open. The suboptimal dependence of our Plotkin-type bound on  $\rho$  turns out to be sufficient for the proof of the Elias–Bassalygo-type bound.

As a technical contribution, we discover several new representations of the average radius and the Chebyshev radius. They play crucial roles in facilitating the analyses. To name a few, the average radius of a list can be written as a quadratic form associated with the list. This representation is used to analyze Gaussian codes and PPPs. The average radius can also be written as the difference between the average norm of points in the list and the norm of the centroid of the list. This representation is used to analyze spherical codes and ball codes. The average radius can be further written as the average pairwise distance of the list. This allows us to give a one-line proof of the Blachman–Few reduction and its strengthened version. Yet another way of writing the average radius using the average norm and the average pairwise correlation turns out to be useful for the proof of the Plotkin-type bound.

## V. ORGANIZATION OF THE PAPER

This paper is a collection of lower and upper bounds on the largest multiple packing density. The rest of the paper is organized as follows. Notational conventions and preliminary definitions/facts are listed in **Sections VI** and **VII**, respectively. After that, we present in **Section VIII** the formal definitions of multiple packing and pertaining notions. We also discuss different notions of density of codes used in the literature. Furthermore, we obtain several novel representations of the Chebyshev radius and the average radius which are crucial for estimating their tail probabilities. In **Section IX**, we introduce the basic technology for proving lower bounds: random coding with expurgation.

The rest of the sections are relatively independent of each other and can be read in an arbitrary order. In **Section X**, we analyze the exact asymptotics of expurgated Gaussian codes under average-radius list-decoding. In **Section XI**, we obtain bounds on the rate of average-radius list-decodable expurgated spherical codes and ball codes. In **Section XII**, we analyze the exact asymptotics of expurgated Poisson Point Processes under average-radius list-decoding. In **Section XIII**, we rederive, simplify and strengthen a lower bound by Blachman and Few [BF63] using a novel representation of average radius in **Section VIII-C**. In **Section XIV**, we prove the inequality that relates the Chebyshev radius to error exponent and combine it with bounds on error exponent to obtain lower

bounds on the largest multiple packing density. The bounds on error exponent used in this section are proved in [Section XVII](#) for the bounded case and in [Section XVIII](#) for the unbounded case. Complete and clean proofs of the Plotkin-type bound and the Elias–Bassalygo-type bound are presented in [Section XV](#). In [Section XVI](#), we list results on the limiting values of the largest multiple packing density as  $L \rightarrow \infty$ . Some of these results were known previously and others follow from the bounds in the current paper. We end the paper with several open questions in [Section XIX](#).

## VI. NOTATION

**Conventions.** Sets are denoted by capital letters in calligraphic typeface, e.g.,  $\mathcal{C}, \mathcal{B}$ , etc. Random variables are denoted by lower case letters in boldface or capital letters in plain typeface, e.g.,  $\mathbf{x}, S$ , etc. Their realizations are denoted by corresponding lower case letters in plain typeface, e.g.,  $x, s$ , etc. Vectors (random or fixed) of length  $n$ , where  $n$  is the blocklength without further specification, are denoted by lower case letters with underlines, e.g.,  $\underline{x}, \underline{\mathbf{g}}, \underline{x}, \underline{g}$ , etc. Vectors of length different from  $n$  are denoted by an arrow on top and the length will be specified whenever used, e.g.,  $\vec{t}, \vec{\alpha}$ , etc. The  $i$ -th entry of a vector  $\underline{x} \in \mathcal{X}^n$  is denoted by  $\underline{x}(i)$  since we can alternatively think  $\underline{x}$  as a function from  $[n]$  to  $\mathcal{X}$ . Same for a random vector  $\underline{\mathbf{x}}$ . Matrices are denoted by capital letters, e.g.,  $A, \Sigma$ , etc. Similarly, the  $(i, j)$ -th entry of a matrix  $G \in \mathbb{F}^{n \times m}$  is denoted by  $G(i, j)$ . We sometimes write  $G_{n \times m}$  to explicitly specify its dimension. For square matrices, we write  $G_n$  for short. Letter  $I$  is reserved for identity matrix.

**Functions.** We use the standard Bachmann–Landau (Big-Oh) notation for asymptotics of real-valued functions in positive integers.

For two real-valued functions  $f(n), g(n)$  of positive integers, we say that  $f(n)$  *asymptotically equals*  $g(n)$ , denoted  $f(n) \asymp g(n)$ , if

$$\lim_{n \rightarrow \infty} \frac{f(n)}{g(n)} = 1.$$

For instance,  $2^{n+\log n} \asymp 2^{n+\log n} + 2^n$ ,  $2^{n+\log n} \not\asymp 2^n$ . We write  $f(n) \doteq g(n)$  (read  $f(n)$  dot equals  $g(n)$ ) if the coefficients of the dominant terms in the exponents of  $f(n)$  and  $g(n)$  match,

$$\lim_{n \rightarrow \infty} \frac{\log f(n)}{\log g(n)} = 1.$$

For instance,  $2^{3n} \doteq 2^{3n+n^{1/4}}$ ,  $2^{2n} \not\doteq 2^{2n+\log n}$ . Note that  $f(n) \asymp g(n)$  implies  $f(n) \doteq g(n)$ , but the converse is not true.

For any  $q \in \mathbb{R}_{>0}$ , we write  $\log_q(\cdot)$  for the logarithm to the base  $q$ . In particular, let  $\log(\cdot)$  and  $\ln(\cdot)$  denote logarithms to the base 2 and  $e$ , respectively.

For any  $\mathcal{A} \subseteq \Omega$ , the indicator function of  $\mathcal{A}$  is defined as, for any  $x \in \Omega$ ,

$$\mathbb{1}_{\mathcal{A}}(x) := \begin{cases} 1, & x \in \mathcal{A} \\ 0, & x \notin \mathcal{A} \end{cases}.$$

At times, we will slightly abuse notation by saying that  $\mathbb{1}_{\mathcal{A}}$  is 1 when event  $\mathcal{A}$  happens and 0 otherwise. Note that  $\mathbb{1}_{\mathcal{A}}(\cdot) = \mathbb{1}\{\cdot \in \mathcal{A}\}$ .

**Sets.** For any two nonempty sets  $\mathcal{A}$  and  $\mathcal{B}$  with additive structures, let  $\mathcal{A} + \mathcal{B}$  denote the Minkowski sum of them which is defined as  $\mathcal{A} + \mathcal{B} := \{a + b : a \in \mathcal{A}, b \in \mathcal{B}\}$ . If  $\mathcal{A} = \{x\}$  is a singleton set, we write  $x + \mathcal{B}$  and for  $\{x\} + \mathcal{B}$ . For any  $r \in \mathbb{R}$ , the  $r$ -dilation of  $\mathcal{A}$  is defined as  $r\mathcal{A} := \{r\underline{a} : \underline{a} \in \mathcal{A}\}$ . In particular,  $-\mathcal{A} := (-1)\mathcal{A}$ .

For  $M \in \mathbb{Z}_{>0}$ , we let  $[M]$  denote the set of first  $M$  positive integers  $\{1, 2, \dots, M\}$ .

**Geometry.** Let  $\|\cdot\|_2$  denote the Euclidean/ $\ell_2$ -norm. Specifically, for any  $\underline{x} \in \mathbb{R}^n$ ,

$$\|\underline{x}\|_2 := \left( \sum_{i=1}^n \underline{x}(i)^2 \right)^{1/2}.$$

With slight abuse of notation, we let  $|\cdot|$  denote the “volume” of a set w.r.t. a measure that is obvious from the context. If  $\mathcal{A}$  is a finite set, then  $|\mathcal{A}|$  denotes the cardinality of  $\mathcal{A}$  w.r.t. the counting measure. For a set  $\mathcal{A} \subset \mathbb{R}^n$ , let

$$\text{aff}(\mathcal{A}) := \left\{ \sum_{i=1}^k \lambda_i \underline{a}_i : k \in \mathbb{Z}_{\geq 1}; \forall i \in [k], \underline{a}_i \in \mathcal{A}, \lambda_i \in \mathbb{R}, \sum_{i=1}^k \lambda_i = 1 \right\}$$

denote the *affine hull* of  $\mathcal{A}$ , i.e., the smallest affine subspace containing  $\mathcal{A}$ . If  $\mathcal{A}$  is a connected compact set in  $\mathbb{R}^n$  with nonempty interior and  $\text{aff}(\mathcal{A}) = \mathbb{R}^n$ , then  $|\mathcal{A}|$  denotes the volume of  $\mathcal{A}$  w.r.t. the  $n$ -dimensional Lebesgue measure. If  $\text{aff}(\mathcal{A})$  is a  $k$ -dimensional affine subspace for  $1 \leq k < n$ , then  $|\mathcal{A}|$  denotes the  $k$ -dimensional Lebesgue volume of  $\mathcal{A}$ .

The closed  $n$ -dimensional Euclidean unit ball is defined as

$$\mathcal{B}^n := \left\{ \underline{y} \in \mathbb{R}^n : \|\underline{y}\|_2 \leq 1 \right\}.$$

The  $(n-1)$ -dimensional Euclidean unit sphere is defined as

$$\mathcal{S}^{n-1} := \left\{ \underline{y} \in \mathbb{R}^n : \|\underline{y}\|_2 = 1 \right\}.$$

For any  $\underline{x} \in \mathbb{R}^n$  and  $r \in \mathbb{R}_{>0}$ , let  $\mathcal{B}^n(r) := r\mathcal{B}^n$ ,  $\mathcal{S}^{n-1}(r) := r\mathcal{S}^{n-1}$  and  $\mathcal{B}^n(\underline{x}, r) := \underline{x} + r\mathcal{B}^n$ ,  $\mathcal{S}^{n-1}(\underline{x}, r) := \underline{x} + r\mathcal{S}^{n-1}$ .

Let  $V_n := |\mathcal{B}^n|$ .

## VII. PRELIMINARIES

**Fact 1** (Volume of the unit ball).  $V_n \asymp \frac{1}{\sqrt{\pi n}} (2\pi e/n)^{n/2}$ .

**Lemma 2** (Markov). If  $\mathbf{x}$  is a nonnegative random variable, then for any  $a > 0$ ,  $\Pr[\mathbf{x} \geq a] \leq \mathbb{E}[\mathbf{x}]/a$ .

**Lemma 3** (Chebyshev). If  $\mathbf{x}$  is a nonnegative random variable, then for any  $a > 0$  and  $k > 0$ ,  $\Pr[\mathbf{x} \geq a] \leq \mathbb{E}[\mathbf{x}^k]/a^k$ .

**Lemma 4** (Gaussian tail). Let  $\mathbf{g} \sim \mathcal{N}(0, \sigma^2)$ . Then for any  $a > 0$ ,  $\Pr[\mathbf{g} > a] \leq \exp\left(-\frac{a^2}{2\sigma^2}\right)$ .

**Definition 1** ( $Q$ -function). The  $Q$ -function is defined as

$$Q(x) := \Pr[\mathcal{N}(0, 1) > x] = \frac{1}{\sqrt{2\pi}} \int_x^\infty e^{-g^2/2} dg.$$

**Lemma 5.** For any  $x > 0$ ,

$$Q(x) = \frac{1}{12} e^{-x^2/2} (1 + e^{-\Omega(x)}).$$

As a direct corollary, for any  $x > 0$ ,

$$\Pr[\mathcal{N}(0, \sigma^2) > x] = Q(x/\sigma) = \frac{1}{12} e^{-\frac{x^2}{2\sigma^2}} (1 + e^{-\Omega(x)}).$$

**Lemma 6** (Integration in polar coordinates). For any integrable function  $f: \mathbb{R}^n \rightarrow \mathbb{R}$ , we have

$$\int_{\mathbb{R}^n} f(\underline{x}) d\underline{x} = \int_{\mathcal{S}^{n-1}} \int_0^\infty f(r\underline{\theta}) r^{n-1} |\mathcal{S}^{n-1}| dr d\mu(\underline{\theta})$$

where  $\mu$  is the uniform probability measure on  $\mathcal{S}^{n-1}$ , i.e., for  $\mathcal{A} \subset \mathcal{S}^{n-1}$ ,  $\mu(\mathcal{A}) := \frac{|\mathcal{A}|}{|\mathcal{S}^{n-1}|}$ .

**Lemma 7** (Change of variable). Let  $\mathcal{U} \subset \mathbb{R}^n$  be an open set and  $\varphi: \mathcal{U} \rightarrow \mathbb{R}^n$  be an injective differentiable function with continuous partial derivatives, the Jacobian of which is nonzero for every  $\underline{u} \in \mathcal{U}$ . Then for any compactly supported, continuous function  $f: \varphi(\mathcal{U}) \rightarrow \mathbb{R}$ , the substitution  $\underline{v} = \varphi(\underline{u})$  yields the following formula

$$\int_{\varphi(\mathcal{U})} f(\underline{v}) d\underline{v} = \int_{\mathcal{U}} f(\varphi(\underline{u})) |\det(\nabla\varphi)(\underline{u})| d\underline{u}.$$

**Theorem 8** (Laplace's method). Let  $a < b \in \mathbb{R}$  and  $f, g: \mathbb{R} \rightarrow \mathbb{R}$ .

1) If  $t^* \in (a, b)$  is the unique minimum point of  $f$  in  $[a, b]$  such that  $f'(t^*) = 0$ ,  $f''(t^*) > 0$ ,  $g(t^*) \neq 0$ , then

$$\int_a^b g(t) e^{-Mf(t)} dt \stackrel{M \rightarrow \infty}{\asymp} e^{-Mf(t^*)} g(t^*) \sqrt{\frac{2\pi}{Mf''(t^*)}}.$$

2) If  $a$  is the unique minimum point of  $f$  in  $[a, b]$  such that  $f'(a) = 0, f''(a) > 0, g(a) \neq 0$ , then

$$\int_a^b g(t)e^{-Mf(t)} dt \underset{M \rightarrow \infty}{\approx} e^{-Mf(a)} g(a) \sqrt{\frac{\pi}{2Mf''(a)}}.$$

3) If  $a$  is the unique minimum point of  $f$  in  $[a, b]$  such that  $f'(a) > 0, g(a) \neq 0$ , then

$$\int_a^b g(t)e^{-Mf(t)} dt \underset{M \rightarrow \infty}{\approx} e^{-Mf(a)} \frac{g(a)}{Mf'(a)}.$$

**Theorem 9** (Laplace's method). *Let  $a \in \mathbb{R}$  and  $L \geq 2$  be an integer. Suppose  $g: \mathbb{R} \rightarrow \mathbb{R}$  satisfies  $g(a) = g^{(1)}(a) = g^{(2)}(a) = \dots = g^{(L-2)}(a) = 0$  and  $g^{(L-1)}(a) \neq 0$  where  $g^{(i)}$  denotes the  $i$ -th derivative of  $g$ . Suppose  $f: \mathbb{R} \rightarrow \mathbb{R}$  attains its unique minimum at  $a$  in the interval  $[a, \infty)$  and  $f^{(1)}(a) > 0$ . Then we have*

$$\int_a^\infty g(t)e^{-Mf(t)} dt \underset{M \rightarrow \infty}{\approx} e^{-Mf(a)} \frac{g^{(L-1)}(a)}{(Mf^{(1)}(a))^L}.$$

*Proof.* The proof follows closely that of the standard Laplace's formula and we only present a sketch of the former. The deviation is two-fold: (i) the function  $g$  is degenerate at a higher order; (ii) the extreme point  $a$  of  $f$  is on the boundary of the integration domain and is *not* a stationary point.

$$\begin{aligned} & \int_a^\infty g(t)e^{-Mf(t)} dt \\ & \approx e^{-Mf(a)} \int_a^{a+\varepsilon} g(t)e^{-M(f(t)-f(a))} dt \\ & \approx e^{-Mf(a)} \int_a^{a+\varepsilon} \left[ g(a) + g^{(1)}(a)(t-a) + \frac{g^{(2)}(a)}{2}(t-a)^2 + \dots + \frac{g^{(L-2)}(a)}{(L-2)!}(t-a)^{L-2} + \frac{g^{(L-1)}(a)}{(L-1)!}(t-a)^{L-1} \right] \\ & \quad e^{-M([f(a)+f^{(1)}(a)(t-a)]-f(a))} dt \end{aligned} \tag{14}$$

$$= e^{-Mf(a)} \int_a^{a+\varepsilon} \frac{g^{(L-1)}(a)}{(L-1)!} (t-a)^{L-1} e^{-Mf^{(1)}(a)(t-a)} dt \tag{15}$$

$$\begin{aligned} & \approx e^{-Mf(a)} \frac{g^{(L-1)}(a)}{(L-1)!} \int_a^\infty (t-a)^{L-1} e^{-Mf^{(1)}(a)(t-a)} dt \\ & = e^{-Mf(a)} \frac{g^{(L-1)}(a)}{(L-1)!} \int_0^\infty \left( \frac{u}{Mf^{(1)}(a)} \right)^{L-1} e^{-u} (Mf^{(1)}(a))^{-1} du \end{aligned} \tag{16}$$

$$\begin{aligned} & = e^{-Mf(a)} \frac{g^{(L-1)}(a)}{(L-1)!} (Mf^{(1)}(a))^{-L} \int_0^\infty u^{L-1} e^{-u} du \\ & = e^{-Mf(a)} \frac{g^{(L-1)}(a)}{(L-1)!} (Mf^{(1)}(a))^{-L} \Gamma(L) \end{aligned} \tag{17}$$

$$= e^{-Mf(a)} \frac{g^{(L-1)}(a)}{(Mf^{(1)}(a))^L}. \tag{18}$$

In Equation (14), we take the  $(L-1)$ -st Taylor polynomial of  $g$  at  $a$  and the first Taylor polynomial of  $f$  at  $a$ . Equation (15) follows since, by the assumption, the first  $L-1$  terms of the Taylor polynomial of  $g$  vanish at  $a$ . In Equation (16), we let  $u = Mf^{(1)}(a)(t-a)$ . Equation (17) follows from the definition of Gamma function (Definition 2) and Equation (18) is because the Gamma function coincides with the factorial function at positive integer points.  $\square$

**Theorem 10** (Laplace's method). *Suppose  $f: \mathbb{R}^d \rightarrow \mathbb{R}$  is a twice continuously differentiable function on  $\mathcal{A} \subset \mathbb{R}^d$ , and there exists a unique point  $\vec{t}^* \in \text{int}(\mathcal{A})$  (where  $\text{int}(\cdot)$  denotes the interior of a set) such that*

$$f(\vec{t}^*) = \min_{\vec{t} \in \mathcal{A}} f(\vec{t}), \quad (\text{Hess } f)(\vec{t}^*) > 0.$$

Suppose  $g(\vec{t})$  is positive. Then

$$\int_{\mathcal{A}} g(\vec{t}) e^{-Mf(\vec{t})} d\vec{t} \stackrel{M \rightarrow \infty}{\asymp} e^{-Mf(\vec{t}^*)} \left( \frac{2\pi}{M} \right)^{d/2} \frac{g(\vec{t}^*)}{\sqrt{\det((\text{Hess } f)(\vec{t}^*))}}.$$

**Theorem 11** (Cramér). Let  $\{\mathbf{x}_i\}_{i=1}^n$  be a sequence of i.i.d. real-valued random variables. Let  $\mathbf{s}_n := \frac{1}{n} \sum_{i=1}^n \mathbf{x}_i$ . Then for any closed  $\mathcal{F} \subset \mathbb{R}$ ,

$$\limsup_{n \rightarrow \infty} \frac{1}{n} \ln \Pr[\mathbf{s}_n \in \mathcal{F}] \leq - \inf_{x \in \mathcal{F}} \sup_{\lambda \in \mathbb{R}} \left\{ \lambda x - \ln \mathbb{E} \left[ e^{\lambda \mathbf{x}_1} \right] \right\};$$

and for any open  $\mathcal{G} \subset \mathbb{R}$ ,

$$\liminf_{n \rightarrow \infty} \frac{1}{n} \ln \Pr[\mathbf{s}_n \in \mathcal{G}] \geq - \inf_{x \in \mathcal{G}} \sup_{\lambda \in \mathbb{R}} \left\{ \lambda x - \ln \mathbb{E} \left[ e^{\lambda \mathbf{x}_1} \right] \right\}.$$

Furthermore, when  $\mathcal{F}$  or  $\mathcal{G}$  corresponds to the upper (resp. lower) tail of  $\mathbf{s}_n$ , the maximizer  $\lambda \geq 0$  (resp.  $\lambda \leq 0$ ).

**Definition 2** (Gamma function). For any  $z \in \mathbb{C}$  with  $\Re(z) > 0$ , the Gamma function  $\Gamma(z)$  is defined as

$$\Gamma(z) := \int_0^{\infty} v^{z-1} e^{-v} dv.$$

**Theorem 12** (Stirling's approximation). The asymptotics of  $\Gamma(z+1)$  for large positive  $z$  is given by  $\Gamma(z+1) \asymp \sqrt{2\pi z} (z/e)^z$ .

**Lemma 13** (Gaussian integral). Let  $a > 0$  and  $b, c \in \mathbb{R}$ . We have

$$\int_{\mathbb{R}} e^{-ax^2+bx+c} dx = \sqrt{\frac{\pi}{a}} \cdot e^{\frac{b^2}{4a}+c}.$$

**Lemma 14** (Gaussian integral). Let  $A \in \mathbb{R}^{n \times n}$  be a positive-definite matrix. Then

$$\int_{\mathbb{R}^n} \exp(-\underline{x}^\top A \underline{x}) d\underline{x} = \sqrt{\frac{\pi^n}{\det(A)}}.$$

**Definition 3** (PPP). A homogeneous Poisson Point Process (PPP)  $\mathcal{C}$  in  $\mathbb{R}^n$  with intensity  $\lambda > 0$  is a point process satisfying the following two conditions.

1) For any bounded Borel set  $\mathcal{B} \subset \mathbb{R}^n$ ,  $|\mathcal{C} \cap \mathcal{B}| \sim \text{Pois}(\lambda|\mathcal{B}|)$ , that is,

$$\Pr[|\mathcal{C} \cap \mathcal{B}| = k] = e^{-\lambda|\mathcal{B}|} \frac{(\lambda|\mathcal{B}|)^k}{k!}$$

for any  $k \in \mathbb{Z}_{\geq 0}$ .

2) For any  $\ell \in \mathbb{Z}_{\geq 2}$  and any collection of  $\ell$  disjoint bounded Borel sets  $\mathcal{B}_1, \dots, \mathcal{B}_\ell \subset \mathbb{R}^n$ , the random variables  $|\mathcal{C} \cap \mathcal{B}_1|, \dots, |\mathcal{C} \cap \mathcal{B}_\ell|$  are independent, that is,

$$\Pr[\forall i \in [\ell], |\mathcal{C} \cap \mathcal{B}_i| = k_i] = \prod_{i=1}^{\ell} e^{-\lambda|\mathcal{B}_i|} \frac{(\lambda|\mathcal{B}_i|)^{k_i}}{k_i!}$$

for any  $k_1, \dots, k_\ell \in \mathbb{Z}_{\geq 0}$ .

*Remark 1.* All PPPs in this paper will be homogeneous, that is, the intensity is a constant and does not depend on the location of a point.

**Definition 4** (Intensity and factorial moment measure). Let  $\mathcal{C}$  be a point process in  $\mathbb{R}^n$ . The *intensity measure*  $\Lambda(\cdot)$  induced by  $\mathcal{C}$  is defined as the measure on  $\mathbb{R}^n$  satisfying  $\Lambda(\mathcal{B}) = \mathbb{E}[|\mathcal{C} \cap \mathcal{B}|]$  for any Borel set  $\mathcal{B} \subset \mathbb{R}^n$ . The *intensity field* (a.k.a. *intensity* for short)  $\lambda(\cdot)$  is the density of  $\Lambda(\cdot)$  (whenever exists), i.e.,

$$\Lambda(\mathcal{B}) = \int_{\mathcal{B}} \lambda(\underline{x}) d\underline{x}.$$



More generally, for any  $L \geq 1$ , the  $L$ -th factorial moment measure  $\Lambda^{(L)}(\cdot)$  induced by  $\mathcal{C}$  is defined as the measure on  $(\mathbb{R}^n)^L$  satisfying

$$\Lambda^{(L)}(\mathcal{B}_1 \times \cdots \times \mathcal{B}_L) = \mathbb{E} \left[ \sum_{\substack{(\underline{x}_1, \dots, \underline{x}_L) \in \mathcal{C}^L \\ \text{distinct}}} \prod_{i=1}^L \mathbb{1}_{\mathcal{B}_i}(\underline{x}_i) \right],$$

for any  $L$ -tuple of Borel sets  $\mathcal{B}_1, \dots, \mathcal{B}_L$  in  $\mathbb{R}^n$  (not necessarily disjoint). The  $L$ -th factorial moment density  $\lambda^{(L)}(\cdot, \dots, \cdot)$  is the density of  $\Lambda^{(L)}(\cdot)$  (whenever exists):

$$\Lambda^{(L)}(\mathcal{B}_1 \times \cdots \times \mathcal{B}_L) = \int_{\mathcal{B}_1} \cdots \int_{\mathcal{B}_L} \lambda^{(L)}(\underline{x}_1, \dots, \underline{x}_L) d\underline{x}_1 \cdots d\underline{x}_L.$$

Note that the first factorial moment measure/density coincides with the intensity measure/field.

**Fact 15.** For a homogeneous PPP with intensity  $\lambda$ , the  $L$ -th factorial moment measure  $\Lambda^{(L)}(\cdot)$  is given by

$$\Lambda^{(L)}(\mathcal{B}_1 \times \cdots \times \mathcal{B}_L) = \lambda^L \prod_{i=1}^L |\mathcal{B}_i|$$

and the  $L$ -th factorial moment density  $\lambda^{(L)}(\cdot, \dots, \cdot)$  is given by  $\lambda^{(L)}(\underline{x}_1, \dots, \underline{x}_L) = \lambda^L$ .

**Fact 16.** A homogeneous PPP  $\mathcal{C}$  satisfies the following properties.

- 1) A homogeneous PPP is stationary, i.e., invariant to translation.
- 2) A homogeneous PPP is isotropic, i.e., invariant to rotation.
- 3) For any box  $\mathcal{Q} := \prod_{i=1}^n (a_i, b_i]$  where  $a_i \leq b_i$  for all  $i \in [n]$ , the points in  $\mathcal{C} \cap \mathcal{Q}$  are independent and uniformly distributed in  $\mathcal{Q}$ , that is, the  $i$ -th ( $i \in [n]$ ) coordinate of any vector in  $\mathcal{C} \cap \mathcal{Q}$  is uniformly distributed in  $(a_i, b_i]$  and is independent of any other coordinates (in or not in the same vector).

**Definition 5** (Matérn process). A Matérn process  $\mathcal{C}'$  in  $\mathbb{R}^n$  with exclusion radius  $r > 0$  can be obtained from a PPP  $\mathcal{C}$  in  $\mathbb{R}^n$  with intensity  $\lambda$  by removing all pairs of points in  $\mathcal{C}$  with distance at most  $r$ . The intensity  $\lambda'$  of the resulting Matérn process  $\mathcal{C}'$  is given by  $\lambda' = \lambda e^{-\lambda |\mathcal{B}^n(r)|}$ .

**Theorem 17** (Campbell). For any  $L \in \mathbb{Z}_{\geq 1}$ , any point process  $\mathcal{C}$  on  $\mathbb{R}^n$  with  $L$ -th factorial moment measure  $\Lambda^{(L)}(\cdot)$  and any measurable function  $f: (\mathbb{R}^n)^L \rightarrow \mathbb{R}$ , the following equation holds

$$\mathbb{E} \left[ \sum_{\substack{(\underline{x}_1, \dots, \underline{x}_L) \in \mathcal{C}^L \\ \text{distinct}}} f(\underline{x}_1, \dots, \underline{x}_L) \right] = \int_{(\mathbb{R}^n)^L} f(\underline{x}_1, \dots, \underline{x}_L) \Lambda^{(L)}(d\underline{x}_1 \times \cdots \times d\underline{x}_L).$$

If  $\Lambda^{(L)}(\cdot)$  has a density  $\lambda^{(L)}(\cdot, \dots, \cdot)$ , then the equation becomes

$$\mathbb{E} \left[ \sum_{\substack{(\underline{x}_1, \dots, \underline{x}_L) \in \mathcal{C}^L \\ \text{distinct}}} f(\underline{x}_1, \dots, \underline{x}_L) \right] = \int_{\mathbb{R}^n} \cdots \int_{\mathbb{R}^n} f(\underline{x}_1, \dots, \underline{x}_L) \lambda^{(L)}(\underline{x}_1, \dots, \underline{x}_L) d\underline{x}_1 \cdots d\underline{x}_L.$$

**Theorem 18** (Slivnyak). Conditioned on a point (WLOG the origin, by *Item 1 of Fact 16*) in a homogeneous PPP, the distribution of the rest of the PPP (which is called the Palm distribution) is equal to that of the original PPP.

## VIII. BASIC DEFINITIONS AND FACTS

Given the intimate connection between packing and error-correcting code, we will interchangeably use the terms “multiple packing” and “list-decodable code”. The parameter  $L \in \mathbb{Z}_{\geq 2}$  is called the *multiplicity of overlap* or the *list-size*. The parameters  $N$  and  $P$  (in the case of bounded packing) are called the *input and noise power constraints*, respectively. Elements of a packing are called either *points* or *codewords*. We will call a size- $L$  subset of a packing an  $L$ -*list*. This paper is only concerned with the fundamental limits of multiple packing for asymptotically large dimension  $n \rightarrow \infty$ . When we say “a” code  $\mathcal{C}$ , we always mean an infinite sequence of codes  $\{\mathcal{C}_i\}_{i \geq 1}$  where  $\mathcal{C}_i \subset \mathbb{R}^{n_i}$

and  $\{n_i\}_{i \geq 1}$  is an increasing sequence of positive integers. We call  $\mathcal{C}$  a *spherical code* if  $\mathcal{C} \subset \mathcal{B}^n(\sqrt{nP})$  and we call it a *ball code* if  $\mathcal{C} \subset \mathcal{B}^n(\sqrt{nP})$ .

In the rest of this section, we list a sequence of formal definitions and some facts associated with these definitions.

**Definition 6** (Bounded multiple packing). Let  $N, P > 0$  and  $L \in \mathbb{Z}_{\geq 2}$ . A subset  $\mathcal{C} \subseteq \mathcal{B}^n(\sqrt{nP})$  is called a  $(P, N, L - 1)$ -*list-decodable code* (a.k.a. a  $(P, N, L - 1)$ -*multiple packing*) if for every  $\underline{y} \in \mathbb{R}^n$ ,

$$|\mathcal{C} \cap \mathcal{B}^n(\underline{y}, \sqrt{nN})| \leq L - 1. \quad (19)$$

The *rate* (a.k.a. *density*) of  $\mathcal{C}$  is defined as

$$R(\mathcal{C}) := \frac{1}{n} \ln |\mathcal{C}|. \quad (20)$$

**Definition 7** (Unbounded multiple packing). Let  $N > 0$  and  $L \in \mathbb{Z}_{\geq 2}$ . A subset  $\mathcal{C} \subseteq \mathbb{R}^n$  is called a  $(N, L - 1)$ -*list-decodable code* (a.k.a. an  $(N, L - 1)$ -*multiple packing*) if for every  $\underline{y} \in \mathbb{R}^n$ ,

$$|\mathcal{C} \cap \mathcal{B}^n(\underline{y}, \sqrt{nN})| \leq L - 1. \quad (21)$$

The *rate* (a.k.a. *density*) of  $\mathcal{C}$  is defined as

$$R(\mathcal{C}) := \limsup_{K \rightarrow \infty} \frac{1}{n} \ln \frac{|\mathcal{C} \cap (K\mathcal{B})|}{|K\mathcal{B}|}, \quad (22)$$

where  $\mathcal{B}$  is an arbitrary compact set in  $\mathbb{R}^n$  with nonempty interior. Common choices of  $\mathcal{B}$  include the unit ball  $\mathcal{B}^n$ , the unit cube  $[-1, 1]^n$ , the fundamental Voronoi region  $\mathcal{V}_\Lambda$  of a (full-rank) lattice  $\Lambda \subset \mathbb{R}^n$ , etc.

*Remark 2.* It is a slight abuse of notation to write  $R(\mathcal{C})$  to refer to the rate of either a bounded packing or an unbounded packing. However, the meaning of  $R(\mathcal{C})$  will be clear from the context. The rate of an unbounded packing (as per Equation (22)) is also called the *normalized logarithmic density* in the literature. It measures the rate (w.r.t. Equation (20)) per unit volume.

Note that the condition given by Equations (19) and (21) is equivalent to that for any  $(\underline{x}_1, \dots, \underline{x}_L) \in \binom{\mathcal{C}}{L}$ ,

$$\bigcap_{i=1}^L \mathcal{B}^n(\underline{x}_i, \sqrt{nN}) = \emptyset. \quad (23)$$

**Definition 8** (Chebyshev radius and average radius of a list). Let  $\underline{x}_1, \dots, \underline{x}_L$  be  $L$  points in  $\mathbb{R}^n$ . Then the *Chebyshev radius*  $\text{rad}(\underline{x}_1, \dots, \underline{x}_L)$  of  $\underline{x}_1, \dots, \underline{x}_L$  is defined as the (squared) radius of the smallest ball containing  $\underline{x}_1, \dots, \underline{x}_L$ , i.e.,

$$\text{rad}(\underline{x}_1, \dots, \underline{x}_L) := \min_{\underline{y} \in \mathbb{R}^n} \max_{i \in [L]} \|\underline{x}_i - \underline{y}\|_2^2. \quad (24)$$

The *average radius*  $\overline{\text{rad}}(\underline{x}_1, \dots, \underline{x}_L)$  of  $\underline{x}_1, \dots, \underline{x}_L$  is defined as the average distance to the centroid, i.e.,

$$\overline{\text{rad}}(\underline{x}_1, \dots, \underline{x}_L) := \frac{1}{L} \sum_{i=1}^L \|\underline{x}_i - \underline{x}\|_2^2, \quad (25)$$

where  $\underline{x} := \frac{1}{L} \sum_{i=1}^L \underline{x}_i$  is the centroid of  $\underline{x}_1, \dots, \underline{x}_L$ .

*Remark 3.* One should note that for an  $L$ -list  $\mathcal{L}$  of points, the smallest ball containing  $\mathcal{L}$  is not necessarily the same as the *circumscribed ball*, i.e., the ball such that all points in  $\mathcal{L}$  live on the boundary of the ball. The circumscribed ball of the polytope  $\text{conv}\{\mathcal{L}\}$  spanned by the points in  $\mathcal{L}$  may not exist. If it does exist, it is not necessarily the smallest one containing  $\mathcal{L}$ . However, whenever it exists, the smallest ball containing  $\mathcal{L}$  must be the circumscribed ball of a certain *subset* of  $\mathcal{L}$ .

*Remark 4.* We remark that the motivation behind the definition of average radius (Equation (25)) is to replace the maximization in Equation (24) with average.

$$\min_{\underline{y} \in \mathbb{R}^n} \mathbb{E}_{\mathbf{i} \sim [L]} \left[ \|\underline{x}_i - \underline{y}\|_2^2 \right] = \min_{\underline{y} \in \mathbb{R}^n} \frac{1}{L} \sum_{i=1}^L \sum_{j=1}^n (\underline{x}_i(j) - \underline{y}(j))^2$$

$$= \min_{(y_1, \dots, y_n) \in \mathbb{R}^n} \sum_{j=1}^n \frac{1}{L} \sum_{i=1}^L (x_i(j) - y_j)^2 \quad (26)$$

$$= \sum_{j=1}^n \min_{y_j \in \mathbb{R}} \frac{1}{L} \sum_{i=1}^L (x_i(j) - y_j)^2 \quad (27)$$

$$= \frac{1}{L} \sum_{i=1}^L \sum_{j=1}^n (x_i(j) - y_j^*)^2 \quad (28)$$

$$= \frac{1}{L} \sum_{i=1}^L \|\underline{x}_i - \underline{x}\|_2^2. \quad (29)$$

Equation (27) holds since the inner summation  $\frac{1}{L} \sum_{i=1}^L (x_i(j) - y_j)^2$  in Equation (26) only depends on  $y_j$  among all  $y_1, \dots, y_n$ . Equation (28) follows since for each  $j$ , the minimizer of the minimization in Equation (27) is  $y_j^* := \frac{1}{L} \sum_{i=1}^L x_i(j)$ . In Equation (29), the minimizer  $\underline{y}^*$  equals  $\underline{x} := \frac{1}{L} \sum_{i=1}^L \underline{x}_i$ .

**Definition 9** (Chebyshev radius and average radius of a code). Given a code  $\mathcal{C} \subset \mathbb{R}^n$  of rate  $R$ , the  $(L-1)$ -list-decoding radius of  $\mathcal{C}$  is defined as

$$\text{rad}_L(\mathcal{C}) := \min_{\mathcal{L} \in \binom{\mathcal{C}}{L}} \text{rad}(\mathcal{L}). \quad (30)$$

The  $(L-1)$ -average radius of  $\mathcal{C}$  is defined as

$$\overline{\text{rad}}_L(\mathcal{C}) := \min_{\mathcal{L} \in \binom{\mathcal{C}}{L}} \overline{\text{rad}}(\mathcal{L}). \quad (31)$$

**Definition 10** (Bounded average-radius multiple packing). A subset  $\mathcal{C} \subset \mathcal{B}^n(\sqrt{nP})$  is called a  $(P, N, L-1)$ -average-radius list-decodable code (a.k.a. a  $(P, N, L-1)$ -average-radius multiple packing) if  $\overline{\text{rad}}_L(\mathcal{C}) > nN$ . The rate (a.k.a. density)  $R(\mathcal{C})$  of  $\mathcal{C}$  is given by Equation (20). The  $(P, N, L-1)$ -average-radius list-decoding capacity (a.k.a.  $(P, N, L-1)$  average-radius multiple packing density) is defined as

$$\overline{C}_{L-1}(P, N) := \limsup_{n \rightarrow \infty} \limsup_{\mathcal{C} \subseteq \mathcal{B}^n(\sqrt{nP}) : \overline{\text{rad}}_L(\mathcal{C}) > nN} R(\mathcal{C}).$$

The  $(L-1)$ -average-radius list-decoding radius at rate  $R$  with input constraint  $P$  is defined as

$$\overline{\text{rad}}_L(P, R) := \limsup_{n \rightarrow \infty} \limsup_{\mathcal{C} \subseteq \mathcal{B}^n(\sqrt{nP}) : R(\mathcal{C}) \geq R} \overline{\text{rad}}_L(\mathcal{C}).$$

**Definition 11** (Unbounded average-radius multiple packing). A subset  $\mathcal{C} \subset \mathbb{R}^n$  is called an  $(N, L-1)$ -average-radius list-decodable code (a.k.a. an  $(N, L-1)$ -average-radius multiple packing) if  $\overline{\text{rad}}_L(\mathcal{C}) > nN$ . The rate (a.k.a. density)  $R(\mathcal{C})$  of  $\mathcal{C}$  is given by Equation (22). The  $(N, L-1)$ -average-radius list-decoding capacity (a.k.a.  $(N, L-1)$  average-radius multiple packing density) is defined as

$$\overline{C}_{L-1}(N) := \limsup_{n \rightarrow \infty} \limsup_{\mathcal{C} \subseteq \mathbb{R}^n : \overline{\text{rad}}_L(\mathcal{C}) > nN} R(\mathcal{C}).$$

The  $(L-1)$ -average-radius list-decoding radius at rate  $R$  (without input constraint) is defined as

$$\overline{\text{rad}}_L(R) := \limsup_{n \rightarrow \infty} \limsup_{\mathcal{C} \subseteq \mathbb{R}^n : R(\mathcal{C}) \geq R} \overline{\text{rad}}_L(\mathcal{C}).$$

Note that  $(L-1)$ -list-decodability defined by Equation (19) or Equation (23) is equivalent to  $\text{rad}_L(\mathcal{C}) > nN$ . Since the average radius is at most the Chebyshev radius, average-radius list-decodability is stronger than regular list-decodability.

We also define the  $(P, N, L-1)$ -list-decoding capacity (a.k.a.  $(P, N, L-1)$ -multiple packing density)

$$C_{L-1}(P, N) := \limsup_{n \rightarrow \infty} \limsup_{\mathcal{C} \subseteq \mathcal{B}^n(\sqrt{nP}) : \text{rad}_L(\mathcal{C}) > nN} R(\mathcal{C}),$$

and the  $(L - 1)$ -list-decoding radius at rate  $R$  with input constraint  $P$

$$\text{rad}_L(P, R) := \limsup_{n \rightarrow \infty} \limsup_{\mathcal{C} \subseteq \mathcal{B}^n(\sqrt{nP}) : R(\mathcal{C}) \geq R} \text{rad}_L(\mathcal{C}).$$

Any lower (resp. upper) bound on  $\overline{C}_{L-1}(P, N)$  (resp.  $C_{L-1}(P, N)$ ) is automatically a lower (resp. upper) bound on  $C_{L-1}(P, N)$  (resp.  $\overline{C}_{L-1}(P, N)$ ). The same relation also holds for the unbounded versions  $C_{L-1}(N)$  and  $\overline{C}_{L-1}(N)$ . Proving upper/lower bounds on  $C_{L-1}(P, N)$  (resp.  $\overline{C}_{L-1}(P, N)$ ) is equivalent to proving upper/lower bounds on  $\text{rad}_L(P, R)$  (resp.  $\overline{\text{rad}}_L(P, R)$ ). The same relation also holds for the unbounded versions  $C_{L-1}(N)$  (resp.  $\overline{C}_{L-1}(N)$ ) and  $\text{rad}_L(R)$  (resp.  $\overline{\text{rad}}_L(R)$ ).

#### A. Different notions of density of unbounded packings

We measure the density of an unbounded packing using Equation (22). In the literature, there exists another commonly used notion of density for unbounded packings. It counts the fraction of space occupied by the union of the balls of radius  $\sqrt{nN}$  centered around points in the packing. Specifically, for an  $(N, L - 1)$ -packing  $\mathcal{C} \subset \mathbb{R}^n$ ,

$$\Delta(\mathcal{C}) := \limsup_{P \rightarrow \infty} \frac{1}{n} \ln \left( \left| \bigcup_{\underline{x} \in \mathcal{C}} \mathcal{B}^n(\underline{x}, \sqrt{nN}) \cap \mathcal{B}^n(\sqrt{nP}) \right| / \left| \mathcal{B}^n(\sqrt{nP}) \right| \right). \quad (32)$$

We prove the following statement.

**Theorem 19.** *Let  $N > 0$  and  $L \in \mathbb{Z}_{\geq 2}$ . Let  $\mathcal{C} \subset \mathbb{R}^n$  be an  $(N, L - 1)$ -multiple packing. Then  $\Delta(\mathcal{C}) \asymp R(\mathcal{C}) + \frac{1}{2} \ln(2\pi eN)$ .*

*Proof.* Note that for sufficiently large  $P$ ,

$$\left| \bigcup_{\underline{x} \in \mathcal{C}} \mathcal{B}^n(\underline{x}, \sqrt{nN}) \cap \mathcal{B}^n(\sqrt{nP}) \right| \lesssim \left| \mathcal{C} \cap \mathcal{B}^n(\sqrt{nP}) \right| \cdot \left| \mathcal{B}^n(\sqrt{nN}) \right|.$$

Therefore,

$$\begin{aligned} \Delta(\mathcal{C}) &\leq \limsup_{P \rightarrow \infty} \frac{1}{n} \ln \frac{\left| \mathcal{C} \cap \mathcal{B}^n(\sqrt{nP}) \right| \cdot \left| \mathcal{B}^n(\sqrt{nN}) \right|}{\left| \mathcal{B}^n(\sqrt{nP}) \right|} \\ &= R(\mathcal{C}) + \frac{1}{n} \ln \left| \mathcal{B}^n(\sqrt{nN}) \right| \\ &\asymp R(\mathcal{C}) + \frac{1}{n} \ln \left( \sqrt{nN}^n \cdot \frac{1}{\sqrt{\pi n}} \sqrt{\frac{2\pi e^n}{n}} \right) \\ &\asymp R(\mathcal{C}) + \frac{1}{2} \ln(2\pi eN). \end{aligned} \quad (33)$$

On the other hand, we claim that for sufficiently large  $P$ ,

$$\left| \bigcup_{\underline{x} \in \mathcal{C}} \mathcal{B}^n(\underline{x}, \sqrt{nN}) \cap \mathcal{B}^n(\sqrt{nP}) \right| \gtrsim \frac{1}{L-1} \left| \mathcal{C} \cap \mathcal{B}^n(\sqrt{nP}) \right| \cdot \left| \mathcal{B}^n(\sqrt{nN}) \right|. \quad (34)$$

The above claim is justified at the end of this subsection. Then following the same lines of calculations above, we have

$$\Delta(\mathcal{C}) \geq R(\mathcal{C}) + \frac{1}{2} \ln(2\pi eN) - o(1). \quad (35)$$

Combining Equations (33) and (35), we have that for any  $(N, L - 1)$ -packing  $\mathcal{C}$ ,

$$\Delta(\mathcal{C}) \asymp R(\mathcal{C}) + \frac{1}{2} \ln(2\pi eN).$$

To see Equation (34), consider the set of convex sets

$$\mathcal{D} := \left\{ \mathcal{D}(\underline{x}) : \underline{x} \in \mathcal{C}, \mathcal{B}^n(\underline{x}, \sqrt{nN}) \cap \mathcal{B}^n(\sqrt{nP}) \neq \emptyset \right\},$$

where

$$\mathcal{D}(\underline{x}) := \mathcal{B}^n(\underline{x}, \sqrt{nN}) \cap \mathcal{B}^n(\sqrt{nP}).$$

Note that some elements in  $\mathcal{D}$  are balls  $\mathcal{B}^n(\underline{x}, \sqrt{nN})$ , while other elements are the intersection of two balls  $\mathcal{B}^n(\underline{x}, \sqrt{nN}) \cap \mathcal{B}^n(\sqrt{nP})$  for some  $\underline{x} \in \mathcal{C}$ .

We now rearrange all  $\mathcal{D}(\underline{x})$  in  $\mathcal{D}$  so that they become disjoint. Then the volume induced by the resulting packing is

$$\begin{aligned} \sum_{\mathcal{D} \in \mathcal{D}} |\mathcal{D}| &= \sum_{\substack{\underline{x} \in \mathcal{C} \\ \mathcal{B}^n(\underline{x}, \sqrt{nN}) \cap \mathcal{B}^n(\sqrt{nP}) \neq \emptyset}} |\mathcal{D}(\underline{x})| \\ &\approx \sum_{\underline{x} \in \mathcal{C} \cap \mathcal{B}^n(\sqrt{nP})} |\mathcal{D}(\underline{x})| \\ &= \sum_{\underline{x} \in \mathcal{C} \cap \mathcal{B}^n(\sqrt{nP})} \left| \mathcal{B}^n(\underline{x}, \sqrt{nN}) \cap \mathcal{B}^n(\sqrt{nP}) \right|. \end{aligned} \quad (36)$$

On the other hand, for any  $\underline{y} \in \bigcup_{\mathcal{D} \in \mathcal{D}} \mathcal{D}$ , it can split into at most  $L - 1$  points after the above process since by  $(L - 1)$ -list-decodability, each point in a ball is covered by at most  $L - 2$  other balls. Therefore, the volume induced by the rearranged packing is at most

$$(L - 1) \left| \bigcup_{\mathcal{D} \in \mathcal{D}} \mathcal{D} \right| = (L - 1) \left| \bigcup_{\underline{x} \in \mathcal{C}} \mathcal{B}^n(\underline{x}, \sqrt{nN}) \cap \mathcal{B}^n(\sqrt{nP}) \right|. \quad (37)$$

Combining [Equations \(36\) and \(37\)](#), we have, for sufficiently large  $P$ ,

$$\begin{aligned} \left| \bigcup_{\underline{x} \in \mathcal{C}} \mathcal{B}^n(\underline{x}, \sqrt{nN}) \cap \mathcal{B}^n(\sqrt{nP}) \right| &\geq \frac{1}{L - 1} \sum_{\underline{x} \in \mathcal{C} \cap \mathcal{B}^n(\sqrt{nP})} \left| \mathcal{B}^n(\underline{x}, \sqrt{nN}) \cap \mathcal{B}^n(\sqrt{nP}) \right| \\ &\approx \frac{1}{L - 1} \left| \mathcal{C} \cap \mathcal{B}^n(\sqrt{nP}) \right| \left| \mathcal{B}^n(\sqrt{nN}) \right|, \end{aligned}$$

as claimed in [Equation \(34\)](#). □

### B. Density of bounded and unbounded packings

In general (not only for multiple packing), it is customary to measure the density of a bounded constellation using [Equation \(20\)](#) while to measure that of an unbounded constellation using [Equation \(22\)](#). Informally, we expect them to be related to each other in the following way. Let  $\mathcal{C}_P$  be a constellation in  $\mathcal{B}^n(\sqrt{nP})$ . Let  $\mathcal{C} := \lim_{P \rightarrow \infty} \mathcal{C}_P$ . Then

$$\begin{aligned} R(\mathcal{C}) &= \limsup_{P \rightarrow \infty} \frac{1}{n} \ln \frac{|\mathcal{C} \cap \mathcal{B}^n(\sqrt{nP})|}{|\mathcal{B}^n(\sqrt{nP})|} \\ &= \limsup_{P \rightarrow \infty} \frac{1}{n} \ln \frac{|\mathcal{C}_P|}{|\mathcal{B}^n(\sqrt{nP})|} \\ &= \limsup_{P \rightarrow \infty} \left( R(\mathcal{C}_P) - \frac{1}{n} \ln |\mathcal{B}^n(\sqrt{nP})| \right) \\ &\asymp \limsup_{P \rightarrow \infty} \left( R(\mathcal{C}_P) - \frac{1}{n} \ln \left( \sqrt{nP}^n \cdot \frac{1}{\sqrt{\pi n}} \sqrt{\frac{2\pi e^n}{n}} \right) \right) \\ &\asymp \limsup_{P \rightarrow \infty} \left( R(\mathcal{C}_P) - \frac{1}{2} \ln(2\pi eP) \right). \end{aligned} \quad (38)$$

Suppose that for a certain problem without input constraint, the optimal density  $R^*(\mathcal{C}^*)$  is achieved by an unbounded constellation  $\mathcal{C}^*$ , while for the same problem with input constraint  $P$ , the corresponding optimal density  $R^*(\mathcal{C}_P^*)$  is

achieved by a bounded constellation  $C_P^*$ . The above relation between  $R^*(C^*)$  and  $R^*(C_P^*)$  given by Equation (38) is empirically correct for some problems. However, the reasoning is not exactly rigorous since the bounded constellation  $C_P^*$  may not converge to an unbounded constellation as  $P$  approaches infinity.

Let us look at some examples to justify the above comments. For the multiple packing problem with asymptotically large  $L$ , the capacity without input constraint is known to be  $\frac{1}{2} \ln \frac{P}{N}$  [ZVJS18] whereas the capacity with input constraint  $P$  equals  $\frac{1}{2} \ln \frac{1}{2\pi e N}$  [ZV19]. These two quantities indeed satisfy the relation given by Equation (38).

For the channel coding problem over an AWGN channel, the capacity without input constraint is  $\frac{1}{2} \ln \frac{1}{2\pi e N}$  whereas the capacity with input constraint  $P$  equals  $\frac{1}{2} \ln(1 + \frac{P}{N})$ . It still holds that

$$\lim_{P \rightarrow \infty} \left( \frac{1}{2} \ln \left( 1 + \frac{P}{N} \right) - \frac{1}{2} \ln(2\pi e P) \right) = \lim_{P \rightarrow \infty} \frac{1}{2} \ln \left( \frac{1}{2\pi e N} + \frac{1}{2\pi e P} \right) = \frac{1}{2} \ln \frac{1}{2\pi e N}.$$

However, from this example, we see that one cannot rearrange both sides of Equation (38) and claim that for any  $P$ ,

$$R(C_P) \asymp R(C) + \frac{1}{2} \ln(2\pi e P).$$

### C. Chebyshev radius and average radius

In this section, we present several different representations of the Chebyshev radius and average radius. Some of them will be crucially used in the subsequent sections of this paper. These representations are summarized in the following theorem which will be proved in the subsequent subsections.

**Theorem 20.** *Let  $L \in \mathbb{Z}_{\geq 2}$  and  $\underline{x}_1, \dots, \underline{x}_L \in \mathbb{R}^n$ . Then the Chebyshev radius of  $\underline{x}_1, \dots, \underline{x}_L$  admits the following alternative representations:*

$$\text{rad}(\underline{x}_1, \dots, \underline{x}_L) = \max_{\underline{z} \in \Delta_L} \sum_{i=1}^L \tilde{z}(i) \left\| \underline{x}_i - \underline{y}_{\underline{z}} \right\|_2^2,$$

where  $\underline{y}_{\underline{z}} := \sum_{i=1}^L \tilde{z}(i) \underline{x}_i$ ;

$$\text{rad}(\underline{x}_1, \dots, \underline{x}_L) = \lim_{p \rightarrow \infty} \text{rad}^{(p)}(\underline{x}_1, \dots, \underline{x}_L),$$

where

$$\text{rad}^{(p)}(\underline{x}_1, \dots, \underline{x}_L) := \left( \min_{\underline{y} \in \mathbb{R}^n} \frac{1}{L} \sum_{i=1}^L \left\| \underline{x}_i - \underline{y} \right\|_2^{2p} \right)^{1/p};$$

there exists a unique  $1 \leq q \leq \infty$  depending on  $\underline{x}_1, \dots, \underline{x}_L$  such that

$$\text{rad}(\underline{x}_1, \dots, \underline{x}_L) = \left( \frac{1}{L} \sum_{i=1}^L \left\| \underline{x}_i - \underline{x} \right\|_2^{2q} \right)^{1/q},$$

and  $\underline{x} := \frac{1}{L} \sum_{i=1}^L \underline{x}_i$ .

The average radius of  $\underline{x}_1, \dots, \underline{x}_L$  admits the following alternative representations:

$$\begin{aligned} \overline{\text{rad}}(\underline{x}_1, \dots, \underline{x}_L) &= \frac{1}{L} \sum_{i=1}^L \left\| \underline{x}_i \right\|_2^2 - \left\| \underline{x} \right\|_2^2 \\ &= \frac{L-1}{L^2} \sum_{i=1}^L \left\| \underline{x}_i \right\|_2^2 - \frac{1}{L^2} \sum_{(i,j) \in [L]^2: i \neq j} \langle \underline{x}_i, \underline{x}_j \rangle \\ &= \frac{1}{2L^2} \sum_{(i,j) \in [L]^2: i \neq j} \left\| \underline{x}_i - \underline{x}_j \right\|_2^2. \end{aligned}$$

1) *Another representation of the Chebyshev radius:* The Chebyshev radius involves a minimax expression which is in general tricky to handle. One can use minimax theorem to interchange the min and max and then compute the inner min explicitly.

$$\text{rad}(\underline{x}_1, \dots, \underline{x}_L) = \min_{\underline{y} \in \mathbb{R}^n} \max_{i \in [L]} \|\underline{x}_i - \underline{y}\|_2^2 = \min_{\underline{y} \in \mathbb{R}^n} \max_{\underline{z} \in \Delta_L} \sum_{i=1}^L \bar{z}(i) \|\underline{x}_i - \underline{y}\|_2^2.$$

In the last equality, we use  $\Delta_L$  to denote the probability simplex on  $[L]$ . This equality follows since the maximum is always achieved by a singleton  $\bar{z} \in \{0, 1\}^L$ . Note that the objective function on the RHS is linear (hence concave) in  $\bar{z}$  and quadratic (hence convex) in  $\underline{y}$ . Therefore the max and min can be interchanged and we get

$$\max_{\bar{z} \in \Delta_L} \min_{\underline{y} \in \mathbb{R}^n} \sum_{i=1}^L \bar{z}(i) \|\underline{x}_i - \underline{y}\|_2^2 = \max_{\bar{z} \in \Delta_L} \min_{\underline{y} \in \mathbb{R}^n} \sum_{j=1}^n \sum_{i=1}^L \bar{z}(i) (\underline{x}_i(j) - \underline{y}(j))^2 = \max_{\bar{z} \in \Delta_L} \sum_{j=1}^n \min_{\underline{y}_j \in \mathbb{R}} \sum_{i=1}^L \bar{z}(i) (\underline{x}_i(j) - \underline{y}_j)^2.$$

The last equality follows since each inner summation  $\sum_{i=1}^L \bar{z}(i) (\underline{x}_i(j) - \underline{y}(j))^2$  only depends on  $\underline{y}(j)$  among all  $\underline{y}(1), \dots, \underline{y}(n)$ . For each  $j$ , the minimizing  $\underline{y}_j^*$  equals

$$\underline{y}_j^* := \frac{\sum_{i=1}^L \bar{z}(i) \underline{x}_i(j)}{\sum_{i=1}^L \bar{z}(i)} = \sum_{i=1}^L \bar{z}(i) \underline{x}_i(j),$$

where the last equality is because  $\bar{z} \in \Delta_L$ . Therefore

$$\text{rad}(\underline{x}_1, \dots, \underline{x}_L) = \max_{\bar{z} \in \Delta_L} \sum_{i=1}^L \bar{z}(i) \|\underline{x}_i - \underline{y}_{\bar{z}}\|_2^2, \quad (39)$$

where  $\underline{y}_{\bar{z}} := \sum_{i=1}^L \bar{z}(i) \underline{x}_i$ .

2) *Higher-order approximations to the Chebyshev radius:* As explained in [Remark 4](#), the average radius is a linear relaxation of the Chebyshev radius:

$$\overline{\text{rad}}(\underline{x}_1, \dots, \underline{x}_L) = \min_{\underline{y} \in \mathbb{R}^n} \mathbb{E}_{i \sim [L]} \left[ \|\underline{x}_i - \underline{y}\|_2^2 \right]. \quad (40)$$

One may obtain better and better approximations to the Chebyshev radius by taking higher and higher order relaxations:

$$\text{rad}^{(p)}(\underline{x}_1, \dots, \underline{x}_L) = \min_{\underline{y} \in \mathbb{R}^n} \left( \mathbb{E}_{i \sim [L]} \left[ \|\underline{x}_i - \underline{y}\|_2^{2p} \right] \right)^{1/p} = \left( \min_{\underline{y} \in \mathbb{R}^n} \mathbb{E}_{i \sim [L]} \left[ \|\underline{x}_i - \underline{y}\|_2^{2p} \right] \right)^{1/p}, \quad (41)$$

where  $p \geq 1$ . The second equality in [Equation \(41\)](#) follows since the  $f(\cdot) = (\cdot)^{1/p}$  is monotonically increasing. Note that  $\text{rad}^{(1)}(\underline{x}_1, \dots, \underline{x}_L) = \overline{\text{rad}}(\underline{x}_1, \dots, \underline{x}_L)$ . Moreover, since  $\mathbb{E}[(\cdot)^p]^{1/p}$  is increasing in  $p$ , we have

$$\text{rad}^{(p)}(\underline{x}_1, \dots, \underline{x}_L) \xrightarrow{p \rightarrow \infty} \text{rad}(\underline{x}_1, \dots, \underline{x}_L).$$

However, we do not know how to analyze  $\text{rad}^{(p)}$ . It seems difficult to get a closed-form solution of the minimization since the minimizer  $\underline{y}^*$  cannot be obtained by minimizing over  $\underline{y}(j)$  for different  $j \in [n]$  separately.

3) *More representations of the average radius:* Recall that [Equation \(40\)](#), as a lower bound on  $\text{rad}(\underline{x}_1, \dots, \underline{x}_L)$ , admits an explicit formula given by [Equation \(29\)](#):

$$\text{rad}(\underline{x}_1, \dots, \underline{x}_L) \geq \overline{\text{rad}}(\underline{x}_1, \dots, \underline{x}_L) = \frac{1}{L} \sum_{i=1}^L \|\underline{x}_i - \underline{x}\|_2^2, \quad (42)$$

where  $\underline{x} := \frac{1}{L} \sum_{i=1}^L \underline{x}_i$  denotes the centroid of  $\underline{x}_1, \dots, \underline{x}_L$ . On the other hand, we have

$$\text{rad}(\underline{x}_1, \dots, \underline{x}_L) = \min_{\underline{y} \in \mathbb{R}^n} \max_{i \in [L]} \|\underline{x}_i - \underline{y}\|_2^2 \leq \max_{i \in [L]} \|\underline{x}_i - \underline{x}\|_2^2 =: \text{rad}_{\max}(\underline{x}_1, \dots, \underline{x}_L). \quad (43)$$



Contrasting [Equations \(42\)](#) and [\(43\)](#), by monotonicity and continuity of  $\|\cdot\|_p$  in  $p$ , we know that there exists  $1 \leq p \leq \infty$  such that

$$\text{rad}(\underline{x}_1, \dots, \underline{x}_L) = \left( \frac{1}{L} \sum_{i=1}^L \|\underline{x}_i - \underline{x}\|_2^{2p} \right)^{1/p}.$$

However, we do not know how to use the above observation for the following two reasons. Firstly, the above expression seems tricky to handle. Secondly and more importantly, the number  $p$  depends on  $\underline{x}_1, \dots, \underline{x}_L$  and is typically different for different lists.

Finally, we provide several alternative expressions for  $\overline{\text{rad}}(\underline{x}_1, \dots, \underline{x}_L)$  which will be useful in the proceeding sections of this paper.

$$\begin{aligned} \overline{\text{rad}}(\underline{x}_1, \dots, \underline{x}_L) &= \frac{1}{L} \sum_{i=1}^L \|\underline{x}_i - \underline{x}\|_2^2 \\ &= \frac{1}{L} \sum_{i=1}^L \langle \underline{x}_i - \underline{x}, \underline{x}_i - \underline{x} \rangle \\ &= \frac{1}{L} \sum_{i=1}^L \left( \|\underline{x}_i\|_2^2 - 2\langle \underline{x}_i, \underline{x} \rangle + \|\underline{x}\|_2^2 \right) \\ &= \frac{1}{L} \sum_{i=1}^L \|\underline{x}_i\|_2^2 - 2\langle \underline{x}, \underline{x} \rangle + \|\underline{x}\|_2^2 \\ &= \frac{1}{L} \sum_{i=1}^L \|\underline{x}_i\|_2^2 - \|\underline{x}\|_2^2. \end{aligned} \tag{44}$$

The above expression can be further written as

$$\begin{aligned} \overline{\text{rad}}(\underline{x}_1, \dots, \underline{x}_L) &= \frac{1}{L} \sum_{i=1}^L \|\underline{x}_i\|_2^2 - \|\underline{x}\|_2^2 \\ &= \frac{1}{L} \sum_{i=1}^L \|\underline{x}_i\|_2^2 - \frac{1}{L^2} \sum_{(i,j) \in [L]^2} \langle \underline{x}_i, \underline{x}_j \rangle \\ &= \frac{1}{L} \sum_{i=1}^L \|\underline{x}_i\|_2^2 - \frac{1}{L^2} \sum_{i=1}^L \|\underline{x}_i\|_2^2 - \frac{1}{L^2} \sum_{(i,j) \in [L]^2: i \neq j} \langle \underline{x}_i, \underline{x}_j \rangle \\ &= \frac{L-1}{L^2} \sum_{i=1}^L \|\underline{x}_i\|_2^2 - \frac{1}{L^2} \sum_{(i,j) \in [L]^2: i \neq j} \langle \underline{x}_i, \underline{x}_j \rangle. \end{aligned} \tag{45}$$

At last, [Equation \(45\)](#) can in turn be rewritten as

$$\begin{aligned} \overline{\text{rad}}(\underline{x}_1, \dots, \underline{x}_L) &= \frac{L-1}{L^2} \sum_{i=1}^L \|\underline{x}_i\|_2^2 - \frac{1}{L^2} \sum_{(i,j) \in [L]^2: i \neq j} \langle \underline{x}_i, \underline{x}_j \rangle \\ &= \frac{L-1}{L^2} \sum_{i=1}^L \|\underline{x}_i\|_2^2 - \frac{1}{2L^2} \sum_{(i,j) \in [L]^2: i \neq j} \left( \|\underline{x}_i\|_2^2 + \|\underline{x}_j\|_2^2 \right) + \frac{1}{2L^2} \sum_{(i,j) \in [L]^2: i \neq j} \left( \|\underline{x}_i\|_2^2 + \|\underline{x}_j\|_2^2 - 2\langle \underline{x}_i, \underline{x}_j \rangle \right) \\ &= \frac{L-1}{L^2} \sum_{i=1}^L \|\underline{x}_i\|_2^2 - \frac{1}{L^2} \sum_{(i,j) \in [L]^2: i \neq j} \|\underline{x}_i\|_2^2 + \frac{1}{2L^2} \sum_{(i,j) \in [L]^2: i \neq j} \|\underline{x}_i - \underline{x}_j\|_2^2 \\ &= \frac{1}{2L^2} \sum_{(i,j) \in [L]^2: i \neq j} \|\underline{x}_i - \underline{x}_j\|_2^2. \end{aligned} \tag{46}$$

If all  $\underline{x}_1, \dots, \underline{x}_L$  have the same  $\ell_2$  norm  $\sqrt{nP}$ , then [Equation \(44\)](#)

$$\overline{\text{rad}}(\underline{x}_1, \dots, \underline{x}_L) = nP - \|\underline{x}\|_2^2. \quad (47)$$

and [Equation \(45\)](#) becomes

$$\overline{\text{rad}}(\underline{x}_1, \dots, \underline{x}_L) = \frac{L-1}{L}nP - \frac{1}{L^2} \sum_{(i,j) \in [L]^2: i \neq j} \langle \underline{x}_i, \underline{x}_j \rangle. \quad (48)$$

#### D. Reduction from ball codes to spherical codes

We show that  $C_{L-1}(P, N)$  can be achieved using spherical codes.

**Theorem 21.** *Let  $N, P > 0$  and  $L \in \mathbb{Z}_{\geq 2}$ . If there is a  $(P, N, L-1)$ -list-decodable code  $\mathcal{C} \subset \mathcal{B}^n(\sqrt{nP})$  of rate  $R$ , then there must exist a  $(P, \frac{nN}{N+1}, L-1)$ -list-decodable code  $\mathcal{C} \subset \mathcal{S}^n(\vec{0}, \sqrt{(n+1)P})^3$  of rate  $R$ .*

*Proof.* Let  $\mathcal{C} \subset \mathcal{B}^n(\sqrt{nP})$  be a  $(P, N, L-1)$ -list-decodable ball code whose codewords may not necessarily have the same norm. We will turn  $\mathcal{C}$  into a  $(P, N', L-1)$ -list-decodable spherical code  $\mathcal{C}' \subset \mathcal{S}^n(\vec{0}, \sqrt{(n+1)P})$  for some  $N' \xrightarrow{n \rightarrow \infty} N$ . We will append one more coordinate to each codeword in  $\mathcal{C}$  in such a way that the augmented codeword of length  $n+1$  has norm exactly  $\sqrt{(n+1)P}$ . The collection of augmented codewords obtained from  $\mathcal{C}$  is denoted by  $\mathcal{C}'$ . Specifically, for a codeword  $\underline{x} \in \mathcal{C}$ , let  $\vec{x} \in \mathcal{C}'$  be defined as

$$\vec{x}(i) = \begin{cases} \underline{x}(i), & i \in [n] \\ \sqrt{(n+1)P - \|\underline{x}\|_2^2}, & i = n+1 \end{cases}.$$

for  $i \in [n+1]$ . It is immediate that  $\|\vec{x}\|_2 = \sqrt{(n+1)P}$ . By list-decodability of  $\mathcal{C}$ , we know that for any  $(\underline{x}_1, \dots, \underline{x}_L) \in \binom{\mathcal{C}}{L}$ ,

$$\text{rad}(\underline{x}_1, \dots, \underline{x}_L) = \min_{\underline{y} \in \mathbb{R}^n} \max_{i \in [L]} \|\underline{x}_i - \underline{y}\|_2^2 > nN.$$

We would like to check the list-decodability of  $\mathcal{C}'$ . Let  $(\vec{x}_1, \dots, \vec{x}_L)$  denote the augmented version of  $(\underline{x}_1, \dots, \underline{x}_L)$ .

$$\begin{aligned} \text{rad}(\vec{x}_1, \dots, \vec{x}_L) &= \min_{\vec{y} \in \mathbb{R}^{n+1}} \max_{i \in [L]} \|\vec{x}_i - \vec{y}\|_2^2 \\ &= \min_{\substack{\underline{y} \in \mathbb{R}^n \\ y_{n+1} \in \mathbb{R}}} \max_{i \in [L]} \left\{ \|\underline{x}_i - \underline{y}\|_2^2 + |\vec{x}(n+1) - y_{n+1}|^2 \right\} \\ &\geq \min_{\underline{y} \in \mathbb{R}^n} \max_{i \in [L]} \|\underline{x}_i - \underline{y}\|_2^2 \\ &> nN \\ &= (n+1)N', \end{aligned}$$

where  $N' := \frac{nN}{n+1} \xrightarrow{n \rightarrow \infty} N$ . Therefore,  $\mathcal{C}' \subset \mathcal{S}^n(\vec{0}, \sqrt{(n+1)P})$  is  $(P, N', L-1)$ -list-decodable.  $\square$

The same trick applies to the unbounded case as well. Using the representation of average radius given by [Equation \(46\)](#), we have

$$\begin{aligned} \overline{\text{rad}}(\vec{x}_1, \dots, \vec{x}_L) &= \frac{1}{2L^2} \sum_{(i,j) \in [L]^2: i \neq j} \|\vec{x}_i - \vec{x}_j\|_2^2 \\ &= \frac{1}{2L^2} \sum_{(i,j) \in [L]^2: i \neq j} \left( \|\underline{x}_i - \underline{x}_j\|_2^2 + |\vec{x}_i(n+1) - \vec{x}_j(n+1)|^2 \right) \\ &\geq \frac{1}{2L^2} \sum_{(i,j) \in [L]^2: i \neq j} \|\underline{x}_i - \underline{x}_j\|_2^2 \\ &= \text{rad}(\underline{x}_1, \dots, \underline{x}_L). \end{aligned}$$

<sup>3</sup>We use  $\vec{0} \in \mathbb{R}^{n+1}$  to denote the all-zero vector of length  $n+1$ .

We conclude that  $\overline{C}_{L-1}(P, N)$  can also be achieved using spherical codes.

*Remark 5.* For  $L = 2$ , Cohn and Zhao [CZ14] obtained a reduction from unbounded packings to bounded packings for *finite*  $n$ . They first restricted an unbounded packing to a ball code in  $\mathcal{B}^n(\sqrt{nP})$  and then proved a reduction from ball codes to spherical codes. They showed that for *any*  $n \geq 1$ , and any  $P, N > 0$  such that  $1/4 \leq N/P \leq 1$ ,

$$\limsup_{\mathcal{C} \subset \mathbb{R}^n: \text{rad}_2(\mathcal{C}) > nN} \Delta(\mathcal{C}) \leq \sqrt{N/P^n} \quad \limsup_{\mathcal{C} \subset \mathcal{S}^{n-1}(\sqrt{nP}): \text{rad}_2(\mathcal{C}) > nN} R(\mathcal{C}),$$

where the density of an unbounded packing is measured using Equation (32), i.e., the fraction of space occupied by the balls of radius  $\sqrt{nN}$ . The above inequality holds for *every* dimension with additional constraints on  $N/P$ . On the other hands, our reduction (Theorem 21) only holds for *asymptotically large* dimensions without any constraint on  $N/P$ . We are unable to generalize the result for finite  $n$  by Cohn and Zhao to  $L > 3$ .

## IX. RANDOM CODING WITH EXPURGATION

In this section, we introduce a basic strategy for proving lower bounds on the list-decoding capacity. The idea, known as *random coding with expurgation*, is classical in information theory and coding theory.

**Theorem 22.** *Let  $P, N > 0$  and  $L \in \mathbb{Z}_{\geq 2}$ . For any distribution  $\mathcal{D}$  supported on  $\mathcal{B}^n(\sqrt{nP})$ ,*

$$C_{L-1}(P, N) \geq \frac{E(P, N, L)}{L-1}, \quad \overline{C}_{L-1}(P, N) \geq \frac{\overline{E}(P, N, L)}{L-1},$$

where  $E(P, N, L)$  and  $\overline{E}(P, N, L)$  depending on  $\mathcal{D}$  are lower bounds on the exponents of the following probabilities

$$E(P, N, L) \leq \lim_{n \rightarrow \infty} -\frac{1}{n} \ln \Pr_{(\mathbf{x}_1, \dots, \mathbf{x}_L) \sim \mathcal{D}^{\otimes L}} [\text{rad}(\mathbf{x}_1, \dots, \mathbf{x}_L) \leq nN],$$

$$\overline{E}(P, N, L) \leq \lim_{n \rightarrow \infty} -\frac{1}{n} \ln \Pr_{(\mathbf{x}_1, \dots, \mathbf{x}_L) \sim \mathcal{D}^{\otimes L}} [\overline{\text{rad}}(\mathbf{x}_1, \dots, \mathbf{x}_L) \leq nN].$$

*Proof.* Let us first consider constructions of  $(P, N, L-1)$ -multiple packings. Let  $\mathcal{D}$  be a distribution on  $\mathcal{B}^n(\sqrt{nP})$ . We sample  $M = e^{nR}$  points i.i.d. from  $\mathcal{D}$  and call the point set  $\mathcal{C}$ . Fix any  $(i_1, \dots, i_L) \in \binom{[M]}{L}$ . Suppose we manage to compute the following probability

$$\Pr[\varphi(\mathbf{x}_{i_1}, \dots, \mathbf{x}_{i_L}) \leq nN] \doteq e^{-nE(P, N, L)}, \quad (49)$$

where  $\varphi(\cdot)$  denotes either the Chebyshev radius  $\text{rad}(\cdot)$  or the average radius  $\overline{\text{rad}}(\cdot)$ . Then we know that the expected number of *bad* lists (i.e.,  $L$ -lists  $\mathcal{L}$  for which  $\varphi(\mathcal{L})$  is at most  $nN$ ) is

$$\mathbb{E} \left[ \left| \left\{ \mathcal{L} \in \binom{\mathcal{C}}{L} : \varphi(\mathcal{L}) \leq nN \right\} \right| \right] \doteq \binom{M}{L} e^{-nE(P, N, L)} \leq M^L e^{-nE(P, N, L)} = e^{n(RL - E(P, N, L))}.$$

We then expurgate one point from each of these bad lists and hope that the total number of removed points is at most, say,  $M/2$ . This is satisfied if

$$\begin{aligned} e^{n(RL - E(P, N, L) + o(1))} &\leq M/2 \\ \iff RL - E(P, N, L) &\leq R - o(1) \\ \iff R &\leq \frac{E(P, N, L)}{L-1} - o(1). \end{aligned}$$

Note that the expurgation process destroys all bad  $L$ -lists, and the remaining subcode  $\mathcal{C}' \subset \mathcal{C}$  of size at least  $M/2$  is indeed a  $(P, N, L-1)$ -multiple packing. Therefore, there exists a construction of  $(P, N, L-1)$ -multiple packing with rate approaching  $\frac{E(P, N, L)}{L-1}$ .  $\square$

Technically, if the distribution  $\mathcal{D}$  is not exactly supported in  $\mathcal{B}^n(\sqrt{nP})$ , e.g.,  $\mathcal{D} = \mathcal{N}(0, PI_n)$ , then we also need to compute the probability

$$\Pr_{\mathbf{x} \sim \mathcal{D}} [\|\mathbf{x}\|_2 > \sqrt{nP}] \doteq e^{-nF(P, N)}$$

for some exponent  $F(P, N)$  and argue that the expected number of points with norm larger than  $\sqrt{nP}$  is negligible, i.e.,

$$\mathbb{E}\left[\left|\mathcal{C} \cap \mathcal{B}^n(\sqrt{nP})^c\right|\right] \doteq e^{n(R-F(P,N))} \ll e^{nR}.$$

Such a probability is usually very small and the number of points with large norm that will be expurgated is therefore negligible. As a result, this expurgation step does not put effective constraints on the rate  $R$ .

The above idea can be adapted to  $(N, L-1)$ -multiple packings.

*Remark 6.* From [Equation \(49\)](#), if we do not proceed with expurgation but instead take a union bound over  $(i_1, \dots, i_L) \in \binom{[M]}{L}$ , then the bound we eventually get will be  $\frac{E(P,N,L)}{L}$  which is much less than  $\frac{E(P,N,L)}{L-1}$  especially for small  $L$ . Therefore, expurgation is necessary for random coding arguments.

## X. LOWER BOUNDS VIA GAUSSIAN CODES

In this section, we analyze average-radius list-decodability of a Gaussian code (with expurgation) and establish the following theorem.

**Theorem 23.** *For any  $P, N \in \mathbb{R}_{>0}$  such that  $\frac{N}{P} \leq \frac{L-1}{L}$  and  $L \in \mathbb{Z}_{\geq 2}$ , the  $(P, N, L-1)$ -average-radius list-decoding capacity is at least*

$$\bar{C}_{L-1}(P, N) \geq \frac{1}{2} \left( \ln \frac{(L-1)P}{LN} + \frac{LN}{(L-1)P} - 1 \right). \quad (50)$$

*Remark 7.* The above bound ([Equation \(50\)](#)) converges to  $\frac{1}{2}(\ln \frac{P}{N} + \frac{N}{P} - 1)$  as  $L \rightarrow \infty$ . The limiting value is strictly smaller than  $\frac{1}{2} \ln \frac{P}{N}$  which is the list-decoding capacity for asymptotically large  $L$  (see [Section XVI](#)). When  $L = 2$ , the above bound becomes  $\frac{1}{2}(\ln \frac{P}{2N} + \frac{2N}{P} - 1)$  which is lower than the best known  $\frac{1}{2} \ln \frac{P^2}{4N(P-N)}$  (see [Theorem 33](#)). Furthermore, the above bound shoots to infinity at  $N/P = 0$  and hits zero at  $N/P = \frac{L-1}{L}$ . These two values are tight. Specifically,  $\bar{C}_{L-1}(P, N) = \infty$  at  $N/P = 0$ , obviously. Also, it turns out that  $\bar{C}_{L-1}(P, N) = 0$  at the point  $N/P = \frac{L-1}{L}$  known as the *Plotkin point* (see [Section XV](#)).

*Proof.* Construct a codebook by sampling  $M = e^{nR}$  (for some rate  $R > 0$  to be determined later) Gaussian vectors  $\mathbf{x}_1, \dots, \mathbf{x}_M$ , each entry i.i.d. from  $\mathcal{N}\left(0, \frac{P}{1+\varepsilon}\right)$  where  $\varepsilon$  is a small number to be determined. Let  $P' := \frac{P}{1+\varepsilon}$ . The probability that a codeword violates the power constraint is

$$\Pr_{\mathbf{x} \sim \mathcal{N}(\mathbf{0}, P'I_n)} \left[ \|\mathbf{x}\|_2 > \sqrt{nP} \right]. \quad (51)$$

To obtain the exponent of the probability in [Equation \(51\)](#), we first recall the MGF of a chi-square random variable.

**Definition 12.** The *chi-square distribution*  $\chi^2(k)$  with *degree of freedom*  $k$  is defined as the distribution of  $\sum_{i=1}^k \mathbf{g}_i$  where  $\mathbf{g}_i \stackrel{\text{i.i.d.}}{\sim} \mathcal{N}(0, 1)$  for  $1 \leq i \leq k$ .

**Fact 24.** *If  $\mathbf{x} \sim \chi^2(k)$ , then for  $\lambda < 1/2$*

$$\mathbb{E}\left[e^{\lambda \mathbf{x}}\right] = \sqrt{1 - 2\lambda}^{-k}.$$

Plugging the formula in [Fact 24](#) into Cramér's theorem ([Theorem 11](#)), we get the first order asymptotics of the tail of a chi-square random variable.

**Lemma 25.** *If  $\mathbf{x} \sim \chi^2(k)$ , then*

$$\begin{aligned} \lim_{k \rightarrow \infty} \frac{1}{k} \ln \Pr[\mathbf{x} > (1 + \delta)k] &= \frac{1}{2}(-\delta + \ln(1 + \delta)), & \text{for } \delta > 0; \\ \lim_{k \rightarrow \infty} \frac{1}{k} \ln \Pr[\mathbf{x} < (1 - \delta)k] &= \frac{1}{2}(\delta + \ln(1 - \delta)), & \text{for } \delta \in (0, 1). \end{aligned}$$

Then the probability in [Equation \(51\)](#) is

$$\Pr_{\mathbf{x} \sim \mathcal{N}(\mathbf{0}, P'I_n)} \left[ \left\| \frac{\mathbf{x}}{\sqrt{P'}} \right\|_2^2 > nP/P' \right] = \Pr_{\mathbf{x} \sim \mathcal{N}(\mathbf{0}, P'I_n)} \left[ \left\| \frac{\mathbf{x}}{\sqrt{P'}} \right\|_2^2 > n(1 + \varepsilon) \right] \doteq e^{\frac{n}{2}(-\varepsilon + \ln(1 + \varepsilon))},$$

since  $\|\underline{\mathbf{x}}/\sqrt{P'}\|_2^2 \sim \chi^2(n)$ . Therefore the expected number of codewords that violate the power constraint is

$$\mathbb{E}\left[\left|\left\{i \in [M] : \|\underline{\mathbf{x}}_i\|_2 > \sqrt{nP'}\right\}\right|\right] \doteq Me^{\frac{n}{2}(-\varepsilon + \ln(1+\varepsilon))} = e^{n(R + \frac{1}{2}(-\varepsilon + \ln(1+\varepsilon)))}.$$

If  $\varepsilon$  is set to be sufficiently small, the above number is negligible compared to the size  $e^{nR}$  of the code.

We now compute the probability that the average radius of a list is too small (Equation (49) with  $\varphi(\cdot) = \overline{\text{rad}}(\cdot)$ ).

$$\Pr[\overline{\text{rad}}(\underline{\mathbf{x}}_1, \dots, \underline{\mathbf{x}}_L) \leq nN] = \Pr\left[\frac{1}{L} \sum_{i=1}^L \|\underline{\mathbf{x}}_i\|_2^2 - \|\underline{\mathbf{x}}\|_2^2 \leq nN\right] \quad (52)$$

$$\begin{aligned} &= \Pr\left[\sum_{i=1}^L \|\underline{\mathbf{x}}_i\|_2^2 - L\|\underline{\mathbf{x}}\|_2^2 \leq LnN\right] \\ &= \Pr\left[\sum_{j=1}^n \sum_{i=1}^L \underline{\mathbf{x}}_i(j)^2 - L \sum_{j=1}^n \left(\frac{1}{L} \sum_{i=1}^L \underline{\mathbf{x}}_i(j)\right)^2 \leq LnN\right] \\ &= \Pr\left[\sum_{j=1}^n \left(\sum_{i=1}^L \underline{\mathbf{x}}_i(j)^2 - \frac{1}{L} \left(\sum_{i=1}^L \underline{\mathbf{x}}_i(j)\right)^2\right) \leq LnN\right], \end{aligned} \quad (53)$$

where Equation (52) is by Equation (44) and  $\underline{\mathbf{x}} := \frac{1}{L} \sum_{i=1}^L \underline{\mathbf{x}}_i$ .

Define

$$g(x_1, \dots, x_L) := \sum_{i=1}^L x_i^2 - \frac{1}{L} \left(\sum_{i=1}^L x_i\right)^2.$$

The above probability (Equation (53)) can be rewritten as

$$\Pr\left[\sum_{j=1}^n g(\underline{\mathbf{x}}_1(j), \dots, \underline{\mathbf{x}}_L(j)) \leq LnN\right] \quad (54)$$

where  $\underline{\mathbf{x}}_i(j) \stackrel{\text{i.i.d.}}{\sim} \mathcal{N}(0, P')$  for each  $i \in [L]$  and  $j \in [n]$ .

We note that the function  $g(\vec{t})$  is a quadratic form of  $\vec{t} \in \mathbb{R}^L$ . Indeed,

$$g(\vec{t}) = \sum_{i=1}^L \vec{t}(i)^2 - \frac{1}{L} \left(\sum_{i=1}^L \vec{t}(i)\right)^2 = \left(1 - \frac{1}{L}\right) \sum_{i=1}^L \vec{t}(i)^2 - \frac{2}{L} \sum_{i,j \in [L]: i < j} \vec{t}(i)\vec{t}(j) = \vec{t}^\top A \vec{t}, \quad (55)$$

where

$$A := I_L - \frac{1}{L} J_L \in \mathbb{R}^{L \times L}$$

and  $I_L$  denotes the  $L \times L$  identity matrix and  $J_L$  denotes the  $L \times L$  all-one matrix.

Let  $\vec{\mathbf{x}}_j := (\underline{\mathbf{x}}_1(j), \dots, \underline{\mathbf{x}}_L(j)) \in \mathbb{R}^L$ . By the above manipulation, we have  $g(\vec{\mathbf{x}}_j) = \vec{\mathbf{x}}_j^\top A \vec{\mathbf{x}}_j$ , where  $\vec{\mathbf{x}}_j \sim \mathcal{N}(\vec{0}, P' I_L)$ . In fact, since  $A$  is idempotent (i.e.,  $A^2 = A$ ), such a quadratic form is distributed according to  $g(\vec{\mathbf{x}}_j)/P' \sim \chi^2(\text{Tr}(A)) = \chi^2(L-1)$ . Furthermore, the sum of i.i.d. chi-square random variables is still chi-square distributed and the degrees of freedom are summed. Therefore,  $\sum_{j=1}^n g(\vec{\mathbf{x}}_j)/P' \sim \chi^2((L-1)n)$ .

Assume  $\frac{N}{P'} < \frac{L-1}{L}$ . Let  $N = \frac{L-1}{L} P' (1-\rho)$  for some  $\rho > 0$ . One can solve  $\rho$  and get  $\rho = 1 - \frac{LN}{(L-1)P'}$ . We now can apply Lemma 25 to obtain the exact asymptotics of Equation (54):

$$\begin{aligned} \text{Equation (54)} &= \Pr\left[\sum_{j=1}^n g(\vec{\mathbf{x}}_j)/P' \leq LnN/P'\right] \\ &= \Pr\left[\chi^2((L-1)n) \leq Ln \cdot \frac{L-1}{L} P' (1-\rho) \cdot \frac{1+\varepsilon}{P'}\right] \\ &= \Pr\left[\chi^2((L-1)n) \leq n(L-1)(1-\rho)(1+\varepsilon)\right] \end{aligned}$$

$$\begin{aligned}
&= \Pr[\chi^2((L-1)n) \leq n(L-1)(1-\delta)] \\
&\doteq \exp\left((L-1)n\frac{1}{2}(\ln(1-\delta) + \delta)\right).
\end{aligned} \tag{56}$$

In Equation (56), we define  $\delta > 0$  such that  $1 - \delta = (1 - \rho)(1 + \varepsilon)$ , i.e.,  $\delta := (1 + \varepsilon)\rho - \varepsilon$ . Note that  $\delta \xrightarrow{\varepsilon \rightarrow 0} \rho$ .

The expected number of *bad* lists is therefore

$$\mathbb{E}\left[\left|\left\{\mathcal{L} \in \binom{[M]}{L} : \overline{\text{rad}}(\{\mathbf{x}_i\}_{i \in \mathcal{L}}) \leq nN\right\}\right|\right] \doteq \binom{M}{L} e^{n\frac{L-1}{2}(\ln(1-\delta) + \delta)} \leq e^{n(LR + \frac{L-1}{2}(\ln(1-\delta) + \delta))}.$$

To obtain an  $(P, N, L-1)$ -average-radius list-decodable code, we first throw away all codewords that violate the power constraint. We then throw away one codeword in each *bad* list whose average radius is at most  $nN$ . We would like the expected number of codewords we threw away in total not to exceed  $M/2$ . This can be satisfied if the rate  $R$  satisfies

$$LR + \frac{L-1}{2}(\ln(1-\delta) + \delta) \leq R - o(1).$$

That is, (ignoring the  $o(1)$  factor)

$$\begin{aligned}
R &< \frac{1}{2} \left( \ln \frac{1}{1-\delta} - \delta \right) \\
&= \frac{1}{2} \left( \ln \frac{1}{(1-\rho)(1+\varepsilon)} - (1+\varepsilon)\rho + \varepsilon \right) \\
&= \frac{1}{2} \left( \ln \frac{(L-1)P}{LN(1+\varepsilon)} - (1+\varepsilon) \left( 1 - \frac{LN}{(L-1)P} \right) + \varepsilon \right) \\
&\xrightarrow{\varepsilon \rightarrow 0} \frac{1}{2} \left( \ln \frac{(L-1)P}{LN} + \frac{LN}{(L-1)P} - 1 \right).
\end{aligned}$$

We then obtain a  $(P, N, L-1)$ -average-radius list-decodable code of size at least  $M/2$ .  $\square$

## XI. LOWER BOUNDS VIA SPHERICAL CODES

In this section, we examine the  $(P, N, L-1)$ -average-radius list-decodability of uniformly random spherical codes (with expurgation). We first sample  $M = e^{nR}$  codewords  $\mathbf{x}_1, \dots, \mathbf{x}_M$  uniformly and independently from  $\mathcal{B}^n(\sqrt{nP})$ . We are again interested in the asymptotics of Equation (49) with  $\varphi(\cdot) = \overline{\text{rad}}(\cdot)$ . In the spherical case, it is more convenient to use the formula Equation (47) for the average radius. In Sections XI-A and XI-B respectively, we will obtain a bound on the normalized exponent of Equation (49) via two different approaches: *normal approximation* and *Khinchin's inequality* (with sharp constants). Plugging this bound into the random coding with expurgation framework, we get the following result.

**Theorem 26.** *For any  $P, N \in \mathbb{R}_{>0}$  such that  $\frac{N}{P} \leq \frac{L-1}{L}$  and  $L \in \mathbb{Z}_{\geq 2}$ , the  $(P, N, L-1)$ -average-radius list-decoding capacity is at least*

$$\overline{C}_{L-1}(P, N) \geq \frac{1}{2} \left( 1 - \frac{LN}{(L-1)P} - \frac{1}{L-1} \ln \frac{L(P-N)}{P} \right). \tag{57}$$

*Remark 8.* The above bound (Equation (57)) converges to  $\frac{1}{2}(1 - \frac{N}{P})$  as  $L \rightarrow \infty$ . The limiting value is strictly smaller than  $\frac{1}{2} \ln \frac{P}{N}$  which is the list-decoding capacity for asymptotically large  $L$  (see Section XVI). On the other hand, when  $L = 2$ , the above bound becomes  $\frac{1}{2} \left( 1 - \frac{2N}{P} - \ln \frac{2(P-N)}{P} \right)$  which is lower than the best known bound  $\frac{1}{2} \ln \frac{P^2}{4N(P-N)}$  in Theorem 33. Furthermore, the above bound is reasonably good for  $N/P$  close to  $\frac{L-1}{L}$  (see Equation (9)) whereas it gets worse for small  $N/P$ . In particular, for  $N/P = 0$ ,  $\overline{C}_{L-1}(P, N)$  should be infinity since clearly one can pack arbitrarily many balls of radius zero. However, the above bound attains a finite value (specifically  $\frac{1}{2} \left( 1 - \frac{\ln L}{L-1} \right)$ ) at  $N/P = 0$ . This will be explained in Remark 9.

### A. Proof via normal approximation

We need the following lemma for approximating the density of a sum of uniform spherical vectors by that of a Gaussian (with a consistent variance).

**Lemma 27** ([ML15], Proposition 2). *Let  $P > 0$ . Let  $\mathbf{x}_1, \dots, \mathbf{x}_L$  be i.i.d. random vectors uniformly distributed on  $\mathcal{B}^n(\sqrt{nP})$ . Let  $\tilde{\mathbf{x}}_1, \dots, \tilde{\mathbf{x}}_L$  be i.i.d. Gaussian vectors each with distribution  $\mathcal{N}(\mathbf{0}, P \cdot I_n)$ . Let  $\underline{\mathbf{y}} := \sum_{i=1}^L \mathbf{x}_i$  and  $\tilde{\underline{\mathbf{y}}} := \sum_{i=1}^L \tilde{\mathbf{x}}_i$  respectively. Then for any  $\underline{\mathbf{y}} \in \mathbb{R}^n$ , we have  $P_{\underline{\mathbf{y}}}(\underline{\mathbf{y}})/P_{\tilde{\underline{\mathbf{y}}}(\underline{\mathbf{y}})} \leq \kappa$ , where  $\kappa = \kappa(P) > 0$  is a constant depending only on  $P$  but not  $n$ .*

Assume  $N = \frac{L-1}{L}P(1-\rho)$  for some constant  $\rho > 0$ . Equivalently,  $\rho = 1 - \frac{LN}{(L-1)P}$ . We are ready to compute Equation (49) with  $\varphi(\cdot) = \overline{\text{rad}}(\cdot)$ .

$$\Pr[\overline{\text{rad}}(\mathbf{x}_1, \dots, \mathbf{x}_L) \leq nN] = \Pr[nP - \|\mathbf{x}\|_2^2 \leq nN] \quad (58)$$

$$\begin{aligned} &= \Pr[\|\mathbf{x}\|_2^2 \geq n(P-N)] \\ &= \Pr\left[\|\mathbf{x}\|_2^2 \geq n\left(\frac{P}{L} + \left(1 - \frac{1}{L}\right)P\rho\right)\right] \\ &= \Pr[\|\underline{\mathbf{y}}\|_2^2 \geq nLP(1+\eta)] \end{aligned} \quad (59)$$

$$\begin{aligned} &= \int_{\mathbb{R}^n} P_{\underline{\mathbf{y}}}(\underline{\mathbf{y}}) \mathbf{1}\{\|\underline{\mathbf{y}}\|_2^2 \geq nLP(1+\eta)\} d\underline{\mathbf{y}} \\ &\leq \kappa \int_{\mathbb{R}^n} P_{\tilde{\underline{\mathbf{y}}}(\underline{\mathbf{y}})} \mathbf{1}\{\|\underline{\mathbf{y}}\|_2^2 \geq nLP(1+\eta)\} d\underline{\mathbf{y}} \end{aligned} \quad (60)$$

$$= \kappa \Pr[\|\tilde{\underline{\mathbf{y}}}\|_2^2 \geq nLP(1+\eta)], \quad (61)$$

Equation (58) follows from Equation (47) and  $\mathbf{x} := \frac{1}{L} \sum_{i=1}^L \mathbf{x}_i$ . In Equation (59), we define  $\underline{\mathbf{y}} := L\mathbf{x} = \sum_{i=1}^L \mathbf{x}_i$  and  $\eta := (L-1)\rho$ . Inequality (60) is by Lemma 27 and  $\tilde{\underline{\mathbf{y}}} = \sum_{i=1}^L \tilde{\mathbf{x}}_i$  where  $\mathbf{x}_i \stackrel{\text{i.i.d.}}{\sim} \mathcal{N}(\mathbf{0}, P \cdot I_n)$  for  $1 \leq i \leq L$ . Note that the probability in Equation (61) is nothing but the tail of a chi-square random variable. Indeed,

$$\begin{aligned} \Pr[\|\tilde{\underline{\mathbf{y}}}\|_2^2 \geq nLP(1+\eta)] &= \Pr\left[\sum_{j=1}^n \tilde{\mathbf{y}}(j)^2 \geq nLP(1+\eta)\right] \\ &= \Pr\left[\sum_{j=1}^n \left(\sum_{i=1}^L \tilde{\mathbf{x}}_i(j)\right)^2 \geq nLP(1+\eta)\right] \\ &= \Pr\left[\sum_{j=1}^n \mathcal{N}_j(0, LP)^2 \geq nLP(1+\eta)\right] \\ &= \Pr\left[\sum_{j=1}^n \mathcal{N}_j(0, 1)^2 \geq n(1+\eta)\right] \\ &= \Pr[\chi^2(n) \geq n(1+\eta)] \\ &\doteq \exp\left(\frac{n}{2}(-\eta + \ln(1+\eta))\right). \end{aligned} \quad (62)$$

The last equality (Equation (62)) is by Lemma 25. Going through the same expurgation process as described in Section IX, we obtain a  $(P, N, L-1)$ -average-radius list-decodable code of rate asymptotically  $R$  as long as

$$LR + \frac{1}{2}(-\eta + \ln(1+\eta)) \leq R,$$

Since  $\rho = 1 - \frac{LN}{(L-1)P}$ , this is equivalent to

$$R \leq \frac{1}{2(L-1)}(\eta - \ln(1+\eta))$$



$$\begin{aligned}
&= \frac{1}{2} \left( \rho - \frac{1}{L-1} \ln(1 + (L-1)\rho) \right) \\
&= \frac{1}{2} \left( 1 - \frac{LN}{(L-1)P} - \frac{1}{L-1} \ln \left( 1 + (L-1) - \frac{LN}{P} \right) \right) \\
&= \frac{1}{2} \left( 1 - \frac{LN}{(L-1)P} - \frac{1}{L-1} \ln \frac{L(P-N)}{P} \right).
\end{aligned}$$

This finishes the proof of [Theorem 26](#).

*Remark 9.* Note that [Equation \(57\)](#) equals  $\frac{1}{2} \left( 1 - \frac{\ln L}{L-1} \right) < \infty$  when  $N/P = 0$ . However, if  $N/P = 0$ , [Equation \(58\)](#) is obviously zero since  $\|\underline{\mathbf{x}}\|_2^2 \leq \left( \frac{1}{L} \cdot L\sqrt{nP} \right)^2 = nP$  for any  $\underline{\mathbf{x}}_1, \dots, \underline{\mathbf{x}}_L \in \mathcal{B}^n(\sqrt{nP})$ . This means that we should be able to achieve an arbitrarily large  $R$  in this case. The reason why [Equation \(57\)](#) is incorrect at high rates is that [Inequality \(60\)](#) is loose when  $N/P$  is small. In particular, if  $N/P = 0$ , we have  $\rho = 1$ , therefore  $\eta = L - 1$ . The probability  $\Pr \left[ \|\tilde{\underline{\mathbf{x}}}\|_2^2 \geq nP \right]$ , where  $\tilde{\underline{\mathbf{x}}} = \frac{1}{L} \sum_{i=1}^L \tilde{\underline{\mathbf{x}}}_i$  and each  $\tilde{\underline{\mathbf{x}}}_i$  is i.i.d. Gaussian, equals  $\Pr[\chi^2(n) \geq nL]$ . This probability has a finite (rather than infinite) exponent.

Given the above observation, it is tempting to consider better versions of normal approximation in [Inequality \(60\)](#). The simplest refinement would be to truncate the p.d.f. at  $\|\underline{\mathbf{y}}\|_2 = L\sqrt{nP}$ , i.e.,

$$P_{\underline{\mathbf{y}}}(\underline{\mathbf{y}}) \leq \kappa P_{\tilde{\underline{\mathbf{y}}}}(\underline{\mathbf{y}}) \mathbb{1} \left\{ \|\underline{\mathbf{y}}\|_2^2 \leq nL^2P \right\}.$$

Unfortunately, the above refinement does not give rise to an improved bound on the achievable rate.

### B. Proof via Khinchin's inequality

It was proved in [[KK01](#), Theorem 3] that the  $p$ -th moment of the norm of the sum of a collection of spherical vectors is *upper bounded*<sup>4</sup> by its second moment.

**Theorem 28** ([[KK01](#)]). *Let  $1 \leq p < \infty$  and  $n \geq 2$ . If  $\underline{\mathbf{x}}_1, \dots, \underline{\mathbf{x}}_k$  are independent and uniformly distributed on  $\mathcal{S}^{n-1}$ , then for any  $k \in \mathbb{Z}_{\geq 1}$  and  $\vec{\alpha} = [\vec{\alpha}(1), \dots, \vec{\alpha}(k)] \in \mathbb{R}^k$ ,*

$$\left( \mathbb{E} \left[ \left\| \sum_{i=1}^k \vec{\alpha}(i) \underline{\mathbf{x}}_i \right\|_2^p \right] \right)^{1/p} \leq C_{n,p} \|\vec{\alpha}\|_2, \quad (63)$$

where

$$C_{n,p} := \sqrt{\frac{2}{n}} \left( \frac{\Gamma(\frac{p+n}{2})}{\Gamma(\frac{n}{2})} \right)^{1/p}.$$

*Remark 10.* The constant  $C_{n,p}$  (independent of  $\vec{\alpha}$ ) is the best possible and is attained when  $\vec{\alpha} = [1/\sqrt{k}, \dots, 1/\sqrt{k}] \in \mathbb{R}^k$  and  $k \rightarrow \infty$ .

*Remark 11.* It is not hard to check that  $\|\vec{\alpha}\|_2 = \sqrt{\mathbb{E} \left[ \left\| \sum_{i=1}^k \vec{\alpha}(i) \underline{\mathbf{x}}_i \right\|_2^2 \right]}$ . Indeed,

$$\begin{aligned}
\left( \mathbb{E} \left[ \left\| \sum_{i=1}^k \vec{\alpha}(i) \underline{\mathbf{x}}_i \right\|_2^2 \right] \right)^{1/2} &= \left( \mathbb{E} \left[ \sum_{(i,j) \in [k]^2} \vec{\alpha}(i) \vec{\alpha}(j) \langle \underline{\mathbf{x}}_i, \underline{\mathbf{x}}_j \rangle \right] \right)^{1/2} \\
&= \left( \mathbb{E} \left[ \sum_{i \in [k]} \vec{\alpha}(i)^2 \|\underline{\mathbf{x}}_i\|_2^2 \right] + \mathbb{E} \left[ \sum_{(i,j) \in [k]^2: i \neq j} \vec{\alpha}(i) \vec{\alpha}(j) \langle \underline{\mathbf{x}}_i, \underline{\mathbf{x}}_j \rangle \right] \right)^{1/2} \\
&= \left( \sum_{i \in [k]} \vec{\alpha}(i)^2 + \sum_{(i,j) \in [k]^2: i \neq j} \vec{\alpha}(i) \vec{\alpha}(j) \sum_{\ell \in [n]} \mathbb{E}[\underline{\mathbf{x}}_i(\ell) \underline{\mathbf{x}}_j(\ell)] \right)^{1/2}
\end{aligned}$$

<sup>4</sup>Note that the  $p$ -th moment is trivially *lower bounded* by the second moment simply by the monotonicity (in  $p$ ) of moment  $(\mathbb{E}[\cdot^p])^{1/p}$ .

$$\begin{aligned}
&= \left( \sum_{i \in [k]} \vec{\alpha}(i)^2 + \sum_{(i,j) \in [k]^2: i \neq j} \vec{\alpha}(i)\vec{\alpha}(j) \sum_{\ell \in [n]} \mathbb{E}[\mathbf{x}_i(\ell)]\mathbb{E}[\mathbf{x}_j(\ell)] \right)^{1/2} \\
&= \left( \sum_{i \in [k]} \vec{\alpha}(i)^2 \right)^{1/2} \\
&= \|\vec{\alpha}\|_2.
\end{aligned} \tag{64}$$

Equation (64) follows since  $\mathbf{x}_i$  and  $\mathbf{x}_j$  are independent for  $1 \leq i \neq j \leq k$ . Therefore, Inequality (63) is a moment comparison inequality. Also, the constant  $C_{n,p}$  in Inequality (63) is in fact equal to  $C_{n,p} = \left( \mathbb{E} \left[ \|\mathbf{g}\|_2^p \right] \right)^{1/p}$  where  $\mathbf{g} \sim \mathcal{N}(\mathbf{0}, I_n/n)$ .

We can now get an upper bound on Equation (58) by combining Theorem 28 and the Chebyshev's inequality (Lemma 3). Let  $\mathbf{y} := \sum_{i=1}^L \mathbf{x}_i$ . Then

$$\begin{aligned}
\Pr[\text{rad}(\mathbf{x}_1, \dots, \mathbf{x}_L) \leq nN] &= \Pr \left[ \|\mathbf{y}\|_2^2 \geq nLP(1+\eta) \right] \\
&= \Pr \left[ \left\| \sum_{i=1}^L \mathbf{u}_i \right\|_2 \geq \sqrt{L(1+\eta)} \right]
\end{aligned} \tag{65}$$

$$\begin{aligned}
&= \Pr \left[ \left\| \sum_{i=1}^L \mathbf{u}_i \right\|_2^p \geq (L(1+\eta))^{p/2} \right] \\
&\leq \frac{\mathbb{E} \left[ \left\| \sum_{i=1}^L \mathbf{u}_i \right\|_2^p \right]}{(L(1+\eta))^{p/2}}
\end{aligned} \tag{66}$$

In Equation (65),  $\mathbf{u}_i \stackrel{\text{i.i.d.}}{\sim} \text{Unif}(\mathcal{S}^{n-1})$  for  $1 \leq i \leq L$ . To apply Theorem 28, we let  $k = L$ ,  $\vec{\alpha} = [1, \dots, 1] \in \mathbb{R}^L$ . Note that  $\|\vec{\alpha}\|_2 = \sqrt{L}$ . Therefore Equation (66) is at most

$$\begin{aligned}
\text{Equation (66)} &\leq \frac{C_{n,p}^p L^{p/2}}{(L(1+\eta))^{p/2}} \\
&= \left( \frac{2}{n} \right)^{p/2} \frac{\Gamma(\frac{p+n}{2})}{\Gamma(\frac{n}{2})} (1+\eta)^{-p/2} \\
&\stackrel{n \rightarrow \infty}{\asymp} \left( \frac{2}{n} \right)^{p/2} \frac{\sqrt{\pi(p+n-2)} \left( \frac{p+n-1}{e} \right)^{\frac{p+n}{2}-1}}{\sqrt{\pi(n-2)} \left( \frac{n-1}{e} \right)^{\frac{n}{2}-1}} (1+\eta)^{-p/2}
\end{aligned} \tag{67}$$

$$\begin{aligned}
&= \left( \frac{2}{n} \right)^{p/2} \sqrt{\frac{n+p-2}{n-2}} \left( \frac{n+p-2}{2e} \right)^{\frac{n+p}{2}-1} \left( \frac{2e}{n-2} \right)^{\frac{n}{2}-1} (1+\eta)^{-p/2} \\
&= \left( \frac{n+p-2}{ne} \right)^{p/2} \sqrt{\frac{n+p-2}{n-2}} \left( \frac{n+p-2}{n-2} \right)^{\frac{n}{2}-1} (1+\eta)^{-p/2} \\
&= \left( \frac{n+p-2}{ne(1+\eta)} \right)^{p/2} \sqrt{\frac{n+p-2}{n-2}} \left( 1 + \frac{p}{n-2} \right)^{\frac{n}{2}-1}
\end{aligned} \tag{68}$$

In Equation (67), we use the Stirling's approximation (Theorem 12) for Gamma functions. If we set  $p = \alpha n$  for some  $\alpha > 0$  and let  $A := e(1+\eta)$ ,  $\beta = 1 + \alpha$ , then asymptotically in  $n \rightarrow \infty$ , Equation (68) becomes

$$\begin{aligned}
\text{Equation (68)} &\stackrel{n \rightarrow \infty}{\asymp} \left( \frac{1+\alpha}{e(1+\eta)} \right)^{n\alpha/2} \sqrt{1+\alpha} (1+\alpha)^{n/2-1} \\
&= (1+\alpha)^{-1/2} \left( \frac{1+\alpha}{e(1+\eta)} \right)^{n\alpha/2} (1+\alpha)^{n/2}
\end{aligned}$$

$$\begin{aligned}
&= (1 + \alpha)^{-1/2} \exp\left(\frac{n}{2}(\alpha \ln(1 + \alpha) - \alpha \ln A + \ln(1 + \alpha))\right) \\
&= (1 + \alpha)^{-1/2} \exp\left(\frac{n}{2}((1 + \alpha) \ln(1 + \alpha) - (1 + \alpha) \ln A + \ln A)\right) \\
&= \beta^{-1/2} \exp\left(\frac{n}{2}(\beta(\ln \beta - \ln A) + \ln A)\right).
\end{aligned}$$

The exponent is maximized at  $\beta = e^{\ln A - 1} = A/e = 1 + \eta$ , that is,  $\alpha = \eta$ . The corresponding maximum exponent (normalized by  $1/n$ ) is

$$\frac{1}{2}((1 + \eta)(\ln(1 + \eta) - \ln(e(1 + \eta))) + \ln(e(1 + \eta))) = \frac{1}{2}(-(1 + \eta) + \ln(1 + \eta) + 1) = \frac{1}{2}(-\eta + \ln(1 + \eta))$$

which matches [Equation \(62\)](#). The rest of the proof remains the same and we get the same bound.

### C. Ball codes

Since the  $p$ -th moment of the norm of the sum of vectors uniformly distributed on unit *sphere* is related to that of the sum of vectors uniformly distributed in unit *ball*, we also have Khinchin's inequality for the latter quantity.

**Theorem 29** ([KK01], Proposition 4). *Let  $0 < p < \infty$ ,  $n \in \mathbb{Z}_{\geq 1}$  and  $r > 0$ . Let  $\vec{x}_1, \dots, \vec{x}_k \in \mathbb{R}^{n+2}$  be independent random vectors uniformly distributed on  $S^{n+1}$ . Let  $\mathbf{x}_1, \dots, \mathbf{x}_k \in \mathbb{R}^n$  be independent random vectors uniformly distributed in  $r\mathcal{B}^n$ . Then for any  $k \in \mathbb{Z}_{\geq 1}$  and  $(\alpha_1, \dots, \alpha_k) \in \mathbb{R}^k$ ,*

$$\mathbb{E} \left[ \left\| \sum_{i=1}^k \alpha_i \mathbf{x}_i \right\|_2^p \right] = r^p \frac{n}{n+p} \mathbb{E} \left[ \left\| \sum_{i=1}^k \alpha_i \vec{x}_i \right\|_2^p \right].$$

**Theorem 30** ([KK01], Theorem 5). *Let  $1 \leq p < \infty$  and  $n \geq 1$ . If  $\mathbf{x}_1, \dots, \mathbf{x}_k$  are independent and uniformly distributed on  $\mathcal{B}^n$ , then for any  $k \in \mathbb{Z}_{\geq 1}$  and  $\vec{\alpha} = [\vec{\alpha}(1), \dots, \vec{\alpha}(k)] \in \mathbb{R}^k$ ,*

$$\left( \mathbb{E} \left[ \left\| \sum_{i=1}^k \vec{\alpha}(i) \mathbf{x}_i \right\|_2^p \right] \right)^{1/p} \leq \tilde{C}_{n,p} \|\vec{\alpha}\|_2,$$

where

$$\tilde{C}_{n,p} := \sqrt{\frac{2}{n+2}} \left( \frac{\Gamma(\frac{p+n}{2})}{\Gamma(\frac{n}{2})} \right)^{1/p}.$$

Therefore, random *ball* codes with expurgation can attain the same bound as [Equation \(57\)](#) which was attained by random *spherical* codes with expurgation.

## XII. LOWER BOUNDS VIA POISSON POINT PROCESSES (PPPs)

In this section, we analyze average-radius list-decodability of Poisson Point Processes (PPPs) with expurgation and prove the following lower bound on the  $(N, L-1)$ -average-radius list-decoding capacity of unbounded packings.

**Theorem 31.** *For any  $N > 0$  and  $L \in \mathbb{Z}_{\geq 2}$ , the  $(N, L-1)$ -average-radius list-decoding capacity is at least*

$$\bar{C}_{L-1}(N) \geq \frac{1}{2} \ln \frac{L-1}{2\pi eNL} - \frac{1}{2(L-1)} \ln L. \quad (69)$$

*Remark 12.* Note that the above bound ([Equation \(69\)](#)) approaches  $\frac{1}{2} \ln \frac{1}{2\pi eN}$  as  $L \rightarrow \infty$ . The latter quantity is known to be the list-decoding capacity for asymptotically large  $L$  (see [Section XVI](#)). On the extreme, when  $L = 2$ , the above bound becomes  $\frac{1}{2} \ln \frac{1}{8\pi eN}$  which recovers the best known bound ([Theorem 35](#)).

To prove the above theorem, let  $R < \frac{1}{2} \ln \frac{L-1}{2\pi eNL} - \frac{1}{2(L-1)} \ln L$  and  $\lambda \doteq e^{nR}$  and let  $\mathcal{C} \subset \mathbb{R}^n$  be a PPP of intensity  $\lambda$ . The exact choice of  $\lambda$  is given by [Equation \(88\)](#).

To analyze average-radius list-decodability of  $\mathcal{C}$ , we first restrict ourselves to a cube  $\mathcal{A} = \mathcal{I}^n$  where  $\mathcal{I} := [-K, K]$  is a sufficiently large interval for some  $K > 0$ . Let  $M$  be the number of points in  $\mathcal{A}$ , i.e.,  $M := |\mathcal{C} \cap \mathcal{A}|$ . By [Item 1](#) of [Definition 3](#),  $M \sim \text{Pois}(\lambda|\mathcal{A}|)$ . Conditioned on  $M$ , let  $\mathbf{x}_1, \dots, \mathbf{x}_M$  denote these  $M$  points in  $\mathcal{A}$ . By

**Item 3** of **Fact 16**, these points are independent and uniformly distributed in  $\mathcal{A}$ . That is,  $\underline{\mathbf{x}}_i(j) \stackrel{\text{i.i.d.}}{\sim} \text{Unif}(\mathcal{I})$  for each  $1 \leq i \leq M$  and  $1 \leq j \leq n$ . As usual, we would like to bound

$$\Pr[\overline{\text{rad}}(\underline{\mathbf{x}}_1, \dots, \underline{\mathbf{x}}_L) \leq nN] = \Pr\left[\frac{1}{L} \sum_{i=1}^L \|\underline{\mathbf{x}}_i\|_2^2 - \|\underline{\mathbf{x}}\|_2^2 \leq nN\right], \quad (70)$$

where  $\underline{\mathbf{x}} := \frac{1}{L} \sum_{i=1}^L \underline{\mathbf{x}}_i$ .

Recall **Equations (54)** and **(55)**. **Equation (70)** can be alternatively written as

$$\Pr\left[\sum_{j=1}^n \bar{\mathbf{x}}_j^\top A \bar{\mathbf{x}}_j \leq LnN\right], \quad (71)$$

where  $A := I_L - \frac{1}{L} J_L \in \mathbb{R}^{L \times L}$ ,  $\bar{\mathbf{x}}_j := [\underline{\mathbf{x}}_1(j), \dots, \underline{\mathbf{x}}_L(j)] \in \mathbb{R}^L$  and  $\underline{\mathbf{x}}_i(j) \stackrel{\text{i.i.d.}}{\sim} \text{Unif}(\mathcal{I})$  for each  $1 \leq i \leq L$  and  $1 \leq j \leq n$ .

### A. Large deviation principle

Since  $\bar{\mathbf{x}}_j^\top A \bar{\mathbf{x}}_j$  is independent for each  $1 \leq j \leq n$ , we can apply the large deviation principle (**Theorem 11**) to get the asymptotic behaviour of **Equation (71)**. Specifically,

$$\frac{1}{n} \ln \text{Equation (71)} \rightarrow -\max_{\lambda \leq 0} \left\{ \lambda Ln - \ln \mathbb{E}\left[e^{\lambda \bar{\mathbf{x}}^\top A \bar{\mathbf{x}}}\right] \right\} = -\max_{\lambda \geq 0} \left\{ -\lambda Ln - \ln \mathbb{E}\left[e^{-\lambda \bar{\mathbf{x}}^\top A \bar{\mathbf{x}}}\right] \right\}, \quad (72)$$

where  $\bar{\mathbf{x}} \sim \text{Unif}^{\otimes L}(\mathcal{I})$ .

We need to compute the following integral:

$$\mathbb{E}\left[e^{-\lambda \bar{\mathbf{x}}^\top A \bar{\mathbf{x}}}\right] = \frac{1}{(2K)^L} \int_{\mathcal{I}^L} e^{-\lambda \bar{\mathbf{x}}^\top A \bar{\mathbf{x}}} d\bar{\mathbf{x}} = \frac{1}{(2K)^L} \int_{[-1,1]^L} e^{-\lambda K^2 \bar{t}^\top A \bar{t}} K^L d\bar{t} = \frac{1}{2^L} \int_{[-1,1]^L} e^{-K^2 \lambda \bar{t}^\top A \bar{t}} d\bar{t}, \quad (73)$$

where  $\lambda \geq 0$ .

Note that  $A \in \mathbb{R}^{L \times L}$  has rank  $L - 1$  and therefor is singular, unfortunately. In fact,  $A$  has eigendecomposition  $A = PDP^{-1}$  where

$$P := \left[ \begin{array}{c|c|c|c|c} -1 & -1 & \cdots & -1 & 1 \\ & & & 1 & 1 \\ & & & & \vdots \\ & & \ddots & & 1 \\ 1 & 1 & & & 1 \end{array} \right] \in \mathbb{R}^{L \times L}$$

consists of the eigenvectors of  $A$  as its columns and

$$D := \left[ \begin{array}{cccc} 1 & & & \\ & \ddots & & \\ & & 1 & \\ & & & 0 \end{array} \right] \in \mathbb{R}^{L \times L}$$

consists of the eigenvalues of  $A$  as its diagonal entries. However,  $P$  is not orthogonal. One can orthogonalize it using the Gram–Schmidt process which gives us an orthogonal matrix  $U \in \mathbb{R}^{L \times L}$ . We claim that

$$U = \begin{bmatrix} -\frac{1}{\sqrt{1 \times 2}} & -\frac{1}{\sqrt{2 \times 3}} & -\frac{1}{\sqrt{3 \times 4}} & -\frac{1}{\sqrt{4 \times 5}} & \cdots & -\frac{1}{\sqrt{(L-2) \times (L-1)}} & -\frac{1}{\sqrt{(L-1) \times L}} & \frac{1}{\sqrt{L}} \\ & & & & & & \frac{\sqrt{\frac{L-1}{L}}}{\sqrt{(L-1) \times L}} & \frac{1}{\sqrt{L}} \\ & & & & & \frac{\sqrt{\frac{L-2}{L-1}}}{\sqrt{(L-1) \times L}} & -\frac{1}{\sqrt{(L-1) \times L}} & \vdots \\ & & & \ddots & & -\frac{1}{\sqrt{(L-2) \times (L-1)}} & \vdots & \vdots \\ & & & & \frac{\sqrt{\frac{4}{5}}}{\sqrt{4 \times 5}} & \vdots & \vdots & \vdots \\ & & & & & \frac{\sqrt{\frac{3}{4}}}{\sqrt{4 \times 5}} & -\frac{1}{\sqrt{4 \times 5}} & \vdots \\ & & & & & & \frac{\sqrt{\frac{2}{3}}}{\sqrt{3 \times 4}} & -\frac{1}{\sqrt{3 \times 4}} \\ & & & & & & & \frac{\sqrt{\frac{1}{2}}}{\sqrt{2 \times 3}} \\ \frac{\sqrt{\frac{1}{2}}}{\sqrt{2 \times 3}} & -\frac{1}{\sqrt{2 \times 3}} & -\frac{1}{\sqrt{3 \times 4}} & -\frac{1}{\sqrt{4 \times 5}} & \vdots & -\frac{1}{\sqrt{(L-2) \times (L-1)}} & -\frac{1}{\sqrt{(L-1) \times L}} & \frac{1}{\sqrt{L}} \end{bmatrix} \in \mathbb{R}^{L \times L}. \quad (74)$$

The above  $U$  gives us the SVD of  $A$  which is  $A = UDU^\top$ . Note that  $U^\top = U^{-1}$  by orthogonality of  $U$  and the diagonalization of  $A$  is given by  $D = U^{-1}AU^{-\top} = U^\top AU$ . Under the change of variable  $\vec{t} = U\vec{y}$ , the quadratic form  $\vec{t}^\top A\vec{t}$  becomes a diagonal form  $\vec{y}^\top D\vec{y}$  and the RHS of Equation (73) becomes

$$\frac{1}{2^L} \int_{[-1,1]^L} \exp(-K^2 \lambda \vec{t}^\top A \vec{t}) d\vec{t} = \frac{1}{2^L} \int_{U^{-1}[-1,1]^L} \exp(-K^2 \lambda (U\vec{y})^\top A (U\vec{y})) \cdot |\det(U)| d\vec{y} \quad (75)$$

$$= \frac{1}{2^L} \int_{U^\top[-1,1]^L} \exp(-K^2 \lambda \vec{y}^\top (U^\top A U) \vec{y}) d\vec{y} \quad (76)$$

$$= \frac{1}{2^L} \int_{U^\top[-1,1]^L} \exp(-K^2 \lambda \vec{y}^\top D \vec{y}) d\vec{y} \\ = \frac{1}{2^L} \int_{U^\top[-1,1]^L} \exp\left(-K^2 \lambda \sum_{i=1}^{L-1} \vec{t}(i)^2\right) d\vec{t}. \quad (77)$$

Equation (75) is by Lemma 7. In Equation (76), we use the facts that  $U^{-1} = U^\top$  and  $|\det(U)| = 1$ .

### B. Laplace's method

To compute Equation (77), we note that the integral is degenerate along the direction of the last coordinate  $\vec{t}(L)$ . Since the integral domain is bounded, the integral is still finite. We first integrate out  $\vec{t}(L)$  and get an  $(L-1)$ -dimensional integral w.r.t.  $\vec{t}(1), \dots, \vec{t}(L-1)$ . To this end, observe that for  $\vec{t} \in U[-1,1]^L$ , the last component  $\vec{t}(L)$  is a function of  $\vec{t}(1), \dots, \vec{t}(L-1)$  and it can take any value of the last coordinate of  $U^\top[-1,1]^L$ . Therefore the range of  $\vec{t}(L)$  can be written as  $[g_1(\vec{t}(1), \dots, \vec{t}(L-1)), g_2(\vec{t}(1), \dots, \vec{t}(L-1))]$  where  $g_1(\cdot)$  and  $g_2(\cdot)$  are piecewise linear continuous functions given by  $U$ . We now integrate out  $\vec{t}(L)$  and get

$$\int_{(U^\top[-1,1]^L)|_{[t_1, \dots, t_{L-1}]}} e^{-K^2 \lambda \sum_{i=1}^{L-1} t_i^2} (g_2(t_1, \dots, t_{L-1}) - g_1(t_1, \dots, t_{L-1})) d(t_1, \dots, t_{L-1}), \quad (78)$$

where  $(U^\top[-1,1]^L)|_{[t_1, \dots, t_{L-1}]} \subset \mathbb{R}^{L-1}$  denotes the set obtained by restricting each vector in  $U^\top[-1,1]^L \subset \mathbb{R}^L$  to the first  $L-1$  coordinates  $(t_1, \dots, t_{L-1})$ .

Note that the quadratic function  $f(t_1, \dots, t_{L-1}) := \lambda \sum_{i=1}^{L-1} t_i^2$  is nonnegative and attains its unique minimum (which is zero) at  $[t_1, \dots, t_{L-1}] = [0, \dots, 0]$  which is in the interior of  $U^\top[-1,1]^L$ . Therefore, by Laplace's method (Theorem 10), Equation (78) converges to

$$\left(\frac{2\pi}{K^2}\right)^{\frac{L-1}{2}} \frac{g_2(0, \dots, 0) - g_1(0, \dots, 0)}{\sqrt{\det((\text{Hess } f)(0, \dots, 0))}}$$

as  $K \rightarrow \infty$ . Since  $\text{Hess } f = 2\lambda I_{L-1} > 0$ , we have

$$\left(\frac{2\pi}{K^2}\right)^{\frac{L-1}{2}} \frac{g_2(0, \dots, 0) - g_1(0, \dots, 0)}{\sqrt{(2\lambda)^{L-1}}} = \left(\frac{\pi}{K^2\lambda}\right)^{\frac{L-1}{2}} (g_2(0, \dots, 0) - g_1(0, \dots, 0)).$$

Note that  $g_2(0, \dots, 0) - g_1(0, \dots, 0)$  is nothing but the length of the range of the last coordinate  $t_{L-1}$  of vectors in  $U^\top[-1, 1]^L$ . Since any vector  $\vec{t} \in U^\top[-1, 1]^L$  can be written as  $U^\top \vec{u}$  for some  $\vec{u} \in [-1, 1]^L$ , the length of the range of the last coordinate of  $\vec{t}$  is twice the  $\ell_1$ -norm of the last row of  $U^\top$ , i.e., the last column of  $U$ . From [Equation \(74\)](#), it is not hard to see that

$$g_2(0, \dots, 0) - g_1(0, \dots, 0) = 2 \cdot L \cdot \frac{1}{\sqrt{L}} = 2\sqrt{L}. \quad (79)$$

Finally, we get that [Equation \(78\)](#) (asymptotically) equals

$$\left(\frac{\pi}{K^2\lambda}\right)^{\frac{L-1}{2}} \cdot 2\sqrt{L}. \quad (80)$$

Let

$$E(K) := - \lim_{n \rightarrow \infty} \frac{1}{n} \ln \Pr[\overline{\text{rad}}(\mathbf{x}_1, \dots, \mathbf{x}_L) \leq nN]$$

be the exponent of [Equation \(70\)](#). Plugging [Equation \(80\)](#) back to [Equation \(77\)](#) and then back to [Equation \(72\)](#), we have

$$\begin{aligned} E(K) &= \max_{\lambda \geq 0} \left\{ -\lambda LN - \ln \left( \frac{1}{2L} \cdot \left( \frac{\pi}{K^2\lambda} \right)^{\frac{L-1}{2}} \cdot 2\sqrt{L} \right) \right\} \\ &= \max_{\lambda \geq 0} \left\{ -\lambda LN - \ln \left( \left( \frac{\pi}{(2K)^2\lambda} \right)^{\frac{L-1}{2}} \sqrt{L} \right) \right\} \\ &= \max_{\lambda \geq 0} \left\{ -LN\lambda + \frac{L-1}{2} \ln \lambda + (L-1) \ln(2K) - \frac{L-1}{2} \ln \pi - \frac{1}{2} \ln L \right\} \\ &= \max_{\lambda \geq 0} \left\{ -LN\lambda + \frac{L-1}{2} \ln \lambda \right\} + (L-1) \ln(2K) - \frac{L-1}{2} \ln \pi - \frac{1}{2} \ln L \end{aligned} \quad (81)$$

$$= -\frac{L-1}{2} + \frac{L-1}{2} \ln \frac{L-1}{2LN} - \frac{L-1}{2} \ln \pi + (L-1) \ln(2K) - \frac{1}{2} \ln L \quad (82)$$

$$= \frac{L-1}{2} \ln \frac{L-1}{2\pi eNL} - \frac{1}{2} \ln L + (L-1) \ln(2K). \quad (83)$$

[Equation \(82\)](#) follows since the function of  $\lambda$  in the maximization in [Equation \(81\)](#) is convex and attains its maximum at  $\lambda = \frac{L-1}{2LN}$ .

### C. Putting things together

Since, by the definition of PPPs ([Definition 3](#)), the number  $M$  of points in  $\mathcal{A}$  is Poissonly distributed with mean  $\lambda|\mathcal{A}| = \lambda(2K)^n$ , the expected number of lists with average radius at most  $nN$  is

$$\begin{aligned} &\mathbb{E} \left[ \left| \left\{ \mathcal{L} \in \binom{\mathcal{C} \cap \mathcal{A}}{L} : \overline{\text{rad}}(\mathcal{L}) \leq nN \right\} \right| \right] \\ &= \mathbb{E} \left[ \mathbb{E} \left[ \left| \left\{ \mathcal{L} \in \binom{[M]}{L} : \overline{\text{rad}}(\{\mathbf{x}_i\}_{i \in \mathcal{L}}) \leq nN \right\} \right| \middle| M \right] \right] \\ &\doteq \mathbb{E} \left[ \binom{M}{L} e^{-nE(K)} \right] \\ &= e^{-nE(K)} \mathbb{E} \left[ \binom{M}{L} \right] \\ &= e^{-nE(K)} \sum_{m=L}^{\infty} e^{-\lambda|\mathcal{A}|} \frac{(\lambda|\mathcal{A}|)^m}{m!} \binom{m}{L} \end{aligned} \quad (84)$$

$$\begin{aligned}
&= e^{-nE(K)} \sum_{m=L}^{\infty} e^{-\lambda|\mathcal{A}|} \frac{(\lambda|\mathcal{A}|)^m}{L!(m-L)!} \\
&= \frac{e^{-nE(K)}}{L!} \sum_{\ell=0}^{\infty} e^{-\lambda|\mathcal{A}|} \frac{(\lambda|\mathcal{A}|)^{\ell+L}}{\ell!} \tag{85}
\end{aligned}$$

$$= \frac{(\lambda|\mathcal{A}|)^L e^{-nE(K)}}{L!} \sum_{\ell=0}^{\infty} e^{-\lambda|\mathcal{A}|} \frac{(\lambda|\mathcal{A}|)^{\ell}}{\ell!} \tag{86}$$

$$\begin{aligned}
&= \frac{(\lambda|\mathcal{A}|)^L e^{-nE(K)}}{L!} \\
&= \frac{\lambda^L (2K)^{nL} e^{-nE(K)}}{L!}. \tag{87}
\end{aligned}$$

Equation (84) follows from law of total expectation where the outer expectation is over  $M \sim \text{Pois}(\lambda|\mathcal{A}|)$  and the inner expectation is over  $\underline{x}_i \stackrel{\text{i.i.d.}}{\sim} \text{Unif}(\mathcal{A})$  for  $1 \leq i \leq M$ . In Equation (85), we change variable  $\ell = m - L$ . In Equation (86), the summation equals one since it is the total probability of a Poisson random variable with mean  $\lambda|\mathcal{A}|$ .

We now set  $\lambda$  in such a way that Equation (87) is at most  $\frac{1}{2}\mathbb{E}[M] = \frac{1}{2}\lambda|\mathcal{A}| = \frac{1}{2}\lambda(2K)^n$ . That is,

$$\begin{aligned}
&\frac{1}{2}\lambda(2K)^n \geq \frac{\lambda^L (2K)^{nL} e^{-nE(K)}}{L!} \\
\iff &L!/2 \geq \lambda^{L-1} (2K)^{(L-1)n} e^{-nE(K)} \\
\iff &\lambda \leq (L!/2)^{\frac{1}{L-1}} \frac{e^{nE(K)/(L-1)}}{(2K)^n} \\
&= (L!/2)^{\frac{1}{L-1}} e^{n\left(\frac{E(K)}{L-1} - \ln(2K)\right)} \\
&= (L!/2)^{\frac{1}{L-1}} \exp\left(n\left(\frac{1}{2} \ln \frac{L-1}{2\pi eNL} - \frac{1}{2(L-1)} \ln L\right)\right). \tag{88}
\end{aligned}$$

After expurgating out one codeword from each bad list, we get an  $(N, L-1)$ -average-radius multiple packing of size at least  $\frac{1}{2}\mathbb{E}[M]$  and the density is therefore at least

$$\frac{1}{n} \ln \frac{\frac{1}{2}\mathbb{E}[M]}{|\mathcal{A}|} = \frac{1}{n} \ln \frac{\frac{1}{2}\lambda|\mathcal{A}|}{|\mathcal{A}|} = \frac{1}{n} \ln \frac{\lambda}{2}. \tag{89}$$

Substituting Equation (89) here, we get the following lower bound on the density

$$\frac{1}{2} \ln \frac{L-1}{2\pi eNL} - \frac{1}{2(L-1)} \ln L,$$

as promised in Theorem 31.

#### D. Connections

We managed to compute the exact asymptotics (up to lower order terms in the exponent) of the tail probability given by Equation (71). The way we did so is by applying the large deviation principle and performing ad hoc calculations on the moment generating function of the random quadratic form of interest. From the perspective of concentration of measure, the tail probability we computed can be cast from several different angles:

- 1) Gaussian integral w.r.t. a general (non-identity) degenerate covariance matrix  $A$ ;
- 2) Concentration of the uniform measure on a solid cube (a useful trick for which is to push it forward to the Gaussian measure and apply Lipschitz concentration [Bob10]);
- 3) The (standard) Gaussian measure of a parallelepiped defined by the linear transformation  $U$ ;
- 4) The probability that a Gaussian (with zero mean and general covariance matrix) lies in a cube;
- 5) Hanson–Wright inequality for quadratic forms in subgaussian random vectors [Ver18] which, in our case, are uniform vectors in a solid cube.

We tried all the above black-box technologies. However, they do not seem to yield the correct exponent, at least in their vanilla forms, though they may give certain exponentially decaying bounds. Therefore, we feel that Equation (71) is a cute example for which standard concentration tools are not able to produce the optimal bound.



### E. Mistakes in [Bli05b]

The paper [Bli05b] also analyzed the list-decodability of expurgated PPPs and somehow arrived at the same bound (Equation (69)) as ours. Although our proof also involves analyzing the tail probability of the average radius (Equation (70)), our techniques are different. From our understanding of [Bli05b], we believe that there are some flaws which are outlined below.

Let  $\mathcal{C}$  be a PPP (without expurgation yet) and  $K \in \mathbb{R}$ . Let  $\underline{x}_1, \dots, \underline{x}_L \in \mathcal{C} \cap [-K, K]^n$  be an  $L$ -list. Recall that they are independent and uniformly distributed in  $[-K, K]^n$ . Let  $\underline{x} = \frac{1}{L} \sum_{i=1}^L \underline{x}_i$  denote the centroid of the list. To compute Equation (70), [Bli05b] first claims that one can apply an orthogonal transformation  $\underline{x}_i \mapsto \underline{u}_i$  ( $1 \leq i \leq L$ ) to the list so that  $\frac{1}{L} \|\underline{u}_1\|_2 = \|\underline{x}\|_2$  where  $\underline{u} := \frac{1}{L} \sum_{i=1}^L \|\underline{u}_i\|_2$ . However, this is in general impossible since an orthogonal transformation only reflects and/or rotates the list, but does not translate it.

From our understanding of the paper [Bli05b], the ideas can be interpreted as follows. Since the average radius is invariant under rigid transformations (i.e., translations, rotations, reflections and their combination) and a homogeneous PPP is stationary and isotropic (Fact 16), [Bli05b] attempts to transform the list rigidly so that the resulting average radius admits a simpler expression and the list is still independent and uniformly distributed in the cube.

However, this leads to a problem. In fact, we *can* find a shift  $\underline{a} \in \mathbb{R}^n$  such that the translation  $\underline{x}_i \mapsto \underline{u}_i := \underline{x}_i + \underline{a}$  ( $1 \leq i \leq L$ ) satisfies

$$\frac{1}{L} \|\underline{u}_1\|_2 = \|\underline{u}\|_2. \quad (90)$$

Under this translation, the average radius becomes

$$\overline{\text{rad}}(\underline{x}_1, \dots, \underline{x}_L) = \overline{\text{rad}}(\underline{u}_1, \dots, \underline{u}_L) = \frac{1}{L} \sum_{i=1}^L \|\underline{u}_i\|_2^2 - \|\underline{u}\|_2^2 = \frac{1}{L} \sum_{i=2}^L \|\underline{u}_i\|_2^2. \quad (91)$$

However, the issue is that  $\underline{u}_1, \dots, \underline{u}_L$  are no longer independent and uniformly distributed in a cube since the shift  $\underline{a}$  (which can be solved from Equation (90)) depends on the list  $\underline{x}_1, \dots, \underline{x}_L$ ! This invalidates the remainder of the calculations in [Bli05b], which assume that  $\underline{u}_1, \dots, \underline{u}_L$  are i.i.d.

In short, we claim that the preprocessing argument in [Bli05b] cannot work since there does not exist a rigid transformation that satisfies the following two conditions *simultaneously*: (i) Equation (91) holds; (ii) it preserves the distribution of the list.

## XIII. LOWER BOUNDS VIA REDUCTION TO SPHERE PACKING

In [BF63, Theorem 2], Blachman and Few proved another lower bound on the  $(P, N, L-1)$ -list-decoding capacity. Their observation is that a sphere packing is going to be  $(L-1)$ -list-decodable if we suitably dilate the balls so that they have multiplicity of overlap at most  $L-1$ . The key lemma they used is the following by Few [Few64, Theorem 2]. We reproduce it here with a simpler proof and use it to get lower bounds on the  $(P, N, L-1)$ -list-decoding capacity and the  $(N, L-1)$ -list-decoding capacity.

**Lemma 32.** *Let  $P, N > 0$ . If  $\mathcal{C} \subset \mathbb{R}^n$  is a  $(P, N, 1)$ -sphere packing, then it is also a  $(P, N', L)$ -multiple packing for any  $0 \leq N' < \frac{2(L-1)N}{L}$  and  $L \in \mathbb{Z}_{\geq 2}$ .*

*Proof.* The proof is by contradiction. Suppose the conclusion of the lemma does not hold. Then we can find an  $L$ -list  $\underline{x}_1, \dots, \underline{x}_L \in \mathcal{C}$  satisfying  $\text{rad}(\underline{x}_1, \dots, \underline{x}_L) \leq nN'$ . On the other hand,

$$\text{rad}(\underline{x}_1, \dots, \underline{x}_L) \geq \overline{\text{rad}}(\underline{x}_1, \dots, \underline{x}_L) = \frac{1}{2L^2} \sum_{(i,j) \in [L]^2: i \neq j} \|\underline{x}_i - \underline{x}_j\|_2^2 \geq \frac{1}{2L^2} L(L-1) (2\sqrt{nN})^2 = \frac{2(L-1)}{L} nN$$

where the first equality is by Equation (46). This is a contradiction for  $N' < \frac{2(L-1)}{L} N$  and the proof is completed.  $\square$

We can combine the above lemma with the following lower bound on sphere packing density to get a lower bound on the  $(P, N, L-1)$ -list-decoding capacity for any  $L \in \mathbb{Z}_{\geq 2}$ . It is well-known (see, e.g., [Bla62]) that the  $(P, N, 1)$ -sphere packing density is lower bounded as follows.

**Theorem 33** ([Bla62]). *Let  $N, P > 0$  such that  $N \leq P/2$ . There exist spherical codes on  $\mathcal{B}^n(\sqrt{nP})$  of minimum distance at least  $2\sqrt{nN}$  and rate at least  $\frac{1}{2} \ln \frac{P^2}{4N(P-N)}$ .*

Combining [Lemma 32](#) and [Theorem 33](#), we immediately get:

**Theorem 34.** *Let  $P, N > 0$  such that  $N \leq \frac{L-1}{L}P$ . Let  $L \in \mathbb{Z}_{\geq 2}$ . The  $(P, N, L-1)$ -list-decoding capacity  $C_{L-1}(P, N)$  is at least  $\frac{1}{2} \ln \frac{(L-1)^2 P^2}{LN(2(L-1)P-LN)}$ .*

*Proof.* Replace  $N$  in the bound in [Theorem 33](#) by  $\frac{LN}{2(L-1)}$ . □

*Remark 13.* The above bound converges to  $\frac{1}{2} \ln \frac{P^2}{N(2P-N)}$  as  $L \rightarrow \infty$  which is lower than the list-decoding capacity  $\frac{1}{2} \ln \frac{P}{N}$  for  $L \rightarrow \infty$  (see [Section XVI](#)). On the other hand, the above bound recovers the best known bound  $\frac{1}{2} \ln \frac{P^2}{4P(P-N)}$  in [Theorem 33](#) for  $L = 2$ . This is not surprising since the above bound is obtained from the bound for  $L = 2$ . The above bound attains the tight values  $\infty$  and  $0$  at two special points  $N/P = 0$  and  $N/P = \frac{L-1}{L}$  (see [Section XV](#) for the *Plotkin point*), respectively.

In the proof of [Lemma 32](#), we never assumed anything about the norm of each point, therefore the lemma also holds for unbounded packings.

It is well-known that the  $(N, L-1)$ -list-decoding capacity is lower bounded as follows.

**Theorem 35.** *Let  $N > 0$ . The  $(N, 1)$ -sphere packing density is lower bounded by  $\frac{1}{2} \ln \frac{1}{8\pi eN}$ .*

Combining [Lemma 32](#) and [Theorem 35](#), we immediately get:

**Theorem 36.** *Let  $N > 0$  and  $L \in \mathbb{Z}_{\geq 2}$ . The  $(N, L-1)$ -list-decoding capacity  $C_{L-1}(N)$  is at least  $\frac{1}{2} \ln \frac{L-1}{4\pi eLN}$ .*

*Remark 14.* The above bound converges to  $\frac{1}{2} \ln \frac{1}{4\pi eN}$  as  $L \rightarrow \infty$  which is lower than the list-decoding capacity  $\frac{1}{2} \ln \frac{1}{2\pi eN}$  for  $L \rightarrow \infty$  (see [Section XVI](#)). When  $L = 2$ , the above bound recovers the best known bound  $\frac{1}{2} \ln \frac{1}{8\pi eN}$  in [Theorem 35](#).

Finally, we comment on the average-radius version of [Lemma 32](#). Since the proof of [Lemma 32](#) lower bounds the Chebyshev radius by average radius, the same conclusion actually also holds for the stronger notion of average-radius multiple packing.

**Lemma 37.** *Let  $P, N > 0$ . If  $\mathcal{C} \subset \mathbb{R}^n$  is a  $(P, N, 1)$ -sphere packing, then it is also a  $(P, N', L)$ -average-radius multiple packing for any  $0 \leq N' < \frac{2(L-1)N}{L}$  and  $L \in \mathbb{Z}_{\geq 2}$ .*

Since the  $(L-1)$ -average-radius list-decodability and the (regular)  $(L-1)$ -list-decodability coincide for  $L = 2$ , [Theorems 33](#) and [35](#) also hold under the former notion. Combining them with [Lemma 37](#), we can strengthen [Theorems 34](#) and [36](#) to the average-radius case.

**Theorem 38.** *Let  $P, N > 0$  such that  $N \leq \frac{L-1}{L}P$ . Let  $L \in \mathbb{Z}_{\geq 2}$ . The  $(P, N, L-1)$ -average-radius list-decoding capacity  $\overline{C}_{L-1}(P, N)$  is at least  $\frac{1}{2} \ln \frac{(L-1)^2 P^2}{LN(2(L-1)P-LN)}$ .*

**Theorem 39.** *Let  $N > 0$  and  $L \in \mathbb{Z}_{\geq 2}$ . The  $(N, L-1)$ -average-radius list-decoding capacity  $\overline{C}_{L-1}(N)$  is at least  $\frac{1}{2} \ln \frac{L-1}{4\pi eLN}$ .*

#### XIV. LOWER BOUNDS VIA ERROR EXPONENTS

In this section, we will show the following lower bound on  $C_{L-1}(P, N)$ .

**Theorem 40.** *For any  $P, N > 0$  such that  $N \leq \frac{L-1}{L}P$  and any  $L \in \mathbb{Z}_{\geq 2}$ , the  $(P, N, L-1)$ -list-decoding capacity  $C_{L-1}(P, N)$  is at least*

$$C_{L-1}(P, N) \geq \frac{1}{2} \left[ \ln \frac{(L-1)P}{LN} + \frac{1}{L-1} \ln \frac{P}{L(P-N)} \right]. \quad (92)$$

*Remark 15.* When  $L \rightarrow \infty$ , the above bound ([Equation \(92\)](#)) converges to the list-decoding capacity  $\frac{1}{2} \ln \frac{P}{N}$  for  $L \rightarrow \infty$  (see [Section XVI](#)). For  $L = 2$ , it recovers the best known bound  $\frac{1}{2} \ln \frac{P^2}{4N(P-N)}$  in [Theorem 33](#). Furthermore,

it is tight at  $N/P = 0$  where the optimal density is  $\infty$  and  $N/P = \frac{L-1}{L}$  where the optimal density is 0 (see [Section XV](#) for the *Plotkin point*).

To handle the Chebyshev radius, we follow an indirect approach which relates the Chebyshev radius to a quantity called *error exponent*. To this end, we take a detour by first introducing the notion of error exponent and then presenting bounds on it. We find it curious that the  $(P, N, L-1)$ -list-decodability against *worst-case* errors can be related to the error exponent of a *Gaussian* channel that only inflicts *average-case* errors.

Consider a Gaussian channel  $\underline{y} = \underline{x} + \underline{g}$  where the input  $\underline{x}$  satisfies  $\|\underline{x}\|_2 \leq \sqrt{nP}$  and  $\underline{g} \sim \mathcal{N}(\underline{0}, \sigma^2 I_n)$  is an additive white Gaussian noise. Let  $\mathcal{C} = \{\underline{x}_i\}_{i=1}^M$  be a codebook for the above Gaussian channel, that is,  $\|\underline{x}_i\|_2 \leq \sqrt{nP}$  for all  $1 \leq i \leq M$ . We are interested in the *probability of  $(L-1)$ -list-decoding error* of  $\mathcal{C}$  under the *maximum likelihood (ML)  $(L-1)$ -list-decoder*. Formally, let  $\text{Dec}_{L-1, \mathcal{C}}^{\text{ML}}: \mathbb{R}^n \rightarrow \binom{\mathcal{C}}{L-1}$  denote the ML  $(L-1)$ -list-decoder. Given  $\underline{y}$ , the ML list-decoder outputs the list of the nearest  $L-1$  codewords in  $\mathcal{C}$  to  $\underline{y}$ . We say that an  $(L-1)$ -list-decoding error occurs if  $\underline{x}_i$  was transmitted whereas it is not output by the list-decoder, i.e.,  $\text{Dec}_{L-1, \mathcal{C}}^{\text{ML}}(\underline{x}_i + \underline{g}) \not\supset \underline{x}_i$ . Define the *average (over codewords) probability of  $(L-1)$ -list-decoding error* of  $\mathcal{C}$  under  $\text{Dec}_{L-1, \mathcal{C}}^{\text{ML}}$  as

$$P_{\text{e,avg},L-1}^{\text{ML}}(\mathcal{C}) := \frac{1}{M} \sum_{i=1}^M P_{\text{e},L-1}^{\text{ML}}(i, \mathcal{C}),$$

where

$$\begin{aligned} P_{\text{e},L-1}^{\text{ML}}(i, \mathcal{C}) &:= \Pr[\text{Dec}_{L-1, \mathcal{C}}^{\text{ML}}(\underline{x}_i + \underline{g}) \not\supset \underline{x}_i] \\ &= \Pr\left[\exists \{i_1, \dots, i_{L-1}\} \in \binom{[M] \setminus \{i\}}{L-1}, \forall j \in [L-1], \|\underline{x}_{i_j} - (\underline{x}_i + \underline{g})\|_2 < \|\underline{g}\|_2\right]. \end{aligned}$$

Occasionally, we also write  $P_{\text{e},L-1}^{\text{ML}}(\underline{x}_i, \mathcal{C})$  to denote the same quantity above.

**Theorem 41.** *For any code  $\mathcal{C} = \{\underline{x}_i\}_{i=1}^M$ , there exists a subcode  $\mathcal{C}' \subset \mathcal{C}$  of size  $M' := |\mathcal{C}'| \geq M/2$  such that for all  $\mathcal{L} \in \binom{\mathcal{C}'}{L}$ ,*

$$P_{\text{e,avg},L-1}^{\text{ML}}(\mathcal{L}) \leq 2P_{\text{e,avg},L-1}^{\text{ML}}(\mathcal{C}),$$

where

$$P_{\text{e,avg},L-1}^{\text{ML}}(\mathcal{L}) := \frac{1}{L} \sum_{\underline{x} \in \mathcal{L}} P_{\text{e},L-1}^{\text{ML}}(\underline{x}, \mathcal{L}),$$

and

$$P_{\text{e},L-1}^{\text{ML}}(\underline{x}, \mathcal{L}) := \Pr[\text{Dec}_{L-1, \mathcal{L}}^{\text{ML}}(\underline{x} + \underline{g}) \not\supset \underline{x}] = \Pr[\forall \underline{x}' \in \mathcal{L} \setminus \{\underline{x}\}, \|\underline{x}' - (\underline{x} + \underline{g})\|_2 < \|\underline{g}\|_2].$$

*Proof.* Without loss of generality, assume that the codewords in  $\mathcal{C}$  are listed according to ascending order of  $P_{\text{e},L-1}^{\text{ML}}(i, \mathcal{C})$ , that is,

$$P_{\text{e},L-1}^{\text{ML}}(1, \mathcal{C}) \leq P_{\text{e},L-1}^{\text{ML}}(2, \mathcal{C}) \leq \dots \leq P_{\text{e},L-1}^{\text{ML}}(M, \mathcal{C}).$$

By Markov's inequality ([Lemma 2](#)), each of the first (at least)  $M/2$  codewords has probability of error at most  $2P_{\text{e,avg},L-1}^{\text{ML}}(\mathcal{C})$ . Let  $\mathcal{C}' := \{\underline{x}_i\}_{i=1}^{M/2} \subset \mathcal{C}$ . Take any  $\mathcal{L} \in \binom{\mathcal{C}'}{L}$  and any  $\underline{x} \in \mathcal{L}$ .

$$\begin{aligned} P_{\text{e},L-1}^{\text{ML}}(\underline{x}, \mathcal{L}) &= \Pr\left[\forall \underline{x}' \in \mathcal{L} \setminus \{\underline{x}\}, \|\underline{x}' - (\underline{x} + \underline{g})\|_2 < \|\underline{g}\|_2\right] \\ &\leq \Pr\left[\bigcup_{\mathcal{L}' \in \binom{\mathcal{C}' \setminus \{\underline{x}\}}{L-1}} \left\{ \forall \underline{x}' \in \mathcal{L}', \|\underline{x}' - (\underline{x} + \underline{g})\|_2 < \|\underline{g}\|_2 \right\}\right] \\ &= P_{\text{e},L-1}^{\text{ML}}(\underline{x}, \mathcal{C}') \\ &\leq 2P_{\text{e,avg},L-1}^{\text{ML}}(\mathcal{C}). \end{aligned}$$

Therefore

$$P_{\text{e,avg},L-1}^{\text{ML}}(\mathcal{L}) \leq 2P_{\text{e,avg},L-1}^{\text{ML}}(\mathcal{C}),$$

which finishes the proof.  $\square$

**Theorem 42.** Let  $\mathcal{L} = \{\underline{x}_1, \dots, \underline{x}_L\} \subset \mathbb{R}^n$  be an arbitrary set of  $L$  (where  $L \geq 2$ ) points in  $\mathbb{R}^n$  satisfying (i) there exists a constant  $C > 0$  independent of  $n$  such that  $\|\underline{x}_i\|_2 \leq \sqrt{nC}$  for all  $1 \leq i \leq L$ ; (ii) there exists a constant  $c > 0$  independent of  $n$  such that  $\|\underline{x}_i - \underline{x}_j\|_2 \geq \sqrt{nc}$  for all  $1 \leq i \neq j \leq L$ . Then

$$P_{e,\text{avg},L-1}^{\text{ML}}(\mathcal{L}) \geq \exp\left(-\frac{\text{rad}(\mathcal{L})}{2\sigma^2} - o(n)\right). \quad (93)$$

Note that the case where  $L-1 = 1$  is trivial which corresponds to unique-decoding. Indeed, suppose  $\mathcal{L} = \{\underline{x}_1, \underline{x}_2\}$ . Without loss of generality, assume  $\underline{x}_1 = \underline{0} \in \mathbb{R}^n$  and  $\underline{x}_2 = [a, 0, \dots, 0] \in \mathbb{R}^n$  for some  $a \geq \sqrt{nc}$ . It is not hard to see that

$$\begin{aligned} P_{e,1}^{\text{ML}}(\underline{x}_1, \mathcal{L}) &= \Pr\left[\|\underline{x}_2 - (\underline{x}_1 + \underline{\mathbf{g}})\|_2 < \|\underline{\mathbf{g}}\|_2\right] \\ &= \Pr\left[\|\underline{x}_2 - \underline{\mathbf{g}}\|_2^2 < \|\underline{\mathbf{g}}\|_2^2\right] \\ &= \Pr\left[(a - \underline{\mathbf{g}}(1))^2 < \underline{\mathbf{g}}(1)^2\right] \\ &= \Pr\left[\underline{\mathbf{g}}(1) > a/2\right] \\ &= \exp\left(-\frac{(a/2)^2}{2\sigma^2} - o(n)\right). \end{aligned}$$

The last equality is by [Lemma 5](#). By symmetry,  $P_{e,1}^{\text{ML}}(\underline{x}_1, \mathcal{L}) = P_{e,1}^{\text{ML}}(\underline{x}_2, \mathcal{L})$  both of which are equal to  $P_{e,\text{avg},1}^{\text{ML}}(\mathcal{L})$ . Since  $\sqrt{\text{rad}(\{\underline{x}_1, \underline{x}_2\})} = \frac{1}{2}\|\underline{x}_1 - \underline{x}_2\|_2 = a/2$ , we see that [Theorem 42](#) holds for  $L-1 = 1$ .

In the proceeding two subsections, we first present in [Section XIV-A](#) the proof of [Theorem 42](#) for the special case of  $L-1 = 2$  which exhibits a simpler geometric structure and admits more explicit calculations. In fact we will prove a stronger statement:

$$P_{e,\text{avg},2}^{\text{ML}}(\{\underline{x}_1, \underline{x}_2, \underline{x}_3\}) = \exp\left(-\frac{\text{rad}(\underline{x}_1, \underline{x}_2, \underline{x}_3)}{2\sigma^2} - o(n)\right).$$

We then prove [Theorem 42](#) in [Section XIV-B](#) for general  $L-1 \geq 2$  using the Laplace's method ([Theorem 9](#)).

#### A. Special case where $L-1 = 2$

1) *Voronoi partition and higher-order Voronoi partition:* We first introduce the notion of *Voronoi partition* induced by a point set and its *higher-order* generalization. Let  $\mathcal{C} \subset \mathbb{R}^n$  be a discrete set of points. The *Voronoi region*  $\mathcal{V}_{\mathcal{C}}(\underline{x})$  associated with  $\underline{x} \in \mathcal{C}$  is defined as the region in which any point is closer to  $\underline{x}$  than to any other points in  $\mathcal{C}$ , i.e.,

$$\mathcal{V}_{\mathcal{C}}(\underline{x}) := \left\{ \underline{y} \in \mathbb{R}^n : \forall \underline{x}' \in \mathcal{C} \setminus \{\underline{x}\}, \|\underline{y} - \underline{x}'\|_2 > \|\underline{y} - \underline{x}\|_2 \right\}.$$

When the underlying point set  $\mathcal{C}$  is clear from the context, we write  $\mathcal{V}(\underline{x})$  for  $\mathcal{V}_{\mathcal{C}}(\underline{x})$ . Clearly,  $\mathcal{V}_{\mathcal{C}}(\underline{x}) \cap \mathcal{V}_{\mathcal{C}}(\underline{x}') = \emptyset$  for  $\underline{x} \neq \underline{x}' \in \mathcal{C}$  and  $\bigcup_{\underline{x} \in \mathcal{C}} \mathcal{V}_{\mathcal{C}}(\underline{x}) = \mathbb{R}^n$ . The collection of Voronoi regions induced by  $\mathcal{C}$  is called the *Voronoi partition* induced by  $\mathcal{C}$ . It is not hard to see that for any  $\mathcal{C} \subset \mathbb{R}^n$  and any  $\underline{x} \in \mathbb{R}^n$ , there is exactly one point in  $\mathcal{V}_{\mathcal{C}}(\underline{x})$  from  $\mathcal{C}$  which is  $\underline{x}$  itself.

For any  $\underline{x} \in \mathcal{C}$ , to compute  $\mathcal{V}(\underline{x})$ , one can draw a hyperplane bisecting and perpendicular to the segment connecting  $\underline{x}$  and  $\underline{x}'$  for each  $\underline{x}' \in \mathcal{C} \setminus \{\underline{x}\}$ . Let  $\mathcal{H}_{\underline{x}'}(\underline{x})$  be the halfspace induced by the hyperplane that contains  $\underline{x}$ , i.e.,

$$\mathcal{H}_{\underline{x}'}(\underline{x}) := \left\{ \underline{y} \in \mathbb{R}^n : \langle \underline{y}, \underline{x} - \underline{x}' \rangle \geq \frac{\|\underline{x}\|_2^2 - \|\underline{x}'\|_2^2}{2} \right\}.$$

Then  $\mathcal{V}(\underline{x})$  is nothing but the intersection of all such halfspaces, i.e.,

$$\mathcal{V}_{\mathcal{C}}(\underline{x}) = \bigcap_{\underline{x}' \in \mathcal{C} \setminus \{\underline{x}\}} \mathcal{H}_{\underline{x}'}(\underline{x}).$$

More generally, one can define Voronoi regions associated with *subsets* of points in  $\mathcal{C}$ . Let  $L \in \mathbb{Z}_{\geq 1}$ . The *order- $L$  Voronoi region*  $\mathcal{V}_{\mathcal{C},L}(\mathcal{L})$  associated with  $\mathcal{L} \in \binom{\mathcal{C}}{L}$  is defined as the region such that the set of the nearest  $L$  points from  $\mathcal{C}$  to any point in the region is  $\mathcal{L}$ , i.e.,

$$\mathcal{V}_{\mathcal{C},L}(\mathcal{L}) := \left\{ \underline{y} \in \mathbb{R}^n : \forall \underline{x}' \in \mathcal{C} \setminus \mathcal{L}, \|\underline{y} - \underline{x}'\|_2 > \max_{\underline{x} \in \mathcal{L}} \|\underline{y} - \underline{x}\|_2 \right\}. \quad (94)$$

Again, we will ignore the subscripts if they are clear. If  $\mathcal{L} = \{\underline{x}\}$  is a singleton set,  $\mathcal{V}_{\mathcal{C},1}(\{\underline{x}\}) = \mathcal{V}_{\mathcal{C}}(\underline{x})$ . Clearly,  $\mathcal{V}_{\mathcal{C},L}(\mathcal{L}) \cap \mathcal{V}_{\mathcal{C},L}(\mathcal{L}') = \emptyset$  for  $\mathcal{L} \neq \mathcal{L}' \in \binom{\mathcal{C}}{L}$  and  $\bigcup_{\mathcal{L} \in \binom{\mathcal{C}}{L}} \mathcal{V}_{\mathcal{C},L}(\mathcal{L}) = \mathbb{R}^n$ . The collection of order- $L$  Voronoi regions

induced by all  $L$ -subsets of  $\mathcal{C}$  is called the *order- $L$  Voronoi partition* induced by  $\mathcal{C}$ . Computing the order- $L$  Voronoi partition of a point set  $\mathcal{C} \subset \mathbb{R}^n$  is in general not easy for  $L > 1$ . Even when  $n = 2$ , i.e., all points in  $\mathcal{C}$  are on a plane, the problem is not trivial and the resulting order- $L$  Voronoi partition may exhibit significantly different behaviours from the  $L = 1$  case [Lee82, Fig. 2-5].

However, if one is given the order- $(L - 1)$  Voronoi partition of  $\mathcal{C}$  and the (first order) Voronoi partition for all sets  $\mathcal{C} \setminus \mathcal{L}'$  (where  $\mathcal{L}' \in \binom{\mathcal{C}}{L-1}$ ), then the order- $L$  Voronoi partition of  $\mathcal{C}$  can be computed in the following way. For  $\mathcal{L} \in \binom{\mathcal{C}}{L}$ , to compute  $\mathcal{V}_{\mathcal{C},L}(\mathcal{L})$ , for each  $\underline{x} \in \mathcal{L}$ , compute the following set  $\mathcal{V}_{\mathcal{C},L-1}(\mathcal{L} \setminus \{\underline{x}\}) \cap \mathcal{V}_{\mathcal{C} \setminus (\mathcal{L} \setminus \{\underline{x}\})}(\underline{x})$ . Then  $\mathcal{V}_{\mathcal{C},L}(\mathcal{L})$  is nothing but their unions, i.e.,

$$\mathcal{V}_{\mathcal{C},L}(\mathcal{L}) = \bigcup_{\underline{x} \in \mathcal{L}} \mathcal{V}_{\mathcal{C},L-1}(\mathcal{L} \setminus \{\underline{x}\}) \cap \mathcal{V}_{\mathcal{C} \setminus (\mathcal{L} \setminus \{\underline{x}\})}(\underline{x}).$$

Back to the task of estimating the probability of  $(L - 1)$ -list-decoding error of an  $L$ -list  $\mathcal{L} \subset \mathbb{R}^n$ , given the order- $(L - 1)$  Voronoi partition of  $\mathcal{L}$ , the error probability of any  $\underline{x} \in \mathcal{L}$  can be written as

$$P_{e,L-1}^{\text{ML}}(\underline{x}, \mathcal{L}) = \Pr[\underline{x} + \underline{\mathbf{g}} \in \mathcal{V}_{\mathcal{C},L-1}(\mathcal{L} \setminus \{\underline{x}\})], \quad (95)$$

i.e., the probability that  $\underline{x}$  is the furthest point to  $\underline{x} + \underline{\mathbf{g}}$  among  $\mathcal{C}$ .

Let  $\underline{x}_1, \underline{x}_2, \underline{x}_3$  be three distinct points in  $\mathbb{R}^n$ . In the proceeding two subsections, we divide the analysis of Equation (95) into two cases according to the largest angle of the triangle spanned by  $\underline{x}_1, \underline{x}_2, \underline{x}_3$ .

2) *The largest angle of the triangle spanned by  $\underline{x}_1, \underline{x}_2, \underline{x}_3$  is acute or right:* As shown in Figure 5, in this case, the smallest ball containing  $\underline{x}_1, \underline{x}_2, \underline{x}_3$  coincides with the circumscribed ball. As explained in Section XIV-A1, the Voronoi partition induced by  $\{\underline{x}_1, \underline{x}_2, \underline{x}_3\}$  can be easily computed and is depicted in the first figure of Figure 5. The second order Voronoi partition can be computed given the (first order) Voronoi partition. For example,  $\mathcal{V}(\underline{x}_1, \underline{x}_2)$  is comprised of the subregion in  $\mathcal{V}(\underline{x}_1)$  whose points are closer to  $\underline{x}_2$  (such a subregion can be computed by computing the Voronoi partition with  $\underline{x}_1$  removed) and the subregion in  $\mathcal{V}(\underline{x}_2)$  whose points are closer to  $\underline{x}_1$  (such a subregion can be computed by computing the Voronoi partition with  $\underline{x}_2$  removed). One observes that each of the resulting second order Voronoi regions may contain no (see  $\mathcal{V}(\underline{x}_2, \underline{x}_3)$ ), one (see  $\mathcal{V}(\underline{x}_1, \underline{x}_3)$ ) or two points (see  $\mathcal{V}(\underline{x}_1, \underline{x}_2)$ ) from the point set. This is in contrast with the (first order) Voronoi regions which only contain one point from the point set. In general, points can also be on the boundary of the higher-order Voronoi regions. This happens when, e.g.,  $\underline{x}_1, \underline{x}_2, \underline{x}_3$  span an equilateral triangle.

To show Theorem 42 in this case, we need to estimate  $P_{e,\text{avg},2}^{\text{ML}}(\{\underline{x}_1, \underline{x}_2, \underline{x}_3\})$ . Consider the plane containing  $\underline{x}_1, \underline{x}_2, \underline{x}_3$ . As depicted in Figure 6, let the center of the smallest ball containing  $\underline{x}_1, \underline{x}_2, \underline{x}_3$  be the origin, denoted by  $O$ . Let the ray going from  $\underline{x}_1$  to  $O$  be the  $x_1$  axis and the line perpendicular to it be the  $x_2$  axis. Under this parameterization,  $\|\underline{x}_1\|_2^2 = \|\underline{x}_2\|_2^2 = \|\underline{x}_3\|_2^2 = \text{rad}(\underline{x}_1, \underline{x}_2, \underline{x}_3)$  and  $\underline{x}_1(i) = \underline{x}_2(i) = \underline{x}_3(i) = 0$  for every  $3 \leq i \leq n$ .

Let us first estimate  $P_{e,2}^{\text{ML}}(\underline{x}_1, \{\underline{x}_1, \underline{x}_2, \underline{x}_3\})$ . Suppose that in the plane spanned by  $\underline{x}_1, \underline{x}_2, \underline{x}_3$ , the boundaries of  $\mathcal{V}(\underline{x}_2, \underline{x}_3)$  are given by two rays  $L_1$  and  $L_2$  as depicted in Figure 6. It is not hard to check that if the largest angle of the triangle spanned by the three points is acute or right, then  $\mathcal{V}(\underline{x}_2, \underline{x}_2)$  belongs to the halfspace  $\{x_2 \geq 0\}$  whereas  $\underline{x}_1$  belongs to the other halfspace  $\{x_2 \leq 0\}$ . Suppose  $L_1$  and  $L_2$  are parameterized by  $x_2 = a_1 x_1$  and  $x_2 =$

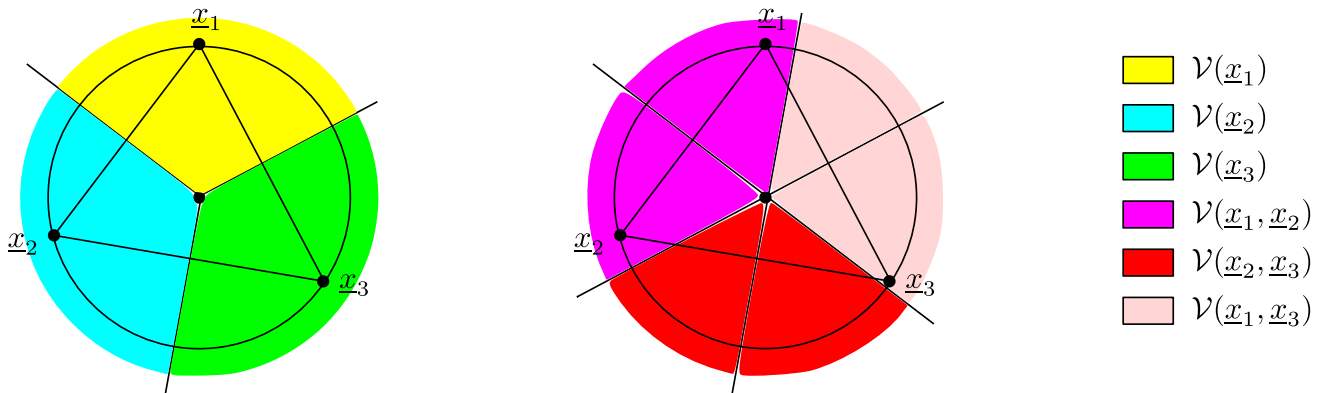

Fig. 5: The Voronoi partition (left) and the second order Voronoi partition (right) of  $\{\underline{x}_1, \underline{x}_2, \underline{x}_3\}$  when  $\underline{x}_1, \underline{x}_2, \underline{x}_3$  span an acute/right triangle. Note that in this case, the smallest ball containing  $\underline{x}_1, \underline{x}_2, \underline{x}_3$  coincides with the circumscribed ball. That is, all points lie on the boundary of the ball. We use the shorthand notation  $\mathcal{V}(\underline{x}_i) = \mathcal{V}_{\{\underline{x}_1, \underline{x}_2, \underline{x}_3\}}(\underline{x}_i)$  and  $\mathcal{V}(\underline{x}_i, \underline{x}_j) = \mathcal{V}_{\{\underline{x}_1, \underline{x}_2, \underline{x}_3\}, 2}(\{\underline{x}_i, \underline{x}_j\})$ .

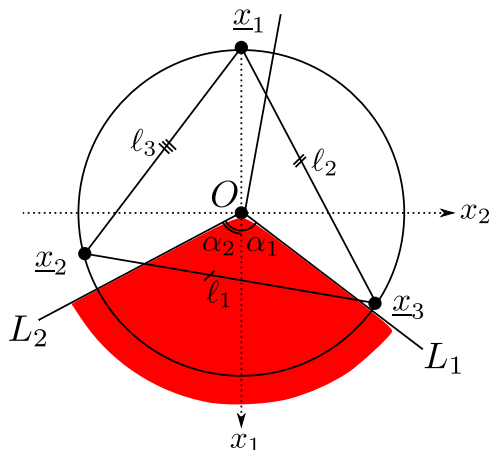

Fig. 6: Suppose that the largest angle of the triangle spanned by  $\underline{x}_1, \underline{x}_2, \underline{x}_3$  is acute or right. The origin  $O$  is set to be the center of the smallest ball containing  $\underline{x}_1, \underline{x}_2, \underline{x}_3$ . The  $x_1$  axis is set to be the ray going from  $\underline{x}_1$  to  $O$  and the  $x_2$  axis is the ray perpendicular to the  $x_1$  axis. The circumradius coincides with the Chebyshev radius which equals  $r = \sqrt{\text{rad}(\underline{x}_1, \underline{x}_2, \underline{x}_3)} = \|\underline{x}_1\|_2 = \|\underline{x}_2\|_2 = \|\underline{x}_3\|_2$ . The (second order) Voronoi region  $\mathcal{V}(\underline{x}_2, \underline{x}_3)$  has two boundaries, denoted by the rays  $L_1$  and  $L_2$ . The angle between the  $x_1$  axis and the rays  $L_1, L_2$  are denoted by  $\alpha_1, \alpha_2$ , respectively. The pairwise distances of  $\underline{x}_1, \underline{x}_2, \underline{x}_3$  are denoted by  $\ell_1, \ell_2, \ell_3$ .

$-a_2 x_1$  for some constants<sup>5</sup>  $a_1 > 0, a_2 > 0$  respectively. Let  $\mathcal{V} := \{[x_1, x_2] \in \mathbb{R}^2 : x_1 \geq 0, -a_2 x_1 \leq x_2 \leq a_1 x_1\}$ ,  $r := \sqrt{\text{rad}(\underline{x}_1, \underline{x}_2, \underline{x}_3)}$  and  $a := \max\{a_1, a_2\} > 0$ . We are now ready to estimate  $P_{e,2}^{\text{ML}}(\underline{x}_1, \{\underline{x}_1, \underline{x}_2, \underline{x}_3\})$ .

$$\begin{aligned}
P_{e,2}^{\text{ML}}(\underline{x}_1, \{\underline{x}_1, \underline{x}_2, \underline{x}_3\}) &= \Pr[\underline{x}_1 + \mathbf{g} \in \mathcal{V}(\underline{x}_2, \underline{x}_3)] \\
&= \Pr[[-r, 0] + [\mathbf{g}(1), \mathbf{g}(2)] \in \mathcal{V}] \\
&= \Pr[[\mathbf{g}_1, \mathbf{g}_2] \in [r, 0] + \mathcal{V}] \\
&= \Pr[\mathbf{g}_1 \geq r, -a_2(\mathbf{g}_1 - r) \leq \mathbf{g}_2 \leq a_1(\mathbf{g}_1 - r)]
\end{aligned} \tag{96}$$

<sup>5</sup>We explain below why the slopes  $a_1 > 0, a_2 > 0$  must be lower bounded by some constant independent of  $n$ . Let  $\ell_1 := \|\underline{x}_2 - \underline{x}_3\|_2, \ell_2 := \|\underline{x}_1 - \underline{x}_3\|_2, \ell_3 := \|\underline{x}_1 - \underline{x}_2\|_2$ . Under the assumptions in [Theorem 42](#), it is guaranteed that  $\ell_1, \ell_2, \ell_3 = \Theta(\sqrt{n})$ . It is a well-known fact that the circumradius of a triangle with side lengths  $\ell_1, \ell_2, \ell_3$  is equal to  $r = \frac{\ell_1 \ell_2 \ell_3}{4\sqrt{s(s-\ell_1)(s-\ell_2)(s-\ell_3)}}$  where  $s = \frac{\ell_1 + \ell_2 + \ell_3}{2}$ . Under the assumptions in [Theorem 42](#),  $r = \Theta(\sqrt{n})$ . Let  $\alpha_1, \alpha_2$  denote the angles between the  $x_1$  axis and the rays  $L_1, L_2$ , respectively. Then  $\sin \alpha_i = \frac{a_i}{\sqrt{1+a_i^2}}$  for  $i = 1, 2$ . On the other hand,  $\sin \alpha_1 = \frac{\ell_3/2}{r}, \sin \alpha_2 = \frac{\ell_2/2}{r}$ . We therefore get the relations  $\frac{a_1}{\sqrt{1+a_1^2}} = \frac{\ell_3/2}{r}, \frac{a_2}{\sqrt{1+a_2^2}} = \frac{\ell_2/2}{r}$ , the RHSs of which are on the order of  $\Theta(1)$ . Hence  $a_1 = \frac{\ell_3}{\sqrt{4r^2 - \ell_3^2}} = \Theta(1), a_2 = \frac{\ell_2}{\sqrt{4r^2 - \ell_2^2}} = \Theta(1)$ .



$$\begin{aligned}
&= \int_r^\infty \int_{-a_2(x_1-r)}^{a_1(x_1-r)} \frac{1}{2\pi\sigma^2} \exp\left(-\frac{x_1^2 + x_2^2}{2\sigma^2}\right) dx_2 dx_1 \\
&\geq \int_r^\infty \int_0^{a(x_1-r)} \frac{1}{2\pi\sigma^2} \exp\left(-\frac{x_1^2 + x_2^2}{2\sigma^2}\right) dx_2 dx_1 \\
&= \int_r^\infty \frac{1}{\sqrt{2\pi\sigma^2}} \exp\left(-\frac{x_1^2}{2\sigma^2}\right) \int_0^{a(x_1-r)} \frac{1}{\sqrt{2\pi\sigma^2}} \exp\left(-\frac{x_2^2}{2\sigma^2}\right) dx_2 dx_1 \\
&= \int_r^\infty \frac{1}{\sqrt{2\pi\sigma^2}} \exp\left(-\frac{x_1^2}{2\sigma^2}\right) \left[ \frac{1}{2} - \int_{a(x_1-r)}^\infty \frac{1}{\sqrt{2\pi\sigma^2}} \exp\left(-\frac{x_2^2}{2\sigma^2}\right) dx_2 \right] dx_1 \\
&\approx \int_r^\infty \frac{1}{\sqrt{2\pi\sigma^2}} \exp\left(-\frac{x_1^2}{2\sigma^2}\right) \left[ \frac{1}{2} - \frac{1}{12} \exp\left(-\frac{a^2(x_1-r)^2}{2\sigma^2}\right) \right] dx_1 \tag{97} \\
&\approx \frac{1}{2} \cdot \frac{1}{12} \exp\left(-\frac{r^2}{2\sigma^2}\right) - \frac{1}{12} \int_r^\infty \frac{1}{\sqrt{2\pi\sigma^2}} \exp\left(-\frac{x_1^2 + a^2(x_1-r)^2}{2\sigma^2}\right) dx_1. \tag{98}
\end{aligned}$$

In Equation (96),  $\mathbf{g}_1$  and  $\mathbf{g}_2$  are two independent Gaussians with mean zero and variance  $\sigma^2$ . In Equations (97) and (98), we use twice the bound on the  $Q$ -function (Lemma 5).

We then proceed to estimate the integral in Equation (98).

$$\begin{aligned}
&\int_r^\infty \frac{1}{\sqrt{2\pi\sigma^2}} \exp\left(-\frac{x_1^2 + a^2(x_1-r)^2}{2\sigma^2}\right) dx_1 \\
&= \int_r^\infty \frac{1}{\sqrt{2\pi\sigma^2}} \exp\left(-\frac{1}{2\sigma^2}((1+a^2)x_1^2 - 2a^2rx_1 + a^2r^2)\right) dx_1 \\
&= \int_r^\infty \frac{1}{\sqrt{2\pi\sigma^2}} \exp\left(-\frac{1}{2\sigma^2} \left[ \left( \sqrt{1+a^2}x_1 - \frac{a^2r}{\sqrt{1+a^2}} \right)^2 + a^2r^2 - \frac{a^4r^2}{1+a^2} \right] \right) dx_1 \\
&= \exp\left(-\frac{1}{2\sigma^2} \left[ a^2r^2 - \frac{a^4r^2}{1+a^2} \right] \right) \int_{\sqrt{1+a^2}r - \frac{a^2r}{\sqrt{1+a^2}}}^\infty \frac{1}{\sqrt{2\pi\sigma^2}} \exp\left(-\frac{s^2}{2\sigma^2}\right) \frac{1}{\sqrt{1+a^2}} ds \\
&\approx \frac{1}{12\sqrt{1+a^2}} \exp\left(-\frac{1}{2\sigma^2} \left[ a^2r^2 - \frac{a^4r^2}{1+a^2} \right] \right) \exp\left(-\frac{1}{2\sigma^2} \left[ \sqrt{1+a^2}r - \frac{a^2r}{\sqrt{1+a^2}} \right]^2 \right) \tag{99} \\
&= \frac{1}{12\sqrt{1+a^2}} \exp\left(-\frac{r^2}{2\sigma^2}\right).
\end{aligned}$$

Equation (99) follows again from Lemma 5.

Continuing with Equation (98), we have

$$P_{e,2}^{\text{ML}}(\underline{x}_1, \{\underline{x}_1, \underline{x}_2, \underline{x}_3\}) \gtrsim \frac{1}{2} \cdot \frac{1}{12} \exp\left(-\frac{r^2}{2\sigma^2}\right) - \frac{1}{12} \cdot \frac{1}{12\sqrt{1+a^2}} \exp\left(-\frac{r^2}{2\sigma^2}\right) = \frac{1}{24} \left(1 - \frac{1}{6\sqrt{1+a^2}}\right) \exp\left(-\frac{r^2}{2\sigma^2}\right).$$

By the geometry of the second order Voronoi partition in Figure 5, the same bound also holds for  $P_{e,2}^{\text{ML}}(\underline{x}_2, \{\underline{x}_1, \underline{x}_2, \underline{x}_3\})$  and  $P_{e,2}^{\text{ML}}(\underline{x}_3, \{\underline{x}_1, \underline{x}_2, \underline{x}_3\})$ . Therefore Theorem 42 holds in this case.

3) *The largest angle of the triangle spanned by  $\underline{x}_1, \underline{x}_2, \underline{x}_3$  is obtuse or flat:* In this case, the largest angle of the triangle spanned by  $\underline{x}_1, \underline{x}_2, \underline{x}_3$  is obtuse or flat. One can similarly compute the (first order) Voronoi partition and the second order Voronoi partition induced by  $\underline{x}_1, \underline{x}_2, \underline{x}_3$ , as depicted in the first and second figures of Figure 7, respectively. Note that in this case the smallest ball containing all three points is *different* from the circumscribed ball. In fact, the former one only touches *two* points among three whereas the latter one by definition touches all three points and is larger than the former one. Note that the Chebyshev radius of the triangle is now equal to half of the length of the longest edge. In the example depicted in Figure 7,  $\text{rad}(\underline{x}_1, \underline{x}_2, \underline{x}_3) = \left(\frac{1}{2}\|\underline{x}_2 - \underline{x}_3\|_2\right)^2$ .

Following similar calculations as done in Section XIV-A2, we can estimate  $P_{e,2}^{\text{ML}}(\underline{x}_i, \{\underline{x}_1, \underline{x}_2, \underline{x}_3\})$  for each  $i = 1, 2, 3$ . Note that, as depicted in Figure 8, the distance from  $\underline{x}_2$  to  $\mathcal{V}(\underline{x}_1, \underline{x}_3)$  and the distance from  $\underline{x}_3$  to  $\mathcal{V}(\underline{x}_1, \underline{x}_2)$  are both equal to  $\sqrt{\text{rad}(\underline{x}_1, \underline{x}_2, \underline{x}_3)}$ , and both  $\mathcal{V}(\underline{x}_1, \underline{x}_3)$  and  $\mathcal{V}(\underline{x}_1, \underline{x}_2)$  contain a full quadrant. Therefore the same calculations as those in Section XIV-A2 yield

$$P_{e,2}^{\text{ML}}(\underline{x}_2, \{\underline{x}_1, \underline{x}_2, \underline{x}_3\}) = \exp\left(-\frac{r^2}{2\sigma^2} - o(n)\right), \quad P_{e,2}^{\text{ML}}(\underline{x}_3, \{\underline{x}_1, \underline{x}_2, \underline{x}_3\}) = \exp\left(-\frac{r^2}{2\sigma^2} - o(n)\right),$$

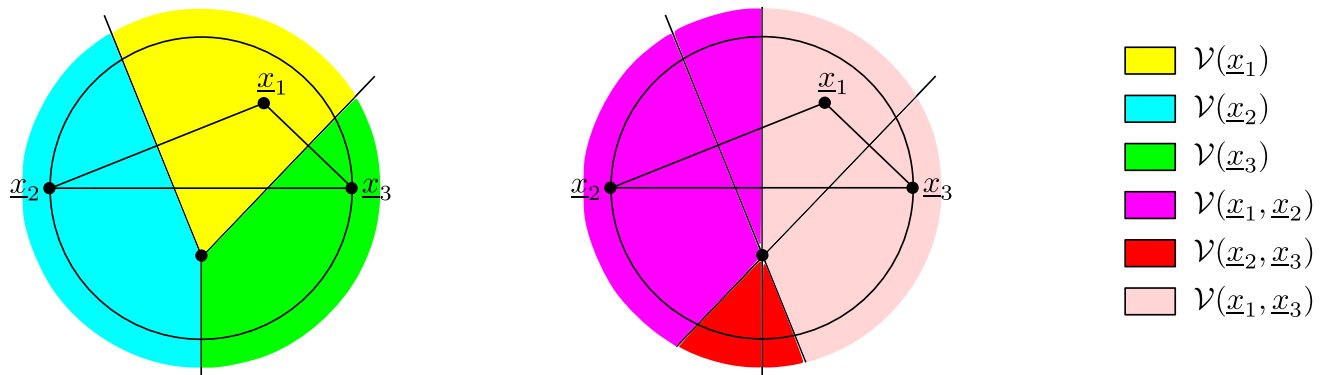

Fig. 7: The Voronoi partition (left) and the second order Voronoi partition (right) of  $\{\underline{x}_1, \underline{x}_2, \underline{x}_3\}$  when  $\underline{x}_1, \underline{x}_2, \underline{x}_3$  span an obtuse/flat triangle. Note that in this case, the smallest ball containing  $\underline{x}_1, \underline{x}_2, \underline{x}_3$  is strictly smaller than the circumscribed ball. In particular, the former ball only touches two points which are  $\underline{x}_2, \underline{x}_3$  in the first subfigure. We use the shorthand notation  $\mathcal{V}(\underline{x}_i) = \mathcal{V}_{\{\underline{x}_1, \underline{x}_2, \underline{x}_3\}}(\underline{x}_i)$  and  $\mathcal{V}(\underline{x}_i, \underline{x}_j) = \mathcal{V}_{\{\underline{x}_1, \underline{x}_2, \underline{x}_3\}, 2}(\{\underline{x}_i, \underline{x}_j\})$ .

where  $r = \sqrt{\text{rad}(\underline{x}_1, \underline{x}_2, \underline{x}_3)}$ . However, the distance from  $\underline{x}_1$  to  $\mathcal{V}(\underline{x}_2, \underline{x}_3)$  is strictly larger than  $r$ . To see this, we note that in the first subfigure of **Figure 8**, the distance equals  $\|\underline{x}_1\|_2$  and  $\|\underline{x}_1\|_2 = \|\underline{x}_2\|_2 = \|\underline{x}_3\|_2$ , the later two quantities of which are obviously larger than the radius of the ball. Hence

$$P_{e,2}^{\text{ML}}(\underline{x}_1, \{\underline{x}_1, \underline{x}_2, \underline{x}_3\}) = \exp\left(-\frac{d^2}{2\sigma^2} - o(n)\right) \ll \exp\left(-\frac{r^2}{2\sigma^2} - o(n)\right),$$

where  $d := d_{\ell_2}(\underline{x}_1, \mathcal{V}(\underline{x}_2, \underline{x}_3)) = \|\underline{x}_1\|_2 > \sqrt{\text{rad}(\underline{x}_1, \underline{x}_2, \underline{x}_3)}$ . Overall, **Theorem 42** still holds in this case.

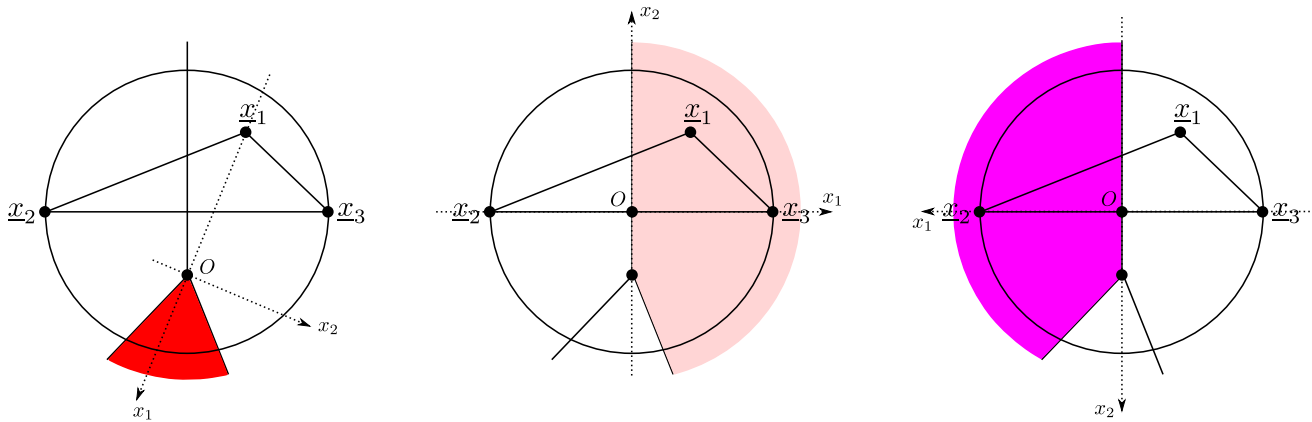

Fig. 8: Suppose that  $\underline{x}_1, \underline{x}_2, \underline{x}_3$  span an obtuse/flat triangle and the length of the longest edge is given by  $\|\underline{x}_2 - \underline{x}_3\|_2$ . The radius of the smallest ball containing  $\underline{x}_1, \underline{x}_2, \underline{x}_3$  is equal to  $r = \frac{1}{2}\|\underline{x}_2 - \underline{x}_3\|_2 = \sqrt{\text{rad}(\underline{x}_1, \underline{x}_2, \underline{x}_3)}$ . Then the distance from  $\underline{x}_2$  to  $\mathcal{V}(\underline{x}_1, \underline{x}_3)$  and the distance from  $\underline{x}_3$  to  $\mathcal{V}(\underline{x}_1, \underline{x}_2)$  are both equal to  $r$ . However, the distance  $d$  from  $\underline{x}_1$  to  $\mathcal{V}(\underline{x}_2, \underline{x}_3)$  is strictly larger than  $r$ .

### B. General case where $L - 1 \geq 2$

We now prove **Theorem 42** in the general case where  $L - 1 \geq 2$ . Let  $\mathcal{L} \subset \mathbb{R}^n$  be an arbitrary set of distinct  $L$  points in  $\mathbb{R}^n$ . We assume that  $\mathcal{L}$  satisfies (i) a mild minimum distance condition: there exists a constant  $c > 0$  such that  $\|\underline{x} - \underline{x}'\|_2 \geq \sqrt{nc}$  for every distinct pair  $\underline{x} \neq \underline{x}'$  in  $\mathcal{L}$ ; (ii) a mild maximum norm condition:  $\mathcal{L} \subset \mathcal{B}^n(\sqrt{nC})$  for some constant  $C > 0$ . Let  $\mathcal{B}_{\mathcal{L}}$  be the smallest ball containing  $\mathcal{L}$ . It is clear that there must be a point in  $\mathcal{L}$  that lies on the boundary of  $\mathcal{B}_{\mathcal{L}}$ , otherwise  $\mathcal{B}_{\mathcal{L}}$  can be shrunk yet still contains  $\mathcal{L}$ , which violates the minimality of  $\mathcal{B}_{\mathcal{L}}$ . Let  $\underline{x}_0$  denote a point on the boundary of  $\mathcal{B}_{\mathcal{L}}$ , as depicted in the first subfigure of **Figure 9**.

Since there are only  $L$  points in  $\mathcal{L}$ ,  $\dim(\text{aff}\{\mathcal{L}\}) \leq L - 1$ . By translating  $\mathcal{L}$  such that  $\text{aff}\{\mathcal{L}\}$  becomes a subspace, we can therefore parameterize  $\mathbb{R}^n$  using the orthonormal basis of  $\text{aff}\{\mathcal{L}\}$  (with its extension to  $\mathbb{R}^n$ ). Under this



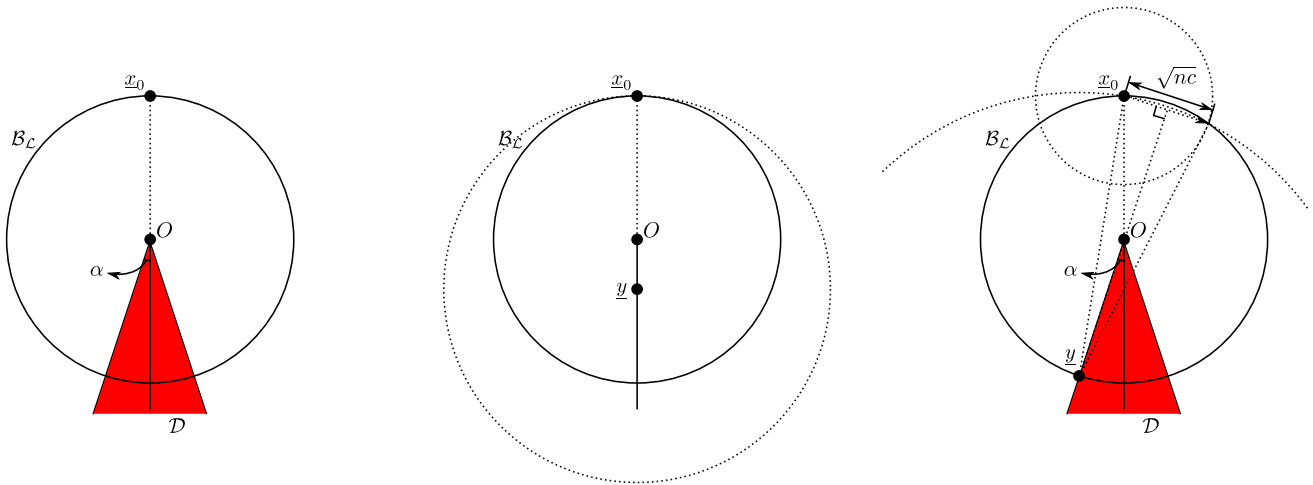

Fig. 9: Suppose  $\mathcal{L} \subset \mathbb{R}^n$  is a set of  $L$  points each of length  $O(\sqrt{n})$  and the minimum pairwise distance is on the order of  $\Theta(\sqrt{n})$ . Let  $\mathcal{B}_{\mathcal{L}}$  be the smallest ball containing  $\mathcal{L}$ . Then there must exist a point  $\underline{x}_0 \in \mathcal{L}$  on the boundary of  $\mathcal{B}_{\mathcal{L}}$ . We show that the  $(L-1)$ -list-decoding error of  $\underline{x}_0$  under ML list-decoder is large. We do so by lower bounding the Gaussian measure of the ML  $(L-1)$ -list-decoding error region of  $\underline{x}_0$  by that of a cone  $\mathcal{D}$  of angular radius  $\alpha$  for some constant  $\alpha > 0$ . Indeed, from the geometry of the second and third subfigures, we show in [Lemma 43](#) that any received vector  $\underline{y}$  in  $\mathcal{D}$  will result in a list-decoding error under ML  $(L-1)$ -list-decoder.

parameterization, for any  $\underline{x} \in \mathcal{L}$ , we have  $\underline{x}(i) = 0$  for all  $L \leq i \leq n$ . In the analysis we will only work with vectors in  $\mathbb{R}^{L-1}$  which are obtained by restricting vectors in  $\mathbb{R}^n$  to the first  $L-1$  coordinates and stick with the same notation.

As mentioned in [Equation \(95\)](#), for an  $L$ -list  $\mathcal{L}$ , the complement of the ML  $(L-1)$ -list-decoding region of  $\underline{x}_0$  is given by the order- $(L-1)$  Voronoi region  $\mathcal{V}_{\mathcal{L}, L-1}(\mathcal{L} \setminus \{\underline{x}_0\})$  of  $\mathcal{L} \setminus \{\underline{x}_0\}$ . For  $L-1 > 2$ , the shape of  $\mathcal{V}_{\mathcal{L}, L-1}(\mathcal{L} \setminus \{\underline{x}_0\})$  seems delicate. However, we manage to prove the following lemma ([Lemma 43](#)) which helps us estimate the probability that the a Gaussian noise brings  $\underline{x}_0$  to the ML  $(L-1)$ -list-decoding error region  $\mathcal{V}_{\mathcal{L}, L-1}(\mathcal{L} \setminus \{\underline{x}_0\})$ .

To state the lemma, we need the following set of definitions. Let  $\underline{x}_0$  be a point in  $\mathcal{L}$  that lies on the boundary of  $\mathcal{B}_{\mathcal{L}}$ . As argued above, such an  $\underline{x}_0$  must exist. Let  $O$  be the center of  $\mathcal{B}_{\mathcal{L}}$ . We also set  $O$  to be the origin of our coordinate system. Let  $\alpha$  be such that  $\sin \alpha = \frac{\sqrt{nc}/2}{\sqrt{\text{rad}(\mathcal{L})}}$  (see the third subfigure of [Figure 9](#)). Note that under the assumptions in [Theorem 42](#), it is guaranteed that  $\alpha$  is a constant (independent of  $n$ ).<sup>6</sup> Let  $\mathcal{D} \subset \mathbb{R}^{L-1}$  be the cone of angular radius  $\alpha$  with apex at  $O$  and axis along the direction of  $-\underline{x}_0$ . The cone  $\mathcal{D}$  is depicted in [Figure 9](#). With these parameters/objects at hands, we claim that  $\mathcal{D}$  is a subset of  $\mathcal{V}_{\mathcal{L}, L-1}(\mathcal{L} \setminus \{\underline{x}_0\})$  (the latter of which, by the notational convention of this section, is also a subset of  $\mathbb{R}^{L-1}$  obtained by projecting the original  $n$ -dimensional (order- $(L-1)$ ) Voronoi region to its first  $L-1$  coordinates).

**Lemma 43.** *Let  $C > c > 0$  be constants. Let  $\mathcal{L} \subset \mathcal{B}^n(\sqrt{nC})$  be a set of  $L$  points with minimum pairwise distance at least  $\sqrt{nc}$ . Let  $\mathcal{B}_{\mathcal{L}}$  be the smallest ball containing  $\mathcal{L}$ . Let  $\mathcal{D} \subset \mathbb{R}^{L-1}$  be the  $(L-1)$ -dimensional cone of angular radius  $\alpha = \sin^{-1} \frac{\sqrt{nc}/2}{\sqrt{\text{rad}(\mathcal{L})}}$  depicted in [Figure 9](#). Let  $\underline{x}_0 \in \mathcal{L}$  be on the boundary of  $\mathcal{B}_{\mathcal{L}}$ . Then  $\mathcal{D} \subset \mathcal{V}_{\mathcal{L}, L-1}(\mathcal{L} \setminus \{\underline{x}_0\})$ .*

*Proof.* We first note that all points on the ray shooting from  $O$  along the direction of  $-\underline{x}_0$  are in  $\mathcal{V}_{\mathcal{L}, L-1}(\mathcal{L} \setminus \{\underline{x}_0\})$ . To see this, take any point  $\underline{y}$  on that ray and draw a ball of radius  $\|\underline{x}_0 - \underline{y}\|_2$  around  $\underline{y}$  (see the second subfigure of [Figure 9](#)). Then  $\mathcal{B}^{L-1}(O, \sqrt{\text{rad}(\mathcal{L})}) \subset \mathcal{B}^{L-1}(\underline{y}, \|\underline{x}_0 - \underline{y}\|_2)$  and they are tangent at  $\underline{x}_0$ . Therefore  $\underline{x}_0$  is the unique furthest point to  $\underline{y}$  in  $\mathcal{B}_{\mathcal{L}}$ . That is, given  $\underline{y}$  on the ray, the ML  $(L-1)$ -list-decoder will *not* output  $\underline{x}_0$ .

The above argument for the ray can be extended to hold for the cone  $\mathcal{D}$  given the  $\sqrt{nc}$ -minimum distance guarantee. Clearly, to show that  $\mathcal{D}$  is a subset of  $\mathcal{V}_{\mathcal{L}, L-1}(\mathcal{L} \setminus \{\underline{x}_0\})$ , it suffices to consider points on the boundary of  $\mathcal{D}$ . Now take any point  $\underline{y} \neq O$  on the boundary of  $\mathcal{D}$ . (The case  $\underline{y} = O$  was already handled in the above

<sup>6</sup>To see this, it suffices to show  $\sqrt{\text{rad}(\mathcal{L})} = \Theta(\sqrt{n})$ . Apparently,  $\sqrt{\text{rad}(\mathcal{L})} \leq \sqrt{nC}$  since  $\mathcal{L} \subset \mathcal{B}^n(\sqrt{nC})$ . Also,  $\sqrt{\text{rad}(\mathcal{L})} \geq \frac{1}{2}\sqrt{nc}$  which is tight for  $L = 2$ . Therefore  $\sqrt{\text{rad}(\mathcal{L})} = \Theta(\sqrt{n})$  and  $\alpha = \sin^{-1} \frac{\sqrt{nc}/2}{\sqrt{\text{rad}(\mathcal{L})}} = \Theta(1)$ .

paragraph.) Again, draw the ball  $\mathcal{B}^{L-1}(y, \|\underline{x}_0 - y\|_2)$  (see the third subfigure of [Figure 9](#)). It is not hard to see that there is no point from  $\mathcal{L}$  other than  $\underline{x}_0$  that is in  $\mathcal{B}_{\mathcal{L}} \setminus \mathcal{B}^{L-1}(y, \|\underline{x}_0 - y\|_2)$ , since by the  $\sqrt{nc}$ -minimum distance guarantee,  $\mathcal{B}^{L-1}(\underline{x}_0, \sqrt{nc}) \cap \mathcal{L} = \{\underline{x}_0\}$ . Therefore,  $\underline{x}_0$  is the furthest point in  $\mathcal{L}$  from  $y$ , and given  $y$ , the ML  $(L-1)$ -list-decoder will not output  $\underline{x}_0$ . This finishes the proof of the lemma.  $\square$

Provided [Lemma 43](#), we are finally ready to estimate the probability of ML  $(L-1)$ -list-decoding error ([Equation \(95\)](#)). As before, let  $r := \sqrt{\text{rad}(\mathcal{L})}$ . We work with polar coordinates. Let the apex of the cone  $\mathcal{D}$  be the origin  $O$ . Parameterize  $\underline{x}_0$  as  $[-r, \underline{u}_0] \in \mathbb{R}^{L-1}$  for some  $\underline{u}_0 \in \mathcal{S}^{L-2}$ .

$$\begin{aligned} P_{e,L-1}^{\text{ML}}(\underline{x}_0, \mathcal{L}) &= \Pr[\underline{x}_0 + \underline{g} \in \mathcal{V}_{\mathcal{L},L-1}(\mathcal{L} \setminus \{\underline{x}_0\})] \\ &\geq \Pr[\underline{x}_0 + \underline{g} \in \mathcal{D}] \\ &= \int_{-\underline{x}_0 + \mathcal{D}} \frac{1}{(2\pi\sigma^2)^{(L-1)/2}} \exp\left(-\frac{\|\underline{g}\|_2^2}{2\sigma^2}\right) d\underline{g} \\ &= \int_{\mathcal{S}^{L-2}} \int_0^\infty \frac{1}{(2\pi\sigma^2)^{(L-1)/2}} \exp\left(-\frac{\|\rho\underline{u}\|_2^2}{2\sigma^2}\right) \rho^{L-2} \cdot |\mathcal{S}^{L-2}| \cdot \mathbf{1}_{-\underline{x}_0 + \mathcal{D}}(\rho\underline{u}) d\rho d\mu(\underline{u}) \end{aligned} \quad (100)$$

$$= \int_{\mathcal{S}^{L-2}} \int_r^\infty \frac{1}{(2\pi\sigma^2)^{(L-1)/2}} \exp\left(-\frac{\rho^2}{2\sigma^2}\right) \rho^{L-2} \cdot |\mathcal{S}^{L-2}| \cdot \mathbf{1}_{\rho^{-1}(-\underline{x}_0 + \mathcal{D})}(\underline{u}) d\rho d\mu(\underline{u}) \quad (101)$$

$$= \int_r^\infty \frac{1}{(2\pi\sigma^2)^{(L-1)/2}} \exp\left(-\frac{\rho^2}{2\sigma^2}\right) \rho^{L-2} \cdot |\mathcal{S}^{L-2}| \cdot \left( \int_{\mathcal{S}^{L-2}} \mathbf{1}_{\rho^{-1}(-\underline{x}_0 + \mathcal{D})}(\underline{u}) d\mu(\underline{u}) \right) d\rho \quad (102)$$

$$= \int_r^\infty \frac{1}{(2\pi\sigma^2)^{(L-1)/2}} \exp\left(-\frac{\rho^2}{2\sigma^2}\right) \rho^{L-2} \cdot |\mathcal{S}^{L-2}| \cdot \frac{|\mathcal{S}^{L-2} \cap \rho^{-1}(-\underline{x}_0 + \mathcal{D})|}{|\mathcal{S}^{L-2}|} d\rho \quad (103)$$

$$= \int_r^\infty \frac{1}{(2\pi\sigma^2)^{(L-1)/2}} \exp\left(-\frac{\rho^2}{2\sigma^2}\right) \cdot |\mathcal{S}^{L-2}(\rho) \cap (-\underline{x}_0 + \mathcal{D})| d\rho. \quad (104)$$

In [Equation \(100\)](#), we switch to polar coordinates using [Lemma 6](#) where  $\mu(\cdot)$  denotes the uniform probability measure on  $\mathcal{S}^{L-2}$ . [Equation \(101\)](#) follows since  $\|\underline{u}\|_2^2 = 1$  for  $\underline{u} \in \mathcal{S}^{L-2}$  and the inner integral vanishes for any  $\rho$  such that  $\rho = \|\rho\underline{u}\|_2 \leq \|\underline{x}_0\|_2 = r$ . In [Equation \(102\)](#), we interchange the inner and outer integrations. [Equation \(103\)](#) follows by noting that the inner integral is nothing but the normalized surface area of the cap obtained by taking the intersection of  $\mathcal{S}^{L-2}$  and the (shifted and rescaled) cone  $\rho^{-1}(-\underline{x}_0 + \mathcal{D})$ . [Equation \(104\)](#) follows from the fact that the  $(L-2)$ -dimensional volume scales like  $|\rho\mathcal{S}^{L-2}| = \rho^{L-2}|\mathcal{S}^{L-2}|$ .

To proceed, we bound the volume of the cap by first computing its radius  $s = s(\rho, \alpha, r)$  as a function of  $\rho$  (and  $\alpha, r$  as well). The geometry is depicted in [Figure 10](#).

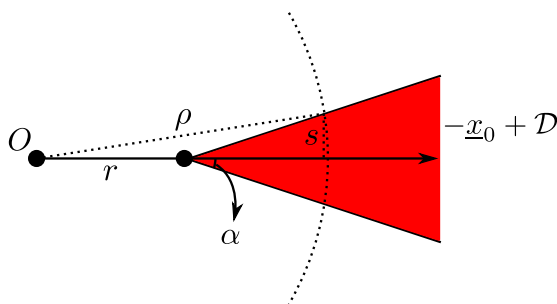

Fig. 10: In the above figure,  $-\underline{x}_0 + \mathcal{D}$  is a cone of angular radius  $\alpha$ , the apex of which is  $r$  away from the origin  $O$ . To integrate using polar coordinates, for each radius  $\rho \geq r$ , we need to compute the surface measure of the cap obtained by taking the intersection of  $\mathcal{S}^{L-2}(\rho)$  and  $-\underline{x}_0 + \mathcal{D}$ . It suffices to compute the radius  $s$  of the cap. This can be done by examining the elementary geometry depicted above.

By Pythagorean theorem, it is not hard to see that

$$\left(\frac{s}{\tan \alpha} + r\right)^2 + s^2 = \rho^2.$$

Solving  $s$ , we get

$$s = s(\rho, \alpha, r) = \frac{(\tan \alpha) \left( \sqrt{(1 + \tan^2 \alpha) \rho^2 - (\tan^2 \alpha) r^2} - r \right)}{\tan^2 \alpha + 1} = (\sin \alpha) \left( \sqrt{\rho^2 - r^2 \sin^2 \alpha} - r \cos \alpha \right) \quad (105)$$

Since the volume of an  $(L - 2)$ -dimensional cap is lower bounded by that of an  $(L - 2)$ -dimensional ball of the same radius, continuing with [Equation \(104\)](#), we have

$$\begin{aligned} P_{e, L-1}^{\text{ML}}(\underline{x}_0, \mathcal{L}) &\geq \int_r^\infty \frac{1}{(2\pi\sigma^2)^{(L-1)/2}} \exp\left(-\frac{\rho^2}{2\sigma^2}\right) \cdot |\mathcal{B}^{L-2}(s(\rho, \alpha, r))| d\rho \\ &= (2\pi\sigma^2)^{-(L-1)/2} V_{L-2}(\sin^{L-2} \alpha) \int_r^\infty \exp\left(-\frac{\rho^2}{2\sigma^2}\right) \left(\sqrt{\rho^2 - r^2 \sin^2 \alpha} - r \cos \alpha\right)^{L-2} d\rho \\ &= (2\pi\sigma^2)^{-(L-1)/2} V_{L-2}(\sin^{L-2} \alpha) \int_1^\infty \exp\left(-\frac{r^2 t^2}{2\sigma^2}\right) \left(\sqrt{r^2 t^2 - r^2 \sin^2 \alpha} - r \cos \alpha\right)^{L-2} r dt \\ &= (2\pi\sigma^2)^{-(L-1)/2} V_{L-2}(\sin^{L-2} \alpha) r^{L-1} \int_1^\infty \exp\left(-\frac{r^2 t^2}{2\sigma^2}\right) \left(\sqrt{t^2 - \sin^2 \alpha} - \cos \alpha\right)^{L-2} dt. \end{aligned} \quad (106)$$

Define the following two functions

$$f(t) := \frac{t^2}{2\sigma^2}, \quad g(t) := \left(\sqrt{t^2 - \sin^2 \alpha} - \cos \alpha\right)^{L-2}.$$

We note that  $f'(t) = t/\sigma^2$  and in the domain  $[1, \infty)$ ,  $f(t)$  attains its unique minimum  $\frac{1}{2\sigma^2}$  at  $t^* = 1$ . Furthermore,  $g(t^*) = g^{(1)}(t^*) = g^{(2)}(t^*) = \dots = g^{(L-3)}(t^*) = 0$  where  $g^{(k)}(t)$  denotes the  $k$ -th derivative of  $g(t)$ . However, the  $(L - 2)$ -st derivative of  $g(t)$  does not vanish at  $t^*$  and in fact one can check that it equals

$$g^{(L-2)}(t^*) = \frac{(L-2)! t^{L-2}}{(t^2 - \sin^2 \alpha)^{(L-2)/2}} \Big|_{t=t^*} = \frac{(L-2)!}{\cos^{L-2} \alpha}.$$

Now, we apply Laplace's method ([Theorem 9](#)) to compute the integral above ([Equation \(106\)](#)). As  $n \rightarrow \infty$ , we have  $r = \Theta(\sqrt{n}) \rightarrow \infty$  and therefore

$$\begin{aligned} \int_1^\infty \exp\left(-\frac{r^2 t^2}{2\sigma^2}\right) \left(\sqrt{t^2 - \sin^2 \alpha} - \cos \alpha\right)^{L-2} dt &= \int_1^\infty \exp(-r^2 f(t)) g(t) dt \\ &\xrightarrow{n \rightarrow \infty} \exp(-r^2 f(t^*)) \cdot \frac{g^{(L-2)}(t^*)}{(r^2 f^{(1)}(t^*))^{L-1}} \\ &= \frac{\sigma^{2(L-1)} (L-2)!}{(\cos^{L-2} \alpha) r^{2(L-1)}} \exp\left(-\frac{r^2}{2\sigma^2}\right). \end{aligned}$$

Putting this back to [Equation \(106\)](#), we have, as  $n \rightarrow \infty$

$$P_{e, L-1}^{\text{ML}}(\underline{x}_0, \mathcal{L}) \gtrsim \left(\frac{\sigma^2}{2\pi}\right)^{(L-1)/2} V_{L-2}(\tan^{L-2} \alpha) \frac{(L-2)!}{r^{L-1}} \exp\left(-\frac{r^2}{2\sigma^2}\right).$$

Since  $\sigma, L, \alpha$  are all constants independent of  $n$ , we have shown

$$P_{e, \text{avg}, L-1}^{\text{ML}}(\mathcal{L}) \geq \frac{1}{L} P_{e, L-1}^{\text{ML}}(\underline{x}_0, \mathcal{L}) = \exp\left(-\frac{r^2}{2\sigma^2} - o(n)\right),$$

as desired.

### C. Putting things together

**Theorems 41** and **42** imply the following corollary which gives a lower bound on the error probability of a code  $\mathcal{C}$  in terms of the Chebyshev radius.

**Corollary 44.** *Let  $P, \sigma > 0$  and  $L \in \mathbb{Z}_{\geq 2}$ . For any code  $\mathcal{C} \subset \mathcal{B}^n(\sqrt{nP})$  of size  $M$  and minimum pairwise distance at least  $\sqrt{nc}$  for some constant  $c > 0$ , there exists a subcode  $\mathcal{C}' \subset \mathcal{C}$  of size at least  $M' \geq M/2$  such that for all  $\mathcal{L} \in \binom{\mathcal{C}'}{L}$ ,*

$$P_{e,\text{avg},L-1}^{\text{ML}}(\mathcal{C}) \geq \exp\left(-\frac{\text{rad}(\mathcal{L})}{2\sigma^2} - o(n)\right).$$

On the other hand, one can construct codes whose error probability is small. By carefully analyzing a random code (with expurgation) in **Section XVII-F**, we have the following upper bound on the  $(L-1)$ -list-decoding error probability under ML list-decoder.

**Theorem 45.** *Let  $P, \sigma > 0$  and  $L \in \mathbb{Z}_{\geq 2}$ . There exist codes  $\mathcal{C} \subset \mathcal{S}^{n-1}(\sqrt{nP})$  of rate  $R$  such that when used over an AWGN channel with input constraint  $P$  and noise variance  $\sigma^2$ , it attains the following expurgated error exponent under ML  $(L-1)$ -list-decoding.*

$$P_{e,\text{avg},L-1}^{\text{ML}}(\mathcal{C}) \leq \exp(-nE_{\text{ex},L-1}(R) + o(n)),$$

where

$$E_{\text{ex},L-1}(R) := -\min_{s \geq 0, \rho \geq 1} R(L-1)\rho - \rho \left[ sLP + \frac{1}{2} \ln(1-2sP) + \frac{L-1}{2} \ln\left(1-2sP + \frac{P}{\sigma^2 L \rho}\right) \right]. \quad (107)$$

*Remark 16.* The above theorem follows from the intermediate result given by **Equation (175)** in **Section XVII-F**. We did not take the eventual explicit expression (without the minimization) in **Theorem 58** since for the purpose of this section, the minimization in **Equation (107)** can be solved in a simpler manner when combined with **Corollary 44**.

**Corollary 44** requires the minimum distance of the code to be at least  $\sqrt{nc}$  for an arbitrarily small constant  $c > 0$ . This turns out to be a mild condition and can be met without sacrificing the rate by taking a sufficiently small  $c > 0$ . Indeed, it was shown by Shannon [**Sha59**] (see also Eqn. (45) in [**SEW13**]) that even under unique-decoding, no rate loss is incurred if the code is expurgated so that the minimum distance is at least  $\sqrt{nc}$  for any  $0 \leq c \leq c(R)$  where  $c(R) := \sqrt{2 - 2\sqrt{1 - e^{-2R}}}$ . Therefore, **Theorem 45** continues to hold even under the  $\sqrt{nc}$ -minimum distance condition for any  $0 \leq c \leq c(R)$ .

Now, combining **Corollary 44** and **Theorem 45**, we get a code  $\mathcal{C} \subset \mathcal{S}^{n-1}(\sqrt{nP})$  of size  $M = e^{nR}$  which contains a subcode  $\mathcal{C}' \subset \mathcal{C}$  of size at least  $M/2$  satisfying: for every  $\mathcal{L} \in \binom{\mathcal{C}'}{L}$ ,

$$\exp\left(-\frac{\text{rad}(\mathcal{L})}{2\sigma^2} - o(n)\right) \leq P_{e,\text{avg},L-1}^{\text{ML}}(\mathcal{C}) \leq \exp(-nE_{\text{ex},L-1}(R) + o(n)). \quad (108)$$

For the subcode  $\mathcal{C}'$  to be  $(P, N, L-1)$ -list-decodable, we have  $\text{rad}_L(\mathcal{C}') = \min_{\mathcal{L} \in \binom{\mathcal{C}'}{L}} \text{rad}(\mathcal{L}) > nN$ . Therefore, by **Inequality (108)**,

$$\frac{N}{2\sigma^2} \geq E_{\text{ex},L-1}(R) - o(1). \quad (109)$$

We then ignore the  $o(1)$  factor and optimize out the ancillary parameters  $s$  and  $\rho$  to get an explicit bound on  $R$  in terms of  $P, N, L$ . To this end, let

$$F(s, \rho) := R(L-1)\rho - \rho \left[ sLP + \frac{1}{2} \ln(1-2sP) + \frac{L-1}{2} \ln\left(1-2sP + \frac{P}{\sigma^2 L \rho}\right) \right]. \quad (110)$$

The critical point  $s$  and  $\rho$  in the minimization of  $E_{\text{ex},L-1}(R)$  satisfies:

$$\frac{\partial}{\partial s} F(s, \rho) = -P\rho \left( L - \frac{1}{1-2Ps} - \frac{L-1}{1-2Ps + P/(\sigma^2 L \rho)} \right) = 0, \quad (111)$$

$$\frac{\partial}{\partial \rho} F(s, \rho) = R(L-1) - sLP - \frac{1}{2} \ln(1-2Ps) - \frac{L-1}{2} \ln\left(1-2Ps + \frac{P}{\sigma^2 L \rho}\right) - \frac{(L-1)P}{2(P + L(1-2Ps)\rho\sigma^2)} = 0. \quad (112)$$

From Equation (111), we have

$$\rho = \frac{(L-1) - 2LPs}{2L^2s(1-2Ps)\sigma^2}. \quad (113)$$

Substitute  $\rho$  into Equation (112), we have

$$-\ln(1-2Ps) + (L-1) \left[ 2R - \ln \frac{(L-1)(1-2Ps)}{L(1-2Ps)-1} \right] = 0. \quad (114)$$

Solving  $R$  from Equation (114), we get

$$R = \frac{1}{2} \left[ \ln \frac{(L-1)(1-2Ps)}{L(1-2Ps)-1} + \frac{1}{L-1} \ln(1-2Ps) \right]. \quad (115)$$

Note that for Equation (115) to be valid, we need one additional constraint on  $s$ , i.e.,  $s < \frac{1-1/L}{2P}$  which implies  $L(1-2Ps)-1 > 0$ . Now, putting the expressions of the critical  $\rho$  (Equation (113)) and the critical  $R$  (Equation (115)) into  $F(s, \rho)$  (Equation (110)), we have

$$F(s, \rho) = -\frac{P(L(1-2Ps)-1)}{2L\sigma^2(1-2Ps)}. \quad (116)$$

Substitute Equation (116) back to the relation between  $N$  and  $E_{\text{ex},L-1}(R)$  (Inequality (109)), we have

$$N \geq \frac{P(L(1-2Ps)-1)}{L(1-2Ps)}. \quad (117)$$

Note that there is no  $\sigma^2$  in the above relation as it is cancelled out. Since the RHS increases as  $s$  decreases, to maximize the list-decoding radius  $N$ , we need to take the minimum  $s$ . Therefore, we take  $s$  that saturates Inequality (117):

$$s = \frac{(L-1)P - LN}{2L(P-N)P}. \quad (118)$$

Finally, putting  $s$  (Equation (118)) to the expression of  $R$  (Equation (115)), we get the desired bound

$$R = \frac{1}{2} \left[ \ln \frac{(L-1)P}{LN} + \frac{1}{L-1} \ln \frac{P}{L(P-N)} \right]. \quad (119)$$

As a sanity check, the critical value  $s$  given by Equation (118) is indeed nonnegative since  $N$  is less than the Plotkin point  $\frac{L-1}{L}P$ . Also, it is not hard to check that  $s < \frac{1-1/L}{2P}$ . Putting the critical value of  $s$  (Equation (118)) into the expression of  $\rho$  (Equation (113)), we get

$$\rho = \frac{N(P-N)}{(L(P-N)-P)\sigma^2}.$$

We note that  $\rho$  is nonnegative for the same reason. Moreover, since  $\sigma^2$  does not show up in the final bound on  $R$ , one can take a sufficiently small  $\sigma^2$  to make  $\rho \geq 1$ . In particular, it suffices to take  $0 < \sigma \leq \sqrt{\frac{N(P-N)}{L(P-N)-P}}$ . Finally, to double check, we note that the expurgated exponent given by Equation (107) is achievable if  $R \leq R_{x,L-1}(\text{snr})$  where  $R_{x,L-1}(\text{snr})$  is defined by Equation (155). Since  $R_{x,L-1}(\text{snr})$  is increasing as  $\text{snr} = P/\sigma^2$  increases, that is, as  $\sigma^2$  decreases, the condition  $R_{x,L-1}(\text{snr}) \geq R$  can be satisfied if we take  $\sigma^2$  to be sufficiently small so that  $R_{x,L-1}(\text{snr})$  becomes larger than Equation (119). The exact threshold is given by

$$\text{snr} \geq \frac{P(L(P-N)-P)}{N(P-N)},$$

or

$$\sigma \leq \sqrt{\frac{N(P-N)}{L(P-N)-P}}, \quad (120)$$

which is the same as what we obtained before.

#### D. Mistakes in [Bli99]

The paper [Bli99] also tried to build the connection between list-decoding radius and error exponent (Equation (93)) and used it to obtain the same bound (Equation (92)) as ours. However, we have found some flaws in the proof as outlined below.

The main idea in [Bli99] is to lower bound a higher-order Voronoi region (which arises as the list-decoding error region) by a (first order) Voronoi region whose Gaussian measure is then estimated.

First, [Bli99] gave an incorrect description of the higher-order Voronoi partition which does not obey the true geometry. In particular, [Bli99] took a different perspective on a higher-order Voronoi region. Let  $\mathcal{C} \subset \mathbb{R}^n$  and  $\mathcal{L} \in \binom{\mathcal{C}}{L-1}$ . In [Bli99], it was claimed that the order- $(L-1)$  Voronoi region  $\mathcal{V}_{\mathcal{C},L-1}(\mathcal{L})$  associated with  $\mathcal{L}$  can be written as  $\mathcal{V}_{\mathcal{C},L-1}(\mathcal{L}) = \bigcap_{\underline{x} \in \mathcal{L}} \mathcal{U}(\underline{x})$  for a collection of  $\mathcal{U}(\underline{x})$  each associated with a point  $\underline{x}$ . It was then claimed that  $\mathcal{U}(\underline{x}) = \mathcal{V}_{\mathcal{C}}(\underline{x})$ , the RHS of which is the (first order) Voronoi region associated with  $\underline{x}$ . This cannot be true since different  $\mathcal{V}_{\mathcal{C}}(\underline{x})$ 's are disjoint and their intersection is always empty. However,  $\mathcal{V}_{\mathcal{C},L-1}(\mathcal{L})$  is never empty. In fact,  $\mathcal{U}(\underline{x})$  also depends on  $\mathcal{L}$  and had better be denoted by  $\mathcal{U}_{\mathcal{L}}(\underline{x})$ . To see this, note that the original definition of  $\mathcal{V}_{\mathcal{C},L-1}(\mathcal{L})$  (Equation (94)) can be rewritten as

$$\begin{aligned} \mathcal{V}_{\mathcal{C},L-1}(\mathcal{L}) &= \left\{ \underline{y} \in \mathbb{R}^n : \forall \underline{x}' \in \mathcal{C} \setminus \mathcal{L}, \forall \underline{x} \in \mathcal{L}, \|\underline{y} - \underline{x}'\|_2 > \|\underline{y} - \underline{x}\|_2 \right\} \\ &= \bigcap_{\underline{x}' \in \mathcal{C} \setminus \mathcal{L}} \bigcap_{\underline{x} \in \mathcal{L}} \left\{ \underline{y} \in \mathbb{R}^n : \|\underline{y} - \underline{x}'\|_2 > \|\underline{y} - \underline{x}\|_2 \right\} \\ &= \bigcap_{\underline{x} \in \mathcal{L}} \bigcap_{\underline{x}' \in \mathcal{C} \setminus \mathcal{L}} \left\{ \underline{y} \in \mathbb{R}^n : \|\underline{y} - \underline{x}'\|_2 > \|\underline{y} - \underline{x}\|_2 \right\}. \end{aligned}$$

Therefore, one can take

$$\mathcal{U}_{\mathcal{L}}(\underline{x}) := \bigcap_{\underline{x}' \in \mathcal{C} \setminus \mathcal{L}} \left\{ \underline{y} \in \mathbb{R}^n : \|\underline{y} - \underline{x}'\|_2 > \|\underline{y} - \underline{x}\|_2 \right\},$$

and it holds that  $\mathcal{V}_{\mathcal{C},L-1}(\mathcal{L}) = \bigcap_{\underline{x} \in \mathcal{L}} \mathcal{U}_{\mathcal{L}}(\underline{x})$ .

Second, due to the incorrect description of the higher-order Voronoi region, it was also claimed that  $\mathcal{V}_{\mathcal{C},L-1}(\mathcal{L}) \subset \mathcal{V}_{\mathcal{C}}(\underline{x})$  for any  $\underline{x} \in \mathcal{L}$ . This is inconsistent with the geometry even in the case of  $L = 3$ . Indeed, in Figures 5 and 7, neither  $\mathcal{V}(\underline{x}_1, \underline{x}_2)$  nor  $\mathcal{V}(\underline{x}_1)$  is a subset of each other.

Third, it is then claimed (without proof) that

$$\Pr[\underline{x} + \underline{\mathbf{g}} \notin \mathcal{V}_{\mathcal{L} \cup \{\underline{x}\},L-1}(\underline{x})] \geq \Pr[\underline{x} + \underline{\mathbf{g}} \notin \mathcal{V}_{\mathcal{L} \cup \{\underline{x}\}}(\underline{x})] \doteq \exp\left(-\frac{\text{rad}(\mathcal{L})}{2\sigma^2}\right). \quad (121)$$

The last (dot) equality is also incorrect. To see why this is the case, consider the example in Figure 5. From the geometry therein, if we take  $\underline{x} = \underline{x}_1$  and  $\mathcal{L} = \{\underline{x}_2, \underline{x}_3\}$ , the second probability in Equation (121) should be larger than the RHS since the distance from  $\underline{x}_1$  to  $\mathbb{R}^n \setminus \mathcal{V}(\underline{x}_1)$  is strictly less than  $\sqrt{\text{rad}(\underline{x}_1, \underline{x}_2, \underline{x}_3)}$ . Moreover, the reason for [Bli99] to look at this probability is solely a result of the preceding mistakes. The right probability to look at should be Equation (95) in which the Voronoi region is genuinely of higher-order.

Finally, it was claimed in [Bli99] that for Equation (93) to hold, one has to take  $\sigma \rightarrow 0$ . Our results show that this constraint is unnecessary. The AWGN variance  $\sigma^2$  can be taken to be a positive constant, as long as it does not exceed the RHS of Equation (120).

We believe that the main source of error in [Bli99] is the (incorrect) assumption that the higher-order Voronoi region can be written as the intersection of several conventional Voronoi regions. To the best of our understanding, there is no simple relation (even inclusions) between the conventional Voronoi partition and the higher-order Voronoi partition.

#### E. Unbounded packings

The techniques above also work for *unbounded* packings. The two key ingredients are: (i) a lower bound on the list-decoding error probability in terms of the Chebyshev radius; (ii) an upper bound on the list-decoding error probability. For (i), Theorem 42 does not require the code to lie on a sphere and therefore continues to hold

for unbounded packings. For (ii), we have bounds in [Theorem 62](#) on the list-decoding error exponent of AWGN channels *without* input constraints.

Let  $\alpha \geq 1$  and  $R = \frac{1}{2} \ln \frac{1}{2\pi e \sigma^2 \alpha^2}$ . Or equivalently,  $\alpha = \sqrt{\frac{e^{-2R}}{2\pi e \sigma^2}}$ . Let  $\mathcal{C} \subset \mathbb{R}^n$  be an unbounded code of rate  $R$  attaining the error exponent  $E_{\text{ex},L-1}(\alpha)$  given by [Theorem 62](#) for the AWGN channel with noise variance  $\sigma^2$ . By [Theorem 42](#), if  $\mathcal{C}$  is  $(N, L-1)$ -list-decodable, then for every  $\mathcal{L} \in \binom{\mathcal{C}}{L}$ ,

$$\exp\left(-\frac{nN}{2\sigma^2}\right) \leq \exp\left(-\frac{\text{rad}(\mathcal{L})}{2\sigma^2} - o(n)\right) \leq \exp(-nE_{\text{ex},L-1}(\alpha) + o(n)).$$

Hence,

$$N \geq 2\sigma^2 E_{\text{ex},L-1}(\alpha) = 2\sigma^2 E_{\text{ex},L-1}\left(\sqrt{\frac{e^{-2R}}{2\pi e \sigma^2}}\right). \quad (122)$$

It can be verified that the RHS as a function of  $\sigma$  is maximized at

$$\sigma = \sqrt{\exp\left(-\frac{L}{L-1} \ln L - \ln(2\pi e) - 2R\right)}, \quad (123)$$

which corresponds to

$$\alpha = \sqrt{\frac{e^{-2R}}{2\pi e \sigma^2}} = \sqrt{L^{\frac{L}{L-1}}} \in [\sqrt{L}, \sqrt{2L}].$$

Substituting the critical  $\sigma$  ([Equation \(123\)](#)) into [Inequality \(122\)](#), we get the following inequality relating  $N$  to  $R$ :

$$\begin{aligned} N &\geq 2 \exp\left(-\frac{L}{L-1} \ln L - \ln(2\pi e) - 2R\right) \cdot E_{\text{ex},L-1}\left(\sqrt{L^{\frac{L}{L-1}}}\right) \\ &= 2 \exp\left(-\frac{L}{L-1} \ln L - \ln(2\pi e) - 2R\right) \cdot \frac{L-1}{2} \\ &= (L-1) \exp\left(-\left[\frac{\ln L}{L-1} + \ln(2\pi e L) + 2R\right]\right). \end{aligned}$$

Solving  $R$ , we get the following lower bound on the  $(N, L-1)$ -list-decoding capacity:

$$R = \frac{1}{2} \ln \frac{L-1}{2\pi e N L} - \frac{\ln L}{2(L-1)},$$

which coincides with the lower bound on the  $(N, L-1)$ -average-radius list-decoding capacity given by [Theorem 31](#). We summarize our finding in the following theorem.

**Theorem 46.** *Let  $N > 0$  and  $L \in \mathbb{Z}_{\geq 2}$ . The  $(N, L-1)$ -list-decoding capacity  $C_{L-1}(N)$  is at least*

$$C_{L-1}(N) \geq \frac{1}{2} \ln \frac{L-1}{2\pi e N L} - \frac{\ln L}{2(L-1)}.$$

*Remark 17.* To prove [Theorems 40](#) and [46](#) for the bounded and unbounded cases, respectively, we combine [Theorem 42](#) with bounds on error exponents. This combination then gives rise to an inequality relating  $N$  to  $R$ . See [Inequalities \(109\)](#) and [\(122\)](#) for the bounded and unbounded cases. In [Inequality \(109\)](#), the variance  $\sigma^2$  of the Gaussian noise happens to cancel on both sides. To maximize  $R$ , one then needs to take the largest possible error exponent which occurs in the expurgated regime  $R \leq R_{x,L-1}$  (the latter quantity is defined in [Equation \(155\)](#)). However, in [Inequality \(122\)](#), the Gaussian variance  $\sigma^2$  does not cancel and one should optimize it out. It turns out that the optimal  $\sigma^2$  does *not* lie in the expurgated regime. Instead, one should use the error exponent in the ‘‘straight line’’ regime  $\sqrt{L} < \alpha \leq \sqrt{2L}$  (under the parameterization of [Theorem 62](#)). We do not have intuition of this phenomenon.

## XV. UPPER BOUNDS

In this section, we prove an upper bound on the optimal density of multiple packings on the sphere. We first show that any  $(P, N, L-1)$ -multiple packing must have a constant (independent of  $n$ ) size if  $N > \frac{L-1}{L}P$ . We then combine this result with an Elias–Bassalygo-type ([Bas65](#)) reduction to obtain an upper bound on the optimal density.



### A. Plotkin bound

In this section, we prove a Plotkin-type bound. It says that any  $(P, N, L - 1)$ -list-decodable code living on a spherical cap of angular radius  $\alpha$  must have a constant size (in particular,  $R(\mathcal{C}) = 0$ ) if  $\frac{N}{P}$  is larger than the threshold  $\frac{L-1}{L}(\sin \alpha)^2$ . When  $\alpha = \pi$ , it says that the  $(P, N, L - 1)$ -list-decoding capacity is zero as long as  $N > \frac{L-1}{P}$ . Combined with lower bounds given by various constructions in the preceding sections, this gives us a sharp threshold of the largest amount of noise that a positive-rate list-decodable code can correct.

We need some tools from Ramsey theory for the proof of the above Plotkin-type bound.

**Definition 13** (Ramsey number). The  $N$ -colour Ramsey number  $\mathcal{R}_N(M)$  is defined as the smallest integer  $K$  such that any  $N$ -colouring of the edges of a size- $K$  complete graph must contain a monochromatic complete subgraph of size at least  $M$ .

It is well-known that  $\mathcal{R}_N(M)$  is finite. There are bounds on  $\mathcal{R}_N(M)$  in the literature. The following simple one suffices for the purposes of this section.

**Theorem 47** ([WBBJ19]). For any  $N, M \in \mathbb{Z}_{\geq 1}$ ,  $\mathcal{R}_N(M) \leq 2^{N \cdot M^{N-1}}$ .

We then present a subcode extraction lemma using the above Ramsey-theoretic tools.

**Lemma 48.** For any code  $\mathcal{C} \subset \mathcal{B}^n(\sqrt{nP})$ , there exist  $\varepsilon \xrightarrow{|\mathcal{C}| \rightarrow \infty} 0$ , an increasing function  $f(\cdot)$ , a constant  $0 < d < 4P$  and a subcode  $\mathcal{C}' \subset \mathcal{C}$  of size at least  $f(|\mathcal{C}|)$  such that  $\|\underline{x}_i - \underline{x}_j\|_2 \in [\sqrt{n(d - \varepsilon)}, \sqrt{n(d + \varepsilon)}]$  for all  $1 \leq i \neq j \leq |\mathcal{C}'|$ .

*Proof.* The argument is somewhat standard in coding theory and we only give a proof sketch here. See, e.g., [Bli86] or [Bli12, Lemma 4, Chapter 2] for more detail. Let us build a complete graph  $\mathcal{G}_{\mathcal{C}}$  on the code  $\mathcal{C}$ . The vertices of  $\mathcal{G}_{\mathcal{C}}$  are all codewords in  $\mathcal{C}$  and every pair of codewords are connected by an edge. Clearly, since  $\mathcal{C}$  is in  $\mathcal{B}^n(\sqrt{nP})$ , the distance between any pair of codewords in  $\mathcal{C}$  lies in the range  $[0, 2\sqrt{nP}]$ . Let us uniformly divide the above interval into subintervals each of length  $\sqrt{2n\varepsilon}$ . To this end, we need  $N := \frac{4P}{2\varepsilon} = \frac{2P}{\varepsilon}$  many subintervals.<sup>7</sup> Each subinterval is represented by its middle point  $\sqrt{nd}$  for some  $d \in \mathcal{S} := \{\varepsilon, 3\varepsilon, 5\varepsilon, \dots, 4P - \varepsilon\}$ . If we view each  $d \in \mathcal{S}$  as a colour, then  $\mathcal{S}$  induces an edge colouring of  $\mathcal{G}_{\mathcal{C}}$  in the following sense. If  $\|\underline{x}_i - \underline{x}_j\|_2 \in [\sqrt{n(d - \varepsilon)}, \sqrt{n(d + \varepsilon)}]$ , then we say that the edge  $(\underline{x}_i, \underline{x}_j)$  gets colour  $d$ . Given such an  $N$ -colouring of the edges of  $\mathcal{G}_{\mathcal{C}}$ , by Ramsey's theorem (Theorem 47), as long as the size of  $\mathcal{C}$  exceeds  $\mathcal{R}_N(|\mathcal{C}'|)$ , there must exist a monochromatic complete subgraph  $\mathcal{C}' \subset \mathcal{C}$ . In other words, any code  $\mathcal{C}$  contains a monochromatic subcode  $\mathcal{C}'$  of size at least  $\mathcal{R}_N^{-1}(|\mathcal{C}|)$ . We have therefore proved the lemma by noting that monochromatic just means that all pairwise distances are  $\varepsilon$ -close to  $\sqrt{nd}$  for some  $d \in \mathcal{S}$ .  $\square$

*Remark 18.* We discuss here the  $o(1)$  factor  $\varepsilon$  and the increasing function  $f(\cdot)$  that appear in Lemma 48. Let  $K := |\mathcal{C}|$ . Suppose  $K \geq 2^{N \cdot M^{N-1}}$ . This guarantees the existence of a size- $M$  subcode  $\mathcal{C}' \subset \mathcal{C}$  where

$$M = \left( \frac{\log K}{N} \right)^{\frac{1}{N-1}}.$$

If we take  $N = \log \log \log K$ , then we can take  $f(\cdot)$  such that

$$M = f(K) := \left( \frac{\log K}{\log \log \log K} \right)^{\frac{1}{\log \log \log K - 1}} \xrightarrow{K \rightarrow \infty} \infty. \quad (124)$$

Note that  $f(\cdot)$  is increasing very slowly. In particular, the rate of the subcode  $\mathcal{C}' \subset \mathcal{C}$  is vanishing even if  $\mathcal{C}$  has positive rate. However, fortunately, this is fine for the sake of the Plotkin-type bound that we are going to prove.

Recall that  $N = \frac{2P}{\varepsilon}$ . Therefore we can take

$$\varepsilon = \frac{2P}{\log \log \log K} \xrightarrow{K \rightarrow \infty} 0.$$

We are now ready to prove the threshold result.

<sup>7</sup>For simplicity, we neglect divisibility issues.



**Theorem 49.** Let  $0 < \alpha < \pi$  and  $L \in \mathbb{Z}_{\geq 2}$ . Let  $P, N > 0$  be such that  $\frac{N}{P} \geq \frac{L-1}{L}(\sin \alpha)^2(1 + \rho)$  for some  $\rho > 0$ . Then any list-decodable code  $\mathcal{C}$  on a spherical cap of angular radius  $\alpha$  on  $\mathcal{B}^n(\sqrt{nP})$  with list-decoding radius  $\sqrt{nN}$  and list-size at most  $L - 1$  has size at most  $|\mathcal{C}| \leq F(\rho^{-1} + 1)$  for some increasing function  $F(\cdot)$ .

*Remark 19.* One can take  $F(\cdot) = f^{-1}(\cdot)$  for the  $f(\cdot)$  given by Equation (124). Recall that  $f$  is increasing very slowly. Since the inverse of an increasing function is also increasing,  $F$  is increasing. Note that  $F$  is growing as rapidly as the the Ramsey number.

*Proof.* Let  $\mathcal{C}$  be an arbitrary multiple packing on a spherical cap on  $\mathcal{B}^n(\sqrt{nP})$  of angular radius  $\alpha$ , denoted by  $\mathcal{K}_\alpha$ , with list-decoding radius  $\sqrt{nN}$  and list-size at most  $L - 1$ . Since rotation does not affect list-decodability, we assume that the cap is defined as

$$\mathcal{K}_\alpha := \left\{ \underline{x} \in \mathcal{B}^n(\sqrt{nP}) : \underline{x}(1) \geq \sqrt{nP} \cos \alpha \right\}. \quad (125)$$

Since  $\mathcal{K}_\alpha \subset \mathcal{B}^n(\underline{v}, \sqrt{nP} \sin \alpha)$  for some  $\underline{v} \in \mathbb{R}^n$ , by Lemma 48, we can extract a subcode  $\mathcal{C}' \subseteq \mathcal{C}$  of size at least  $M := |\mathcal{C}'| \geq f(|\mathcal{C}|)$  (for some increasing function  $f(\cdot)$ ) such that for any  $\underline{x}_i \neq \underline{x}_j \in \mathcal{C}'$ ,  $\langle \underline{x}_i, \underline{x}_j \rangle$  almost does not depend on the choice of  $i$  and  $j$ . Specifically, there is  $\varepsilon \xrightarrow{|\mathcal{C}'| \rightarrow \infty} 0$  such that  $\|\underline{x}_i - \underline{x}_j\|_2 \in [\sqrt{n(d - \varepsilon)}, \sqrt{n(d + \varepsilon)}]$  for all  $i \neq j \in [M]$  where  $0 < d < 4P(\sin \alpha)^2$  is a constant. Since  $\varepsilon$  can be taken to be  $o(1)$ , in the proceeding calculations, we will not carry the  $o(1)$  factor for simplicity.

Recall that if  $\mathcal{C}'$  is on  $\mathcal{B}^n(\sqrt{nP})$ , then for any list  $\mathcal{L} \in \binom{[M]}{L}$ , we have the following representations of the average radius

$$\overline{\text{rad}}(\{\underline{x}_i\}_{i \in \mathcal{L}}) = \frac{L-1}{L}nP - \frac{1}{L^2} \sum_{i \neq j \in \mathcal{L}} \langle \underline{x}_i, \underline{x}_j \rangle \quad (126)$$

$$= \frac{1}{2L^2} \sum_{i \neq j \in \mathcal{L}} \|\underline{x}_i - \underline{x}_j\|_2^2, \quad (127)$$

where  $\underline{x}_\mathcal{L} := \frac{1}{L} \sum_{i \in \mathcal{L}} \underline{x}_i$ . The first one (Equation (126)) is copied from Equation (48) and the second one (Equation (127)) is copied from Equation (46).

Let  $\mathcal{L} \in \binom{[M]}{L}$ . Note that for any  $i \in \mathcal{L}$ ,

$$\begin{aligned} \|\underline{x}_i - \underline{x}_\mathcal{L}\|_2^2 &= \langle \underline{x}_i - \underline{x}_\mathcal{L}, \underline{x}_i - \underline{x}_\mathcal{L} \rangle \\ &= nP - 2\langle \underline{x}_i, \underline{x}_\mathcal{L} \rangle + \langle \underline{x}_\mathcal{L}, \underline{x}_\mathcal{L} \rangle \\ &= nP - \frac{2}{L} \sum_{j \in \mathcal{L}} \langle \underline{x}_i, \underline{x}_j \rangle + \langle \underline{x}_\mathcal{L}, \underline{x}_\mathcal{L} \rangle \\ &= nP - \frac{2}{L} \left( nP + \sum_{i \neq j \in \mathcal{L}} \langle \underline{x}_i, \underline{x}_j \rangle \right) + \langle \underline{x}_\mathcal{L}, \underline{x}_\mathcal{L} \rangle. \end{aligned}$$

By the polarization identity, for any  $i \neq j \in \mathcal{L}$ ,

$$\langle \underline{x}_i, \underline{x}_j \rangle = \frac{1}{2} \left( \|\underline{x}_i\|_2^2 + \|\underline{x}_j\|_2^2 - \|\underline{x}_i - \underline{x}_j\|_2^2 \right) \asymp \frac{1}{2} (2nP - nd).$$

Therefore,  $\|\underline{x}_i - \underline{x}_\mathcal{L}\|_2^2$  (almost) does not depend on  $i$ .

Recall the following relations shown in Section VIII-C:

$$\begin{array}{ccccc} \mathbb{E}_{\underline{i} \sim \mathcal{L}} \left[ \|\underline{x}_i - \underline{x}_\mathcal{L}\|_2^2 \right] & = & \min_{\underline{y} \in \mathbb{R}^n} \mathbb{E}_{\underline{i} \sim \mathcal{L}} \left[ \|\underline{x}_i - \underline{y}\|_2^2 \right] & \leq & \min_{\underline{y} \in \mathbb{R}^n} \max_{i \in \mathcal{L}} \|\underline{x}_i - \underline{y}\|_2^2 & \leq & \max_{i \in \mathcal{L}} \|\underline{x}_i - \underline{x}_\mathcal{L}\|_2^2 \\ \parallel & & \parallel & & \parallel & & \parallel \\ \overline{\text{rad}}(\{\underline{x}_i\}_{i \in \mathcal{L}}) & & \text{rad}(\{\underline{x}_i\}_{i \in \mathcal{L}}) & & \text{rad}_{\max}(\{\underline{x}_i\}_{i \in \mathcal{L}}) & & \end{array}$$

Since the value of  $\|\underline{x}_i - \underline{x}_\mathcal{L}\|_2$  is approximately the same for every  $i \in \mathcal{L}$ , we have  $\overline{\text{rad}}(\{\underline{x}_i\}_{i \in \mathcal{L}}) \asymp \text{rad}_{\max}(\{\underline{x}_i\}_{i \in \mathcal{L}})$ . Since  $\text{rad}(\{\underline{x}_i\}_{i \in \mathcal{L}})$  is sandwiched between the above two quantities, we further have, for every  $\mathcal{L} \in \binom{[M]}{L}$ ,

$$\overline{\text{rad}}(\{\underline{x}_i\}_{i \in \mathcal{L}}) \asymp \text{rad}(\{\underline{x}_i\}_{i \in \mathcal{L}}) \asymp \text{rad}_{\max}(\{\underline{x}_i\}_{i \in \mathcal{L}}). \quad (128)$$

Moreover, we claim that the value of the above three radii (almost) do not depend on the choice of  $\mathcal{L} \in \binom{[M]}{L}$ . By Equation (128), it suffices to prove this for one of the three radii. Indeed, for any  $\mathcal{L} \in \binom{[M]}{L}$ , consider the average radius:

$$\overline{\text{rad}}(\{\underline{x}_i\}_{i \in \mathcal{L}}) = \frac{1}{2L^2} \sum_{i \neq j \in \mathcal{L}} \|\underline{x}_i - \underline{x}_j\|_2^2 \asymp \frac{1}{2L^2} L(L-1)nd = \frac{L-1}{2L} nd, \quad (129)$$

independent of  $\mathcal{L}$ . The first inequality follows from the second representation of  $\overline{\text{rad}}(\cdot)$  (Equation (127)). By the definitions of  $\text{rad}_L(\cdot)$  (Equation (30)) and  $\overline{\text{rad}}_L(\cdot)$  (Equation (31)), we further have  $\overline{\text{rad}}(\mathcal{C}') \asymp \text{rad}(\mathcal{C}')$ .

To get an upper bound on  $M = |\mathcal{C}'|$ , it suffices to upper bound  $\text{rad}(\mathcal{C}')$ . To this end, we bound the following quantity

$$\mathbb{E}_{\mathcal{L} \sim \binom{[M]}{L}} [\overline{\text{rad}}(\{\underline{x}_i\}_{i \in \mathcal{L}})]. \quad (130)$$

By the first form of  $\overline{\text{rad}}(\cdot)$  (Equation (126)), Equation (130) equals

$$\begin{aligned} \text{Equation (130)} &= \mathbb{E}_{\mathcal{L} \sim \binom{[M]}{L}} \left[ \frac{L-1}{L} nP - \frac{1}{L^2} \sum_{i \neq j \in \mathcal{L}} \langle \underline{x}_i, \underline{x}_j \rangle \right] \\ &= \frac{L-1}{L} nP - \frac{1}{L^2} \frac{1}{\binom{M}{L}} \sum_{\mathcal{L} \in \binom{[M]}{L}} \sum_{i \neq j \in \mathcal{L}} \langle \underline{x}_i, \underline{x}_j \rangle \\ &= \frac{L-1}{L} nP - \frac{1}{L^2} \frac{1}{\binom{M}{L}} \sum_{i \neq j \in [M]} \sum_{\mathcal{L} \in \binom{[M]}{L}} \langle \underline{x}_i, \underline{x}_j \rangle \mathbf{1}\{\mathcal{L} \ni i, \mathcal{L} \ni j\} \\ &= \frac{L-1}{L} nP - \frac{1}{L^2} \frac{1}{\binom{M}{L}} \sum_{i \neq j \in [M]} \langle \underline{x}_i, \underline{x}_j \rangle \sum_{\mathcal{L} \in \binom{[M]}{L}} \mathbf{1}\{\mathcal{L} \ni i, \mathcal{L} \ni j\} \\ &= \frac{L-1}{L} nP - \frac{1}{L^2} \frac{1}{\binom{M}{L}} \sum_{i \neq j \in [M]} \langle \underline{x}_i, \underline{x}_j \rangle \binom{M-2}{L-2} \\ &= \frac{L-1}{L} nP - \frac{1}{L^2} \frac{1}{\binom{M}{L}} \left( \sum_{(i,j) \in [M]^2} \langle \underline{x}_i, \underline{x}_j \rangle - \sum_{i \in [M]} \|\underline{x}_i\|_2^2 \right) \binom{M-2}{L-2} \\ &= \frac{L-1}{L} nP - \frac{1}{L^2} \frac{1}{\binom{M}{L}} \left( M^2 \|\bar{\underline{x}}\|_2^2 - M \cdot nP \right) \binom{M-2}{L-2}. \end{aligned} \quad (131)$$

In Equation (131), we let  $\bar{\underline{x}} := \frac{1}{M} \sum_{i \in [M]} \underline{x}_i$ . Note that the norm of  $\bar{\underline{x}}$  can be lower bounded as follows.

$$\begin{aligned} \|\bar{\underline{x}}\|_2^2 &= \left\| \frac{1}{M} \sum_{i \in [M]} \underline{x}_i \right\|_2^2 \\ &= \sum_{j=1}^n \left( \frac{1}{M} \sum_{i \in [M]} \underline{x}_i(j) \right)^2 \\ &\geq \left( \frac{1}{M} \sum_{i \in [M]} \underline{x}_i(1) \right)^2 \\ &\geq \left( \frac{1}{M} \cdot M \cdot \sqrt{nP} \cos \alpha \right)^2 \end{aligned} \quad (132)$$

$$= nP \cdot (\cos \alpha)^2. \quad (133)$$

**Inequality (132)** is by the assumption  $\mathcal{C}' \subset \mathcal{C} \subset \mathcal{K}_\alpha$  where  $\mathcal{K}_\alpha$  is defined by **Equation (125)**. Putting **Equation (133)** back to **Equation (131)**, we have

$$\begin{aligned}
\text{Equation (130)} &\leq \frac{L-1}{L}nP - \frac{1}{L^2} \frac{1}{\binom{M}{L}} (M^2nP(\cos \alpha)^2 - M \cdot nP) \binom{M-2}{L-2} \\
&= \frac{L-1}{L}nP - \frac{L-1}{LM(M-1)} (M^2nP(\cos \alpha)^2 - MnP) \\
&= \frac{L-1}{L}nP - \frac{(L-1)M}{L(M-1)}nP(\cos \alpha)^2 + \frac{L-1}{L(M-1)}nP \\
&= \frac{L-1}{L}nP - \frac{L-1}{L}nP(\cos \alpha)^2 + \frac{L-1}{L(M-1)}nP - \frac{L-1}{L(M-1)}nP(\cos \alpha)^2 \\
&= \frac{L-1}{L}nP(\sin \alpha)^2 \left(1 + \frac{1}{M-1}\right). \tag{134}
\end{aligned}$$

Finally,

$$nN \leq \text{rad}(\mathcal{C}') = \min_{\mathcal{L} \in \binom{[M]}{L}} \text{rad}(\{\underline{x}_i\}_{i \in \mathcal{L}}) \asymp \mathbb{E}_{\mathcal{L} \sim \binom{[M]}{L}} [\text{rad}(\{\underline{x}_i\}_{i \in \mathcal{L}})] \leq \frac{L-1}{L}nP(\sin \alpha)^2 \left(1 + \frac{1}{M-1}\right). \tag{135}$$

The asymptotic equality follows from the following two points: (i) by **Equation (128)**, for any  $\mathcal{L} \in \binom{[M]}{L}$ ,  $\text{rad}(\{\underline{x}_i\}_{i \in \mathcal{L}}) \asymp \overline{\text{rad}}(\{\underline{x}_i\}_{i \in \mathcal{L}})$ ; (ii) by **Equation (129)**, the value of  $\text{rad}(\{\underline{x}_i\}_{i \in \mathcal{L}})$  is approximately the same for every  $\mathcal{L} \in \binom{[M]}{L}$ .

Assume  $\frac{N}{P} = \frac{L-1}{L}(\sin \alpha)^2(1 + \rho)$  for some constant  $\rho > 0$ . Rearranging terms on both sides of **Inequality (135)**, we get

$$1 + \rho \leq 1 + \frac{1}{M-1} \implies M \leq \frac{1}{\rho} + 1.$$

Therefore we have shown  $|\mathcal{C}'| \leq \rho^{-1} + 1$ . Since  $|\mathcal{C}'| \geq f(|\mathcal{C}|)$ , we finally get  $|\mathcal{C}| \leq f^{-1}(|\mathcal{C}'|) \leq f^{-1}(\rho^{-1} + 1) = F(\rho^{-1} + 1)$ , as claimed in the theorem.  $\square$

## B. Elias–Bassalygo bound

In this section, we combine the following covering lemma with **Theorem 49** to get an upper bound on the size of an arbitrary  $(P, N, L-1)$ -list-decodable code.

**Lemma 50** (Folklore). *Let  $0 < \alpha < \pi$ . There exists a collection of  $e^{n(\ln \frac{1}{\sin \alpha} + o(1))}$  spherical caps of angular radius  $\alpha$  such that they cover the whole sphere.*

*Remark 20.* A random covering enjoys the property in **Lemma 50** with probability doubly exponentially close to one. This lemma is well-known and we omit the proof. In fact, the converse of **Lemma 50** is also true. That is, any covering of the sphere by spherical caps of angular radius  $\alpha$  must have size at least  $e^{n(\ln \frac{1}{\sin \alpha} - o(1))}$ . We will not use the converse.

We combine **Theorem 49** and **Lemma 50** to prove the following upper bound on the  $(P, N, L-1)$ -list-decoding capacity.

**Theorem 51.** *Let  $L \in \mathbb{Z}_{\geq 2}$  and  $N, P > 0$  such that  $\frac{N}{P} \leq \frac{L-1}{L}$ . The  $(P, N, L-1)$ -list-decoding capacity  $C_{L-1}(P, N)$  is at most  $\frac{1}{2} \ln \frac{(L-1)P}{LN}$ .*

*Remark 21.* The above bound approaches  $\frac{1}{2} \ln \frac{P}{N}$  as  $L \rightarrow \infty$ . The latter quantity is known to be the list-decoding capacity in the large  $L$  limit (see **Section XVI**). For  $L = 2$ , the above bound becomes  $\frac{1}{2} \ln \frac{P}{2N}$  which is worse than the linear programming-type bound by Kabatiansky and Levenshtein [KL78]. The above bound is tight (specifically, equals  $\infty$  and 0, respectively) at  $N/P = 0$  and  $N/P = \frac{L-1}{L}$ .

*Proof.* Let  $\mathcal{C} \subset \mathcal{B}^n(\sqrt{nP})$  be an arbitrary  $(P, N, L-1)$ -list-decodable code. Let  $0 < \alpha < \pi$  be such that  $\frac{N}{P} = \frac{L-1}{L}(\sin \alpha)^2(1 + \rho)$  for some small constant  $\rho > 0$ . We cover  $\mathcal{B}^n(\sqrt{nP})$  using spherical caps of angular radius

$\alpha$ . By [Theorem 49](#), on each spherical cap, the number of codewords is at most a constant  $C_\rho = F(\rho^{-1} + 1)$ , independent of  $n$ . By [Lemma 50](#), the number of spherical caps is  $e^{n(\ln \frac{1}{\sin \alpha} + o(1))}$ . Therefore, the total number of codewords in  $\mathcal{C}$  is at most  $C_\rho \cdot e^{n(\ln \frac{1}{\sin \alpha} + o(1))}$ , meaning that the rate of  $\mathcal{C}$  is at most

$$\ln \frac{1}{\sin \alpha} = \frac{1}{2} \ln \frac{1}{(\sin \alpha)^2} = \frac{1}{2} \ln \frac{(L-1)P(1+\rho)}{LN}.$$

The theorem is proved once  $\rho$  is sent to zero.  $\square$

*Remark 22.* Technically, [Theorem 51](#) is proved only for spherical codes. However, by [Theorem 21](#), this is without loss of generality since any capacity-achieving code can be turned into a spherical code.

The idea in [Theorem 49](#) can be adapted to the unbounded setting. Let  $\mathcal{C} \subset \mathbb{R}^n$  be an arbitrary  $(N, L-1)$ -multiple packing of rate  $R(\mathcal{C})$ . The trick is to restrict  $\mathcal{C}$  to a large ball. Specifically, let  $\mathcal{C}_P := \mathcal{C} \cap \mathcal{B}^n(\sqrt{nP})$  for a sufficiently large  $P$  such that

$$R(\mathcal{C}_P) \geq R(\mathcal{C}) - \frac{1}{2} \ln(2\pi eP) - \delta, \quad (136)$$

for a small  $\delta > 0$ . We divide  $\mathcal{B}^n(\sqrt{nP})$  into a sequence of shells such that the norm of vectors in each shell is in the range  $[\sqrt{n(P' - \varepsilon)}, \sqrt{n(P' + \varepsilon)}]$  for some  $0 \leq P' \leq P$  and some small  $\varepsilon > 0$ . By Markov's inequality, there must exist some  $P' \in [0, P]$  such that the number of codewords in the shell of radius  $\sqrt{nP'}$  is at least  $\frac{|\mathcal{C}_P|}{P/(2\varepsilon)}$  codewords. Let  $\mathcal{C}_{P'} \subset \mathcal{C}_P$  denote the subcode in this shell. The rate of  $\mathcal{C}_{P'}$  is asymptotically the same as that of  $\mathcal{C}_P$ . If  $\varepsilon$  is sufficiently small, it becomes negligible in the proof of [Theorem 49](#). Therefore, [Theorems 49](#) and [51](#) continue to hold for  $\mathcal{C}_{P'}$  and we have  $R(\mathcal{C}_{P'}) \leq \frac{1}{2} \ln \frac{LN}{(L-1)P'}$ . We do not have control on  $P'$  and should take the extremal value  $P' = P$ . By [Inequality \(136\)](#), we conclude

$$R(\mathcal{C}) \leq R(\mathcal{C}_P) + \frac{1}{2} \ln(2\pi eP) + \delta = R(\mathcal{C}_{P'}) + \frac{1}{2} \ln(2\pi eP) + \delta \leq \frac{1}{2} \ln \frac{(L-1)P}{LN} - \frac{1}{2} \ln(2\pi eP) + \delta = \frac{1}{2} \ln \frac{L-1}{L \cdot 2\pi eN} + \delta,$$

provided that  $P$  is sufficiently large and consequently  $\delta$  is sufficiently small.

We summarize our finding in the following theorem.

**Theorem 52.** *Let  $N > 0$  and  $L \in \mathbb{Z}_{\geq 2}$ . The  $(N, L-1)$ -list-decoding capacity  $C_{L-1}(N)$  is at most  $\frac{1}{2} \ln \frac{L-1}{L \cdot 2\pi eN}$ .*

*Remark 23.* The above bound approaches  $\frac{1}{2} \ln \frac{1}{2\pi eN}$  as  $L \rightarrow \infty$ . The latter quantity is known to be the list-decoding capacity in the large  $L$  limit (see [Section XVI](#)).

## XVI. LIST-DECODING CAPACITY FOR LARGE $L$

Characterizing  $C_{L-1}(P, N)$ ,  $\overline{C}_{L-1}(P, N)$ ,  $C_{L-1}(N)$  or  $\overline{C}_{L-1}(N)$  is a difficult task that is out of reach given the current techniques. However, if the list-size  $L$  is allowed to grow, we can actually characterize

$$C_{\text{LD}} := \lim_{L \rightarrow \infty} C_{L-1}(P, N), \quad C_{\text{LD}}(N) := \lim_{L \rightarrow \infty} C_{L-1}(N), \quad \overline{C}_{\text{LD}}(N) := \lim_{L \rightarrow \infty} \overline{C}_{L-1}(N),$$

where the subscript LD denotes List-Decoding. However, we are not able to characterize

$$\overline{C}_{\text{LD}}(P, N) := \lim_{L \rightarrow \infty} \overline{C}_{L-1}(P, N).$$

We leave this as an intriguing open question (see [Section XIX](#)).

It is well-known that  $C_{\text{LD}}(P, N) = \frac{1}{2} \ln \frac{P}{N}$ . Specifically, the following theorem appears to be a folklore in the literature and a complete proof can be found in [\[ZVJS18\]](#).

**Theorem 53** (Folklore, [\[ZVJS18\]](#)). *Let  $0 < N \leq P$ . Then for any  $\varepsilon > 0$ ,*

- 1) *There exist  $(P, N, L-1)$ -multiple packings of rate  $\frac{1}{2} \ln \frac{P}{N} - \varepsilon$  for some  $L = \mathcal{O}(\frac{1}{\varepsilon} \ln \frac{1}{\varepsilon})$ ;*
- 2) *Any  $(P, N, L-1)$ -multiple packing of rate  $\frac{1}{2} \ln \frac{P}{N} + \varepsilon$  must satisfy  $L = e^{\Omega(n\varepsilon)}$ .*

*Therefore,  $C_{\text{LD}}(P, N) = \frac{1}{2} \ln \frac{P}{N}$ .*

The unbounded version  $C_{\text{LD}}(N)$  is characterized in [\[ZV19\]](#) which equals  $\frac{1}{2} \ln \frac{1}{2\pi eN}$ .

**Theorem 54** ([\[ZV19\]](#)). *Let  $N > 0$ . Then for any  $\varepsilon > 0$ ,*

- 1) There exist  $(N, L - 1)$ -multiple packings of rate  $\frac{1}{2} \ln \frac{1}{2\pi e N} - \varepsilon$  for some  $L = \mathcal{O}(\frac{1}{\varepsilon} \ln \frac{1}{\varepsilon})$ ;
- 2) Any  $(N, L - 1)$ -multiple packing of rate  $\frac{1}{2} \ln \frac{1}{2\pi e N} + \varepsilon$  must satisfy  $L = e^{\Omega(n\varepsilon)}$ .

Therefore,  $C_{\text{LD}}(N) = \frac{1}{2} \ln \frac{1}{2\pi e N}$ .

Finally, we claim  $\overline{C}_{\text{LD}}(N) = \frac{1}{2} \ln \frac{1}{2\pi e N}$ . For an upper bound, recall that average-radius list-decodability implies (regular) list-decodability. Therefore, any upper bound on  $C_{L-1}(N)$  is also an upper bound on  $\overline{C}_{L-1}(N)$ . We already saw an upper bound on  $C_{L-1}(N)$  in [Theorem 52](#) that approaches  $\frac{1}{2} \ln \frac{1}{2\pi e N}$  as  $L \rightarrow \infty$ . On the other hand, we have seen constructions of  $(N, L - 1)$ -average-radius list-decodable codes in that attains rate approaching  $\frac{1}{2} \ln \frac{1}{2\pi e N}$  as  $L \rightarrow \infty$ . Indeed, according to [Theorem 31](#), for sufficiently large  $L$ , a PPP achieves  $\frac{1}{2} \ln \frac{1}{2\pi e N}$  with high probability.

**Theorem 55.** For any  $N > 0$ ,  $\overline{C}_{\text{LD}}(N) = \frac{1}{2} \ln \frac{1}{2\pi e N}$ .

## XVII. LIST-DECODING ERROR EXPONENTS

Consider a *discrete memoryless channel (DMC)*  $W_{\mathbf{y}|\mathbf{x}} \in \Delta(\mathcal{Y}|\mathcal{X})$  with discrete input alphabet  $\mathcal{X}$  and discrete output alphabet  $\mathcal{Y}$ . It is nothing but a conditional distribution that takes as input a sequence  $\underline{x} \in \mathcal{X}^n$  and generates as output a sequence  $\underline{y} \in \mathcal{Y}^n$  by acting on each component of  $\underline{x}$  independently, that is, for any  $\underline{y} \in \mathcal{Y}^n$

$$\Pr[\underline{y} = \underline{y} | \underline{x} = \underline{x}] = \prod_{i=1}^n W_{\mathbf{y}|\mathbf{x}}(\underline{y}(i) | \underline{x}(i)),$$

for any  $\underline{y} \in \mathcal{Y}^n$ . We also associate a set  $\mathcal{P} \subset \Delta(\mathcal{X})$  of input constraints to the channel  $W_{\mathbf{y}|\mathbf{x}}$ . The constraints require that the empirical distribution of any input sequence  $\underline{x} \in \mathcal{X}^n$  is in  $\mathcal{P}$ . Specifically, for  $\underline{x} \in \mathcal{X}^n$ , let  $\tau_{\underline{x}} \in \Delta(\mathcal{X})$  denote its *empirical distribution* (a.k.a. *histogram* or *type*) defined as

$$\tau_{\underline{x}}(x) := \frac{1}{n} \sum_{i=1}^n \mathbb{1}\{\underline{x}(i) = x\},$$

for any  $x \in \mathcal{X}$ . Clearly,  $\tau_{\underline{x}}$  is a distribution on  $\mathcal{X}$ ,

$$\forall x \in \mathcal{X}, \tau_{\underline{x}}(x) \geq 0; \quad \sum_{x \in \mathcal{X}} \tau_{\underline{x}}(x) = 1.$$

An input sequence  $\underline{x} \in \mathcal{X}^n$  is said to satisfy the constraints  $\mathcal{P}$  if  $\tau_{\underline{x}} \in \mathcal{P}$ . The capacity [\[Sha48\]](#) of a DMC  $W_{\mathbf{y}|\mathbf{x}}$  with input constraints  $\mathcal{P} \in \Delta(\mathcal{X})$  is

$$C(W_{\mathbf{y}|\mathbf{x}}, \mathcal{P}) = \max_{P_{\mathbf{x}} \in \mathcal{P}} I(\mathbf{x}; \mathbf{y}),$$

where the mutual information

$$I(\mathbf{x}; \mathbf{y}) := \sum_{(x,y) \in \mathcal{X} \times \mathcal{Y}} P_{\mathbf{x},\mathbf{y}}(x,y) \log \frac{P_{\mathbf{x},\mathbf{y}}(x,y)}{P_{\mathbf{x}}(x)P_{\mathbf{y}}(y)}$$

is evaluated w.r.t. the joint distribution  $P_{\mathbf{x},\mathbf{y}} := P_{\mathbf{x}}W_{\mathbf{y}|\mathbf{x}}$  whose marginals are denoted by  $P_{\mathbf{x}}$  and  $P_{\mathbf{y}}$ .

Let  $\mathcal{C} = \{\underline{x}_i\}_{i=1}^M \subset \mathcal{X}^n$  be a code equipped with an  $(L - 1)$ -list-decoder  $\text{Dec}_{L-1,\mathcal{C}}: \mathcal{Y}^n \rightarrow \binom{\mathcal{C}}{L}$ . The rate  $R(\mathcal{C})$  of  $\mathcal{C}$  is defined as  $R(\mathcal{C}) := \frac{1}{n} \log |\mathcal{C}|$ . Assume that  $\mathcal{C}$  satisfies the input constraints  $\mathcal{P}$ , i.e.,  $\tau_{\underline{x}} \in \mathcal{P}$  for all  $\underline{x} \in \mathcal{C}$ . Using  $\mathcal{C}$  on the DMC  $W_{\mathbf{y}|\mathbf{x}}$ , we are interested in upper bounding its average probability of error (i.e., lower bounding the error exponent) under  $\text{Dec}_{L-1,\mathcal{C}}$  which is defined as below

$$P_{e,\text{avg},L-1}(\mathcal{C}) := \frac{1}{M} \sum_{i=1}^M P_{e,L-1}(i, \mathcal{C}),$$

where

$$P_{e,L-1}(i, \mathcal{C}) := \Pr_{\mathbf{y} \sim \prod_{j=1}^n W_{\mathbf{y}|\mathbf{x}=\underline{x}_i(j)}} [\text{Dec}_{L-1,\mathcal{C}}(\mathbf{y}) \not\subseteq \underline{x}_i].$$

Besides being of interest in their own rights, results for this problem are used in [Section XIV](#) to obtain bounds on the list-decoding capacity against *worst-case* errors.

We follow Gallager's approach [Gal65], [Gal68, Theorem 7.4.4]. For a DMC  $W_{\mathbf{y}|\mathbf{x}}$  with input constraints  $\mathcal{P} \subset \Delta(\mathcal{X})$ , we construct a random code  $\mathcal{C}$  of rate  $R < C(W_{\mathbf{y}|\mathbf{x}}, \mathcal{P})$  and analyze its average probability of error  $P_{e,\text{avg},L-1}^{\text{ML}}(\mathcal{C})$  under the ML  $(L-1)$ -list-decoder. Results obtained by this means can be generalized to memoryless channels with *continuous* alphabets, e.g., additive white Gaussian noise (AWGN) channels with power constraints.

### A. Random coding exponent

Let  $\mathcal{C} \in \mathcal{X}^{2^{nR} \times n}$  be a random code whose entries are i.i.d. according to some  $P_{\mathbf{x}} \in \mathcal{P}$ . Let  $M := 2^{nR}$ . We use the ML  $(L-1)$ -list-decoder  $\text{Dec}_{L-1,\mathcal{C}}^{\text{ML}}: \mathcal{Y}^n \rightarrow \binom{[M]}{L-1}$ . That is, receiving  $\underline{y} \in \mathcal{Y}^n$ , the decoder outputs a list  $\{m_1, \dots, m_{L-1}\} \in \binom{[M]}{L-1}$  such that for any other  $m' \in [M] \setminus \{m_1, \dots, m_{L-1}\}$ ,

$$W_{\mathbf{y}|\mathbf{x}}^{\otimes n}(\underline{y}|\underline{x}_{m'}) \leq \min\left\{W_{\mathbf{y}|\mathbf{x}}^{\otimes n}(\underline{y}|\underline{x}_{m_1}), \dots, W_{\mathbf{y}|\mathbf{x}}^{\otimes n}(\underline{y}|\underline{x}_{m_{L-1}})\right\}.$$

An error occurs if  $\underline{x}_m$  was transmitted but  $m \notin \{m_1, \dots, m_{L-1}\}$ . First observe that the error indicator function can be bounded as follows

$$\begin{aligned} \mathbb{1}\{\text{Dec}_{L-1,\mathcal{C}}^{\text{ML}}(\underline{y}) \not\# m\} &= \mathbb{1}\left\{\exists \mathcal{L} \in \binom{[M] \setminus \{m\}}{L-1}, \forall i \in \mathcal{L}, W_{\mathbf{y}|\mathbf{x}}^{\otimes n}(\underline{y}|\underline{x}_i) > W_{\mathbf{y}|\mathbf{x}}^{\otimes n}(\underline{y}|\underline{x}_m)\right\} \\ &= \left(\mathbb{1}\left\{\exists \mathcal{L} \in \binom{[M] \setminus \{m\}}{L-1}, \forall i \in \mathcal{L}, W_{\mathbf{y}|\mathbf{x}}^{\otimes n}(\underline{y}|\underline{x}_i) > W_{\mathbf{y}|\mathbf{x}}^{\otimes n}(\underline{y}|\underline{x}_m)\right\}\right)^\rho \\ &\leq \left(\sum_{\mathcal{L} \in \binom{[M] \setminus \{m\}}{L-1}} \prod_{i \in \mathcal{L}} \mathbb{1}\left\{\frac{W_{\mathbf{y}|\mathbf{x}}^{\otimes n}(\underline{y}|\underline{x}_i)}{W_{\mathbf{y}|\mathbf{x}}^{\otimes n}(\underline{y}|\underline{x}_m)} > 1\right\}\right)^\rho \\ &= \left(\sum_{\mathcal{L} \in \binom{[M] \setminus \{m\}}{L-1}} \prod_{i \in \mathcal{L}} \mathbb{1}\left\{\left(\frac{W_{\mathbf{y}|\mathbf{x}}^{\otimes n}(\underline{y}|\underline{x}_i)}{W_{\mathbf{y}|\mathbf{x}}^{\otimes n}(\underline{y}|\underline{x}_m)}\right)^s > 1^s\right\}\right)^\rho \\ &\leq \left(\sum_{\mathcal{L} \in \binom{[M] \setminus \{m\}}{L-1}} \prod_{i \in \mathcal{L}} \left(\frac{W_{\mathbf{y}|\mathbf{x}}^{\otimes n}(\underline{y}|\underline{x}_i)}{W_{\mathbf{y}|\mathbf{x}}^{\otimes n}(\underline{y}|\underline{x}_m)}\right)^s\right)^\rho, \end{aligned} \quad (137)$$

for any  $\rho > 0$  and  $s > 0$ . **Inequality (137)** follows from the elementary inequality

$$\mathbb{1}\{a > 1\} < a, \quad (138)$$

for any  $a > 0$ . For any message  $m$ , the probability that  $m$  is incorrectly list-decoded is

$$\begin{aligned} P_{e,L-1}^{\text{ML}}(m, \mathcal{C}) &= \sum_{\underline{y} \in \mathcal{Y}^n} W_{\mathbf{y}|\mathbf{x}}^{\otimes n}(\underline{y}|\underline{x}_m) \mathbb{1}\{\text{Dec}_{L-1,\mathcal{C}}^{\text{ML}}(\underline{y}) \not\# m\} \\ &\leq \sum_{\underline{y} \in \mathcal{Y}^n} W_{\mathbf{y}|\mathbf{x}}^{\otimes n}(\underline{y}|\underline{x}_m) \left(\sum_{\mathcal{L} \in \binom{[M] \setminus \{m\}}{L-1}} \prod_{i \in \mathcal{L}} \left(\frac{W_{\mathbf{y}|\mathbf{x}}^{\otimes n}(\underline{y}|\underline{x}_i)}{W_{\mathbf{y}|\mathbf{x}}^{\otimes n}(\underline{y}|\underline{x}_m)}\right)^s\right)^\rho \\ &= \sum_{\underline{y} \in \mathcal{Y}^n} W_{\mathbf{y}|\mathbf{x}}^{\otimes n}(\underline{y}|\underline{x}_m)^{1-s(L-1)\rho} \left(\sum_{\mathcal{L} \in \binom{[M] \setminus \{m\}}{L-1}} \prod_{i \in \mathcal{L}} W_{\mathbf{y}|\mathbf{x}}^{\otimes n}(\underline{y}|\underline{x}_i)^s\right)^\rho. \end{aligned} \quad (139)$$

Averaged over the random generation of  $\mathcal{C}$ , the error probability is

$$\begin{aligned} \mathbb{E}_{\mathcal{C}}[P_{e,L-1}^{\text{ML}}(m, \mathcal{C})] &\leq \sum_{\underline{y} \in \mathcal{Y}^n} \mathbb{E}_{\mathcal{C}} \left[ W_{\mathbf{y}|\mathbf{x}}^{\otimes n}(\underline{y}|\underline{\mathbf{x}}_m)^{1-s(L-1)\rho} \left(\sum_{\mathcal{L} \in \binom{[M] \setminus \{m\}}{L-1}} \prod_{i \in \mathcal{L}} W_{\mathbf{y}|\mathbf{x}}^{\otimes n}(\underline{y}|\underline{\mathbf{x}}_i)^s\right)^\rho \right] \\ &= \sum_{\underline{y} \in \mathcal{Y}^n} \mathbb{E}_{\mathcal{C}} \left[ W_{\mathbf{y}|\mathbf{x}}^{\otimes n}(\underline{y}|\underline{\mathbf{x}}_m)^{1-s(L-1)\rho} \right] \mathbb{E}_{\mathcal{C}} \left[ \left(\sum_{\mathcal{L} \in \binom{[M] \setminus \{m\}}{L-1}} \prod_{i \in \mathcal{L}} W_{\mathbf{y}|\mathbf{x}}^{\otimes n}(\underline{y}|\underline{\mathbf{x}}_i)^s\right)^\rho \right] \end{aligned} \quad (140)$$

$$\leq \sum_{\underline{y} \in \mathcal{Y}^n} \mathbb{E}_{\mathcal{C}} \left[ W_{\underline{y}|\underline{\mathbf{x}}_m}^{\otimes n} 1^{-s(L-1)\rho} \right] \left( \sum_{\mathcal{L} \in \binom{[M] \setminus \{m\}}{L-1}} \mathbb{E}_{\mathcal{C}} \left[ \prod_{i \in \mathcal{L}} W_{\underline{y}|\underline{\mathbf{x}}_i}^{\otimes n} \right]^s \right)^\rho \quad (141)$$

$$= \sum_{\underline{y} \in \mathcal{Y}^n} \mathbb{E}_{\mathcal{C}} \left[ W_{\underline{y}|\underline{\mathbf{x}}_m}^{\otimes n} 1^{-s(L-1)\rho} \right] \left( \sum_{\mathcal{L} \in \binom{[M] \setminus \{m\}}{L-1}} \prod_{i \in \mathcal{L}} \mathbb{E}_{\mathcal{C}} \left[ W_{\underline{y}|\underline{\mathbf{x}}_i}^{\otimes n} \right]^s \right)^\rho, \quad (142)$$

Equations (140) and (142) follow since each codeword in  $\mathcal{C}$  is independent. Inequality (141) is valid when  $0 < \rho \leq 1$  since  $(\cdot)^\rho$  is concave. We also use linearity of expectation here. For any  $i \in [M]$  and  $t > 0$ ,

$$\mathbb{E}_{\mathcal{C}} \left[ W_{\underline{y}|\underline{\mathbf{x}}_i}^{\otimes n} \right]^t = \sum_{\underline{x} \in \mathcal{X}^n} P_{\underline{\mathbf{x}}}^{\otimes n}(\underline{x}) W_{\underline{y}|\underline{x}}^{\otimes n}(\underline{y}|\underline{x})^t,$$

which is independent of  $i$ . Therefore, Equation (142) equals

$$\begin{aligned} & \sum_{\underline{y} \in \mathcal{Y}^n} \left( \sum_{\underline{x} \in \mathcal{X}^n} P_{\underline{\mathbf{x}}}^{\otimes n}(\underline{x}) W_{\underline{y}|\underline{x}}^{\otimes n}(\underline{y}|\underline{x})^{1-s(L-1)\rho} \right) \left( \sum_{\mathcal{L} \in \binom{[M] \setminus \{m\}}{L-1}} \left( \sum_{\underline{x} \in \mathcal{X}^n} P_{\underline{\mathbf{x}}}^{\otimes n}(\underline{x}) W_{\underline{y}|\underline{x}}^{\otimes n}(\underline{y}|\underline{x})^s \right)^{L-1} \right)^\rho \\ &= \left( \frac{M-1}{L-1} \right)^\rho \sum_{\underline{y} \in \mathcal{Y}^n} \left( \sum_{\underline{x} \in \mathcal{X}^n} P_{\underline{\mathbf{x}}}^{\otimes n}(\underline{x}) W_{\underline{y}|\underline{x}}^{\otimes n}(\underline{y}|\underline{x})^{1-s(L-1)\rho} \right) \left( \sum_{\underline{x} \in \mathcal{X}^n} P_{\underline{\mathbf{x}}}^{\otimes n}(\underline{x}) W_{\underline{y}|\underline{x}}^{\otimes n}(\underline{y}|\underline{x})^s \right)^{(L-1)\rho}. \end{aligned}$$

Letting  $s = \frac{1}{1+(L-1)\rho}$ , we get

$$\begin{aligned} & \left( \frac{M-1}{L-1} \right)^\rho \sum_{\underline{y} \in \mathcal{Y}^n} \left( \sum_{\underline{x} \in \mathcal{X}^n} P_{\underline{\mathbf{x}}}^{\otimes n}(\underline{x}) W_{\underline{y}|\underline{x}}^{\otimes n}(\underline{y}|\underline{x})^{\frac{1}{1+(L-1)\rho}} \right)^{1+(L-1)\rho} \\ & \leq M^{(L-1)\rho} \sum_{\underline{y} \in \mathcal{Y}^n} \left( \sum_{\underline{x} \in \mathcal{X}^n} P_{\underline{\mathbf{x}}}^{\otimes n}(\underline{x}) W_{\underline{y}|\underline{x}}^{\otimes n}(\underline{y}|\underline{x})^{\frac{1}{1+(L-1)\rho}} \right)^{1+(L-1)\rho} \\ & = M^{(L-1)\rho} \sum_{\underline{y} \in \mathcal{Y}^n} \left( \sum_{(x_1, \dots, x_n) \in \mathcal{X}^n} \prod_{i=1}^n P_{\underline{\mathbf{x}}}(x_i) W_{\underline{y}|\underline{\mathbf{x}}}(y(i)|x_i)^{\frac{1}{1+(L-1)\rho}} \right)^{1+(L-1)\rho} \\ & = M^{(L-1)\rho} \sum_{\underline{y} \in \mathcal{Y}^n} \left( \prod_{i=1}^n \sum_{x_i \in \mathcal{X}} P_{\underline{\mathbf{x}}}(x_i) W_{\underline{y}|\underline{\mathbf{x}}}(y(i)|x_i)^{\frac{1}{1+(L-1)\rho}} \right)^{1+(L-1)\rho} \\ & = M^{(L-1)\rho} \sum_{(y_1, \dots, y_n) \in \mathcal{Y}^n} \prod_{i=1}^n \left( \sum_{x_i \in \mathcal{X}} P_{\underline{\mathbf{x}}}(x_i) W_{\underline{y}|\underline{\mathbf{x}}}(y_i|x_i)^{\frac{1}{1+(L-1)\rho}} \right)^{1+(L-1)\rho} \\ & = M^{(L-1)\rho} \prod_{i=1}^n \sum_{y_i \in \mathcal{Y}} \left( \sum_{x_i \in \mathcal{X}} P_{\underline{\mathbf{x}}}(x_i) W_{\underline{y}|\underline{\mathbf{x}}}(y_i|x_i)^{\frac{1}{1+(L-1)\rho}} \right)^{1+(L-1)\rho} \\ & = M^{(L-1)\rho} \left[ \sum_{\underline{y} \in \mathcal{Y}^n} \left( \sum_{\underline{x} \in \mathcal{X}^n} P_{\underline{\mathbf{x}}}(x) W_{\underline{y}|\underline{x}}(y|x)^{\frac{1}{1+(L-1)\rho}} \right)^{1+(L-1)\rho} \right]^n \\ & = \exp_2(-n[-(L-1)\rho R + E_0((L-1)\rho, P_{\underline{\mathbf{x}}})]), \end{aligned} \quad (143)$$

where

$$E_0(\rho, P_{\underline{\mathbf{x}}}) := -\ln \left[ \sum_{\underline{y} \in \mathcal{Y}^n} \left( \sum_{\underline{x} \in \mathcal{X}^n} P_{\underline{\mathbf{x}}}(x) W_{\underline{y}|\underline{x}}(y|x)^{\frac{1}{1+\rho}} \right)^{1+\rho} \right].$$

Optimizing over  $0 \leq \rho \leq 1$ , we get the random coding exponent

$$E_{r,L-1}(R, P_{\mathbf{x}}) := \max_{0 \leq \rho \leq 1} \{-(L-1)\rho R + E_0((L-1)\rho, P_{\mathbf{x}})\}.$$

### B. Expurgated exponent

Taking  $\rho = 1$  and  $s = 1/L$  in Equation (139), we have

$$\begin{aligned} P_{e,L-1}^{\text{ML}}(m_0, \mathcal{C}) &\leq \sum_{\underline{y} \in \mathcal{Y}^n} W_{\underline{y}|\underline{x}}^{\otimes n}(\underline{y}|\underline{x}_m)^{1/L} \sum_{\mathcal{L} \in \binom{[M] \setminus \{m\}}{L-1}} \prod_{i \in \mathcal{L}} W_{\underline{y}|\underline{x}}^{\otimes n}(\underline{y}|\underline{x}_i)^{1/L} \\ &= \sum_{\{m_1, \dots, m_{L-1}\} \in \binom{[M] \setminus \{m_0\}}{L-1}} \sum_{\underline{y} \in \mathcal{Y}^n} \prod_{i=0}^{L-1} W_{\underline{y}|\underline{x}}^{\otimes n}(\underline{y}|\underline{x}_{m_i})^{1/L} \\ &= \sum_{\{m_1, \dots, m_{L-1}\} \in \binom{[M] \setminus \{m_0\}}{L-1}} \sum_{(y_1, \dots, y_n) \in \mathcal{Y}^n} \prod_{j=1}^n \prod_{i=0}^{L-1} W_{\underline{y}|\underline{x}}(y_j|\underline{x}_{m_i}(j))^{1/L} \\ &= \sum_{\{m_1, \dots, m_{L-1}\} \in \binom{[M] \setminus \{m_0\}}{L-1}} \prod_{j=1}^n \sum_{y_j \in \mathcal{Y}} \prod_{i=0}^{L-1} W_{\underline{y}|\underline{x}}(y_j|\underline{x}_{m_i}(j))^{1/L} \\ &= \sum_{\{m_1, \dots, m_{L-1}\} \in \binom{[M] \setminus \{m_0\}}{L-1}} q(\underline{x}_{m_0}, \underline{x}_{m_1}, \dots, \underline{x}_{m_{L-1}}), \end{aligned} \quad (144)$$

where in Equation (144) we define

$$q(\underline{x}_{m_0}, \underline{x}_{m_1}, \dots, \underline{x}_{m_{L-1}}) := \prod_{j=1}^n \sum_{y_j \in \mathcal{Y}} \prod_{i=0}^{L-1} W_{\underline{y}|\underline{x}}(y_j|\underline{x}_{m_i}(j))^{1/L}.$$

Now for any  $B > 0$ ,

$$\begin{aligned} \Pr_{\mathcal{C}}[P_{e,L-1}^{\text{ML}}(m_0, \mathcal{C}) > B] &= \mathbb{E}_{\mathcal{C}}[\mathbf{1}\{P_{e,L-1}^{\text{ML}}(m_0, \mathcal{C}) > B\}] \\ &\leq \mathbb{E}_{\mathcal{C}} \left[ \mathbf{1} \left\{ \sum_{\{m_1, \dots, m_{L-1}\} \in \binom{[M] \setminus \{m_0\}}{L-1}} q(\underline{x}_{m_0}, \underline{x}_{m_1}, \dots, \underline{x}_{m_{L-1}}) > B \right\} \right] \\ &= \mathbb{E}_{\mathcal{C}} \left[ \mathbf{1} \left\{ \sum_{\{m_1, \dots, m_{L-1}\} \in \binom{[M] \setminus \{m_0\}}{L-1}} \left| \frac{q(\underline{x}_{m_0}, \underline{x}_{m_1}, \dots, \underline{x}_{m_{L-1}})}{B} \right| > 1 \right\} \right] \\ &\leq \mathbb{E}_{\mathcal{C}} \left[ \mathbf{1} \left\{ \left( \sum_{\{m_1, \dots, m_{L-1}\} \in \binom{[M] \setminus \{m_0\}}{L-1}} \left| \frac{q(\underline{x}_{m_0}, \underline{x}_{m_1}, \dots, \underline{x}_{m_{L-1}})}{B} \right|^s \right)^{1/s} > 1 \right\} \right] \end{aligned} \quad (145)$$

$$\begin{aligned} &= \mathbb{E}_{\mathcal{C}} \left[ \mathbf{1} \left\{ \sum_{\{m_1, \dots, m_{L-1}\} \in \binom{[M] \setminus \{m_0\}}{L-1}} \frac{q(\underline{x}_{m_0}, \underline{x}_{m_1}, \dots, \underline{x}_{m_{L-1}})^s}{B^s} > 1 \right\} \right] \\ &\leq \mathbb{E}_{\mathcal{C}} \left[ \sum_{\{m_1, \dots, m_{L-1}\} \in \binom{[M] \setminus \{m_0\}}{L-1}} \frac{q(\underline{x}_{m_0}, \underline{x}_{m_1}, \dots, \underline{x}_{m_{L-1}})^s}{B^s} \right] \end{aligned} \quad (146)$$

$$= \sum_{\{m_1, \dots, m_{L-1}\} \in \binom{[M] \setminus \{m_0\}}{L-1}} B^{-s} \mathbb{E}_{\mathcal{C}} \left[ q(\underline{x}_{m_0}, \underline{x}_{m_1}, \dots, \underline{x}_{m_{L-1}})^s \right]. \quad (147)$$



Equation (145) is valid for any  $0 \leq s \leq 1$  since  $\|\cdot\|_s$  is decreasing in  $s$ . Inequality (146) follows from Inequality (138). We then bound the above expectation.

$$\begin{aligned}
\mathbb{E}_{\mathcal{C}} \left[ q(\mathbf{x}_{m_0}, \mathbf{x}_{m_1}, \dots, \mathbf{x}_{m_{L-1}})^s \right] &= \sum_{(\underline{x}_0, \dots, \underline{x}_{L-1}) \in (\mathcal{X}^n)^L} \left( \prod_{k=0}^{L-1} P_{\mathbf{x}}^{\otimes n}(\underline{x}_k) \right) q(\underline{x}_0, \underline{x}_1, \dots, \underline{x}_{L-1})^s \\
&= \sum_{(\underline{x}_0, \dots, \underline{x}_{L-1}) \in (\mathcal{X}^n)^L} \left( \prod_{k=0}^{L-1} P_{\mathbf{x}}^{\otimes n}(\underline{x}_k) \right) \left( \prod_{j=1}^n \sum_{y_j \in \mathcal{Y}} \prod_{i=0}^{L-1} W_{\mathbf{y}|\mathbf{x}}(y_j | \underline{x}_i(j))^{1/L} \right)^s \\
&= \sum_{(\underline{x}_0, \dots, \underline{x}_{L-1}) \in (\mathcal{X}^n)^L} \left[ \prod_{j=1}^n \prod_{k=0}^{L-1} P_{\mathbf{x}}(\underline{x}_k(j)) \right] \left[ \prod_{j=1}^n \left( \sum_{y_j \in \mathcal{Y}} \prod_{i=0}^{L-1} W_{\mathbf{y}|\mathbf{x}}(y_j | \underline{x}_i(j))^{1/L} \right)^s \right] \\
&= \sum_{(\underline{x}_0, \dots, \underline{x}_{L-1}) \in (\mathcal{X}^n)^L} \prod_{j=1}^n \left( \prod_{k=0}^{L-1} P_{\mathbf{x}}(\underline{x}_k(j)) \right) \left( \sum_{y_j \in \mathcal{Y}} \prod_{i=0}^{L-1} W_{\mathbf{y}|\mathbf{x}}(y_j | \underline{x}_i(j))^{1/L} \right)^s \\
&= \sum_{\substack{(x_{0,1}, \dots, x_{L-1,1}) \in \mathcal{X}^L \\ \vdots \\ (x_{0,n}, \dots, x_{L-1,n}) \in \mathcal{X}^L}} \prod_{j=1}^n \left( \prod_{k=0}^{L-1} P_{\mathbf{x}}(x_{k,j}) \right) \left( \sum_{y_j \in \mathcal{Y}} \prod_{i=0}^{L-1} W_{\mathbf{y}|\mathbf{x}}(y_j | x_{i,j})^{1/L} \right)^s \\
&= \prod_{j=1}^n \sum_{(x_{0,j}, \dots, x_{L-1,j}) \in \mathcal{X}^L} \left( \prod_{k=0}^{L-1} P_{\mathbf{x}}(x_{k,j}) \right) \left( \sum_{y_j \in \mathcal{Y}} \prod_{i=0}^{L-1} W_{\mathbf{y}|\mathbf{x}}(y_j | x_{i,j})^{1/L} \right)^s \\
&= \left[ \sum_{(x_0, \dots, x_{L-1}) \in \mathcal{X}^L} \left( \prod_{k=0}^{L-1} P_{\mathbf{x}}(x_k) \right) \left( \sum_{y \in \mathcal{Y}} \prod_{i=0}^{L-1} W_{\mathbf{y}|\mathbf{x}}(y | x_i)^{1/L} \right)^s \right]^n,
\end{aligned}$$

which is independent of  $m_0, \dots, m_{L-1}$ . Then Equation (147) becomes at most

$$M^{L-1} B^{-s} \left[ \sum_{(x_0, \dots, x_{L-1}) \in \mathcal{X}^L} \left( \prod_{k=0}^{L-1} P_{\mathbf{x}}(x_k) \right) \left( \sum_{y \in \mathcal{Y}} \prod_{i=0}^{L-1} W_{\mathbf{y}|\mathbf{x}}(y | x_i)^{1/L} \right)^s \right]^n.$$

Choose  $B$  such that the above quantity equals  $1/2$ , i.e.,

$$\begin{aligned}
B &= \left( \frac{1}{2} M^{-(L-1)} \left[ \sum_{(x_0, \dots, x_{L-1}) \in \mathcal{X}^L} \left( \prod_{k=0}^{L-1} P_{\mathbf{x}}(x_k) \right) \left( \sum_{y \in \mathcal{Y}} \prod_{i=0}^{L-1} W_{\mathbf{y}|\mathbf{x}}(y | x_i)^{1/L} \right)^s \right]^{-n} \right)^{-1/s} \\
&= (2M^{L-1})^{1/s} \left[ \sum_{(x_0, \dots, x_{L-1}) \in \mathcal{X}^L} \left( \prod_{k=0}^{L-1} P_{\mathbf{x}}(x_k) \right) \left( \sum_{y \in \mathcal{Y}} \prod_{i=0}^{L-1} W_{\mathbf{y}|\mathbf{x}}(y | x_i)^{1/L} \right)^s \right]^{n/s}.
\end{aligned}$$

Under the above choice of  $B$ , we get that

$$\mathbb{E}_{\mathcal{C}} [\{m \in [M] : P_{e,L-1}^{\text{ML}}(m, \mathcal{C}) > B\}] = \sum_{m \in [M]} \Pr_{\mathcal{C}} [P_{e,L-1}^{\text{ML}}(m, \mathcal{C}) > B] = M/2.$$

Therefore, if we expurgate all codewords in  $\mathcal{C}$  with probability of error exceeding  $B$ , we get a code  $\mathcal{C}' \subset \mathcal{C}$  of expected size  $M/2$  whose codewords all have probability of error at most  $P_{e,L-1}^{\text{ML}}(m, \mathcal{C}') \leq P_{e,L-1}^{\text{ML}}(m, \mathcal{C}) \leq B$ . The first inequality follows since the probability of error of each codeword does not increase if there are less competing codewords. Letting  $\rho := 1/s \geq 1$  and  $R = \frac{1}{n} \ln \frac{M}{2}$ , we get the following upper bound on the error probability

$$\begin{aligned}
B &= (2^L (M/2)^{L-1})^\rho \left[ \sum_{(x_0, \dots, x_{L-1}) \in \mathcal{X}^L} \left( \prod_{k=0}^{L-1} P_{\mathbf{x}}(x_k) \right) \left( \sum_{y \in \mathcal{Y}} \prod_{i=0}^{L-1} W_{\mathbf{y}|\mathbf{x}}(y | x_i)^{1/L} \right)^{1/\rho} \right]^{\rho n} \\
&= 2^{L\rho} \exp_2(-n[-(L-1)\rho R + E_{\mathbf{x},L-1}(\rho, P_{\mathbf{x}})]),
\end{aligned} \tag{148}$$

where

$$E_{x,L-1}(\rho, P_{\mathbf{x}}) := -\rho \ln \left[ \sum_{(x_0, \dots, x_{L-1}) \in \mathcal{X}^L} \left( \prod_{k=0}^{L-1} P_{\mathbf{x}}(x_k) \right) \left( \sum_{y \in \mathcal{Y}} \prod_{i=0}^{L-1} W_{y|\mathbf{x}}(y|x_i)^{1/L} \right)^{1/\rho} \right].$$

The above bound can be translated to the following lower bound on error exponent

$$E_{\text{ex},L-1}(R, P_{\mathbf{x}}) := \max_{\rho \geq 1} \{ -(L-1)\rho R + E_{x,L-1}(\rho, P_{\mathbf{x}}) \}.$$

### C. Input constraints

Associate the input alphabet  $\mathcal{X}$  with a cost function  $f: \mathcal{X} \rightarrow \mathbb{R}$ . We impose the power constraint that any input sequence should satisfy  $\sum_{i=1}^n f(\underline{x}(i)) \leq 0$ . We can alternatively write this constraint in terms of  $\tau_{\underline{x}}$  by observing that

$$\sum_{i=1}^n f(\underline{x}(i)) = \sum_{x \in \mathcal{X}} n \tau_{\underline{x}}(x) f(x).$$

Therefore,  $\sum_{i=1}^n f(\underline{x}(i)) \leq 0$  is equivalent to  $\tau_{\underline{x}} \in \mathcal{P}_f$  where

$$\mathcal{P}_f := \left\{ P_{\mathbf{x}} \in \Delta(\mathcal{X}) : \sum_{x \in \mathcal{X}} P_{\mathbf{x}}(x) f(x) \leq 0 \right\}.$$

For the DMC  $W_{y|\mathbf{x}}$  with input constraints  $\mathcal{P}_f$ , we sample codewords from  $Q_{\underline{x}} \in \Delta(\mathcal{X}^n)$  which is obtained by truncating the input distribution  $P_{\mathbf{x}}^{\otimes n}$  so that it satisfies the power constraint. Specifically, for some  $\delta > 0$ , for any  $\underline{x} \in \mathcal{X}^n$ ,

$$Q_{\underline{x}}(\underline{x}) := Z^{-1} P_{\mathbf{x}}^{\otimes n}(\underline{x}) \mathbb{1} \left\{ \sum_{i=1}^n f(\underline{x}(i)) \in [-\delta, 0] \right\},$$

where

$$Z := \sum_{\underline{x} \in \mathcal{X}^n} P_{\mathbf{x}}^{\otimes n}(\underline{x}) \mathbb{1} \left\{ \sum_{i=1}^n f(\underline{x}(i)) \in [-\delta, 0] \right\}$$

is a normalizing constant. Though  $Q_{\underline{x}}$  is not a product distribution, we will upper bound it pointwise by a product distribution. Note that the indicator function of the power constraint can be bounded as follows,

$$\begin{aligned} \mathbb{1} \left\{ -\delta \leq \sum_{i=1}^n f(\underline{x}(i)) \leq 0 \right\} &= \mathbb{1} \left\{ 0 \leq \sum_{i=1}^n f(\underline{x}(i)) + \delta \leq \delta \right\} \\ &= \mathbb{1} \left\{ e^{s \cdot 0} \leq e^{s(\sum_{i=1}^n f(\underline{x}(i)) + \delta)} \leq e^{s\delta} \right\} \\ &\leq \mathbb{1} \left\{ e^{s(\sum_{i=1}^n f(\underline{x}(i)) + \delta)} \geq 1 \right\} \\ &\leq e^{s(\sum_{i=1}^n f(\underline{x}(i)) + \delta)}, \end{aligned} \tag{149}$$

for any  $s \geq 0$ . **Inequality (149)** is by **Inequality (138)**. Therefore we have

$$Q_{\underline{x}}(\underline{x}) \leq Z^{-1} P_{\mathbf{x}}^{\otimes n}(\underline{x}) e^{s(\sum_{i=1}^n f(\underline{x}(i)) + \delta)} = \prod_{i=1}^n \left( P_{\mathbf{x}}(\underline{x}(i)) e^{s f(\underline{x}(i))} e^{s\delta/n} Z^{-1/n} \right).$$

Replacing  $P_{\mathbf{x}}(x)$  with  $P_{\mathbf{x}}(x) e^{s f(x)} e^{s\delta/n} Z^{-1/n}$  in **Equation (143)**, we have a random coding bound with input constraints:

$$\mathbb{E}_{\mathcal{C}} [P_{e,L-1}^{\text{ML}}(m, \mathcal{C})] \leq M^{(L-1)\rho} \left( \frac{e^{s\delta}}{Z} \right)^{1+(L-1)\rho} \left[ \sum_{y \in \mathcal{Y}} \left( \sum_{x \in \mathcal{X}} P_{\mathbf{x}}(x) e^{s f(x)} W_{y|\mathbf{x}}(y|x)^{\frac{1}{1+(L-1)\rho}} \right)^{1+(L-1)\rho} \right]^n, \tag{150}$$

for  $s \geq 0$  and  $0 \leq \rho \leq 1$ . A similar substitution for Equation (148) yields an expurgated bound with input constraints:

$$2^{L\rho} M^{(L-1)\rho} \left( \frac{e^{s\delta}}{Z} \right)^{L\rho} \left[ \sum_{(x_0, \dots, x_{L-1}) \in \mathcal{X}^L} \left( e^{s \sum_{k=0}^{L-1} f(x_k)} \prod_{k=0}^{L-1} P_{\mathbf{x}}(x_k) \right) \left( \sum_{y \in \mathcal{Y}} \prod_{i=0}^{L-1} W_{\mathbf{y}|\mathbf{x}}(y|x_i)^{1/L} \right)^{1/\rho} \right]^{\rho n}, \quad (151)$$

for  $s \geq 0$  and  $\rho \geq 1$ .

#### D. Continuous alphabets

Equations (150) and (151) can be generalized to channels over the reals in a straightforward manner:

$$M^{(L-1)\rho} \left( \frac{e^{s\delta}}{Z} \right)^{1+(L-1)\rho} \left[ \int_{\mathbb{R}} \left( \int_{\mathbb{R}} P_{\mathbf{x}}(x) e^{s f(x)} W_{\mathbf{y}|\mathbf{x}}(y|x)^{\frac{1}{1+(L-1)\rho}} dx \right)^{1+(L-1)\rho} dy \right]^n, \quad (152)$$

where  $s \geq 0$  and  $0 \leq \rho \leq 1$ ;

$$2^{L\rho} M^{(L-1)\rho} \left( \frac{e^{s\delta}}{Z} \right)^{L\rho} \left[ \int_{\mathbb{R}^L} \left( e^{s \sum_{k=0}^{L-1} f(x_k)} \prod_{k=0}^{L-1} P_{\mathbf{x}}(x_k) \right) \left( \int_{\mathbb{R}} \prod_{i=0}^{L-1} W_{\mathbf{y}|\mathbf{x}}(y|x_i)^{1/L} dy \right)^{1/\rho} d(x_0, \dots, x_{L-1}) \right]^{\rho n}, \quad (153)$$

where  $s \geq 0, \rho \geq 1$  and

$$Z := \int_{\mathbb{R}^n} P_{\mathbf{x}}^{\otimes n}(\underline{x}) \mathbb{1} \left\{ \sum_{i=1}^n f(\underline{x}(i)) \in [-\delta, 0] \right\} d\underline{x}. \quad (154)$$

#### E. Random coding exponent for AWGN channels with input constraints

In this section, we evaluate the random coding exponent (Equation (152)) in the case of AWGN channels with input constraint  $P$  and noise variance  $\sigma^2$  under  $(L-1)$ -list-decoding. We prove the following theorem.

**Theorem 56.** *Let  $P, \sigma > 0$  and  $L \in \mathbb{Z}_{\geq 2}$ . There exist codes of rate  $R$  for the AWGN channel with input constraint  $P$  and noise variance  $\sigma^2$  such that the rate satisfies  $0 \leq R \leq \frac{1}{2} \ln(1 + P/\sigma^2)$  and the exponent  $E_{L-1}(R, P/\sigma^2)$  of the probability of error (normalized by  $\lim_{n \rightarrow \infty} -\frac{1}{n} \ln(\cdot)$ ) under  $(L-1)$ -list-decoding is bounded as follows.*

Let  $\text{snr} := P/\sigma^2$  and

$$R_{x,L-1}(\text{snr}) := \frac{1}{2} \left( \ln \frac{\sqrt{L^2 + \text{snr}^2 - 2\text{snr}(L-2)} + L + \text{snr}}{2L} + \frac{1}{L-1} \ln \frac{\sqrt{L^2 + \text{snr}^2 - 2\text{snr}(L-2)} + L - \text{snr}}{2L} \right), \quad (155)$$

$$R_{\text{crit},L-1}(\text{snr}) := \frac{1}{2} \ln \left( \frac{1}{2} + \frac{\text{snr}}{2L} + \frac{1}{2} \sqrt{1 - \frac{2(L-2)}{L^2} \text{snr} + \frac{\text{snr}^2}{L^2}} \right). \quad (156)$$

1) If  $R_{\text{crit},L-1}(\text{snr}) \leq R \leq \frac{1}{2} \ln(1 + \text{snr})$ , then

$$E_{L-1}(R, \text{snr}) \geq \frac{1}{2} \ln \left[ e^{2R} - \frac{\text{snr}(e^{2R} - 1)}{2} \left( \sqrt{1 + \frac{4e^{2R}}{\text{snr}(e^{2R} - 1)}} - 1 \right) \right] + \frac{\text{snr}}{4e^{2R}} \left( e^{2R} + 1 - (e^{2R} - 1) \sqrt{1 + \frac{4e^{2R}}{\text{snr}(e^{2R} - 1)}} \right). \quad (157)$$

2) If  $0 \leq R \leq R_{\text{crit},L-1}(\text{snr})$ , then

$$E_{L-1}(R, \text{snr}) \geq -R(L-1) + \frac{L-1}{2} \ln \left( L + \text{snr} + \sqrt{(L - \text{snr})^2 + 4\text{snr}} \right) + \frac{1}{2} \ln \left( L - \text{snr} + \sqrt{(L - \text{snr})^2 + 4\text{snr}} \right) + \frac{1}{4} \left( L + \text{snr} - \sqrt{(L - \text{snr})^2 + 4\text{snr}} \right) - \frac{L}{2} \ln(2L). \quad (158)$$

For an AWGN channel with input constraint  $P$  and noise variance  $\sigma^2$ , the channel transition kernel is given by

$$W_{\mathbf{y}|\mathbf{x}}(y|x) = \frac{1}{\sqrt{2\pi\sigma^2}} e^{-\frac{(y-x)^2}{2\sigma^2}}, \quad (159)$$

and the cost function is given by

$$f(x) = x^2 - P. \quad (160)$$

Let  $P_{\mathbf{x}}$  be the Gaussian density with variance  $P$ :

$$P_{\mathbf{x}}(x) = \frac{1}{\sqrt{2\pi P}} e^{-\frac{x^2}{2P}}. \quad (161)$$

For a constant  $\delta > 0$ , we claim that the factor  $(e^{s\delta}/Z)^{1+(L-1)\rho}$  that appears in Equation (152) scales like  $\text{poly}(n)$  for asymptotically large  $n$  and therefore does not effectively contribute to the exponent. Indeed, the following lemma holds.

**Lemma 57.** *Let  $P, \sigma, \delta > 0$  be constants. Let  $P_{\mathbf{x}}$  be the Gaussian density with variance  $P$  as defined in Equation (161). Let  $f(x) := x^2 - P$ . Let  $Z$  be defined by Equation (154). Then  $Z \stackrel{n \rightarrow \infty}{\asymp} \frac{\delta}{2P\sqrt{\pi n}}$ .*

*Proof.* The proof follows from the central limit theorem.

$$\begin{aligned} Z &= \int_{\mathbb{R}^n} P_{\mathbf{x}}^{\otimes n}(\underline{x}) \mathbf{1} \left\{ -\delta \leq \sum_{i=1}^n (\underline{x}(i)^2 - P) \leq 0 \right\} d\underline{x} \\ &= \Pr \left[ -\delta \leq P \left( \sum_{i=1}^n \mathcal{N}_i(0, 1)^2 - n \right) \leq 0 \right] \\ &= \Pr \left[ \frac{-\delta}{P\sqrt{2n}} \leq \frac{\chi^2(n) - n}{\sqrt{2n}} \leq 0 \right] \\ &\stackrel{n \rightarrow \infty}{\asymp} \Pr \left[ \frac{-\delta}{P\sqrt{2n}} \leq \mathcal{N}(0, 1) \leq 0 \right] \end{aligned} \quad (162)$$

$$\begin{aligned} &\stackrel{n \rightarrow \infty}{\asymp} \frac{\delta}{P\sqrt{2n}} \cdot \frac{1}{\sqrt{2\pi}} \\ &= \frac{\delta}{2P\sqrt{\pi n}}. \end{aligned} \quad (163)$$

Equation (162) follows since  $\frac{\chi^2(n)-n}{\sqrt{2n}}$  converges to  $\mathcal{N}(0, 1)$  in distribution as  $n \rightarrow \infty$ . Equation (163) follows since the Gaussian measure of a thin interval  $\left[-\frac{\delta}{P\sqrt{2n}}, 0\right]$  is essentially the area of a rectangle with width  $\frac{\delta}{P\sqrt{2n}}$  and height  $P_{\mathbf{x}}(0) = 1/\sqrt{2\pi}$  for asymptotically large  $n$ .  $\square$

We are now ready to evaluate the random coding bound (Equation (152)) on the probability of the  $(L-1)$ -list-decoding error of AWGN channels with input constraint  $P$  and noise variance  $\sigma^2$ .

*Proof of Theorem 56.* The exponent (i.e., the probability of error normalized by  $-\frac{1}{n} \ln(\cdot)$ ) given by Equation (152) specializes to

$$-R(L-1)\rho - \ln \left[ \int_{\mathbb{R}} \left( \int_{\mathbb{R}} \frac{1}{\sqrt{2\pi P}} e^{-\frac{x^2}{2P}} e^{s(x^2-P)} \left( \frac{1}{\sqrt{2\pi\sigma^2}} e^{-\frac{(y-x)^2}{2\sigma^2}} \right)^{\frac{1}{1+(L-1)\rho}} dx \right)^{1+(L-1)\rho} dy \right].$$

For notational convenience, let  $\gamma := 1 + (L-1)\rho$ . We first compute the inner integral

$$\begin{aligned} I(y) &:= \int_{\mathbb{R}} \frac{1}{\sqrt{2\pi P}} \frac{1}{\sqrt{2\pi\sigma^2}^{1/\gamma}} \exp \left( -\frac{x^2}{2P} + s(x^2-P) - \frac{(y-x)^2}{2\sigma^2\gamma} \right) dx \\ &= \int_{\mathbb{R}} \frac{1}{\sqrt{2\pi P}} \frac{1}{\sqrt{2\pi\sigma^2}^{1/\gamma}} \exp \left( \left( -\frac{1}{2P} + s - \frac{1}{2\sigma^2\gamma} \right) x^2 + \frac{y}{\sigma^2\gamma} x - sP - \frac{1}{2\sigma^2\gamma} y^2 \right) dx, \end{aligned}$$

which is a Gaussian integral. We let

$$a := \frac{1}{2P} - s + \frac{1}{2\sigma^2\gamma}, \quad b := \frac{y}{\sigma^2\gamma} \quad c := -sP - \frac{1}{2\sigma^2\gamma}y^2,$$

and

$$A := \sqrt{\frac{\pi}{a}} = \sqrt{\pi \left( \frac{1}{2P} - s + \frac{1}{2\sigma^2\gamma} \right)^{-1}} = \sqrt{\frac{2\pi P\sigma^2\gamma}{\sigma^2\gamma(1-2sP) + P}}.$$

By [Lemma 13](#), the above integral  $I(y)$  equals

$$\begin{aligned} A \cdot \frac{1}{\sqrt{2\pi P}} \frac{1}{\sqrt{2\pi\sigma^2}^{1/\gamma}} \exp\left(\frac{b^2}{4a} + c\right) &= A \cdot \frac{1}{\sqrt{2\pi P}} \frac{1}{\sqrt{2\pi\sigma^2}^{1/\gamma}} \exp\left(\frac{y^2}{\sigma^4\gamma^2 \cdot 4 \cdot \left(\frac{1}{2P} - s + \frac{1}{2\sigma^2\gamma}\right)} - sP - \frac{y^2}{2\sigma^2\gamma}\right) \\ &= A \cdot \frac{1}{\sqrt{2\pi P}} \frac{1}{\sqrt{2\pi\sigma^2}^{1/\gamma}} \exp\left(-\frac{1-2sP}{2(\sigma^2\gamma(1-2sP) + P)}y^2 - sP\right). \end{aligned}$$

We then compute the outer integral:

$$\int_{\mathbb{R}} I(y)^\gamma dy = \int_{\mathbb{R}} A^\gamma \frac{1}{\sqrt{2\pi P}^\gamma} \frac{1}{\sqrt{2\pi\sigma^2}^\gamma} \exp\left(-\frac{(1-2sP)\gamma}{2(\sigma^2\gamma(1-2sP) + P)}y^2 - sP\gamma\right) dy.$$

We get again a Gaussian integral. Let

$$a' := \frac{(1-2sP)\gamma}{2(\sigma^2\gamma(1-2sP) + P)}, \quad b' := 0, \quad c' := -sP\gamma.$$

By [Lemma 13](#),

$$\begin{aligned} \int_{\mathbb{R}} I(y)^\gamma dy &= A^\gamma \frac{1}{\sqrt{2\pi P}^\gamma} \frac{1}{\sqrt{2\pi\sigma^2}^\gamma} \cdot \sqrt{\frac{\pi}{a'}} e^{c'} \\ &= \sqrt{\frac{2\pi P\sigma^2\gamma}{\sigma^2\gamma(1-2sP) + P}} \frac{1}{\sqrt{2\pi P}^\gamma} \frac{1}{\sqrt{2\pi\sigma^2}^\gamma} \sqrt{\pi \frac{2(\sigma^2\gamma(1-2sP) + P)}{(1-2sP)\gamma}} e^{-sP\gamma}. \end{aligned}$$

With this, the random coding exponent becomes

$$\begin{aligned} E(s, \gamma) &:= -R(L-1)\rho - \ln \left[ \sqrt{\frac{2\pi P\sigma^2\gamma}{\sigma^2\gamma(1-2sP) + P}} \frac{1}{\sqrt{2\pi P}^\gamma} \frac{1}{\sqrt{2\pi\sigma^2}^\gamma} \sqrt{\pi \frac{2(\sigma^2\gamma(1-2sP) + P)}{(1-2sP)\gamma}} e^{-sP\gamma} \right] \\ &= -R(\gamma-1) + \frac{\gamma-1}{2} \ln \left( 1 - 2sP + \frac{P}{\sigma^2\gamma} \right) + \frac{1}{2} \ln(1-2sP) + sP\gamma. \end{aligned} \quad (164)$$

For the above bound to be valid, we need  $s < \frac{1}{2P}$ .

Recall that  $s \geq 0, \rho \in [0, 1]$  and  $\gamma = 1 + (L-1)\rho$ . We need to maximize  $E(s, \gamma)$  in the region  $s \in [0, 1/(2P)], \gamma \in [1, L]$ . To this end, we compute the stationary  $s$  and  $\gamma$ .

$$\frac{\partial}{\partial s} E(s, \gamma) = P \left( -\frac{\gamma-1}{1-2sP + \frac{P}{\sigma^2\gamma}} + \frac{1}{1-2sP} + \gamma \right) = 0, \quad (165)$$

$$\frac{\partial}{\partial \gamma} E(s, \gamma) = -R + \frac{1}{2} \ln \left( 1 - 2sP + \frac{P}{\sigma^2\gamma} \right) - \frac{P(\gamma-1)}{2\gamma(P + \sigma^2\gamma(1-2sP))} + sP. \quad (166)$$

Let  $\text{snr} := P/\sigma^2$  denote the signal-to-noise ratio (SNR). Solving  $s$  from [Equation \(165\)](#), we get

$$s = \frac{1}{4P} \left( 1 + \frac{\text{snr}}{\gamma} - \frac{1}{\gamma} \sqrt{(\gamma - \text{snr})^2 + 4\text{snr}} \right). \quad (167)$$

One can easily check that  $s \geq 0$  provided  $\gamma \geq 1$ . Furthermore,  $s < \frac{1}{2P}$ .

Putting Equation (167) into Equation (166) and solving  $\gamma$  therein, we get

$$\gamma = \frac{\text{snr}}{2e^{2R}} \left( 1 + \sqrt{1 + \frac{4\text{snr}}{\text{snr}(e^{2R} - 1)}} \right). \quad (168)$$

It can be easily verified that  $\gamma \geq 1$  for any  $R \leq \frac{1}{2} \ln(1 + \text{snr})$ .

Suppose  $\gamma \leq L$ . Then the minimum value of  $E(s, \gamma)$  is indeed achieved at the above  $\gamma$  given by Equation (168). Note that the condition  $\gamma \leq L$  is equivalent to

$$R \geq \frac{1}{2} \ln \left( \frac{1}{2} + \frac{\text{snr}}{2L} + \frac{1}{2} \sqrt{1 - \frac{2(L-2)}{L^2} \text{snr} + \frac{\text{snr}^2}{L^2}} \right). \quad (169)$$

Substituting the stationary  $\gamma$  (Equation (168)) back to Equation (167), we get the stationary  $s$  as a function of only  $\text{snr}$  and  $R$ . Note that here  $s$  and  $\gamma$  do not depend on  $L$ . Therefore the calculations in this case coincide with those for unique-decoding case as done in [Gal68, Theorem 7.4.4] and we omit the details. Putting both  $s$  and  $\gamma$  into Equation (164), we finally get the random coding exponent

$$\begin{aligned} \min_{s \in [0, 1/(2P)], \gamma \in [1, L]} E(s, \gamma) &= \frac{1}{2} \ln \left[ e^{2R} - \frac{\text{snr}(e^{2R} - 1)}{2} \left( \sqrt{1 + \frac{4e^{2R}}{\text{snr}(e^{2R} - 1)}} - 1 \right) \right] \\ &\quad + \frac{\text{snr}}{4e^{2R}} \left( e^{2R} + 1 - (e^{2R} - 1) \sqrt{1 + \frac{4e^{2R}}{\text{snr}(e^{2R} - 1)}} \right). \end{aligned}$$

This proves Item 1 in Theorem 56.

On the other hand, if the  $\gamma$  given by Equation (168) is larger than  $L$ , i.e., Inequality (169) holds in the reverse direction, then the minimum value of  $E(s, \gamma)$  is achieved at  $\gamma = L$ . In this case,  $s$  given by Equation (167) becomes

$$s = \frac{1}{4P} \left( 1 + \frac{\text{snr}}{L} - \frac{1}{L} \sqrt{(L - \text{snr})^2 + 4\text{snr}} \right), \quad (170)$$

and the minimum value of  $E(s, \gamma)$  is achieved at  $\gamma = L$  and the  $s$  given by Equation (170):

$$\begin{aligned} \min_{s \in [0, 1/(2P)], \gamma \in [1, L]} E(s, \gamma) &= -R(L-1) + \frac{L-1}{2} \ln \left( L + \text{snr} + \sqrt{(L - \text{snr})^2 + 4\text{snr}} \right) \\ &\quad + \frac{1}{2} \ln \left( L - \text{snr} + \sqrt{(L - \text{snr})^2 + 4\text{snr}} \right) \\ &\quad + \frac{1}{4} \left( L + \text{snr} - \sqrt{(L - \text{snr})^2 + 4\text{snr}} \right) - \frac{L}{2} \ln(2L). \end{aligned}$$

This proves Item 2 in Theorem 56. □

### F. Expurgated exponent for AWGN channels with input constraints

We proceed to evaluate the expurgated exponent (Equation (153)) in the case of AWGN channels with input constraint  $P$  and noise variance  $\sigma^2$  under  $(L-1)$ -list-decoding. We prove the following theorem.

**Theorem 58.** *Let  $P, \sigma > 0$  and  $L \in \mathbb{Z}_{\geq 2}$ . Consider an AWGN channel with input constraint  $P$  and noise variance  $\sigma^2$ . Let  $\text{snr} := P/\sigma^2$ . Let  $R_{x, L-1}(\text{snr})$  be defined by Equation (155). Then there exist codes of rate  $0 \leq R \leq R_{x, L-1}(\text{snr})$  for the above channel such that the exponent  $E_{L-1}(R, \text{snr})$  of the probability of error (normalized by  $\lim_{n \rightarrow \infty} -\frac{1}{n} \ln(\cdot)$ ) under  $(L-1)$ -list-decoding is bounded as follows:*

$$E_{L-1}(R, \text{snr}) \geq \frac{\text{snr}(Lt - 1)}{2Lt}, \quad (171)$$

where  $t$  is the unique solution of  $(Lt - 1)e^{2R} = (L - 1)t^{\frac{L}{L-1}}$  in  $t \in [1/L, 1]$ .

*Proof.* For the channel of interest, the channel transition kernel  $W_{y|x}$ , the cost function  $f$  and the input distribution  $P_x$  are given by Equations (159) to (161), respectively. For a constant  $\delta > 0$ , by Lemma 57, the factor  $2^{L\rho} \left( \frac{e^{s\delta}}{Z} \right)^{L\rho}$  is

subexponential in  $n$  and does not play a role in the exponent. Therefore, the exponent of [Equation \(153\)](#) specializes to

$$R(L-1)\rho + \rho \ln \left[ \int_{\mathbb{R}^L} \left( e^{s \sum_{k=0}^{L-1} x_k^2 - sLP} \frac{1}{\sqrt{2\pi P^L}} e^{-\frac{\sum_{k=0}^{L-1} x_k^2}{2P}} \right) \left( \int_{\mathbb{R}} \frac{1}{\sqrt{2\pi\sigma^2}} e^{-\frac{\sum_{k=0}^{L-1} (y-x_k)^2}{2\sigma^2 L}} dy \right)^{1/\rho} d(x_0, \dots, x_{L-1}) \right]. \quad (172)$$

The inner integral w.r.t.  $y$  in [Equation \(172\)](#) is a Gaussian integral and can be computed as follows using [Lemma 13](#).

$$\begin{aligned} \int_{\mathbb{R}} \frac{1}{\sqrt{2\pi\sigma^2}} \exp\left(-\frac{1}{2\sigma^2 L} \sum_{i=0}^{L-1} (y-x_i)^2\right) dy &= \frac{1}{\sqrt{2\pi\sigma^2}} \int_{\mathbb{R}} \exp\left(-\frac{1}{2\sigma^2} y^2 + \frac{1}{\sigma^2 L} y \sum_{i=0}^{L-1} x_i - \frac{1}{2\sigma^2 L} \sum_{i=0}^{L-1} x_i^2\right) dy \\ &= \exp\left(\frac{1}{2\sigma^2 L^2} \left( \left( \sum_{i=0}^{L-1} x_i \right)^2 - L \sum_{i=0}^{L-1} x_i^2 \right)\right) \\ &= \exp\left(\frac{1}{2\sigma^2 L^2} \left( \sum_{0 \leq i \neq j \leq L-1} x_i x_j - (L-1) \sum_{i=0}^{L-1} x_i^2 \right)\right). \end{aligned}$$

Now the  $L$ -dimensional integral inside the logarithm in [Equation \(172\)](#) equals

$$\begin{aligned} &\int_{\mathbb{R}^L} \frac{1}{\sqrt{2\pi P^L}} \exp\left(s \sum_{i=0}^{L-1} x_i^2 - sLP - \frac{1}{2P} \sum_{i=0}^{L-1} x_i^2 + \frac{1}{2\sigma^2 L^2 \rho} \left( \sum_{0 \leq i \neq j \leq L-1} x_i x_j - (L-1) \sum_{i=0}^{L-1} x_i^2 \right)\right) d(x_0, \dots, x_{L-1}) \\ &= \frac{e^{-sLP}}{\sqrt{2\pi P^L}} \int_{\mathbb{R}^L} \exp\left(\left(s - \frac{1}{2P} - \frac{L-1}{2\sigma^2 L^2 \rho}\right) \sum_{i=0}^{L-1} x_i^2 + \frac{1}{2\sigma^2 L^2 \rho} \sum_{0 \leq i \neq j \leq L-1} x_i x_j\right) d(x_0, \dots, x_{L-1}) \\ &= \frac{e^{-sLP}}{\sqrt{2\pi P^L}} \int_{\mathbb{R}^L} \exp(-\vec{x}^\top A \vec{x}) d\vec{x}, \end{aligned} \quad (173)$$

where  $\vec{x} = [x_0, \dots, x_{L-1}] \in \mathbb{R}^L$  and  $A \in \mathbb{R}^{L \times L}$  is a matrix with all diagonal entries equal to

$$a := \frac{1}{2P} + \frac{L-1}{2\sigma^2 L^2 \rho} - s$$

and all off-diagonal entries equal to

$$b := -\frac{1}{2\sigma^2 L^2 \rho}.$$

By [Lemma 14](#), the RHS of [Equation \(173\)](#) equals

$$\frac{e^{-sLP}}{\sqrt{2\pi P^L}} \sqrt{\frac{\pi^L}{\det(A)}} = \frac{e^{-sLP}}{\sqrt{2P^L} \sqrt{\det(A)}}. \quad (174)$$

To compute  $\det(A)$ , we note that  $A = (a-b)I_L + (\sqrt{-b}\vec{\mathbf{1}}_L)(-\sqrt{-b}\vec{\mathbf{1}}_L)^\top$  where  $\vec{\mathbf{1}}_L$  denotes the all-one vector of length  $L$ .

**Lemma 59** (Matrix determinant lemma). *Let  $A \in \mathbb{R}^{n \times n}$  be a non-singular matrix and let  $\underline{u}, \underline{v} \in \mathbb{R}^n$ . Then*

$$\det(A + \underline{u}\underline{v}^\top) = (1 + \underline{v}^\top A^{-1} \underline{u}) \det(A).$$

By [Lemma 59](#), we have

$$\begin{aligned} \det(A) &= \left[ 1 + (-\sqrt{-b}\vec{\mathbf{1}}_L)^\top ((a-b)I_L)^{-1} (\sqrt{-b}\vec{\mathbf{1}}_L) \right] \det((a-b)I_L) \\ &= \left( 1 + \frac{b}{a-b} L \right) (a-b)^L \\ &= (a + (L-1)b)(a-b)^{L-1} \\ &= \left( \frac{1}{2P} - s \right) \left( \frac{1}{2P} + \frac{1}{2\sigma^2 L \rho} - s \right)^{L-1}. \end{aligned}$$

Therefore, the (natural) logarithm of the RHS of [Equation \(174\)](#) equals

$$\begin{aligned} & -sLP - \frac{L}{2} \ln(2P) - \frac{1}{2} \ln\left(\frac{1}{2P} - s\right) - \frac{L-1}{2} \ln\left(\frac{1}{2P} + \frac{1}{2\sigma^2 L \rho} - s\right) \\ & = -\left(sLP + \frac{1}{2} \ln(1 - 2sP) + \frac{L-1}{2} \ln\left(1 - 2sP + \frac{P}{\sigma^2 L \rho}\right)\right). \end{aligned}$$

Plugging the above expression back to [Equation \(172\)](#), we see that to get the largest error exponent, we need to minimize the following expression over  $s \geq 0$  and  $\rho \geq 1$ .

$$R(L-1)\rho - \rho \left[ sLP + \frac{1}{2} \ln(1 - 2sP) + \frac{L-1}{2} \ln\left(1 - 2sP + \frac{P}{\sigma^2 L \rho}\right) \right]. \quad (175)$$

From the calculations in [Section XIV-C](#), one can obtain an expression of the solution to the above minimization problem. Specifically, negating [Equation \(175\)](#), by [Equation \(116\)](#), we know that the maximum value equals

$$\frac{P(L(1 - 2Ps) - 1)}{2L\sigma^2(1 - 2Ps)} = \frac{\text{snr}(Lt - 1)}{2Lt}, \quad (176)$$

where  $t := 1 - 2Ps$ . Recall that  $0 \leq s \leq \frac{1-1/L}{2P}$  satisfies [Equation \(115\)](#) which can be rewritten in term of  $t$  as

$$R = \frac{1}{2} \left[ \ln \frac{(L-1)t}{Lt-1} + \frac{1}{L-1} \ln t \right]. \quad (177)$$

Equivalently,  $t$  is the unique solution of the equation  $(Lt - 1)e^{2R} = (L-1)t^{\frac{L}{L-1}}$  in  $t \in [1/L, 1]$ ,

[Equation \(176\)](#) is valid whenever  $\rho \geq 1$ . Recall the relation between  $\rho$  and  $s$  ([Equation \(113\)](#)). We rewrite it in terms of  $t$ :

$$\rho = \frac{(L-1) + L(t-1)}{2L^2 \cdot \frac{1-t}{2P} \cdot t \cdot \sigma^2} = \frac{(Lt-1)\text{snr}}{L^2(1-t)t}.$$

By the above relation between  $\rho$  and  $t$ , the condition  $\rho \geq 1$  is equivalent to

$$t \geq \frac{L - \text{snr} + \sqrt{L^2 + \text{snr}^2 - 2\text{snr}(L-2)}}{2L}. \quad (178)$$

Plugging the RHS of [Inequality \(178\)](#) to [Equation \(177\)](#), the condition  $\rho \geq 1$  is further equivalent to

$$R \leq \frac{1}{2} \left( \ln \frac{\sqrt{L^2 + \text{snr}^2 - 2\text{snr}(L-2)} + L + \text{snr}}{2L} + \frac{1}{L-1} \ln \frac{\sqrt{L^2 + \text{snr}^2 - 2\text{snr}(L-2)} + L - \text{snr}}{2L} \right),$$

the RHS of which is defined as  $R_{x,L-1}(\text{snr})$ . We conclude that the error exponent given by the RHS of [Equation \(176\)](#) can be achieved for any  $R \leq R_{x,L-1}(\text{snr})$ .  $\square$

### G. List-decoding error exponents vs. unique-decoding error exponents

Our bounds on the list-decoding error exponent of AWGN channels recover Gallager's results [[Gal65](#)], [[Gal68](#), [Theorem 7.4.4](#)] for unique-decoding. Indeed, when  $L = 2$ , [Equations \(155\)](#) and [\(156\)](#) become

$$R_{x,1}(\text{snr}) = \frac{1}{2} \left( \ln \frac{\sqrt{4 + \text{snr}^2} + 2 + \text{snr}}{4} + \ln \frac{\sqrt{4 + \text{snr}^2} + 2 - \text{snr}}{4} \right) = \frac{1}{2} \ln \left( \frac{1}{2} + \frac{1}{2} \sqrt{1 + \frac{\text{snr}^2}{4}} \right), \quad (179)$$

$$R_{\text{crit},1}(\text{snr}) = \frac{1}{2} \ln \left( \frac{1}{2} + \frac{\text{snr}}{4} + \frac{1}{2} \sqrt{1 + \frac{\text{snr}^2}{4}} \right), \quad (180)$$

and the random coding exponent in [Theorem 56](#) specializes to

$$E_1(R, \text{snr}) \geq \frac{1}{2} \ln \left[ e^{2R} - \frac{\text{snr}(e^{2R} - 1)}{2} \left( \sqrt{1 + \frac{4e^{2R}}{\text{snr}(e^{2R} - 1)}} - 1 \right) \right]$$



$$+ \frac{\text{snr}}{4e^{2R}} \left( e^{2R} + 1 - (e^{2R} - 1) \sqrt{1 + \frac{4e^{2R}}{\text{snr}(e^{2R} - 1)}} \right) \quad (181)$$

for  $R_{\text{crit},1}(\text{snr}) \leq R \leq \frac{1}{2} \ln(1 + \text{snr})$ , and

$$\begin{aligned} E_1(R, \text{snr}) &= -R + \frac{1}{2} \ln(2 + \text{snr} + \sqrt{4 + \text{snr}^2}) + \frac{1}{2} \ln(2 - \text{snr} + \sqrt{4 + \text{snr}^2}) + \frac{1}{4} (2 + \text{snr} - \sqrt{4 + \text{snr}^2}) - \ln 4 \\ &= -R + \frac{1}{2} \ln \left( \frac{1}{2} + \frac{1}{2} \sqrt{1 + \frac{\text{snr}^2}{4}} \right) + \frac{1}{2} + \frac{\text{snr}}{4} - \frac{1}{2} \sqrt{1 + \frac{\text{snr}^2}{4}} \end{aligned} \quad (182)$$

for  $0 \leq R \leq R_{\text{crit},1}(\text{snr})$ .

As for the expurgated exponent, to evaluate the bound in [Theorem 58](#), we first solve  $t \in [1/2, 1]$  from the equation  $(2t - 1)e^{2R} = t^2$  and get

$$t = e^{2R} (1 - \sqrt{1 - e^{-2R}}).$$

Substituting  $t$  in [Equation \(171\)](#) yields

$$E_1(R, \text{snr}) \geq \frac{\text{snr}(2t - 1)}{4t} = \frac{\text{snr} \cdot t^2 e^{-2R}}{4t} = \frac{\text{snr} \cdot t e^{-2R}}{4} = \frac{\text{snr}}{4} (1 - \sqrt{1 - e^{-2R}}). \quad (183)$$

It has been long known that for DMCs and AWGN channels, list-decoding under any subexponential (in  $n$ ) list-sizes does not increase the channel capacity. Interestingly, our results show that list-decoding under constant list-sizes does not increase the error exponent of capacity-achieving codes. Indeed, for any  $\text{snr} > 0$  and any constant  $L \in \mathbb{Z}_{\geq 2}$ , the error exponent remains the same under  $(L - 1)$ -list-decoding for any  $R_{x,1}(\text{snr}) \leq R \leq \frac{1}{2} \ln(1 + \text{snr})$ . However, list-decoding does boost the error exponent for any  $0 \leq R \leq R_{x,1}(\text{snr})$ . In particular, the critical rates under list-decoding move, i.e.,  $R_{\text{crit},L-1}(\text{snr}) > R_{\text{crit},1}(\text{snr})$  and  $R_{x,L-1}(\text{snr}) > R_{x,1}(\text{snr})$  for any  $L \in \mathbb{Z}_{>2}$ .

Gallager's exponents and our list-decoding error exponents (for  $L = 3$ ) are plotted in [Figure 11](#) for  $\text{snr} = 1$ .

## XVIII. LIST-DECODING ERROR EXPONENTS OF AWGN CHANNELS WITHOUT INPUT CONSTRAINTS

In this section, we obtain bounds on the  $(L - 1)$ -list-decoding error exponent of an AWGN channel with *no* input constraint and noise variance  $\sigma^2$ . An *unbounded* code for such a channel contains codewords whose length can be arbitrarily large. The rate of such a code is measured by [Equation \(22\)](#).

### A. Random coding exponent

**Theorem 60.** *For any  $\sigma > 0, \alpha \geq 1$  and  $L \in \mathbb{Z}_{\geq 2}$ , there exists an unbounded code  $\mathcal{C} \subset \mathbb{R}^n$  of rate  $R = \frac{1}{2} \ln \frac{1}{2\pi e \sigma^2 \alpha^2}$  such that when used over an AWGN channel with noise variance  $\sigma^2$  and no input constraint, the exponent of the average probability of  $(L - 1)$ -list-decoding error of  $\mathcal{C}$  (normalized by  $\lim_{n \rightarrow \infty} -\frac{1}{n} \ln(\cdot)$ ) is at least  $E_{r,L-1}(\alpha)$  defined as*

$$E_{r,L-1}(\alpha) = \begin{cases} \frac{\alpha^2}{2} - \ln \alpha - \frac{1}{2}, & 1 \leq \alpha \leq \sqrt{L} \\ \frac{L-1}{2} - \frac{L}{2} \ln L + (L-1) \ln \alpha, & \alpha > \sqrt{L} \end{cases}.$$

*Proof.* Let  $\alpha \geq 1$  and  $R = \frac{1}{2} \ln \frac{1}{2\pi e \sigma^2 \alpha^2}$ . Let  $\mathcal{C} \subset \mathbb{R}^n$  be a Poisson Point Process with intensity  $\lambda = e^{nR} = (2\pi e \sigma^2 \alpha^2)^{-n/2}$ . By translating  $\mathcal{C}$ , we assume without loss of generality that  $\underline{0} \in \mathcal{C}$ . By [Item 1](#) of [Fact 16](#), the distribution of the translated process remains the same.

Let  $\mathcal{E}_{L-1}^{\text{ML}}(\mathcal{C})$  denote the error event of  $\mathcal{C}$  under ML  $(L - 1)$ -list-decoding given  $\underline{0}$  is transmitted.

$$\mathcal{E}_{L-1}^{\text{ML}}(\mathcal{C}) := \left\{ \exists \{ \underline{x}_1, \dots, \underline{x}_{L-1} \} \in \binom{\mathcal{C} \setminus \{ \underline{0} \}}{L-1}, \forall i \in [L-1], \|\underline{x}_i - \underline{\mathbf{g}}\|_2 < \|\underline{\mathbf{g}}\|_2 \right\}.$$

For any instantiated  $\mathcal{C}$ , we can bound the probability of  $\mathcal{E}_{L-1}^{\text{ML}}(\mathcal{C})$  as follows.

$$\begin{aligned} \Pr[\mathcal{E}_{L-1}^{\text{ML}}(\mathcal{C})] &= \mathbb{E}_{\mathbf{r}} \left[ \Pr[\mathcal{E}_{L-1}^{\text{ML}}(\mathcal{C}) \mid \|\underline{\mathbf{g}}\|_2 = \mathbf{r}] \right] \\ &= \int_0^\infty f_{\|\underline{\mathbf{g}}\|_2}(r) \Pr[\mathcal{E}_{L-1}^{\text{ML}}(\mathcal{C}) \mid \|\underline{\mathbf{g}}\|_2 = r] \, dr \end{aligned}$$

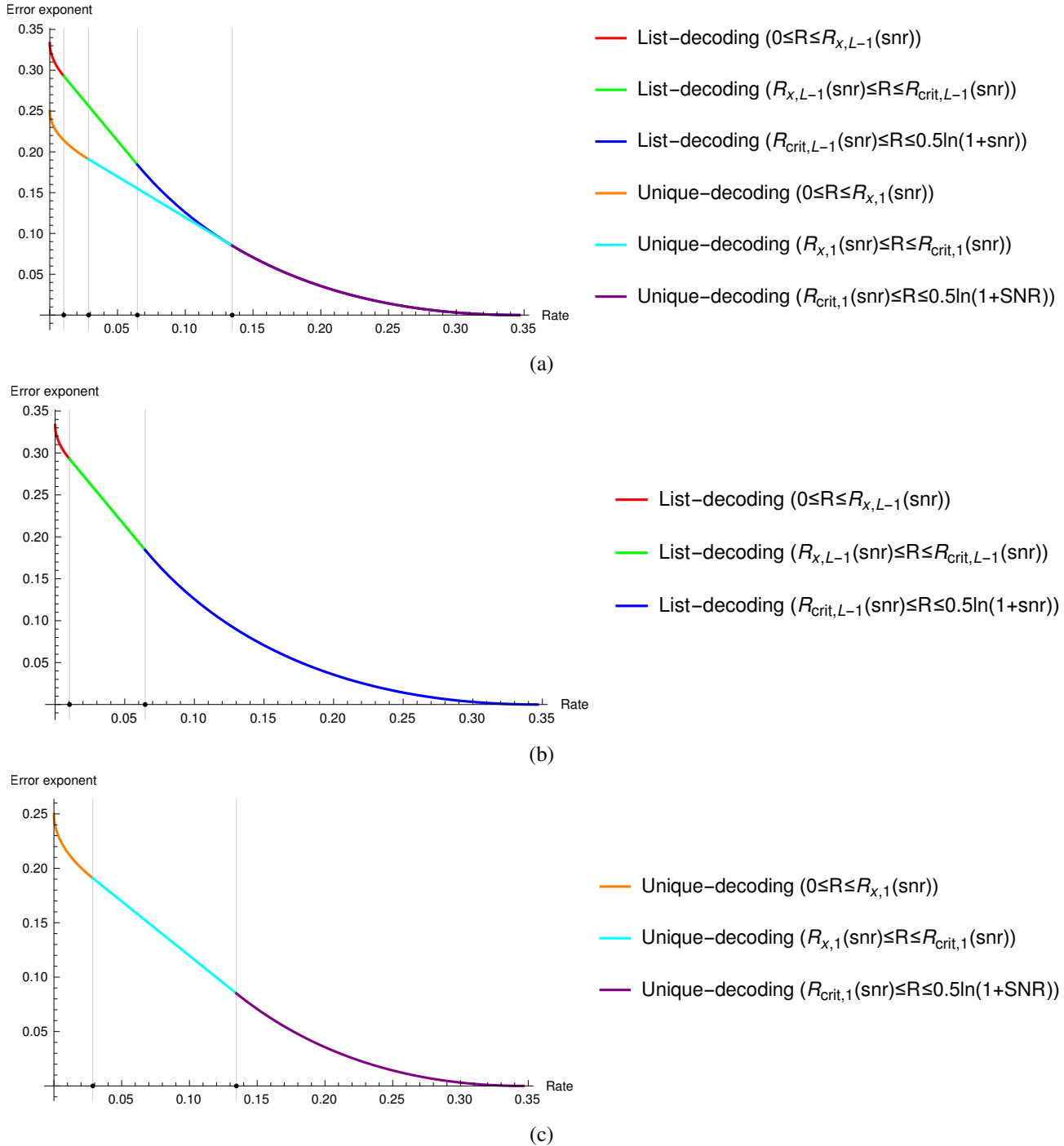

Fig. 11: Comparison of Gallager's unique-decoding error exponents (Equations (181) to (183)) and our list-decoding error exponents (Equations (157), (158) and (171)) for AWGN channels with  $\text{snr} = 1$ . We plot our bounds for  $L = 3$ . The horizontal axis is the rate  $0 \leq R \leq \frac{1}{2} \ln(1 + \text{snr})$  and the vertical axis is the values of the exponents. The list-decoding error exponents and the unique-decoding error exponents are plotted jointly in Section XVII-G and are plotted separately in Figures 11b and 11c, respectively. Interestingly, the error exponent under list-decoding remains the same for sufficiently large rate, i.e.,  $R \geq R_{x,1}(\text{snr})$ . However, for any rate less than  $R_{x,1}(\text{snr})$ , list-decoding does increase the error exponent. Moreover, the critical rates  $R_{x,L-1}(\text{snr})$  and  $R_{\text{crit},L-1}(\text{snr})$  (see Equations (155) and (156)) become smaller than  $R_{x,1}(\text{snr})$  and  $R_{\text{crit},1}(\text{snr})$  (see Equations (179) and (180)), respectively, under  $(L - 1)$ -list-decoding.

$$\leq \int_0^{r^*} f_{\|\underline{\mathbf{g}}\|_2}(r) \Pr\left[\mathcal{E}_{L-1}^{\text{ML}}(\mathcal{C}) \mid \|\underline{\mathbf{g}}\|_2 = r\right] dr + \int_{r^*}^{\infty} f_{\|\underline{\mathbf{g}}\|_2}(r) dr. \quad (184)$$

The function  $f_{\|\underline{\mathbf{g}}\|_2}$  denotes the p.d.f. of the  $\ell_2$ -norm of a Gaussian vector  $\underline{\mathbf{g}} \sim \mathcal{N}(\mathbf{0}, \sigma^2 I_n)$ . The randomness of the above probability and expectation comes from the Gaussian noise  $\underline{\mathbf{g}}$ . In Equation (184),  $r^* > 0$  is to be specified.

Conditioned on  $\underline{\mathbf{0}} \in \mathcal{C}$  being transmitted, the rest of  $\mathcal{C}$  follows the Palm distribution denoted by  $\mathbb{E}^{\text{Palm}}$  and  $\Pr^{\text{Palm}}$ . We now average Equation (184) over the PPP  $\mathcal{C}$ . The second term is independent of  $\mathcal{C}$  and remains the same under averaging. As for the first term, we note that

$$\Pr\left[\mathcal{E}_{L-1}^{\text{ML}}(\mathcal{C}) \mid \|\underline{\mathbf{g}}\|_2 = r\right] = \Pr\left[\exists \{\underline{\mathbf{x}}_1, \dots, \underline{\mathbf{x}}_{L-1}\} \in \binom{\mathcal{C} \setminus \{\underline{\mathbf{0}}\}}{L-1}, \forall i \in [L-1], \|\underline{\mathbf{x}}_i - \underline{\mathbf{g}}\|_2 < r \mid \|\underline{\mathbf{g}}\|_2 = r\right] \\ \leq \min \left\{ \sum_{\{\underline{\mathbf{x}}_1, \dots, \underline{\mathbf{x}}_{L-1}\} \in \binom{\mathcal{C} \setminus \{\underline{\mathbf{0}}\}}{L-1}} \Pr\left[\forall i \in [L-1], \underline{\mathbf{x}}_i \in \text{int}(\mathcal{B}^n(\underline{\mathbf{g}}, r)) \mid \|\underline{\mathbf{g}}\|_2 = r\right], 1 \right\}. \quad (185)$$

The first term in Equation (184) then is at most

$$\sum_{\{\underline{\mathbf{x}}_1, \dots, \underline{\mathbf{x}}_{L-1}\} \in \binom{\mathcal{C} \setminus \{\underline{\mathbf{0}}\}}{L-1}} \int_0^{r^*} f_{\|\underline{\mathbf{g}}\|_2}(r) \Pr\left[\forall i \in [L-1], \underline{\mathbf{x}}_i \in \text{int}(\mathcal{B}^n(\underline{\mathbf{g}}, r)) \mid \|\underline{\mathbf{g}}\|_2 = r\right] dr, \quad (186)$$

where we only used the first term of the minimization in Equation (185). Now, the first term in Equation (184) averaged over  $\mathcal{C}$  can be bounded as follows:

$$\mathbb{E}_{\mathcal{C}}^{\text{Palm}} \left[ \int_0^{r^*} f_{\|\underline{\mathbf{g}}\|_2}(r) \Pr_{\underline{\mathbf{g}}} \left[ \mathcal{E}_{L-1}^{\text{ML}}(\mathcal{C}) \mid \|\underline{\mathbf{g}}\|_2 = r \right] dr \right] \\ = \mathbb{E}_{\mathcal{C}} \left[ \int_0^{r^*} f_{\|\underline{\mathbf{g}}\|_2}(r) \Pr_{\underline{\mathbf{g}}} \left[ \mathcal{E}_{L-1}^{\text{ML}}(\mathcal{C}) \mid \|\underline{\mathbf{g}}\|_2 = r \right] dr \right] \quad (187)$$

$$\leq \mathbb{E}_{\mathcal{C}} \left[ \sum_{\{\underline{\mathbf{x}}_1, \dots, \underline{\mathbf{x}}_{L-1}\} \in \binom{\mathcal{C} \setminus \{\underline{\mathbf{0}}\}}{L-1}} \int_0^{r^*} f_{\|\underline{\mathbf{g}}\|_2}(r) \Pr\left[\forall i \in [L-1], \underline{\mathbf{x}}_i \in \text{int}(\mathcal{B}^n(\underline{\mathbf{g}}, r)) \mid \|\underline{\mathbf{g}}\|_2 = r\right] dr \right] \quad (188)$$

$$= \int_{\mathbb{R}^{n(L-1)}} \left( \int_0^{r^*} f_{\|\underline{\mathbf{g}}\|_2}(r) \Pr_{\underline{\mathbf{g}}} \left[ \forall i \in [L-1], \underline{\mathbf{x}}_i \in \text{int}(\mathcal{B}^n(\underline{\mathbf{g}}, r)) \mid \|\underline{\mathbf{g}}\|_2 = r \right] dr \right) \lambda^{L-1} d(\underline{\mathbf{x}}_1, \dots, \underline{\mathbf{x}}_{L-1}) \quad (189)$$

$$= \int_0^{r^*} f_{\|\underline{\mathbf{g}}\|_2}(r) \lambda^{L-1} \int_{\mathbb{R}^{n(L-1)}} \Pr\left[\forall i \in [L-1], \underline{\mathbf{x}}_i \in \text{int}(\mathcal{B}^n(\underline{\mathbf{g}}, r)) \mid \|\underline{\mathbf{g}}\|_2 = r\right] d(\underline{\mathbf{x}}_1, \dots, \underline{\mathbf{x}}_{L-1}) dr \\ = \int_0^{r^*} f_{\|\underline{\mathbf{g}}\|_2}(r) \lambda^{L-1} \int_{\mathbb{R}^{n(L-1)}} \mathbb{E}_{\underline{\mathbf{g}}} \left[ \prod_{i=1}^{L-1} \mathbb{1}\{\underline{\mathbf{x}}_i \in \text{int}(\mathcal{B}^n(\underline{\mathbf{g}}, r))\} \mid \|\underline{\mathbf{g}}\|_2 = r \right] d(\underline{\mathbf{x}}_1, \dots, \underline{\mathbf{x}}_{L-1}) dr \\ = \int_0^{r^*} f_{\|\underline{\mathbf{g}}\|_2}(r) \lambda^{L-1} \mathbb{E}_{\underline{\mathbf{g}}} \left[ \int_{\mathbb{R}^{n(L-1)}} \prod_{i=1}^{L-1} \mathbb{1}\{\underline{\mathbf{x}}_i \in \text{int}(\mathcal{B}^n(\underline{\mathbf{g}}, r))\} d(\underline{\mathbf{x}}_1, \dots, \underline{\mathbf{x}}_{L-1}) \mid \|\underline{\mathbf{g}}\|_2 = r \right] dr \\ = \int_0^{r^*} f_{\|\underline{\mathbf{g}}\|_2}(r) \lambda^{L-1} \mathbb{E}_{\underline{\mathbf{g}}} \left[ \prod_{i=1}^{L-1} \int_{\mathbb{R}^n} \mathbb{1}\{\underline{\mathbf{x}}_i \in \text{int}(\mathcal{B}^n(\underline{\mathbf{g}}, r))\} d\underline{\mathbf{x}}_i \mid \|\underline{\mathbf{g}}\|_2 = r \right] dr \\ = \int_0^{r^*} f_{\|\underline{\mathbf{g}}\|_2}(r) \lambda^{L-1} \mathbb{E}_{\underline{\mathbf{g}}} \left[ |\mathcal{B}^n(r)|^{L-1} \mid \|\underline{\mathbf{g}}\|_2 = r \right] dr \\ = \lambda^{L-1} V_n^{L-1} \int_0^{r^*} f_{\|\underline{\mathbf{g}}\|_2}(r) r^{n(L-1)} dr. \quad (190)$$

Equation (187) is by Slivnyak's theorem (Theorem 18). Inequality (188) follows from Equation (186). Equation (189) is by Campbell's theorem (Theorem 17).

We choose  $r^*$  such that the sum of [Equation \(190\)](#) and the second term in [Equation \(184\)](#) is minimized. That is,  $r^*$  is a zero of the derivative (w.r.t.  $r^*$ ) of the sum. Recall the way one takes derivative w.r.t. the limit of an integral. If

$$F(x) = \int_a^x f(t)dt,$$

then

$$\frac{d}{dx}F(x) = f(x).$$

Therefore,  $r^*$  satisfies

$$\lambda^{L-1}V_n^{L-1}f_{\|\mathbf{g}\|_2}(r^*)(r^*)^{n(L-1)} - f_{\|\mathbf{g}\|_2}(r^*) = 0 \quad \implies \quad r^* = \lambda^{-1/n}V_n^{-1/n}.$$

By the choice of  $\lambda$ , we further have

$$r^* = e^{-R} \left( \frac{2\pi e}{n} \right)^{-1/2} (1 + o(1)) = \exp\left(-\frac{1}{2} \ln \frac{1}{2\pi e \sigma^2 \alpha^2}\right) (2\pi e)^{-1/2} \sqrt{n} (1 + o(1)) = \alpha \sigma \sqrt{n} (1 + o(1)). \quad (191)$$

Next, we evaluate the bound we got for the error probability

$$\lambda^{L-1}V_n^{L-1} \int_0^{r^*} f_{\|\mathbf{g}\|_2}(r) r^{n(L-1)} dr + \Pr[\|\mathbf{g}\|_2 > r^*]. \quad (192)$$

The density of the  $\ell_2$ -norm of a Gaussian vector of variance  $\sigma^2$  is

$$f_{\|\mathbf{g}\|_2}(r) = \sigma^{-1} f(r/\sigma), \quad (193)$$

where  $f(\cdot)$  is the density of the  $\ell_2$ -norm  $\|\mathbf{g}_0\|_2$  of a standard Gaussian vector  $\mathbf{g}_0 \sim \mathcal{N}(0, I_n)$ . Neglecting the  $o(1)$  factor in  $r^*$  ([Equation \(191\)](#)), we get that the first term of [Equation \(192\)](#) (dot) equals

$$\begin{aligned} & (2\pi e \sigma^2 \alpha^2)^{-\frac{1}{2}n(L-1)} \left( \frac{2\pi e}{n} \right)^{\frac{1}{2}n(L-1)} \int_0^{\alpha \sigma \sqrt{n}} \sigma^{-1} f(r/\sigma) r^{n(L-1)} dr \\ &= (\sigma^2 \alpha^2 n)^{-\frac{1}{2}n(L-1)} \int_0^\alpha \sigma^{-1} f(s\sqrt{n}) (s\sigma\sqrt{n})^{n(L-1)} \sigma \sqrt{n} ds \\ &= \alpha^{-n(L-1)} \sqrt{n} \int_0^\alpha f(s\sqrt{n}) s^{n(L-1)} ds. \end{aligned} \quad (194)$$

In [Equation \(85\)](#), we let  $s = \frac{r}{\sigma\sqrt{n}}$ .

The following asymptotics of  $f(\cdot)$  was obtained in [[AB10](#), Eqn. (129)].

**Lemma 61** ([[AB10](#)]). *The p.d.f.  $f(\cdot)$  of the  $\ell_2$ -norm of an  $n$ -dimensional standard Gaussian vector satisfies the following pointwise estimate:*

$$f(s\sqrt{n}) = \exp\left(-n\left(\frac{s^2}{2} - \ln s - \frac{1}{2}\right) + o(n)\right),$$

for any  $s \geq 0$ .

By [Lemma 61](#), the first term of [Equation \(192\)](#) dot equals

$$\int_0^\alpha \exp\left(-n\left[\left(\frac{s^2}{2} - \ln s - \frac{1}{2}\right) - (L-1)\ln s + (L-1)\ln \alpha\right]\right) ds = \int_0^\alpha \exp\left(-n\left[\frac{s^2}{2} - L\ln s - \frac{1}{2} + (L-1)\ln \alpha\right]\right) ds \quad (195)$$

where we have suppressed the polynomial factor  $\sqrt{n}$ . To evaluate the integral in [Equation \(195\)](#), we will apply the Laplace's method ([Theorem 8](#)). It is easy to check that the function  $F(s) := \frac{s^2}{2} - L\ln s - \frac{1}{2} + (L-1)\ln \alpha$  is decreasing in  $s \in [0, \sqrt{L}]$  and is increasing in  $s \in [\sqrt{L}, \infty]$ .

If  $\alpha \leq \sqrt{L}$ , the minimum value of  $F(s)$  in  $[0, \alpha]$  is achieved at  $s = \alpha$ . By [Theorem 8](#), the integral in [Equation \(195\)](#) dot equals

$$\exp\left(-n\left[\frac{\alpha^2}{2} - L \ln \alpha - \frac{1}{2} + (L-1) \ln \alpha\right]\right) = \exp\left(-n\left[\frac{\alpha^2}{2} - \ln \alpha - \frac{1}{2}\right]\right). \quad (196)$$

If  $\alpha > \sqrt{L}$ , the minimum value of  $F(s)$  in  $[0, \alpha]$  is achieved at  $s = \sqrt{L}$ . By [Theorem 8](#), the integral in [Equation \(195\)](#) dot equals

$$\exp\left(-n\left[\frac{L}{2} - \frac{L}{2} \ln L - \frac{1}{2} + (L-1) \ln \alpha\right]\right) = \exp\left(-n\left[\frac{L-1}{2} - \frac{L}{2} \ln L + (L-1) \ln \alpha\right]\right). \quad (197)$$

Let  $E_1(\alpha, L)$  and  $E_2(\alpha, L)$  be the normalized first-order exponent of the first and second term in [Equation \(192\)](#), respectively, i.e.,

$$E_1(\alpha, L) := -\lim_{n \rightarrow \infty} \frac{1}{n} \ln \left( \lambda^{L-1} V_n^{L-1} \int_0^{r^*} f_{\|\mathbf{g}\|_2}(r) r^{n(L-1)} dr \right),$$

$$E_2(\alpha, L) := -\lim_{n \rightarrow \infty} \frac{1}{n} \ln \Pr[\|\mathbf{g}\|_2 > r^*].$$

By [Equations \(196\) and \(197\)](#),  $E_1(\alpha, L)$  is given by

$$E_1(\alpha, L) = \begin{cases} \frac{\alpha^2}{2} - \ln \alpha - \frac{1}{2}, & \alpha \leq \sqrt{L} \\ \frac{L-1}{2} - \frac{L}{2} \ln L + (L-1) \ln \alpha, & \alpha > \sqrt{L} \end{cases}.$$

Let  $C := \frac{1}{2} \ln \frac{1}{2\pi e \sigma^2}$ . Note that  $R = \frac{1}{2} \ln \frac{1}{2\pi e \sigma^2 \alpha^2} = C - \ln \alpha$ . The exponent  $E_2(\alpha, L)$  is the large deviation exponent of the tail of a chi-square random variable which is given by [Lemma 25](#). In fact, it was shown in [[IZF12](#), Eqn. (29)] and [[Pol94](#)] that, under the choice of  $r^*$  given by [Equation \(191\)](#), we have

$$E_2(\alpha, L) = \frac{1}{2} \left[ e^{2(C-R)} - 1 - 2(C-R) \right] = \frac{1}{2} \left( e^{2 \ln \alpha} - 1 - 2 \ln \alpha \right) = \frac{1}{2} (\alpha^2 - 1 - 2 \ln \alpha) = \frac{\alpha^2}{2} - \ln \alpha - \frac{1}{2}.$$

Note that  $E_2(\alpha, L)$  coincides with  $E_1(\alpha, L)$  for  $1 \leq \alpha \leq \sqrt{L}$  whereas it strictly dominates  $E_1(\alpha, L)$  when  $\alpha > \sqrt{L}$ . Finally,

$$\begin{aligned} -\lim_{n \rightarrow \infty} \frac{1}{n} \ln \mathbb{E}_C [\Pr[\mathcal{E}_{L-1}^{\text{ML}}(\mathcal{C}) | \mathcal{C}]] &\geq -\lim_{n \rightarrow \infty} \frac{1}{n} \ln \text{Equation (192)} \\ &\geq \min\{E_1(\alpha, L), E_2(\alpha, L)\} \\ &= \begin{cases} \frac{\alpha^2}{2} - \ln \alpha - \frac{1}{2}, & 1 \leq \alpha \leq \sqrt{L} \\ \frac{L-1}{2} - \frac{L}{2} \ln L + (L-1) \ln \alpha, & \alpha > \sqrt{L} \end{cases}. \quad \square \end{aligned}$$

### B. Expurgated exponent

The bound on error exponent proved in the last section ([Section XVIII-A](#)) can be improved using the expurgation technique when the rate is sufficiently low. In this section, we prove the following theorem.

**Theorem 62.** For any  $\sigma > 0, \alpha \geq 1$  and  $L \in \mathbb{Z}_{\geq 2}$ , there exists an unbounded code  $\mathcal{C} \subset \mathbb{R}^n$  of rate  $R = \frac{1}{2} \ln \frac{1}{2\pi e \sigma^2 \alpha^2}$  such that when used over an AWGN channel with noise variance  $\sigma^2$  and no input constraint, the exponent of the average probability of  $(L-1)$ -list-decoding error of  $\mathcal{C}$  (normalized by  $\lim_{n \rightarrow \infty} -\frac{1}{n} \ln(\cdot)$ ) is at least  $E_{\text{ex}, L-1}(\alpha)$  defined as

$$E_{\text{ex}, L-1}(\alpha) = \begin{cases} \frac{\alpha^2}{2} - \ln \alpha - \frac{1}{2}, & 1 \leq \alpha \leq \sqrt{L} \\ \frac{L-1}{2} - \frac{L}{2} \ln L + (L-1) \ln \alpha, & \sqrt{L} < \alpha \leq \sqrt{2L}, \\ F(\alpha, L), & \alpha > \sqrt{2L} \end{cases}, \quad (198)$$

where

$$F(\alpha, L) := \frac{\alpha^2}{16} + \frac{1}{16} \sqrt{\alpha^4 + 8\alpha^2(2L-3) + 16} - \frac{L-1}{2} \ln \left( \sqrt{\alpha^4 + 8\alpha^2(2L-3) + 16} - \alpha^2 + 4 \right)$$

$$+ \frac{L-2}{2} \ln\left(\sqrt{\alpha^4 + 8\alpha^2(2L-3) + 16} + \alpha^2 + 4\right) + \frac{3}{2} \ln 2 - \frac{1}{4}.$$

*Proof.* Let  $\alpha \geq 1$  and  $R = \frac{1}{2} \ln \frac{1}{2\pi e \sigma^2 \alpha^2}$ . Let  $\mathcal{C} \subset \mathbb{R}^n$  be a Matérn process obtained from a PPP with intensity  $\lambda = e^{nR} = (2\pi e \sigma^2 \alpha^2)^{-n/2}$  and exclusion radius  $\xi := \tilde{\alpha} \sigma \sqrt{n}$  where  $\tilde{\alpha} := \alpha(1 - \varepsilon_n)$  for a proper choice of  $\varepsilon_n \xrightarrow{n \rightarrow \infty} 0$  to be specified momentarily. The intensity  $\lambda'$  of the Matérn process is

$$\begin{aligned} \lambda' &= \lambda \exp(-\lambda |\mathcal{B}^n(\xi)|) \\ &= \lambda \exp(-\lambda V_n(\alpha(1 - \varepsilon_n) \sigma \sqrt{n})^n) \\ &\asymp \lambda \exp\left(- (2\pi e \sigma^2 \alpha^2)^{-n/2} \frac{1}{\sqrt{\pi n}} \left(\frac{2\pi e}{n}\right)^{n/2} (\alpha^2(1 - \varepsilon_n)^2 \sigma^2 n)^{n/2}\right) \\ &= \lambda \exp\left(-\frac{(1 - \varepsilon_n)^n}{\sqrt{\pi n}}\right). \end{aligned}$$

Taking  $\varepsilon_n = \frac{\ln n}{n} = o(1)$ , we have

$$\lambda' \asymp \lambda \exp\left(-\frac{e^{-\ln n}}{\sqrt{\pi n}}\right) = \lambda \exp\left(-\pi^{-1/2} n^{-3/2}\right) \asymp \lambda.$$

In the following analysis, we will ignore the  $o(1)$  factor  $\varepsilon_n$  and assume for simplicity  $\tilde{\alpha} = \alpha$ .

Suppose  $\underline{0} \in \mathcal{C}$ . Under the Palm distribution, the order- $(L-1)$  factorial moment measure  $\lambda'(\underline{x}_1, \dots, \underline{x}_{L-1})$  of  $\mathcal{C}$  can be bounded as follows

$$\lambda'(\underline{x}_1, \dots, \underline{x}_{L-1}) \leq \lambda^{L-1} \prod_{i=1}^{L-1} \mathbf{1}\{\underline{x}_i \in \mathcal{B}^n(\xi)^c\}. \quad (199)$$

Following similar arguments to those in [Section XVIII-A](#), we have

$$\Pr[\mathcal{E}_{L-1}^{\text{ML}}(\mathcal{C})] = \int_0^\infty f_{\|\underline{\mathbf{g}}\|_2}(r) \Pr[\mathcal{E}_{L-1}^{\text{ML}}(\mathcal{C}) \mid \|\underline{\mathbf{g}}\|_2 = r] dr.$$

The above identity holds for any instantiated  $\mathcal{C} \subset \mathbb{R}^n$  and the randomness in the probability comes from the channel noise  $\underline{\mathbf{g}}$ . Averaging the RHS of the above equation over the Matérn process  $\mathcal{C}$ , we have

$$\begin{aligned} &\mathbb{E}_{\mathcal{C}}^{\text{Palm}} \left[ \int_0^\infty f_{\|\underline{\mathbf{g}}\|_2}(r) \Pr_{\underline{\mathbf{g}}}[\mathcal{E}_{L-1}^{\text{ML}}(\mathcal{C}) \mid \|\underline{\mathbf{g}}\|_2 = r] dr \right] \\ &\leq \int_{\mathbb{R}^{n(L-1)}} \left( \int_0^\infty f_{\|\underline{\mathbf{g}}\|_2}(r) \Pr_{\underline{\mathbf{g}}}[\forall i \in [L-1], \underline{x}_i \in \text{int}(\mathcal{B}^n(\underline{\mathbf{g}}, r)) \mid \|\underline{\mathbf{g}}\|_2 = r] dr \right) \lambda^{L-1} \prod_{i=1}^{L-1} \mathbf{1}\{\underline{x}_i \in \mathcal{B}^n(\xi)^c\} d(\underline{x}_1, \dots, \underline{x}_{L-1}) \end{aligned} \quad (200)$$

$$\begin{aligned} &= \int_0^\infty f_{\|\underline{\mathbf{g}}\|_2}(r) \lambda^{L-1} \int_{\mathbb{R}^{n(L-1)}} \mathbb{E}_{\underline{\mathbf{g}}} \left[ \prod_{i=1}^{L-1} \mathbf{1}\{\underline{x}_i \in \text{int}(\mathcal{B}^n(\underline{\mathbf{g}}, r))\} \mid \|\underline{\mathbf{g}}\|_2 = r \right] \prod_{i=1}^{L-1} \mathbf{1}\{\underline{x}_i \in \mathcal{B}^n(\xi)^c\} d(\underline{x}_1, \dots, \underline{x}_{L-1}) dr \\ &= \int_0^\infty f_{\|\underline{\mathbf{g}}\|_2}(r) \lambda^{L-1} \int_{\mathbb{R}^{n(L-1)}} \mathbb{E}_{\underline{\mathbf{g}}} \left[ \prod_{i=1}^{L-1} \mathbf{1}\{\underline{x}_i \in \text{int}(\mathcal{B}^n(\underline{\mathbf{g}}, r))\} \mathbf{1}\{\underline{x}_i \in \mathcal{B}^n(\xi)^c\} \mid \|\underline{\mathbf{g}}\|_2 = r \right] d(\underline{x}_1, \dots, \underline{x}_{L-1}) dr \\ &= \int_0^\infty f_{\|\underline{\mathbf{g}}\|_2}(r) \lambda^{L-1} \mathbb{E}_{\underline{\mathbf{g}}} \left[ \prod_{i=1}^{L-1} \int_{\mathbb{R}^n} \mathbf{1}\{\underline{x}_i \in \text{int}(\mathcal{B}^n(\underline{\mathbf{g}}, r)) \cap \mathcal{B}^n(\xi)^c\} d\underline{x}_i \mid \|\underline{\mathbf{g}}\|_2 = r \right] dr \end{aligned} \quad (201)$$

$$= \int_0^\infty f_{\|\underline{\mathbf{g}}\|_2}(r) \lambda^{L-1} |\mathcal{B}^n(r\underline{e}, r) \cap \mathcal{B}^n(\xi)^c|^{L-1} dr, \quad (202)$$

where  $\underline{e} = [1, 0, \dots, 0] \in \mathbb{R}^n$ . In [Inequality \(200\)](#), we skipped several steps which are similar to [Equation \(187\)](#), [Inequality \(188\)](#) and [Equation \(189\)](#). In particular, we used Slivnyak's theorem ([Theorem 18](#)), the first bound of the minimum in [Equation \(185\)](#), Campbell's theorem ([Theorem 17](#)) and the bound on the (Palm) intensity of Matérn processes ([Inequality \(199\)](#)). In [Equation \(202\)](#), we take the direction of  $\underline{\mathbf{g}}$  to be  $\underline{e}$  since the integral in [Equation \(201\)](#) does not depend on the direction of  $\underline{\mathbf{g}}$ .

Incorporating the second term of the minimum in [Equation \(185\)](#), we get

$$\mathbb{E}_{\mathcal{C}} \left[ \int_0^\infty f_{\|\underline{\mathbf{g}}\|_2}(r) \Pr_{\underline{\mathbf{g}}} \left[ \mathcal{E}_{L-1}^{\text{ML}}(\mathcal{C}) \mid \|\underline{\mathbf{g}}\|_2 = r \right] dr \right] \leq \int_0^\infty f_{\|\underline{\mathbf{g}}\|_2}(r) \min \left\{ \lambda^{L-1} |\mathcal{B}^n(r\underline{\mathbf{e}}, r) \cap \mathcal{B}^n(\xi)^c|^{L-1}, 1 \right\} dr.$$

We apply the relation [Equation \(193\)](#), change variable  $s = \frac{r}{\sigma\sqrt{n}}$  and get

$$\begin{aligned} \mathbb{E}_{\mathcal{C}} [\Pr[\mathcal{E}_{L-1}^{\text{ML}}(\mathcal{C})|\mathcal{C}]] &\leq \int_0^\infty \sigma^{-1} f(r/\sigma) \min \left\{ \lambda^{L-1} |\mathcal{B}^n(r\underline{\mathbf{e}}, r) \cap \mathcal{B}^n(\xi)^c|^{L-1}, 1 \right\} dr \\ &= \int_0^\infty \sigma^{-1} f(s\sqrt{n}) \min \left\{ \lambda^{L-1} |\mathcal{B}^n(r\underline{\mathbf{e}}, r) \cap \mathcal{B}^n(\xi)^c|^{L-1}, 1 \right\} \sigma\sqrt{n} ds \\ &\doteq \int_0^\infty f(s\sqrt{n}) \min \left\{ \lambda^{L-1} |\mathcal{B}^n(r\underline{\mathbf{e}}, r) \cap \mathcal{B}^n(\alpha\sigma\sqrt{n})^c|^{L-1}, 1 \right\} ds. \end{aligned} \quad (203)$$

The following upper bound on  $|\mathcal{B}^n(r\underline{\mathbf{e}}, r) \cap \mathcal{B}^n(\alpha\sigma\sqrt{n})^c|$  was shown in [\[AB10, Eqn. \(106\)\]](#).

**Lemma 63** ([\[AB10\]](#)). *Let  $\underline{\mathbf{e}} = [1, 0, \dots, 0] \in \mathbb{R}^n$ ,  $\alpha \geq 1$ ,  $\sigma > 0$ . Then for any  $r > 0$ ,*

$$|\mathcal{B}^n(r\underline{\mathbf{e}}, r) \cap \mathcal{B}^n(\alpha\sigma\sqrt{n})^c| \leq |\mathcal{B}^n(c(s)\sigma\sqrt{n})| = V_n(c(s)\sigma\sqrt{n})^n,$$

where

$$c(s) = \begin{cases} 0, & 0 < s \leq \alpha/2 \\ \sqrt{s^2 - \left(s - \frac{\alpha^2}{2s}\right)^2}, & \alpha/2 < s \leq \alpha/\sqrt{2} \\ s, & s > \alpha/\sqrt{2} \end{cases}$$

Using [Lemma 63](#), continuing with [Equation \(203\)](#), we have

$$\begin{aligned} \mathbb{E}_{\mathcal{C}} [\Pr[\mathcal{E}_{L-1}^{\text{ML}}(\mathcal{C})|\mathcal{C}]] &\leq \int_0^\infty f(s\sqrt{n}) \min \left\{ \lambda^{L-1} V_n^{L-1}(c(s)\sigma\sqrt{n})^{n(L-1)}, 1 \right\} ds \\ &\doteq \int_0^\infty f(s\sqrt{n}) \min \left\{ (2\pi e \sigma^2 \alpha^2)^{-\frac{1}{2}n(L-1)} (2\pi e n^{-1})^{\frac{1}{2}n(L-1)} (c(s)^2 \sigma^2 n)^{\frac{1}{2}n(L-1)}, 1 \right\} ds \\ &= \int_0^\infty f(s\sqrt{n}) \min \left\{ \alpha^{-n(L-1)} c(s)^{n(L-1)}, 1 \right\} ds \\ &\leq \int_0^\infty \exp \left( -n \left\{ \frac{s^2}{2} - \ln s - \frac{1}{2} + (L-1)[\ln \alpha - \ln c(s)]^+ \right\} \right) ds \\ &= \int_0^{\alpha/2} \exp(-nF_1(s)) ds + \int_{\alpha/2}^{\alpha/\sqrt{2}} \exp(-nF_2(s)) ds + \int_{\alpha/\sqrt{2}}^\infty \exp(-nF_3(s)) ds, \end{aligned} \quad (204)$$

where  $F_1(s), F_2(s), F_3(s)$  are defined as follows

$$\begin{aligned} F_1(s) &:= \frac{s^2}{2} - \ln s - \frac{1}{2} + (L-1)(\ln \alpha - \ln 0) = \infty, \quad 0 \leq s \leq \alpha/2; \\ F_2(s) &:= \frac{s^2}{2} - \ln s - \frac{1}{2} + (L-1) \left[ \ln \alpha - \frac{1}{2} \ln \left( s^2 - \left( s - \frac{\alpha^2}{2s} \right)^2 \right) \right]^+ \\ &= \frac{s^2}{2} - \ln s - \frac{1}{2} + (L-1) \left[ \ln \alpha - \frac{1}{2} \ln \left( s^2 - \left( s - \frac{\alpha^2}{2s} \right)^2 \right) \right], \quad \alpha/2 < s \leq \alpha/\sqrt{2}; \\ F_3(s) &:= \frac{s^2}{2} - \ln s - \frac{1}{2} + (L-1)[\ln \alpha - \ln s]^+ \\ &= \begin{cases} \frac{s^2}{2} - \ln s - \frac{1}{2} + (L-1)(\ln \alpha - \ln s), & \alpha/\sqrt{2} < s \leq \alpha \\ \frac{s^2}{2} - \ln s - \frac{1}{2}, & s > \alpha \end{cases}. \end{aligned}$$

For  $F_2(s)$ , we can remove the function  $[\cdot]^+$  since the function  $f_2(s) := \sqrt{s^2 - \left(s - \frac{\alpha^2}{2s}\right)^2}$  attains its maximum value  $\alpha/\sqrt{2}$  at  $s = \alpha/\sqrt{2}$ . Therefore  $\ln \alpha - \ln f_2(s) \geq \ln \sqrt{2} > 0$ .



Define

$$\begin{aligned} E_1(\alpha, L) &:= -\lim_{n \rightarrow \infty} \frac{1}{n} \ln \int_0^{\alpha/2} \exp(-nF_1(s)) ds, \\ E_2(\alpha, L) &:= -\lim_{n \rightarrow \infty} \frac{1}{n} \ln \int_{\alpha/2}^{\alpha/\sqrt{2}} \exp(-nF_2(s)) ds, \\ E_3(\alpha, L) &:= -\lim_{n \rightarrow \infty} \frac{1}{n} \ln \int_{\alpha/\sqrt{2}}^{\infty} \exp(-nF_3(s)) ds. \end{aligned}$$

We compute  $E_1(\alpha, L), E_2(\alpha, L), E_3(\alpha, L)$  using Laplace's method ([Theorem 8](#)). For  $E_1(\alpha, L)$ , we have

$$E_1(\alpha, L) = \min_{s \in [0, \alpha/2]} F_1(s) = \infty.$$

For  $E_2(\sigma, L)$ ,  $F_2(s)$  has a unique stationary point

$$s_0 = \sqrt{\frac{\alpha^2 + \sqrt{\alpha^4 + 8\alpha^2(2L-3) + 16} + 4}{8}}.$$

One can check that  $s_0 \geq \sqrt{2}/\alpha$  if  $\alpha \leq \sqrt{2L}$  and  $s_0 < \sqrt{2}/\alpha$  if  $\alpha > \sqrt{2L}$ . Therefore

$$E_2(\alpha, L) = \min_{s \in (\alpha/2, \alpha/\sqrt{2}]} F_2(s) = \begin{cases} F_2(\sqrt{2}/\alpha), & \alpha \leq \sqrt{2L} \\ F_2(s_0), & \alpha > \sqrt{2L} \end{cases},$$

where

$$\begin{aligned} F_2(\sqrt{2}/\alpha) &= \frac{\alpha^2}{4} + \ln \alpha + \frac{L}{2} \ln 2 - \frac{1}{2}, \\ F_2(s_0) &= \frac{\alpha^2}{16} + \frac{1}{16} \sqrt{\alpha^4 + 8\alpha^2(2L-3) + 16} - \frac{L-1}{2} \ln(\sqrt{\alpha^4 + 8\alpha^2(2L-3) + 16} - \alpha^2 + 4) \\ &\quad + \frac{L-2}{2} \ln(\sqrt{\alpha^4 + 8\alpha^2(2L-3) + 16} + \alpha^2 + 4) + \frac{3}{2} \ln 2 - \frac{1}{4}. \end{aligned} \quad (205)$$

For  $E_3(\alpha, L)$ , we let

$$F_{3,1}(s) := \frac{s^2}{2} - \ln s - \frac{1}{2} + (L-1)(\ln \alpha - \ln s), \quad F_{3,2}(s) := \frac{s^2}{2} - \ln s - \frac{1}{2}.$$

The function  $F_{3,1}(s)$  has a unique minimum point  $s = \sqrt{L}$ . Therefore, for  $s \in (\alpha/\sqrt{2}, \alpha]$ , the minimum value of  $F_{3,1}(s)$  is

$$\min_{s \in (\alpha/\sqrt{2}, \alpha]} F_{3,1}(s) = \begin{cases} F_{3,1}(\alpha) = \frac{\alpha^2}{2} - \ln \alpha - \frac{1}{2}, & 1 \leq \alpha \leq \sqrt{L} \\ F_{3,1}(\sqrt{L}) = \frac{L-1}{2} - \frac{L}{2} \ln L + (L-1) \ln \alpha, & \sqrt{L} < \alpha \leq \sqrt{2L} \\ F_{3,1}(\alpha/\sqrt{2}) = \frac{\alpha^2}{4} - \ln \alpha + \frac{L}{2} \ln 2 - \frac{1}{2}, & \alpha > \sqrt{2L} \end{cases}. \quad (206)$$

The function  $F_{3,2}(s)$  has a unique minimum point  $s = 1 \leq \alpha$ . Therefore, for  $s \in (\alpha, \infty)$ , the minimum value of  $F_{3,2}(s)$  is

$$\min_{s \in (\alpha, \infty)} F_{3,2}(s) = F_{3,2}(1) = \frac{\alpha^2}{2} - \ln \alpha - \frac{1}{2}. \quad (207)$$

One can easily check that [Equation \(207\)](#) is at least [Equation \(206\)](#) for any  $\alpha \geq 1$ . Therefore,

$$E_3(\alpha, L) = \min_{s \in (\alpha/\sqrt{2}, \infty)} F_3(s) = \min \left\{ \min_{s \in (\alpha/\sqrt{2}, \alpha]} F_{3,1}(s), \min_{s \in (\alpha, \infty)} F_{3,2}(s) \right\} = \min_{s \in (\alpha/\sqrt{2}, \alpha]} F_{3,1}(s).$$

Finally,

$$-\lim_{n \rightarrow \infty} \frac{1}{n} \ln \mathbb{E}_{\mathcal{C}} [\Pr[\mathcal{E}_{L-1}^{\text{ML}}(\mathcal{C}) | \mathcal{C}]] \geq -\lim_{n \rightarrow \infty} \frac{1}{n} \ln \text{Equation (204)}$$

$$\begin{aligned}
&\geq \min\{E_1(\alpha, L), E_2(\alpha, L), E_3(\alpha, L)\} \\
&= \min\{E_2(\alpha, L), E_3(\alpha, L)\} \\
&= \begin{cases} \min\{F_2(\alpha/\sqrt{2}), F_{3,1}(\alpha)\}, & 1 \leq \alpha \leq \sqrt{L} \\ \min\{F_2(\alpha/\sqrt{2}), F_{3,1}(\sqrt{L})\}, & \sqrt{L} < \alpha \leq \sqrt{2L} \\ \min\{F_2(s_0), F_{3,1}(\alpha/\sqrt{2})\}, & \alpha > \sqrt{2L} \end{cases} \\
&= \begin{cases} F_{3,1}(\alpha), & 1 \leq \alpha \leq \sqrt{L} \\ F_{3,1}(\sqrt{L}), & \sqrt{L} < \alpha \leq \sqrt{2L} \\ F_2(s_0), & \alpha > \sqrt{2L} \end{cases} \\
&= \begin{cases} \frac{\alpha^2}{2} - \ln \alpha - \frac{1}{2}, & 1 \leq \alpha \leq \sqrt{L} \\ \frac{L-1}{2} - \frac{L}{2} \ln L + (L-1) \ln \alpha, & \sqrt{L} < \alpha \leq \sqrt{2L} \\ F_2(s_0), & \alpha > \sqrt{2L} \end{cases}.
\end{aligned}$$

Recall that the quantity  $F_2(s_0)$  was defined in Equation (205). This finishes the proof.  $\square$

### C. List-decoding error exponents vs. unique-decoding error exponents

Our results on list-decoding error exponents of AWGN channels without input constraints recover those by Poltyrev [Pol94, Theorem 3] for unique-decoding<sup>8</sup>. Indeed, when  $L = 2$ , Equation (198) specializes to

$$E_{\text{ex},L-1}(\alpha) = \begin{cases} \frac{\alpha^2}{2} - \ln \alpha - \frac{1}{2}, & 1 \leq \alpha \leq \sqrt{2} \\ \frac{1}{2} - \ln 2 + \ln \alpha, & \sqrt{2} \leq \alpha \leq 2 \\ \frac{\alpha^2}{8}, & \alpha > 2 \end{cases}. \quad (208)$$

The situation here is similar to the bounded case as discussed in Section XVII-G. List-decoding for input unconstrained AWGN channels does not increase the capacity and moreover does not increase the error exponent for any  $1 \leq \alpha \leq \sqrt{2}$ . However, for any  $\alpha > \sqrt{2}$ , list-decoding does increase the error exponent. Furthermore, the critical values of  $\alpha$  move from  $\sqrt{2}$  and 2 to  $\sqrt{L}$  and  $\sqrt{2L}$ , respectively, under list-decoding.

We plot Poltyrev's exponents and our exponents (for  $L = 3$ ) in Figure 12.

## XIX. OPEN QUESTIONS

We end the paper with several intriguing open questions.

- 1) The problem of packing spheres in  $\ell_p$  space was also addressed in the literature [Ran55], [Spe70], [Bal87], [Sam13]. Recently, there was an exponential improvement on the optimal packing density in  $\ell_p$  space [SSZ20] relying on the Kabatiansky–Levenshtein bound [KL78]. It is worth exploring the  $\ell_p$  version of the multiple packing problem. One obstacle here is that the  $\ell_p$  average radius does not admit a closed form expression as in the  $p = 2$  case.
- 2) We examined the performance of multiple packings obtained from the Gaussian distribution (Section X), the uniform distribution on a sphere (Section XI) and the uniform distribution in a ball (Section XI-C), respectively. It turns out that these distributions are special cases of the  $n$ -dimensional beta distribution  $\text{Beta}_n(\beta)$  when  $\beta = \infty, -1, 0$ , respectively. If one can prove a Khinchin's inequality for beta distribution with sharp constants, then it allows us to unify our proofs for three distributions and potentially strengthen our bounds for spherical codes and ball codes. Also, Khinchin's inequality for beta distribution is of independent interest for probabilists.
- 3) In this paper, we treat (regular) list-decoding and average-radius list-decoding as two different notions and obtain bounds for both. It follows from our bounds that in the *unbounded* case, the largest multiple packing density under these two notions coincide as  $L \rightarrow \infty$ . However, as far as we know, it is unknown whether in the *bounded* case, the largest multiple packing density under standard and average-radius list-decoding is the same in the large  $L$  limit. Indeed, we do not have a pair of lower and upper bounds for both notions that converge to the same limiting value. Moreover, the same question is open for any finite  $L$ , even in the unbounded case and of course in the bounded case.

<sup>8</sup>See also [AB10, Eqn. (108)] for a parameterization of Poltyrev's bound using  $\alpha$ .

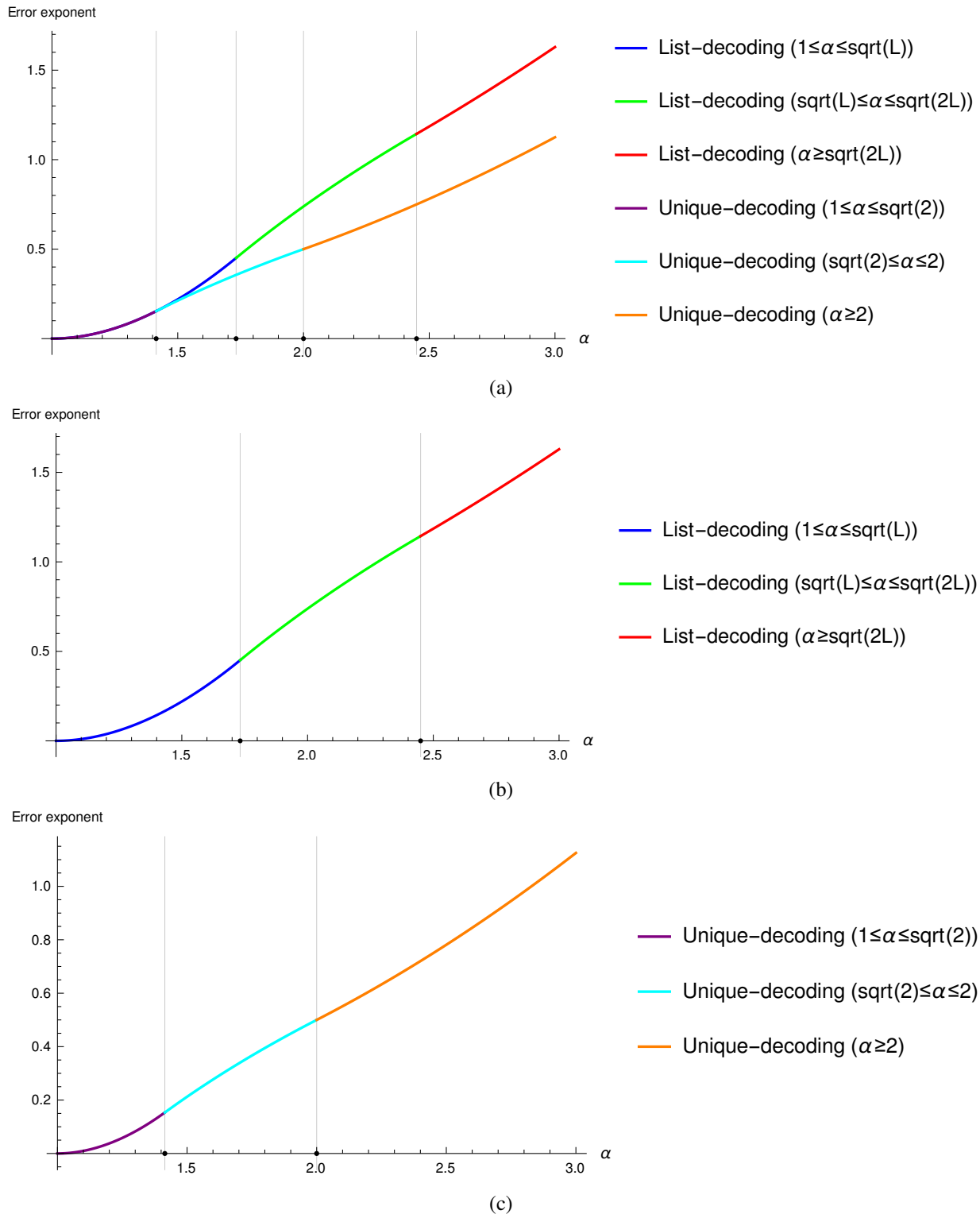

Fig. 12: Comparison of Poltyrev's unique-decoding error exponents (Equation (208)) and our list-decoding error exponents (Equation (198)) for input unconstrained AWGN channels with noise variance  $\sigma^2$ . We plot our bounds for  $L = 3$ . The horizontal axis is  $\alpha \geq 1$  which parameterizes the rate  $R$  through the relation  $R = \frac{1}{2} \ln \frac{1}{2\pi e \sigma^2 \alpha^2}$ . The vertical axis is the values of various exponents. The list-decoding error exponents and the unique-decoding error exponents are plotted jointly in Figure 12a and are plotted separately in Figures 12b and 12c, respectively. We observe that list-decoding does not increase the error exponent for any  $1 \leq \alpha \leq \sqrt{2}$ . However, for any  $\alpha > \sqrt{2}$ , list-decoding does increase the error exponent. Moreover, the critical values of  $\alpha$  move from  $\sqrt{2}$  and 2 to  $\sqrt{L}$  and  $\sqrt{2L}$ , respectively, under  $(L - 1)$ -list-decoding.

- 4) For the regular notion of list-decoding, our best lower bound is proved via a peculiar connection with error exponents. We do not know how to directly analyze the tail probability of the Chebyshev radius, even for Gaussian codes. One can view it as the tail of the maximum of a certain Gaussian process. This looks like a proper venue where the chaining method [VH14] is applicable. However, it seems unlikely that one can extract a meaning exponent using the generic chaining machinery. Note that for the purpose of maximizing the rate, we do care about the exact exponent, not only an exponentially decaying bound.

## XX. ACKNOWLEDGEMENT

YZ thanks Tomasz Tkocz for discussions on Khinchin’s inequality with sharp constants for sums and quadratic forms. He thanks Jiajin Li for making the observation given by Equation (39). He also would like to thank Nir Ailon and Ely Porat for several helpful conversations throughout this project.

YZ has received funding from the European Union’s Horizon 2020 research and innovation programme under grant agreement No 682203-ERC-[Inf-Speed-Tradeoff]. The work of SV was supported by a seed grant from IIT Hyderabad and the start-up research grant from the Science and Engineering Research Board, India (SRG/2020/000910).

*YZ dedicates this work to the memory of the grandmother of Jasmine Yao.*

## REFERENCES

- [AB08] Rudolf Ahlswede and Vladimir Blinovsky. *Lectures on advances in combinatorics*. Springer, 2008. **II**
- [AB10] Venkat Anantharam and François Baccelli. Information-theoretic capacity and error exponents of stationary point processes under random additive displacements. *arXiv preprint arXiv:1012.4924*, 2010. **IV, XVIII-A, 61, XVIII-B, 63, 8**
- [ABL00] Alexei Ashikhmin, Alexander Barg, and Simon Litsyn. A new upper bound on codes decodable into size-2 lists. In *Numbers, Information and Complexity*, pages 239–244. Springer, 2000. **II**
- [ABP18] Noga Alon, Boris Bukh, and Yury Polyanskiy. List-decodable zero-rate codes. *IEEE Transactions on Information Theory*, 65(3):1657–1667, 2018. **IV**
- [BADTS20] Avraham Ben-Aroya, Dean Doron, and Amnon Ta-Shma. Near-optimal erasure list-decodable codes. In *35th Computational Complexity Conference (CCC 2020)*. Schloss Dagstuhl-Leibniz-Zentrum für Informatik, 2020. **II**
- [Bal87] Keith Ball. Inequalities and sphere-packing in  $p$ . *Israel Journal of Mathematics*, 58(2):243–256, 1987. **I**
- [Bas65] L. A. Bassalygo. New upper bounds for error-correcting codes. *Probl. of Info. Transm.*, 1:32–35, 1965. **I, XV**
- [BF63] NM Blachman and L Few. Multiple packing of spherical caps. *Mathematika*, 10(1):84–88, 1963. **I, III, III, V, XIII**
- [BHL08] Yael Ben-Haim and Simon Litsyn. Improved upper bounds on the reliability function of the gaussian channel. *IEEE Transactions on Information Theory*, 54(1):5–12, 2008. **I**
- [BL11] Vladimir Blinovsky and Simon Litsyn. New asymptotic bounds on the size of multiple packings of the euclidean sphere. *Discrete & Computational Geometry*, 46(4):626–635, 2011. **I, IV**
- [Bla62] N. Blachman. On the capacity of bandlimited channel perturbed by statistically dependent interference. *IRE Transactions on Information Theory*, 8:48–55, 1962. **I, XIII, 33**
- [Bli86] Vladimir M Blinovsky. Bounds for codes in the case of list decoding of finite volume. *Problems of Information Transmission*, 22:7–19, 1986. **II, XV-A**
- [Bli99] V Blinovsky. Multiple packing of the euclidean sphere. *IEEE Transactions on Information Theory*, 45(4):1334–1337, 1999. **(document), I, III, IV, XIV-D, XIV-D, XIV-D, XIV-D, XIV-D, XIV-D, XIV-D, XIV-D, XIV-D**
- [Bli05a] Vladimir M Blinovsky. Code bounds for multiple packings over a nonbinary finite alphabet. *Problems of Information Transmission*, 41:23–32, 2005. **II**
- [Bli05b] Vladimir M Blinovsky. Random sphere packing. *Problems of Information Transmission*, 41(4):319–330, 2005. **(document), I, III, IV, XII-E, XII-E, XII-E, XII-E, XII-E, XII-E, XII-E**
- [Bli08] Vladimir M Blinovsky. On the convexity of one coding-theory function. *Problems of Information Transmission*, 44:34–39, 2008. **II**
- [Bli12] Volodia Blinovsky. *Asymptotic combinatorial coding theory*, volume 415. Springer Science & Business Media, 2012. **II, XV-A**
- [Bob10] Sergey G Bobkov. On concentration of measure on the cube. *Journal of Mathematical Sciences*, 165(1):60–70, 2010. **2**
- [CKM<sup>+</sup>17] Henry Cohn, Abhinav Kumar, Stephen D Miller, Danylo Radchenko, and Maryna Viazovska. The sphere packing problem in dimension 24. *Annals of Mathematics*, pages 1017–1033, 2017. **II**
- [CZ14] Henry Cohn and Yufei Zhao. Sphere packing bounds via spherical codes. *Duke Mathematical Journal*, 163(10):1965–2002, 2014. **5**
- [Del73] Philippe Delsarte. An algebraic approach to the association schemes of coding theory. *Philips Res. Rep. Suppl.*, 10:vi+–97, 1973. **I, II**
- [Eli57] Peter Elias. List decoding for noisy channels. 1957. **I**
- [Few64] L Few. Multiple packing of spheres. *Journal of the London Mathematical Society*, 1(1):51–54, 1964. **XIII**
- [Gal65] R Gallager. A simple derivation of the coding theorem and some applications. *IEEE Transactions on Information Theory*, 11(1):3–18, 1965. **IV, XVII, XVII-G**
- [Gal68] Robert G. Gallager. *Information Theory and Reliable Communication*. MIT Press, 1968. **IV, XVII, XVII-E, XVII-G**

- [GHS20] Venkatesan Guruswami, Bernhard Haeupler, and Amirbehshad Shahrasbi. Optimally resilient codes for list-decoding from insertions and deletions. In *Proceedings of the 52nd Annual ACM SIGACT Symposium on Theory of Computing*, pages 524–537, 2020. **II**
- [Gil52] Edgar N Gilbert. A comparison of signalling alphabets. *The Bell system technical journal*, 31(3):504–522, 1952. **II**
- [Gop77] Valerii Denisovich Goppa. Codes associated with divisors. *Problemy Peredachi Informatsii*, 13(1):33–39, 1977. **II**
- [GP12] Elena Grigorescu and Chris Peikert. List decoding barnes-wall lattices. In *2012 IEEE 27th Conference on Computational Complexity*, pages 316–325. IEEE, 2012. **I**
- [Gur06] V Guruswami. List decoding from erasures: bounds and code constructions. *IEEE Transactions on Information Theory*, 49(11):2826–2833, 2006. **II**
- [HAB<sup>+</sup>17] Thomas Hales, Mark Adams, Gertrud Bauer, Tat Dat Dang, John Harrison, Hoang Le Truong, Cezary Kaliszyk, Victor Magron, Sean McLaughlin, Tat Thang Nguyen, et al. A formal proof of the kepler conjecture. In *Forum of mathematics, Pi*, volume 5. Cambridge University Press, 2017. **II**
- [Hal98] Thomas C Hales. The kepler conjecture. *arXiv preprint math.MG/9811078*, 1998. **II**
- [Hug97] Brian L. Hughes. The smallest list for the arbitrarily varying channel. *IEEE Transactions on Information Theory*, 43(3):803–815, 1997. **II**
- [IZF12] Amir Ingber, Ram Zamir, and Meir Feder. Finite-dimensional infinite constellations. *IEEE transactions on information theory*, 59(3):1630–1656, 2012. **IV, XVIII-A**
- [Jos58] DD Joshi. A note on upper bounds for minimum distance codes. 1958. **II**
- [Kep11] Johannes Kepler. Strena seu de nive sexangula (the six-cornered snowflake). *Frankfurt: Gottfried. Tampach*, 1611. **I**
- [KK01] Hermann König and S Kwapien. Best khintchine type inequalities for sums of independent, rotationally invariant random vectors. *Positivity*, 5(2):115–152, 2001. **XI-B, 28, 29, 30**
- [KL78] Grigorii Anatolevich Kabatiansky and Vladimir Iosifovich Levenshtein. On bounds for packings on a sphere and in space. *Problemy Peredachi Informatsii*, 14(1):3–25, 1978. **I, I, II, 21, 1**
- [KL95] Gil Kalai and Nathan Linial. On the distance distribution of codes. *IEEE Transactions on Information Theory*, 41(5):1467–1472, 1995. **II**
- [Kom53] Y Komamiya. Application of logical mathematics to information theory. *Proc. 3rd Japan. Nat. Cong. Appl. Math*, 437, 1953. **II**
- [Lee82] Der-Tsai Lee. On k-nearest neighbor voronoi diagrams in the plane. *IEEE transactions on computers*, 100(6):478–487, 1982. **XIV-A1**
- [Lit99] Simon Litsyn. New upper bounds on error exponents. *IEEE Transactions on Information Theory*, 45(2):385–398, 1999. **II**
- [ML15] Ebrahim MolavianJazi and J Nicholas Laneman. A second-order achievable rate region for gaussian multi-access channels via a central limit theorem for functions. *IEEE Transactions on Information Theory*, 61(12):6719–6733, 2015. **27**
- [MRRW77] Robert McEliece, Eugene Rodemich, Howard Rumsey, and Lloyd Welch. New upper bounds on the rate of a code via the delarte-macwilliams inequalities. *IEEE Transactions on Information Theory*, 23(2):157–166, 1977. **II**
- [Plo60] Morris Plotkin. Binary codes with specified minimum distance. *IRE Transactions on Information Theory*, 6(4):445–450, 1960. **I**
- [Pol94] Gregory Poltyrev. On coding without restrictions for the awgn channel. *IEEE Transactions on Information Theory*, 40(2):409–417, 1994. **IV, XVIII-A, XVIII-C**
- [Pol16] Yury Polyanskiy. Upper bound on list-decoding radius of binary codes. *IEEE Transactions on Information Theory*, 62(3):1119–1128, 2016. **II**
- [PZ21] Nikita Polyanskii and Yihan Zhang. Codes for the z-channel. *arXiv preprint arXiv:2105.01427*, 2021. **II**
- [Ran55] R.A. Rankin. The closest packing of spherical caps in n dimensions. *Proc. Glasgow Math. Assoc.*, 2:139–144, 1955. **1**
- [RS60] Irving S Reed and Gustave Solomon. Polynomial codes over certain finite fields. *Journal of the society for industrial and applied mathematics*, 8(2):300–304, 1960. **II**
- [Sam13] Alex Samorodnitsky. A bound on ll codes. [https://www.cs.huji.ac.il/~salex/papers/L1\\_codes.pdf](https://www.cs.huji.ac.il/~salex/papers/L1_codes.pdf), 2013. **1**
- [SEW13] Charles H Swannack, Uri Erez, and Gregory W Wornell. Geometric relationships between gaussian and modulo-lattice error exponents. *arXiv preprint arXiv:1308.1609*, 2013. **XIV-C**
- [SG12] Anand D Sarwate and Michael Gastpar. List-decoding for the arbitrarily varying channel under state constraints. *IEEE transactions on information theory*, 58(3):1372–1384, 2012. **II**
- [Sha48] Claude E Shannon. A mathematical theory of communication. *The Bell system technical journal*, 27(3):379–423, 1948. **XVII**
- [Sha59] C. E. Shannon. Probability of error for optimal codes in a Gaussian channel. *Bell Syst. Tech. J.*, 38:611–656, May 1959. **XIV-C**
- [Sin64] Richard Singleton. Maximum distance q-nary codes. *IEEE Transactions on Information Theory*, 10(2):116–118, 1964. **II**
- [Spe70] E Spence. Packing of spheres in lp. *Glasgow Mathematical Journal*, 11(1):72–80, 1970. **1**
- [SSSZ20] Ashwin Sah, Mehtaab Sawhney, David Stoner, and Yufei Zhao. Exponential improvements for superball packing upper bounds. *Advances in Mathematics*, 365:107056, 2020. **1**
- [Thu11] Axel Thue. "U about the densest compilation of congruent circles in a plane. Number 1. J. Dybwad, 1911. **II**
- [Tót40] L Fejes Tóth. Über einen geometrischen satz. *Math*, 2(46):79–83, 1940. **II**
- [TVZ82] Michael A Tsfasman, SG Vlăduț, and Th Zink. Modular curves, shimura curves, and goppa codes, better than varshamov-gilbert bound. *Mathematische Nachrichten*, 109(1):21–28, 1982. **II**
- [Var57] Rom Rubenovich Varshamov. Estimate of the number of signals in error correcting codes. *Doklady Akad. Nauk, SSSR*, 117:739–741, 1957. **II**
- [Ver18] Roman Vershynin. *High-dimensional probability: An introduction with applications in data science*, volume 47. Cambridge university press, 2018. **5**
- [VH14] Ramon Van Handel. Probability in high dimension. Technical report, PRINCETON UNIV NJ, 2014. **4**
- [Via17] Maryna S Viazovska. The sphere packing problem in dimension 8. *Annals of Mathematics*, pages 991–1015, 2017. **II**

- [WBBJ19] Xishi Wang, Amitalok J Budkuley, Andrej Bogdanov, and Sidharth Jaggi. When are large codes possible for avcs? In *2019 IEEE International Symposium on Information Theory (ISIT)*, pages 632–636. IEEE, 2019. 47
- [Woz58] John M Wozencraft. List decoding. *Quarterly Progress Report*, 48:90–95, 1958. I
- [ZBJ20] Yihan Zhang, Amitalok J. Budkuley, and Sidharth Jaggi. Generalized List Decoding. In Thomas Vidick, editor, *11th Innovations in Theoretical Computer Science Conference (ITCS 2020)*, volume 151 of *Leibniz International Proceedings in Informatics (LIPIcs)*, pages 51:1–51:83, Dagstuhl, Germany, 2020. Schloss Dagstuhl–Leibniz-Zentrum fuer Informatik. II
- [ZJB20] Yihan Zhang, Sidharth Jaggi, and Amitalok J Budkuley. Tight List-Sizes for Oblivious AVCs under Constraints. *arXiv preprint arXiv:2009.03788*, 2020. II
- [ZV19] Yihan Zhang and Shashank Vatedka. List decoding random euclidean codes and infinite constellations. *arXiv preprint arXiv:1901.03790*, 2019. I, III, VIII-B, XVI, 54
- [ZVJS18] Yihan Zhang, Shashank Vatedka, Sidharth Jaggi, and Anand Sarwate. Quadratically constrained myopic adversarial channels. *arXiv preprint arXiv:1801.05951*, 2018. I, II, III, VIII-B, XVI, 53