

# RANK-ONE STRANGE ATTRACTORS *VERSUS* HETEROCLINIC TANGLES

ALEXANDRE A. P. RODRIGUES  
CENTRO DE MATEMÁTICA DA UNIV. DO PORTO  
RUA DO CAMPO ALEGRE, 687, 4169-007 PORTO, PORTUGAL

**ABSTRACT.** We present a mechanism for the emergence of strange attractors (observable chaos) in a two-parameter periodically-perturbed family of differential equations on the plane. The two parameters are independent and act on different ways in the invariant manifolds of consecutive saddles in the cycle. When both parameters are zero, the flow exhibits an attracting heteroclinic cycle associated to two equilibria. The first parameter makes the two-dimensional invariant manifolds of consecutive saddles in the cycle to pull apart; the second forces transverse intersection. These relative positions may be determined using the Melnikov method.

Extending the previous theory on the field, we prove the existence of many complicated dynamical objects in the two-parameter family, ranging from “large” strange attractors supporting SRB (Sinai-Ruelle-Bowen) measures to superstable sinks and Hénon-type attractors. We draw a plausible bifurcation diagram associated to the problem under consideration and we show that the occurrence of heteroclinic tangles is a *prevalent* phenomenon.

## 1. INTRODUCTION

Periodically perturbed homoclinic cycles have been studied extensively in history. The topic has occupied a center position of the chaos theory since the time of Poincaré [17]. Literature on the mathematical analysis and on numerical simulations is rather abundant. We mention a few that are closely related to this paper: the theory of Smale’s horseshoes [21] and its applications to differential equations through the Melnikov method [11]; the work from Shilnikov’s team [19, 20], those from Chow and Hale’s school [6], concerning chaos and heteroclinic bifurcations in autonomous differential equations and those from Wang, Ott, Oksasoglu and Young concerning rank-one strange attractors [26, 27, 28].

In this paper, we study the dynamics of strange attractors (sustainable chaos) in periodically perturbed differential equations with two heteroclinic connections associated to two dissipative saddles. An explicit formula for the first return map to a cross section is derived. By extending the theory developed for the one loop case in [25, 27], we obtain a generic overview on various admissible dynamical scenarios for the associated non-wandering sets. We state precise hypotheses that imply the existence of observable chaos and sinks for a set of forcing amplitudes with positive Lebesgue measure.

---

*Date:* January 5, 2022.

*2010 Mathematics Subject Classification.* 34C28; 34C37; 37D05; 37D45; 37G35

*Keywords:* Heteroclinic cycle; Heteroclinic bifurcation; Misiurewicz-type map; Rank-one strange attractor; Heteroclinic tangle; Sinks; Prevalence.

AR was partially supported by CMUP, which is financed by national funds through FCT – Fundação para a Ciência e Tecnologia, I.P., under the project with reference UIDB/00144/2020. The author also acknowledges financial support from Program INVESTIGADOR FCT (IF/00107/2015).

Motivated by bifurcation scenarios involving homoclinic cycles [5], we prove the existence of many complicated dynamical objects for a given equation, ranging from an attracting torus of quasi-periodic solutions, Newhouse sinks and Hénon-like attractors, to rank-one strange attractors with Sinai-Ruelle-Bowen (SRB) measures. The theory developed in this paper is explicitly applicable to the analysis of various specific differential equations and the results obtained go beyond the capacity of the classical Birkhoff-Melnikov-Smale method [8].

Our purpose in writing this paper is not only to point out the range of phenomena that can occur when simple non-linear equations are periodically forced, but to bring to the foreground the methods that have allowed us to reach these conclusions in a straightforward manner. These techniques are not limited to the system considered here.

**Structure of the article.** This article is organised as follows: in Section 2 we describe the problem and we refer some related literature on the topic. In Section 3, we state the main results of this research and we explain how they fit in the literature. In Sections 4, 5, we introduce some basic concepts for the understanding of this article and we review the theory of rank-one attractors stated in [27]. The proof of the main results will be performed in Section 7 and 8, after the precise computation of suitable first return maps to cross sections in Section 6.

In Sections 9 and 10 we prove the results related to the heteroclinic tangle. We also show that the existence of heteroclinic tangles is a prevalent phenomenon in a bifurcation diagram in Section 11. In Section 12, we describe explicitly the expressions requested by the Melnikov integral in order to satisfy Hypotheses **(P6)**–**(P7)** of Section 2. We discuss the consequences of our findings in Section 13.

In Appendix A, we list the main notation for constants and terminology in order of appearance. We use the setting of [15, 22] because we are interested in the admissible families that are obtained by passing to the singular limits of families of rank one maps with/without logarithmic singularities.

We have endeavoured to make a self contained exposition bringing together all topics related to the proofs. We have drawn illustrative figures to make the paper easily readable.

## 2. SETTING

**2.1. Starting point.** Let  $(x, y) \in \mathbb{R}^2$  be the phase variables and  $t$  be the independent variable. We start with the following autonomous differential equation:

$$\begin{cases} \dot{x} = g_1(x, y) \\ \dot{y} = g_2(x, y) \end{cases} \quad (2.1)$$

where  $g_1$  and  $g_2$  are analytic functions defined on an open domain  $\mathcal{V} \subset \mathbb{R}^2$  and  $\dot{x} = \frac{dx}{dt}$ ,  $\dot{y} = \frac{dy}{dt}$ . We assume that (2.1) has two hyperbolic equilibria in  $\mathcal{V}$ , say  $O_1 = (x_1, y_1)$  and  $O_2 = (x_2, y_2)$  (see Figure 1). Let  $-c_1 < 0 < e_1$  be the eigenvalues of the Jacobian matrix of (2.1) at  $O_1$ , and  $\bar{u}(c_1), \bar{u}(e_1)$  be their associate unit eigenvectors.

Analogously, let  $-c_2 < 0 < e_2$  and  $\bar{u}(c_2), \bar{u}(e_2)$  be the corresponding eigenvalues and unit eigenvectors for the jacobian matrix of (2.1) at  $O_2$ . We assume that both  $O_1$  and  $O_2$  satisfy the following conditions:

**(P1)** (Dissipativeness)  $c_1 > e_1$  and  $c_2 > e_2$ .

**(P2)** (Non-resonant condition) For  $i \in \{1, 2\}$ , there exist  $d_i, \tilde{d}_1, d_2, \tilde{d}_2 \in \mathbb{R}^+$  such that for all  $m, n \in \mathbb{N}$ , the following inequality holds:

$$|m c_i - n e_i| > d_i (|m| + |n|)^{-\tilde{d}_i}.$$

**(P3)** (Heteroclinic cycle) The system (2.1) has two heteroclinic solutions in  $\mathcal{V}$ : one from  $O_1$  to  $O_2$ , which we denote by  $\ell_1 = \{(a_1(t), b_1(t)), t \in \mathbb{R}\}$ ; and the other from  $O_2$  to  $O_1$ , which we denote by  $\ell_2 = \{(a_2(t), b_2(t)), t \in \mathbb{R}\}$ , forming a heteroclinic cycle (see Figure 1).

For  $\varepsilon > 0$  sufficiently small, we add two forcing terms to (2.1) of the type:

$$\begin{cases} \dot{x} = g_1(x, y) + \mu_1 P_1(x, y, \omega t) + \mu_2 Q_1(x, y, \omega t) \\ \dot{y} = g_2(x, y) + \mu_1 P_2(x, y, \omega t) + \mu_2 Q_2(x, y, \omega t) \end{cases} \quad (2.2)$$

where  $\omega > 0$ ,  $\mu_1, \mu_2$  are small independent parameters in  $[0, \varepsilon]$  and

$$P_1(x, y, t), P_2(x, y, t), Q_1(x, y, t), Q_2(x, y, t) : \mathcal{V} \times \mathbb{R} \longrightarrow \mathbb{R}$$

are  $C^4$ . We also assume that:

**(P4)** (Periodic perturbations) For  $j \in \{1, 2\}$ , there exists  $T > 0$  such that

$$\forall x, y \in \mathcal{V}, \quad P_j(x, y, t + T) = P_j(x, y, t) \quad \text{and} \quad Q_j(x, y, t + T) = Q_j(x, y, t).$$

**(P5)** The value of  $P_1(x, y, t)$ ,  $P_2(x, y, t)$ ,  $Q_1(x, y, t)$  and  $Q_2(x, y, t)$  and their first derivatives with respect to  $x$  and  $y$  are all zero at  $O_1$  and  $O_2$  for all  $t$ .

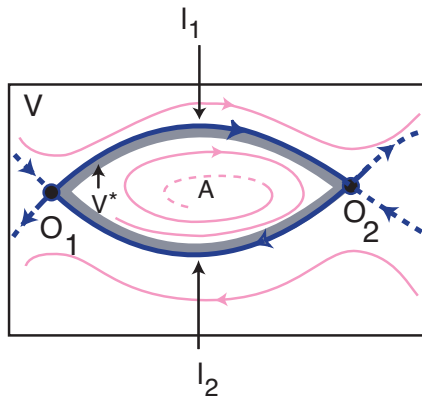

FIGURE 1. The dynamics of (2.1) defined  $\mathcal{V} \subset \mathbb{R}^2$  is governed by the existence of an heteroclinic cycle associated to  $O_1$  and  $O_2$ .  $\ell_1, \ell_2$ : heteroclinic connections;  $\mathcal{V}^*$ : inner basin of attraction of the cycle (absorbing domain);  $\mathcal{A}$ : region limited by the cycle.

In  $\mathcal{V}$ , the heteroclinic cycle  $\ell_1 \cup \ell_2 \cup \{O_1, O_2\}$  limits a region that we call  $\mathcal{A}$ . For  $\mu_1 = \mu_2 = 0$ , there is an open set  $\emptyset \neq \mathcal{V}^*$  of  $\mathcal{A}$  such that the  $\omega$ -limit of all solutions starting in  $\mathcal{V}^*$  is  $\ell_1 \cup \ell_2$ . In other words, the cycle  $\ell_1 \cup \ell_2 \cup \{O_1, O_2\}$  is asymptotically stable “by inside” (configuration similar to that of Takens [23]<sup>1</sup>).

<sup>1</sup>This configuration is also called the “attracting Bowen eye”.

2.2. **The lift.** We now introduce an angular variable  $\theta \in \mathbb{S}^1 = \mathbb{R}/\mathbb{Z}T$  to rewrite (2.2) as

$$\begin{cases} \dot{x} = g_1(x, y) + \mu_1 P_1(x, y, \theta) + \mu_2 Q_1(x, y, \theta) \\ \dot{y} = g_2(x, y) + \mu_1 P_2(x, y, \theta) + \mu_2 Q_2(x, y, \theta) \\ \dot{\theta} = \omega \end{cases} \quad (2.3)$$

or, in matricial notation, by:

$$\begin{pmatrix} \dot{x} \\ \dot{y} \\ \dot{\theta} \end{pmatrix} = \begin{pmatrix} g_1(x, y) \\ g_2(x, y) \\ \omega \end{pmatrix} + \mu_1 \begin{pmatrix} P_1(x, y, \theta) \\ P_2(x, y, \theta) \\ 0 \end{pmatrix} + \mu_2 \begin{pmatrix} Q_1(x, y, \theta) \\ Q_2(x, y, \theta) \\ 0 \end{pmatrix}. \quad (2.4)$$

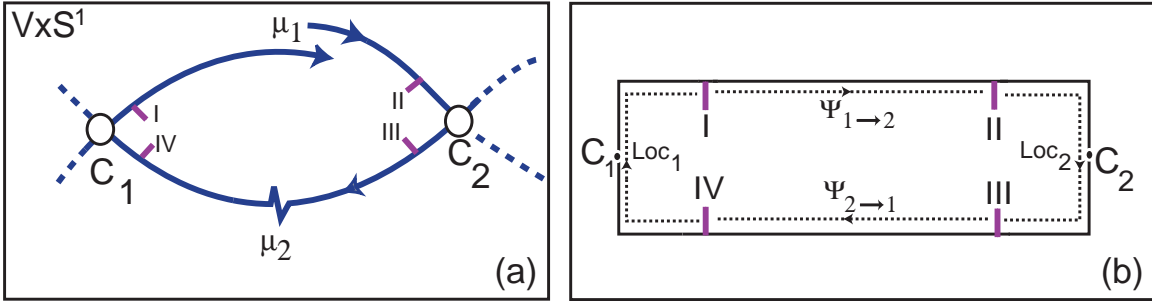

FIGURE 2. (a) Scheme of the effects of the parameters  $\mu_1, \mu_2$  on the equations (2.3). (b) Sketch of the local and transition maps. *I, II, III* and *IV* represent cross sections  $\text{Out}(C_1)$ ,  $\text{In}(C_2)$ ,  $\text{Out}(C_2)$  and  $\text{In}(C_1)$ , respectively.

The vector field associated to equation (2.3) will be denoted by  $f_{(\mu_1, \mu_2)}$ . In the phase space of (2.3), say  $\mathbb{V} = \mathcal{V} \times \mathbb{S}^1$ , for  $\mu_1 = \mu_2 = 0$ , there is an attracting heteroclinic cycle  $\Gamma$  between two hyperbolic periodic solutions, say  $C_1 \cup C_2$ , connected by two manifolds diffeomorphic to tori  $\mathcal{L}_1$  and  $\mathcal{L}_2$ . The periodic solution  $C_i$  is the lift of  $O_i$ ,  $i = 1, 2$ . Set  $\mathbb{A} = \mathcal{A} \times \mathbb{S}^1$ .

In the  $(x, y, \theta)$ -space, let  $V_1$  and  $V_2$  be two hollow cylinders around  $C_1$  and  $C_2$ , respectively, where a local normal form may be defined. Let  $\text{Out}(C_1)$  and  $\text{Out}(C_2)$  be two sections (planes) transverse to  $\mathcal{L}_1 \cup \mathcal{L}_2$  where all initial conditions go outside  $V_1$  and  $V_2$  in positive time, respectively. Analogously, let  $\text{In}(C_1)$  and  $\text{In}(C_2)$  be two sections (planes) transverse to  $\mathcal{L}_1 \cup \mathcal{L}_2$  where all initial conditions go inside  $V_1$  and  $V_2$  in positive time, respectively.

2.3. **Parameters effects.** Concerning the addition of the non-zero perturbing terms whose magnitude is governed by  $\mu_1$  and  $\mu_2$ , the effect on the dynamics of (2.3) differs from the type of intersection between the invariant manifolds of  $C_1$  and  $C_2$  as follows:

**Case 1:**  $W^u(C_1) \pitchfork W^s(C_2)$  and  $W^u(C_2) \pitchfork W^s(C_1)$

**Case 2:**  $W^u(C_1) \cap W^s(C_2) = \emptyset$  and  $W^u(C_2) \pitchfork W^s(C_1)$

**Case 3:**  $W^u(C_1) \pitchfork W^s(C_2)$  and  $W^u(C_2) \cap W^s(C_1) = \emptyset$

**Case 4:**  $W^u(C_1) \cap W^s(C_2) = \emptyset$  and  $W^u(C_2) \cap W^s(C_1) = \emptyset$ ,

where  $A \pitchfork B$  means that the manifolds  $A$  and  $B$  intersect transversely. In Table 1, we identify these four cases.

Configuration	$W^u(\mathbf{C}_1) \pitchfork W^s(\mathbf{C}_2)$	$W^u(\mathbf{C}_1) \cap W^s(\mathbf{C}_2) = \emptyset$
$W^u(\mathbf{C}_2) \pitchfork W^s(\mathbf{C}_1)$	Case 1	Case 2
$W^u(\mathbf{C}_2) \cap W^s(\mathbf{C}_1) = \emptyset$	Case 3	Case 4

TABLE 1. Four generic different cases for the dynamics of (2.3).

*Remark 2.1.* Since  $\mathbf{C}_1$  and  $\mathbf{C}_2$  are hyperbolic, they persist for  $\mu_1, \mu_2 > 0$  small. For  $\mu_1 > 0$ , when we consider empty intersection of the invariant manifolds, we mean  $W^u(\mathbf{C}_1)$  enters the absorbing domain  $\mathbb{V}^*$ , otherwise there are no guarantees that the set of non-wandering points is non-empty.

For  $(\mu_1, \mu_2) \in [0, \varepsilon] \times [0, \varepsilon]$ , let  $\mathcal{F}_{(\mu_1, \mu_2)}$  and  $\mathcal{G}_{(\mu_1, \mu_2)}$  be the return maps to the cross sections  $\text{Out}(\mathbf{C}_1)$  and  $\text{Out}(\mathbf{C}_2)$ , respectively. Denote

$$\Omega(\mathcal{F}_{(\mu_1, \mu_2)}) = \left\{ X \in \text{Out}(\mathbf{C}_1) : \mathcal{F}_{(\mu_1, \mu_2)}^n(X) \in \text{Out}(\mathbf{C}_1), \quad \forall n \in \mathbb{N} \right\}$$

and

$$\Lambda(\mathcal{F}_{(\mu_1, \mu_2)}) = \bigcap_{n \in \mathbb{N}} \mathcal{F}_{(\mu_1, \mu_2)}^n(\Omega_\mu).$$

The set  $\Omega(\mathcal{F}_{(\mu_1, \mu_2)})$  represents all solutions of (2.3) that stay around the unforced heteroclinic loop  $\mathcal{L}_1 \cup \mathcal{L}_2$  in forward time and  $\Lambda(\mathcal{F}_{(\mu_1, \mu_2)})$  represents all solutions that stay around  $\mathcal{L}_1 \cup \mathcal{L}_2$ , for all time. Analogously we define  $\Omega(\mathcal{G}_{(\mu_1, \mu_2)})$  and  $\Lambda(\mathcal{G}_{(\mu_1, \mu_2)})$ , replacing  $\text{Out}(\mathbf{C}_1)$  by  $\text{Out}(\mathbf{C}_2)$ . With respect to the effect of the perturbations governed by  $\mu_1$  and  $\mu_2$ , both act independently and we state the following hypotheses ( $A \equiv_{\mathbb{V}^*} B$  means that the manifolds  $A$  and  $B$  coincide within  $\mathbb{V}^*$ ):

**(P6a)** If  $\mu_1 > 0$  and  $\mu_2 = 0$ , then  $W^u(\mathbf{C}_1) \cap W^s(\mathbf{C}_2) = \emptyset$  and  $W^u(\mathbf{C}_2) \equiv_{\mathbb{V}^*} W^s(\mathbf{C}_1)$ .

**(P6b)** If  $\mu_2 > 0$  and  $\mu_1 = 0$ , then  $W^u(\mathbf{C}_1) \equiv_{\mathbb{V}^*} W^s(\mathbf{C}_2)$  and  $W^u(\mathbf{C}_2) \pitchfork W^s(\mathbf{C}_1)$ .

When we refer to **(P6)**, we refer to **(P6a)** and **(P6b)**. For  $\mu_1, \mu_2 \in [0, \varepsilon]$ , in the local coordinates of Subsection 6.1, the flow associated to (2.3) induces the  $C^3$ -embeddings

$$\Psi_{1 \rightarrow 2} : \text{Out}(\mathbf{C}_1) \rightarrow \text{In}(\mathbf{C}_2) \quad \text{and} \quad \Psi_{2 \rightarrow 1} : \text{Out}(\mathbf{C}_2) \rightarrow \text{In}(\mathbf{C}_1)$$

of the form<sup>2</sup>:

<sup>2</sup>These hypotheses will be clear in Section 6.

**(P7a)**

$$\Psi_{1 \rightarrow 2} \left( y_1^{(1)}, \theta^{(1)} \right) = \left[ c_1 y_1^{(1)} + \mu_1 \Phi_1 \left( y_1^{(1)}, \theta^{(1)} \right); \quad \theta^{(1)} + \xi_1 + \mu_1 \Psi_1 \left( y_1^{(1)}, \theta^{(1)} \right) \right] \quad (2.5)$$

where  $c_1 \neq 0$ ,  $\xi_1 \in \mathbb{R}$ ,  $\Psi_1 : \text{Out}(\mathbf{C}_1) \rightarrow \mathbb{R}$  is  $C^1$  and  $\Phi_1 : \text{Out}(\mathbf{C}_1) \rightarrow \mathbb{R}^+$  is  $C^3$ , non-constant and has a finite number of non degenerate critical points. Furthermore,

**(P7b)**

$$\Psi_{2 \rightarrow 1} \left( y_1^{(2)}, \theta^{(2)} \right) = \left[ c_2 y_1^{(2)} + \mu_2 \Phi_2 \left( y_1^{(2)}, \theta^{(2)} \right); \quad \theta^{(2)} + \xi_2 + \mu_2 \Psi_2 \left( y_1^{(2)}, \theta^{(2)} \right) \right] \quad (2.6)$$

where  $c_2 \neq 0$ ,  $\xi_2 \in \mathbb{R}$ ,  $\Psi_2, \Phi : \text{Out}(\mathbf{C}_2) \rightarrow \mathbb{R}$  are  $C^1$  and  $\Phi_2 : \text{Out}(\mathbf{C}_2) \rightarrow \mathbb{R}$  has at least two non degenerate zeros.

*Remark 2.2.* When there is no risk of misunderstanding, we identify  $\Phi_1(\theta) \equiv \Phi_1(0, \theta)$  and  $\Phi_2(\theta) \equiv \Phi_2(0, \theta)$ , where  $\theta \in \mathbb{S}^1$ .

**2.4. Literature on the topic and the goal of this article.** Case 1 has been studied in [5, 10, 18]; the authors found a sequence of suspended horseshoes accumulating on the cycle, homoclinic tangencies and Newhouse phenomena giving rise to sinks and Hénon-type strange attractors. Their results do not depend on the frequency  $\omega$ . Case 4 has been discussed in [13], where the authors proved the existence of an attracting torus for  $\omega \approx 0$  and rank-one attractors for  $\omega \gg 1$  (sufficiently large). Combining the techniques developed in [5, 13], in this paper we deal with Case 2 illustrated in Figure 2. Case 3 has a similar treatment. We also provide complementary results for Cases 1 and 4.

### 3. MAIN RESULTS

Once for all, let us fix  $\varepsilon > 0$  small. Denote by  $\mathfrak{X}_\Gamma^4(\mathbb{V})$  the two-parameter family of  $C^4$ -vector fields (2.3) satisfying conditions **(P1)**–**(P7)**. Before going further, we set two positive constants that will be used in the sequel:

$$K_F = \frac{1}{e_2} + \frac{c_2/e_2}{e_1} \quad \text{and} \quad K_G = \frac{1}{e_1} + \frac{c_1/e_1}{e_2}. \quad (3.1)$$

Our first result strongly relies on the global map  $\Psi_{1 \rightarrow 2}$  from  $\text{Out}(\mathbf{C}_1)$  to  $\text{In}(\mathbf{C}_2)$  (cf. (2.5) and Remark 2.2).

**Theorem A.** *Let  $f_{(\mu_1, 0)} \in \mathfrak{X}_\Gamma^4(\mathbb{V})$ , with  $\mu_1 > 0$ . If  $\omega$  is such that*

$$\omega \times \sup_{\theta \in \mathbb{S}^1} \left( \frac{\Phi_1'(\theta)}{\Phi_1(\theta)} \right) < \frac{1}{K_F},$$

*then there is an invariant closed curve  $\mathcal{C} \subset \text{Out}(\mathbf{C}_1)$  as the maximal attractor for the map  $\mathcal{F}_{(\mu_1, 0)}$ . This closed curve is not contractible on  $\text{Out}(\mathbf{C}_1)$ .*

Although we use the Theory of Rank-one attractors to prove Theorem A, this result may be shown using the Afraimovich's Annulus Principle [1]. The curve  $\mathcal{C} \subset \text{Out}(\mathbf{C}_1)$  is *globally attracting* in the sense that, for every  $X \in \mathbb{V}^*$ , there exists a point  $X_0 \in \mathcal{C}$  such that

$$\lim_{n \rightarrow +\infty} \left\| \mathcal{F}_{(\mu_1, 0)}^n(X) - \mathcal{F}_{(\mu_1, 0)}^n(X_0) \right\| = 0,$$

where  $\|\star\|$  is the usual norm induced from  $\mathbb{R}^2$ . The attracting invariant curve for  $\mathcal{F}_{(\mu_1,0)}$  is the graph of a smooth map and corresponds to an attracting two-dimensional torus for the flow of (2.3). When  $\mu_1 > 0$  and  $\mu_2 = 0$ , one branch of  $W^u(\mathbf{C}_1)$  accumulates on the torus.

The dynamics of  $\mathcal{F}_{(\mu_1,0)}$  induces on  $\mathcal{C}$  a circle map. Indeed, for any given interval of unit length  $[0, \varepsilon]$ , there is a positive measure set  $\Delta \subset [0, \varepsilon]$  so that the rotation number of  $\mathcal{F}_{(\mu_1,0)}|_{\mathcal{C}}$  is irrational if and only if  $\mu_1 \in \Delta$ . This implies the existence of a set of positive Lebesgue measure (in the bifurcation parameter) for which the torus has a dense orbit, *i.e.* the torus is a *minimal attractor* [9].

**Theorem B.** *Let  $f_{(\mu_1,0)} \in \mathfrak{X}_{\Gamma}^4(\mathbb{V})$ , with  $\mu_1 > 0$ . There exists  $\omega^* > 0$  such that for all  $\omega > \omega^*$ , there is a subset of positive Lebesgue measure  $\Delta \subset [0, \varepsilon]$  for which the map  $\mathcal{F}_{(\mu_1,0)}$  with  $\mu_1 \in \Delta$ , exhibits rank-one strange attractors with an ergodic SRB measure.*

The existence of rank-one strange attractors for  $\mathcal{F}_{\mu}$  is an *abundant phenomenon* in the terminology of [12]. Furthermore, these attractors are “*large*” according to [4], *i.e.* their non-wandering points wind around an entire non-contractible annulus. These strange attractors have strong statistical properties that will be made precise in Section 5 (see also [28]).

The proof of Theorems A and B is performed in Subsections 7.3 and 7.4 by reducing the analysis of the two-dimensional map  $\mathcal{F}_{(\mu_1,0)}$  to the dynamics of a one-dimensional map, via the *Rank-one attractors’s* theory.

**Theorem C.** *Let  $f_{(\mu_1,0)} \in \mathfrak{X}_{\Gamma}^4(\mathbb{V})$ , with  $\mu_1 > 0$ . Under an open technical hypothesis (**TH**) on the space of parameters, for  $\omega \gg 1$  there exists a sequence of real numbers converging to zero, say  $(\mu_{1,n})_{n \in \mathbb{N}}$ , for which the flow of (2.3) exhibits a periodic sink.*

This sink does not follow from the Newhouse theory [14]; it is *superstable* in the sense that one of its Floquet multipliers is very close to zero. The open condition (**TH**) stated in Theorem C is technical and depends on a specific variable in the definition of Misiurewicz-type map in Subsection 5.1. It will be clear in Section 8, where the proof of the result is performed.

The next two results concern the case  $\mu_1 = 0$  and  $\mu_2 > 0$ , where  $W^u(\mathbf{C}_1) \equiv W^s(\mathbf{C}_2)$  and  $W^u(\mathbf{C}_2)$  meets transversely  $W^s(\mathbf{C}_1)$ , giving rise to what we usually call *heteroclinic tangle*. The *Rank-one maps’s* theory does not apply in this context.

**Theorem D.** *Let  $f_{(0,\mu_2)} \in \mathfrak{X}_{\Gamma}^4(\mathbb{V})$ , with  $\mu_2 > 0$ . The flow of (2.3) satisfies the following properties for  $\mu_2 > 0$ :*

- (1) *the set  $\Lambda(\mathcal{G}_{(0,\mu_2)})$  contains a horseshoe with infinitely many branches.*
- (2) *there is a sequence  $(\mu_{2,i})_{i \in \mathbb{N}}$  of positive real numbers converging to zero, such that the manifolds  $W^u(\mathbf{C}_2)$  and  $W^s(\mathbf{C}_2)$  meet tangentially<sup>3</sup> for the flow of  $f_{(0,\mu_{2,i})}$ .*
- (3) *there exists a positive measure set of parameters in  $I = [0, \varepsilon]$  so that  $\mathcal{G}_{(0,\mu_2)}$  admits a strange attractor with an ergodic SRB measure.*
- (4) *there is a sequence  $(\tilde{\mu}_{2,i})_{i \in \mathbb{N}}$  of positive real numbers converging to zero, such that the flow of  $f_{(0,\tilde{\mu}_{2,i})}$  has a periodic sink.*

---

<sup>3</sup>This tangency is quadratic (generic).



The proof of Theorem D does not depend on  $\omega$  and follows the same lines to the reasoning of [5, 10]. Item (1) of Theorem D is often called the classical Birkhoff-Melnikov-Smale horseshoe theorem.

*Remark 3.1.* Points in the horseshoe stated in Theorem D lie on the topological closure of  $W^u(\mathbf{C}_2) \cap W^s(\mathbf{C}_1)$ .

The horseshoe whose existence is proved in Theorem D has infinitely many saddle periodic points, whose Lyapunov multipliers' modules tend to  $+\infty$  and to 0. The next notion will be useful in the sequel.

*Definition 1.* We say that the embedding  $\mathcal{G}_{(0,\mu_2)} : \text{Out}(\mathbf{C}_2) \rightarrow \text{Out}(\mathbf{C}_2)$  exhibits *non-uniform expansion* if, given  $\rho > 0$ , for Lebesgue almost all points in  $\text{Out}(\mathbf{C}_2)$ , the map  $\mathcal{G}_{(0,\mu_2)}$  is well defined and has a positive upper Lyapunov exponent greater than  $\rho$ .

The next result ensures the existence of a “large” strange attractor for the dynamics of (2.3) and its non-uniform expansion for most parameters.

**Proposition E.** *Let  $f_{(0,\mu_2)} \in \mathfrak{X}_\Gamma^4(\mathbb{V})$ , with  $\mu_2 > 0$ . If  $\omega \gg 1$ , then the first return map  $\mathcal{G}_{(0,\mu_2)}$  associated to (2.3) exhibits a “large” strange attractor with non-uniform expansion.*

The proof of this result is proved in Section 10. In particular, it is possible to construct invariant probabilities absolutely continuous with respect to the Lebesgue measure (cf. [28, Sec. 3]).

**Theorem F.** *Let  $f_{(\mu_1,\mu_2)} \in \mathfrak{X}_\Gamma^4(\mathbb{V})$ , with  $\mu_1, \mu_2 > 0$ . In the bifurcation parameter  $(\mu_1, \mu_2) \in [0, \varepsilon]^2$ , there exists a curve *Hom* associated to the emergence of homoclinic cycles to  $\mathbf{C}_1$ . Heteroclinic tangles occurs in the convex region defined by this curve.*

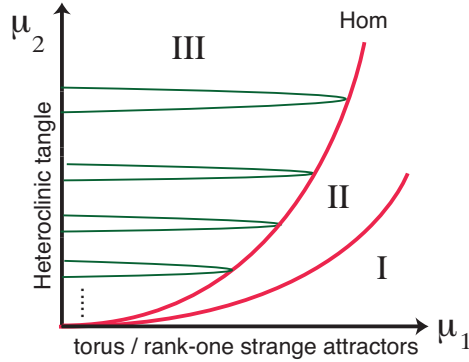

FIGURE 3. Plausible bifurcation diagram associated to an element  $f_{(\mu_1,\mu_2)}$  of the family  $\mathfrak{X}_\Gamma^4(\mathbb{V})$ . I – the flow has an invariant two-dimensional torus if  $\omega \approx 0$  and a rank-one strange attractor if  $\omega \gg 1$ . II – transition region; III – heteroclinic tangle; Hom – curve that corresponds to the emergence of a homoclinic tangency associated to  $\mathbf{C}_1$ .

The proof of Theorem F is performed in Section 11. As suggested in Figure 3, for  $\varepsilon > 0$  small and  $r \in [0, \varepsilon]$ , defining

$$B_r = \{(\mu_1, \mu_2) \in [0, \varepsilon] \times [0, \varepsilon] : \mu_1^2 + \mu_2^2 \leq r^2\},$$



we have:

$$\lim_{r \rightarrow 0} \frac{\text{Leb}_2(\{(\mu_1, \mu_2) \in [0, r] \times [0, r] : \mathcal{F}_{(\mu_1, \mu_2)} \text{ exhibits heteroclinic tangles}\} \cap B_r)}{\text{Leb}_2(B_r)} = 1,$$

where  $\text{Leb}_2$  denotes the usual two-dimensional Lebesgue measure. This is why we say that non-uniform hyperbolicity is a *prevalent phenomena* in the problem under consideration.

#### 4. PRELIMINARIES: STRANGE ATTRACTORS AND SRB MEASURES

In this section, we gather a collection of technical facts used repeatedly in later sections. We formalize the notion of strange attractor for a two-parametric family of diffeomorphisms  $H_{(a,b)}$  defined on  $M = [0, 1] \times \mathbb{S}^1$ , endowed with the induced topology. The set  $M$  is also called by *circloid* in [16]. In what follows, if  $A \subset M$ ,  $\bar{A}$  denotes its topological closure.

Let  $H_{(a,b)}$  be an embedding such that  $H_{(a,b)}(\bar{U}) \subset U$  for some open set  $U \subset M$ . In the present article, we refer to

$$\Omega = \bigcap_{m=0}^{+\infty} H_{(a,b)}^m(\bar{U}).$$

as an *attractor* and  $U$  its *basin*. The attractor  $\Omega$  is *irreducible* if it cannot be written as the union of two (or more) disjoint attractors.

*Definition 2.* The embedding  $H_{(a,b)}$  is said to have a *horseshoe with infinitely many branches* if there exists an invariant subset  $\Sigma \subset U$  on which  $H_{(a,b)}|_{\Sigma}$  is topologically conjugated to a full shift of infinitely many symbols.

*Definition 3.* We say that  $H_{(a,b)}$  possesses a *strange attractor supporting an ergodic SRB measure*  $\nu$  if:

- for Lebesgue almost all  $(y, \theta) \in U$ , the  $H_{(a,b)}$ -orbit of  $(y, \theta)$  has a positive Lyapunov exponent, *ie*

$$\lim_{n \in \mathbb{N}} \frac{1}{n} \log \|DH_{(a,b)}^n(y, \theta)\| > 0;$$

- $H_{(a,b)}$  admits a unique ergodic SRB measure (with no-zero Lyapunov exponents) [26];
- for Lebesgue almost all points  $(y, \theta) \in U$  and for every continuous test function  $\varphi : U \rightarrow \mathbb{R}$ , we have:

$$\lim_{n \in \mathbb{N}} \frac{1}{n} \sum_{i=0}^{n-1} \varphi \circ H_{(a,b)}^i(y, \theta) = \int \varphi d\nu. \quad (4.1)$$

Admitting that  $H_{(a,b)}$  admits a unique ergodic SRB measure  $\nu$ , we define convergence of  $H_{(a,b)}$  with respect to  $\nu$  as follows:

*Definition 4.* We say that:

- $H_{(a,b)}$  converges (in distribution with respect to  $\nu$ ) to the normal distribution if, for every Hölder continuous function  $\varphi : U \rightarrow \mathbb{R}$ , the sequence  $\{\varphi(H_{(a,b)}^i) : i \in \mathbb{N}\}$  obeys a *central limit theorem*; *ie*, if  $\int \varphi d\nu = 0$  then the sequence  $\left(\frac{1}{\sqrt{m}} \sum_{i=0}^{m-1} \varphi \circ H_{(a,b)}^i\right)_m$  converges in distribution (with respect to  $\nu$ ) to the *normal distribution*.

- the pair  $(H_{(a,b)}, \nu)$  is *mixing* if it is isomorphic to a Bernoulli shift.

We address the reader for [26] for more information on the subject.

## 5. RANK-ONE ATTRACTORS' THEORY REVISITED

To make a self-contained presentation, we provide an exposition of the theory of rank-one attractors adapted to our purposes. We hope this saves the reader the trouble of going through the entire length of [25, 26] to achieve a complete description of the theory.

In what follows, let us denote by  $C^3(\mathbb{S}^1, \mathbb{R})$  the set of  $C^3$ -maps from  $\mathbb{S}^1$  (unit circle) to  $\mathbb{R}$ . For  $h \in C^3(\mathbb{S}^1, \mathbb{R})$ , let

$$C \equiv C(h) = \{\theta \in \mathbb{S}^1 : h'(\theta) = 0\}$$

be the *critical set* of  $h$ . For  $\delta > 0$ , let  $C_\delta$  be the  $\delta$ -neighbourhood of  $C$  in  $\mathbb{S}^1$  and let  $C_\delta$  be the  $\delta$ -neighbourhood of  $\theta \in C$  as illustrated in Figure 4. The terminology *dist* denotes the euclidian distance on  $\mathbb{R}$ .

**5.1. Misiurewicz-type map.** We say that  $h \in C^3(\mathbb{S}^1, \mathbb{R})$  is a *Misiurewicz-type map* (and we denote it by  $h \in \mathcal{E}$ ) if the following assertions hold:

- (1) There exists  $\delta_0 > 0$  such that:
  - (a)  $\forall \theta \in C_{\delta_0}$ , we have  $h''(\theta) \neq 0$  and
  - (b)  $\forall \theta \in C$  and  $n \in \mathbb{N}$ ,  $\text{dist}(h^n(\theta), C) \geq \delta_0$ .
- (2) There exist constants  $b_0, \lambda_0 \in \mathbb{R}^+$  such that for all  $\delta < \delta_0$  and  $n \in \mathbb{N}$ , we may write:
  - (a) if  $h^k(\theta) \notin C_\delta$  for  $k \in \{0, \dots, n-1\}$ , then  $|(h^n)'(\theta)| \geq b_0 \delta \exp(\lambda_0 n)$  and
  - (b) if  $h^k(\theta) \notin C_\delta$  for  $k \in \{0, \dots, n-1\}$  and  $h^n(\theta) \in C_{\delta_0}$ , then  $|(h^n)'(\theta)| \geq b_0 \exp(\lambda_0 n)$ .

Maps in  $\mathcal{E}$  are among the simplest with non-uniform expansion. For  $\delta_0 > 0$ , the set  $C_{\delta_0}$  induces a partition on  $\mathbb{S}^1$ , ie the space  $\mathbb{S}^1$  may be divided in  $C_{\delta_0}$  and  $\mathbb{S}^1 \setminus C_{\delta_0}$ .

### Digestive remarks about Misiurewicz-type maps.

- (1) The critical orbits stay a fixed distance away from the critical set  $C$ ;
- (2) The derivatives grow at a uniform exponential rate (up to a prefactor) along orbits that remain outside  $C_\delta$ ;
- (3) For  $\theta \in C_\delta \setminus C$ , although  $|h'(\theta)|$  is small, the orbit of  $\theta \in \mathbb{S}^1$  does not return to  $C_\delta$  again until its derivative has regained an “amount” of exponential growth.

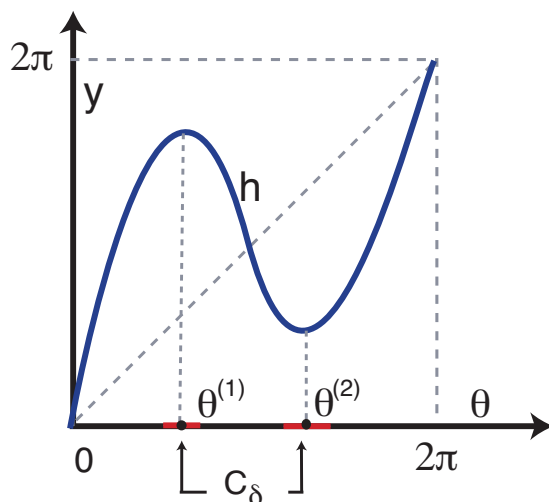

FIGURE 4. Example of a Misiurewicz-type map  $h_a : \mathbb{S}^1 \rightarrow \mathbb{R}$ . For  $\delta > 0$ , the set  $C_\delta$  is a  $\delta$ -neighbourhood of the set of critical points  $C$ .

**5.2. Admissible family.** We recall the notation and main results of [28]. Let

$$H : [0, 2\pi] \times \mathbb{S}^1 \rightarrow [0, 2\pi]$$

be a  $C^3$  map. The map  $H$  defines a one-parameter family of maps

$$\{h_a \in C^3([0, 2\pi], [0, 2\pi]) : a \in \mathbb{S}^1\}$$

via  $h_a(x) = H(x, a)$ . We assume that there exists  $a^* \in \mathbb{S}^1$  such that  $h_{a^*} \in \mathcal{E}$  (ie  $h_{a^*}$  is a Misiurewicz map). For each  $c \in C(h_{a^*})$ , there exists a continuation  $c(a) \in C(h_a)$  provided  $a$  is sufficiently close to  $a^*$ . Therefore, for  $a$  close to  $a^*$ , let  $C(h_{a^*}) = \{c^{(1)}(a^*), \dots, c^{(q)}(a^*)\}$ , where

$$\forall i \in \{1, \dots, q-1\}, \quad c^{(i)}(a^*) < c^{(i+1)}(a^*) \quad \text{and} \quad c^{(q+1)}(a^*) = c^{(1)}(a^*).$$

From now on, when there is no risk of misunderstanding, we omit the dependence on  $a^*$  and the superscript  $(i)$  in order to simplify the notation. For  $c(a^*) \in C(h_{a^*})$  we denote

$$\beta_c(a^*) = h_{a^*}(c(a^*)).$$

For all parameters  $a$  sufficiently close to  $a^*$ , there exists a unique continuation  $\beta_c(a)$  of  $\beta_c(a^*)$  such that the orbits

$$\{h_{a^*}^n(\beta_c(a^*)) : n \in \mathbb{N}\} \quad \text{and} \quad \{h_a^n(\beta_c(a)) : n \in \mathbb{N}\}$$

have the same itineraries with respect to the partitions of  $[0, 1]$  induced by  $C(h_{a^*})$  and  $C(h_a)$ , respectively. This means that:

$$\forall n \in \mathbb{N}, \quad (h_{a^*}^n(\beta_c(a^*)) \in (c^{(j)}(a^*), c^{(j+1)}(a^*))) \Leftrightarrow (h_a^n(\beta_c(a)) \in (c^{(j)}(a), c^{(j+1)}(a))),$$

for  $j \in \{1, \dots, q\}$ . In addition:

**Lemma 5.1** ([28]). *The map  $a \mapsto \beta_c(a)$  is differentiable.*

The previous lemma will be implicitly used in the next definition.

*Definition 5.* Let  $H : [0, 1] \times \mathbb{S}^1 \rightarrow [0, 1]$  be a  $C^3$  map. The associated one-parameter family  $\{h_a : a \in \mathbb{S}^1\}$  is *admissible* if:

- (1) there exists  $a^* \in \mathbb{S}^1$  such that  $h_{a^*} \in \mathcal{E}$ ;
- (2) for all  $c \in C(h_{a^*})$ , we have

$$\xi(c) = \frac{d}{da}(h_a(c(a) - \beta_c(a)))|_{a=a^*} = \frac{d}{da}(h_a(c(a) - h_{a^*}(c(a^*)))|_{a=a^*} \neq 0.$$

**5.3. Rank-one maps.** Let  $M = [0, 2\pi] \times \mathbb{S}^1$ , induced with the usual topology. We consider the two-parameter family of maps  $H_{(a,b)} : M \rightarrow M$ , where  $a \in \mathbb{S}^1$  and  $b \in \mathbb{R}$  is a scalar. Let  $B_0 \subset \mathbb{R} \setminus \{0\}$  with 0 as an accumulation point; this will be a crucial point in order to prove our results in Subsection 7.1. We assume the following conditions:

- (H1) Regularity conditions:** (1) For each  $b \in B_0$ , the function  $(x, y, a) \mapsto H_{(a,b)}$  is at least  $C^3$ -smooth.
- (2) Each map  $H_{(a,b)}$  is an embedding of  $M$  into itself.
- (3) There exists  $k \in \mathbb{R}^+$  independent of  $a$  and  $b$  such that for all  $a \in \mathbb{S}^1$ ,  $b \in B_0$  and  $(y_1, \theta_1), (y_2, \theta_2) \in M$ , we have:

$$\frac{|\det DH_{(a,b)}(y_1, \theta_1)|}{|\det DH_{(a,b)}(y_2, \theta_2)|} \leq k.$$

- (H2) Existence of a singular limit:** For  $a \in \mathbb{S}^1$ , there exists a map

$$H_{(a,0)} : M \rightarrow \{0\} \times \mathbb{S}^1$$

such that the following property holds: for every  $(y, \theta) \in M$  and  $a \in [0, 2\pi]$ , we have

$$\lim_{b \rightarrow 0} H_{(a,b)}(y, \theta) = H_{(a,0)}(y, \theta).$$

- (H3)  $C^3$ -convergence to the singular limit:** For every choice of  $a \in \mathbb{S}^1$ , the maps  $(y, \theta, a) \mapsto H_{(a,b)}$  converge in the  $C^3$ -topology to  $(y, \theta, a) \mapsto H_{(a,0)}$  on  $M \times \mathbb{S}^1$  as  $b$  goes to zero.

- (H4) Existence of a sufficiently expanding map within the singular limit:** There exists  $a^* \in \mathbb{S}^1$  such that  $h_{a^*}(\theta) \equiv H_{(a^*,0)}(0, \theta)$  is a Misiurewicz-type map.

- (H5) Parameter transversality:** Let  $C_{a^*}$  denote the critical set of a Misiurewicz-type map  $h_{a^*}$ . For each  $x \in C_{a^*} \equiv C(h_{a^*})$ , let  $p = h_{a^*}(x)$ , and let  $x(\tilde{a})$  and  $p(\tilde{a})$  denote the continuations of  $x$  and  $p$ , respectively, as the parameter  $a$  varies around  $a^*$ . The point  $p(\tilde{a})$  is the unique point such that  $p(\tilde{a})$  and  $p$  have identical symbolic itineraries under  $h_{a^*}$  and  $h_{\tilde{a}}$ , respectively. We have:

$$\frac{d}{da}h_{\tilde{a}}(x(\tilde{a}))|_{a=a^*} \neq \frac{d}{da}p(\tilde{a})|_{a=a^*}.$$

- (H6) Nondegeneracy at turns:** For each  $x \in C_{a^*}$ , we have

$$\frac{d}{dy}H_{(a^*,0)}(y, \theta)|_{y=0} \neq 0.$$

**(H7) Conditions for mixing:** If  $J_1, \dots, J_r$  are the intervals of monotonicity of a Misiurewicz-type map  $h_{a^*}$ , then:

- (1)  $\exp(\lambda_0/3) > 2$  (see the meaning of  $\lambda_0$  in Subsection 5.1) and
- (2) if  $Q = (q_{im})$  is the matrix of all possible transitions between the intervals of monotonicity of  $h_{a^*}$  defined by:

$$\begin{cases} 1 & \text{if } J_m \subset h_{a^*}(J_i) \\ 0 & \text{otherwise,} \end{cases}$$

then there exists  $N \in \mathbb{N}$  such that  $Q^N > 0$  (in other words, all entries of the matrix  $Q^N$ , endowed with the usual product topology, are positive).

*Remark 5.2.* By **(H2)**, identifying  $\mathbb{S}^1 \times \{0\}$  with  $\mathbb{S}^1$ , we refer to  $H_{(a,0)}$  the restriction  $h_a : \mathbb{S}^1 \rightarrow \mathbb{S}^1$  defined by  $h_a(\theta) = H_{(a,0)}(\theta, 0)$  as the *singular limit* of  $H_{(a,b)}$ .

**5.4. Wang and Young's reduction.** The results developed in [26, 27] are about maps with attracting sets on which there is strong dissipation and (in most places) a single direction of instability. Two-parameter families  $H_{(a,b)}$  have been considered and it has been proved that if a singular limit makes sense (for  $b = 0$ ) and if the resulting family of one-dimensional maps has certain “good” properties, then some of them can be passed back to the two-dimensional system ( $b > 0$ ). They in turn allow us to prove results on strange attractors for a positive Lebesgue measure set of  $a$ .

Conditions **(H1)**–**(H7)** are simple and checkable; when satisfied, they guarantee the existence of strange attractors with a package of statistical and geometric properties:

**Theorem 5.3** ([26], adapted). *Suppose the family  $H_{(a,b)}$  satisfies **(H1)**–**(H7)**. Then, for all sufficiently small  $b \in B_0$ , there exists a subset  $\Delta \subset [0, 2\pi]$  with positive Lebesgue measure such that for  $a \in \Delta$ , the map  $H_{(a,b)}$  admits an irreducible strange attractor  $\tilde{\Omega} \subset \Omega$  that supports a unique ergodic SRB measure  $\nu$ . The orbit of Lebesgue almost all points in  $\tilde{\Omega}$  has positive Lyapunov exponent and is asymptotically distributed according to  $\nu$ .*

The map  $H_{(a,b)}$  has *exponential decay of correlations* for Hölder continuous observables. The theory may be extended for  $[0, 1]^{N-1} \times \mathbb{S}^1$ , with  $N \geq 2$  [28].

**5.5. Periodic attractors in singular limits of families of rank-one maps.** We now introduce the combinatorics needed to prove Theorem 5.5. Let  $\delta < \delta_0$  be fixed ( $\delta_0 > 0$  is the constant coming from the definition of *Misiurewicz-type map* in Subsection 5.1). For  $1 \leq i \leq q$ , let  $J^{(i)}$  be a subinterval of  $C_\delta^{(i)}$ , the connected component of  $C_\delta$  containing the critical point  $c^{(i)}$ , and assume that there exist  $n = n(i)$  and  $j = j(i)$  associated to  $J^{(i)}$  such that:

- (1)  $h^k(J^{(i)}) \cap C_\delta = \emptyset$  for all  $0 < k < n$  and
- (2)  $h^n(J^{(i)}) = C_\delta^{(j)}$ .

In other words, we have:

$q$ : number of connected components of  $\mathbb{S}^1 \setminus C_\delta$  ( $q \geq 1$ );

$n(i)$ : number of interactions needed to  $J^{(i)}$  to intersect the critical set;

$j(i)$ : label of the connected component of the critical set intersected by  $h^{n(i)}(J^{(i)})$ .

Now, for  $\delta > 0$  fixed, define the collection:

$$J_\delta = \left\{ \left( J^{(i)}, n(i), j(i) \right) : 1 \leq i \leq q \right\}$$

We associate a *directed graph*  $\mathcal{P}(J_\delta)$  with  $J_\delta$  as follows:

- the graph  $\mathcal{P}(J_\delta)$  contains  $q$  vertices  $v_1, \dots, v_q$  representing  $c_1, \dots, c_q$ ;
- there exists a directed edge from  $v_i$  to  $v_\ell$  in  $\mathcal{P}(J_\delta)$  if and only if  $j(i) = \ell$ .

According to [15], we define the concept of completely accessible vertex.

*Definition 6.* We say that a vertex  $v_{i_0}$  in  $\mathcal{P}(J_\delta)$  is *completely accessible* if for every  $1 \leq i \leq q$ , there exists a directed path from  $v_i$  to  $v_{i_0}$  in the graph  $\mathcal{P}(J_\delta)$ .

For fixed  $\lambda < \lambda_0/5$  and  $\alpha > 0$  small, let  $\Delta(\lambda, \alpha)$  be the set of  $a \in \mathbb{S}^1$  for which the following conditions hold for a critical point  $c \in C \equiv C(h_a)$ :

$$\text{(CE1): } \text{dist}(h_a^n(c), C) \geq \min\{\delta_0/2, \exp(-\alpha n)\};$$

$$\text{(CE2): } |(h_a^n)'(h_a(c))| \geq 2b_0\delta_0 \exp(\lambda n).$$

These assertions are usually called by  $(\lambda, \alpha)$ -*Collet-Eickmann conditions*. Next lemma says that, in the  $C^3$ -topology, if  $a^* \in \mathbb{S}^1$  is such that  $h_{a^*} \in \mathcal{E}$ , we may “easily” find other values close to  $a^*$  for which  $h_a \in \mathcal{E}$ .

**Lemma 5.4** ([28], adapted). *If  $a^* \in \mathbb{S}^1$  is such that  $h_{a^*} \in \mathcal{E}$  then*

$$\liminf_{r \rightarrow 0^+} \frac{\text{Leb}_1(\Delta(\lambda, \alpha) \cap [a^* - r, a^* + r])}{2r} > 0,$$

where  $\text{Leb}_1$  denotes the usual one-dimensional Lebesgue measure.

**Theorem 5.5** ([15], adapted). *Let  $\{h_a : a \in \mathbb{S}^1\}$  be an admissible family and let  $a^* \in \mathbb{S}^1$  be such that  $h_{a^*} \in \mathcal{E}$ . Fix  $\lambda < \lambda_0/5$ . Then for  $\alpha < \lambda$  sufficiently small, there exists  $\delta_1 > 0$  sufficiently small such that the following holds. If  $h_{a^*}$  admits a collection  $J_\delta$  such that the directed graph  $\mathcal{P}(J_\delta)$  has a completely accessible vertex for some  $\delta < \delta_1$ , then for every  $\hat{a} \in \Delta(\lambda, \alpha)$  sufficiently close to  $a^*$ , there exists a sequence  $a_n$  converging to  $\hat{a}$  such that for every  $n \in \mathbb{N}$ , the map  $h_{a_n}$  admits a periodic sink.*

The periodic sink is *superstable* because it is a critical point for the singular limit ( $\Rightarrow$  one of the Lyapunov multipliers is very close to 0).

## 6. COMPUTATION OF THE FIRST RETURN MAP

For  $\varepsilon > 0$ , in this section we denote by  $B_\varepsilon(O_i)$  the set of points  $X \in \mathcal{V} \subset \mathbb{R}^2$  such that  $\|X - O_i\| < \varepsilon$ . When the phase space of (2.2) is augmented with a  $\mathbb{S}^1$  factor, the hyperbolic saddles  $O_1$  and  $O_2$  of (2.1) become hyperbolic periodic solutions that we call by  $\mathbf{C}_1$  and  $\mathbf{C}_2$ . These hyperbolic periodic orbits persist for  $\mu = (\mu_1, \mu_2)$  sufficiently small (in the  $C^k$ -norm,  $k \geq 3$ ). By [25], under hypotheses **(P1)**–**(P5)**, there exist  $\varepsilon_0, \mu_0 > 0$  and a  $\mu$ -dependent coordinate system  $(x, y, \theta)$  defined on the open set  $V_i = B_{\varepsilon_0}(O_i) \times \mathbb{S}^1$  such that for every  $\mu = (\mu_1, \mu_2) \in [0, \mu_0] \times [0, \mu_0]$ , we may write

$$\mathbf{C}_i = \left\{ \left( x_1^{(i)}, x_2^{(i)}, \theta^{(i)} \right) : x_1^{(i)} = x_2^{(i)} = 0, \quad \theta^{(i)} \in \mathbb{S}^1 \right\}$$

and the stable and unstable manifolds are locally flat:

$$W^s(\mathbf{C}_i) \cap V_i \subset \left\{ \left( x_1^{(i)}, x_2^{(i)}, \theta^{(i)} \right) : x_2^{(i)} = 0, \quad \theta^{(i)} \in \mathbb{S}^1 \right\}$$

and

$$W^u(\mathbf{C}_i) \cap V_i \subset \left\{ \left( x_1^{(i)}, x_2^{(i)}, \theta^{(i)} \right) : x_1^{(i)} = 0, \quad \theta^{(i)} \in \mathbb{S}^1 \right\}.$$

For  $\mu \in ]0, \mu_0[ \times ]0, \mu_0[$  define the cross sections:

$$\text{In}(\mathbf{C}_1) = \left\{ \left( x_1^{(1)}, x_2^{(1)}, \theta^{(1)} \right) : x_1^{(1)} = \varepsilon_0, \quad -\|\mu\|/C_1 \leq x_2^{(1)} \leq C_1\|\mu\|, \quad \theta^{(1)} \in \mathbb{S}^1 \right\}$$

$$\text{Out}(\mathbf{C}_1) = \left\{ \left( x_1^{(1)}, x_2^{(1)}, \theta^{(1)} \right) : x_2^{(1)} = \varepsilon_0, \quad 0 \leq x_1^{(1)} \leq C'_1\|\mu\|, \quad \theta^{(1)} \in \mathbb{S}^1 \right\}$$

$$\text{In}(\mathbf{C}_2) = \left\{ \left( x_1^{(2)}, x_2^{(2)}, \theta^{(2)} \right) : x_1^{(2)} = \varepsilon_0, \quad -\|\mu\|/C_2 \leq x_2^{(2)} \leq C_2\|\mu\|, \quad \theta^{(2)} \in \mathbb{S}^1 \right\}$$

$$\text{Out}(\mathbf{C}_2) = \left\{ \left( x_1^{(2)}, x_2^{(2)}, \theta^{(2)} \right) : x_2^{(2)} = \varepsilon_0, \quad -\|\mu\|/C'_2 \leq x_1^{(2)} \leq C'_2\|\mu\|, \quad \theta^{(2)} \in \mathbb{S}^1 \right\}$$

where the constants  $C_i > 0$  are suitably chosen and  $C'_i$  satisfy  $C'_i\mu_0 \ll \varepsilon_0$ .

**6.1. Magnified coordinates.** For  $\mu = (\mu_1, \mu_2) \in ]0, \mu_0[ \times ]0, \mu_0[$ , we make following change of coordinates:

$$\left( \|\mu\| y_1^{(1)}, \|\mu\| y_2^{(1)}, \theta^{(1)} \right) \mapsto \left( x_1^{(1)}, x_2^{(1)}, \theta^{(1)} \right) \quad (6.1)$$

and

$$\left( \|\mu\| y_1^{(2)}, \|\mu\| y_2^{(2)}, \theta^{(2)} \right) \mapsto \left( x_1^{(2)}, x_2^{(2)}, \theta^{(2)} \right) \quad (6.2)$$

and therefore we obtain (see Table 2):

$$\text{In}(\mathbf{C}_1) = \left\{ \left( y_1^{(1)}, y_2^{(1)}, \theta^{(1)} \right) : y_1^{(1)} = \varepsilon_0/\|\mu\|, \quad -1/C_1 \leq y_2^{(1)} \leq C_1, \quad \theta^{(1)} \in \mathbb{S}^1 \right\}$$

$$\text{Out}(\mathbf{C}_1) = \left\{ \left( y_1^{(1)}, y_2^{(1)}, \theta^{(1)} \right) : y_2^{(1)} = \varepsilon_0/\|\mu\|, \quad 0 \leq y_1^{(1)} \leq C'_1, \quad \theta^{(1)} \in \mathbb{S}^1 \right\}$$

$$\text{In}(\mathbf{C}_2) = \left\{ \left( y_1^{(2)}, y_2^{(2)}, \theta^{(2)} \right) : y_1^{(2)} = \varepsilon_0/\|\mu\|, \quad -1/C_2 \leq y_2^{(2)} \leq C_2, \quad \theta^{(2)} \in \mathbb{S}^1 \right\}$$

$$\text{Out}(\mathbf{C}_2) = \left\{ \left( y_1^{(2)}, y_2^{(2)}, \theta^{(2)} \right) : y_2^{(2)} = \varepsilon_0/\|\mu\|, \quad -1/C'_2 \leq y_1^{(2)} \leq C'_2, \quad \theta^{(2)} \in \mathbb{S}^1 \right\}.$$



Set	Notation	Set	Notation
$\text{In}(\mathbf{C}_1)$	$(y_1^{(1)}, y_2^{(1)}, \theta^{(1)})$	$\text{In}(\mathbf{C}_2)$	$(y_1^{(2)}, y_2^{(2)}, \theta^{(2)})$
$\text{Out}(\mathbf{C}_1)$	$(\bar{y}_1^{(1)}, \bar{y}_2^{(1)}, \bar{\theta}^{(1)})$	$\text{Out}(\mathbf{C}_2)$	$(\bar{y}_1^{(2)}, \bar{y}_2^{(2)}, \bar{\theta}^{(2)})$

TABLE 2. Coordinates and notation of the cross sections after the change of coordinates (6.1) and (6.2).

For  $i \in \{1, 2\}$ , the sets  $\text{In}(\mathbf{C}_i)$  may be divided as follows:

$$\text{In}(\mathbf{C}_i) = \text{In}^+(\mathbf{C}_i) \dot{\cup} W^s(\mathbf{C}_i) \dot{\cup} \text{In}^-(\mathbf{C}_i),$$

according to the sign of the  $y_2^{(i)}$  coordinate: positive (negative) for initial conditions in  $\text{In}^+(\mathbf{C}_i)$  ( $\text{In}^-(\mathbf{C}_i)$ ), zero for initial conditions in  $W^s(\mathbf{C}_i)$ . We define analogously the sets  $\text{Out}^+(\mathbf{C}_2)$  and  $\text{Out}^-(\mathbf{C}_2)$ .

For  $i \in \{1, 2\}$ , we start by computing a normal form for (2.3) valid in  $V_i \times ]0, \mu_0]^2$  and the associated local map near  $\mathbf{C}_i$ , say

$$\text{Loc}_i : \text{In}(\mathbf{C}_i) \setminus W^s(\mathbf{C}_i) \rightarrow \text{Out}(\mathbf{C}_i).$$

The notation  $\|\star\|_{\mathcal{C}^3}$  denote the  $C^3$ -norm defined for maps defined in  $V_i \times ]0, \mu_0]^2$ . Recall that  $V_i = B_{\varepsilon_0}(O_i) \times \mathbb{S}^1$  is a genus two torus.

**Proposition 6.1** ([25], adapted). *System (2.3) may be written, in terms of coordinates  $(y_1^{(i)}, y_2^{(i)}, \theta^{(i)})$  on  $V_i \times [0, \mu_0]^2$ , in the following form:*

$$\begin{cases} \dot{y}_1^{(i)} = \left(-c_i + \|\mu\| g_1 \left(y_1^{(i)}, y_2^{(i)}, \theta^{(i)}; \mu\right)\right) y_1^{(i)} \\ \dot{y}_2^{(i)} = \left(e_i + \|\mu\| g_2 \left(y_1^{(i)}, y_2^{(i)}, \theta^{(i)}; \mu\right)\right) y_2^{(i)} \\ \dot{\theta}^{(i)} = \omega \end{cases} \quad (6.3)$$

There exists  $K_1 \in \mathbb{R}^+$  such that the maps  $g_1, g_2$  are analytic on  $V_i \times ]0, \mu_0]$  and satisfies  $\|g_1\|_{\mathcal{C}^3}, \|g_2\|_{\mathcal{C}^3} \leq K_1$ ,  $i \in \{1, 2\}$ .

Notice that, by construction,  $\mathbb{V}^*$  is a neighbourhood of  $\Gamma = \mathcal{L}_1 \cup \mathcal{L}_2$  such that all solutions starting at  $\mathbb{V}^*$  remain inside  $\mathbb{V}^*$  for all positive  $t$ .

For  $\mu = (\mu_1, \mu_2) \in ]0, \mu_0]^2$ , let  $q_0^{(i)} = (y_1^{(i)}(0), y_2^{(i)}(0), \theta^{(i)}(0)) \in \mathbb{V}^* \cap \text{In}(\mathbf{C}_i) \setminus W^s(\mathbf{C}_i)$  and let

$$q^{(i)}(t, q_0^{(i)}; \mu) = \left[ y_1^{(i)}(t, q_0^{(i)}; \mu), y_2^{(i)}(t, q_0^{(i)}; \mu), \theta^{(i)}(t, q_0^{(i)}; \mu) \right], \quad t \geq 0$$

denote the unique solution of (6.3) with  $q^{(i)}(0, q_0^{(i)}; \mu) = q_0^{(i)}$  (initial condition). Integrating (6.3), we may write:

$$\begin{cases} y_1^{(i)}(t, q_0^{(i)}; \mu) = y_1^{(i)}(0) \exp \int_0^t [-c_i + \|\mu\| g_1^{(i)}(q^{(i)}(s, q_0^{(i)}; \mu))] ds \\ y_2^{(i)}(t, q_0^{(i)}; \mu) = y_2^{(i)}(0) \exp \int_0^t [e_i + \|\mu\| g_2^{(i)}(q^{(i)}(s, q_0^{(i)}; \mu))] ds \\ \theta^{(i)}(t, q_0^{(i)}; \mu) = \theta_0^{(i)} + \omega t. \end{cases} \quad (6.4)$$

The expression (6.4) may be rephrased as:

$$\begin{cases} y_1^{(i)}(t, q_0, \mu) = y_1^{(i)}(0) \exp \left( t \left[ -c_i + w_1^{(i)}(t, q_0^{(i)}; \mu) \right] \right) \\ y_2^{(i)}(t, q_0, \mu) = y_2^{(i)}(0) \exp \left( t \left[ e_i + w_2^{(i)}(t, q_0^{(i)}; \mu) \right] \right) \\ \theta^{(i)}(t, q_0; \mu) = \theta_0^{(i)} + \omega t \end{cases} \quad (6.5)$$

where

$$w_j^{(i)}(t, q_0^{(i)}; \mu) = \frac{1}{t} \int_0^t \|\mu\| g_j^{(i)}(q^{(i)}(s, q_0^{(i)}; \mu); \mu) ds, \quad \text{for } j \in \{1, 2\}. \quad (6.6)$$

The next result establishes the  $C^3$ -control of  $w_j$  on  $V_i \times ]0, \mu_0]^2$ ,  $i, j \in \{1, 2\}$ .

**Proposition 6.2** ([25], adapted). *For  $j \in 1, 2$ , there exists  $K_2 \in \mathbb{R}^+$  such that the following holds: for any  $T^* > 1$  such that all solutions of (2.3) that start in  $(\text{In}(\mathbf{C}_j) \setminus W^s(\mathbf{C}_j)) \cap \mathbb{V}^*$  remain in  $V_i$  up to time  $T^*$ , we have  $\|w_j\|_{C^3} \leq K_2 \mu$ .*

Let  $q_0^{(i)} \in \text{In}(\mathbf{C}_i) \setminus W^s(\mathbf{C}_i)$  and  $\mu = (\mu_1, \mu_2) \in ]0, \mu_0]^2$ . The time of flight  $T \equiv T(q_0^{(i)}; \mu)$  inside  $V_i$  may be determined explicitly by solving the equation:

$$\varepsilon_0 / \|\mu\| = y_2^{(i)}(0) \exp \left( T \left( e_i + w_2^{(i)}(T, q_0^{(i)}; \mu) \right) \right),$$

from where we deduce that

$$T \equiv T(q_0^{(i)}; \mu) = \frac{1}{e_i + w_2^{(i)}(T, q_0^{(i)}; \mu)} \ln \left( \frac{\varepsilon_0}{\|\mu\| y_2^{(i)}(0)} \right).$$

Proposition 5.7 and Lemma 7.4 of [25] provide a precise control of  $T$ , in the  $C^3$ -norm (check the last paragraph of [25, Sec. 7]).

**6.2. Local map.** For  $i \in \{1, 2\}$ , from now on, let us omit the constant components of the cross sections  $\text{In}^+(\mathbf{C}_i)$  and  $\text{Out}(\mathbf{C}_i)$ . More specifically, let us use the covers (see Table 2):

$$\text{In}(\mathbf{C}_i) : \left( y_1^{(i)}, y_2^{(i)}, \theta^{(i)} \right) \mapsto \left( y_2^{(i)}, \theta^{(i)} \right)$$

and

$$\text{Out}(\mathbf{C}_i) : \left( \bar{y}_1^{(i)}, \bar{y}_2^{(i)}, \bar{\theta}^{(i)} \right) \mapsto \left( \bar{y}_1^{(i)}, \bar{\theta}^{(i)} \right).$$

The local map  $Loc_i$  near  $\mathbf{C}_i$  sends  $(y_2^{(i)}, \theta^{(i)}) \in \text{In}^+(\mathbf{C}_i)$  to coordinates  $(\bar{y}_1^{(i)}, \bar{\theta}^{(i)})$  in  $\text{Out}(\mathbf{C}_i)$  and it is given by:

$$\begin{aligned}\bar{y}_1^{(i)} &= \frac{\varepsilon_0}{\|\mu\|} \left[ \frac{\varepsilon_0}{\|\mu\| y_2^{(i)}} \right]^{-\delta_i} \\ \bar{\theta}^{(i)} &= \theta^{(i)} + \frac{\omega}{e_i + w_2^{(i)}} \ln \left( \frac{\varepsilon_0}{\|\mu\| y_2^{(i)}} \right),\end{aligned}\tag{6.7}$$

where

$$\delta_i \equiv \delta_i \left( t, q_0^{(i)}; \mu \right) = \frac{c_i + w_1^{(i)}}{e_i + w_2^{(i)}} > 1.\tag{6.8}$$

These formulas will be simplified later. Note that  $\lim_{(\mu_1, \mu_2) \rightarrow (0,0)} \delta_i \left( t, q_0^{(i)}; \mu \right) = c_i/e_i > 1$ .

A corresponding map can be constructed from  $\text{In}^-(\mathbf{C}_i)$  to  $\text{Out}(\mathbf{C}_i)$ , but we are interested in trajectories following the heteroclinic cycle  $\Gamma$  in the positive  $y_2^{(i)}$ -direction.

**6.3. The global map.** We assume that for  $\mu = (\mu_1, \mu_2) \in ]0, \mu_0]^2$ , the flow generated by (2.3) induces a map from  $\text{Out}(\mathbf{C}_i)$  into  $\text{In}(\mathbf{C}_{i+1})$  satisfying conditions **(P7a)** and **(P7b)** – see Figure 5. The global map  $\Psi_{1 \rightarrow 2} : \text{Out}(\mathbf{C}_1) \rightarrow \text{In}(\mathbf{C}_2)$  is given in the rescaled coordinates defined in Subsection 6.1, by:

$$\begin{aligned}y_2^{(2)} &= b_1 \bar{y}_1^{(1)} + \frac{\mu_1}{\|\mu\|} \phi_1 \left( \bar{y}_1^{(1)}, \bar{\theta}^{(1)} \right) \\ \theta^{(2)} &= \bar{\theta}^{(1)} + \xi_1 + \mu_1 \psi_1 \left( \bar{y}_1^{(1)}, \bar{\theta}^{(1)} \right),\end{aligned}\tag{6.9}$$

where  $b_1 \neq 0$ ,  $\phi_1 \left( \bar{y}_1^{(1)}, \bar{\theta}^{(1)} \right) = \Phi_1 \left( \|\mu\| \bar{y}_1^{(1)}, \bar{\theta}^{(1)} \right)$  and  $\psi_1 \left( \bar{y}_1^{(1)}, \bar{\theta}^{(1)} \right) = \Psi_1 \left( \|\mu\| \bar{y}_1^{(1)}, \bar{\theta}^{(1)} \right)$ , for  $\Phi_1, \Psi_1$  are the maps defined in **(P7a)**. Analogously, the global map  $\Psi_{2 \rightarrow 1} : \text{Out}(\mathbf{C}_2) \rightarrow \text{In}(\mathbf{C}_1)$  is given in the rescaled coordinates by:

$$\begin{aligned}y_2^{(1)} &= b_2 \bar{y}_1^{(2)} + \frac{\mu_2}{\|\mu\|} \phi_2 \left( \bar{y}_1^{(2)}, \bar{\theta}^{(2)} \right) \\ \theta^{(1)} &= \bar{\theta}^{(2)} + \xi_2 + \mu_2 \psi_2 \left( \bar{y}_1^{(2)}, \bar{\theta}^{(2)} \right),\end{aligned}\tag{6.10}$$

for  $b_2 \neq 0$ ,  $\phi_2 \left( \bar{y}_1^{(2)}, \bar{\theta}^{(2)} \right) = \Phi_2 \left( \|\mu\| \bar{y}_1^{(2)}, \bar{\theta}^{(2)} \right)$  and  $\psi_2 \left( \bar{y}_1^{(2)}, \bar{\theta}^{(2)} \right) = \Psi_2 \left( \|\mu\| \bar{y}_1^{(2)}, \bar{\theta}^{(2)} \right)$ , where  $\Phi_2, \Psi_2$  are the maps defined in **(P7b)**.

*Remark 6.3.* At this stage, we may need to slightly change the positive constants  $C_1, C_2, C'_1$  and  $C'_2$  in order that the global maps are well defined (this would correspond to “shrink” the domain of definition of  $\Psi_{1 \rightarrow 2}$  and  $\Psi_{2 \rightarrow 1}$ ). We omit this technicality.

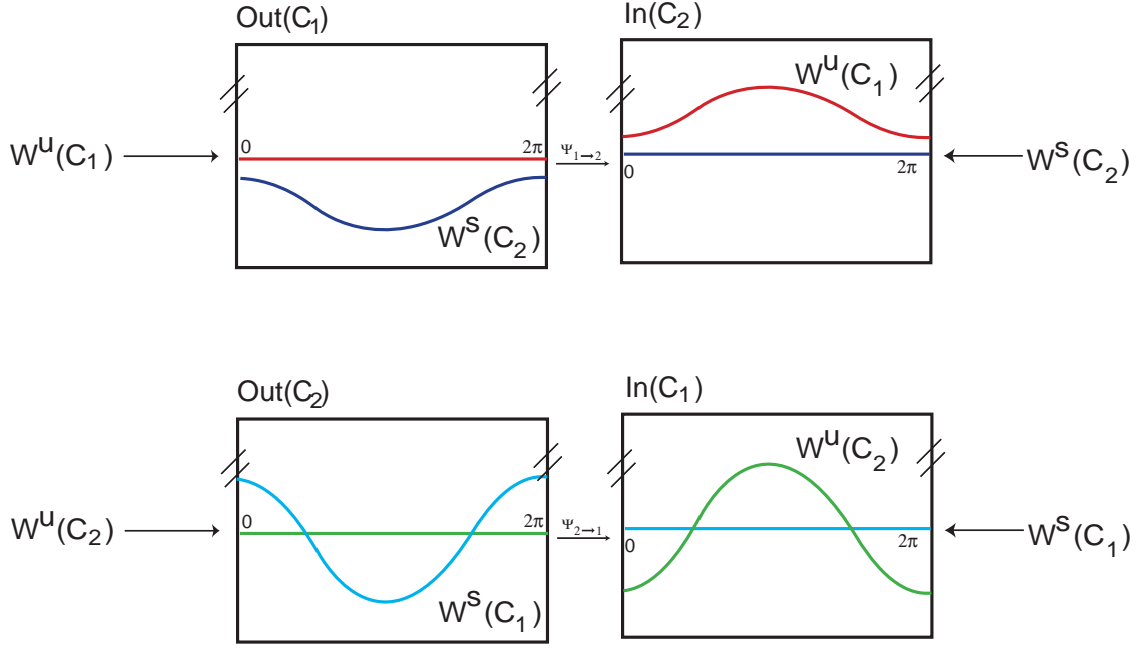

FIGURE 5. Transition maps from  $\text{Out}(\mathbf{C}_1)$  to  $\text{In}(\mathbf{C}_2)$  (Case I) and from  $\text{Out}(\mathbf{C}_2)$  to  $\text{In}(\mathbf{C}_1)$  (Case II). In Case I:  $W^u(\mathbf{C}_1) \cap W^s(\mathbf{C}_2) = \emptyset$ . In Case II:  $W^u(\mathbf{C}_2) \pitchfork W^s(\mathbf{C}_1)$ . Double bars mean that the sides are identified.

**6.4. First return maps to a cross section.** For the flow of (2.3), the first return map to  $\text{Out}^+(\mathbf{C}_1)$ ,

$$\mathcal{F}_{(\mu_1,0)} = \text{Loc}_1 \circ \Psi_{2 \rightarrow 1} \circ \text{Loc}_2 \circ \Psi_{1 \rightarrow 2} : \text{Out}^+(\mathbf{C}_1) \rightarrow \text{Out}(\mathbf{C}_1)$$

is then given by

$$\mathcal{F}_{(\mu_1,0)} \left( \bar{y}_1^{(1)}, \bar{\theta}^{(1)} \right) = (\mathcal{F}_1, \mathcal{F}_2)$$

where

$$\mathcal{F}_1 = \varepsilon_0^{1-\delta_1} \|\mu\|^{\delta_1-1} \left[ b_2 \varepsilon_0^{1-\delta_2} \|\mu\|^{\delta_2-1} \left[ b_1 \bar{y}_1^{(1)} + \frac{\mu_1}{\|\mu\|} \phi_1 \left( \bar{y}_1^{(1)}, \bar{\theta}^{(1)} \right) \right]^{\delta_2} + \frac{\mu_2}{\|\mu\|} \phi_2 \left( \bar{y}_1^{(2)}, \bar{\theta}^{(2)} \right) \right]^{\delta_1}$$

$$\begin{aligned} \mathcal{F}_2 = & \bar{\theta}^{(1)} + \xi_1 + \xi_2 + \mu_1 \psi_1 \left( \bar{y}_1^{(1)}, \bar{\theta}^{(1)} \right) + \mu_2 \psi_2 \left( \bar{y}_1^{(2)}, \bar{\theta}^{(2)} \right) - \left( \frac{\omega}{e_2 + \omega_2^{(2)}} + \frac{\omega}{e_1 + \omega_2^{(1)}} \right) \ln \left( \frac{\|\mu\|}{\varepsilon_0} \right) \\ & - \frac{\omega}{e_2 + \omega_2^{(2)}} \ln \left[ b_1 \bar{y}_1^{(1)} + \frac{\mu_1}{\|\mu\|} \phi_1 \left( \bar{y}_1^{(1)}, \bar{\theta}^{(1)} \right) \right] \\ & - \frac{\omega}{e_1 + \omega_2^{(1)}} \ln \left[ b_2 \varepsilon_0^{1-\delta_2} \|\mu\|^{\delta_2-1} \left[ b_1 \bar{y}_1^{(1)} + \frac{\mu_1}{\|\mu\|} \phi_1 \left( \bar{y}_1^{(1)}, \bar{\theta}^{(1)} \right) \right]^{\delta_2} + \frac{\mu_2}{\|\mu\|} \phi_2 \left( \bar{y}_1^{(2)}, \bar{\theta}^{(2)} \right) \right]. \end{aligned}$$

The first return map to  $\text{Out}(\mathbf{C}_2)$ ,  $\mathcal{G}_{(0,\mu_2)} = \text{Loc}_1 \circ \Psi_{1 \rightarrow 2} \circ \text{Loc}_1 \circ \Psi_{2 \rightarrow 1} : \text{Out}(\mathbf{C}_2) \rightarrow \text{Out}(\mathbf{C}_2)$  is given by

$$\mathcal{G}_{(0,\mu_2)} \left( \bar{y}_1^{(2)}, \bar{\theta}^{(2)} \right) = (\mathcal{G}_1, \mathcal{G}_2)$$

where

$$\begin{aligned} \mathcal{G}_1 &= \frac{\varepsilon_0}{\|\mu\|} \left[ b_1 \left( \frac{\|\mu\|}{\varepsilon_0} \right)^{\delta_1} \left[ b_2 \bar{y}_1^{(2)} + \frac{\mu_2}{\|\mu\|} \phi_2 \left( \bar{y}_1^{(2)}, \bar{\theta}^{(2)} \right) \right]^{\delta_1} + \frac{\mu_1}{\|\mu\|} \phi_1 \left( \bar{y}_1^{(1)}, \bar{\theta}^{(1)} \right) \right]^{\delta_2} \\ \mathcal{G}_2 &= \bar{\theta}^{(2)} + \xi_1 + \xi_2 + \mu_2 \psi_2 \left( \bar{y}_1^{(2)}, \bar{\theta}^{(2)} \right) + \mu_1 \psi_1 \left( \bar{y}_1^{(1)}, \bar{\theta}^{(1)} \right) - \left( \frac{\omega}{e_1 + \omega_2^{(1)}} + \frac{\omega}{e_2 + \omega_2^{(2)}} \right) \ln \left( \frac{\|\mu\|}{\varepsilon_0} \right) \\ &\quad - \frac{\omega}{e_1 + \omega_2^{(1)}} \ln \left[ b_2 \bar{y}_1^{(2)} + \frac{\mu_2}{\|\mu\|} \phi_2 \left( \bar{y}_1^{(2)}, \bar{\theta}^{(2)} \right) \right] \\ &\quad - \frac{\omega}{e_2 + \omega_2^{(2)}} \ln \left[ b_1 \varepsilon_0^{1-\delta_1} \|\mu\|^{\delta_1-1} \left[ b_2 \bar{y}_1^{(2)} + \frac{\mu_2}{\|\mu\|} \phi_2 \left( \bar{y}_1^{(2)}, \bar{\theta}^{(2)} \right) \right]^{\delta_1} + \frac{\mu_1}{\|\mu\|} \phi_1 \left( \bar{y}_1^{(1)}, \bar{\theta}^{(1)} \right) \right]. \end{aligned}$$

**6.5. Simplified model for the return maps  $\mathcal{F}_{(\mu_1,0)}$  and  $\mathcal{G}_{(0,\mu_2)}$ .** In what follows we assume, without loss of generality, that  $b_1 = b_2 = \varepsilon_0 = 1$ . This assumption simplifies the formulas and do not restrict the generality of the results.

**Lemma 6.4.** *If  $b_1 = b_2 = \varepsilon_0 = 1$ , then the first return map  $\mathcal{F}_{(\mu_1,0)}$  to  $Out(\mathbf{C}_1)$  may be written as  $\mathcal{F}_{(\mu_1,0)} = (\mathcal{F}_1, \mathcal{F}_2)$  where:*

$$\begin{aligned} \mathcal{F}_1 &= \mu_1^{\delta-1} \left[ \bar{y}_1^{(1)} + \phi_1 \left( \bar{y}_1^{(1)}, \bar{\theta}^{(1)} \right) \right]^{\delta} \\ \mathcal{F}_2 &= \bar{\theta}^{(1)} + \xi + \mu_1 \psi_1 \left( \bar{y}_1^{(1)}, \bar{\theta}^{(1)} \right) - \omega K_F \ln(\mu_1) - \omega K_F \ln \left[ \bar{y}_1^{(1)} + \phi_1 \left( \bar{y}_1^{(1)}, \bar{\theta}^{(1)} \right) \right] \end{aligned}$$

with  $\delta = \delta_1 \delta_2$  <sup>(4)</sup>,  $\xi = \xi_1 + \xi_2$  and  $K_F = \frac{1}{e_2 + \omega_2^{(2)}} + \frac{\delta_2}{e_1 + \omega_2^{(1)}}$ , where  $\omega_2^{(1)}$  and  $\omega_2^{(2)}$  are the integrals defined in (6.5).

*Proof.* First of all note that when  $\mu_1 > 0$  and  $\mu_2 = 0$ , then  $\|\mu\| = \mu_1$ . Using the results of §6.4, the first return map  $\mathcal{F}_{(\mu_1,0)} = Loc_1 \circ \Psi_{2 \rightarrow 1} \circ Loc_2 \circ \Psi_{1 \rightarrow 2}$  is given by

$$\mathcal{F}_{(\mu_1,0)} \left( \bar{y}_1^{(1)}, \bar{\theta}^{(1)} \right) = (\mathcal{F}_1, \mathcal{F}_2)$$

where

$$\mathcal{F}_1 = \mu_1^{\delta-1} \left[ \bar{y}_1^{(1)} + \phi_1 \left( \bar{y}_1^{(1)}, \bar{\theta}^{(1)} \right) \right]^{\delta}.$$

---

<sup>4</sup>See equation (6.8) for the definitions of  $\delta_1$  and  $\delta_2$ .

Simplifying expression of  $\mathcal{F}_2$  given in §6.4, we get:

$$\begin{aligned}
\mathcal{F}_2 &= \bar{\theta}^{(1)} + \xi_1 + \xi_2 + \mu_1 \psi_1 \left( \bar{y}_1^{(1)}, \bar{\theta}^{(1)} \right) - \left( \frac{\omega}{e_2 + \omega_2^{(2)}} + \frac{\omega}{e_1 + \omega_2^{(1)}} \right) \ln(\mu_1) \\
&\quad - \frac{\omega}{e_2 + \omega_2^{(2)}} \ln \left[ \bar{y}_1^{(1)} + \phi_1 \left( \bar{y}_1^{(1)}, \bar{\theta}^{(1)} \right) \right] \\
&\quad - \frac{\omega}{e_1 + \omega_2^{(1)}} \ln \left[ \mu_1^{\delta_2 - 1} \left[ \bar{y}_1^{(1)} + \phi_1 \left( \bar{y}_1^{(1)}, \bar{\theta}^{(1)} \right) \right]^{\delta_2} \right] \\
&= \bar{\theta}^{(1)} + \xi_1 + \xi_2 + \mu_1 \psi_1 \left( \bar{y}_1^{(1)}, \bar{\theta}^{(1)} \right) - \left( \frac{\omega}{e_2 + \omega_2^{(2)}} + \frac{\omega \delta_2}{e_1 + \omega_2^{(1)}} \right) \ln(\mu_1) \\
&\quad - \left( \frac{\omega}{e_2 + \omega_2^{(2)}} + \frac{\omega \delta_2}{e_1 + \omega_2^{(2)}} \right) \ln \left[ \bar{y}_1^{(1)} + \phi_1 \left( \bar{y}_1^{(1)}, \bar{\theta}^{(1)} \right) \right] \\
&= \bar{\theta}^{(1)} + \xi + \mu_1 \psi_1 \left( \bar{y}_1^{(1)}, \bar{\theta}^{(1)} \right) - \omega K_F \ln(\mu_1) - \omega K_F \ln \left[ \bar{y}_1^{(1)} + \phi_1 \left( \bar{y}_1^{(1)}, \bar{\theta}^{(1)} \right) \right]
\end{aligned}$$

where  $\xi$  and  $K_F$  are as stated. □

**Lemma 6.5.** *If  $b_1 = b_2 = \varepsilon_0 = 1$ , then the first return map  $\mathcal{G}_{(0, \mu_2)}$  to  $\text{Out}(C_2) \setminus W^s(C_2)$  may be written as  $\mathcal{G}_{(0, \mu_2)} = (\mathcal{G}_1, \mathcal{G}_2)$  where:*

$$\begin{aligned}
\mathcal{G}_1 &= \mu_2^{\delta_2 - 1} \left[ \bar{y}_1^{(2)} + \phi_2 \left( \bar{y}_1^{(2)}, \bar{\theta}^{(2)} \right) \right]^{\delta_2} \\
\mathcal{G}_2 &= \bar{\theta}^{(2)} + \xi + \mu_2 \psi_2 \left( \bar{y}_1^{(2)}, \bar{\theta}^{(2)} \right) - \omega K_G \ln(\mu_2) - \omega K_G \ln \left[ \bar{y}_1^{(2)} + \phi_2 \left( \bar{y}_1^{(2)}, \bar{\theta}^{(2)} \right) \right]
\end{aligned}$$

where  $\xi = \xi_1 + \xi_2$  and  $K_G = \frac{1}{e_1 + \omega_2^{(1)}} + \frac{\delta_1}{e_2 + \omega_2^{(2)}}$ .

We omit the proof of Lemma 6.5 since it is similar to that of Lemma 6.4.

*Remark 6.6.* Using the integrals defined in (6.6), note that when  $\mu_1 = \mu_2 = 0$ , the formulas  $\omega_2^{(1)} = \omega_2^{(2)} \equiv 0$ . For this case, we obtain formulas (3.1):

$$K_F = \frac{1}{e_2} + \frac{\delta_2}{e_1} = \frac{e_1 + c_2}{e_1 e_2} \neq 0 \quad \text{and} \quad K_G = \frac{1}{e_1} + \frac{\delta_1}{e_2} = \frac{e_2 + c_1}{e_1 e_2} \neq 0.$$

In order to improve the readability of the manuscript, we use the terminology of Table 3 in the Sections 7–10:

## 7. PROOFS OF THEOREMS A AND B

This case reports the scenario described by  $\mu_1 > 0$  and  $\mu_2 = 0$ . This is why we use the first return map  $\mathcal{F}_{(\mu_1, 0)} \mapsto \mathcal{F}_\mu$  (cf. Table 3).

**7.1. The singular limit.** Let  $k : \mathbb{R}^+ \rightarrow \mathbb{R}$  be the invertible map defined by

$$k(x) = -\omega K_F \ln(x).$$

For  $\mu_0 < \varepsilon$ , define now the decreasing sequence  $(\mu_n)_n$  such that, for all  $n \in \mathbb{N}$ , we have:

$\mathcal{F}_{(\mu_1,0)} \mapsto \mathcal{F}_\mu$	Sections 7 and 8
$\mathcal{G}_{(0,\mu_2)} \mapsto \mathcal{G}_\mu$	Sections 9 and 10

TABLE 3. Notation for the next sections where  $\mu_1, \mu_2 \in ]0, \varepsilon]$ .

- (1)  $\mu_n \in ]0, \mu_0[$  and
- (2)  $k(\mu_n) \equiv 0 \pmod{2\pi}$ .

Since  $k$  is an invertible map, for  $a \in \mathbb{S}^1$  fixed and  $n \geq n_0 \in \mathbb{N}$ , let

$$\mu_{(a,n)} = k^{-1}(k(\mu_n) + a) \in ]0, \mu_0[. \quad (7.1)$$

It is easy to check that:

$$k(\mu_{(a,n)}) = -\omega K_F \ln(\mu_n) + a = a \pmod{2\pi}. \quad (7.2)$$

Define  $\mathcal{F}_{(a,\mu_{(a,n)})}$  as  $\mathcal{F}_{\mu_{(a,n)}}$ . The following proposition establishes  $\mathbf{C}^3$ -convergence to a singular limit as  $n \rightarrow +\infty$ .

**Lemma 7.1.** *In the  $C^3$ -norm, for  $a \in \mathbb{S}^1$ , the following equality holds:*

$$\lim_{n \in \mathbb{N}} \|\mathcal{F}_{(a,\mu_{(a,n)})} - (\mathbf{0}, h_a)\| = 0$$

where  $\mathbf{0}$  is the null map and

$$h_a(\bar{\theta}^{(1)}) = \bar{\theta}^{(1)} + \xi + a - \omega K_F \ln \left[ \phi_1 \left( 0, \bar{\theta}^{(1)} \right) \right]. \quad (7.3)$$

*Proof.* The proof of this lemma follows from the fact that  $k(\mu_{(a,n)}) = a \pmod{2\pi}$ . The  $C^3$ -convergence is a consequence of Hypothesis **(P2)**, Proposition 6.1 and Lemma 6.4. See also Lemma 7.4 of [25].  $\square$

*Remark 7.2.* The map  $h_a(\theta^{(1)}) = \theta^{(1)} + \xi + a - \omega K_F \ln(\phi_1(\theta^{(1)})) \equiv \mathcal{F}_{(a,\mu_{(a,n)})}^1(0, \theta^{(1)})$  is a Morse function with finitely many nondegenerate critical points (by Hypothesis **(P7a)**).

**7.2. Verification of the hypotheses of the theory of rank-one maps.** From now on, our focus will be the sequence of two-dimensional maps

$$\mathcal{F}_{(a,b)} = \mathcal{F}_{(a,\mu_{(a,n)})} \quad \text{with} \quad n \in \mathbb{N} \quad \text{and} \quad a \in \mathbb{S}^1 \text{ fixed.} \quad (7.4)$$

Since our starting point is an attracting heteroclinic cycle (for  $\mu_1 = \mu_2 = 0$ ), the *absorbing sets* defined in Subsection 2.4 of [26] follow from the existence of the attracting annular region. Now, we show that the family of maps (7.4) satisfies Hypotheses **(H1)**–**(H6)** stated in Subsection 5.3.



**(H1):** The first two items are immediate. We establish the distortion bound **(H1)(3)** by studying  $D\mathcal{F}_{(a,\mu(n,a))}$ . Direct computation implies that for every  $\mu \in (0, \tilde{\mu})$  and  $(\bar{y}_1^{(1)}, \bar{\theta}^{(1)}) \in \text{Out}(\mathbf{C}_1) \cap \mathbb{V}^*$ , one gets:

$$|\det D\mathcal{F}_{(a,\mu(n,a))}(\bar{y}_1^{(1)}, \bar{\theta}^{(1)})| = |\det \text{Loc}_1| |\det \Psi_{2 \rightarrow 1}| |\det \text{Loc}_2| |\det \Psi_{1 \rightarrow 2}|$$

where

$$\begin{aligned} \left| \det \Psi_{1 \rightarrow 2}(\bar{y}_1^{(1)}, \bar{\theta}^{(1)}) \right| &= \left| \left( b_1 + \frac{\partial \phi_1}{\partial y} \right) \left( 1 + \mu_1 \frac{\partial \Psi_1}{\partial \theta^{(1)}} \right) - \mu_1 \frac{\partial \psi_1}{\partial \bar{y}^{(1)}} \frac{\partial \phi_1}{\partial \bar{\theta}^{(1)}} \right| \\ \left| \det \text{Loc}_2(y_2^{(2)}, \theta^{(2)}) \right| &= \left| \mu_1^{\delta_2 - 1} (y_2^{(2)})^{\delta_2 - 1} \right| \\ \left| \det \Psi_{2 \rightarrow 1}(\bar{y}_1^{(2)}, \bar{\theta}^{(2)}) \right| &= \left| \left( b_2 + \frac{\partial \phi_2}{\partial y} \right) \left( 1 + \mu_1 \frac{\partial \Psi_2}{\partial \theta^{(1)}} \right) - \mu_1 \frac{\partial \psi_2}{\partial \bar{y}^{(2)}} \frac{\partial \phi_2}{\partial \bar{\theta}^{(2)}} \right| \\ \left| \det \text{Loc}_1(y_2^{(1)}, \theta^{(1)}) \right| &= \left| \mu_1^{\delta_1 - 1} (y_2^{(1)})^{\delta_1 - 1} \right| \end{aligned}$$

Since  $(y_2^{(2)})^{\delta_2 - 1}$ ,  $(y_2^{(1)})^{\delta_1 - 1}$  are positive and  $b_1, b_2 \neq 0$  (because  $c_1, c_2 \neq 0$  in **(P6)**) we conclude that there exists  $\mu^* > 0$  small enough such that:

$$\forall \mu \in ]0, \mu^*[, \quad \left| \det D\mathcal{F}_{(a,\mu(n,a))}(\bar{y}_1^{(1)}, \bar{\theta}^{(1)}) \right| \in ]k_1^{-1}, k_1[,$$

for some  $k_1 > 1$ . This implies that hypothesis **(H1)(3)** is satisfied.

**(H2) and (H3):** It follows from Lemma 7.1 where  $b = \mu(n,a)$  (see (7.4)).

**(H4) and (H5):** These hypotheses are connected with the family of circle maps

$$h_a : \mathbb{S}^1 \rightarrow \mathbb{S}^1$$

defined in Remark 7.2. We now use the following result:

**Proposition 7.3** ([27], adapted). *Let  $\Phi : \mathbb{S}^1 \rightarrow \mathbb{R}$  be a  $C^3$  function with nondegenerate critical points. Then there exist  $L_1$  and  $\delta$  such that of  $L \geq L_1$  and  $\Psi : \mathbb{S}^1 \rightarrow \mathbb{R}$  is a  $C^3$  map with  $\|\Psi\|_{C^2} \leq \delta$  and  $\|\Psi\|_{C^3} \leq 1$ , then the family*

$$h_a(\theta) = \theta + a + L(\Phi(\theta) + \Psi(\theta)), \quad a \in \mathbb{S}^1$$

*satisfies **(H4)** and **(H5)**. If  $L$  is sufficiently large, then **(H7)** is also verified.*

It is immediate to check that the family  $h_a$  satisfies Properties **(H4)** and **(H5)**.

**(H6):** The computation follows from direct computation using the expression of  $\mathcal{F}_\mu(\bar{y}_1^{(1)}, \bar{\theta}^{(1)})$ .

Indeed, for each  $\theta \in C_{a^*}$  (set of critical points of  $h_{a^*}$  defined in (7.3)), we have

$$\frac{d}{dy} \mathcal{F}_{(a,\mu(n,a))}(\bar{y}_1^{(1)}, \theta^{(1)}) \Big|_{\bar{y}_1^{(1)}=0} \neq 0.$$

**(H7):** It follows from Proposition 7.3 if  $\omega$  is large enough.

We apply the theory developed by [26] to prove Theorems A and B.

**7.3. Proof of Theorem A: attracting torus.** The map  $h_a(\theta) = \theta + \xi + a - \omega K_F \ln[\phi_1(\theta)]$  is a diffeomorphism on the circle if and only if:

$$\begin{aligned} h'_a(\theta) > 0 &\Leftrightarrow 1 - \omega K_F \frac{\phi'_1(\theta)}{\phi_1(\theta)} > 0 \\ &\stackrel{(6.9)}{\Leftrightarrow} 1 - \omega K_F \frac{\Phi'_1(\theta)}{\Phi_1(\theta)} > 0 \\ &\Leftrightarrow \omega \times \sup_{\theta \in \mathbb{S}^1} \frac{\Phi'_1(\theta)}{\Phi_1(\theta)} < 1/K_F. \end{aligned}$$

In particular, if  $\omega \times \sup_{\theta \in \mathbb{S}^1} \frac{\Phi'_1(\theta)}{\Phi_1(\theta)} < \frac{1}{K_F}$ , the map  $h_a$  is a diffeomorphism on  $\mathcal{C}$  ( $\Rightarrow$  the flow of (2.3) has an invariant torus). The circle  $\mathcal{C}$  is attracting by Lemma 7.1 and it is not contractible because it may be seen as the graph of a map. Theorem A is proved.

**7.4. Proof of Theorem B: rank-one strange attractors.** Since the family  $\mathcal{F}_{(a, \mu(n, a))}$  satisfies **(H1)**–**(H7)** then, for  $\mu^+ = \min\{\varepsilon, \mu^*\} > 0$  and  $\omega \gg 1$ , there exists a subset of  $\Delta \subset [0, \mu^+]$  with positive Lebesgue measure such that for  $\mu \in \Delta$ , the map  $\mathcal{F}_\mu$  admits a strange attractor in

$$\Omega \subset \bigcap_{m=0}^{+\infty} \mathcal{F}_\mu^m(\text{Out}^+(\mathbf{C}_1))$$

supporting a unique ergodic SRB measure  $\nu$ . Denoting by  $\text{Leb}_1$  the one-dimensional Lebesgue measure, from the reasoning of [25, Sec. 3], we have:

$$\liminf_{r \rightarrow 0^+} \frac{\text{Leb}_1 \{\mu \in [0, r] \cap \Delta : \mathcal{F}_\mu \text{ has a strange attractor with a SRB measure}\}}{r} > 0. \quad (7.5)$$

Theorem B is shown.

#### Technical remarks.

- (1) Throughout the proof, it is essential that the domain of definition of  $\mathcal{F}_\mu$  is diffeomorphic to a cylinder. Otherwise the results of [25] cannot be applied.
- (2) The SRB measure  $\nu$  obtained in this result is global in the sense that almost every point in  $\Omega$  is generic with respect to  $\nu$ . The orbit of Lebesgue almost all points in  $\Omega$  has positive Lyapunov exponent and is asymptotically distributed according to  $\nu$ .
- (3) The strange attractor  $\Omega$  is non-uniformly hyperbolic, non-structurally stable and is the limit of an increasing sequence of uniformly hyperbolic invariant sets.

## 8. PROOF OF THEOREM C

In order to prove Theorem C, we use Theorem 5.5. We make use of the fact that the family  $h_a : \mathbb{S}^1 \rightarrow \mathbb{S}^1$ ,  $a \in \mathbb{S}^1$ , is admissible (see §7.2). In particular, there exists  $a^* \in \mathbb{S}^1$  such that  $h_{a^*} \in \mathcal{E}$  (is a Misiurewicz map). In this section we assume the following technical hypothesis on  $\lambda_0 > 0$  (this constant comes from the definition of Misiurewicz-type map of §5).

**(TH):**  $\exp(\lambda_0) > 2$ .

Let  $S_i$  be one of the connected components of  $C_\delta^{(i)} \setminus \{c^{(i)}\}$ ,  $i = 1, \dots, q$ . This interval is contained in one monotonicity interval of  $h_{a^*}$  (see **(H7)**).

**Lemma 8.1.** *Let  $a^* \in \mathbb{S}^1$  be such that  $h_{a^*} \in \mathcal{E}$ . Then, there exists  $m_1 \in \mathbb{N}$  such that the following conditions hold:*

- (1)  $h_{a^*}^k(S_i) \cap C_\delta = \emptyset$ , for all  $k \in \{1, \dots, m_1 - 1\}$  and
- (2)  $h_{a^*}^{m_1}(S_i) \cap C_\delta \neq \emptyset$ .

*Proof.* Suppose, by contradiction, that  $h_{a^*}^n(S_i)$  never intersect  $C_\delta$ , for all  $n \in \mathbb{N}$ . For  $C \subset \mathbb{S}^1$ , let us denote by  $\text{diam}(C)$  the maximum distance of points in  $C$ . Therefore, for  $y \in h_{a^*}(S_i)$  we have:

$$\begin{aligned} \text{diam}(h_{a^*}^n(S_i)) &\geq \text{diam}(h_{a^*}(S_i)) m \quad \text{where} \quad m = \inf_{y \in h_{a^*}(S_i)} \text{diam}((h_{a^*}^{n-1})'(y)) \\ &> \text{diam}(h_{a^*}(S_i)) b_0 \delta \exp(\lambda_0(n-1)) \\ &> C b_0 \delta \exp(\lambda_0(n-1)), \quad \text{for some } C > 0. \end{aligned}$$

Since  $\lim_{n \rightarrow +\infty} C b_0 \delta \exp(\lambda_0(n-1)) = +\infty$  and  $\text{diam}(S_i) \leq 2\pi$ , this is a contradiction. Then the images of  $S_i$  under  $h_{a^*}$  should intersect  $C_\delta$ .  $\square$

From Lemma 8.1, we may identify three disjoint possibilities:

- (1) there exists  $j_0 \in \{1, \dots, q\}$  such that  $C_\delta^{(j_0)} \subset h_{a^*}^{m_1}(S_i) \Rightarrow n(i) = m_1$ .
- (2)  $]c^{(l)}, c^{(l+1)}[ \subset h_{a^*}^{m_1}(S_i)$  for some  $l \in \{1, \dots, q\}$ . Since  $[0, 2\pi] \subset h_{a^*}(]c^{(l)}, c^{(l+1)}[)$  for all  $l \in \{1, \dots, q\}$  and  $\omega \gg 1$  (remind that for  $\omega \gg 1$  the map  $h_{a^*}$  is mixing by Proposition 7.3), it follows that  $h_{a^*}^{m_1}(S_i) \cap C_\delta^{(j_0)} \neq \emptyset \Rightarrow n(i) = m_1 + 1$ .
- (3) none of the above.

Under the notation of Lemma 8.1, let  $L_0$  be one connected component of  $h_{a^*}^{m_1}(S_i) \setminus C_\delta$  with one endpoint at  $h_{a^*}^{m_1}(c^{(i)})$ ,  $i = 1, \dots, q$ .

**Lemma 8.2.** *If **(TH)** holds, there exists  $m_2 \in \mathbb{N}$  and a subinterval  $L_1$  of  $L_0$  such that  $h_{a^*}^k(L_1) \cap C_\delta = \emptyset$  for all  $k < m_2$  and  $h_{a^*}^{m_2}(L_1) = ]c^{(l)}, c^{(l+1)}[$  for some  $l \in \{1, \dots, q\}$ .*

*Proof.* The proof follows the same lines to those of Lemma 3.2 of [15].  $\square$

Using Lemmas 8.1 and 8.2, for  $\delta > 0$  sufficiently small, the map  $h_{a^*}$  admits a collection  $J_\delta$  such that all vertices of the directed graph  $\mathcal{P}(J_\delta)$  are completely accessible. By Theorem 5.5, we may conclude that for every  $\alpha > 0$  sufficiently small and for every  $\hat{a} \in \Delta(\lambda, \alpha)$  close to  $a^*$ , there exists a sequence  $(a_n)_{n \in \mathbb{N}}$  converging to  $\hat{a}$  for which  $h_{a_n}$  admits a superstable sink. By (7.2), we have

$$\mu_n = \exp\left(\frac{a_n - 2n\pi}{\omega K_F}\right), \quad n \in \mathbb{N}.$$

It is easy to see that  $\lim_{n \rightarrow +\infty} \mu_n = 0$ . Setting  $\mu_{1,n} = \mu_n$ ,  $n \in \mathbb{N}$ , we obtain the sequence needed to prove Theorem C. The way this superstable periodic orbit (which is a *critical point* of  $h_{a_n}$ ) is obtained has been sketched in Figure 6.

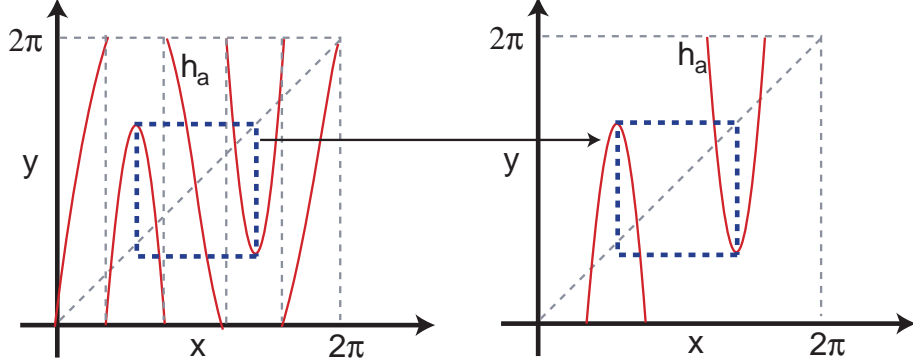

FIGURE 6. Graph of the map  $h_a$  for  $a = \mu_n$  and  $\omega \gg 1$  with  $q = 2$  (number of critical points). Indicated is a superstable periodic orbit of period 2.

## 9. PROOF OF THEOREM D

This case reports the scenario described by Hypotheses **(P1)–(P5)** and **(P6b)–(P7b)** with  $\mu_1 = 0$  and  $\mu_2 > 0$ . We use the first return map  $\mathcal{G}_{(0,\mu_2)} \mapsto \mathcal{G}_\mu$  (cf. Table 3). The proof of Theorem D follows the arguments of [10, 18] and Appendices B and C of [24]. For the sake of completeness, we reproduce the main ideas of the proof. It was shown in [18], that  $\Lambda(\mathcal{G}_{(0,\mu_2)})$  contains infinitely many horseshoes near the heteroclinic network which emerges near  $W^u(\mathbf{C}_2) \pitchfork W^s(\mathbf{C}_1)$ . We describe the geometry of  $W^u(\mathbf{C}_2) \cap \text{In}(\mathbf{C}_1)$  and  $W^s(\mathbf{C}_1) \cap \text{Out}(\mathbf{C}_2)$  for  $\mu_1 = 0$  and  $\mu_2 \neq 0$ . First, we introduce the notation depicted in Figure 7:

- $(O_2^1, 0)$  and  $(O_2^2, 0)$  with  $0 < O_2^1 < O_2^2 < 2\pi$  are the coordinates of the two points where  $W_{\text{loc}}^u(\mathbf{C}_2)$  meets  $W_{\text{loc}}^s(\mathbf{C}_1)$  in  $\text{Out}(\mathbf{C}_2)$  in the first turn around the cycle;
- $(I_1^1, 0)$  and  $(I_1^2, 0)$  with  $0 < I_1^1 < I_1^2 < 2\pi$  are the coordinates of the two points where  $W_{\text{loc}}^u(\mathbf{C}_2)$  meets  $W_{\text{loc}}^s(\mathbf{C}_1)$  in  $\text{In}(\mathbf{C}_1)$  in the first turn around the cycle;
- $(I_1^i, 0)$  and  $(O_2^i, 0)$  are on the same trajectory for each  $i \in \{1, 2\}$  (also called 0-pulses).

By **(P6b)**, for  $\mu_1 = 0$  and small  $\mu_2 > 0$ , the curves  $W_{\text{loc}}^s(\mathbf{C}_1) \cap \text{Out}(\mathbf{C}_2)$  and  $W_{\text{loc}}^u(\mathbf{C}_2) \cap \text{In}(\mathbf{C}_1)$  are the graphs of periodic functions  $\eta_s$  and  $\eta_u$ , for which we make the following conventions (see the meaning of  $C_1$  and  $C_2'$  in Subsection 6.1):

- $W_{\text{loc}}^s(\mathbf{C}_1) \cap \text{Out}(\mathbf{C}_2)$  is the graph of  $\eta_s : \mathbb{S}^1 \rightarrow [-1/C_2', C_2']$ ;
- $W_{\text{loc}}^u(\mathbf{C}_2) \cap \text{In}(\mathbf{C}_1)$  is the graph of  $\eta_u : \mathbb{S}^1 \rightarrow [-1/C_1, C_1]$ ;

- $\eta'_u(I_1^1), \eta'_s(O_2^1) > 0$  and  $\eta'_u(I_1^2), \eta'_s(O_2^2) < 0$ .

The maximum value of  $\eta_u$  depends on  $\mu$  and is attained at some point of the type:

$$\left(y_2^{(1)}, \theta^{(1)}\right) = (\theta^*(\mu), M) \quad \text{with} \quad I_1^1 < \theta^* < I_1^2 \quad \text{and} \quad 0 < M < C_1 < 1.$$

We will need to introduce the definition of spiral on an annulus  $\mathcal{A}$  parametrised by the coordinates  $(y, \theta) \in [0, C_1] \times \mathbb{S}^1$ .

*Definition 7.* A spiral on the annulus  $\mathcal{A}$  accumulating on the circle defined by  $y = 0$  is a curve on  $\mathcal{A}$ , without self-intersections, that is the image, by the parametrisation  $(y, \theta)$ , of a  $C^1$  map  $H : (b, c) \rightarrow [0, C_1] \times \mathbb{S}^1$ ,

$$H(s) = (y(s), \theta(s)),$$

such that:

- there are  $\tilde{b} \leq \tilde{c} \in (b, c)$  for which both  $\theta(s)$  and  $y(s)$  are monotonic in each of the intervals  $(b, \tilde{b})$  and  $(\tilde{c}, c)$ ;
- either  $\lim_{s \rightarrow b^+} \theta(s) = \lim_{s \rightarrow c^-} \theta(s) = +\infty$  or  $\lim_{s \rightarrow b^+} \theta(s) = \lim_{s \rightarrow c^-} \theta(s) = -\infty$ ;
- $\lim_{s \rightarrow b^+} y(s) = \lim_{s \rightarrow c^-} y(s) = 0$ .

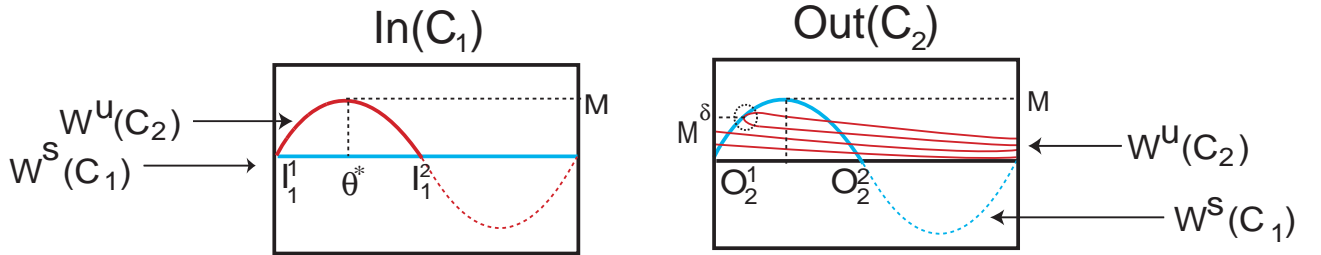

FIGURE 7. The set  $\eta_u = W^u(\mathbf{C}_2) \cap \text{In}^+(\mathbf{C}_1)$  is mapped by  $\text{Loc}_2 \circ \Psi_{1 \rightarrow 2} \circ \text{Loc}_1$  into a spiral accumulating on the circle defined by  $\bar{y}_1^{(2)} = 0$  (ie the parametrisation of  $\text{Out}(\mathbf{C}_2) \cap W^u(\mathbf{C}_2)$ ). There is a sequence  $(\mu_i)_i$  for which the flow of  $\mathcal{G}_{\mu_i}$  exhibits a quadratic heteroclinic tangency.

It follows from the assumptions on the function  $\theta(s)$  that it has either a global minimum or a global maximum, and that  $y(s)$  always has a global maximum. The point where the map  $\theta(s)$  has a global minimum or a global maximum will be called a *fold point* of the spiral. The global maximum value of  $r(s)$  will be called the *maximum radius* of the spiral.

**Lemma 9.1** (Prop. 10 of [10], adapted). *The map  $\text{Loc}_2 \circ \Psi_{1 \rightarrow 2} \circ \text{Loc}_1$  transforms the line  $W^u(\mathbf{C}_2) \cap \text{In}^+(\mathbf{C}_1)$ <sup>5</sup> into a spiral on  $\text{Out}(\mathbf{C}_2)$  accumulating on the circle defined by  $\text{Out}(\mathbf{C}_2) \cap W^u(\mathbf{C}_2)$  (i.e.,  $\bar{y}_1^{(2)} = 0$ ). This spiral has maximum radius  $M^\delta$  as  $\mu$  tends to zero. It has a fold point that turns around  $W^u(\mathbf{C}_2) \cap \text{Out}^+(\mathbf{C}_2)$ .*

<sup>5</sup>This line is part of the graph of  $\eta_u$  (red continuous line on the left image of Figure 7).

The geometric idea of Lemma 9.1 is depicted in Figure 7. Since  $\delta > 1$  and  $M < 1$ , then  $M^\delta < M < C_1$ .

**9.1. Proof of Theorem D(1): rotational horseshoes.** For  $\tau > 0$  sufficiently small, define a rectangle  $R \subset \text{Out}(\mathbf{C}_2)$  parameterized by  $[O_2^1 - \tau, O_2^2 + \tau] \times ]0, \tau]$ . The map  $\mathcal{G}_\mu$  compresses  $R$  in the vertical direction and stretches in the vertical direction, making the image infinitely long towards both ends. In other words, the map  $\mathcal{G}_\mu$  folds and wraps  $R$  infinitely many times. This is why  $\Lambda(\mathcal{G}_\mu)$  contains a horseshoe of infinitely many branches for all  $\mu \in [0, \varepsilon]$ . When restricted to a compact set of  $\text{Out}^+(\mathbf{C}_2)$  not containing  $W^u(\mathbf{C}_2)$ , these horseshoes are uniformly hyperbolic. All details of this proof may be found in [18, Th. 8]<sup>6</sup>

**9.2. Proof of Theorem D(2): sequence of heteroclinic tangencies.** The set  $\eta_s$  divides  $\text{Out}(\mathbf{C}_2)$  in two connected components. By Lemma 9.1 and using the fact that  $M^\delta < M$ , the fold point of  $\text{Loc}_2 \circ \Psi_{1 \rightarrow 2} \circ \text{Loc}_1(W^u(\mathbf{C}_2) \cap \text{In}^+(\mathbf{C}_1))$  moves around  $\text{Out}(\mathbf{C}_2)$  at a speed (with respect to the parameter  $\mu$ ) greater than the speed of  $\eta_s$ , from one connected component to the other, as  $\mu$  vanishes. Two points where the fold point of the spiral  $\text{Loc}_2 \circ \Psi_{1 \rightarrow 2} \circ \text{Loc}_1(W^u(\mathbf{C}_2) \cap \text{In}^+(\mathbf{C}_1))$  intersects the graph of  $\eta_s$  come together and collapse at the heteroclinic tangency associated to the two-dimensional manifolds  $W^s(\mathbf{C}_1)$  and  $W^u(\mathbf{C}_2)$ . As  $\mu$  goes to zero, it creates a sequence  $(\mu_i)_{i \in \mathbb{N}}$  of tangencies to the graph of  $\eta_s$  (see Figure 7). This tangency has a quadratic form.

**9.3. Proof of Theorem D(3): strange attractors.** By [18] there is a horseshoe near the 0-pulses associated to  $W^u(\mathbf{C}_2) \pitchfork W^s(\mathbf{C}_1)$ . Hence, there are hyperbolic fixed points of the first return map  $\mathcal{G}_\mu$  arbitrarily close to the 0-pulse; let  $P_i$  be one of these periodic orbits.

First, note that  $P_i$  is dissipative (the absolute value of the product of the Lyapunov multipliers is less than the unit). The unstable manifold of  $P_i$  crosses  $W^s(\mathbf{C}_1)$  and so its image under  $\text{Loc}_2 \circ \Psi_{1 \rightarrow 2} \circ \text{Loc}_1$  accumulates on  $W^u(\mathbf{C}_2)$  (some reasoning of Lemma 9.1); in particular,  $\text{Loc}_2 \circ \Psi_{1 \rightarrow 2} \circ \text{Loc}_1(W^u(P_i) \cap \text{Out}(\mathbf{C}_2))$  contains infinitely many spirals in  $\text{Out}(\mathbf{C}_2)$ , each one having a fold point. Since the fold points turn around  $\text{Out}(\mathbf{C}_2)$  infinitely many times as  $\mu$  varies, this curve is tangent (quadratic tangency) to  $W^s(P_i)$  at a sequence  $\mu_i$  of values of  $\mu$ . Hence, there exists a sequence of parameter values for which the associated flow exhibits non-degenerate heteroclinic tangencies formed by the invariant manifolds of the periodic orbits of the horseshoe. The existence of strange attractors of Hénon-type follows from [12]. Setting  $\mu_{2,i} = \mu_i$ ,  $i \in \mathbb{N}$ , we obtain the sequence needed to prove Theorem D(3).

**9.4. Proof of Theorem D(4): sequence of sinks.** The existence of a sequence of parameter values for which the flow of (2.3) exhibits a sink is a result of the quadratic homoclinic tangency associated to a dissipative point. The result follows from Gavrilov-Shilnikov [7] and Newhouse [14] theories.

## 10. PROOF OF PROPOSITION E

This case addresses the scenario described by  $\mu_1 = 0$  and  $\mu_2 > 0$ . This is why we use the first return map  $\mathcal{G}_{(0, \mu_2)} \mapsto \mathcal{G}_\mu$  (cf. Table 3). Taking into account Lemma 6.5, the singular cycle associated to  $\mathcal{G}_\mu$  has the form:

$$h_a(\theta) = \theta + \xi + \mu_2 \psi_2(\theta) - a - \omega K_G \ln[\phi_2(\theta)], \quad \theta \in \mathbb{S}^1, \quad (10.1)$$

<sup>6</sup>The shift dynamics is what the authors of [18] call *horseshoe in time*.

where

$$\xi = \xi_1 + \xi_2 \quad \text{and} \quad K_G = \frac{1}{e_1 + \omega_2^{(1)}} + \frac{\delta_1}{e_2 + \omega_2^{(2)}}.$$

The meaning of  $a$  is the same of equation (7.2). Since  $\phi_2$  has zeros, the singular limit has logarithmic singularities. By [22, pp. 534], for  $\varepsilon > 0$  small and  $\omega \gg 1$ , there exists a set  $\Delta \subset \mathbb{S}^1$  of  $a$ -values with  $Leb_1(\Delta) > 0$  such that if  $a \in \Delta$  and  $c \in C$  (set of critical points of  $h_a$ ), the following inequality holds:

$$\forall n \in \mathbb{N}, \quad |(h_a^n)'(h_a(c))| > (\omega K_G)^{\lambda n}. \quad (10.2)$$

In addition  $\lim_{\omega \rightarrow +\infty} Leb_1(\Delta) = 2\pi$ . Since the recurrence of the critical points is almost inevitable with respect to the Lebesgue measure ([22]), from (10.2) we may conclude that for almost all points  $\theta \in \mathbb{S}^1$ , we have:

$$\limsup_{n \rightarrow +\infty} \frac{\ln |(h_a^n)'(\theta)|}{n} \geq \frac{\ln \omega}{\log \varepsilon} + \mathcal{O}(1) > 0,$$

where  $\mathcal{O}(1)$  denotes the usual *Landau notation*. This proves Proposition E.

*Remark 10.1.* The nature of the strange attractor of Proposition E is different from that of Theorem D. In the latter case, the strange attractor is of Hénon-type and its basin of attraction is confined to a portion of the phase space near the homoclinicity. In the first case, the strange attractor shadows the entire locus of a two-dimensional torus (defined by  $W^u(\mathbf{C}_2)$ ). This strange attractor coexists with the heteroclinic pulses whose existence is guaranteed in [18].

## 11. PROOF OF THEOREM F

We are looking for homoclinic tangencies to  $\mathbf{C}_1$ . In  $\text{Out}(\mathbf{C}_1)$ , the local unstable manifold of  $\mathbf{C}_1$  is parametrised by

$$\left(0, \bar{\theta}^{(1)}\right), \quad \bar{\theta}^{(1)} \in \mathbb{S}^1$$

The expression for  $\Psi_{2 \rightarrow 1} \circ \text{Loc}_2 \circ \Psi_{1 \rightarrow 2}(W_{\text{loc}}^u(\mathbf{C}_1) \cap \text{Out}(\mathbf{C}_1)) \subset \text{In}(\mathbf{C}_1)$  is given by:

$$\bar{y}_2^{(1)} = b_2 \frac{\mu_1^{\delta_2}}{\|\mu\|} \phi_1 \left(0, \theta^{(1)}\right)^{\delta_2} + \frac{\mu_2}{\|\mu\|} \phi_2 \left(\bar{y}_1^{(2)}, \theta^{(2)}\right) \quad (11.1)$$

where

$$\begin{aligned} \bar{y}_1^{(2)} &= \frac{\mu_1^{\delta_2}}{\|\mu\|} \phi_1 \left(0, \theta^{(1)}\right)^{\delta_2} \\ \bar{\theta}^{(2)} &= \bar{\theta}^{(1)} + \xi_1 + \mu_1 \psi_1 \left(0, \bar{\theta}^{(1)}\right) - \frac{\omega}{e_2 + \omega_2^{(2)}} \ln \left(\mu_1 \phi_1 \left(0, \bar{\theta}^{(1)}\right)\right) \end{aligned}$$

There is a homoclinic cycle to  $\mathbf{C}_1$  when  $\bar{y}_2^{(1)} = 0$  (parameterization of the local stable manifold of  $\mathbf{C}_1$ ). Using (11.1), we get

$$\text{Hom:} \quad b_2 \mu_1^{\delta_2} C_1 + \mu_2 C_2 = 0 \Leftrightarrow |\mu_2| = C |\mu_1|^{\delta_2}, \quad C, C_1, C_2 \in \mathbb{R}^+.$$

The invariant manifolds associated to  $\mathbf{C}_1$  develop a tangency along the curve *Hom*, and above this tangency (in the parameter space) there are transverse heteroclinic connections and thus a heteroclinic tangle. In the convex region defined by the curve *Hom*, the set  $W^u(\mathbf{C}_1)$



does not play any longer the role of separatrix. A plausible bifurcation diagram is depicted in Figure 3 and an interpretation for the different regions follows:

- I** → Attracting two-dimensional torus if  $\omega \approx 0$ ;
- I** → Rank-one attractors if  $\omega \gg 1$ ;
- II** → Dynamical structures associated to the torus-breakdown scenario when  $\omega \approx 0$  and heteroclinic bifurcations;
- III** → Heteroclinic tangles; pulses; “large” strange attractors if  $\omega \gg 1$ .

Dynamical properties of these three regions are discussed in Section 13.

## 12. REWRITING PROPERTIES **(P7a)** AND **(P7b)** WITH MELNIKOV INTEGRALS

We start with the Melnikov functions for system (2.2), explicitly defined for the unperturbed heteroclinic solutions  $\ell_1$  and  $\ell_2$  respectively. Let:

$$\tau_1(t) = \frac{1}{|\ell'_1(t)|} \ell'_1(t) \quad \text{and} \quad \tau_2(t) = \frac{1}{|\ell'_2(t)|} \ell'_2(t)$$

be the unit tangent vectors of the heteroclinic solutions at  $\ell_1$  and  $\ell_2$  respectively. It is easy to check that:

$$\lim_{t \rightarrow -\infty} \tau_1(t) = \bar{u}(e_1), \quad \lim_{t \rightarrow +\infty} \tau_1(t) = \bar{u}(c_2),$$

and

$$\lim_{t \rightarrow -\infty} \tau_2(t) = \bar{u}(e_2), \quad \lim_{t \rightarrow +\infty} \tau_2(t) = -\bar{u}(c_1).$$

For  $i \in \{1, 2\}$ , let  $\tau_i^\perp(t)$  denote a unit vector that is perpendicular to  $\tau_{\ell_i}(t)$  and  $(\tau_{\ell_i}^\perp(t))^T$  its transpose. The splitting of the stable and unstable manifolds on a global transverse cross section  $\Sigma$  for the perturbed system is measured by the *Melnikov function*:

$$W_i(\theta) = \int_{-\infty}^{+\infty} \left\langle (P(\ell_i(t), t + \theta), Q(\ell_i(t), t + \theta)), \tau_i^\perp(t) \right\rangle \exp\left(-\int_0^t E_i(s) ds\right) dt, \quad \theta \in \mathbb{S}^1$$

where  $\langle \cdot, \cdot \rangle$  denotes the usual inner product<sup>7</sup> in  $\mathbb{R}^2$  and

$$E_i(t) = \tau_{\ell_i}^\perp(t) \begin{pmatrix} \frac{\partial g_1}{\partial x}(\ell_i(t)) & \frac{\partial g_1}{\partial y}(\ell_i(t)) \\ \frac{\partial g_2}{\partial x}(\ell_i(t)) & \frac{\partial g_2}{\partial y}(\ell_i(t)) \end{pmatrix} (\tau_i^\perp(t))^T \in \mathbb{R}.$$

It is easy to check that

$$\lim_{t \rightarrow -\infty} E_1(t) = e_1 \quad \text{and} \quad \lim_{t \rightarrow +\infty} E_1(t) = c_2$$

and

$$\lim_{t \rightarrow -\infty} E_2(t) = e_2 \quad \text{and} \quad \lim_{t \rightarrow +\infty} E_2(t) = e_1.$$

According to [3, 8, 11], Hypotheses **(P7a)** and **(P7b)** main be rephrased as:

---

<sup>7</sup>This inner product corresponds to the *wedge product*  $\wedge$  defined by Melnikov [11] (see also [8]).

- (P7a) If  $\mu_1 > 0$  and  $\mu_2 = 0$ , then  $\min_{\theta \in \mathbb{S}^1} W_1(\theta)$  and  $\max_{\theta \in \mathbb{S}^1} W_1(\theta)$  have the same sign.
- (P7b) If  $\mu_2 > 0$  and  $\mu_1 = 0$ , then  $\min_{\theta \in \mathbb{S}^1} W_2(\theta) < 0 < \max_{\theta \in \mathbb{S}^1} W_2(\theta)$  and if  $W_2(\theta_0) = 0$  for some  $\theta_0 \in \mathbb{S}^1$ , then  $W_2'(\theta_0) \neq 0$ .

### 13. RANK-ONE STRANGE ATTRACTORS AND HETEROCLINIC TANGLES: A SHORT DISCUSSION

When a planar heteroclinic cycle associated to two dissipative saddles is periodically perturbed, the perturbation either pulls the stable and the unstable manifolds of the equilibria completely apart, or it creates chaos through a heteroclinic tangle. In both (exclusive) cases, the singular limit induced by the perturbed equation (at least  $C^4$ ) in the extended phase space may be written as a family of two-dimensional maps. The *singular limit cycle* is a one-dimensional map of the form:

$$\theta \mapsto \theta + a + \omega K \ln |\Phi(\theta)|, \quad \theta \in \mathbb{S}^1$$

where:

- (1)  $K > 0$  depends on the eigenvalues of the derivative of the original vector field at the hyperbolic equilibria;
- (2)  $\omega$  is the frequency of the non-autonomous perturbation;
- (3)  $a \in \mathbb{S}^1$  (depends on the magnitude of the forcing);
- (4)  $\Phi : \mathbb{S}^1 \rightarrow \mathbb{R}$  is  $C^3$  and periodic;
- (5)  $\Phi'(\theta) \neq 0$  if  $\Phi(\theta) = 0$  and  $\Phi''(\theta) \neq 0$  if  $\Phi'(\theta) = 0$ .

Usually, the map  $\Phi$  may be seen as the *classical Melnikov function*.

For system (2.3), if  $\mu_1 > 0$  and  $\mu_2 = 0$ , the stable and unstable manifolds of the perturbed saddles are pulled completely apart by the forcing function, implying  $\Phi(\theta) \neq 0$  for all  $\theta \in \mathbb{S}^1$ . In this case, we obtain an attracting two-dimensional torus or strange attractors, to which the theory of rank-one maps may be applied. Here, the parameter  $\omega$  plays an important role to understand how “large” strange attractors come from the destruction of an attracting two-dimensional torus.

If  $\mu_1 = 0$  and  $\mu_2 > 0$ , the two-dimensional stable and unstable manifolds of the saddles intersect ( $\Leftrightarrow \Phi(\theta) = 0$  has solutions) and strange attractors are associated to a heteroclinic tangle. As  $\omega$  gets larger, the contracting region gets smaller and the dynamics is more and more expanding in most of the phase space. The recurrence of the critical points is inevitable, and infinitesimal changes of dynamics occur when  $a$  is varied. The logarithmic nature of the singular set turns out to present a new phenomenon which is unknown to occur for Misiurewicz-type maps. Proposition E states that strange attractors with *nonuniform expansion* prevails provided  $\omega \gg 1$ . When  $\mu_1, \mu_2 \neq 0$ , we also proved that, under conditions (P1)–(P7), the existence of heteroclinic tangles is a *prevalent phenomenon* for the dynamics of (2.3).

The techniques we have used to prove the main results follow the spirit of previous results in the literature. In Table 4, we give an overview of the results and the contribution of the present article (in blue) for the dynamics of (2.3).

Configuration	$W^u(\mathbf{C}_1) \pitchfork W^s(\mathbf{C}_2)$	$W^u(\mathbf{C}_1) \cap W^s(\mathbf{C}_2) = \emptyset$
$W^u(\mathbf{C}_2) \pitchfork W^s(\mathbf{C}_1)$	Case 1 Heteroclinic tangles (Horseshoes, tangencies, sinks Newhouse phenomena, pulses) [5, 10, 18]	Case 2 (Novelty of this article) Region with torus if $\omega \approx 0$ Region with rank-one attractors if $\omega \gg 1$ Superstable sinks Heteroclinic tangles prevail
$W^u(\mathbf{C}_2) \cap W^s(\mathbf{C}_1) = \emptyset$	Case 3 Similar to Case 2	Case 4 Region with torus if $\omega \approx 0$ Region with rank-one attractors if $\omega \gg 1$ [13]

TABLE 4. Overview of the results in the literature and the contribution of the present article (in blue) for the dynamics of (2.3).

Strange attractors found in Theorems B and D are qualitative different. In the first case, they are rank-one strange attractors; if  $\omega \gg 1$ , they are not confined to a small portion of the phase space – their basin of attraction spreads around the whole “torus-ghost” (annulus in the cross section  $\text{Out}(\mathbf{C}_1)$ ). According to [4], they are called “large” strange attractors. On the other hand, in Theorem D, Hénon-type strange attractors are confined to a small portion of the phase space near the homoclinic tangency. In this case, the study of properties of the strange attractors is more involved due to the existence of infinitely many pulses which cannot be disconnected from the attractor (there are infinitely many points within  $W^s(O_1)$  where the first return map is not well defined). This difference justifies the title of this manuscript. A lot more needs to be done before these two types of chaos are well understood.

The sinks of Theorems C and D(3) have similarities but they have been obtained in a different way. While in the first case, sinks are due to critical periodic points of the singular cycle [15], in the second, sinks are a consequence of Gavrilov-Newhouse phenomena [7, 14].

Finally, we would like to point out that in Case 4, the non-wandering set associated to  $\Gamma$  has one, two or three attracting tori according to the relative position of  $W^u(\mathbf{C}_1)$  and  $W^u(\mathbf{C}_2)$ . In the same spirit of [5], in Figure 8, we have summarized all possibles of invariant curves that can appear in the unfolding of system (2.3), for  $\mu_1 \neq 0$  and  $\mu_2 = 0$ . In these cases, Theorems A, B and C still hold with minor variations. Finding an explicit example where Hypotheses (P1)–(P7) are met is the next ongoing research.

#### REFERENCES

- [1] V.S. Afraimovich, S-B Hsu, H. E. Lin. *Chaotic behavior of three competing species of May–Leonard model under small periodic perturbations*. Int. J. Bif. Chaos, 11(2) (2001) 435–447.

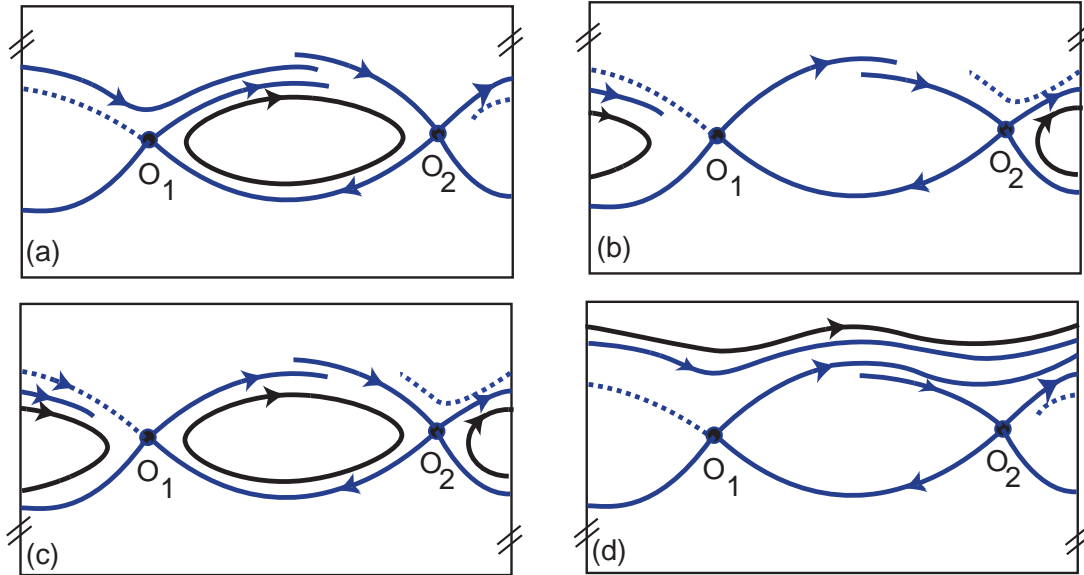

FIGURE 8. Four types of configuration for (2.2) when  $\mu_1 > 0$  and  $\mu_2 = 0$ . (a), (b): one contractible periodic solution; (c): two contractible periodic solutions; (d) one non-contractible periodic solution. Double bars mean that the sides are identified.

- [2] M.A.D. Aguiar, S.B.S.D. Castro, I.S. Labouriau. *Dynamics near a heteroclinic network*. Nonlinearity 18 (2005) 391–414.
- [3] A. L. Bertozzi. *Heteroclinic orbits and chaotic dynamics in planar fluid flows*, SIAM J. Math. Anal, Vol. 19, No. 6 (1988) 1271–1294.
- [4] H. Broer, C. Simó, J. C. Tatjer. *Towards global models near homoclinic tangencies of dissipative diffeomorphisms* Nonlinearity 11 (1998) 667–770.
- [5] F. Chen, A. Oksasoglu, Q. Wang. *Heteroclinic tangles in time-periodic equations*. J. Diff. Eqs. 254 (2013) 1137–1171.
- [6] S-N. Chow, J. Hale. *Methods of bifurcation theory*, Springer-Verlag, New York-Berlin, 1982.
- [7] N.K. Gavrilov, L.P. Shilnikov. *On three-dimensional dynamical systems close to systems with a structurally unstable homoclinic curve*. Part I: Math. USSR Sbornik 17 (1972) 467–485. Part II: *ibid* 19 (1973) 139–156.
- [8] J. Guckenheimer, P. Holmes. *Nonlinear Oscillations, Dynamical Systems, and Bifurcations of Vector Fields*. Applied Mathematical Sciences 42, Springer-Verlag, 1983.
- [9] M. Herman. *Mesure de Lebesgue et Nombre de Rotation*, Lecture Notes in Math., vol. 597, Springer, (1977) 271–293.
- [10] I.S. Labouriau, A.A.P. Rodrigues. *On Takens’ Last Problem: tangencies and time averages near heteroclinic networks*, Nonlinearity 30 (2017) 1876–1910.
- [11] V.K. Melnikov. *On the stability of the center for time periodic perturbations*, Trans. Moscow Math. Soc., 12 (1963), 1–57.
- [12] L. Mora, M. Viana. *Abundance of strange attractors*, Acta Math. 171(1) (1993) 1–71.
- [13] A. Mohapatra, W. Ott. *Homoclinic Loops, Heteroclinic Cycles, and Rank One Dynamics*, SIAM Journal on Applied Dynamical Systems 14.1 (2015), 107–131.
- [14] S.E. Newhouse. *The abundance of wild hyperbolic sets and non-smooth stable sets for diffeomorphisms*. Publ. Math. Inst. Hautes Études Sci. 50 (1979) 101–151.
- [15] W. Ott, Q. Wang. *Periodic attractors versus nonuniform expansion in singular limits of families of rank one maps*, Discrete & Continuous Dynamical Systems-A 26.3 (2009): 1035.

- [16] A. Passeggi, R. Potrie, M. Sambarino. *Rotation intervals and entropy on attracting annular continua*, Geometry & Topology 22(4), 2145–2186, 2018.
- [17] H. Poincaré. *Les méthodes nouvelles de la mécanique céleste*, 3 Vols. (1899) Gauthier-Villars: Paris.
- [18] A.A.P. Rodrigues, I.S. Labouriau, M.A.D. Aguiar. *Chaotic double cycling*, Dyn. Sys. Int. J. 26(2) (2011) 199–233.
- [19] L.P. Shilnikov. *A contribution to the problem of the structure of an extended neighborhood of a rough equilibrium state of saddle-focus type*. Math. USSR Sb. 10 (1970) 91–102.
- [20] L. P. Shilnikov, A. Shilnikov, D. Turaev, L. Chua. *Methods Of Qualitative Theory In Nonlinear Dynamics* (Part II). World Sci. Singapore, New Jersey, London, Hong Kong, 2001.
- [21] S. Smale. *Differentiable Dynamical Systems*, Bull. Amer. Math. Soc. 73 (1967), 474–517.
- [22] H. Takahasi, Q. Wang. *Nonuniformly expanding 1d maps with logarithmic singularities* Nonlinearity 25.2 (2012) 533–550.
- [23] F. Takens. *Heteroclinic attractors: Time averages and moduli of topological conjugacy*. Bol. Soc. Brasil. Mat. 25 (1994) 107–120.
- [24] Q Wang, A. Oksasoglu. *Dynamics of homoclinic tangles in periodically perturbed second-order equations*, J. Diff. Eqs. 250(2) (2011) 710–751.
- [25] Q. Wang, W. Ott. *Dissipative homoclinic loops of two-dimensional maps and strange attractors with one direction of instability*, Communications on Pure and Applied Mathematics 64–11 (2011) 1439–1496.
- [26] Q. Wang, L.S. Young. *From Invariant Curves to Strange Attractors*, Commun. Math. Phys. (2002) 225–275.
- [27] Q. Wang, L.S. Young. *Strange Attractors in Periodically-Kicked Limit Cycles and Hopf Bifurcations*, Comm. Math. Phys. 240 (2003) 509–529.
- [28] Q. Wang, L.S. Young. *Nonuniformly expand 1D maps*, Comm. Math. Phys. 264(1) (2006) 255–282.

#### APPENDIX A. NOTATION

In Table 5, we list the main notation for constants and auxiliary functions used in this paper in order of appearance with the reference of the section containing a definition.

ALEXANDRE RODRIGUES, CENTRO DE MATEMÁTICA DA UNIV. DO PORTO, RUA DO CAMPO ALEGRE, 687, 4169-007 PORTO, PORTUGAL

*Email address:* alexandre.rodrigues@fc.up.pt

Notation	Definition/meaning	Section
$\mathcal{V}$	Open region of $\mathbb{R}^2$ where equation (2.1) is well defined	§2.1
$O_1, O_2$	Saddle-equilibria of the equation (2.1)	§2.1
$\ell_1, \ell_2$	Connections from $O_1$ to $O_2$ and from $O_2$ to $O_1$	§2.1
$\mathcal{A}$	Region limited by the heteroclinic cycle $\ell_1 \cup \ell_2$	§2.1
$\mathcal{V}^*$	Inner basin of attraction of the heteroclinic cycle $\ell_1 \cup \ell_2$ (absorbing domain)	§2.1
$\mathbb{V}$	$\mathcal{V} \times \mathbb{S}^1$ – open region where equation (2.3) is defined	§2.2
$\mathbf{C}_1, \mathbf{C}_2$	Saddle periodic solutions of the equation (2.3)	§2.2
$\Gamma$	Heteroclinic cycle associated to $\mathbf{C}_1, \mathbf{C}_2$	§2.2
$\mathbb{A}$	$\mathcal{A} \times \mathbb{S}^1$	§2.2
$\mathbb{V}^*$	$\mathcal{V}^* \times \mathbb{S}^1$	§2.2
$\mathcal{L}_1, \mathcal{L}_2$	Connections from $\mathbf{C}_1$ to $\mathbf{C}_2$ and from $\mathbf{C}_2$ to $\mathbf{C}_1$	§2.2
$V_1, V_2$	Hollow cylinders around $\mathbf{C}_1$ and $\mathbf{C}_2$	§2.2
$A \equiv_{\mathbb{V}^*} B$	The manifolds $A$ and $B$ coincide within $\mathbb{V}^*$	§2.3
$\mathcal{F}_{(\mu_1, \mu_2)} \equiv \mathcal{F}_\mu$	First return map to $\text{Out}(\mathbf{C}_1)$	§6.5 and Table 3
$\mathcal{G}_{(\mu_1, \mu_2)} \equiv \mathcal{G}_\mu$	First return map to $\text{Out}(\mathbf{C}_2)$	§6.5 and Table 3

TABLE 5. Notation.