

Crowd-Anticrowd Theory of Collective Dynamics in Competitive, Multi-Agent Populations and Networks

Neil F. Johnson*

Physics Department, Oxford University, Oxford, OX1 3PU, UK

Pak Ming Hui

Department of Physics, The Chinese University of Hong Kong, Shatin, Hong Kong, China

(Dated: May 26, 2020)

Abstract

We discuss a crowd-based theory for describing the collective behavior in a generic multi-agent population which is competing for a limited resource. These systems – whose binary versions we refer to as B-A-R (Binary Agent Resource) collectives – have a dynamical evolution which is determined by the aggregate action of the heterogeneous, adaptive agent population. Accounting for the strong correlations between agents’ strategies, yields an accurate description of the system’s dynamics in terms of a ‘Crowd-Anticrowd’ theory. This theory can incorporate the effects of an underlying network within the population. Most importantly, its applicability is *not* just limited to the El Farol Problem and the Minority Game. Indeed, the Crowd-Anticrowd theory offers a powerful approach to tackling the dynamical behavior of a wide class of agent-based Complex Systems, across a range of disciplines. With this in mind, the present working paper is written for a general multi-disciplinary audience within the Complex Systems community.

Working paper for the Workshop on Collectives and the Design of Complex Systems, Stanford University, August 2003.

* Research performed in collaboration with former graduate students Michael Hart and Paul Jefferies, and present graduate students Sehyo Charley Choe, Sean Gourley and David Smith.

I. INTRODUCTION

Complex Systems – together with their dynamical behavior known as Complexity – are thought to pervade much of the natural, informational, sociological, and economic world [1, 2, 3, 4, 5]. A unique, all-encompassing definition of a Complex System is lacking - worse still, such a definition would probably end up being too vague. Instead, such Complex Systems are better thought of in terms of a list of common features which distinguish them from ‘simple’ systems, and from systems which are just ‘complicated’ as opposed to being complex. Although a unique list of Complex System properties does not exist, most people would agree that the following would typically appear: feedback and adaptation at the macroscopic and/or microscopic level, many (but not too many) interacting parts, non-stationarity, evolution, coupling with the environment, and observed dynamics which depend upon the particular realization of the system. In addition, Complex Systems have the ability to produce large macroscopic changes which appear spontaneously but have long-lasting consequences. Such large changes might also be referred to as ‘innovations’, ‘breakthroughs’, ‘gateway events’ or ‘punctuated equilibria’ depending on the context [6]. Alternatively, the particular trajectory taken by a Complex System can be thought of as exhibiting ‘frozen accidents’ [6]. Understanding the functionality of Complex Systems is of paramount importance, from both practical and theoretical viewpoints. Such functionality is currently being addressed through the study of ‘Collectives’ [7].

The down-side of labelling such a wide range of systems as belonging to the same ‘Complex’ family, is that instead of saying something about everything, one may end up saying nothing very much about anything. Indeed, one may end up with little more than the vague notion that ‘ant colonies are like vehicular traffic, which is like financial markets, which are like fungal colonies etc.’. On the other hand, it would be a mistake to focus too narrowly on a specific example of a Complex System since the lessons learned may not be transferable - worse still, they may be misleading or plain wrong in the context of other Complex Systems. Such is the daunting task facing researchers in Complex Systems: based on studies of a few very specific Complex System models, how can one extract general theoretical principles which have wide applicability across a range of disciplines? This explains why, to date, there are very few truly universal theoretical principles or ‘laws’ to describe Complex Systems.

As pointed out by John Casti on p. 213 of Ref. [1], ‘.... a decent mathematical formalism to describe and analyze the [so-called] El Farol Problem would go a long way toward the creation of a viable theory of complex, adaptive systems’. The rationale behind this statement is that the El Farol Problem, which was originally proposed by Brian Arthur[8] to demonstrate the essence of Complexity in financial markets, incorporates the key features of a Complex System in an everyday setting. Very briefly, the El Farol Problem concerns the collective decision-making of a group of potential bar-goers, who repeatedly try to predict whether they should attend a potentially overcrowded bar on a given night each week. They have no information about the others predictions. Indeed the only information available to each agent is global, comprising a string of outcomes (‘overcrowded’ or ‘undercrowded’) for a limited number of previous occasions. Hence they end up having to predict the predictions of others. No ‘typical’ agent exists, since all such typical agents would then make the same decision, hence rendering their common prediction scheme useless. This simple yet intriguing problem has inspired a huge amount of interest in the physics community over the past few years. Reference [9], which was the first work on the full El Farol Problem in the physics community, identified a minimum in the volatility of attendance at the bar with increasing adaptivity of the agents. With the exception of Ref. [9], the physics literature has instead focussed on a simplified binary form of the El Farol Problem as introduced by Challet and Zhang [10]. This so-called Minority Game (MG) is discussed in detail in Refs. [11, 12, 13, 14, 15, 16, 17, 18, 19, 20, 21, 22, 23, 24, 25, 26, 27, 28, 29, 30, 31, 32, 33, 34, 35, 36, 37, 38]) and Ref. [39]. The Minority Game concerns a population of N heterogeneous agents with limited capabilities and information, who repeatedly compete to be in the minority group. The agents (e.g. people, cells, data-packets) are adaptive, but only have access to global information about the game’s progress. In both the El Farol Problem and the Minority Game, the time-averaged fluctuations in the system’s global output are of particular importance – for example, the time-averaged fluctuations in attendance can be used to assess the wastage of the underlying global resource (i.e. bar seating).

Despite its appeal, the El Farol Problem (and the Minority Game in particular) is somewhat limited in its applicability to general Complex Systems, and hence arguably falls short of representing a true generic paradigm for Complex Systems. First, the reward structure is simultaneously too restrictive and specific. Agents in the Minority Game, for example, can only win if they instantaneously choose the minority group at a particular timestep:

yet this is not what investors in a financial market, for example, would call ‘winning’ [40]. Second, agents only have access to global information. In the natural world, most if not all biological and social systems have at least some degree of underlying connectivity between the agents, allowing for local exchange of information or physical goods [41]. In fact it is this interplay of network structure, agent heterogeneity, and the resulting functionality of the overall system, which is likely to be of prime interest across disciplines in the Complex Systems field.

Three enormous challenges therefore face any candidate Complex Systems theory: it must be able to explain the specific numerical results observed for the El Farol Problem and its variants; it should also be able to account for the presence of an arbitrary underlying network; yet it should be directly applicable to a much wider class of ‘game’ with a variety of reward structures. Only then will one have a hope of claiming some form of generic theory of Complex Systems. And only then will the design of multi-agent Collectives to address both forward and inverse problems, become relatively straightforward. It might then be possible to achieve the Holy Grail of predicting *a priori* how to engineer agents’ reward structures, or which specific game rules to invoke, or what network communication scheme to introduce, in order to achieve some global objective. For a detailed discussion of these issues, we refer to the paper of Kagan Tumer and David Wolpert [7] at this Workshop.

In this paper, we attempt to take a step in this more general direction, by building on the success of the Crowd-Anticrowd theory in describing both the original El Farol Problem [9], and the Minority Game [23, 24] and its variants. In particular, we present a formal treatment of the collective behavior of a generic multi-agent population which is competing for a limited resource. The applicability of the Crowd-Anticrowd analysis is *not* limited to MG-like games, even though we focus on MG-like games in order to demonstrate the accuracy of the Crowd-Anticrowd approach in explaining the numerical results. We also show how the Crowd-Anticrowd theory can be extended to incorporate the presence of networks. The theory is built around the crowding (i.e. correlations) in strategy-space, rather than the precise rules of the game itself, and only makes fairly modest assumptions about a game’s dynamical behavior. To the extent that a given Complex System mimics a general competitive multi-agent game, it is likely that the Crowd-Anticrowd approach will therefore be applicable. This would be a welcome development, given the lack of general theoretical concepts in the field of Complex Systems as a whole. The challenge then moves to

understanding how best to embed the present theory within the powerful COIN framework developed by Wolpert and Tumer for Collectives [7].

We have tried to aim this paper at a multi-disciplinary audience within the general Complex Systems community. The layout of the paper is as follows. Section II briefly discusses the background to the Crowd-Anticrowd framework. Section III provides a description of a wide class of Complex Systems which will be our focus: we call these B-A-R (Binary Agent Resource) problems in recognition of the stimulus provided by Arthur’s El Farol Problem. The Minority Game is a special limiting case of such B-A-R problems. Section IV develops the Crowd-Anticrowd formalism which describes a general B-A-R system’s dynamics. Section V considers the implementation of the Crowd-Anticrowd formalism, deriving analytic expressions for the global fluctuations in the system in various limiting cases. Section VI applies these results to both the basic Minority Game and several generalizations, in the absence of a network. Section VII then considers the intriguing case of B-A-R systems subject to an underlying network. In particular, it is shown analytically that such network structure may have important benefits at very low values of network connectivity, in terms of reduced wastage of global resources. The conclusion is given in Section VIII.

II. CROWD-ANTICROWD FRAMEWORK

The fundamental idea behind our crowd-based approach describing the dynamics of a complex multi-agent system, is to incorporate accurately the correlations in strategies followed by the agents. This methodology is well-known in the field of many-body theory in physics, particularly in condensed matter physics where composite ‘super-particles’ are typically considered which incorporate all the strong correlations in the system. A well-known example is an exciton gas: each exciton contains one negatively-charged electron and one positively-charged hole. Because of their opposite charges, these two particles move in opposite directions in a given electric field and attract each other strongly. However since this exciton super-particle is neutral overall, any two excitons will have a negligible interaction and hence the excitons move independently of each other. More generally, a given exciton (or so-called ‘excitonic complex’) may contain a ‘crowd’ of $n_e \geq 1$ electrons, together with a ‘crowd’ of $n_h \geq 1$ holes having opposite behavior. In an analogous way, the Crowd-Anticrowd theory in multi-agent games forms groups containing like-minded

agents (‘Crowd’) and opposite-minded agents (‘Anticrowd’). This is done in such a way that the strong strategy correlations are confined within each group, leaving weakly interacting Crowd-Anticrowd groups which then behave in an uncorrelated way with respect to each other. The first application[9] of our crowd-based approach was to the full El Farol Problem. It yielded good quantitative agreement with the numerical simulations. However the analysis was complicated by the fact that the space of strategies in the El Farol Problem is difficult to quantify. This analysis becomes far easier if the system has an underlying binary structure, as we will see in Sections III and IV. However we note that the Crowd-Anticrowd analysis is not in principle limited to such binary systems.

As indicated above, the Crowd-Anticrowd analysis breaks the N -agent population down into groups of agents, according to the correlations between these agents’ strategies. Each group G contains a crowd of agents using strategies which are positively-correlated, and a complementary anticrowd using strategies which are strongly negatively-correlated to the crowd. Hence a given group G might contain $n_R[t]$ agents who are all using strategy R and hence act as a crowd (e.g. by attending the bar en masse in the El Farol Problem) together with $n_{\bar{R}}[t]$ agents who are all using the opposite strategy \bar{R} and hence act as an anticrowd (e.g. by staying away from the bar en masse). Most importantly, the anticrowd $n_{\bar{R}}[t]$ will always take the *opposite* decisions to the crowd $n_R[t]$ *regardless* of the current circumstances in the game, since the strategies R and \bar{R} imply the opposite action in all situations. Note that this collective action may be entirely involuntary in the sense that typical games will be competitive, and there may be very limited (if any) communication between agents. Since all the strong correlations have been accounted for within each group, these individual groups $\{G\} = G_1, G_2, \dots, G_n$ will then act in an uncorrelated way with respect to each other, and hence can be treated as n uncorrelated stochastic processes. The global dynamics of the system is then given by the sum of the n uncorrelated stochastic processes generated by the groups $\{G\} = G_1, G_2, \dots, G_n$.

Regarding the special limiting case of the Minority Game (MG), we note that there have been various alternative theories proposed to describe the MG’s dynamics [12, 13, 14, 15, 16, 18, 34, 35, 37, 38]. Although elegant and sophisticated, such theories have however not been able to reproduce the original numerical results of Ref. [20] over the full range of parameter space. What is missing from such theories is an accurate description of the correlations between agents’ strategies: in essence, these correlations produce a highly-correlated form

of decision noise which cannot easily be averaged over or added in. By contrast these strong correlations take center-stage in the Crowd-Anticrowd theory, in a similar way to particle-particle correlations taking center-stage in many-body physics.

III. B-A-R (BINARY AGENT RESOURCE) SYSTEMS

A. Generic B-A-R system setup

Figure 1 summarizes the generic form of the B-A-R (Binary Agent Resource) system under consideration. At timestep t , each agent (e.g. a bar customer, a commuter, or a market agent) decides whether to enter a game where the choices are action $+1$ (e.g. attend the bar, take route A, or buy) and action -1 (e.g. go home, take route B, or sell). We will denote the number of agents choosing -1 as $n_{-1}[t]$, and the number choosing $+1$ as $n_{+1}[t]$. For simplicity, we will assume here that all the agents participate in the game at each timestep, although this is not a necessary restriction. We can define an ‘excess demand’ as

$$D[t] = n_{+1}[t] - n_{-1}[t] \quad . \quad (1)$$

As suggested in Figure 1, the agents may have connections between them: these connections may be temporary or permanent, and their functionality may be conditional on some other features in the problem. The global information available to the agents is a common memory of the recent history, i.e. the most recent m global outcomes. For example for $m = 2$, the possible forms are $\dots 00$, $\dots 01$, $\dots 10$ or $\dots 11$ which we denote simply as 00, 01, 10 or 11. Hence at each timestep, the recent history constitutes a particular bit-string of length m . For general m , there will be $P = 2^m$ possible history bit-strings. These history bit-strings can alternatively be represented in decimal form: $\mu = \{0, 1, \dots, P - 1\}$ where $\mu = 0$ corresponds to 00, $\mu = 1$ corresponds to 01 etc. A strategy consists of a predicted action, -1 or $+1$, for each possible history bit-string. Hence there are 2^P possible strategies. For $m = 2$ for example, there are therefore 16 possible strategies. In order to mimic the heterogeneity in the system, a typical game setup would have each agent randomly picking S strategies at the outset of the game. In the Minority Game, these strategies are then fixed for all time – however a more general setup would allow the strategies held, and hence the heterogeneity in the population, to change with time. The agents then update the scores of their strategies

after each timestep with $+1$ (or -1) as the pay-off for predicting the action which won (or lost). This binary representation of histories and strategies is due to Challet and Zhang [11].

B. Rules of the Game

The rules of the game determine the subsequent game dynamics. The particular rules chosen will depend on the practical system under consideration. It is an open question as to how best to abstract an appropriate ‘game’ from a real-world Complex System. In Ref. [40], we discuss multi-agent games which are relevant to financial markets. Elsewhere we plan to discuss possible choices of game for the specific case of foraging fungal colonies [42]. The foraging mechanism adopted within such networks might well be active in other biological systems, and may also prove relevant to social/economic networks. Insight into network functionality may even prove useful in designing and controlling arrays of imperfect nanostructures, microchips, nano-bio components, and other ‘systems on a chip’ [43].

The following rules need to be specified in order to fully define the dynamics of a multi-agent game:

- How is the global outcome, and hence the winning action, to be decided at each timestep t ? In a general game, the global outcome may be an arbitrary function of the values of $n_{-1}[t' \leq t]$, $n_{+1}[t' \leq t]$, and $L[t' \leq t]$ for any t' . Consider the specific case of the El Farol Problem: we can define the action $+1$ (-1) to be attend (stay away) with $L[t]$ representing the bar capacity. If $n_{+1}[t] < L[t]$, the bar will be undercrowded and hence can be assigned the global outcome 0. Hence the winning action is $+1$ (i.e. attend). Likewise if $n_{+1}[t] > L[t]$, the bar will be overcrowded and can be assigned the global outcome 1. The winning action is then -1 (i.e. stay away). However more generally, the global outcome and hence winning action may be any function of present or past system data. Furthermore, the resource level $L[t]$ may be endogenously produced (e.g. a specific function of past values of $n_{-1}[t]$, $n_{+1}[t]$) or exogenously produced (e.g. determined by external environmental concerns). Figure 1 denotes the global outcome (and hence winning action) algorithm as lying in the hands of a fictitious ‘Game-master’, who aggregates the information in the game such as $n_{+1}[t]$, $n_{-1}[t]$ and $L[t]$, and then announces the global outcome. We note that in principle, the agents themselves do not actually need to know what game they are playing. Instead they are just

fed with the global outcome: each of their S strategies are then rewarded/penalized according to whether the strategy predicted the winning/losing action. One typical setup has agents adding/deducting one virtual point from strategies that would have suggested the winning/losing action.

- How do agents decide which strategy to use? Typically one might expect agents to play their highest scoring strategy, as in the original El Farol Problem and Minority Game. However agents may instead adopt a stochastic method for choosing which strategy to use at each timestep. There may even be ‘dumb’ agents, who use their worst strategy at each timestep. Of course, it is not obvious that such agents would then necessarily lose, i.e. whether such a method is actually dumb will depend on the decisions of the other agents.
- What happens in a strategy tie-break situation? Suppose agents are programmed to always use their highest-scoring strategy. If an agent were then to hold two or more strategies that are tied for the position of highest-scoring strategy, then a rule must be invoked for breaking this tie. One example would be for the agent to toss a fair coin in order to decide which of his tied strategies to use at that turn of the game. Alternatively, an agent may prefer to stick with the strategy which was higher on the previous timestep.
- What are the rules governing the connections between agents? In terms of structure, the connections may be hard-wired or temporary, random or ordered or partially ordered (e.g. scale-free network or small-world network). In terms of functionality, there is also an endless set of possible choices of rules. For example, any two connected agents might compare the scores of their highest scoring strategies, and hence adopt the predicted action of whichever strategy is overall the highest-scoring. Just as above, a tie-break rule will then have to be imposed for the case where two connected agents have equal-scoring highest strategies – for example a coin-toss might be invoked, or a ‘selfish’ rule may be used whereby an agent sticks with his own strategy in the event of such a tie. The connections themselves may have directionality, e.g. perhaps agent b can influence agent d but not vice-versa. Or maybe the connection (e.g. between b and a) is inactive unless a certain criterion is met. Hence it may turn out that agent b follows d even though agent d is actually following agent a .

- Do agents have to play at each timestep? For simplicity in the present paper, we will consider that this is the case. This rule is easily generalized by introducing a confidence level: if the agent doesn't hold any strategies with sufficiently high success rate, then the agent does not participate at that timestep. This in turn implies that the number of agents participating at each timestep fluctuates. We do not pursue this generalization here, but note that its effect is to systematically prevent the playing of low-scoring strategies which are anticorrelated to the high-scoring strategies. For financial markets, for example, this extra property of confidence-level is a crucial ingredient for building a realistic market model, since it leads to fluctuations in the 'volume' of active agents [32, 40].

We emphasize that the set-up in Figure 1 does not make any assumptions about the actual game being played, nor how the winning decision is to be decided. Instead, one hopes to obtain a fairly general description of the type of dynamics which are possible *without* having to specify the exact details of the game. On the other hand, situations can arise where the precise details of the strategy tie-break mechanism, for example, have a fundamental impact on the type of dynamics exhibited by the system and hence its overall performance in terms of achieving some particular goal. We refer to Ref. [44] for an explicit example of this, for the case of network-based multi-agent systems.

C. Strategy Space

Figure 2 shows in more detail the $m = 2$ example strategy space from Figure 1. A strategy is a set of instructions to describe what an agent should do in any given situation, i.e. given any particular history μ , the strategy then decides what action the agent should take. The strategy space is the set of strategies from which agents are allocated their strategies. If this strategy allocation is fixed randomly at the outset, then this acts as a source of quenched disorder. Alternatively, the strategy allocation may be allowed to evolve in response to the system's dynamics. In the case that the initial strategy allocation is fixed, it is clear that the agents playing the game are limited, and hence may become 'frustrated', by this quenched disorder. The strategy space shown is known as the Full Strategy Space FSS, and contains all possible permutations of the actions -1 and $+1$ for each history. As such there are 2^{2^m} strategies in this space. The 2^m dimensional hypercube shows all 2^{2^m} strategies from the

FSS at its vertices. Of course, there are many additional strategies that could be thought of, but which aren't present within the FSS. For example, the simple strategies of persistence and anti-persistence are not present in the FSS. The advantage however of using the FSS is that the strategies form a complete set, and as such the FSS displays no bias towards any particular action for a given history. To include any additional strategies like persistence and anti-persistence would mean opening up the strategy space, hence losing the simplicity of the B-A-R structure and returning to the complexity of Arthur's original El Farol Problem [8, 9].

It can be observed from the FSS, that one can choose a subset of strategies [11] such that any pair within this subset has one of the following characteristics:

- anti-correlated, e.g. $-1-1-1-1$ and $+1+1+1+1$, or $-1-1+1+1$ and $+1+1-1-1$. For example, any two agents using the ($m = 2$) strategies $-1-1+1+1$ and $+1+1-1-1$ respectively, would take the opposite action irrespective of the sequence of previous outcomes and hence the history. Hence one agent will always do the opposite of the other agent. For example, if one agent chooses $+1$ at a given timestep, the other agent will choose -1 . Their net effect on the demand $D[t]$ therefore cancels out at each timestep, regardless of the history. Hence they will not contribute to fluctuations in $D[t]$.
- uncorrelated, e.g. $-1-1-1-1$ and $-1-1+1+1$. For example, any two agents using the strategies $-1-1-1-1$ and $-1-1+1+1$ respectively, would take the opposite action for two of the four histories, while they would take the same action for the remaining two histories. If the $m = 2$ histories occur equally often, the actions of the two agents will be uncorrelated on average.

A convenient measure of the distance (i.e. closeness) of any two strategies is the Hamming distance which is defined as the number of bits that need to be changed in going from one strategy to another. For example, the Hamming distance between $-1-1-1-1$ and $+1+1+1+1$ is 4, while the Hamming distance between $-1-1-1-1$ and $-1-1+1+1$ is just 2. Although there are $2^P \equiv 2^{2^{m-2}} \equiv 16$ strategies in the $m = 2$ strategy space, it can be seen that one can choose subsets such that any strategy-pair within this subset is either anti-correlated or uncorrelated. Consider, for example, the two groups

$$U_{m=2} \equiv \{-1-1-1-1, +1+1-1-1, +1-1+1-1, -1+1+1-1\} \quad (2)$$

and

$$\overline{U_{m=2}} \equiv \{+1 + 1 + 1 + 1, -1 - 1 + 1 + 1, -1 + 1 - 1 + 1, +1 - 1 - 1 + 1\}. \quad (3)$$

Any two strategies within $U_{m=2}$ are uncorrelated since they have a Hamming distance of 2. Likewise any two strategies within $\overline{U_{m=2}}$ are uncorrelated since they have a relative Hamming distance of 2. However, each strategy in $U_{m=2}$ has an anti-correlated strategy in $\overline{U_{m=2}}$: for example, $-1 - 1 - 1 - 1$ is anti-correlated to $+1 + 1 + 1 + 1$, $+1 + 1 - 1 - 1$ is anti-correlated to $-1 - 1 + 1 + 1$ etc. This subset of strategies comprising $U_{m=2}$ and $\overline{U_{m=2}}$, forms a Reduced Strategy Space (RSS) [11]. Since it contains the essential correlations of the Full Strategy Space (FSS), running a given game simulation within the RSS is likely to reproduce the main features obtained using the FSS [11]. The RSS has a smaller number of strategies $2 \cdot 2^m = 2P \equiv 2^{m+1}$ than the FSS which has $2^P = 2^{2^m}$. For $m = 2$, there are 8 strategies in the RSS compared to 16 in the FSS, whilst for $m = 8$ there are 1.16×10^{77} strategies in the FSS but only 512 strategies in the RSS. We note that the choice of the RSS is not unique, i.e. within a given FSS there are many possible choices for a RSS. In particular, it is possible to create $2^{2^m}/2^{m+1}$ distinct reduced strategy spaces from the FSS. In short, the RSS provides a minimal set of strategies which ‘span’ the FSS and are hence representative of its full structure.

D. History Space

The history μ of recent outcomes changes in time, i.e. it is a dynamical variable. The history dynamics can be represented on a directed graph (a so-called digraph). The particular form of directed graph is called a de Bruijn graph. Figure 3 shows some examples of the de Bruijn graph for $m = 1, 2$, and 3. The probability that the outcome at time $t + 1$ will be a 1 (or 0) depends on the state at time t . Hence it will depend on the previous m outcomes, i.e. it depends on the particular state of the history bit-string. The dependence on earlier timesteps means that the game is not Markovian. However, modifying the game such that there is a finite time-horizon for scoring strategies, may then allow the resulting game to be viewed as a high-dimensional Markov process (see Refs. [29, 30] for the case of the Minority Game).

E. Heterogeneity in strategy allocation, and initial conditions

The dynamics for a particular run of the B-A-R system will depend upon the strategies that the agents hold, and the random process used to decide tie-breaks. The particular dynamics which emerge also depend upon the initial score-vector of the strategies and the initial history used to seed the start of the game. If the initial strategy score-vector is not ‘typical’, then a bias can be introduced into the game which never disappears. In short, the system never recovers from this bias. It will be assumed that no such initial bias exists. In practice this is achieved, for example, by setting all the initial scores to zero. The initial choice of history is not considered to be an important effect. It is assumed that any transient effects resulting from the particular history seed will have disappeared, i.e. the initial history seed does not introduce any long-term bias.

The strategy allocation among agents can be described in terms of a tensor Ω [31]. This tensor Ω describes the distribution of strategies among the N individual agents. If this strategy allocation is fixed from the beginning of the game, then it acts as a quenched disorder in the system. The rank of the tensor Ω is given by the number of strategies S that each agent holds. For example, for $S = 3$ the element $\Omega_{i,j,k}$ gives the number of agents assigned strategy i , then strategy j , and then strategy k , in that order. Hence

$$\sum_{i,j,k,\dots}^X \Omega_{i,j,k,\dots} = N, \tag{4}$$

where the value of X represents the number of distinct strategies that exist within the strategy space chosen: $X = 2^{2^m}$ in the FSS, and $X = 2.2^m$ in the RSS. Figure 4 shows an example distribution Ω for $N = 101$ agents in the case of $m = 2$ and $S = 2$, in the reduced strategy space RSS. We note that a single Ω ‘macrostate’ corresponds to many possible ‘microstates’ describing the specific partitions of strategies among the agents. For example, consider an $N = 2$ agent system with $S = 1$: the microstate (R, R') in which agent 1 has strategy R while agent 2 has strategy R' , belongs to the same macrostate Ω as (R', R) in which agent 1 has strategy R' while agent 2 has strategy R . Hence the present Crowd-Anticrowd theory retained at the level of a given Ω , describes the set of all games which belong to that same Ω macrostate. We also note that although Ω is not symmetric, it can be made so since the agents will typically not distinguish between the order in which the two strategies are picked. Given this, we will henceforth focus on $S = 2$ and consider the

symmetrized version of the strategy allocation matrix given by $\Psi = \frac{1}{2}(\Omega + \Omega^T)$. In general, Ψ would be allowed to change in time, possibly evolving under some pre-defined selection criteria. In David Smith’s paper elsewhere in this Workshop, changes in Ψ are invoked in order to control the future evolution of the multi-agent game: this corresponds to a change in heterogeneity in the agent population, and could represent the physical situation where individual agents (e.g. robots) could be re-wired, re-programmed, or replaced in order to invoke a change in the system’s future evolution, or to avoid certain future scenarios or trajectories for the system as a whole.

F. Design Criteria for Collective

In addition to the excess demand $D[t]$ in such B-A-R systems, one is typically also interested in higher order-moments of this quantity – for example, the standard deviation of $D[t]$ (or ‘volatility’ in a financial context). This gives a measure of the fluctuations in the system, and hence can be used as a measure of ‘risk’ in the system. In particular the standard deviation gives an idea of the size of typical fluctuations in the system. However in the case that $D[t]$ has a power-law distribution, the standard deviation may be a misleading representation of such risk because of the ‘heavy tails’ associated with the power-law [40]. Practical risk is arguably better associated with the probability of the system hitting a certain critical value (D_{crit}), in a similar way to the methodology of financial Value-at-Risk [40]. However a note of caution is worthwhile: if there are high-order correlations in the system and hence in the time-series $D[t]$ itself, any risk assessment based on Probability Distribution Functions over a fixed time-scale (e.g. single timestep) may be misleading. Instead, it may be the *cumulative* effects of a string of large negative values of $D[t]$ which constitute the true risk, since these may take the system into dangerous territory. The possibility of designing a Collective in order to build in some form of immunization/resistance to such large cumulative changes or endogenous ‘extreme events’, or alternatively the possibility of performing ‘on-line’ soft control in an evolving system, is a fascinating topic. We again refer to the paper of David Smith elsewhere in this Workshop for a detailed discussion of these topics. For simplicity, we will focus here on developing a description of $D[t]$ and its standard deviation, noting that the same analytic approach would work equally well for other statistical functions of $D[t]$.

IV. CROWD-ANTICROWD FORMALISM

Here we focus on developing a description of $D[t]$ and its standard deviation. Similar analysis can be carried out for any function of $D[t]$. For example, the function $f[D[t]] \equiv [D[t] - \langle D[t] \rangle]^\alpha$ with $\alpha > 2$, places more weighting on large deviations of $D[t]$ from the mean. Alternatively, one may consider a function of past values $\{D[t' < t]\}$, such as the cumulative value $P[t] = \sum_i D[t_i < t]$, or any function of the constituent processes $n_{+1}[t]$ and $n_{-1}[t]$.

Consider an arbitrary timestep t during a run of the game, at which the particular realization of the strategy allocation matrix is given by Ψ . We will assume that Ψ is effectively constant over the time-window during which we will calculate the statistical properties of $D[t]$. There is a current score-vector $\underline{S}[t]$ and a current history $\mu[t]$ which define the state of the game. The excess demand $D[t] = D[\underline{S}[t], \mu[t]]$ is given by Equation 1. The standard deviation of $D[t]$ for this given run, corresponds to a time-average for a given realization of Ψ and a given set of initial conditions. It may turn out that we are only interested in ensemble-averaged quantities: consequently the standard deviation will then need to be averaged over many runs, and hence averaged over all realizations of Ψ *and* all sets of initial conditions.

Equation 1 can be rewritten by summing over the RSS as follows:

$$D[\underline{S}[t], \mu[t]] = n_{+1}[t] - n_{-1}[t] \equiv \sum_{R=1}^{2P} a_R^{\mu[t]} n_R^{\underline{S}[t]}, \quad (5)$$

where $P = 2^m$. The quantity $a_R^{\mu[t]} = \pm 1$ is the response of strategy R to the history bit-string μ at time t . The quantity $n_R^{\underline{S}[t]}$ is the number of agents using strategy R at time t . The superscript $\underline{S}[t]$ is a reminder that this number of agents will depend on the strategy score at time t . The calculation of the average demand $D[t]$ will now be shown, where the average is over time for a given realization of the strategy allocation Ψ . We use the notation $\langle X[t] \rangle_t$ to denote a time-average over the variable $X[t]$ for a given Ψ . Hence

$$\begin{aligned} \langle D[\underline{S}[t], \mu[t]] \rangle_t &= \sum_{R=1}^{2P} \langle a_R^{\mu[t]} n_R^{\underline{S}[t]} \rangle_t \\ &= \sum_{R=1}^{2P} \langle a_R^{\mu[t]} \rangle_t \langle n_R^{\underline{S}[t]} \rangle_t \end{aligned} \quad (6)$$

where we have used the property that $a_R^{\mu[t]}$ and $n_R^{\underline{S}[t]}$ are uncorrelated. We now consider the special case in which all histories are visited equally on average: this may arise as the result

of a periodic cycling through the history space (e.g. a Eulerian trail around the de Bruijn graph) or if the histories are visited randomly. Even if this situation does not hold for a specific Ψ , it may indeed hold once the averaging over Ψ has also been taken. For example, in the Minority Game all histories are visited equally at small m and a given Ψ : however the same is only true for large m if we take the additional average over all Ψ . Under the property of equal histories, we can write

$$\begin{aligned}
\langle D[\underline{S}[t], \mu[t]] \rangle_t &= \sum_{R=1}^{2P} \left(\frac{1}{P} \sum_{\mu=0}^{P-1} a_R^{\mu[t]} \right) \langle n_R^{\underline{S}[t]} \rangle_t \\
&= \sum_{R=1}^P \left(\frac{1}{P} \sum_{\mu=0}^{P-1} a_R^{\mu[t]} + a_{\overline{R}}^{\mu[t]} \right) \langle n_R^{\underline{S}[t]} \rangle_t \\
&= \sum_{R=1}^P 0 \cdot \langle n_R^{\underline{S}[t]} \rangle_t \\
&= 0
\end{aligned} \tag{7}$$

where we have used the exact result that $a_R^{\mu[t]} = -a_{\overline{R}}^{\mu[t]}$ for all $\mu[t]$, and the approximation $\langle n_R^{\underline{S}[t]} \rangle_t = \langle n_{\overline{R}}^{\underline{S}[t]} \rangle_t$. This approximation is reasonable for a competitive game since there is typically no a priori best strategy, hence each strategy has its own ‘five minutes of glory’: if the strategies are distributed fairly evenly among the agents, this then implies that the average number playing each strategy is approximately equal and hence $\langle n_R^{\underline{S}[t]} \rangle_t = \langle n_{\overline{R}}^{\underline{S}[t]} \rangle_t$. In the event that all histories are not equally visited over time, even after averaging over all Ψ , it may still happen that the system’s dynamics is restricted to equal visits to some *subset* of histories. An example of this would arise for $m = 3$, for example, for a repetitive sequence of outcomes $\dots 00110011001$ in which case the system repeatedly performs the 4-cycle $\dots \rightarrow 001 \rightarrow 011 \rightarrow 110 \rightarrow 100 \rightarrow 001 \rightarrow \dots$. In this case one can then carry out the averaging in Equation 7 over this subspace of four histories, implying that there are now strategies that are effectively identical (i.e. they have the same response for these four histories, even though they differ in their response for one or more of the remaining four histories 000, 010, 101, 111 which are not visited). More generally, such sub-cycles within the de Bruijn graph may lead to a bias towards 1’s or 0’s in the global outcome sequence. We note that such a biased series of outcomes can also be generated by biasing the initial strategy pool.

We will focus now on the fluctuations of $D[t]$ about its average value. The variance of

$D[t]$, which is the square of the standard deviation, is given by

$$\sigma_{\Psi}^2 = \left\langle D [\underline{S}[t], \mu[t]]^2 \right\rangle_t - \left\langle D [\underline{S}[t], \mu[t]] \right\rangle_t^2 . \quad (8)$$

For simplicity, we will assume the game output is unbiased and hence we can set $\left\langle D [\underline{S}[t], \mu[t]] \right\rangle_t = 0$. As mentioned above, this might arise in a given system for a given Ψ , or after additional averaging over all possible configurations $\{\Psi\}$. We stress that this approximation does not *have* to be made – one can simply continue subtracting $\left\langle D [\underline{S}[t], \mu[t]] \right\rangle_t^2$ from the right hand side of the expression for σ_{Ψ}^2 . Hence

$$\begin{aligned} \sigma_{\Psi}^2 &= \left\langle D [\underline{S}[t], \mu[t]]^2 \right\rangle_t \\ &= \sum_{R, R'=1}^{2P} \left\langle a_R^{\mu[t]} n_R^{\underline{S}[t]} a_{R'}^{\mu[t]} n_{R'}^{\underline{S}[t]} \right\rangle_t . \end{aligned} \quad (9)$$

In the case that the system visits all possible histories equally, the double sum can usefully be broken down into three parts, based on the correlations between the strategies: $\underline{a}_R \cdot \underline{a}_{R'} = P$ (fully correlated), $\underline{a}_R \cdot \underline{a}_{R'} = -P$ (fully anti-correlated), and $\underline{a}_R \cdot \underline{a}_{R'} = 0$ (fully uncorrelated) where \underline{a}_R is a vector of dimension P with R 'th component $a_R^{\mu[t]}$. This decomposition is exact in the RSS in which we are working. Again we note that if all histories are not equally visited, yet some subset are, then this averaging can be carried out over the restricted subspace of histories. The equal-histories case yields

$$\begin{aligned} \sigma_{\Psi}^2 &= \sum_{R=1}^{2P} \left\langle \left(a_R^{\mu[t]} \right)^2 \left(n_R^{\underline{S}[t]} \right)^2 \right\rangle_t + \sum_{R=1}^{2P} \left\langle a_R^{\mu[t]} a_{\bar{R}}^{\mu[t]} n_R^{\underline{S}[t]} n_{\bar{R}}^{\underline{S}[t]} \right\rangle_t + \sum_{R \neq R' \neq \bar{R}}^{2P} \left\langle a_R^{\mu[t]} a_{R'}^{\mu[t]} n_R^{\underline{S}[t]} n_{R'}^{\underline{S}[t]} \right\rangle_t \\ &= \sum_{R=1}^{2P} \left\langle \left(n_R^{\underline{S}[t]} \right)^2 - n_R^{\underline{S}[t]} n_{\bar{R}}^{\underline{S}[t]} \right\rangle_t + \sum_{R \neq R' \neq \bar{R}}^{2P} \left\langle a_R^{\mu[t]} a_{R'}^{\mu[t]} \right\rangle_t \left\langle n_R^{\underline{S}[t]} n_{R'}^{\underline{S}[t]} \right\rangle_t \\ &= \sum_{R=1}^{2P} \left\langle \left(n_R^{\underline{S}[t]} \right)^2 - n_R^{\underline{S}[t]} n_{\bar{R}}^{\underline{S}[t]} \right\rangle_t + \sum_{R \neq R' \neq \bar{R}}^{2P} \left(\frac{1}{P} \sum_{\mu=0}^{P-1} a_R^{\mu[t]} a_{R'}^{\mu[t]} \right) \left\langle n_R^{\underline{S}[t]} n_{R'}^{\underline{S}[t]} \right\rangle_t \\ &= \sum_{R=1}^{2P} \left\langle \left(n_R^{\underline{S}[t]} \right)^2 - n_R^{\underline{S}[t]} n_{\bar{R}}^{\underline{S}[t]} \right\rangle_t . \end{aligned} \quad (10)$$

This sum over $2P$ terms can be written equivalently as a sum over P terms,

$$\begin{aligned} \sigma_{\Psi}^2 &= \sum_{R=1}^{2P} \left\langle \left(n_R^{\underline{S}[t]} \right)^2 - n_R^{\underline{S}[t]} n_{\bar{R}}^{\underline{S}[t]} \right\rangle_t \\ &= \sum_{R=1}^P \left\langle \left(n_R^{\underline{S}[t]} \right)^2 - n_R^{\underline{S}[t]} n_{\bar{R}}^{\underline{S}[t]} + \left(n_{\bar{R}}^{\underline{S}[t]} \right)^2 - n_{\bar{R}}^{\underline{S}[t]} n_R^{\underline{S}[t]} \right\rangle_t \end{aligned} \quad (11)$$

$$\begin{aligned}
&= \sum_{R=1}^P \left\langle \left(n_R^{S[t]} \right)^2 - 2n_R^{S[t]} n_{\bar{R}}^{S[t]} + \left(n_{\bar{R}}^{S[t]} \right)^2 \right\rangle_t \\
&= \sum_{R=1}^P \left\langle \left(n_R^{S[t]} - n_{\bar{R}}^{S[t]} \right)^2 \right\rangle_t \equiv \left\langle \sum_{R=1}^P \left(n_R^{S[t]} - n_{\bar{R}}^{S[t]} \right)^2 \right\rangle_t.
\end{aligned}$$

The values of $n_R^{S[t]}$ and $n_{\bar{R}}^{S[t]}$ for each R will depend on the precise form of Ψ . We now proceed to consider the ensemble-average over all possible realizations of the strategy allocation matrix Ψ . The ensemble-average is denoted as $\langle \dots \rangle_{\Psi}$, and for simplicity the notation $\langle \sigma_{\Psi}^2 \rangle_{\Psi} = \sigma^2$ is defined. This ensemble-average is performed on either side of Equation 11,

$$\sigma^2 = \left\langle \left\langle \sum_{R=1}^P \left(n_R^{S[t]} - n_{\bar{R}}^{S[t]} \right)^2 \right\rangle_t \right\rangle_{\Psi} \quad (12)$$

yielding the variance in the excess demand $D[t]$. Equation 12 is an important intermediary result for the Crowd-Anticrowd theory. It is straightforward to obtain analogous expressions for the variances in $n_{+1}[t]$ and $n_{-1}[t]$.

A. Quantitative theory

Equation 12 provides us with an expression for the time-averaged fluctuations. Some form of approximation must be introduced in order to reduce Equation 12 to explicit analytic expressions. It turns out that Equation 12 can be manipulated in a variety of ways, depending on the level of approximation that one is prepared to make. The precise form of any resulting analytic expression will depend on the details of the approximations made.

We now turn to the problem of evaluating Equation 12 analytically. A key first step is to relabel the strategies. Specifically, the sum in Equation 12 is re-written to be over a *virtual-point ranking* K and not the decimal form R . Consider the variation in points for a given strategy, as a function of time for a given realization of Ψ . The ranking (i.e. label) of a given strategy in terms of virtual-points score will typically change in time since the individual strategies have a variation in virtual-points which also varies in time. For the Minority Game, this variation is quite rapid in the low m regime since there are many more agents than available strategies – hence any strategy emerging as the instantaneously highest-scoring, will immediately get played by many agents and therefore be likely to lose on the next time-step. More general games involving competition within a multi-agent population, will typically generate a similar ecology of strategy-scores with no all-time winner. [N.B. If

this weren't the case, then there would by definition be an absolute best, second-best etc. strategy. Hence any agent observing the game from the outside would be able to choose such a strategy and win consistently. Such a system is not sufficiently competitive, and is hence not the type of system we have in mind]. This implies that the specific identity of the ' K 'th highest-scoring strategy' changes frequently in time. It also implies that $n_R^{S[t]}$ varies considerably in time. Therefore in order to proceed, we shift the focus onto the time-evolution of the highest-scoring strategy, second highest-scoring strategy etc. This should have a much smoother time-evolution than the time-evolution for a given strategy. In short, the focus is shifted from the time-evolution of the virtual points of a given strategy (i.e. from $S_R[t]$) to the time-evolution of the virtual points of the K 'th highest scoring strategy (i.e. to $S_K[t]$).

Figure 5 shows a schematic representation of how the scores of the two top scoring strategies might vary, using the new virtual-point ranking scheme. Also shown are the lowest-scoring two strategies, which at every timestep are obviously just the anticorrelated partners of the instantaneously highest-scoring two strategies. In the case that the strategies all start off with zero points, these anticorrelated strategies appear as the mirror-image, i.e. $S_K[t] = -S_{\bar{K}}[t]$. The label K is used to denote the rank in terms of strategy score, i.e. $K = 1$ is the highest scoring strategy position, $K = 2$ is the second highest-scoring strategy position etc. with

$$S_{K=1} > S_{K=2} > S_{K=3} > S_{K=4} > \dots \quad (13)$$

assuming no strategy-ties. (Whenever strategy ties occur, this ranking gains a 'degeneracy' in that $S_K = S_{K+1}$ for a given K). A given strategy, e.g. $-1 - 1 - 1 - 1$, may at a given timestep have label $K = 1$, while a few timesteps later have label $K = 5$. Given that $S_R = -S_{\bar{R}}$ (i.e. all strategy scores start off at zero), then we know that $S_K = -S_{\bar{K}}$. Equation 12 can hence be rewritten exactly as

$$\sigma^2 = \left\langle \left\langle \sum_{K=1}^P \left(n_K^{S[t]} - n_{\bar{K}}^{S[t]} \right)^2 \right\rangle \right\rangle_t \Psi. \quad (14)$$

Now we make another important observation. Since in the systems of interest the agents are typically playing their highest-scoring strategies, then the relevant quantity in determining how many agents will instantaneously play a given strategy, is a knowledge of its relative ranking – not the actual value of its virtual points score. This suggests that the quantities

$n_K^{S[t]}$ and $n_{\bar{K}}^{S[t]}$ will fluctuate relatively little in time, and that we should now develop the problem in terms of time-averaged values.

The actual number of agents $n_K^{S[t]}$ playing the K 'th ranked strategy at timestep t , can be determined from knowledge of the strategy allocation matrix Ψ and the strategy scores $S[t]$, in order to calculate how many agents hold the K 'th ranked strategy but *do not* hold another strategy with higher-ranking. The heterogeneity in the population represented by Ψ , combined with the strategy scores $S[t]$, determines $n_K^{S[t]}$ for each K and hence the standard deviation in $D[t]$. We can rewrite the number of agents playing the strategy in position K at any timestep t , in terms of some constant value n_K plus a fluctuating term :

$$n_K^{S[t]} = n_K + \varepsilon_K[t] . \quad (15)$$

Consider a given timestep t in the game's evolution. Some strategies may be tied in virtual-points (i.e. they are 'degenerate') while others are not (i.e. 'non-degenerate'). Depending on the rules of the game, such degeneracy may imply one of the following: (i) an agent must throw a coin to break a tie between any two degenerate strategies in his possession. In this case, any two agents holding the same pair of degenerate strategies may then disagree as to the ranking of the two strategies following the tie-break coin toss. (ii) The Game-master must throw a master coin in order to produce a non-degenerate ranking. In this case, all agents will then agree on a unique virtual-point ranking of strategies. (iii) An agent must preserve the ranking from the most recent timestep at which the two strategies weren't degenerate. Depending on the exact microscopic rule adopted, the global dynamics may differ. We will generally assume that rule (i) holds, since rule (ii) might introduce large random fluctuations while rule (iii) could favor deterministic cyclic behavior. Suppose that an agent holds two strategies R and R' , and that they are non-degenerate at timestep t . Suppose that they occupy ranks K and $K + 1$ respectively. Let the number of agents playing strategy R , the K 'th ranked strategy, be n_K at timestep t . Similarly the number of agents playing strategy R' , the $(K + 1)$ 'th ranked strategy, is n_{K+1} at timestep t . Hence $\varepsilon_K[t] = 0$ and $\varepsilon_{K+1}[t] = 0$ for this timestep, and indeed for all subsequent t until the next strategy-tie. Suppose that the two strategies R and R' now become degenerate at timestep $t + 1$. In a game where each agent resolves strategy tie-breaks using a coin-toss, then both R and R' have probability $1/2$ of being assigned the rank K at this timestep. This means that any agent holding strategies R and R' , will play R or R' with probability $1/2$. Hence

such degeneracy acts to add disorder into the number of agents playing the K 'th highest-scoring strategy. In particular, such coin-tosses at a given timestep t' will tend to reduce the number of agents playing higher-scoring strategies at that timestep (i.e. $\varepsilon_K[t'] < 0$ for small K) but will increase the number of agents playing lower-scoring strategies (i.e. $\varepsilon_K[t'] > 0$ for large K). Therefore if we were to completely ignore coin-tosses, we would tend to overestimate the number of people playing strategies which are higher-ranking (i.e. small K) and underestimate the number playing strategies which are lower-ranking (i.e. large K). This means that we will overestimate the size of Crowds, and underestimate the size of Anticrowds. Hence we will *overestimate* the value of the standard deviation of demand. [For this reason, the analytic expression $\sigma^{\text{delta } f}$ that we will derive, slightly *overestimates* the actual value, and hence can be regarded as an approximate *upper-bound* as shown later in Figure 7]. Accounting for the correct fraction of degenerate vs. non-degenerate timesteps, will yield a more accurate calculation of the time-average $\langle \dots \rangle_t$ in Equation 14. We will adopt this latter approach elsewhere for the network B-A-R system [44], thereby obtaining accurate analytic expressions which are in excellent quantitative agreement with numerical simulations.

Since our focus in this paper is more general, let us for the moment assume that we can choose a suitable constant n_K such that the fluctuation $\varepsilon_K[t]$ represents a small noise term. Hence,

$$\begin{aligned}
\sigma^2 &= \left\langle \sum_{K=1}^P \left\langle [n_K + \varepsilon_K[t] - n_{\overline{K}} - \varepsilon_{\overline{K}}[t]]^2 \right\rangle_t \right\rangle_{\Psi} & (16) \\
&= \left\langle \sum_{K=1}^P \left\langle [(n_K - n_{\overline{K}}) + (\varepsilon_K[t] - \varepsilon_{\overline{K}}[t])]^2 \right\rangle_t \right\rangle_{\Psi} \\
&= \left\langle \sum_{K=1}^P \left\langle [n_K - n_{\overline{K}}]^2 + [\varepsilon_K[t] - \varepsilon_{\overline{K}}[t]]^2 + [2(n_K - n_{\overline{K}})(\varepsilon_K[t] - \varepsilon_{\overline{K}}[t])] \right\rangle_t \right\rangle_{\Psi} \\
&\approx \left\langle \sum_{K=1}^P \left\langle [n_K - n_{\overline{K}}]^2 \right\rangle_t \right\rangle_{\Psi} = \left\langle \sum_{K=1}^P [n_K - n_{\overline{K}}]^2 \right\rangle_{\Psi},
\end{aligned}$$

since the latter two terms involving noise will average out to be small. The resulting expression in Equation 16 involves no time dependence. The averaging over Ψ can then be taken inside the sum. The individual terms in the sum, i.e. $\langle [n_K - n_{\overline{K}}]^2 \rangle_{\Psi}$, are just an expectation value of a function of two variables n_K and $n_{\overline{K}}$. Each term can therefore be rewritten exactly using the joint probability distribution for n_K and $n_{\overline{K}}$, which we shall call

$P(n_K, n_{\overline{K}})$. Hence

$$\begin{aligned}\sigma^2 &= \sum_{K=1}^P \left\langle [n_K - n_{\overline{K}}]^2 \right\rangle_{\Psi} \\ &= \sum_{K=1}^P \sum_{n_K=0}^N \sum_{n_{\overline{K}}=0}^N [n_K - n_{\overline{K}}]^2 P(n_K, n_{\overline{K}}),\end{aligned}\tag{17}$$

where the standard probability result involving functions of two variables has been used.

In the event that Equation 17 is a reasonable approximation for the system under study, the question then arises as to how to evaluate it. In general, its value will depend on the detailed form of the joint probability function $P(n_K, n_{\overline{K}})$ which in turn will depend on the ensemble of quenched disorders $\{\Psi\}$ which are being averaged over. We start off by looking at Equation 17 in the limiting case where the averaging over the quenched disorder matrix is dominated by matrices Ψ which are nearly flat. This will be a good approximation in the ‘crowded’ limit of small m in which there are many more agents than available strategies, since the standard deviation of an element in Ψ (i.e. the standard deviation in bin-size) is then much smaller than the mean bin-size. [N.B. If Ω is approximately flat, then so is Ψ]. In this limiting case, there are several nice features:

- Given the ranking in terms of virtual-points, i.e. $S_{K=1} > S_{K=2} > S_{K=3} > S_{K=4} > \dots$ which holds by definition of the labels $\{K\}$ if we neglect tie-breaks, we will also have

$$n_{K=1} > n_{K=2} > n_{K=3} > n_{K=4} > \dots\tag{18}$$

Hence the rankings in terms of highest virtual-points and popularity are identical. By contrast, the ordering in terms of the labels $\{R\}$ would not be sequential, i.e. it is *not* true that $n_{R=1} > n_{R=2} > n_{R=3} > n_{R=4} > \dots$

- The strategy \overline{K} , which is anticorrelated to strategy K , occupies position $\overline{K} = 2P + 1 - K$ in this popularity-ranked list.
- The probability distribution $P(n_K, n_{\overline{K}})$ will be sharply peaked around the n_K and $n_{\overline{K}}$ values given by the mean values for a flat quenched-disorder matrix Ψ . We will label these mean values as \overline{n}_K and $\overline{n}_{\overline{K}}$.

The last point implies that $P(n_K, n_{\overline{K}}) = \delta_{n_K, \overline{n}_K} \delta_{n_{\overline{K}}, \overline{n}_{\overline{K}}}$ and so

$$\sigma^2 = \sum_{K=1}^P [\overline{n}_K - \overline{n}_{\overline{K}}]^2.\tag{19}$$

We note that there is a very simple interpretation of Equation 19. It represents the sum of the variances for each Crowd-Anticrowd pair. For a given strategy K there is an anticorrelated strategy \overline{K} . The \overline{n}_K agents using strategy K are doing the *opposite* of the $\overline{n}_{\overline{K}}$ agents using strategy \overline{K} *irrespective* of the history bit-string. Hence the effective group-size for each Crowd-Anticrowd pair is $n_K^{eff} = \overline{n}_K - \overline{n}_{\overline{K}}$: this represents the net step-size d of the Crowd-Anticrowd pair in a random-walk contribution to the total variance. Hence, the net contribution by this Crowd-Anticrowd pair to the variance is given by

$$[\sigma^2]_{K\overline{K}} = 4pqd^2 = 4 \cdot \frac{1}{2} \cdot \frac{1}{2} [n_K^{eff}]^2 = [\overline{n}_K - \overline{n}_{\overline{K}}]^2 \quad (20)$$

where $p = q = 1/2$ for a random walk. Since all the strong correlations have been removed (i.e. anti-correlations) it can therefore be assumed that the separate Crowd-Anticrowd pairs execute random walks which are *uncorrelated* with respect to each other. [Recall the properties of the RSS - all the remaining strategies are uncorrelated.] Hence the total variance is given by the sum of the individual variances,

$$\sigma^2 = \sum_{K=1}^P [\sigma^2]_{K\overline{K}} = \sum_{K=1}^P [\overline{n}_K - \overline{n}_{\overline{K}}]^2, \quad (21)$$

which corresponds exactly to Equation 19. If strategy-ties occur frequently, then one has to be more careful about evaluating \overline{n}_K since its value may be affected by the tie-breaking rule. We will show elsewhere that this becomes quite important in the case of very small m in the presence of network connections - this is because very small m naturally leads to crowding in strategy space and hence mean-reverting virtual scores for strategies. This mean-reversion is amplified further by the presence of network connections which increases the crowding, thereby increasing the chance of strategy ties.

V. IMPLEMENTATION OF CROWD-ANTICROWD THEORY

In this section we will consider the application of the Crowd-Anticrowd theory in some limiting cases. As suggested by the previous discussion, we will break the implementation of the Crowd-Anticrowd theory down into two separate regimes: small m , corresponding to many more agents than available strategies, and large m corresponding to the opposite case. Hence these two regimes are defined by the ratio of the number of strategies to agents being much less/greater than unity, and hence the strategy allocation matrix Ψ being densely/sparsely filled.

A. Flat quenched disorder matrix Ψ , small m

Each element of Ψ has a mean of $N/(2P)^S$ agents per ‘bin’. In the case of small m and hence densely-filled Ψ , the fluctuations in the number of agents per bin will be small compared to this mean value. For the case $S = 2$, the mean number of agents whose highest scoring strategy is the strategy occupying position K at timestep t , will therefore be given by summing the appropriate rows and columns of this quenched disorder matrix Ψ . Figure 6 provides a schematic representation of Ψ with $m = 2$, $s = 2$, in the RSS. If the matrix Ψ is flat, then any re-ordering due to changes in the strategy ranking has no effect on the form of the matrix. Therefore the number of agents playing the K 'th highest-scoring strategy, will always be proportional to the number of shaded bins at that K (see Fig. 6 for $K = 3$). The shaded elements in Figure 6 therefore represent those agents who hold a strategy that is ranked third highest in score, i.e. $K = 3$. In games where the agents use their highest scoring strategy, any agent using the strategy in position $K = 3$ cannot have any strategy with a higher position. Hence the agents using the strategy in position $K = 3$ must lie in one of the shaded bins. Since it is assumed that the coverage of the bins is uniform, the mean number of agents using the strategy in position $K = 3$ is given by

$$\begin{aligned}\overline{n_{K=3}} &= N \cdot \frac{1}{(2P)^2} \sum(\text{shaded bins}) \\ &= N \cdot \frac{1}{64} \cdot [(8 - 3) + (8 - 3) + 1] \\ &= \frac{11}{64} N.\end{aligned}\tag{22}$$

For more general m and s values this becomes

$$\begin{aligned}\overline{n_K} &= \frac{N}{(2P)^S} [S(2P - K)^{S-1} + \frac{S(S-1)}{2}(2P - K)^{S-2} + \dots + 1] \\ &= \frac{N}{(2P)^S} \sum_{r=0}^{S-1} \frac{S!}{(S-r)!r!} [2P - K]^r \\ &= \frac{N}{(2P)^S} ([2P - K + 1]^S - [2P - K]^S) \\ &= N \cdot \left(\left[1 - \frac{(K-1)}{2P} \right]^S - \left[1 - \frac{K}{2P} \right]^S \right),\end{aligned}\tag{23}$$

with $P \equiv 2^m$. In the case where each agent holds two strategies, $S = 2$, $\overline{n_K}$ can be simplified to

$$\overline{n_K} = N \cdot \left(\left[1 - \frac{(K-1)}{2P} \right]^2 - \left[1 - \frac{K}{2P} \right]^2 \right) = \frac{(2^{m+2} - 2K + 1)}{2^{2(m+1)}} N.\tag{24}$$

Similarly for $\overline{n_{\overline{K}}}$ the simplification is as follows:

$$\overline{n_{\overline{K}}} = \frac{(2^{m+2} - 2\overline{K} + 1)}{2^{2(m+1)}}N = \frac{(2K - 1)}{2^{2(m+1)}}N, \quad (25)$$

where the relation $\overline{K} = 2P - K + 1 \equiv 2^{m+1} - K + 1$ has been used. It is emphasized that these results depend on the assumption that the averages are dominated by the effects of flat distributions of the quenched disorder matrix Ψ , and hence will only be quantitatively valid for low m . Using Equations 24 and 25 in Equation 19 gives

$$\begin{aligned} \sigma^2 &= \sum_{K=1}^P \left[\frac{(2^{m+2} - 2K + 1)}{2^{2(m+1)}}N - \frac{(2K - 1)}{2^{2(m+1)}}N \right]^2 \\ &= \frac{N^2}{2^{2(2m+1)}} \sum_{K=1}^P [2^{m+1} - 2K + 1]^2 \\ &= \frac{N^2}{3 \cdot 2^m} (1 - 2^{-2(m+1)}), \end{aligned} \quad (26)$$

and hence

$$\sigma^{\text{delta } f} = \frac{N}{\sqrt{3 \cdot 2^{m/2}}} (1 - 2^{-2(m+1)})^{\frac{1}{2}}, \quad (27)$$

which is valid for small m . (The rationale behind the choice of superscript ‘delta f ’ will become apparent shortly.) This derivation has assumed that there are no strategy ties – more precisely, we have assumed that the game rules governing strategy ties do not upset the identical forms of the rankings in terms of highest virtual points and popularity. As discussed earlier, this tends to overestimate the size of the Crowds using high-ranking strategies, and underestimate the size of the Anticrowds using low-ranking strategies. Hence the Crowd-Anticrowd cancellation is underestimated, and consequently $\sigma^{\text{delta } f}$ will overestimate the actual σ value. As we will see later in Figure 7, $\sigma^{\text{delta } f}$ does indeed act as an approximate upper bound.

B. Non-flat quenched disorder matrix Ψ , small m

The appearance of a significant number of non-flat quenched disorder matrices Ψ in the ensemble, implies that the standard deviation for each ‘bin’ is now significant, i.e. non-negligible compared to the mean. This will be increasingly true as m increases. In this case, the general analysis is much more complicated, and should really appeal to the dynamics. However, an approximate theory can still be developed. The features for the case of ensem-

bles containing a significant number of non-flat quenched disorder matrices Ψ become as follows:

- By definition of the labels $\{K\}$, the ranking in terms of virtual-points is retained, i.e. $S_{K=1} > S_{K=2} > S_{K=3} > S_{K=4} > \dots$ is still always true in the absence of strategy ties. However the disorder in the matrix Ψ may distort the number of agents playing a given strategy to such an extent, that it is no longer true that $n_{K=1} > n_{K=2} > n_{K=3} > n_{K=4} > \dots$. Hence the rankings in terms of highest virtual-points and popularity are no longer identical. Another way of saying this is that the disorder in Ψ has introduced a disorder into the popularity ranking, such that it now differs from the virtual-point ranking. [We note that this disordering effect in the popularity ranking arising from the non-flat Ψ , occurs in addition to the disordering effect due to coin-toss tie-breaking of strategy degeneracies discussed earlier].
- In general we now have that $n_{K'} > n_{K''} > n_{K'''} > n_{K''''} > \dots$, where the label K' need not equal 1, and K'' need not equal 2 etc.. It is however possible to introduce a new label $\{Q\}$ which will rank the strategies in terms of popularity, i.e.

$$n_{Q=1} > n_{Q=2} > n_{Q=3} > n_{Q=4} > \dots, \quad (28)$$

where $Q = 1$ represents K' , $Q = 2$ represents K'' , etc.

With this in mind, we will return to the original general form for the standard deviation of the excess demand in Equation 17, but rewrite it slightly as follows:

$$\begin{aligned} \sigma^2 &= \sum_{K=1}^P \sum_{n_K=0}^N \sum_{n_{\bar{K}}=0}^N [n_K - n_{\bar{K}}]^2 P(n_K, n_{\bar{K}}) \\ &= \frac{1}{2} \sum_{K=1}^{2P} \sum_{n_K=0}^N \sum_{n_{\bar{K}}=0}^N [n_K - n_{\bar{K}}]^2 P(n_K, n_{\bar{K}}) \\ &= \frac{1}{2} \sum_{K=1}^{2P} \sum_{K'=1}^{2P} \left\{ \sum_{n_K=0}^N \sum_{n_{K'}=0}^N [n_K - n_{K'}]^2 P(n_K, n_{K'}) \right\} f_{K', \bar{K}}, \end{aligned} \quad (29)$$

where $f_{K', \bar{K}}$ is the probability that K' is the anticorrelated strategy to K (i.e. \bar{K}) and is hence given by $f_{K', \bar{K}} = \delta_{K', 2P+1-K}$. This manipulation is exact so far.

A switch is now made to the popularity-labels $\{Q\}$. After relabelling, we obtain:

$$\sigma^2 = \frac{1}{2} \sum_{Q=1}^{2P} \sum_{Q'=1}^{2P} \left\{ \sum_{n_Q=0}^N \sum_{n_{Q'}=0}^N [n_Q - n_{Q'}]^2 P(n_Q, n_{Q'}) \right\} f_{Q', \bar{Q}}, \quad (30)$$

where $f_{Q',\bar{Q}}$ is the probability that the strategy with label Q' is anticorrelated to Q . Consider any particular strategy which was labelled previously by K and is now labelled by Q . Unlike the case of the flat disorder matrix, it is *not* guaranteed that this strategy's anticorrelated partner will lie in position $Q' = 2P + 1 - Q$. All that can be said is that the strategy R has changed label from $K \rightarrow Q(K)$ while the anticorrelated strategy has changed label from $\bar{K} \rightarrow \bar{Q}(\bar{K})$ and that in general $\bar{Q} \neq 2P + 1 - Q$. As stated earlier, we have as a result of the relabelling that $n_{Q=1} > n_{Q=2} > n_{Q=3} > n_{Q=4} > \dots$. It can be assumed that as a zeroth-order approximation the values of $n_{Q=1}$, $n_{Q=2}$, $n_{Q=3}, \dots$ etc. are still sharply peaked around their mean values obtained for the flat-matrix case, i.e. it is assumed that the probability distribution $P(n_{Q(K)}, n_{Q'(\bar{K})})$ will be sharply peaked around the $n_{Q(K)}$ and $n_{Q'(\bar{K})}$ values given by the mean values for a flat matrix. As before, we will label these values \bar{n}_Q and $\bar{n}_{Q'}$ where the intrinsic dependence of Q on K has been dropped. Hence $P(n_Q, n_{Q'}) = \delta_{n_Q, \bar{n}_Q} \delta_{n_{Q'}, \bar{n}_{Q'}}$ with \bar{n}_Q and $\bar{n}_{Q'}$ given by the bin-counting method. Substituting in $P(n_Q, n_{Q'}) = \delta_{n_Q, \bar{n}_Q} \delta_{n_{Q'}, \bar{n}_{Q'}}$ gives

$$\sigma^2 = \frac{1}{2} \sum_{Q=1}^{2P} \sum_{Q'=1}^{2P} [\bar{n}_Q - \bar{n}_{Q'}]^2 f_{Q',\bar{Q}}, \quad (31)$$

where the function $f_{Q',\bar{Q}}$, which is the probability that the strategy with label Q' is anticorrelated to strategy Q , still needs to be specified.

So what should the form of $f_{Q',\bar{Q}}$ be? In the limit of negligible matrix disorder at small m , as studied in the previous section, it will be a delta-function at $Q' = 2P + 1 - Q \equiv \bar{Q}$ since in this case the rankings in terms of popularity and virtual-points will once more be identical. Hence we recover the results of the previous section. However, as the relative importance of disorder in Ψ increases, the delta-function form will no longer be appropriate. One approximate solution to this problem is to assume that the resulting disorder in the popularity ranking (as compared to the original virtual-point ranking) is so strong, that the probability that Q' is anticorrelated to Q becomes *independent* of the label Q' and is hence given by $1/(2P)$. Hence the anticorrelated strategy to Q could lie *anywhere* in the strategy list $\{Q'\} = 1, \dots, 2P$. In this sense, this is the opposite limit to the delta-function case corresponding to the flat disorder matrix at small m . Hence instead of being a delta-function at $Q' = 2P + 1 - Q$, it now follows that $f_{Q',\bar{Q}}$ has a 'flat' form given by $1/(2P)$. In

this limiting case we have

$$\sigma^{\text{flat } f} = \frac{N}{\sqrt{3} \cdot 2^{(m+1)/2}} (1 - 2^{-2(m+1)})^{\frac{1}{2}}. \quad (32)$$

Comparing this with Equation 27 it can be seen that

$$\sigma^{\text{flat } f} = \frac{1}{\sqrt{2}} \sigma^{\text{delta } f} \approx 0.7 \sigma^{\text{delta } f} \quad (33)$$

for the case of $S = 2$. The superscripts ‘flat f ’ and ‘delta f ’ used in the previous section, therefore can be seen to refer to the form of the probability function $f_{Q', \bar{Q}}$. We emphasize that Equation 27 can be derived from Equation 31 by letting $f_{Q', \bar{Q}}$ take the delta-function form $\delta_{Q', 2P+1-Q}$ peaked at $Q' = 2P + 1 - Q \equiv \bar{Q}$.

C. Non-flat quenched disorder matrix Ψ , large m

For larger m , the standard deviation in the number of agents in a given bin is now similar to the mean value. (By large m it is meant that the number of strategies is greater than N , i.e. $2 \cdot 2^m > N$.) Furthermore, there tend to be either 0 or 1 agents in each box (Q, Q'). In this limit, there will tend to be $O(N)$ crowds, with each crowd having $O(1)$ agent. Hence the popularity ordering is highly degenerate since $n_Q = 0, 1$ for all Q . Since the anticorrelated strategy to Q could be anywhere, we have $f_{Q', \bar{Q}} = 1/(2P)$. Using Equation 31 then gives

$$\begin{aligned} \sigma^2 &= \frac{1}{2} \sum_{Q=1}^{2P} \sum_{Q'=1}^{2P} [\bar{n}_Q - \bar{n}_{Q'}]^2 f_{Q', \bar{Q}} \\ &= \sum_{Q=1}^N \left\{ [(\bar{n}_Q = 1) - (\bar{n}_{Q'} = 1)]^2 \frac{N}{2P} + [(\bar{n}_Q = 1) - (\bar{n}_{Q'} = 0)]^2 \frac{2P - N}{2P} \right\}, \end{aligned} \quad (34)$$

where the sum is now performed over the N strategies with one agent subscribed. Simplifying this expression gives

$$\begin{aligned} \sigma^{\text{flat } f, \text{ high } m} &= \left(\sum_{Q=1}^N [(\bar{n}_Q = 1) - (\bar{n}_{Q'} = 0)]^2 \frac{2P - N}{2P} \right)^{\frac{1}{2}} \\ &= \left(N \cdot \frac{2P - N}{2P} \right)^{\frac{1}{2}} \\ &= \sqrt{N} \left(1 - \frac{N}{2^{m+1}} \right)^{\frac{1}{2}}, \end{aligned} \quad (35)$$

where $P \equiv 2^m$ has been used. We note in passing that it is quite simple to obtain a slightly more sophisticated approximation for $f_{Q', \bar{Q}}$ which incorporates the agents’ behavior

in picking their most successful strategy. For general S , this then yields

$$\sigma^{\text{flat } f, \text{ high } m} = \sqrt{N} \left(1 - \frac{NS - 1}{2^{m+1}}\right)^{\frac{1}{2}} . \quad (36)$$

[N.B. This latter expressions gives an even better fit to the numerical results shown later in Figure 7].

D. Reduced vs. Full Strategy Space

The general dynamics for a typical game are likely to be similar in character when played in both the FSS and the RSS [11]. Hence the RSS-based Crowd-Anticrowd theory would generally be expected to provide a valid description for games played in the FSS as well. In addition to straightforward numerical demonstration for the particular game of interest, there is a theoretical justification which goes as follows. For a game played in the FSS there are $2^{2^m}/2.2^m$ distinct subsets of strategies. Each subset can be considered as a separate RSS. Note that the strategies that belong to a given RSS are optimally spread out across the corresponding FSS hypercube. Figure 2 shows the distribution of the 16, $m = 2$ strategies across the 4 dimensional hypercube. The positions of the strategies belonging to the RSS are such that no two strategies have a Hamming separation less than $2^m/2$. The same can be said for any other choice of RSS. Due to the nature of a RSS, and given similar strings of past outcomes over which to score strategies, each strategy within the RSS attains a score in an uncorrelated or anticorrelated manner to any other strategy in the subset. Any other RSS within the FSS will score its strategies in a similar way, although slightly out of phase. For example for $m = 3$, the first RSS to be considered could contain the strategy 00001111, and the second RSS considered could contain the strategy 01001111. It is easy to see that on 7 out of 8 occasions these two strategies would score in the same way. Hence it can be seen that these two strategies from two separate RSS, will follow each other during a typical run of an unbiased game. This argument extends across all strategies in all of the $2^{2^m}/2.2^m$ distinct RSS's within the FSS. Hence a game using the FSS behaves as if there are 2.2^m clusters of strategies and so is similar to a game played in the RSS. These clusters form the Crowds and Anticrowds of the theory, and this clustering allows the use of just one RSS in the theory.

VI. CROWD-ANTICROWD THEORY APPLIED TO GENERALIZED MINORITY GAMES

In this section we show that the present Crowd-Anticrowd theory, even within its RSS formulation, provides a quantitative theory for both the Minority Game and several variants. There is currently no other analytic theory which can match the quantitative agreement of the Crowd-Anticrowd theory over such a parameter range, and over such a range of game variants. This justifies our belief that the Crowd-Anticrowd theory is an important milestone in such multi-agent systems, and possibly even for Complex Systems in general. It is also pleasing from the point of view of physics methodology, since the basic underlying philosophy of accounting correctly for ‘inter-particle’ correlations is already known to be successful in more conventional areas of many-body physics. This success in turn raises the intriguing possibility that conventional many-body physics might itself be open to re-interpretation in terms of an appropriate multi-particle ‘game’: we leave this for future work.

A. Basic Minority Game

Figure 7 shows the standard deviation σ of the excess demand $D[t]$, obtained for the particular case of the Minority Game. The analytic results were taken from Sections VA, VB and VC. The results are shown as a function of agent memory size m . The spread in numerical values from individual runs, for a given m , indicates the extent to which the choice of Ψ alters the dynamics of the MG. The upper line for each S value at low m , is Equation 27 showing $\sigma^{\text{delta } f}$. The lower line for each S value at low m , is Equation 32 showing $\sigma^{\text{flat } f}$. The line at high m is Equation 35 showing $\sigma^{\text{flat } f, \text{ high } m}$, and is independent of S . Comparing the analytic curves with the numerical results, it can be seen that the analytic expressions capture the essential physics (i.e. the strong correlations) driving the fluctuations in the system.

B. Alloy Minority Game

Here we consider the Crowd-Anticrowd theory applied to a mixed population containing agents of different memory-sizes (or equivalently, agents with differing opinions as to the relative importance of previous outcomes) [25]. Since we are interested in the effects of

crowding within this mixed-ability population, we will focus on small m . Consider a population containing some agents with memory m_1 , and some agents with memory m_2 where $m_1 < m_2$. For a pure population of agents with the same memory m_1 , there is information left in the history time-series [20]. In the small m_1 limit, however, this information is hidden in bit-strings of length greater than m_1 and hence is not accessible to these agents. However it would in principle be accessible to agents with a larger memory m_2 .

In the mixed population or ‘alloy’, there are two sub-populations comprising N_{m_1} agents with memory m_1 and S_1 strategies per agent, and $N_{m_2} = N - N_{m_1}$ agents with memory m_2 and S_2 strategies per agent. Let us focus on the variance σ^2 of demand $D[t]$. If each population were pure, it would form Crowd-Anticrowd groups as discussed earlier in this paper, and hence provide a variance given by the sum of the variances of these uncorrelated groups. In the mixed population, we can assume as a first approximation that the individual groups for different m are also uncorrelated. In short, the agents looking at patterns of length m_1 , and the agents looking at patterns of length m_2 , act in an uncorrelated way with respect to each other. Hence the variance in the total $D[t]$ from both sub-populations, can be obtained by adding separately the contributions to the variance from the m_1 agents and the m_2 agents. Hence $\sigma^2 = \sigma_1^2 + \sigma_2^2$, where σ_1 (σ_2) is the variance due to the m_1 (m_2) agents. Defining the concentration of m_1 agents as $x = N_{m_1}/N$, gives $\sigma_1^2 = C^2(m_1, S_1)x^2N^2$ and $\sigma_2^2 = C^2(m_2, S_2)(1-x)^2N^2$ where the expressions for $C^2(m_1, S_1)$ and $C^2(m_2, S_2)$ follow from Equations 19 and 23:

$$C^2(m_i, S_i) = \sum_{K=1}^{2^{m_i}} \left(\left[1 - \frac{(K-1)}{2^{m_i+1}} \right]^{S_i} - \left[1 - \frac{K}{2^{m_i+1}} \right]^{S_i} - \left[1 - \frac{(2^{m_i+1} - K)}{2^{m_i+1}} \right]^{S_i} + \left[1 - \frac{2^{m_i+1} + 1 - K}{2^{m_i+1}} \right]^{S_i} \right)^2 \quad (37)$$

Hence

$$\sigma = N[C^2(m_1, S_1)x^2 + C^2(m_2, S_2)(1-x)^2]^{1/2}. \quad (38)$$

It can be seen that Equation 38 will generally exhibit a *minimum* in σ at finite x , hence the mixed population uses the limited global resource more efficiently than a pure population of either (m_1, S_1) or (m_2, S_2) agents. This analytic result has been confirmed in numerical simulations of a mixed population [25, 32].

C. Thermal Minority Game

In the ‘Thermal Minority Game’ (TMG) [37], agents choose between their S strategies using an exponential probability weighting. As pointed out by Marsili *et al* [17], such a probabilistic strategy weighting has a long tradition in economics and encodes a particular behavioral model. The numerical simulations of Cavagna *et al* demonstrated that at small m , where the MG σ is larger-than-random, the TMG σ could be pushed below the random coin-toss limit just by altering this relative probability weighting, or equivalently the ‘temperature’ T [37]. This reduction in σ for stochastic strategies seems fairly general: for example, in Ref. [33] we had presented a modified MG in which agents with stochastic strategies also generate a smaller-than-random σ . The common underlying phenomenon in both cases is that stochastic strategy rules tend to reduce (increase) the typical size of Crowds (Anticrowds), which in turn implies an *increase* in the cancellation between the actions of the Crowds and Anticrowds. Hence σ gets reduced, and can even fall below the random coin-toss limit [33, 37].

We will now show that the Crowd-Anticrowd theory provides a quantitative explanation of the main result of Ref. [37], whereby a smaller-than-random σ is generated with increasing ‘temperature’ [26, 27] at small m . We therefore focus on small m , and assume a nearly flat strategy allocation matrix Ψ . At any moment in the game, strategies can be ranked according to their virtual points, $K = 1, 2 \dots 2^{m+1}$ where $K = 1$ is the best strategy, $K = 2$ is second best, etc. Consider any two strategies ranked K and K^* within the list of 2^{m+1} strategies in the RSS. As mentioned earlier, in the small m regime of interest the virtual-point strategy ranking and popularity ranking for strategies are essentially the same. Consider $S = 2$ as an example. Let $p(K, K^* | K^* \geq K)$ be the probability that a given agent possesses K and K^* , where $K^* \geq K$ (i.e. K is the best, or equal best, among his $S = 2$ strategies). In contrast, let $p(K, K^* | K^* \leq K)$ be the probability that a given agent possesses K and K^* , where $K^* \leq K$ (i.e. K is the worst, or equal worst, among his $S = 2$ strategies). Let θ be the probability that the agent uses the worst of his $S = 2$ strategies, while $1 - \theta$ is the probability that he uses the best. The probability that the agent plays K is then given by

$$\begin{aligned}
 p_K &= \sum_{K^*=1}^{2^{m+1}} [\theta p(K, K^* | K^* \leq K) + (1 - \theta) p(K, K^* | K^* \geq K)] \\
 &= \theta p_-(K) + 2^{-2(m+1)} \theta + (1 - \theta) p_+(K)
 \end{aligned}
 \tag{39}$$

where $p_+(K) = \sum_{K^*} p(K, K^* | K^* \geq K)$ is the probability that the agent has picked K and that K is the agent's best (or equal best) strategy; $p_-(K) = \sum_{K^*} p(K, K^* | K^* < K)$ is the probability that the agent has picked K and that K is the agent's worst strategy. Using Equation 23 it is straightforward to show that

$$p_+(K) = \left(\left[1 - \frac{(K-1)}{2^{m+1}} \right]^2 - \left[1 - \frac{K}{2^{m+1}} \right]^2 \right) . \quad (40)$$

Note that $p_+(K) + p_-(K) = p(K)$ where

$$p(K) = 2^{-m} (1 - 2^{-(m+2)}) \quad (41)$$

is the probability that the agent holds strategy K after his $S = 2$ picks, with no condition on whether it is best or worst. An expression for $p_-(K)$ follows from Equations 40 and 41. The basic MG corresponds to the case $\theta = 0$.

In the TMG, each agent is equipped at each timestep with his own (biased) coin characterised by exponential probability weightings [37, 45]. An agent then flips this coin at each timestep to decide which strategy to use [37]. To relate the present analysis to the TMG in Ref. [37], $0 \leq \theta \leq 1/2$ is considered: $\theta = 0$ corresponds to 'temperature' $T = 0$ while $\theta \rightarrow 1/2$ corresponds to $T \rightarrow \infty$ [45] with $\theta = 1/2[1 - \tanh(1/T)]$. Consider the mean number of agents playing strategy K , which is now given by

$$\overline{n_K} = N p_K = N (1 - 2\theta) p_+(K) + N \theta p(K) + 2^{-2(m+1)} N \theta . \quad (42)$$

Recall Equation 19

$$\sigma_\theta = \left[\sum_{K=1}^P [\overline{n_K} - \overline{n_{\overline{K}}}]^2 \right]^{\frac{1}{2}} \quad (43)$$

The quantities $\overline{n_K}$ and $\overline{n_{\overline{K}}}$ are now θ -dependent (see Equation 42). Realizing that only the first term in Equation 42 is actually a function of K and hence substituting Equations 40, 41 and 42 for K and \overline{K} into Equation 19 yields

$$\sigma_\theta = |1 - 2\theta| \sigma_{\theta=0} \quad (44)$$

where $\sigma_{\theta=0}$ is the standard deviation when $\theta = 0$, i.e. the standard deviation of $D[t]$ obtained for the basic MG. Equation 44 explicitly shows that the standard deviation σ_θ *decreases* as θ increases (recall $0 \leq \theta \leq 1/2$): in other words, the standard deviation decreases as agents use their worst strategy with increasing probability. An increase in θ leads to a reduction in

the size of the larger Crowds using high-scoring strategies, as well as an increase in the size of the smaller Anticrowds using lower-scoring strategies, hence resulting in a more substantial cancellation effect between the Crowd and the Anticrowd. As θ increases, σ_θ will eventually drop *below* the random coin-toss result at $\theta = \theta_c$ where

$$\theta_c = \frac{1}{2} - \frac{\sqrt{N}}{2} \frac{1}{\sigma_{\theta=0}} . \quad (45)$$

We now switch to the popularity labels $\{Q\}$ in order to examine σ in the two limits of ‘delta f ’, and ‘flat f ’. The delta-function distribution is $\delta_{Q', 2^{m+1}+1-Q}$ which is peaked at $Q' = 2^{m+1} + 1 - Q$, while the flat distribution is given by $1/(2P) = [2^{-(m+1)}]$. Employing these approximate distributions once again, the resulting expressions for σ_θ are

$$\sigma_\theta^{\text{delta } f} = (1 - 2\theta) \frac{N}{\sqrt{3} 2^{\frac{m}{2}}} \left(1 - 2^{-2(m+1)}\right)^{\frac{1}{2}} \quad (46)$$

and

$$\sigma_\theta^{\text{flat } f} = (1 - 2\theta) \frac{N}{\sqrt{3} 2^{(m+1)/2}} \left(1 - 2^{-2(m+1)}\right)^{\frac{1}{2}} \quad (47)$$

respectively. For the TMG, $\theta = (1/2)[1 - \tanh(1/T)]$ although we again emphasize that the Crowd-Anticrowd theory is not limited to the case of ‘thermal’ strategy weightings.

Figure 8 shows a comparison between the theory of Equations 46, 47 and numerical simulation for various runs, $m = 2$ and $S = 2$. The theory agrees well in the range $\theta = 0 \rightarrow 0.35$ and, most importantly, provides a quantitative explanation for the transition in σ from larger-than-random to smaller-than-random as θ (and hence T) is increased. The numerical data for different runs has a significant natural spread. Most of these data points do lie in the region in between the two analytic curves, which act as approximate upper and lower-bounds. Above $\theta = 0.35$, the numerical data tend to flatten off while the present theory predicts a decrease in σ as $\theta \rightarrow 0.5$. This is because the present theory averages out the fluctuations in strategy-use at each time-step (Equation 42 only considers the mean number of agents using a strategy of given rank). Consider $\theta = 0.5$. For a particular configuration of strategies picked at the start of the game, and at a particular moment in time, the number of agents using each strategy is typically distributed *around* the mean value $\overline{n_K} = N2^{-(m+1)}$ given by Equation 42 for $\theta = 0.5$. The resulting distribution describing the strategy-use is therefore non-flat. It is these fluctuations about the mean values $\overline{n_K}$ and $\overline{\overline{n_K}}$ which give rise to a non-zero σ . The Crowd-Anticrowd theory can be extended to account for the effect of these fluctuations in strategy-use for $\theta \rightarrow 0.5$ in the following way: All N agents are

randomly assigned $S = 2$ strategies. To represent a turn in the game, each agent flips a (fair) coin to decide which of the two strategies is the preferred one. Having generated a list of the number of agents using each strategy, σ is then found in the usual way by cancelling off crowds and anticrowds. A time-averaged value for σ is then obtained by averaging over 100 independent coin-flip outcomes for the given initial distribution of strategies among agents Ψ . This procedure provides a semi-analytic calculation for the value of σ at $\theta = 0.5$. It is also possible to perform a fully analytic calculation of the average σ_θ in the $\theta \rightarrow 0.5$ limit: the initial random assignment of strategies can be modelled using a random-walk. This yields an average value of $[\overline{n_K} - \overline{n_{\bar{K}}}]^2$ (i.e. time-averaged over the fluctuations) given by $N2^{-m}(1 - 2^{-(m+1)})$. Summing over all pairs of correlated-anticorrelated strategies, i.e. all Crowd-Anticrowd pairs, yields a (configuration-average) standard deviation given by

$$\sigma_{\theta \rightarrow 0.5} = \sqrt{N}[1 - 2^{-2(m+1)}]^{1/2}. \quad (48)$$

The agreement for $\theta \rightarrow 0.5$ is good. Note that at finite m , the value of $\sigma_{\theta \rightarrow 0.5}$ will always lie *below* the random coin-toss limit \sqrt{N} , regardless of the value of N . Hence the theoretical and numerical results agree, but neither is equal to the random coin-toss limit as $\theta \rightarrow 0.5$ (i.e. $T \rightarrow \infty$). Interestingly, we can therefore conclude that the high-temperature limit in this system does not strictly correspond to the random coin-toss limit, regardless of the value of N .

D. Thermal Alloy Minority Game

A variation of the Thermal Minority Game is now considered in which a concentration q of agents employ a probabilistic strategy selection at each turn of the game. In particular, these agents play their worst strategy with probability θ , and hence play their best strategy with probability $(1 - \theta)$. These qN agents will be called ‘TMG agents’ because of the direct connection with the Thermal Minority Game discussed above. The remaining $(1 - q)N$ agents choose their best strategy with probability unity (i.e. $\theta = 0$ as in the basic MG) hence they will be called ‘MG agents’. Numerical simulations show that as the concentration q of TMG agents increases, or the probability θ (i.e. T) increases, the standard deviation σ decreases. We will now give the analytic explanation of this in terms of Crowd-Anticrowds.

Recall from Equation 39, the probability that the agent plays the K 'th highest scoring

strategy is given by

$$\begin{aligned} p_K^{\text{TMG}} &= \sum_{K^*=1}^{2^{m+1}} [\theta p(K, K^* | K^* \leq K) + (1 - \theta) p(K, K^* | K^* \geq K)] \\ &= \theta p_-(K) + 2^{-2(m+1)} \theta + (1 - \theta) p_+(K) \end{aligned} \quad (49)$$

Setting $\theta = 0$ in Equation 39 gives the probability that an MG agent plays K

$$p_K^{\text{MG}} = p_+(K) . \quad (50)$$

The mean number of agents \overline{n}_K playing strategy K in the mixed-population game containing a concentration q of TMG agents and $(1 - q)$ of MG agents is now considered. This is given by

$$\begin{aligned} \overline{n}_K &= q N p_K^{\text{TMG}} + (1 - q) N p_K^{\text{MG}} \\ &= N (1 - 2 q \theta) p_+(K) + N q \theta p(K) + 2^{-2(m+1)} N q \theta . \end{aligned} \quad (51)$$

Following the same analysis as in the previous section for the Thermal Minority Game, we obtain

$$\sigma(q, \theta) = [1 - 2 q \theta] \{\sigma(q, \theta)\}_{q\theta=0} \quad (52)$$

where $\{\sigma(q, \theta)\}_{q\theta=0}$ is just the standard deviation for the basic MG (i.e. $q = 0$ and/or $\theta = 0$). Equation 52 predicts that the effect on the standard deviation caused by a change in population composition and/or ‘temperature’ can be described by a simple prefactor $[1 - 2q\theta]$. Provided that the basic MG is in the crowded regime as discussed earlier, Equation 52 holds for all N and m and hence any value of $\{\sigma(q, \theta)\}_{q\theta=0}$. Hence a critical value q_c can be predicted for fixed θ , or θ_c for fixed q , at which $\sigma(q, \theta)$ crosses from worse-than-random to better-than-random. For a given value of θ , it follows from Equation 52 that

$$q_c(\theta) = \frac{1}{2\theta} - \frac{\sqrt{N}}{2\theta} \frac{1}{\{\sigma(q, \theta)\}_{q\theta=0}} . \quad (53)$$

A similar expression follows for $\theta_c(q)$. Given that $0 \leq \theta \leq 1/2$, Equation 53 implies that the run-averaged numerical volatility should lie above the random coin-toss value if $q < q_c^*$ where

$$q_c^* = 1 - \sqrt{N} \frac{1}{\{\sigma(q, \theta)\}_{q\theta=0}} , \quad (54)$$

regardless of ‘temperature’ T . Since the N and m values considered are such that the basic MG is in the worse-than-random regime, $\{\sigma(q, \theta)\}_{q\theta=0} \geq \sqrt{N}$ and therefore $0 \leq q_c^* \leq 1$ as

required. Similarly $\sigma(q, \theta)$ will remain above the random coin-toss value for all q if $\theta < \theta_c^*$ where

$$\theta_c^* = \frac{1}{2} - \frac{\sqrt{N}}{2} \frac{1}{\{\sigma(q, \theta)\}_{q\theta=0}}. \quad (55)$$

VII. B-A-R SYSTEMS WITH AN UNDERLYING NETWORK STRUCTURE

We now extend the above analysis to the case of a network connection between agents. In the first subsection, we consider the appropriate modification of the $\overline{n_K}$ values. In the second sub-section, we follow the spirit of the alloy game mentioned above, whereby we consider the case of very few connections within the population in order to show that in principle the standard deviation can actually decrease as network connections are added.

A. Modification of $\overline{n_K}$

The presence of a network allows for a sharing of information across that network. Depending on the rules of the game regarding information exchange, the connected agents may decide to adopt the strategy prediction of agents to whom they are connected. The Crowd-Anticrowd calculation can be generalized to incorporate such situations by forming new expressions for $\overline{n_K}$. In particular, the bin-counting method to give $\overline{n_K}$ must now be generalized to account for (i) any agent whose own strategies are lower ranking than K , but who is connected to another agent holding strategy K , and (ii) any agent whose highest-scoring strategy is K , but who has a connection to another agent with an even higher-scoring strategy. The contribution (i) will increase $\overline{n_K}$ above the bin-counting value, however contribution (ii) then reduces it. The competition between these two effects will determine what then happens to the standard deviation in the presence of connections.

We will consider the following rule governing functionality of connections. Consider agent i connected to agent j in a game where each agent holds S strategies (e.g. $S = 2$). We also suppose for the moment, that the ranking of strategies is unique (i.e. there are no strategies which are tied in virtual-points). Suppose that the highest-ranking strategy of agent i is G , but that the highest-ranking strategy of agent j is K where $K < G$ and hence K has higher virtual-point score than G . For the particular connection rule we have in mind, we will let agent i therefore have access to the highest-scoring strategy of agent j . In other words,

agent i now uses strategy K since it is the highest-scoring of the $2S$ strategies that the two agents hold between them. Of course, agent i may also be connected to other agents – he will therefore use the highest-scoring strategy among all the agents to whom he is connected. In the case that agent j holds the highest-scoring strategy of them all, then agent i uses the strategy ranked K . The same is true for all other agents. Hence we need to modify the calculation of \overline{n}_K in order to incorporate this effect. In particular, the number of agents using the K 'th ranked strategy at a particular timestep in the game-with-network will be

$$\overline{n}_K^{\text{net}} = \overline{n}_K + n_{\rightarrow K} - n_{K\rightarrow} \quad (56)$$

where $n_{\rightarrow K}$ is a sum over all agents who are connected to an agent whose highest-ranking strategy is K , and who themselves have a highest-ranked strategy G which is worse than K (i.e. G is lower-ranked than K and hence $G > K$). Hence these agents use K , whereas in the absence of the network they would have used their own strategy which is lower-ranked than K . By contrast, $n_{K\rightarrow}$ is a sum over all agents whose highest-ranking strategy is K , but who are connected to an agent whose highest-ranked strategy G is better than K (i.e. G is higher-ranked than K and hence $G < K$). Hence these agents use G , whereas in the absence of the network they would have used K . Notice that this is irrespective of the actual structure of the network, for example the network could be random, small-world, scale-free, or regular.

In order to implement the renormalization of \overline{n}_K in a particular example, we consider the case of a random network in which agent i has a probability of p of forming a connection with agent j . The term $n_{\rightarrow K}$ is given by summing over all agents whose own highest-scoring strategy J is lower-ranked than K (i.e. $J > K$) *given* that they hold at least one connection to an agent whose highest-scoring strategy is K *but* they don't have any connections to any agents with a higher-ranked strategy G (i.e. $G < K$). The resulting expression is

$$n_{\rightarrow K} = \left[\sum_{J>K} \overline{n}_J \right] \left[(1-p)^{\sum_{G<K} \overline{n}_G} \right] \left[1 - (1-p)^{\overline{n}_K} \right] \quad (57)$$

where the third factor represents the probability that a given agent holds at least one connection to an agent whose highest-scoring strategy is K , the second factor accounts for the probability that a given agent is not connected to any agent whose highest-scoring strategy G is higher-ranked than K , and the first factor sums over all agents whose highest-

scoring strategy J is lower-ranked than K . Continuing this analysis, we have

$$n_{K \rightarrow} = \overline{n}_K \left[1 - (1 - p)^{\sum_{G < K} \overline{n}_G} \right] \quad (58)$$

where the second factor accounts for the probability that a given agent has at least one connection to an agent whose highest-scoring strategy G is higher-ranked than K , and the first factor is just the number of agents whose own highest-scoring strategy is K . Finally, we need a suitable expression \overline{n}_K , which is the number of agents using the K 'th highest-ranking strategy in the absence of the network. As before, we will consider the case of the small- m limit with a flat strategy allocation matrix which, from Equation 23, gives

$$\overline{n}_K = N \left(\left[1 - \frac{(K-1)}{2^{m+1}} \right]^S - \left[1 - \frac{K}{2^{m+1}} \right]^S \right). \quad (59)$$

These expressions can then be used to evaluate σ . Elsewhere we will discuss the numerical results for a network B-A-R system [44]. In the limit of high connectivity p , there is substantial crowding in the network B-A-R system and hence degeneracy of strategy scores. Accounting for the correct frequency of degenerate/non-degenerate timesteps yields excellent quantitative agreement with the numerical simulations [44].

B. Proof-in-principle that standard deviation can show a minimum at finite network connectivity

Here we will present a proof-in-principle that the addition of connections can lead to a reduction in the standard deviation σ of demand $D[t]$. In fact there are two competing effects once more. First, connections will tend to increase the size of crowds since more agents are now likely to play the better-performing strategies. On the other hand, any particular agent who is connected to another, will effectively have up to $2S$ strategies at his disposal, thereby increasing his chances of uncovering a ‘good’ strategy. It is this competition which interests us here.

We consider the interesting case in which the B-A-R system has very few connections. This might correspond to a design problem in which initially there are no connections, and where the agents themselves are already designed and built. Hence possible control of the system is limited to introducing communication links between the agents. It is likely that such links will ‘cost’ the designer something, hence a cost-benefit question arises as

to the extent to which the system can be further modified or controlled by introducing a few connections into the system. In particular, how many links should be added, and how should they be introduced? Here we will focus on a simpler version of this problem: we assume that the links are expensive to introduce and cannot be formed in a selective way. Hence we are assuming that there are very few links, and that the links that do exist have been added in randomly to the system. The question we will address is then the subsequent effect on the standard deviation of demand $D[t]$ in the system.

Suppose there is a given probability p that any given agent i is connected to agent j . The population of agents therefore will contain, in general, a certain number $x_1(p)$ of agents who are unconnected (i.e. cluster-size $n = 1$), a number $x_2(p)$ of pairs of connected agents (i.e. cluster-size $n = 2$), a number $x_3(p)$ of triples of connected agents (i.e. cluster-size $n = 3$), etc. Hence we can effectively think of the population of N agents as comprising a ‘gas’ containing $x_1(p)$ monomers, $x_2(p)$ dimers, $x_3(p)$ trimers, and hence $x_n(p)$ n -mers where $n = 1, 2, 3 \dots$. Hence we can write

$$N = \sum_{n=1}^{\infty} nx_n(p) \quad (60)$$

For very low network connection probability, any particular realization of the connections will result in most agents remaining unconnected while a few are connected in pairs. Figure 9 shows a schematic diagram of this situation, whereby the population just comprises monomers (i.e. isolated agents) and dimers (i.e. connected pairs of agents). This implies that

$$N = x_1(p) + 2x_2(p) + \dots \approx x_1(p) + 2x_2(p) \quad (61)$$

The mean number of dimers is simply given by the total number of possible pairs, i.e. $\frac{1}{2}N(N - 1)$, multiplied by the probability p that a given pair is connected, hence yielding $x_2(p) = \frac{1}{2}pN(N - 1)$. Hence $x_1(p) = N - 2 \cdot \frac{1}{2}pN(N - 1) = N - pN(N - 1)$. We note that we are implicitly working below the percolation threshold: when $p \sim 1/N$ we have that every agent has on average one connection, in which case the assumption of truncating at dimers breaks down. We now turn to the calculation of the variance of $D[t]$. Recall that in the small m limit with flat matrices, the variance is given by

$$\sigma^2 = \sum_{K=1}^{2^m} [\overline{n_K} - \overline{\overline{n_K}}]^2 . \quad (62)$$

For the case of no network (i.e. $p = 0$), this becomes $\sigma_{p=0}^2(m, S) = C^2(m, S)N^2$ where we have added in the explicit dependence on m and S , and have used the function defined earlier on in Section VIB

$$C^2(m, S_i) = \sum_{K=1}^{2^m} \left(\left[1 - \frac{(K-1)}{2^{m+1}} \right]^{S_i} - \left[1 - \frac{K}{2^{m+1}} \right]^{S_i} - \left[1 - \frac{(2^{m+1} - K)}{2^{m+1}} \right]^{S_i} + \left[1 - \frac{2^{m+1} + 1 - K}{2^{m+1}} \right]^{S_i} \right)^2 . \quad (63)$$

Since the dimers are effectively ‘super-agents’ with $2S$ strategies at their disposal, as opposed to the isolated monomer agents who only have S , it is reasonable to suppose that the two populations (i.e. monomers and dimers) are uncorrelated on average. This is similar in spirit to the approximation used for the case of the alloy of mixed-memory agents in Section VI. Hence the contribution to $D[t]$ by the monomer agents forms a stochastic process which is uncorrelated to the contribution from the gas of dimer agents. Note that we are *not* assuming that the individual monomers are not correlated with each other, or that the individual dimers are not correlated with each other – on the contrary, there will be significant crowding (i.e. correlations) within each sub-population. The variance of $D[t]$ for the combined population, can hence be written as follows

$$\sigma_p^2 = \sum_{n=1}^N \sigma_{n;p}^2 = \sigma_{1;p}^2 + \sigma_{2;p}^2 + \dots \quad (64)$$

The partial contributions are given as follows:

$$\sigma_{1;p}^2 = [x_1(p)]^2 C^2(m, S) = [1 - p(N-1)]^2 N^2 C^2(m, S) \quad (65)$$

and

$$\sigma_{2;p}^2 = 2^2 [x_2(p)]^2 C^2(m, 2S) = [p(N-1)]^2 N^2 C^2(m, 2S) \quad (66)$$

where the factor 2^2 reflects the fact that the dimer acts with step-size 2 as opposed to 1 for the monomers. Hence we obtain

$$\sigma_p^2 = [1 - p(N-1)]^2 \sigma_{p=0}^2(m, S) + [p(N-1)]^2 \sigma_{p=0}^2(m, 2S) . \quad (67)$$

This expression can then be minimized with respect to p , yielding a minimum in σ_p^2 at

$$p_{\min} = \left[(N-1) \left[1 + \frac{\sigma_{p=0}^2(m, 2S)}{\sigma_{p=0}^2(m, S)} \right] \right]^{-1} . \quad (68)$$

Since $\sigma_{p=0}^2(m, 2S)$ is larger than $\sigma_{p=0}^2(m, S)$ for small m , we have that $p_{\min} < [N - 1]^{-1}$. Hence we have proved that, to the extent to which a particular numerical implementation reflects the connection rules assumed in the present analysis, adding in a small number of connections can actually reduce the fluctuations in $D[t]$ and hence improve performance, in the sense that the fluctuations in excess demand $D[t]$ are reduced. Interestingly, such a minimum in σ has already been reported based on numerical simulations for a somewhat similar game [46]. Our expression for p_{\min} is likely to *underestimate* the actual p value at which a minimum occurs, since we have overestimated the coordination within a given dimer, in addition to overestimating the number of dimers (and hence underestimating the effects of trimers etc.). However the fact that the Crowd-Anticrowd analysis predicts that a minimum can in principle exist, and Ref. [46] had earlier found a minimum numerically in a similar game, is very encouraging. Clearly there is a vast amount of further theoretical analysis that can be done within the present framework – however we leave this to future presentations.

VIII. CONCLUSION

We have given an in-depth presentation of the Crowd-Anticrowd theory in order to understand the fluctuations in competitive multi-agent systems, in particular those based on an underlying binary structure. Since the theory incorporates details concerning the structure of the strategy space, and its possible coupling to history space, we believe that the Crowd-Anticrowd theory will have applicability for more general multi-agent systems. Hence we believe that the Crowd-Anticrowd concept might serve as a fundamental theoretical concept for more general Complex Systems which mimic competitive multi-agent games. This would be a welcome development, given the lack of general theoretical concepts in the field of Complex Systems as a whole. It is also pleasing from the point of view of physics methodology, since the basic underlying philosophy of accounting correctly for ‘inter-particle’ correlations is already known to be successful in more conventional areas of many-body physics. This success in turn raises the intriguing possibility that conventional many-body physics might be open to re-interpretation in terms of an appropriate multi-particle ‘game’: we leave this for future work.

Some properties of multi-agent games cannot be described using time- and configuration-

averaged theories. In particular, an observation of a real-world Complex System which is thought to resemble a multi-agent game, may correspond to a *single* run which evolves from a specific initial configuration of agents' strategies. This implies a particular Ψ , and hence the time-averagings within the Crowd-Anticrowd theory must be carried out for that particular choice of Ψ . However this problem can still be cast in terms of the Crowd-Anticrowd approach, since the averagings are then just carried out over some sub-set of paths in history space, which is conditional on the path along which the Complex System is already heading. We also emphasize that a single Ψ 'macrostate' corresponds to many possible 'microstates', where each microstate corresponds to one particular partition of strategy allocation among the agents. Hence the Crowd-Anticrowd theory retained at the level of a given specified Ψ , is equally valid for the entire *set* of games which share this same 'macrostate'. We refer to David Smith's presentation at this Workshop for a detailed discussion of Ψ -specific dynamics. See also Refs. [29, 30] for the simpler case of the Minority Game.

We have been discussing a Complex System based on multi-agent dynamics, in which both deterministic and stochastic processes co-exist, and are indeed intertwined. Depending on the particular rules of the game, the stochastic element may be associated with any of five areas: (i) disorder associated with the strategy allocation and hence with the heterogeneity in the population, (ii) disorder in the underlying network. Both (i) and (ii) might typically be fixed from the outset (i.e., quenched disorder) hence it is interesting to see the interplay of (i) and (ii) in terms of the overall performance of the system. The extent to which these two 'hard-wired' disorders might then compensate each other, as for example in the Parrondo effect or stochastic resonance, is an interesting question. Such a compensation effect might be engineered, for example, by altering the rules-of-the-game concerning inter-agent communication on the existing network. Three further possible sources of stochasticity are (iii) tie-breaks in the scores of strategies, (iv) a stochastic rule in order for each agent to pick which strategy to use from the available S strategies, as in the Thermal Minority Game, (v) stochasticity in the global resource level $L[t]$ due to changing external conditions. To a greater or lesser extent, these five stochastic elements will tend to break up any deterministic cycles arising in the game. In the case of (iii), the stochasticity due to tie-breaks, we note that this stochasticity may actually have a physical significance. Suppose a real agent is at a deadlock in terms of which strategy to use at a particular timestep: some additional microscopic factor may then become important in determining the particular strategy that

the agent follows (e.g. power level in the case of mechanical agents) hence breaking the tie. In this way, the coin-toss mimics the effect of this additional microscopic characteristic of the individual agents, which had been left out of the original game.

The future therefore looks very interesting for these Binary Agent Resource models. By moving beyond the confines of the El Farol Problem and Minority Games – for example by introducing underlying network structures and generalized game rules – the possibility exists for pursuing a general yet cohesive path through the Complex Systems landscape. On the control and design aspect, the fascinating question now arises concerning the best way to insert the Crowd-Anticrowd theory within the powerful COIN (Collective Intelligence) framework developed by Wolpert and Tumer for Collectives[7]. This question will be addressed in future works.

Acknowledgments

We are grateful to Michael Hart and Paul Jefferies for their earlier input to the material in this draft. One of us (PMH) acknowledges the support from the Research Grants Council of the Hong Kong SAR Government under Grant No. CUHK4241/01P.

-
- [1] J.L. Casti, *Would-be Worlds* (Wiley, New York, 1997).
 - [2] J.L. Casti, *Complexification* (Abacus, London, 1995).
 - [3] R.V. Sole and B. Goodwin, *Signs of Life: how complexity pervades biology* (Basic Books, New York, 2000).
 - [4] T. Bossomaier and D. Green, *Patterns in the Sand: Computers, Complexity and Life* (Allen Unwin, Sydney, 1998).
 - [5] J.H. Holland, *Emergence* (Oxford University Press, 1998).
 - [6] M. Gell-Mann, *The Quark and the Jaguar* (Abacus, 1998).

- [7] See the works of D. Wolpert and K. Tumer, at <http://ic.arc.nasa.gov> and elsewhere in this volume.
- [8] B. Arthur, Amer. Econ. Rev. **84**, 406 (1994); Science **284**, 107 (1999).
- [9] N.F. Johnson, S. Jarvis, R. Jonson, P.Cheung, Y. Kwong and P.M. Hui, Physica A **258**, 230 (1998).
- [10] D. Challet and Y.C. Zhang, Physica A **246**, 407 (1997).
- [11] D. Challet and Y.C. Zhang, Physica A **256**, 514 (1998).
- [12] M. Marsili and D. Challet, Phys. Rev. E **64**, 056138 (2001).
- [13] D. Challet and M. Marsili, Phys. Rev. E **60**, 6271 (1999).
- [14] D. Challet, M. Marsili and R. Zecchina, Phys. Rev. Lett. **82**, 2203 (1999).
- [15] D. Challet, M. Marsili and Y.C. Zhang, Physica A **294**, 514 (2001).
- [16] M. Marsili and D. Challet, Adv. Complex Systems **1**, 1 (2000).
- [17] M. Marsili, D. Challet and R. Zecchina, Physica A **280**, 522 (2000).
- [18] D. Challet and M. Marsili, Phys. Rev. E **62**, 1862 (2000).
- [19] D. Challet, M. Marsili and R. Zecchina, Phys. Rev. Lett. **85**, 5008 (2000).
- [20] R. Savit, R. Manuca and R. Riolo, Phys. Rev. Lett. **82**, 2203 (1999). Interestingly, we had found a similarly shaped curve for the volatility in the El Farol problem (see Ref. [9]).
- [21] Y. Li, R. Riolo and R. Savit, Physica A **276**, 234 (2000).
- [22] Y. Li and R. Riolo and R. Savit, Physica A **276**, 265 (2000).
- [23] N.F. Johnson, M. Hart and P.M. Hui, Physica A **269**, 1 (1999).
- [24] M. Hart, P. Jefferies, N.F. Johnson and P.M. Hui, Physica A **298**, 537 (2001).
- [25] N.F. Johnson, P.M. Hui, Dafang Zheng, and M. Hart, J. Phys. A: Math. Gen. **32**, L427 (1999).
- [26] M.L. Hart, P. Jefferies, N.F. Johnson and P.M. Hui, Phys. Rev. E **63**, 017102 (2001).
- [27] P. Jefferies, M. Hart, N.F. Johnson, and P.M. Hui, J. Phys. A: Math. Gen. **33**, L409 (2000).
- [28] We presented the Grand Canonical Minority Game (GCMG) model at the APFA1 conference in Dublin (1999) and at the first International Workshop of Applications of Statistical Physics to Financial Analysis in Palermo (September 1998). See also Ref. [32].
- [29] M.L. Hart, P. Jefferies and N.F. Johnson, Physica A **311**, 275 (2002).
- [30] M.L. Hart, D. Lamper and N.F. Johnson, Physica A **316**, 649 (2002).
- [31] P. Jefferies, M.L. Hart and N.F. Johnson, Phys. Rev. E **65**, 016105 (2002).
- [32] N.F. Johnson, M. Hart, P.M. Hui and D. Zheng, Int. J. of Th. and Applied Fin **3**, 443 (2000).

- [33] N.F. Johnson, P.M. Hui, R. Jonson and T.S. Lo, Phys. Rev. Lett. **82**, 3360 (1999).
- [34] J.A.F. Heibel and A.C.C. Coolen, Phys. Rev. E. **63**, 056121 (2001).
- [35] J.A.F. Heibel, A.C.C. Coolen and D. Sherrington, Phys. Rev. E **65**, 016126 (2001).
- [36] A. Cavagna, Phys. Rev. E **59**, 3783 (1999).
- [37] A. Cavagna, J.P. Garrahan, I. Giardina and D. Sherrington, Phys. Rev. Lett. **83**, 4429 (1999);
A. Cavagna, J.P. Garrahan, I. Giardina and D. Sherrington, Phys. Rev. Lett **85**, 5009 (2000).
- [38] J.P. Garrahan, E. Moro and D. Sherrington, Quant. Finance **1** 246 (2001).
- [39] See <http://www.unifr.ch/econophysics/minority>
- [40] N.F. Johnson, P. Jefferies, P.M. Hui, *Financial Market Complexity* (Oxford University Press, 2003).
- [41] See, for example, M.E.J. Newman, cond-mat/0303516; M.E.J. Newman, A.L. Barabasi, and D.J. Watts, *The Structure and Dynamics of Networks*, (Princeton University Press, 2003); S.H. Strogatz, Nature **410**, 268 (2001); S.N. Dorogovtsev, and J.F.F. Mendes, *Evolution of Networks: From Biological Nets to the Internet and WWW*, (Oxford University Press, 2003).
- [42] See for example, M. Tlalka, D. Hensman, P.R. Darrah, S.C. Watkinson and M.D. Fricker, New Phytologist **158**, 325 (2003).
- [43] D. Challet and N.F. Johnson, Phys. Rev. Lett. **89**, 028701 (2002).
- [44] C. Choe, S. Gourley, P.M. Hui and N.F. Johnson (in preparation).
- [45] The Thermal Minority Game discussed in Ref. [37] depends on a parameter T (or equivalently $1/\beta$) called a ‘temperature’. We could similarly define T by setting the probability of playing the worst strategy $\theta = e^{-\beta}/(e^{\beta} + e^{-\beta})$. Hence $T = 2[\ln(\theta^{-1} - 1)]^{-1}$. $T = 0$ corresponds to $\theta = 0$ while $T \rightarrow \infty$ corresponds to $\theta \rightarrow 1/2$, hence we will only consider $0 \leq \theta \leq 1/2$.
- [46] M. Anghel, Z. Toroczkai, K.E. Bassler, G. Korniss, preprint (2003).

FIGURES

FIGURE 1 Schematic representation of B-A-R (Binary Agent Resource) system. At timestep t , each agent decides between action -1 and action $+1$ based on the predictions of the S strategies that he possesses. A total of $n_{-1}[t]$ agents choose -1 , and $n_{+1}[t]$ choose $+1$. In the simplified case that each agent’s confidence threshold for entry into the game is very small, then $n_{-1}[t] + n_{+1}[t] = N$ (i.e. all agents play at every timestep). Agents may be subject to some underlying network structure which may be static or evolving, and ordered or disordered. The strategy allocation, and hence heterogeneity in the population, provides a further source of disorder which may be static (i.e. quenched) or evolving. The algorithm for deciding the global outcome, and hence which action was winning/losing, lies in the hands of a fictitious ‘Game-master’. This Game-master aggregates the agents’ actions and then announces the global outcome. All strategies are then rewarded/penalized according to whether they had predicted the winning/losing action.

FIGURE 2 Strategy Space for $m = 2$, together with some example strategies (left). The strategy space shown is known as the Full Strategy Space FSS, and contains all possible permutations of the actions -1 and $+1$ for each history. There are 2^{2^m} strategies in the FSS. The 2^m dimensional hypercube (right) shows all 2^{2^m} strategies from the FSS at its vertices. The shaded strategies form a Reduced Strategy Space RSS. There are $2 \cdot 2^m = 2^{m+1}$ strategies in the RSS. The red shaded line connects two strategies with a Hamming distance separation of 4.

FIGURE 3 History Space. Examples of the de Bruijn graph for $m = 1, 2$, and 3 . Red transitions between states correspond to the most recent global outcome 0 . Blue transitions between states correspond to the most recent global outcome 1 .

FIGURE 4 Example distribution for the tensor Ω describing the strategy allocation for $N = 101$ agents in the case of $m = 2$ and $S = 2$, for the reduced strategy space RSS.

FIGURE 5 Schematic diagram of a fairly typical variation in strategy scores, as a function of time, for a competitive game. This behavior is particularly relevant for the low m regime where there are many more agents than strategies, and hence strategy rankings change in time due to being overplayed. The strategies at any given timestep can be ranked in terms of virtual-point ranking K , with $K = 1$ as the highest-scoring and $\overline{K} = \overline{1}$ as the lowest-scoring. The actual identity of the strategy in rank K changes as time progresses, as can be seen. Ignoring accidental ties in score, there is a well defined ranking of strategies at each timestep in terms of their K values.

FIGURE 6 Schematic representation of the strategy allocation matrix Ψ with $m = 2$ and $s = 2$, in the RSS. The strategies are ranked according to strategy score, and are labelled by the rank K . In the limit that Ψ is essentially flat, then the number of agents playing the K 'th highest-scoring strategy, is just proportional to the number of shaded bins at that K .

FIGURE 7 Crowd-Anticrowd theory vs. numerical simulation results for Minority Game as a function of memory size m , for $N = 101$ agents, at $S = 2, 4$ and 8 . At each S value, analytic forms of standard deviation in excess demand $D[t]$, are shown corresponding to $\sigma^{\text{delta } f}$ (upper solid line), $\sigma^{\text{flat } f}$ (lower dashed line) and $\sigma^{\text{flat } f, \text{ high } m}$ (monotonically-increasing solid line which is independent of S). The numerical values were obtained from different simulation runs (triangles, crosses and circles).

FIGURE 8 Crowd-Anticrowd theory vs. numerical simulation results for Thermal Minority Game as a function of stochastic probability θ , or ‘temperature’ T . The analytic results (lines) correspond to the $\sigma_{\theta}^{\text{delta } f}$ (solid upper line) and $\sigma_{\theta}^{\text{flat } f}$ (solid lower line) limiting-case approximations.

FIGURE 9 Schematic representation of B-A-R (Binary Agent Resource) network system in limit of few connections.

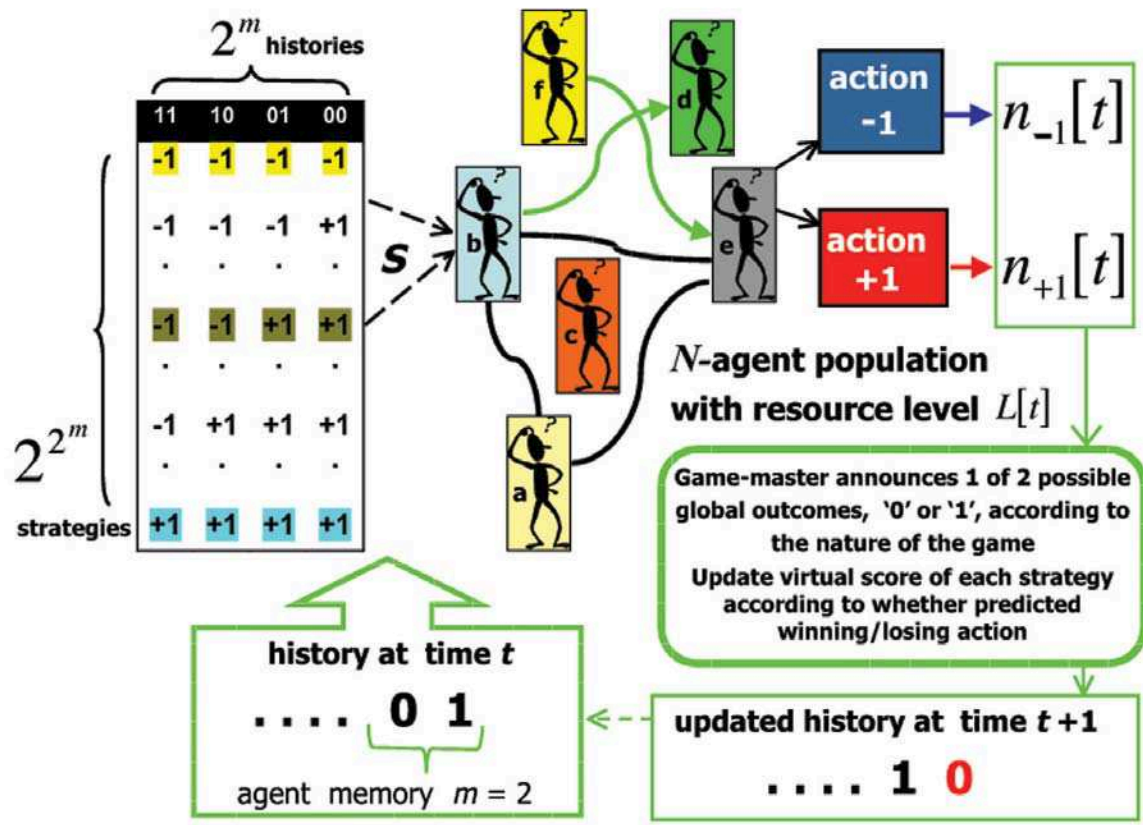

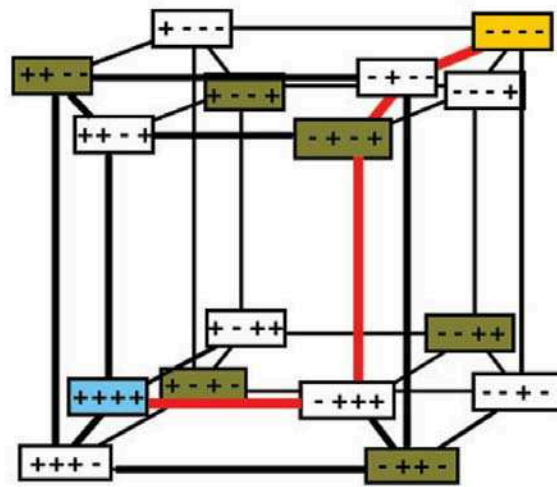
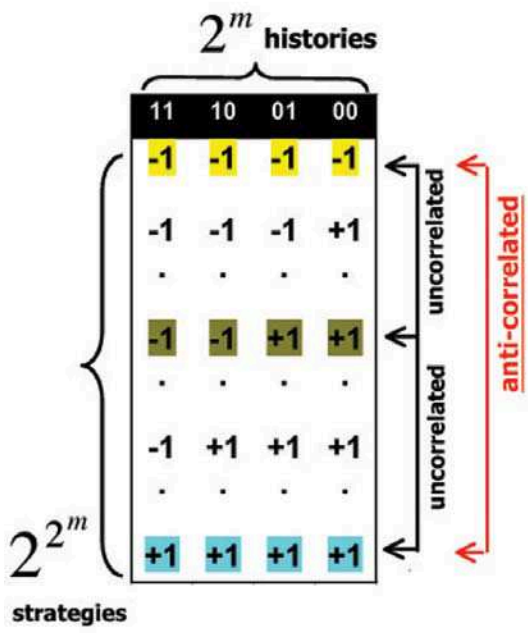

Strategy space

e.g. for memory $m = 2$

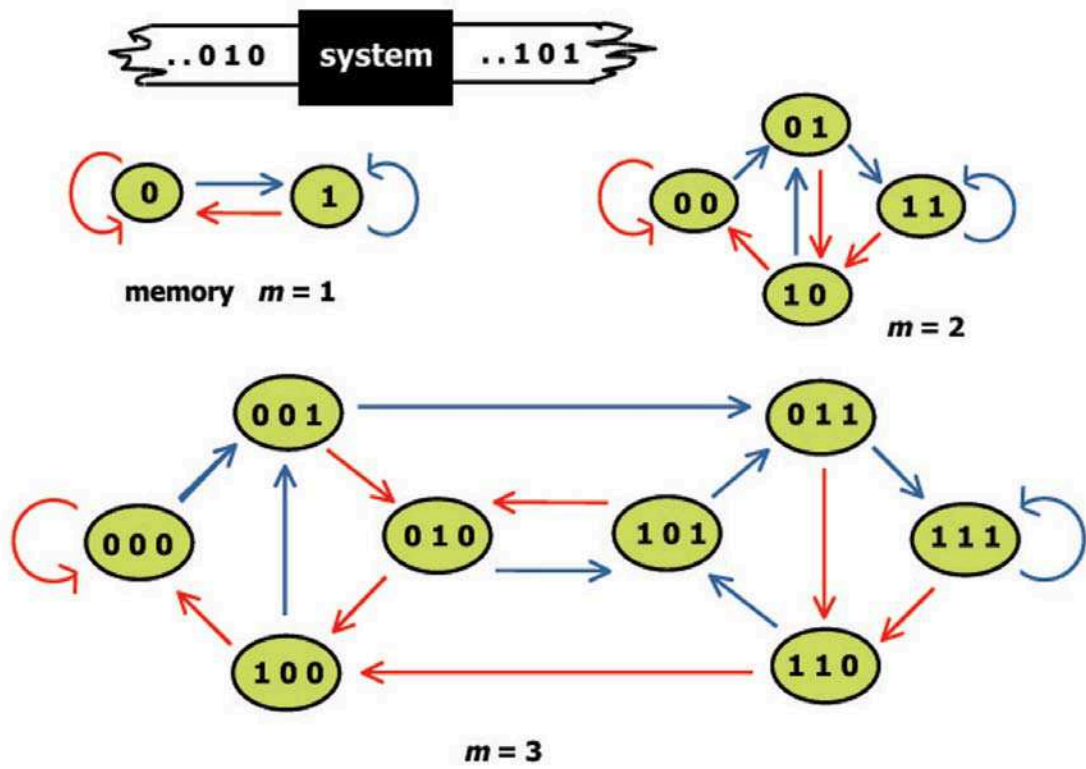

History space



first strategy R 

second strategy R' 

2	1	4	2	1	2	1	2
4	3	3	0	4	1	1	3
2	3	1	1	2	1	3	0
0	1	1	4	4	0	1	2
1	0	1	0	1	1	1	0
0	1	2	0	3	0	0	3
1	0	1	1	2	1	2	0
4	0	0	1	2	5	5	2

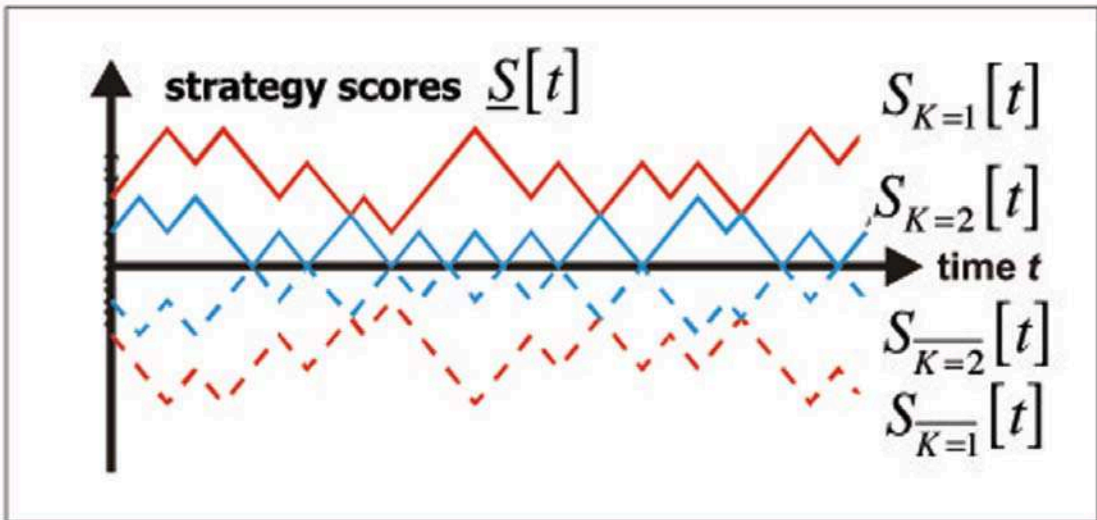

$K \rightarrow$

	1	2	3	4	5	6	7	8
1								
2								
3								
4								
5								
6								
7								
8								

$K' \downarrow$

**Basic
Minority Game**

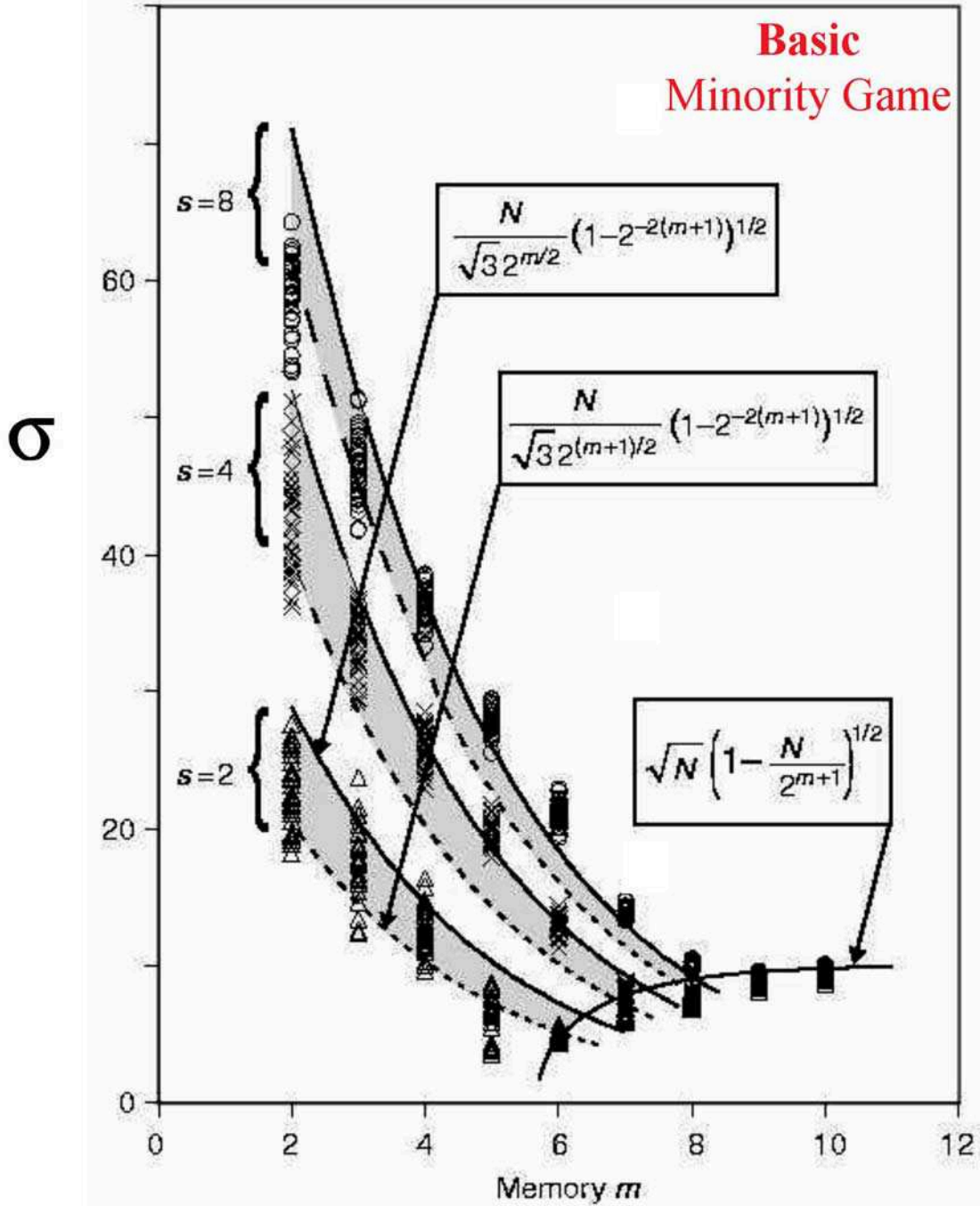

**Thermal
Minority Game**

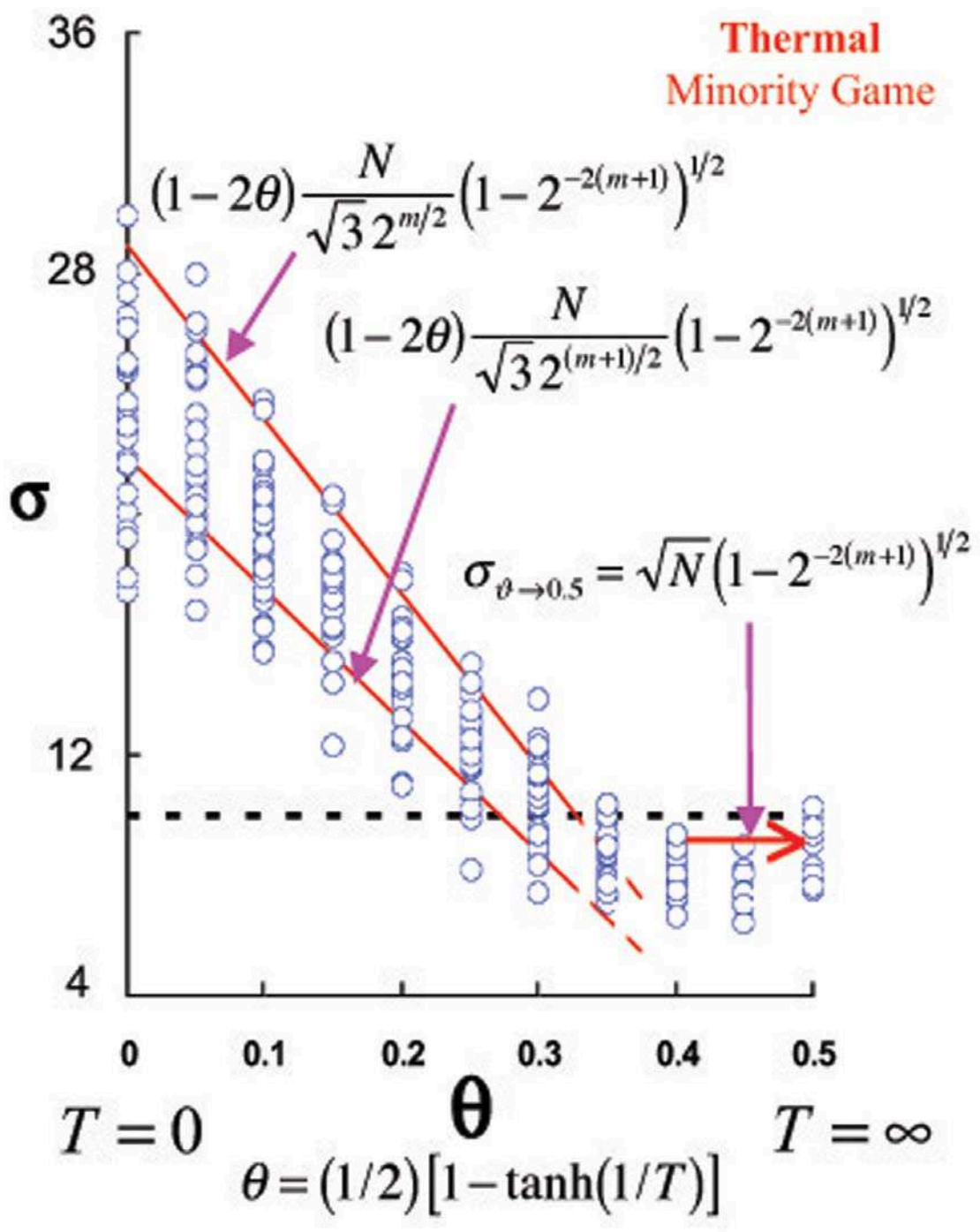

e.g. 2 dimers, 4 monomers

