

**ABOUT COMPOSITE SCALAR REPRESENTATIONS OF THE
ELECTROWEAK SYMMETRY GROUP OF THE STANDARD MODEL.**

B. Machet,^{1 2}

*Laboratoire de Physique Théorique et Hautes Energies,³
Universités Pierre et Marie Curie (Paris 6) et Denis Diderot (Paris 7);
Unité associée au CNRS D0 280.*

Abstract: the scalar composite representations of the electroweak symmetry group of the Standard Model are exhibited in the case of two generations of quarks. The link between ‘strong’ and ‘electroweak’ eigenstates is investigated, showing that the quark content commonly attributed to pseudoscalar mesons needs to be modified. After doing so, the mechanism suppressing the $K^+ \rightarrow \pi^+\pi^0$ decays with respect to $K_S \rightarrow \pi^+\pi^-$ is unraveled, without reference to any model of quark spectator or ‘factorization’ hypothesis. The same mechanism is shown to suppress $K_L \rightarrow \pi\pi$ decays. Leptonic and semi-leptonic decays are also studied. The mass relations between ‘electroweak’ eigenstates, verified at better than one percent, $m_{\pi^3}/m_{\pi^\pm} = \cos\theta_c = m_{\chi(1910)}/m_{D_s^\pm}$ are obtained.

PACS: 12.15.-y, 11.30.Rd, 12.15.Ji, 12.60.-i, 12.60.Fr, 12.60.Rc, 13.20.-v, 13.25.-k



¹Member of ‘Centre National de la Recherche Scientifique’.

²E-mail: machet@lpthe.jussieu.fr.

³LPTHE tour 16 / 1^{er} étage, Université P. et M. Curie, BP 126, 4 place Jussieu, F 75252 PARIS CEDEX 05 (France).

1 Introduction.

Accounting for the Cabibbo rotation [1] is customary at the level of elementary fields (quarks) when they undergo weak interactions; however, the determination of the electroweak eigenstates for the observed mesons, considered as composite particles, has, surprisingly, not been carefully looked at, with the only exception, and still, as we shall see, incomplete, of the neutral K mesons. Yet, nearly all observed interactions of pseudoscalar mesons are electroweak, which means that we have never observed but electroweak eigenstates, and not the bound states associated with the chiral group of symmetry of strong interactions [2]. The latter only play a role in the creation of quark-antiquark pairs, which then evolve in time, and decay, according with the dynamics of electroweak interactions [3]. The theoretical investigations concerning mesonic decays could only depart from the level of their basic constituents by the techniques of Current Algebra [4], which are of reduced utility in particular when non-leptonic decays are concerned. The most striking evidence of the inadequacy of the usual line of approach is probably the experimental factor 20 suppressing the amplitude for the decay $K^+ \rightarrow \pi^+\pi^0$ with respect to $K_S \rightarrow \pi^+\pi^-$ [5], totally unexpected in a description at the quark level, where the breaking of the isospin symmetry between the u and d quarks seems the only factor which can distinguish between the two reactions. Despite continuous efforts [5], the introduction of strong interactions, called for assistance in the form of Quantum Chromodynamics [6], could never give a very clear explanation for this enigmatic factor.

Remark: it is likely, as can be seen from the “Table of Particle Properties” [8], that scalar mesons can decay by strong interactions, and that the nature of the observed states be, in this case, better described in terms of ‘strong’ eigenstates. This is why we shall rather focus on pseudoscalar states in the present work.

The first step of the approach to those reactions that is proposed here is to identify the states which interact, and which are experimentally detected: the 32 mesons (16 pseudoscalars and 16 scalars) that can be built with 4 quarks fall into 8 representations of dimension 4 of the $SU(2)_L \times U(1)$ symmetry group of the Standard Model; four of them contain 1 scalar and 3 pseudoscalars, and the other four contain 1 pseudoscalar and 3 scalars. New results are in particular obtained for what are known as ‘long’ and ‘short’ lived kaons.

All entries in those composite representations now become functions of the mixing angle (here the Cabibbo angle since we restrict the present study to the case of two generations of quarks); this reflects the dependence on this angle of the action of the electroweak group itself on the fundamental fermions, in the natural basis of their ‘strong’ eigenstates, *i.e.* the quarks: in this basis, the generators of $SU(2)_L \times U(1)$ are $N \times N$ matrices (N is the number of quark flavours, $N = 4$ in this work), with a projector $(1 - \gamma_5)/2$ for the ‘left’ group $SU(2)$. In this way, the electroweak group appears as a subgroup of the chiral $U(N)_L \times U(N)_R$ group of the strong interactions.

Having identified the interacting states, in particular through their leptonic and semi-leptonic decays, one then tackles the problem of the non-leptonic decays of kaons, which do not take place through weak interactions only, but also require the transformation, by strong interactions, of a scalar state into two pseudoscalars, or that of a pseudoscalar into one scalar and one pseudoscalar. Indeed, the only property of strong interactions that we shall postulate is that they occur by the creation of a quark-antiquark pair, diagonal in flavour. The details of the dynamics we consider to be unknown, and we shall never rely

on any QCD-like assumption. The net result is that, in the limit of exact $SU(4)$ symmetry, two types of diagrams contribute to $K^+ \rightarrow \pi^+\pi^0$ decays, and exactly cancel, while only one is present for $K_S \rightarrow \pi^+\pi^-$; the same mechanism yields the suppression of $K_L \rightarrow \pi\pi$ decays. Getting numerical values for the decay rates would require the knowledge of the strong vertex, which is not the case; if convergence is likely to require that it behaves like an inverse power of the incoming momentum, one has always to take that kind of argumentation *cum grano salis*. Anyhow, such as it is, the origin of the suppression is unambiguous. It is based on a (gauge) theory of scalar composite multiplets which includes the Standard Model, and is free of any assumption like a ‘quark-spectator’ model, or/and of a factorization hypothesis.

Using a (gauge) electroweak theory for composite particles would not be consistent without a justification to eliminate the quark diagrams that have been up to now considered; this is why we shall, at the end of the paper, briefly restate an argumentation for quantizing spontaneously broken theories with non-independent degrees of freedom [9, 11, 12] (mesons and quarks), which shows that the quarks tend to decouple by getting an infinite mass, their degrees of freedom being transmuted into those of the mesons. Though the argument has only been worked out at leading order in $1/N$, the results of the present work point in the same direction.

2 The composite electroweak eigenstates of the standard model.

2.1 Preliminaries.

For the sake of completeness and in order to make this work more easily understandable in itself, we start by reproducing a few statements already contained in ref. [11].

Let Ψ be the fermionic 4-vector

$$\Psi = \begin{pmatrix} u \\ c \\ d \\ s \end{pmatrix}. \quad (1)$$

In this basis, the generators of the $SU(2)_L \times U(1)$ group, as deduced from the Lagrangian of the Standard Model, act as follows:

$$\mathbb{T}_L^+ = \mathbb{T}_L^1 + i\mathbb{T}_L^2 = \frac{1-\gamma_5}{2} \mathbb{C}, \quad \mathbb{T}_L^- = \mathbb{T}_L^1 - i\mathbb{T}_L^2 = \frac{1-\gamma_5}{2} \mathbb{C}^\dagger, \quad \mathbb{T}_L^3 = \frac{1-\gamma_5}{2} \mathbb{N}; \quad (2)$$

- for $U(1)_L$:

$$\mathbb{Y}_L = \frac{1-\gamma_5}{2} \mathbb{Y} = \frac{1-\gamma_5}{6} \mathbb{I}; \quad (3)$$

- for $U(1)_R$:

$$\mathbb{Y}_R = \frac{1+\gamma_5}{2} \mathbb{Y} = \frac{1+\gamma_5}{2} \mathbb{Q}, \quad (4)$$

where

$$\mathbb{C} = \left(\begin{array}{c|c} 0 & \mathbb{C} \\ \hline 0 & 0 \end{array} \right); \quad \mathbb{N} = \left(\begin{array}{c|c} 1 & 0 \\ \hline 0 & -1 \end{array} \right); \quad \mathbb{Q} = \left(\begin{array}{c|c} \frac{2}{3} & 0 \\ \hline 0 & -\frac{1}{3} \end{array} \right). \quad (5)$$

\mathbf{C} is the customary 2×2 Cabibbo mixing matrix

$$\mathbf{C} = \begin{pmatrix} \cos \theta_c & \sin \theta_c \\ -\sin \theta_c & \cos \theta_c \end{pmatrix}. \quad (6)$$

The Gell-Mann-Nishijima relation writes:

$$\mathbb{Y} = \mathbb{Y}_R + \mathbb{Y}_L = \mathbb{Q} - \mathbb{T}_L^3 = \mathbb{Q}_R + \mathbb{Y}_L. \quad (7)$$

The action of any among such generators, \mathbb{T} or $\mathbb{T}\gamma_5$, on a composite scalar $\bar{\Psi}A\Psi$ or pseudoscalar $\bar{\Psi}\gamma_5A\Psi$, where A is a 4×4 matrix, is deduced by acting with the group on the fermions. Writing

$$e^{i\vec{\alpha}\cdot\vec{\mathbb{T}}}\bar{\Psi}A\Psi = \bar{\Psi}A\Psi + i(\vec{\alpha}\cdot\vec{\mathbb{T}})\bar{\Psi}A\Psi + \dots, \quad (8)$$

we get

$$\mathbb{T}\bar{\Psi}A\Psi = \bar{\Psi}[A, \mathbb{T}]\Psi, \quad (9)$$

and, similarly,

$$\begin{aligned} \mathbb{T}\bar{\Psi}A\gamma_5\Psi &= \bar{\Psi}[A, \mathbb{T}]\gamma_5\Psi; \\ \mathbb{T}\gamma_5\bar{\Psi}A\Psi &= \bar{\Psi}\{A, \mathbb{T}\}\gamma_5\Psi; \\ \mathbb{T}\gamma_5\bar{\Psi}A\gamma_5\Psi &= \bar{\Psi}\{A, \mathbb{T}\}\Psi, \end{aligned} \quad (10)$$

where $[,]$ stands for ‘commutator’ and $\{ , \}$ stands for ‘anticommutator’. As both are involved when acting with the electroweak group, any of its composite representation is associated with an *algebra of matrices* (it closes for commutation and anticommutation and thus for simple matrix multiplication). The simplest is formed by the three $SU(2)$ generators $\mathbb{T}^3, \mathbb{T}^+, \mathbb{T}^-$ and the unit matrix \mathbb{I} , and is at the origin of the first among the eight representations that we display below.

In the following, the symmetry is supposed to be spontaneously broken by

$$\langle H \rangle = \frac{v}{\sqrt{2}}, \quad (11)$$

equivalent to

$$\langle \bar{\Psi}\Psi \rangle = N\mu^3 \quad (12)$$

by the relation

$$H = \frac{v}{\sqrt{2}N\mu^3}\bar{\Psi}\Psi. \quad (13)$$

Remark: in the whole paper, we suppose that the only fields with non-vanishing vacuum expectation values are the diagonal scalar diquark operators. This could have to be modified in a parity-violating theory like that under scrutiny.

All representations below are contained in those displayed in ref. [11], and can be easily deduced from them by simple algebra. The expressions that I propose here are somewhat easier to manipulate than the complex representations of the previous work.

The notations $\sin \theta_c$, $\cos \theta_c$ are hereafter replaced with s_θ and c_θ respectively.

2.2 The composite scalar representations of $SU(2)_L \times U(1)$.

They write:

$$\begin{aligned}
\Phi &= (H, \phi^3, \phi^+, \phi^-) = \frac{v}{N\mu^3} \bar{\Psi} \left(\frac{1}{\sqrt{2}} \mathbb{I}, \frac{i}{\sqrt{2}} \gamma_5 \mathbb{N}, i\gamma_5 \mathbb{C}, i\gamma_5 \mathbb{C}^\dagger \right) \Psi = \\
&\frac{v}{N\mu^3} \bar{\Psi} \left[\frac{1}{\sqrt{2}} \left(\begin{array}{c|c} 1 & \\ \hline & 1 \\ & & 1 \end{array} \right), \frac{i}{\sqrt{2}} \gamma_5 \left(\begin{array}{c|c} 1 & \\ \hline & -1 \\ & & -1 \end{array} \right), \right. \\
&\left. i\gamma_5 \left(\begin{array}{c|cc} & c_\theta & s_\theta \\ \hline & -s_\theta & c_\theta \end{array} \right), i\gamma_5 \left(\begin{array}{cc|c} & & \\ \hline c_\theta & -s_\theta & \\ s_\theta & c_\theta & \end{array} \right) \right] \Psi; \tag{14}
\end{aligned}$$

$$\begin{aligned}
\Sigma &= (\Sigma^0, \Sigma^3, \Sigma^+, \Sigma^-) = \\
&\frac{v}{N\mu^3} \bar{\Psi} \left[\frac{1}{\sqrt{2}} \left(\begin{array}{c|cc} 1 & & \\ \hline & -1 & \\ & c_\theta^2 - s_\theta^2 & 2c_\theta s_\theta \\ & 2c_\theta s_\theta & s_\theta^2 - c_\theta^2 \end{array} \right), \frac{i}{\sqrt{2}} \gamma_5 \left(\begin{array}{c|cc} 1 & & \\ \hline & -1 & \\ & s_\theta^2 - c_\theta^2 & -2c_\theta s_\theta \\ & -2c_\theta s_\theta & c_\theta^2 - s_\theta^2 \end{array} \right), \right. \\
&\left. i\gamma_5 \left(\begin{array}{c|cc} & c_\theta & s_\theta \\ \hline & s_\theta & -c_\theta \end{array} \right), i\gamma_5 \left(\begin{array}{cc|c} & & \\ \hline c_\theta & s_\theta & \\ s_\theta & -c_\theta & \end{array} \right) \right] \Psi; \tag{15}
\end{aligned}$$

$$\begin{aligned}
\Xi &= (\Xi^0, \Xi^3, \Xi^+, \Xi^-) = \\
&\frac{v}{N\mu^3} \bar{\Psi} \left[\frac{i}{\sqrt{2}} \left(\begin{array}{c|c} 1 & \\ \hline -1 & \\ \hline & 1 \\ & -1 \end{array} \right), \frac{1}{\sqrt{2}} \gamma_5 \left(\begin{array}{c|c} 1 & \\ \hline -1 & \\ \hline & 1 \\ & -1 \end{array} \right), \right. \\
&\quad \left. \gamma_5 \left(\begin{array}{c|cc} & -s_\theta & c_\theta \\ \hline & -c_\theta & -s_\theta \\ \hline & & \end{array} \right), \gamma_5 \left(\begin{array}{cc|c} & & \\ \hline s_\theta & c_\theta & \\ \hline -c_\theta & s_\theta & \end{array} \right) \right] \Psi; \tag{16}
\end{aligned}$$

$$\begin{aligned}
\Omega &= (\Omega^0, \Omega^3, \Omega^+, \Omega^-) = \\
&\frac{v}{N\mu^3} \bar{\Psi} \left[\frac{1}{\sqrt{2}} \left(\begin{array}{c|cc} 1 & & \\ \hline 1 & -2c_\theta s_\theta & c_\theta^2 - s_\theta^2 \\ \hline & c_\theta^2 - s_\theta^2 & 2c_\theta s_\theta \end{array} \right), \frac{i}{\sqrt{2}} \gamma_5 \left(\begin{array}{c|cc} 1 & & \\ \hline 1 & 2c_\theta s_\theta & s_\theta^2 - c_\theta^2 \\ \hline & s_\theta^2 - c_\theta^2 & -2c_\theta s_\theta \end{array} \right), \right. \\
&\quad \left. i\gamma_5 \left(\begin{array}{c|cc} & -s_\theta & c_\theta \\ \hline & c_\theta & s_\theta \\ \hline & & \end{array} \right), i\gamma_5 \left(\begin{array}{cc|c} & & \\ \hline -s_\theta & c_\theta & \\ \hline c_\theta & s_\theta & \end{array} \right) \right] \Psi. \tag{17}
\end{aligned}$$

The other four representations are deduced from the four above by a γ_5 transformation, and contain one pseudoscalar and three scalars:

$$\begin{aligned}
\tilde{\Phi} &= \Phi \text{ (scalar } \longleftrightarrow \text{ pseudoscalar)}, \\
\tilde{\Sigma} &= \Sigma \text{ (scalar } \longleftrightarrow \text{ pseudoscalar)}, \\
\tilde{\Xi} &= \Xi \text{ (scalar } \longleftrightarrow \text{ pseudoscalar)}, \\
\tilde{\Omega} &= \Omega \text{ (scalar } \longleftrightarrow \text{ pseudoscalar)}. \tag{18}
\end{aligned}$$

Remark: All ‘untilded’ representations, as have been written, are hermitian (and all ‘tilded’ representations antihermitian), which explains the difference in the i factors that can be noticed between Ξ and Φ, Σ, Ω .

On any representation $(\phi^0, \vec{\phi})$, the group acts as follows:

$$\begin{aligned}\mathbb{T}_L^i \cdot \phi_j &= -\frac{i}{2}(\varepsilon_{ijk}\phi^k + \delta_{ij}\phi^0), \\ \mathbb{T}_L^i \cdot H &= \frac{i}{2}\phi_i.\end{aligned}\quad (19)$$

We have as usual

$$\phi^+ = \frac{\phi_1 + i\phi_2}{\sqrt{2}}, \quad \phi^- = \frac{\phi_1 - i\phi_2}{\sqrt{2}}. \quad (20)$$

Any linear combination of the above representations is also a suitable representation. This leaves a certain freedom in the identification of the eigenstates with observed particles. The resulting ambiguity can only be taken care of by physical arguments.

To every representation above is associated a quadratic invariant (the sum of the square of its four entries), and there are consequently *a priori* eight independent electroweak mass scales; we shall see later that they are finally reduced to six.

We also introduce the eight corresponding $SU(2)_L \times U(1)$ gauge-invariant kinetic terms, all normalized to 1; the one attached to Φ is that for the usual scalar multiplet in the Glashow-Weinberg-Salam model.

Remarks:

- the sum of the kinetic terms for the electroweak eigenstates, all normalized to 1, is identical to that for the ‘strong’ eigenstates $\bar{u}u, \bar{u}\gamma_5 u, \bar{u}d, \bar{u}\gamma_5 d \dots$ (up to the factor $v/N\mu^3$), all likewise chosen with the same normalization; expressed for the fields themselves, which transform like their covariant derivatives, it reads:

$$|\Phi|^2 + |\tilde{\Phi}|^2 + |\Sigma|^2 + |\tilde{\Sigma}|^2 + |\Xi|^2 + |\tilde{\Xi}|^2 + |\Omega|^2 + |\tilde{\Omega}|^2 = 2\left(\frac{v}{N\mu^3}\right)^2 \sum_{q_i=u,c,d,s} \sum_{q_j=u,c,d,s} ((\bar{q}_i q_j)^2 - (\bar{q}_i \gamma_5 q_j)^2); \quad (21)$$

- the usual isospin group of strong interactions has generators

$$I^+ = \left(\begin{array}{c|c} & 1 \\ \hline & 0 \\ \hline & \end{array} \right), \quad I^- = \left(\begin{array}{c|c} & \\ \hline 1 & \\ \hline & 0 \\ \hline \end{array} \right), \quad I^3 = \frac{1}{2} \left(\begin{array}{c|c} 1 & \\ \hline 0 & \\ \hline & -1 \\ \hline & 0 \\ \hline \end{array} \right); \quad (22)$$

It can be generalized here to its ‘Cabibbo-rotated’ version;

- the arrangement of scalars and pseudoscalars inside the representations, always of the type $(1, 3)$, sheds some light on the importance of the group $SU(2)_{diagonal}$: inside each representation, the three scalars or the three pseudoscalars are triplets of this group, while the remaining entry is a singlet. $SU(2)_{diagonal}$ can also be considered as a generalization, in the case of four quarks, of the isospin group of symmetry for the case of two quarks;

- the eight composite representations can be deduced from one another by the action of the $U(2)_L \times U(2)_R$ group with $U(2)$ generators $(\mathbb{I}, \vec{\tau})$:

$$\tau_1 = \left(\begin{array}{c|c} 1 & \\ \hline -1 & \\ \hline & 1 \\ \hline & -1 \\ \hline \end{array} \right), \quad \tau_2 = \left(\begin{array}{c|cc} 1 & & \\ \hline 1 & -2c_\theta s_\theta & c_\theta^2 - s_\theta^2 \\ \hline & c_\theta^2 - s_\theta^2 & 2c_\theta s_\theta \\ \hline \end{array} \right), \quad \tau_3 = \left(\begin{array}{c|cc} 1 & & \\ \hline -1 & c_\theta^2 - s_\theta^2 & 2c_\theta s_\theta \\ \hline & 2c_\theta s_\theta & s_\theta^2 - c_\theta^2 \\ \hline \end{array} \right).$$

Phrased in another way, the 16 matrices of the ‘Cabibbo rotated chiral $U(4)$ algebra’ can be obtained by simple matrix multiplication of the 4 matrices (\mathbb{I}, \vec{T}) spanning the ‘electroweak $U(2)$ ’ with the 4 matrices $(\mathbb{I}, \vec{\tau})$. We have the commutation relations $[\vec{\tau}, \vec{T}] = 0$.

3 Linking observed pseudoscalar mesons and electroweak eigenstates.

All quark pairs are first created by strong interactions, before their electroweak interactions are observed. The incoming ‘strong’ eigenstate is a linear combination of electroweak mass eigenstates, with coefficients depending on the mixing angle. The probability of observing a state with definite (electroweak) mass thus also depends on the mixing angle. The interactions and decays usually concern a precise mass state, which has eventually been collimated.

3.1 First steps.

Let us first investigate the nature of the electroweak mass eigenstates called kaons. Suppose that, in a conservative way, we keep attributing to the K^+ meson the quark content symbolized by $\bar{u}\gamma_5 s$. It decomposes into

$$i\bar{u}\gamma_5 s = \frac{1}{2} \frac{N\mu^3}{v} (c_\theta(i\Xi^+ + \Omega^+) + s_\theta(\Phi^+ + \Sigma^+)). \quad (24)$$

The neutral pseudoscalar in the same representation is expected to be degenerate in mass with $\bar{u}\gamma_5 s$ and must be a linear combination of K^0 and \bar{K}^0 :

$$\frac{1}{2} \frac{N\mu^3}{v} (c_\theta(i\Xi^3 + \Omega^3) + s_\theta(\Phi^3 + \Sigma^3)) = \frac{i}{\sqrt{2}} (c_\theta(\bar{u}\gamma_5 c - \bar{d}\gamma_5 s) + s_\theta(\bar{u}\gamma_5 u - \bar{s}\gamma_5 s)). \quad (25)$$

By the same argumentation, would we attribute to the D^+ meson the quark content $\bar{c}\gamma_5 d$, its neutral partner in the same representation would be

$$\frac{i}{\sqrt{2}} (c_\theta(\bar{c}\gamma_5 u - \bar{s}\gamma_5 d) - s_\theta(\bar{c}\gamma_5 c - \bar{d}\gamma_5 d)). \quad (26)$$

Comparing the two expressions (25) and (26), and neglecting corrections in s_θ , we see that the neutral partner of the D^+ meson and that of the K^+ are antiparticles, and so *must* have the same mass. Thus, unless we accept that the (large) mass splitting between neutral K and D ’s is due to the (small) components, proportional to s_θ , of the neutral partners of $\bar{u}\gamma_5 s$ and $\bar{c}\gamma_5 d$ which are not antiparticles of each other, the starting hypothesis is untenable; this leads us to associate the kaon mass to the Ξ multiplet and the D mass to the Ω multiplet. The study of leptonic, semi-leptonic and non-leptonic decays of these weak eigenstates will further assert the fact that, with two generations of quarks, the quark content of the K and D mesons cannot be what has been currently believed. Instead, for example, we shall rather take as a first approximation

$$\begin{aligned} K^+ &\approx \frac{i}{2a} \Xi^+ \approx \frac{i v}{2a N \mu^3} (\bar{u}\gamma_5 s - \bar{c}\gamma_5 d), \\ D^+ &\approx \frac{1}{2a} \Omega^+ \approx \frac{i v}{2a N \mu^3} (\bar{u}\gamma_5 s + \bar{c}\gamma_5 d), \end{aligned} \quad (27)$$

where a is a normalization constant that will be determined in section 3.2 to be $a = 2f/v$; f is the leptonic decay constant, supposed, for simplification, to be the same for all pseudoscalars. The neutral K and D mesons will be found in ‘tilded’ or ‘untilded’ representations, essentially discriminated by the presence or absence of semi-leptonic decays (see section 3.4 below).

The case of the π and D_s mesons is different in that there is not the same contradiction as above in taking a composition as close as possible to $\bar{u}\gamma_5 d$ for π^+ , and to $\bar{c}\gamma_5 s$ for D_s^+ . This becomes even mandatory, as seen below, for explaining the corresponding leptonic and semi-leptonic decays, and also the non-leptonic decays of the kaons. An argumentation, anticipating on next subsections, is the following:

- π cannot be associated with Φ alone because no neutral pseudoscalar meson made of d and s , or u and c ($\bar{d}\gamma_5 s, \bar{s}\gamma_5 d, \bar{c}\gamma_5 u, \bar{u}\gamma_5 c$) has any component on Φ , and thus will never have an element of Φ in the product of its semi-leptonic decays;
- it cannot either be associated with Σ alone as the action of the group on any entry of Σ never gives a scalar with non-vanishing vacuum expectation value (we suppose, for the sake of simplicity, that $\langle \bar{u}u \rangle = \langle \bar{c}c \rangle = \langle \bar{d}d \rangle = \langle \bar{s}s \rangle$); this forbids the pure Σ states to leptonically decay. So, the pions, which do appear in products of semi-leptonic decays of neutral strongly created quark pairs $\bar{d}\gamma_5 s, \bar{s}\gamma_5 d, \bar{c}\gamma_5 u, \bar{u}\gamma_5 c$, and which do decay leptonically, have to be mixtures of Φ and Σ ;
- however, pions and D_s mesons cannot be either combinations of Φ and Σ only, since then only pions and D_s mesons could decay leptonically, and not kaons; this leads us to introduce an admixture of Ξ in the definition of pions in particular (see eq. (53) below);
- then the mechanism at the origin of the suppression of $K^+ \rightarrow \pi^+\pi^0$ and $K_L \rightarrow \pi\pi$ with respect to $K_S \rightarrow \pi\pi$ can be understood in simple terms.

Another mixing matrix is thus seen to occur, that relates the observed physical states to the composite representations displayed in eqs. (14) to (17). It should be unitary, keeping the kinetic terms diagonal, such that the mass terms are those that explicitly break the $U(4)_L \times U(4)_R$ chiral symmetry down to $SU(2)_L \times U(1)$, at the mesonic level. We shall see in section 3.6 that it is again the Cabibbo matrix, which now also acts at the level of composite states.

Keeping the pions and D_s mesons as close as possible to their ‘strong’ composition is akin to saying that bound states occurring in the first generation only (u, d) or in the second generation only (s, c) stay nearly unchanged (up to corrections in s_θ) when turning on weak interactions, while it causes a strong departure from the Gell-Mann $SU(3)$ symmetry; this is not surprising as the electroweak gauge group cannot be embedded in chiral $U(3)_L \times U(3)_R$ while the weak $SU(2)$ can be split into two $SU(2)$ ’s attached, up to s_θ corrections, respectively to the first and to the second generation; the first of these two groups is the (rotated) strong isospin group.

An interesting point is that the three pseudoscalar components of Φ are known to become the third polarizations of the massive W ’s [13], which are naturally considered as pure electroweak states. In this case where we only consider two generations of fermions, we seem to be led, instead, to picture the third components of the massive gauge fields as mixtures of the quarks they are coupled to, *i.e.* essentially the lowest (π) and highest mass (D_s) pseudoscalars, plus a small (proportional to s_θ) admixture of other mesons. This is untenable, since admitting that the W propagator has also a pole, for example, at the pion mass is equivalent to saying that there exist W -mediated strong interactions *also between hadrons and leptons*. The problem has to be solved in the case of three generations, by the

requirement that the three pseudoscalar companions of the Higgs bosons, which are three among the eleven pseudoscalars involving the top quark, are pure mass states identical with the third components of the massive vector bosons. This means in particular that three among the eleven ‘topped’ mesons weight around 80 GeV and have already been observed. The eight remaining ones may indeed have a higher mass scale [14].

So, from simple arguments, we have come to the conclusion that the usual quark content attributed to pseudoscalar mesons has to be modified when one turns on electroweak interactions for more than one generation of quarks.

3.2 Leptonic decays of pseudoscalar mesons.

The leptonic decays of pseudoscalar mesons arise from the couplings $\propto g\langle H\rangle\vec{W}_\mu\partial^\mu\vec{\Phi}$ occurring in the kinetic term for Φ , with $\langle H\rangle = v/\sqrt{2}$; the outgoing leptons originate from the decay of the W gauge boson. All electroweak pseudoscalar mass eigenstates making up Φ^3 and Φ^\pm can thus decay into leptons; this includes here, in the charged sector, pions, kaons and D_s ; the D^\pm do not appear as components of Φ^\pm (see eq. (53) below) and, indeed, one does observe experimentally that their leptonic decays are extremely small, smaller than those of the D_s^\pm (improving this picture to explain the existing small leptonic decays of the D mesons could be done for example by breaking the postulated $SU(4)$ symmetry for the quark condensates, since the scalar partner of the charged D ’s involves the quantity $2c_\theta s_\theta(\langle\bar{s}s\rangle - \langle\bar{d}d\rangle)$). Scalars cannot leptonically decay as soon as no electroweak transformation can transmute them into a field with non-vanishing vacuum expectation value, which is the case here as we suppose that only the diagonal scalar diquark operators condense in the vacuum, and are $SU(4)$ symmetric.

Let for example a (\bar{u}, s) quark pair be created by strong interactions in a pseudoscalar state $\bar{u}\gamma_5 s$. Using the fact that the kinetic terms, according to eq. (21), can be identically expressed in the ‘strong’ or in the ‘weak’ basis, we directly study here the kinetic term for $(iv/N\mu^3)\bar{u}\gamma_5 s$. Incorporating the factor 2 which appears in the r.h.s of eq. (21), we get the coupling

$$s_\theta\frac{g}{2}\left(\frac{v}{N\mu^3}\right)^2\partial^\mu(\bar{u}\gamma_5 s)W_\mu^+(\langle\bar{u}u\rangle + \langle\bar{s}s\rangle + \dots). \quad (28)$$

Supposing $\langle\bar{u}u\rangle = \langle\bar{c}c\rangle = \langle\bar{d}d\rangle = \langle\bar{s}s\rangle = N\mu^3/4 = \mu^3$, it rewrites

$$s_\theta\frac{gv^2}{4N\mu^3}\partial^\mu(\bar{u}\gamma_5 s)W_\mu^+ + \dots \quad (29)$$

In the low energy regime, we can take for the W propagator $g_{\mu\nu}/M_W^2$, and, using $M_W^2 = g^2v^2/8$, the diagram of fig. 1 finally yields the coupling

$$s_\theta\frac{2}{v}\partial^\mu\left(\frac{v}{N\mu^3}\bar{u}\gamma_5 s\right)L_\mu^- + \dots, \quad (30)$$

where L_μ is the leptonic current, for example here

$$L_\mu^- = \bar{\mu}\gamma_\mu\frac{1-\gamma_5}{2}\nu_\mu. \quad (31)$$

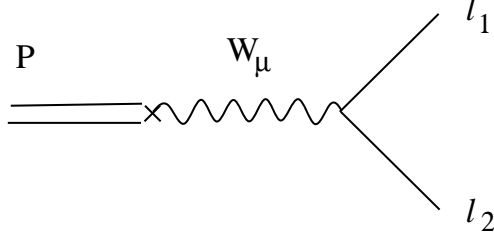

Fig. 1: leptonic decay of a pseudoscalar meson.

We now, as in ref. [11] rescale the fields by

$$\begin{aligned}
\Psi &= a \Psi', \\
\Psi_\ell &= a \Psi'_\ell, \\
R &= a R' \text{ for } R \in \{\Phi, \Xi, \Sigma, \Omega, \tilde{\Phi}, \tilde{\Xi}, \tilde{\Sigma}, \tilde{\Omega}\}, \\
\sigma_\mu &= a \sigma'_\mu \text{ for all gauge fields } \sigma_\mu,
\end{aligned} \tag{32}$$

(Ψ_ℓ is the leptonic equivalent of Ψ , eq. (1)), the gauge coupling constants $g \cdots$ by

$$g = g'/a \cdots, \tag{33}$$

and consider the classical Lagrangian \mathcal{L}/a^2 , such that the kinetic terms for the rescaled fields stay normalized to unity. Notice that the gauge couplings

$$g \phi_1 \partial_\mu \phi_2 \sigma^\mu \text{ or } g \bar{\Psi} \gamma_\mu \Psi \sigma^\mu \tag{34}$$

keep the same form in the rescaled Lagrangian

$$g' \phi'_1 \partial_\mu \phi'_2 \sigma'^\mu \text{ and } g' \bar{\Psi}' \gamma_\mu \Psi' \sigma'^\mu \tag{35}$$

and, for low energy applications, that

$$g^2 \langle H \rangle^2 = g'^2 \langle H' \rangle^2. \tag{36}$$

The physical fields and couplings are now considered to be the rescaled (primed) objects. Writing (see also eqs. (53) below)

$$\frac{iv}{N\mu^3} \bar{u} \gamma_5 s = a(K^+ + D^+), \tag{37}$$

the coupling (30) becomes, in the rescaled Lagrangian

$$s_\theta \frac{2a}{v} \partial^\mu (K^+ + D^+) L'_\mu + \cdots. \tag{38}$$

In the same way, the kinetic term for $(iv/N\mu^3) \bar{c} \gamma_5 d$ yields the coupling

$$s_\theta \frac{2a}{v} \partial^\mu (-K^+ + D^+) L'_\mu + \cdots. \tag{39}$$

We consider, for the sake of simplicity, all leptonic decay constants to be identical. Summing the two contributions (38) and (39) we recover the same coupling

$$s_\theta \frac{8f}{v^2} K^+ \partial^\mu L'_\mu \quad (40)$$

as would be given by the usual PCAC computation, if we take

$$a = 2 \frac{f}{v} = \frac{\sqrt{2}f}{v/\sqrt{2}}. \quad (41)$$

Indeed, eq. (40) also writes in momentum space

$$s_\theta g^2 f (ip_\mu) \frac{g^{\mu\nu}}{M_W^2} \bar{\mu}' \gamma_\mu \frac{1 - \gamma_5}{2} \nu'_\mu, \quad (42)$$

where p_μ is the kaon momentum, yielding exactly the correct numerical value $s_\theta f (ip_\mu) G_F$ for the leptonic coupling of K to the (physical) ‘primed’ leptons. G_F is the Fermi constant $G_F = g^2/M_W^2 = 8/v^2$. The introduction of another scale of interactions [10] is not required by leptonic decays.

Note that putting together eqs. (37) and (32) we can express the mesons fields in terms of the ‘primed’ (physical) quark fields (this is again an approximation at $\mathcal{O}(s_\theta)$; see eqs.(53) below for the exact form proposed):

$$\begin{aligned} K^+ &\approx i \frac{f}{N\mu^3} (\bar{u}' \gamma_5 s' - \bar{c}' \gamma_5 d') = i \frac{v'}{2N\mu^3} (\bar{u}' \gamma_5 s' - \bar{c}' \gamma_5 d') \approx \frac{i}{2} \Xi'^+, \\ D^+ &\approx i \frac{f}{N\mu^3} (\bar{u}' \gamma_5 s' + \bar{c}' \gamma_5 d') = i \frac{v'}{2N\mu^3} (\bar{u}' \gamma_5 s' + \bar{c}' \gamma_5 d') \approx \frac{1}{2} \Omega'^+, \end{aligned} \quad (43)$$

where

$$v = av', \quad N\mu^3 = \langle \bar{\Psi} \Psi \rangle = a^2 N\mu'^3 = a^2 \langle \bar{\Psi}' \Psi' \rangle. \quad (44)$$

Those expressions have to be compared with the customary ‘PCAC’ relations linking the K and D mesons interpolating fields with the divergences of the corresponding axial currents

$$\begin{aligned} K^+ &= \frac{i(m_u + m_s)}{f_K M_K^2} \bar{u} \gamma_5 s, \\ D^+ &= \frac{i(m_c + m_d)}{f_D M_D^2} \bar{c} \gamma_5 d, \end{aligned} \quad (45)$$

m_u, m_s, m_d and m_c being the quark ‘masses’ in the QCD Lagrangian. Up to non-important numerical factors, we notice from eqs. (43) and (45) that $f/N\mu^3$ plays the same role, in the ‘rescaled’ theory, as used to do m/fM^2 for the original quark fields. This is reminiscent of the Gell-Mann-Oakes-Renner [15] formula $(m_u + m_s)N\mu^3 = f_K^2 M_K^2$.

3.3 $\pi^0 \rightarrow \gamma\gamma$ decays.

The $(\bar{u}\gamma_5 u - \bar{d}\gamma_5 d)$ bound state decomposes into (we neglect here s_θ corrections to define the π^0 state)

$$\frac{iv}{N\mu^3} (\bar{u}\gamma_5 u - \bar{d}\gamma_5 d) = \frac{1}{\sqrt{2}} \left(\Phi^3 + \Sigma^3 + c_\theta s_\theta (i\tilde{\Omega}^0 - \Omega^3) + s_\theta^2 (i\tilde{\Sigma}^0 - \Sigma^3) \right). \quad (46)$$

As shown in ref. [9], Φ^3 decays into two photons through the Lagrangian of constraint expressing its compositeness in the Feynman path integral. Though the theory is anomaly-free, the quarks becoming infinitely massive through the same constraint, one rebuilds the same amplitude for the decay $\pi^0 \rightarrow \gamma\gamma$ as usually computed from the anomalous divergence of the associated axial current.

All neutral states having a component on Φ^3 will similarly decay into two photons with an amplitude proportional to the Adler's anomaly [7].

Remark: the reader will easily make the transition from the abelian exercise proposed in [9] and the realistic case studied here; he may however wonder why we only introduce constraints for the Φ multiplet, expressing its compositeness, while one could expect, in this non-abelian case, the equivalent for the other scalar multiplets; this is because the constraints on Φ kill enough degrees of freedom to yield a relevant theory. Its three pseudoscalar entries keep physical because they are 'eaten' by the gauge fields to become massive. Putting constraints for the other representations tend, at the opposite, to decouple their entries by giving them infinite masses (unless they could be eaten by other gauge fields, meaning that one could extend the gauge group to the full chiral group), which is unwanted. This is why, in this framework, only the mesons which have a component on Φ^3 we expect to decay into two photons, with an amplitude proportional to the anomaly.

3.4 Semi-leptonic decays.

Semi-leptonic decays (see fig. 2) are triggered by the same type of couplings (occurring in the kinetic terms) as above, except that the action of the gauge group on the initial pseudoscalar now yields another pseudoscalar in the same representation (remember that the action of a *left* generator on a pseudoscalar can yield a scalar as well as a pseudoscalar). The W gauge field still provides the two leptons. Remark that scalar mesons can now decay semi-leptonically. Similarly, the pseudoscalar 'singlets' of 'tilded' representations can only be turned into scalars by the group, such that they will not have semi-leptonic decays into another pseudoscalar. This is an important reason why the K_S meson has to mainly belong to such a representation. As above, we work with a precise example, now that of a strongly created $\bar{d}\gamma_5 s$ pseudoscalar quark pair, which decomposes into

$$\bar{d}\gamma_5 s = \frac{N\mu^3}{v\sqrt{2}} \left(\frac{1}{2}(-i\tilde{\Xi}^0 - \Xi^3 + \tilde{\Omega}^0 + i\Omega^3) + c_\theta s_\theta(\tilde{\Sigma}^0 + i\Sigma^3) - s_\theta^2(\tilde{\Omega}^0 + i\Omega^3) \right). \quad (47)$$

The weak interactions acting on the Σ^3 component can turn it into a Σ^+ or Σ^- , essentially 'made of' $\pi^\pm(\bar{u}\gamma_5 d, \bar{d}\gamma_5 u)$ and $D_s^\pm(\bar{c}\gamma_5 s, \bar{s}\gamma_5 c)$, with a $s_\theta c_\theta$ factor. The strongly created $\bar{d}\gamma_5 s$ pair will thus semi-leptonically decay into $\pi^\pm + leptons$, with the usual Cabibbo factor (up to s_θ^2 corrections). The other terms in the expansion (47) can also give semi-leptonic decays; the mass scales of the final states will determine if the decay effectively takes place,

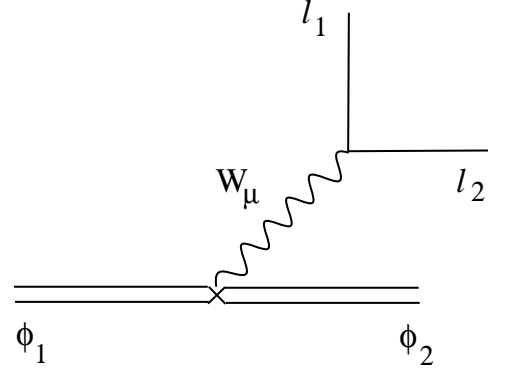

Fig. 2: semi-leptonic decay of a meson.

depending on the energy available.

As already emphasized, this example is instructive in showing that the pions cannot be identified with the three pseudoscalar entries of Φ since they will never appear in the semi-leptonic decays of $\bar{d}\gamma_5 s$. It should also be stressed that the semi-leptonic decays of neutral kaons are experimentally attributed to the long-lived one, while we rather attribute it to the pionic component of $\bar{d}\gamma_5 s$ or $\bar{s}\gamma_5 d$, Σ^3 , which does not decay into two photons (remember that the neutral pion is a mixture of Φ^3 and Σ^3 plus small corrections, and only the first component decays into two photons), and thus which is expected to have a ‘lifetime’ close to that of the charged pions, of the same order of magnitude as that of the long-lived neutral kaon; this similarity between these lifetimes, while that of K_S is much smaller, makes reasonable to think that there might be a ‘confusion’ regarding the origin of the outgoing meson.

Also, from the decomposition (47) above, a $\bar{d}\gamma_5 s$ pair is seen to ‘split’ mainly into four different mass eigenstates $\Xi^3, \tilde{\Xi}^0, \Omega^3, \tilde{\Omega}^0$; the first two we identify with the ‘long’ and ‘short’ lived neutral kaons, nearly degenerate in mass with $K^\pm \equiv \Xi^\pm$, and the last two with the two neutral D mesons, nearly degenerate in mass with the charged ones.

3.5 More about rescaling the fields and normalizing the amplitudes.

The rescaling (32) deserves more comments.¹

In the rescaled Lagrangian \mathcal{L}/a^2 considered as the ‘classical’ Lagrangian for the rescaled ‘primed’ fields and couplings, the former appear normalized to *one* and the gauge couplings take exactly the same form (see eq. (35)) as they had in the Lagrangian \mathcal{L} in terms of the original fields and couplings; we have seen that this led us to recover the correct leptonic decay amplitude for pseudoscalar mesons.

However, when dealing with quantum effects, *i.e.* loops, as for the $\pi^0 \rightarrow \gamma\gamma$ decay, or with a different number of asymptotic states, like for semi-leptonic decays, this simple but somewhat too brutal procedure leads to problems of normalization; I propose instead to start from the generating functional

$$\mathcal{Z} = \int \mathcal{D}\phi e^{\frac{1}{\hbar c} \int d^4x \mathcal{L}(\phi, g)} \equiv \int \mathcal{D}\phi' e^{\frac{a^2}{\hbar c} \int d^4x \frac{1}{a^2} \mathcal{L}(a\phi', g'/a)}. \quad (48)$$

¹The remark on page 25 of the first version of ref. [11] involves an incorrect statement (suppressed in the revised version submitted for publication), and should be replaced by the present subsection.

where ϕ stands for all fields and g for all gauge couplings, and to investigate the theory that hatches from the r.h.s. of eq. (48).

Our goal is to compute S-matrix elements between ‘in’ and ‘out’ primed fields, that we have identified with the observed (asymptotic) mesons; their classical equations (which are the Klein-Gordon equations for free fields) stay the same as those of the original ‘in’ and ‘out’ fields of \mathcal{L} ; this in particular entails that the Klein-Gordon operators occurring inside the reduction formulæ (see for example [16]) stay unchanged. However, because of the global a^2 now factorizing the action in the r.h.s. of eq. (48)

- each (bare) propagator gets a factor $1/a^2$;
 - each gauge coupling g' (recall that g' is the gauge coupling in the rescaled Lagrangian, see eq. (35)) gets a factor a^2 ;
- such that the parameter ‘counting’ the number of loops is now $\hbar c/a^2$.

The first and second points make each external leg get a factor $1/a^2$ because the propagators on the external legs of the full Green functions are no longer canceled by the derivative operators mentioned above, this by a factor $1/a^2$.

This results in the following facts:

- for the same number of asymptotic states, for example for the leptonic decays of mesons and $\pi^0 \rightarrow \gamma\gamma$, the diagram with one loop (the latter) will get a factor $1/a^2$ with respect to the tree-diagram (the former);
- when considering two processes occurring at tree-level, with respectively three and four external legs, as for example leptonic and semi-leptonic decays, the latter having one more external leg than the former, its amplitude has one more $1/a^2$ factor.

Those considerations bear upon the relative normalizations of the different processes of concern to us.

The question of the absolute normalization of the S-matrix elements is left. The simplest way to get it is by looking at the low energy limit of a physical process, and the one which naturally comes to the mind in a theory of weak interactions is the four-leptons coupling. It should reproduce the Fermi interaction at low energies, now between ‘primed’ leptons, considered as the physical ones. One finds

$$\mathcal{N} (a^2)^2 \frac{1}{a^2} \left(\frac{1}{a^2}\right)^4 \frac{8g'^2}{g'^2 v'^2} = \frac{\mathcal{N}}{a^4} \frac{8}{a^2 v'^2} = \frac{\mathcal{N}}{a^4} \frac{8}{v^2} = \frac{\mathcal{N}}{a^4} G_F, \quad (49)$$

where, in the r.h.s., the \mathcal{N} is the normalization factor sought for, the second factor is due to the two coupling constants, the third to the internal W propagator, the fourth to the four external legs. We see that \mathcal{N} is required to be a^4 .

Once we have fixed the global normalization of one process, (which correctly reproduces experimental data), the normalization of other processes is fixed by the discussion above. They are also found to fit experiment: this is the case for the leptonic decays of mesons, where we recover the ‘naive’ (and correct) result of section 3.2, the decay of the pion into two photons, and the semi-leptonic decays of mesons. Indeed, for the latter, we find the coupling (p_μ being the kaon momentum and the 8 factor coming from $M_W^2 = g^2 v^2/8 = g'^2 v'^2/8$)

$$(1/a^2) s_\theta p_\mu \frac{8}{v'^2} = s_\theta p_\mu \frac{8}{v^2}, \quad (50)$$

corresponding to $f_+ + f_- = 1$, f_+ and f_- being the two customary form factors of $K_{\ell 3}$ decays.

Finally, the physical amplitudes are obtained by:

- computing with the above rules, that is, putting as required by eq. (48), a factor a^2 with each coupling constant g' , a factor $1/a^2$ with each internal propagator, and a factor $1/a^2$ with each external leg;
- then, multiplying the result by a global normalization factor $\mathcal{N} = a^4$.

With the above rules of calculation, none of these processes requires the introduction of another scale of interaction.

Remark: the global normalization factor a^4 we also introduce in the reduction formulæ. Take the simplest S -matrix element, that between two identical asymptotic mesons, depicted in fig. 3:

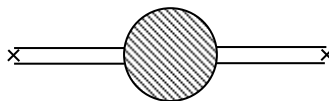

Fig. 3: ‘diagonal’ S -matrix element.

It has two external legs, giving, from the above considerations, two factors $1/a^2$; so, the reduction formulæ bring it to: (we have omitted the \sqrt{Z} ’s normalization factors):

$${}_{out}\langle\phi'(p)|\phi'(p)\rangle_{in} = \frac{\mathcal{N}}{a^4} \times \text{‘2-point proper-vertex’ for interacting } \phi' \text{’s.} \quad (51)$$

The two-point proper vertex is the bubble of fig. 3, where now no external leg is there any longer. Perturbatively, the expansion of the above S -matrix element begins, as ‘usual’, by the inverse propagator, as we now get it from eq. (48):

$$\mathcal{N} \frac{(p^2 - m_\phi^2)^2}{a^2(p^2 - m_\phi^2)} + \dots = a^2(p^2 - m_\phi^2) + \dots, \quad (52)$$

where, in the l.h.s., the two factors $(p^2 - m_\phi^2)$ are the two Klein-Gordon operators.

3.6 Proposed identification of observed pseudoscalar electroweak eigenstates.

The propositions below should be considered only as a first and most simple attempt towards the determination of the physical states. They are likely to be refined in the future by taking into account more experimental data and constraints.

3.6.1 The charged sector.

By inspection of the decays evoked above, and anticipating the results of the next section concerning non-leptonic decays into two pions, we propose to identify the observed charged

electroweak pseudoscalar eigenstates as follows:

$$\begin{aligned}
\pi^\pm &= \frac{v}{4f\sqrt{2}} (c_\theta (\Phi^\pm + \Sigma^\pm) - s_\theta (i \Xi^\pm + \Omega^\pm)), \\
D_s^\pm &= \frac{v}{4f\sqrt{2}} (c_\theta (\Phi^\pm - \Sigma^\pm) - s_\theta (i \Xi^\pm - \Omega^\pm)), \\
K^\pm &= \frac{v}{4f} (i c_\theta \Xi^\pm + s_\theta \Phi^\pm), \\
D^\pm &= \frac{v}{4f} (c_\theta \Omega^\pm + s_\theta \Sigma^\pm).
\end{aligned} \tag{53}$$

This ensures that

$$\pi^+ = \frac{i v^2}{2f\sqrt{2}N\mu^3} \bar{u}\gamma_5 d, \tag{54}$$

$$D_s^+ = \frac{i v^2}{2f\sqrt{2}N\mu^3} \bar{c}\gamma_5 s, \tag{55}$$

$$K^+ = \frac{i v^2}{4fN\mu^3} (\bar{u}\gamma_5 s - \bar{c}\gamma_5 d), \tag{56}$$

$$D^+ = \frac{i v^2}{4fN\mu^3} (\bar{u}\gamma_5 s + \bar{c}\gamma_5 d). \tag{57}$$

The relations (53) above can be cast in the form

$$\begin{pmatrix} \frac{1}{\sqrt{2}}(\pi^\pm + D_s^\pm) & \frac{1}{\sqrt{2}}(\pi^\pm - D_s^\pm) \\ K^\pm & D^\pm \end{pmatrix} = C^{-1} \times \frac{v}{4f} \begin{pmatrix} \Phi^\pm & \Sigma^\pm \\ i \Xi^\pm & \Omega^\pm \end{pmatrix}, \tag{58}$$

where C is the Cabibbo mixing matrix (see eq. (6)), which is seen to act now at the mesonic level.

The above choice ensures that, (at least in the pseudoscalar sector that we are investigating), the kinetic terms are diagonal both in the basis of $\Phi, \Sigma, \Xi, \Omega$ and in that of the mesons themselves (the corresponding mixing matrix is unitary).

3.6.2 The neutral sector.

We first exhibit the neutral pseudoscalar partners of the charged eigenstates above, to which we add the pseudoscalar singlets in the ‘tilded’ representations, that we shall relate to the long-lived kaon $K_L = K_1^0$ and to the D_2^0 meson; we specially study here the case of the neutral K mesons.

$$\begin{aligned}
\pi^3 &= \frac{v}{4f\sqrt{2}} (c_\theta (\Phi^3 + \Sigma^3) - s_\theta (i \Xi^3 + \Omega^3)) \\
&= i \frac{v^2}{4fN\mu^3} (c_\theta (\bar{u}\gamma_5 u - \bar{d}\gamma_5 d) - s_\theta (\bar{u}\gamma_5 c + \bar{s}\gamma_5 d)), \\
d_s^3 &= \frac{v}{4f\sqrt{2}} (c_\theta (\Phi^3 - \Sigma^3) - s_\theta (i \Xi^3 - \Omega^3))
\end{aligned}$$

$$\begin{aligned}
&= i \frac{v^2}{4fN\mu^3} (c_\theta(\bar{c}\gamma_5 c - \bar{s}\gamma_5 s) + s_\theta(\bar{c}\gamma_5 u + \bar{d}\gamma_5 s)), \\
k_1^0 &= \frac{v}{4f}(i c_\theta \Xi^3 + s_\theta \Phi^3) \\
&= i \frac{v^2}{4\sqrt{2}fN\mu^3} (c_\theta(\bar{u}\gamma_5 c - \bar{c}\gamma_5 u - \bar{d}\gamma_5 s + \bar{s}\gamma_5 d) + s_\theta(\bar{u}\gamma_5 u + \bar{c}\gamma_5 c - \bar{d}\gamma_5 d - \bar{s}\gamma_5 s)), \\
d_2^0 &= \frac{v}{4f}(c_\theta \Omega^3 + s_\theta \Sigma^3) \\
&= i \frac{v^2}{4\sqrt{2}fN\mu^3} (c_\theta(\bar{u}\gamma_5 c + \bar{c}\gamma_5 u - \bar{d}\gamma_5 s - \bar{s}\gamma_5 d) + s_\theta(\bar{u}\gamma_5 u - \bar{c}\gamma_5 c + \bar{d}\gamma_5 d - \bar{s}\gamma_5 s)),
\end{aligned} \tag{59}$$

to which we add the ‘singlets’ of the ‘tilded’ representations that we associate with K_2^0 and D_1^0 :

$$\begin{aligned}
k_2^0 &= i \frac{v}{4f}(c_\theta \tilde{\Omega}^0 + s_\theta \tilde{\Sigma}^0) \\
&= i \frac{v^2}{4\sqrt{2}fN\mu^3} (c_\theta(\bar{u}\gamma_5 c + \bar{c}\gamma_5 u + \bar{d}\gamma_5 s + \bar{s}\gamma_5 d) + s_\theta(\bar{u}\gamma_5 u - \bar{c}\gamma_5 c - \bar{d}\gamma_5 d + \bar{s}\gamma_5 s)), \\
d_1^0 &= \frac{v}{4f}(c_\theta \tilde{\Xi}^0 - i s_\theta \tilde{\Phi}^0) \\
&= i \frac{v^2}{4\sqrt{2}fN\mu^3} (c_\theta(\bar{u}\gamma_5 c - \bar{c}\gamma_5 u + \bar{d}\gamma_5 s - \bar{s}\gamma_5 d) - s_\theta(\bar{u}\gamma_5 u + \bar{c}\gamma_5 c + \bar{d}\gamma_5 d + \bar{s}\gamma_5 s)).
\end{aligned} \tag{60}$$

The definition of k_2^0 is seen to introduce a non-diagonal mixing between the kinetic terms of $\tilde{\Omega}$ and $\tilde{\Sigma}$ which will have to be canceled by correctly choosing the scalar eigenstates (we recall that the scalar mesons being likely to undergo strong decays, we will not study them here).

We did not give the states in eqs. (59, 60) above their usual names (using for example lower case letters) as they are not exactly what are considered as the states $\pi^0, K_1^0 = K_L, K_2^0 = K_S, D_1^0, D_2^0$.

The first thing that can be noticed is that the neutral electroweak partner of the charged pions, π^3 , is not its own antiparticle, nor is d_s^3 , which belongs to the same representation as D_s^\pm ; also, $(k_1^0 + k_2^0)$ and $(k_2^0 - k_1^0)$ are not antiparticle of each other. We have:

$$\begin{aligned}
\frac{1}{\sqrt{2}}(k_1^0 + k_2^0) &= i \frac{v^2}{4fN\mu^3} (c_\theta(\bar{u}\gamma_5 c + \bar{s}\gamma_5 d) + s_\theta(\bar{u}\gamma_5 u - \bar{d}\gamma_5 d)), \\
\frac{1}{\sqrt{2}}(k_2^0 - k_1^0) &= i \frac{v^2}{4fN\mu^3} (c_\theta(\bar{c}\gamma_5 u + \bar{d}\gamma_5 s) + s_\theta(\bar{s}\gamma_5 s - \bar{c}\gamma_5 c)).
\end{aligned} \tag{61}$$

Instead, from eqs. (59, 61, 60), one has

$$\left(\frac{c_\theta}{\sqrt{2}}(k_1^0 + k_2^0) - s_\theta \pi^3 \right) = i \frac{v^2}{4fN\mu^3} (\bar{u}\gamma_5 c + \bar{s}\gamma_5 d) = K^0$$

and

$$\left(\frac{c_\theta}{\sqrt{2}}(k_2^0 - k_1^0) + s_\theta d_s^3 \right) = i \frac{v^2}{4fN\mu^3} (\bar{c}\gamma_5 u + \bar{d}\gamma_5 s) = \bar{K}^0 \quad (62)$$

are antiparticle of each other; we thus naturally associate them with the K^0 and \bar{K}^0 ‘strong’ eigenstates (note that, as announced in section 2.1, they differ from their customary definitions in terms of the d and s quarks only). Also, of the two ‘orthogonal’ states

$$\left(c_\theta \pi^3 + \frac{s_\theta}{\sqrt{2}}(k_1^0 + k_2^0) \right) = i \frac{v^2}{4fN\mu^3} (\bar{u}\gamma_5 u - \bar{d}\gamma_5 d) = \pi^0$$

and

$$\left(c_\theta d_s^3 - \frac{s_\theta}{\sqrt{2}}(k_2^0 - k_1^0) \right) = i \frac{v^2}{4fN\mu^3} (\bar{c}\gamma_5 c - \bar{s}\gamma_5 s) = \chi^0, \quad (63)$$

the first corresponds to the ‘strong’ π^0 , and the second should be degenerate in mass with the D_s^\pm mesons. d_s^3 is likely to be the $\chi(1910)$ [8] (see below).

The equations (62, 63) above can be cast in a form similar to eq. (58)

$$\begin{pmatrix} \pi^0 & \bar{K}^0 \\ K^0 & \chi^0 \end{pmatrix} = C \times \begin{pmatrix} \pi^3 & \frac{1}{\sqrt{2}}(k_2^0 - k_1^0) \\ \frac{1}{\sqrt{2}}(k_1^0 + k_2^0) & d_s^3 \end{pmatrix}. \quad (64)$$

So, while the kinetic terms for the electroweak representations of section 2.2 are naturally diagonal in the ‘strong’ eigenstates (and we have been careful that it stays the same after our change of basis above), the same thing does not occur for the mass terms: the neutral electroweak partners of the charged (‘strong’ or ‘weak’) eigenstates no longer have simple relations by charge conjugation, and mixing terms appear.

The detailed study of the neutral sector will be the subject of a forthcoming work. It will also deal with the other neutral states, those corresponding to the D mesons, just mentioned here, and with the mesons of the ‘ η ’ type, the mixing of which are known to be rather subtle.

Let us however give here a very simple example of the mechanism that operates. It has furthermore the nice property of yielding mass relations between charged and neutral (electroweak) pions, and between the D_s mesons and the $\chi(1910)$, both well verified experimentally. We only use the charge independence of strong interactions which forces all ‘strong’ pions to have the same mass. Such a mass term for the strong pions writes

$$-\frac{1}{2}m_\pi^2(2\pi^+\pi^- + \pi^0{}^2), \quad (65)$$

and can be rewritten, using eqs. (62, 63, 64) above, and neglecting terms in s_θ^2

$$-\frac{1}{2}m_\pi^2 \left(2\pi^+\pi^- + c_\theta^2 \pi^3 \pi^{3\dagger} + c_\theta s_\theta (\pi^3 \bar{K}^0 + K^0 \pi^{3\dagger}) + \dots \right). \quad (66)$$

This shows that the electroweak eigenstate π^3 behaves like a particle with mass

$$m_{\pi^3} = c_\theta m_{\pi^\pm}, \quad (67)$$

which has mixing with the neutral kaons; this last fact reflects the already mentioned property that one cannot diagonalize the mass terms for both strong and electroweak eigenstates. The relation (67) is verified at better than 1 percent.

In a similar way, one shows that

$$m_{d_s^3} = c_\theta m_{D_s^\pm}. \quad (68)$$

If we suppose that d_s^3 is the $\chi(1910)$, eq. (68) is verified at 0.4 percent.

Those results are encouraging, and a more complete study is postponed to a further work. We conclude this section by a remark concerning the number of independent mass scales, made simpler by working in the approximation where we neglect $\sin\theta$ corrections. The reader has noticed that K_L and K_S are members of different representations, Ξ for the former and $\tilde{\Omega}$ for the latter, such that we could *a priori* expect two different masses for these mesons. However, in this approximation (K_L+K_S) and (K_S-K_L) being antiparticle of each other must have the same mass, meaning that the mass scales associated to the two above representations of the electroweak gauge group must be identical. The same type of phenomenon occurs in the D sector, such that the *a priori* eight independent electroweak mass scales reduce to six.

Remark: at the same approximation, it can immediately be checked that the states $[K^+, (1/\sqrt{2})(K_L - K_S)]$ and $[K^-, (1/\sqrt{2})(K_L + K_S)]$ are, as usual, doublets of the strong isospin group defined by eq. (22). The same thing holds for D mesons.

4 $K \rightarrow \pi\pi$ decays.

We address here the question of the amplitudes for the electroweak eigenstates $K_S = K_2^0, K^+$ (and $K_L = K_1^0$) to decay into two pions. The literature concerning those decays and the so-called $\Delta I = 1/2$ rule is huge, and it is impossible to quote fairly all of it. The reader will only find a restricted choice of references, putting the accent on the different techniques that have been used and on the evolution of ideas and, inside them, many more.

In the decays under scrutiny, the final neutral pion is detected by its photonic decays; so, in the following, one can safely calculate as if, formally, it was a $(\bar{u}\gamma_5 u - \bar{d}\gamma_5 d)$ bound state; indeed its other components have no projection on Φ^3 and thus do not decay into two photons (see the previous sections). This simplifies the computations. Also, as they are not ‘suppressed’, the decays of K_S will be computed by taking this meson equal to the singlet of $\tilde{\Omega}$, neglecting corrections in higher orders in s_θ .

The three types of diagrams which give rise to such processes are described in figs. 4, 5 and 6 below (the S and P symbols denote respectively scalar and pseudoscalar states in all figures below).

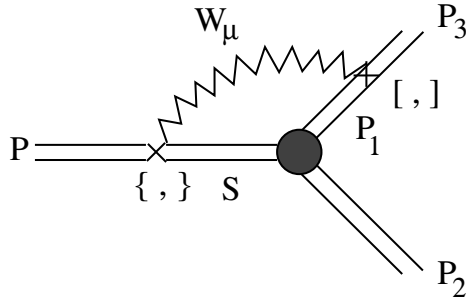

Fig. 4: first type of contribution to $K \rightarrow \pi\pi$.

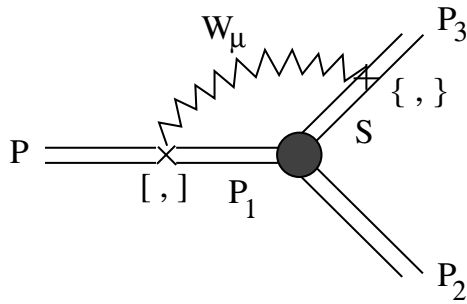

Fig. 5: second type of contribution to $K \rightarrow \pi\pi$.

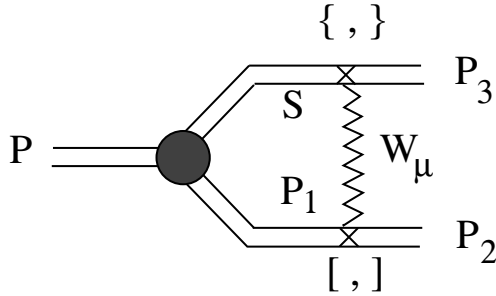

Fig. 6: third type of contribution to $K \rightarrow \pi\pi$.

The darkened bubble corresponds to the creation, by strong interactions, (conserving parity), of a $q\bar{q}$ quark pair, diagonal in flavour, transforming a pseudoscalar bound state into one scalar plus one pseudoscalar, and a scalar bound state into two pseudoscalars (the transformation of one scalar into two scalars is of course possible but does not correspond here to a process of interest). Each cross stands for a weak vertex, connecting either a gauge field and two pseudoscalars or a gauge field, one scalar and one pseudoscalar; those vertices arise in the kinetic terms for the mesons: in the first case, the gauge generator acts on the composite state by commutation, transforming a pseudoscalar into another pseudoscalar, and in the second case it acts by anticommutation, transforming a pseudoscalar into a scalar, or the opposite (see eqs. (9,10)). The mode of action of the gauge group has also been symbolized on the three figures. The contributions where the W propagator is attached to the same ingoing or outgoing particle identically vanish due to the identity symbolically described in fig. 7 and which can be checked easily.

$$\begin{array}{c}
\begin{array}{ccc}
\text{W}_\mu & & \text{W}_\mu \\
\text{S } \{, \} & \text{P } [,] & \text{P} \\
+ & & \\
\text{S } [,] & \text{S } \{, \} & \text{P} \\
= 0
\end{array} \\
\begin{array}{ccc}
\text{W}_\mu & & \text{W}_\mu \\
\text{P } [,] & \text{P } \{, \} & \text{S} \\
+ & & \\
\text{P } \{, \} & \text{S } [,] & \text{S} \\
= 0
\end{array}
\end{array}$$

Fig. 7: identity making the fourth type of contribution to $K \rightarrow \pi\pi$ vanish.

The diagrams of the type of fig. 8 could *a priori* appear since the kaons, as defined in eqs. (53), have a non-vanishing component on Φ , which allows a $K - W_\mu$ transition (see section 3.2). However the coupling of the W to two mesons happens to be antisymmetric in the mesons, which makes it vanish in this case since the two mesons are pions which must, at the opposite, be symmetrized because of Bose statistics.

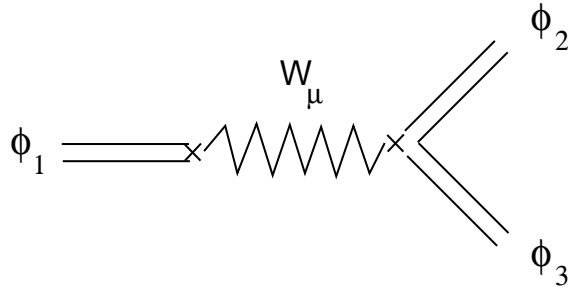

Fig. 8: diagrams that do not occur in $K \rightarrow \pi\pi$ decays.

Because of the unknown value of the ‘strong’ vertex, we cannot give precise numbers, but will only unravel the suppression of certain types of decays, from a new point of view, going in particular beyond any ‘picture’ like the ‘quark-spectator model’, or any ‘factorization’-like hypothesis. We indeed use composite representations of the electroweak group and do not have to raise the question of which line of quark the weak boson is attached to.

Let us work in the approximation where we neglect all effects of flavour symmetry breaking, which means that:

- all strong vertices will be considered to have the same value;
- all intermediate states will be considered to propagate in the same way (we neglect the mass splittings).

The dynamics is consequently maximally simplified, and becomes the same for all diagrams in figs. 4, 5, 6 with the same ingoing and outgoing states, up to a ‘-’ sign between fig. 5 and fig. 6: this can be easily seen if one remembers that the weak vertices involve a derivative of the incoming meson, and that fig. 5 and fig. 6 can be deduced from one another by exchanging the incoming pseudoscalar P and the final P_2 , together with changing the sign of their momenta: one being attached to a ‘strong’ vertex, this change is considered *a priori* not to alter it, while the other, attached to a weak vertex, will change the sign of

this vertex. Our argumentation thus relies on pure group theory, calculating commutators and anticommutators between electroweak generators and matrices determining the scalar bound states, and on the hypothesis concerning strong interactions: they act by flavour-diagonal quark pair creation (thus conserving isospin, strangeness etc . . .), and are flavour independent (the same for all scalar and pseudoscalar bound states).

We study the decays of Ξ^+ , Ξ^3 and $\tilde{\Omega}^0$, corresponding to K^+ , K_L and K_S electroweak eigenstates into two pions; that is, we suppose that the strongly created initial quark pair has been collimated to select the particles with the kaon mass. The results are the following:

* for $K^+ \rightarrow \pi^+\pi^0$:

- for the Ξ component of K^+ : the diagrams of figs. 5 and 6 contribute, the gauge field being W_μ^3 , and exactly cancel in the limit of exact $SU(4)$ symmetry (there is no contribution with W_μ^\pm);

- for the Φ component of K^+ : the diagrams of fig. 4 do not contribute; the diagrams of figs. 5 and 6 again cancel, the gauge fields being W_μ^3 and W_μ^\pm ;

* for $K_S \rightarrow \pi^+\pi^-$, only the diagram of fig. 4 now contributes, with gauge fields W_μ^\pm (there is no contribution with W_μ^3);

* for $K_L \rightarrow \pi^+\pi^-$, cancelations between figs. 5 and 6 again occur, like for $K^+ \rightarrow \pi^+\pi^0$, with an inversion of the roles of W_μ^3 and W_μ^\pm .

All decays depend on the Cabibbo angle like $\cos\theta_c \sin\theta_c$.

We thus conclude that, as observed experimentally, and unlike what is suggested by naive ‘quark spectator’ models, $K^\pm \rightarrow \pi^\pm\pi^0$ and $K_L \rightarrow \pi^+\pi^-$ are strongly suppressed with respect to $K_S \rightarrow \pi^+\pi^-$. The non-complete vanishing of the first two should be attributed to the breaking of the $SU(4)$ symmetry. Dynamical inputs concerning strong interactions would be necessary to go beyond this qualitative argumentation, but we think it to be illusory in our present state of knowledge, since the would-be candidate for a theory of strong interactions cannot yet tell anything about that of observed particles (see for example the introduction of [17]).

The only dynamical remark which can be suggested is that the convergence of the above diagrams requires the strong vertex to have a behaviour in inverse power of the incoming meson momentum. Considering this as a hint that strong interactions do indeed become stronger at low energy is probably, however, going much too fast. It can anyhow be kept in mind for further studies.

5 Conclusion.

In continuation of the program started in refs. [9, 11, 12], this work was devoted to the study of composite representations of the electroweak symmetry group, in the case of two generations of quarks and leptons. It shows that modifying the conventional beliefs concerning the quark content of pseudoscalar mesons provides a new insight into the physics of those particles. In particular, the decays of kaons into two pions are clarified. The possibility of radically departing from a pure quark picture by writing a gauge theory for scalar fields which are composite representations of the symmetry group is specially attractive. This procedure can be extended to the case of three generations. Of course, the enormous (and ever growing) amount of experimental data concerning heavy mesons makes the determination of the observed states as electroweak eigenstates much more difficult, and the choice should be first guided by principal facts and intuition.

Difficulties arise when dealing with processes where not only electroweak, but also strong interactions, are concerned, like the non-leptonic decays of pseudoscalar mesons. The need for a real theory of strong interactions is pressing, to enable dynamical computations. They also require the knowledge of the spectrum of particles running in the internal lines of figs. 4, 5, 6, including elusive scalars, to be able to go beyond the approximation of exact $SU(N)$ symmetry. A departure from this symmetry for the quark condensates can also undoubtedly enrich the phenomenology of the model. But one has always to keep in mind that the goal is not to increase the number of arbitrary parameters, but rather to fully exploit the few ‘unavoidable’ ones, like the mixing angles. We hope to have made here a step in that direction, since, in particular, the phenomenological ‘quark mass’ parameters no longer appear.

The picture that springs out of this approach is that of the preeminence of the chiral group of strong interactions, broken down to the electroweak group which, in particular, determines the mass spectrum of observed electroweak eigenstates. The latter is itself spontaneously broken down to electromagnetism and, inside each electroweak multiplet, a fine mass structure will result from pure electromagnetic interactions. A disturbing question is that only a subgroup of the chiral group seems, up to now, to be a local symmetry. We have already evoked in the core of the paper the need for gauging the whole group: this would allow a more symmetric treatment of the constraints introduced in the Feynman path integral to express the compositeness of the mesons, the ideal situation being that every observed pseudoscalar or scalar meson be the third polarization of a massive gauge field. However, the mass hierarchies physically observed undoubtedly makes this a challenge, in need of a mechanism yet to be uncovered.

Coming back, finally, to more practical concerns, it must have been obvious to the reader that we have always deliberately ignored all ‘quark diagrams’ which were, up to now, the only ones looked at. We have thus supposed that ours have ‘replaced’ the others, meaning that the quark degrees of freedom have been frozen and transmuted into those of the mesons. A more formal argumentation in favour of this point of view can be found in refs. [9, 11], where it is shown that quantizing a theory with composite, non-independent, degrees of freedom (remember that in the Glashow-Weinberg-Salam model, one integrates both on the quarks and on the scalars, and that now the latter are made of the former), requires adding constraints in the Feynman path integral, which bring back to the correct number of degrees of freedom: these constraints can be exponentiated into an additional effective Lagrangian which freezes the quark degrees of freedom by giving them infinite masses. Those consequently decouple, with a subtlety linked to one-loop processes, the anomaly and the photonic decay of the pion, evoked in section 3.3; the latter is recovered from the constraints themselves, though the theory is now anomaly-free. A similar decoupling occurs for the Higgs boson, which we predict to be unobservable. Formal problems are still to be investigated and will be the subject of forthcoming works.

Acknowledgments: Many thanks are due to my colleagues in LPTHE, specially to J. Avan and M. Talon for their help to improve the manuscript, M. Bellon for providing us with a very efficient computer system, and C. M. Viallet for his assistance with the Maple programming language.

List of Figures

- Fig. 1: Leptonic decay of a pseudoscalar meson;*
Fig. 2: Semi-leptonic decay of a meson;
Fig. 3: ‘Diagonal’ S-matrix element;
Fig. 4: First type of contribution to $K \rightarrow \pi\pi$;
Fig. 5: Second type of contribution to $K \rightarrow \pi\pi$;
Fig. 6: Third type of contribution to $K \rightarrow \pi\pi$;
Fig. 7: Identity making the fourth type of contribution to $K \rightarrow \pi\pi$ vanish;
Fig. 8: Diagrams that do not occur in $K \rightarrow \pi\pi$ decays.

References

- [1] N. CABIBBO: *Phys. Lett.* 10 (1963) 513.
- [2] Y. NE'EMAN and M. GELL-MANN: “*The Eightfold Way*” (Benjamin, N.Y., 1964).
- [3] S. L. GLASHOW: *Nucl. Phys.* 22 (1961) 579;
A. SALAM: in “*Elementary Particle Theory: Relativistic Groups and Analyticity*” (Nobel symposium No 8), edited by N. Svartholm (Almqvist and Wiksell, Stockholm 1968);
S. WEINBERG: *Phys. Rev. Lett.* 19 (1967) 1224.
- [4] S. L. ADLER and R. F. DASHEN: “*Current Algebra and Application to Particle Physics*”, (Benjamin, 1968);
B. W. LEE: “*Chiral Dynamics*”, (Gordon Breach, 1972);
M. K. GAILLARD and M. NIKOLIC eds.: “*Weak Interactions*”, *Text Book on Elementary Particle Physics (IN2P3, France, 1977)*.
- [5] M. GELL-MANN: “*Non leptonic weak decays and the eightfold way*”, *Phys. Rev. Lett.* 12 (1964) 155;
M. SUZUKI: “*Partially Conserved Axial-Vector Current and the Nonleptonic K-Meson Decays*”, *Phys. Rev.* 144 (1966) 1154;
B. D'ESPAGNAT and J. ILIOPOULOS: “*On the $\Delta I = 1/2$ rule in kaon decays*”, *Phys. Lett.* 21 (1966) 232;
C. BOUCHIAT and Ph. MEYER: “*The algebra of currents and the $\Delta I = 1/2$ rule for K-meson non-leptonic decays*”, *Phys. Lett.* 22 (1966) 198;
M. K. GAILLARD and B. W. LEE: “ *$\Delta I = 1/2$ Rule for Nonleptonic Decays in Asymptotically Free Field Theories*”, *Phys. Rev. Lett.* 33 (1974) 108;
G. ALTARELLI and L. MAIANI: “*Octet enhancement on non-leptonic weak interactions in asymptotically free gauge theories*”, *Phys. Lett.* 52B (1974) 351;
A. I. VAINSHTEIN, V. I. ZAKHAROV and M. A. SHIFMAN: “*Nonleptonic decays of mesons and hyperons*”, *Sov. Phys. JETP* 45(4) (1977) 670;
M. A. SHIFMAN, A. I. VAINSHTEIN and V. I. ZAKHAROV: “*Asymptotic freedom, light quarks and the origin of the $\Delta I = 1/2$ rule in the nonleptonic decays of strange particles*”, *Nucl. Phys.* B120 (1977) 316;
M. B. WISE and E. WITTEN: “*Diagrammatic analysis of some contributions to the $\Delta I = 1/2$ rule*”, *Phys. Rev.* D20 (1979) 1216;
J. F. DONOGHUE, E. GOLOWICH, W. A. PONCE and B. R. HOLSTEIN: “*Analysis of $\Delta S = 1$ nonleptonic decays and the $\Delta I = 1/2$ rule*”, *Phys. Rev.* D21 (1980) 186;
C. BERNARD, T. DRAPER, A. SONI, H. D. POLITZER and M. B. WISE: “*Application of chiral perturbation theory to $K \rightarrow \pi\pi$ decays*”, *Phys. Rev.* D32 (1985) 2343;
J. BIJNENS: “*On the validity of chiral perturbation theory for the $\Delta I = 1/2$ rule*”, *Phys. Lett.* 152B (1985) 226;
A. PICH, B. GUBERINA and E. de RAFAEL: “*Problem with the $\Delta I = 1/2$ rule in the Standard Model*”, *Nucl. Phys.* B277 (1986) 197;

- W. A. BARDEEN, A. J. BURAS and J. M. GERARD: “A consistent analysis of the $\Delta I = 1/2$ rule for K decays”, *Phys. Lett. B192* (1987) 138;
H. Y. CHENG: “Status of the $\Delta I = 1/2$ rule in kaon decay”, *Int. J. Mod. Phys. A* (1989) 495.
- [6] W. MARCIANO and H. PAGELS: *Phys. Rep.* 36C (1978) 137, and references therein.
- [7] S. L. ADLER: *Phys. Rev.* 177 (1969) 2426;
S. L. ADLER: “Perturbation Theory Anomalies”, in “1970 Brandeis University Summer Institute in Theoretical Physics, vol. 1, (Deser, Grisaru and Pendleton eds., M.I.T. Press 1970).
- [8] PARTICLE DATA GROUP: “Review of Particle Properties”, *Phys. Rev. D50*, number 3, part 1 (1994).
- [9] B. MACHET: “Some Aspects of Pion Physics in a Dynamically Broken Abelian Gauge Theory”, *Mod. Phys. Lett. A* (1994) 3053.
- [10] L. SUSSKIND: *Phys. Rev. D* 20 (1979) 2619;
S. WEINBERG: *Phys. Rev. D* 13 (1975) 974, *ibidem* D19 (1979) 1277.
- [11] B. MACHET: “Comments on the Standard Model of Electroweak Interactions”, preprint PAR-LPTHE 94/24 (June 1994), hep-ph/9406349, revised in March 1995 and submitted for publication to *Int. J. Mod. Phys. A*.
- [12] M. BELLON and B. MACHET: “The Standard Model of Leptons as a Purely Vectorial Theory”, *Phys. Lett. B313* (1993) 141.
- [13] E. S. ABERS and B. W. LEE: *Phys. Rep.* 9 C (1973) 1.
- [14] F. ABE et al.: “Evidence for top quark production in $\bar{p}p$ collision at $\sqrt{s} = 1.8\text{TeV}$ ”, *Phys. Rev. D50* (1994)2966; *ibidem*: *Phys. Rev. Lett.* 73 (1994) 225;
S. ABACHI et al.: “Search for the top quark in $\bar{p}p$ collisions at $\sqrt{s} = 1.8\text{TeV}$ ”, *Phys. Rev. Lett.* 72 (1994), 2138.
- [15] M. GELL-MANN, R. J. OAKES and B. RENNER: *Phys. Rev.* 175 (1968) 2195;
R. DASHEN: *Phys. Rev.* 183 (1969) 1245
- [16] P. ROMAN: “Introduction to Quantum Field Theory” (J. Wiley and Sons, 1969).
- [17] R. P. FEYNMAN: *Nucl. Phys. B188* (1981) 479.