

The Artificial Neural Networks as a tool for analysis of the individual Extensive Air Showers data.

Tadeusz Wibig

*Experimental Physics Dept., University of Łódź,
ul. Pomorska 149/153, PL-90-236 Łódź, Poland*

Abstract

In that paper we discuss possibilities of using the Artificial Neural Network technic for the individual Extensive Air Showers data evaluation. It is shown that the recently developed new computational methods can be used in studies of EAS registered by very large and complex detector systems. The ANN can be used to classify showers due to e.g. primary particle mass as well as to find a particular EAS parameter like e.g. total muon number. The examples of both kinds of analysis are given and discussed.

1 Introduction

The using of Artificial Neural Network (ANN) for solving a very different physical problems become very extensive and promising in the last years ([1]). The stage of complexity of physical processes together with the huge number of data to be proceed makes the "classical type" calculation so complicated that the results sometimes can be reached on the very edge of reality. One of the best examples of such situation is the Extensive Air Shower (EAS) physics. It is possible, in principle, to describe the EAS using the Monte-Carlo technics. Main processes concerning particle traverse through the air are known to some extend. Some believe that the contemporary knowledge of high energy hadronic collisions is good enough to lead us to solutions of some important cosmic ray physics problems. Even if it is so, the problem is how to evaluate the physical answer from the cosmic ray experiment data. The only one way possible at present is to compare the results of Monte-Carlo calculations with the measurements. The most common result of such comparison is the complain that the data obtained from the measurement are not in a very close agreement with the assumed model Monte-Carlo predictions. (Some "physical" discussions are about the question: "How far they disagree?". But this is

not a physical question!) The main goal is in the complexity of the problem. (The Monte-Carlo programs used are about hundreds of thousands line long. The first question is how much we can trust them. This is also not a "physical" question, but we should bear it in minds.) The best, most popular I should say, Monte-Carlo codes to simulate a high energy hadronic interactions have to contain two main sources of uncertainty. First, due to the absence of the theory of strong interactions to build models some more or less strong physical assumptions about the interaction pictures are needed. Some simplifications during the modeling is a natural way to do so and it can also be treated as a source of uncertainty ("unremovable"). The another one is the values of the model parameters which can not be taken from the theory and have to be fitted to some (mainly accelerator) experiment results. The contemporary Monte-Carlo programs needs about hundred parameter (some of them very well known, some unknown at all). The question arises: how the cosmic ray physics can be driven from such a unpure "theoretical" predictions? Let us look at that problem from the other side. The very best existing (and those which will be build in near future) experimental apparatus consist of large number of different detectors distributed over a wide (effective) area. The data collected give a possibility to study different characteristics of the EAS. Each of them is **somehow** connected to the different "part" of the shower development. The bold letters were used to stress the connection which exists for sure, and which is unknown for the reasons given above. The question of the major importance in cosmic ray physics is about the nature of primary cosmic rays: energetic and mass spectrum. The detail knowledge of the connections between cosmic ray flux on the top of the atmosphere and the detector response in the array on the ground level is certainly appreciated, but the lack of it do not make a further study hopeless. Some general features observed in EAS on ground level related to the mass of primary CR particle are more or less *model independent*. Calculations shows that many of the shower parameters depends on the mass but all those dependencies are smeared due to individual shower development fluctuations. On the other hand, these fluctuations are also related to the nature of the primary particle. To get the maximum information on the shower registered by a complex and extended array there are at least two general ways. First is to get a set of parameters describing the shower in the most complete way. This can be understood as a contraction of the rough experimental multidimensional space (in which each of the dimension is given by a single detector signal) to the much less dimensional space of some shower parameters. This reduction can be more or less fortunate and there is no arbitrary way to do this. The further analysis of that contracted space can be done in a conventional way by comparing the experimental points with the Monte-Carlo simulated showers (Ref. [2]). In the case of experiment dedicated to primary mass determination the most required contraction is to reduce all measurement space to one-dimensional which will be interpreted as a primary mass response of the apparatus. Sometimes ones require that the reduction procedure should be also the most effective one. This means that it should

minimize the interpretation errors. To find such best data evaluation procedure a different methods can be used. The well defined one is the Principal Component Analysis procedure discussed e.g. in Ref. [4]. The disadvantage of all that procedures is in the fact that all of them rely very strong on the Monte–Carlo simulation programs. The proof of the exactness of the methods is very hard and is always connected with the believe of the accuracy of the shower development description.

The second way is the object of that paper. The rough experimental data space can be reduced promptly using the Artificial Neural Networks. The ANN can be trained on a Monte–Carlo simulated array responses with the known initial cosmic ray particle. The reduction of the dimensionality of the output we wish to have is done by definition using the general rules established in Monte–Carlo sample. The question of the correctness of the ANN procedure is more complicated mainly because the theory of such a method is poorly known. The nature of the process of network self–organizing is a enigma, and the rules developed by the network during training are far from the standard ”physical” ones. For the very complicated networks the are even hard to extract. The proof of correctness is much harder than for a known statistical methods, even if possible in general. But, as someone says, ”the proof of the pudding is in the eating” I want to show that the method can be satisfactory used in some cases.

In the present work I want to show some preliminary results concerning the ANN analysis using as an example the muon part of the array of the KASCADE experiment in Karlsruhe (Ref. [6]). The muon array consists of 192 detectors of 3.2 m² each spread over 200 × 200 m surface. The energy threshold of muon is 0.1 GeV.

I want study to what extend the information from these counters can be analyzed with the help of ANN technics.

2 Using ANN for the determination of particular shower parameters

The minimizing procedures usually used for estimation of some distribution parameters need two conditions to be fulfilled. One is to have a measurement of the shower statistically accurate enough to be used. The problem can be seen very well in Fig. 1 where the typical muon detector responses for the shower in the array of the KASCADE geometry is presented.

In the most of showers the numbers registered by the muon detectors oscillated around the very few. The large statistical density fluctuations are expected.

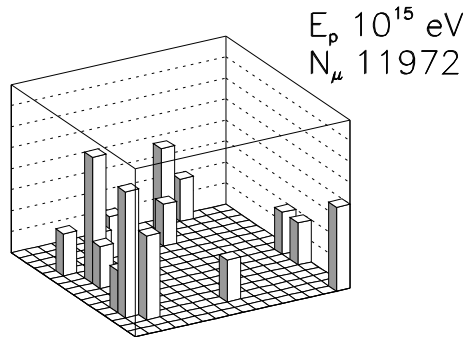

Fig. 1. The muon detector response for the typical shower initiated by primary proton of energy of 10^{15} eV in the array KASCADE experiment geometry.

Another condition is that the assumption about the real distribution one trying to fit is a correct one. In literature there are usually a few possibilities and which one to choose is a question of taste. The differences is expected not to be large, but a word "large" has not a precise meaning. The ANN method is, by definition, not bothered by both such problems. To show that, I want to present the results concerning the total muon number determination for individual showers by the KASCADE-like experiments. It should be pointed out here also that the traditional minimization methods of the muon lateral distribution determination need additional information about the Extensive Air Shower usually obtained from the measurement of the electromagnetic component part of the experiment. They are the shower core position and the shower axis inclination angles. For the results presented in that section those shower parameters are not used. The estimation of the muon size of the shower using ANN is based only on the muon component registration. Then schematic view of the ANN architecture is given in Fig. 2.

The input contain 192 signals from the ideal detectors measured the numbers of muons passing the detector surface. Each of the inputs is connected with each of the first hidden level neurons. The analysis was performed the network with the two hidden levels with different number of neurons to see the effect of the network size. The last hidden level is connected to the one output unit. The number of the network parameters to be trained was from about 25000 to 500000. As the response function the common sigmoid function

$$\text{output} = \frac{1}{1 + A e^{-\text{input}}} \quad (1)$$

was used and the training was the standard back-propagation method. To reach the results about hundreds of thousands showers have been used for training procedure. The direct use of the Monte-Carlo simulation program for training was simply impossible so the special pseudo-Monte-Carlo generator was developed. The semi-empirical description of CORSIKA v4.112 (Ref. [5]) showers was used. From the point of view of total muon number estimation

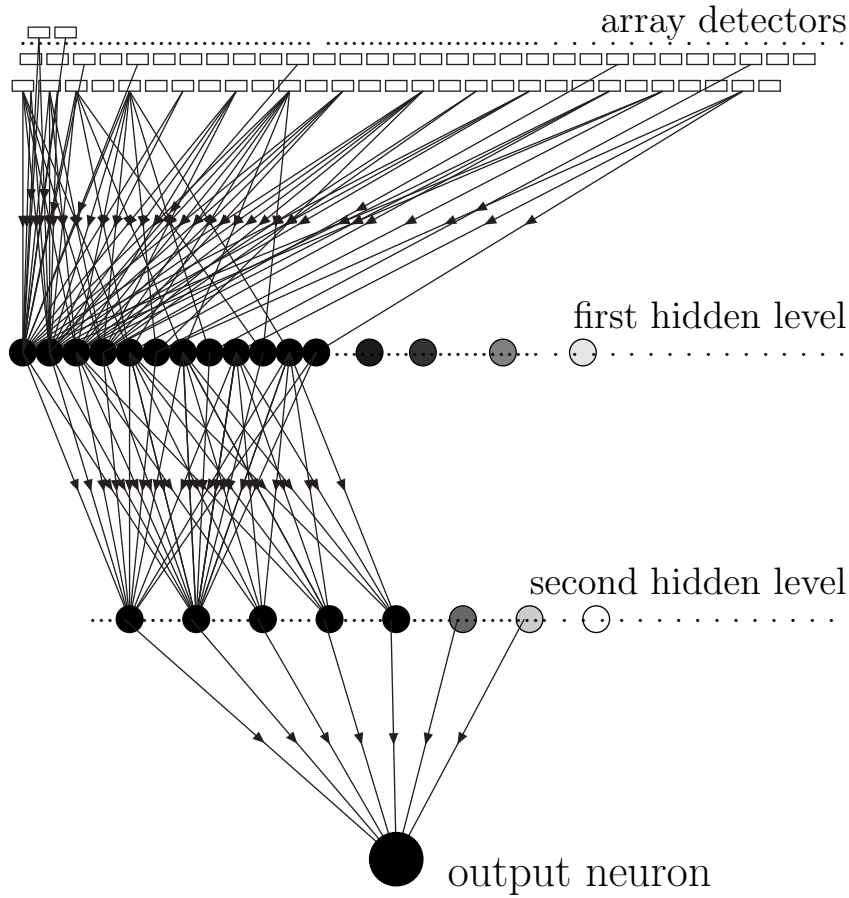

Fig. 2. Schematic layout of the Artificial Neural Network used for the total number of muons in individual EAS evaluation

the details are not very important. For the same reason only vertical showers were used hereafter the present analysis. Results for incline showers do not differ much. An example is given in Fig. 3. It should be said that for the final ANN tests the exact CORSIKA output showers were used. The results presented below justify thus the exactness of our pseudo-Monte-Carlo shower generator.

In the Fig. 3 the convergency of the training procedure is shown for different network sizes. On the vertical axis the width of the distribution of the deviation of the estimated total muon number from its true value is given.

As it is seen the further enlargement of the network size do not lead to the improvement of the accuracy of the ANN answers. It should be noted that

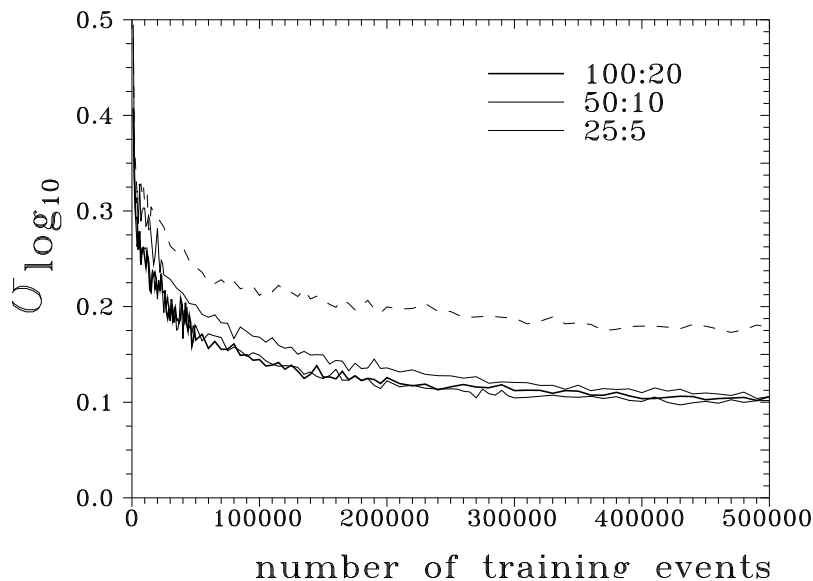

Fig. 3. The efficiency of the ANN as a function of the number of events using for the training process. Different solid lines shows the results for different numbers of neurons in two hidden levels. The dashed line is a result for incline showers

the ANN works for incline showers quite well as well. The fluctuations on the single detectors for the incline showers increase due to the $\cos(\Theta)$ factor reduction of the detector effective area.

The obtained results are presented in Figs. 4–6.

The accuracy seen in the muon size determination is quite good. The interesting point is that the network trained with the proton showers only gives in the tests some answers for the iron induced showers as it is seen in Fig. 5. The bias toward the smaller values is seen what is clearly the result of a difference in shapes of proton and iron muon lateral distributions. That bias disappears when the training procedure contains also the heavy primaries in the primary particle spectrum.

Another important feature of the ANN method is presented in Fig. 6. The ANN is able to give an answer also when only very few detectors are hit. This is presented in Fig. 6a.

The bias seen in Fig. 6a is expected due to existence of the threshold minimum 4 hit detectors in the training shower sample.

The comparison of the ANN results with the standard minimization technics based method is given in Ref. [3]. There is shown that the spread of the estimated total muon number with the respect to the true one obtained using the ANN procedure is about the same as for the best minimization methods

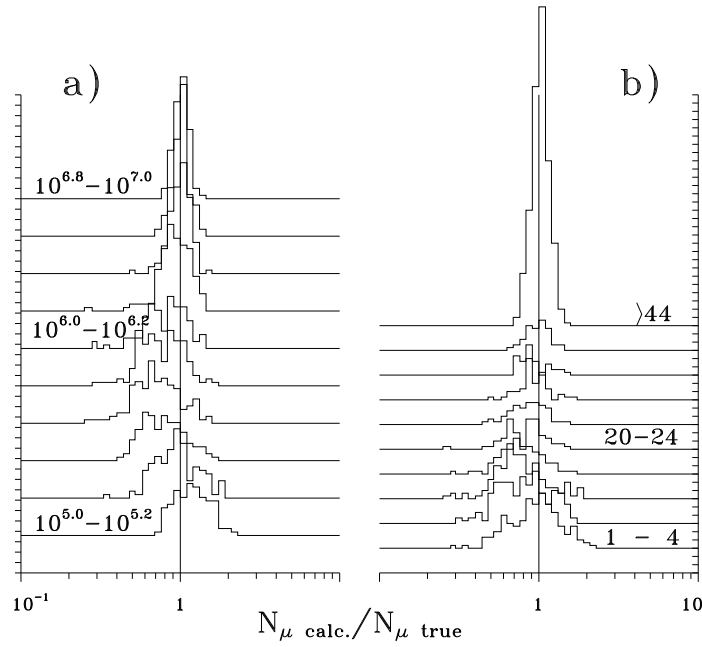

Fig. 4. The accuracy of determining the total muon number in individual showers shown for different shower sizes labeled by the primary particle energy a) and by the number of hit detectors in the KASCADE-like array b).

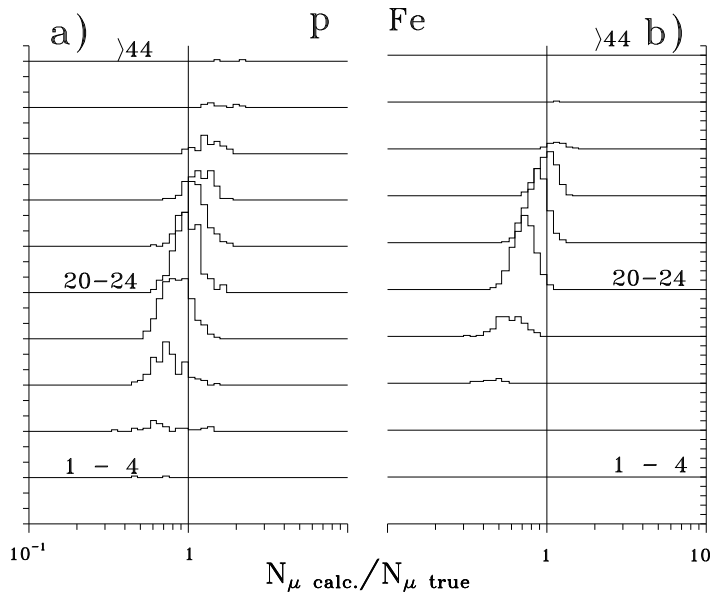

Fig. 5. The accuracy of determining the total muon number in individual showers initiated by primary protons a) and iron nuclei b) of the energy of 10^{15} eV. The histograms for different number of hit detectors are presented separately as in Fig. 4b.

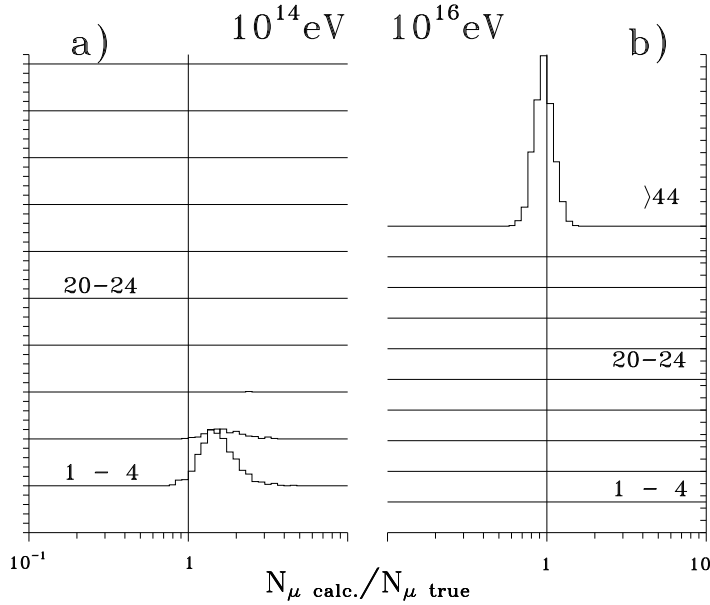

Fig. 6. The same as in Fig. 4 for very small a) and relatively large b) proton showers (of energies 10^{14} and 10^{16} eV respectively).

for the relatively large showers when the statistical weight of an information collected by the detectors is high enough and is much smaller for the small and very small showers.

3 Using ANN for the determination of primary particle mass

It is clear that the primary cosmic ray particle mass is involved in the air shower development. The possible mass spectrum consists of course in principle all the stable nuclides (in practice from hydrogen to iron). However the fluctuations of the cascading process makes impossible to distinguish the very close masses and because of that the primary cosmic ray spectrum is often studied like a spectrum of the group of similar nuclei. The whole mass spectrum is divided into the five groups: H, He, light (C-N-O), heavy (about Si) and very heavy (Fe). The relative abundances of these groups is known as the question of the cosmic ray primary mass spectrum. For such task the network architecture was changed. Two different possibilities have been examined. In the first the preprocessed data were used as an inputs. Instead of direct muon detector responses a few parameter of the muon lateral distribution were used. The number of 192 input nodes with an information about the muons was reduced to only four: muon densities at two well measured distances (50 and 100 m) and the relative slopes of the muon lateral distribution these distances. The important information about the primary mass composition is also included

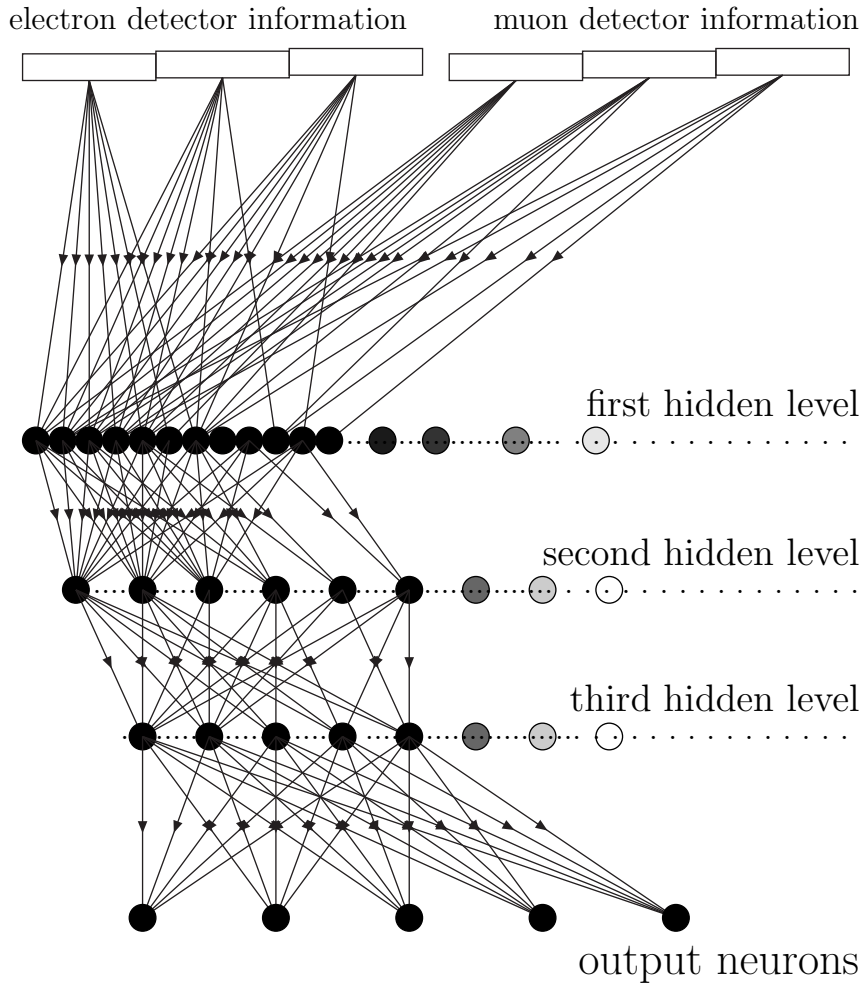

Fig. 7. Schematic layout of the Artificial Neural Network used for the primary particle mass determination using the preprocessed muon data.

in the electromagnetic shower component so another four input nodes were introduced with the same as for muon information but about the electron lateral distribution. To increase the number of intranetwork connections the additional hidden level was introduced. As an output level instead of one the five neurons were established each one related to the one group of nuclei in the primary cosmic ray mass spectrum. As the ANN answer the number of the neuron of the highest output signal was chosen.

The structure of the network is shown in Fig. 7.

First the behaviour of the network was tested for different pairs of five possible masses in primary spectrum. This was done to see if the ANN is able to distinguish between such as close events as produced for example by H ($A=1$)

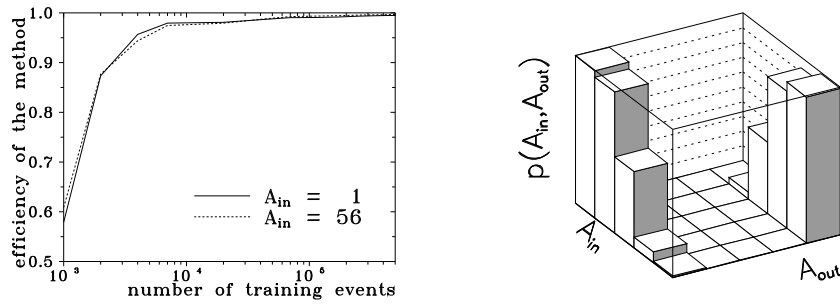

Fig. 8. The results of separation of H and Fe by ANN using preprocessed muon data. The efficiency of the ANN as a function of number of showers used for the network training (left) and the final separation results (right).

and He ($A=4$). The physical fluctuations in the shower development could disperse the information about the primary mass. It was concluded that the efficiency of the method in such a cases is rather questionable. However for outermost masses in the primary mass spectrum: H and Fe the separation is almost perfect as it is shown in Fig. 8. The network efficiency is defined as a conditional probability that the ANN output is right for each particular primary particle mass.

Difficulties with the close masses separation oblige to modify the training procedure for the network training with the five component mass spectrum. Requirement that the ANN answer should be exactly the one known from the simulation *true* primary particle mass gives the training process unsuccessful. Thus it has been replaced by the broader presumed output with the maximum at the *true* value but neighborhood output neuron signals were assumed to be higher than the much distant ones. With such modification the ANN was trained with all five components spectrum and the convergence was found. The results are given in Fig. 9.

The one more interesting possibility of the ANN architecture was examined. There were used as an input signals raw detector outputs from all 192 muon detectors and as before the preprocessed electron data. The statistical weight of an information about muons in each shower is reduced due to the fact that the fraction of the muons registered by all detectors in the KASCADE-like geometry experiment is about percent of all muons in the shower. The results presented previously were obtained using the all muon derived characteristic. The physically important question is if the ANN method can be used directly with raw experimental data.

First again the H – Fe separation possibility was tested. The results are presented in Fig. 10.

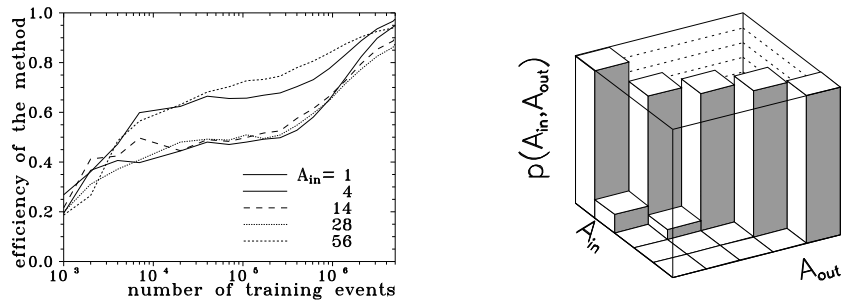

Fig. 9. The results of ANN method using preprocessed muon data for all five component trained network. The efficiency of the ANN as a function of number of showers used for the network training (left) and the final separation results (right).

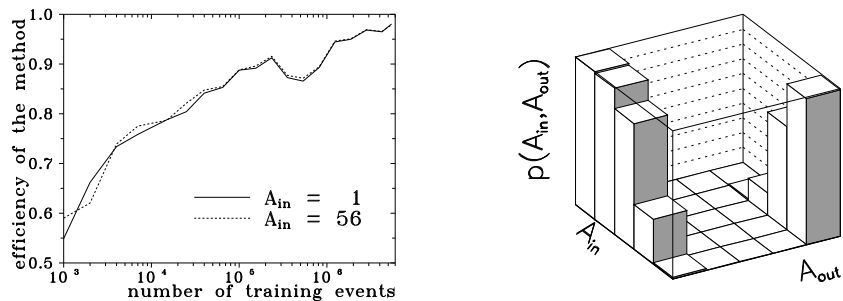

Fig. 10. The results of separation of H and Fe by ANN using raw muon detector data. The efficiency of the ANN as a function of number of showers used for the network training (a) and the final separation results (b).

It is surprising that, in contrary to what one could expect, the final efficiency achieved is not much worse than that obtained previously (Fig. 8). The only one what has changed is the training time. The network needs much more simulated showers to reach the final resolution. This is partially due to the increase of the number of neurons in the net.

Next and final step of the present analysis is to see, if the raw muon detector data from the KASCADE-like experiment allows one to distinguish between different components in the whole primary mass spectrum. The results are given in Fig. 11.

As it can be seen the efficiencies are worst than obtained previously for the "all muon data" (Fig. 9). However it is clear that the ANN is able to give some information about the primary particle mass.

The comparison of the efficiencies given in Figs. 9 and 11 shows that the ANN

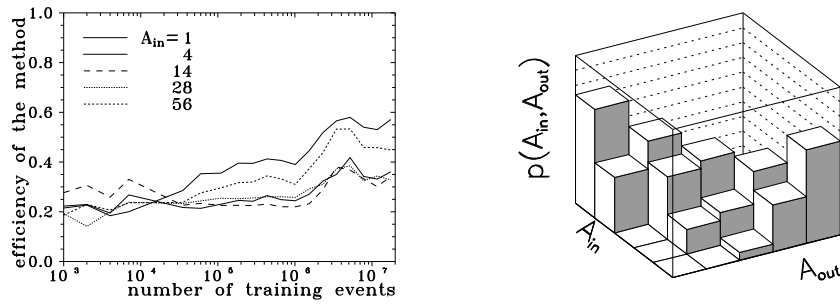

Fig. 11. The results of the primary mass separation by ANN using raw muon detector data. The efficiency of the ANN as a function of number of showers used for the network training (a) and the final separation results (b).

approach is very effective and the information collected by the detectors in KASCADE-like geometry experiment is rich enough to distinguish between the showers initiated by primary protons and iron nuclei only using the muons (and electrons) registered by the array detectors.

4 Summary

The results presented in that paper show that the ANN method can be used to find a total muon number in extensive air showers as well as to classify showers due to primary particle mass.

The comparison of the total muon number obtained using ANN with the standard minimization technics based method shows that the ANN procedure works as good and sometimes even better (for the small and very small showers) than the best minimization method.

The discrimination between different primary CR particle masses looks very promising. The further careful study on improvement the ANN sensitivity as well as on the accuracy of the EAS Monte-Carlo generator is needed to create a powerful tool for data analysis in cosmic ray experiments.

References

- [1] W. Duch and G. H. F. Diercksen, *Comput. Phys. Comm.* **82**, 91 (1994); H. J. Mayer, *Nucl. Instr. Meth.* **A317**, 339 (1992).

- [2] A. A. Chilingarian, M. Halpaap, H. J. Gils and H. Rebel, Proc. of XXIV Intern. Cosmic Ray Conf. Rome, **1**, 391 (1995).
- [3] T. Wibig, University of Lodz preprint 1996 (unpublished).
- [4] M. J. O'Connell, Comp. Phys. Comm. **8**, 49 (1974); P. Gabriel, IN THE Kernforschungszentrum Karlsruhe Report No. 5012 (1992); B. D'Ettorre Piazzoli et al., Proc. of XXIV Intern. Cosmic Ray Conf. Rome, **1**, 520 (1995).
- [5] J. N. Capdevielle et al., Kernforschungszentrum Karlsruhe Report No. 4998 (1992); J. Knapp and D. Heck, Kernforschungszentrum Karlsruhe Report No. 5196B, 1993; J. Knapp et al., Proc. XXIV Intern. Cosmic Ray Conf. Rome, **1**, 403 (1995).
- [6] P. Doll et al., Kernforschungszentrum Karlsruhe Report No. 4686, (1990), Nucl. Phys. B (Proc. Suppl.) **14A**, 336 (1990); H. O. Klages, Proc. XXIV Intern. Cosmic Ray Conf. Rome, **1**, 946 (1995).

$N_{\mu} f(N_{\mu})$

