

# CMB observations in LTB universes: Part II

## — the kSZ effect in an LTB universe —

---

**Chul-Moon Yoo**

*Yukawa Institute for Theoretical Physics, Kyoto University Kyoto 606-8502, Japan  
Asia Pacific Center for Theoretical Physics, Pohang, Gyeongbuk 790-784, Republic of  
Korea E-mail: yoo@yukawa.kyoto-u.ac.jp*

**Ken-ichi Nakao**

*Department of Mathematics and Physics, Graduate School of Science, Osaka City  
University, 3-3-138 Sugimoto, Sumiyoshi, Osaka 558-8585, Japan E-mail:  
knakao@sci.osaka-cu.ac.jp*

**Misao Sasaki**

*Yukawa Institute for Theoretical Physics, Kyoto University Kyoto 606-8502, Japan  
Korea Institute for Advanced Study 207-43 Cheongnyangni 2-dong, Dongdaemun-gu,  
Seoul 130-722, Republic of Korea E-mail: misao@yukawa.kyoto-u.ac.jp*

**ABSTRACT:** We study the kinematic Sunyaev-Zel'dovich (kSZ) effect in a Lemître-Tolman-Bondi (LTB) universe model whose distance-redshift relation agrees with that of the concordance  $\Lambda$ CDM model at redshifts  $z \lesssim 2$ . This LTB universe model has a void with size comparable to the Hubble horizon scale. We first determine the decoupling epoch in this LTB universe model by an approximate analytical condition under a few simplified assumptions on the physical quantities at that epoch. Then we calculate the cosmic microwave background (CMB) anisotropy observed in the rest frame of clusters of galaxies which are assumed to be at rest in the spatial comoving coordinates of the LTB universe model. We find that the obtained temperature anisotropies are dominated by dipole, although there may exist higher multi-poles in general. We may interpret this dipole anisotropy as the drift velocity of a cluster of galaxies relative to the CMB rest frame. Hence it gives rise to the kSZ effect. We calculate this effect and compare it with observational data. We find that if we assume the conventional adiabatic perturbation scenario at the time of decoupling, the drift velocity of clusters of galaxies becomes unacceptably large. Conversely, this observational constraint may be relaxed by introducing a non-adiabatic (i.e., primordially isocurvature) component of inhomogeneities at the time of decoupling. However, our result indicates that the necessary isocurvature perturbation amplitude is very large.

---

## Contents

<b>1. Introduction</b>	<b>1</b>
<b>2. Decoupling Epoch in the LTB Universe</b>	<b>3</b>
2.1 Background universe model	3
2.2 Decoupling epoch in the LTB universe	5
<b>3. Kinematic Sunyaev-Zel'dovich effect</b>	<b>8</b>
3.1 Case of homogeneous decoupling hypersurface	10
3.2 Case of inhomogeneous decoupling hypersurface	11
<b>4. Summary and Discussion</b>	<b>14</b>

---

## 1. Introduction

Copernican principle, i.e., the assumption that we are not at a special place in the universe, plays a very crucial role in the modern physical cosmology. If we accept this principle, the observed highly isotropic distribution of the cosmic microwave background (CMB), except for its dipolar anisotropy, implies the homogeneity and isotropy of our universe. The standard cosmological model based on this homogeneity and isotropy and on general relativity, namely the  $\Lambda$ CDM model, naturally explains various important observational facts, supporting strongly the validity of the Copernican principle, though the homogeneity of our universe has not yet been directly tested.

Within the framework of homogeneous and isotropic cosmological models, the distance-redshift relation of type Ia supernovae and the CMB data by WMAP lead us to a conclusion that there is so-called dark energy as a major component of the universe. The present observational data is consistent with the dark energy being a positive cosmological constant. However, the energy density of the dark energy is about  $10^{-120}$  times smaller than the Planck energy density. This number is regarded as one of the most unnatural numbers of the universe. Hence, recently, many authors have been discussing the possibility to explain observations without dark energy by using anti-Copernican universe models in which we are assumed to be at a very special position in the universe. Usually, in anti-Copernican models, we are assumed to be located at the center of a spherically symmetric inhomogeneous universe [1, 2, 3, 4, 5].

One of the important attempts in this direction is to explain the type Ia supernovae observation using spherically symmetric inhomogeneities without dark energy. There exists an exact solution of the Einstein equations known as the Lemaître-Tolman-Bondi (LTB) solution which describes a system of spherically symmetric dust. Actually, it is possible to

construct an LTB universe model whose distance-redshift relation observed at the symmetry center agrees with that of the concordance  $\Lambda$ CDM model [5, 6, 7, 8, 9, 10]. Such an LTB universe model has a very large void structure comparable to the cosmological horizon scale. This result is very important because it implies that, in order to know the precise information about the dark energy, we have to know how to distinguish the effect of the dark energy from that of inhomogeneity. For this purpose, in this paper, we also study the LTB cosmology with an observer like us at its center.

CMB observations in LTB universe models are also often discussed [11, 12, 13, 14, 15, 16, 17, 18, 19, 20, 21, 22, 23, 24, 25, 26, 27, 28, 29, 30]. In many of these works, it is assumed that the universe is homogeneous in the spacelike asymptotic region from which the CMB photons come, hence the CMB photon distribution is assumed to be the same as that in the homogeneous and isotropic universe models at the last scattering surface (LSS).

One of the most stringent constraints on the LTB universe model with a large void come from the observation of the kinematic Sunyaev-Zel'dovich (kSZ) effect. In the case of a homogeneous and isotropic universe, if a cluster of galaxies has a finite drift velocity relative to the CMB comoving frame, it causes a dipole anisotropy in the CMB temperature in the cluster rest frame. Then Compton scattering of the CMB photons inside a cluster of galaxies causes a distortion in the CMB spectrum in the direction of the cluster of galaxies. Therefore observation of distortions in the CMB spectrum constrains the drift velocity of clusters of galaxies.

In the case of LTB universe models, even if clusters of galaxies are comoving with the non-relativistic matter component in the universe, or in other words, even if they are at rest in the comoving spatial coordinates, an anisotropy of the CMB temperature will be observed at an off-center cluster due to the inhomogeneity of the universe. In contrast to a homogeneous and isotropic universe, this effect may not necessarily be of kinematic origin, since higher multi-pole components of the CMB anisotropy may exist in the cluster rest frame. This is because an LTB universe model is neither homogeneous nor isotropic at off-center clusters of galaxies. In this sense, the terminology ‘the kSZ effect’ is not so appropriate for this effect in the LTB universe model. However, as will be shown later, in our LTB universe model, the anisotropy observed in the rest frame of a cluster of galaxies is found to be dominated by a dipole component. Since a dipole anisotropy may be regarded as the effect of the drift velocity of a cluster of galaxies, we may call this effect the kSZ effect.

In Ref. [17], Garcia-Bellido and Haugboelle reported that current observations of only nine clusters with large error bars would already rule out an LTB universe model with a void of a radius greater than  $\sim 1.5$ Gpc. Their LTB universe model also has a large spherical void structure, but it is homogeneous and isotropic in the spatially asymptotic region. Thus, the CMB at and near the last scattering surface is estimated by the same procedure as in the case of a homogeneous and isotropic universe model. Differently from standard cosmology, however, in the LTB universe models, it might be possible to introduce radial inhomogeneities in the CMB temperature.

In this paper, we analyze the kSZ effect in the LTB universe model whose distance-redshift relation observed at the center agrees with the concordance  $\Lambda$ CDM model, and

then we show that the observational constraints from the kSZ effect have ruled out LTB universe models based on the adiabatic perturbation scenario, but not so if we allow the existence of non-adiabatic inhomogeneities at the decoupling epoch.

This paper is organized as follows. In §2, we introduce the LTB solution and show how to fix the decoupling epoch in an LTB universe model. Under some reasonable assumptions on the physical quantities at the decoupling epoch, we calculate the dipole anisotropy of the CMB temperature observed at each cluster of galaxies in the adiabatic scenario in which there existed only adiabatic curvature perturbations in the early universe in §3.1. We find that the dipole anisotropy is too large to be consistent with observational data. Then in §3.2, we assume the existence of isocurvature inhomogeneities at the decoupling epoch, and show that it may save LTB universe models. Finally, §4 is devoted to summary and discussion.

## 2. Decoupling Epoch in the LTB Universe

### 2.1 Background universe model

In Ref. [8], Yoo, Kai and Nakao numerically constructed an LTB universe model whose distance-redshift relation agrees with that of the concordance  $\Lambda$ CDM model in the whole redshift domain and which is homogeneous at the early stage of the universe. Recently we modified this LTB universe model at redshifts  $z \gtrsim 2$  so that the peak positions in the CMB temperature anisotropy are consistent with the observation [31] (hereafter referred to as Paper I). In this paper, we use this LTB model as the background universe.

The metric of the LTB solution is given by

$$ds^2 = -c^2 dt^2 + \frac{(\partial_r R(t, r))^2}{1 - k(r)r^2} dr^2 + R^2(t, r)(d\vartheta^2 + \sin^2 \vartheta d\varphi^2), \quad (2.1)$$

where  $k(r)$  is an arbitrary function of the radial coordinate  $r$ . The matter is dust whose stress-energy tensor is given by

$$T^{\mu\nu} = \rho u^\mu u^\nu, \quad (2.2)$$

where  $\rho = \rho(t, r)$  is the mass density, and  $u^\mu$  is the four-velocity of the fluid element. The coordinate system in Eq. (2.1) is chosen in such a way that  $u^\mu = (1, 0, 0, 0)$ .

The area radius  $R(t, r)$  satisfies one of the Einstein equations,

$$\left(\frac{\partial R}{\partial t}\right)^2 = \frac{2GM(r)}{R} - c^2 k(r)r^2, \quad (2.3)$$

where  $M(r)$  is an arbitrary function related to the mass density  $\rho$  by

$$\rho(t, r) = \frac{1}{4\pi R^2(t, r)} \frac{dM(r)}{dr}. \quad (2.4)$$

Following [32], we write the solution of Eq. (2.3) in the form,

$$R(t, r) = (6GM(r))^{1/3} (t - t_B(r))^{2/3} S(x), \quad (2.5)$$

$$x = c^2 k(r) r^2 \left( \frac{t - t_B(r)}{6GM(r)} \right)^{2/3}, \quad (2.6)$$

where  $t_{\text{B}}(r)$  is an arbitrary function which determines the big bang time, and  $S(x)$  is a function defined implicitly as

$$S(x) = \begin{cases} \frac{\cosh \sqrt{-\eta} - 1}{6^{1/3}(\sinh \sqrt{-\eta} - \sqrt{-\eta})^{2/3}}; & x = \frac{-(\sinh \sqrt{-\eta} - \sqrt{-\eta})^{2/3}}{6^{2/3}} \quad \text{for } x < 0, \\ \frac{1 - \cos \sqrt{\eta}}{6^{1/3}(\sqrt{\eta} - \sin \sqrt{\eta})^{2/3}}; & x = \frac{(\sqrt{\eta} - \sin \sqrt{\eta})^{2/3}}{6^{2/3}} \quad \text{for } x > 0, \end{cases} \quad (2.7)$$

and  $S(0) = (3/4)^{1/3}$ . The function  $S(x)$  is analytic for  $x < (\pi/3)^{2/3}$ . Some characteristics of the function  $S(x)$  are given in [32] and [8].

As shown in the above, the LTB solution has three arbitrary functions,  $k(r)$ ,  $M(r)$  and  $t_{\text{B}}(r)$ . One of them is a gauge degree of freedom for rescaling of the radial coordinate  $r$ . We fix this by setting

$$M(r) = \frac{4}{3}\pi\rho_0 r^3, \quad (2.8)$$

where  $\rho_0$  is the energy density at the center at present  $\rho_0 = \rho(t_0, 0)$ . As in the case of the homogeneous and isotropic universe, the present Hubble parameter  $H_0$  is related to  $\rho_0$  as

$$H_0^2 + k(0)c^2 = \frac{8}{3}\pi G\rho_0. \quad (2.9)$$

As in [8], we assume the simultaneous big bang, i.e.,

$$t_{\text{B}}(r) = 0. \quad (2.10)$$

For notational simplicity, we introduce dimensionless quantities,

$$\tilde{r} := \frac{H_0 r}{c}, \quad \tilde{k}(\tilde{r}) := \frac{k(r)c^2}{H_0^2}.$$

The LTB universe model proposed in Paper I is specified by the following curvature function:

$$\tilde{k}(\tilde{r}) = \tilde{k}_{\text{fit}}(\tilde{r}) \times f(\tilde{r}; A), \quad (2.11)$$

where

$$\tilde{k}_{\text{fit}}(\tilde{r}) = \frac{0.545745}{0.211472 + \sqrt{0.026176 + \tilde{r}}} - \frac{2.22881}{(0.807782 + \sqrt{0.026176 + \tilde{r}})^2}, \quad (2.12)$$

$$f(\tilde{r}; A) = \begin{cases} 1 & \text{for } \tilde{r} < 2 \\ 1 + \frac{16A(\tilde{r}-2)^3(323-123\tilde{r}+12\tilde{r}^2)}{3125} & \text{for } 2 \leq \tilde{r} < 9/2 \\ 1 + A & \text{for } 9/2 \leq \tilde{r} \end{cases} \quad (2.13)$$

with  $A = -1.069$ . The distance-redshift relation of this LTB solution agrees with that of the concordance  $\Lambda$ CDM model at redshifts  $z \lesssim 2$ .

## 2.2 Decoupling epoch in the LTB universe

The decoupling between photons and baryons occurs in an inhomogeneous universe just as in the case of a homogeneous universe. That is, it occurs when the mean free path of photons becomes effectively infinite due to almost complete recombination of electrons to protons.

Since there is no radiation component in our LTB model, we cannot treat the decoupling in a rigorous manner. However, as in the concordance model, we expect the energy density of the radiation to be only a small fraction of the total density at decoupling, hence its effect on the spacetime geometry is small, if not negligible. In fact, the radiation energy density estimated in our LTB model turns out to be about 20% of the total energy density. This means that treating the radiation as a test field in our model is consistent to a first approximation.

Another approximation we adopt is the instantaneous decoupling. Namely, we assume decoupling to occur on a single spacelike hypersurface. Since our LTB universe model is inhomogeneous but spherically symmetric, it is natural to assume that the decoupling hypersurface is also inhomogeneous but spherically symmetric. Thus it is specified by the form,

$$t = t_D(r). \quad (2.14)$$

The cross section of this hypersurface with the past directed null cone from the observer at the center constitutes the LSS of CMB photons (see Fig. 1). The LSS is a spacelike

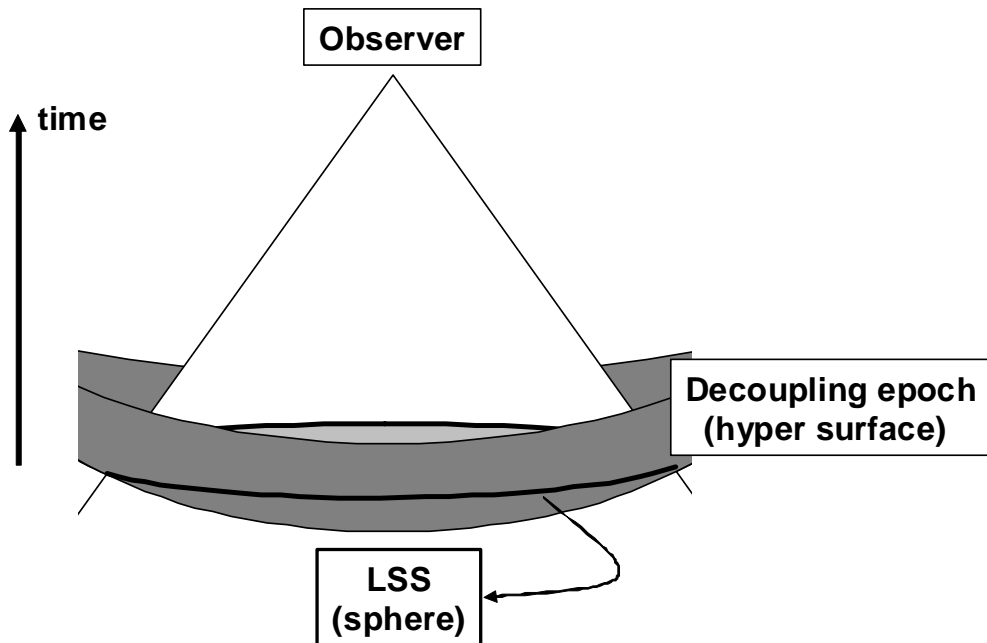

**Figure 1:** Schematic figure for the hypersurface of the decoupling epoch in an LTB universe.

2-dimensional sphere by the assumed symmetry. We use the subscript  $*$  to express phys-

ical quantities on the LSS. In our approximation, ignoring secondary effects, the CMB anisotropy is essentially determined by the distribution of photons on the LSS.

The geodesic equations to determine the past light cone from the observer at the center are written in the form,

$$(1+z)\frac{dt}{dz} = -\frac{\partial_r R}{\partial_t \partial_r R}, \quad (2.15)$$

$$(1+z)\frac{dr}{dz} = \frac{c\sqrt{1-k(r)r^2}}{\partial_t \partial_r R}, \quad (2.16)$$

where the past directed radial null geodesics have been parametrized by the cosmological redshift  $z$ . We denote the solution of the above equations by

$$t = t_{\text{lc}}(z), \quad r = r_{\text{lc}}(z). \quad (2.17)$$

Now to discuss the decoupling condition, for simplicity, we consider a universe consists of cold dark matter, protons and electrons, and neutral hydrogen atoms. In particular, we neglect helium. Since the contributions of helium and the other components are not large, this simplification should not lead to a serious error in our analysis. We also assume that, until the decoupling time, photons, electrons and protons are in thermal equilibrium. The energy density of the electrons and photons is negligible, and hence the constituents of our LTB model are cold dark matter and baryons, the latter of which consist of protons and hydrogen atoms. Thus the baryon number density  $n_b$  is equal to the total number density of protons and hydrogen atoms, and the electron number density  $n_e$  is equal to the proton number density.

In homogeneous and isotropic cosmology, the decoupling time is well determined by Gamow's criterion,

$$H = \Gamma, \quad (2.18)$$

where  $H$  is the Hubble parameter and  $\Gamma$  is the rate of collisions of a photon with electrons. Using the Thomson scattering cross section  $\sigma_T$  and the electron number density  $n_e$ ,  $\Gamma$  is written as

$$\Gamma = cn_e\sigma_T. \quad (2.19)$$

In our LTB model, we adopt this criterion, with the identification of the ‘‘Hubble parameter  $H$ ’’ with

$$H^2 = \frac{8\pi G}{3}\rho. \quad (2.20)$$

Since, by virtue of Eq. (2.10), our LTB universe model is almost identical to the Einstein-de Sitter universe near the decoupling time. Hence the above definition of  $H$  is accurate enough for our purpose.

In order to estimate the electron number density, for simplicity, we use Saha's equation assuming thermal equilibrium. We note that our assumption of thermal equilibrium at the decoupling epoch is not appropriate in reality, because the decoupling process is controlled by a non-thermal physical process [33]. However, as mentioned in [28], the error in the temperature estimate turns out to be 2 - 3%. Hence our treatment of the decoupling is good enough for our qualitative discussions about the kSZ effect.

Let us consider the ionization rate  $X_e := n_e/n_b$ . In thermal equilibrium, the ionization rate  $X_e$  satisfies Saha's equation,

$$\frac{1 - X_e}{X_e^2} = \frac{4\sqrt{2}\zeta(3)}{\sqrt{\pi}} \eta \left( \frac{k_B T}{m_e c^2} \right)^{3/2} \exp\left( \frac{13.59\text{eV}}{k_B T} \right), \quad (2.21)$$

where  $\zeta(x)$  is the zeta function, and  $T$ ,  $\eta$ ,  $k_B$  and  $m_e$  are the temperature, the baryon-to-photon ratio, the Boltzmann constant and the electron mass, respectively. Since the ionization rate at decoupling drops down to  $X_e \sim 10^{-5}$ , we may approximate the above equation by

$$X_e^2 \simeq \frac{\sqrt{\pi}}{4\sqrt{2}\zeta(3)} \frac{1}{\eta} \left( \frac{k_B T}{m_e c^2} \right)^{-3/2} \exp\left( -\frac{13.59\text{eV}}{k_B T} \right). \quad (2.22)$$

Using this equation, Gamow's criterion (2.18) is rewritten in the form,

$$\eta = \frac{32\sqrt{2\pi}\zeta(3)}{3} \frac{G\rho}{(cn_{\gamma 0}\sigma_T)^2} \left( \frac{k_B T_0}{m_e c^2} \right)^{3/2} \left( \frac{T_0}{T} \right)^{9/2} \exp\left( \frac{13.59\text{eV}}{k_B T} \right), \quad (2.23)$$

where  $n_{\gamma 0}$  and  $T_0 \simeq 2.725\text{K}$  are the present photon number density and observed CMB temperature, respectively.

Since we assume thermal equilibrium of electrons, protons and photons until the decoupling time  $t = t_D(r)$ , the physical state of the decoupling hypersurface, which is spherically symmetric, is determined by the distributions of the temperature  $T = T_D(r)$ , the baryon-to-photon ratio  $\eta = \eta_D(r)$ , and the matter energy density  $\rho = \rho(t_D(r), r)$ . For convenience, in place of  $\rho(t_D(r), r)$ , we introduce the following quantity:

$$\alpha_D(r) := \frac{\rho(t_D(r), r)}{\rho_0} \left( \frac{T_0}{T_D(r)} \right)^3. \quad (2.24)$$

The quantity  $\alpha_D(r)$  is proportional to the ratio of the matter density and the photon number density. Then, from Eq. (2.23), we obtain

$$\eta_D(r) = \frac{32\sqrt{2\pi}\zeta(3)}{3} \frac{G\rho_0}{(cn_{\gamma 0}\sigma_T)^2} \left( \frac{k_B T_0}{m_e c^2} \right)^{3/2} \alpha_D(r) \left( \frac{T_0}{T_D(r)} \right)^{3/2} \exp\left( \frac{13.59\text{eV}}{k_B T_D(r)} \right). \quad (2.25)$$

We note that once  $T_D(r)$  and  $\alpha_D(r)$  are given, the hypersurface  $t = t_D(r)$  can be obtained from Eq. (2.24).

On the LSS, we must have

$$\frac{T_D(r_{lc}(z_*))}{T_0} = \frac{T_*}{T_0} = 1 + z_*. \quad (2.26)$$

Then, if we regard  $T_D(r)$ ,  $\eta_D(r)$  and  $\alpha_D(r)$  as mutually independent functions, we have one functional condition (2.25) and one boundary condition at  $z = z_*$  to constrain these three functions. But these are not enough to determine the decoupling hypersurface,  $t = t_D(r)$ , through Eq. (2.24). We would need two more functional conditions. However, to know the location of the LSS for the observer at the center, we only need a single condition on the LSS in addition to Eqs. (2.25) and (2.26). For simplicity, we impose

$$\eta_* = 6.2 \times 10^{-10} \quad (2.27)$$



as in Paper I [31].

We numerically solve the radial null geodesic equations (2.15) and (2.16). At each redshift  $z$ , we define  $T$  and  $\alpha$  by

$$T = (1 + z)T_0, \quad (2.28)$$

$$\alpha = \frac{\rho(t_{\text{lc}}(z), r_{\text{lc}}(z))}{\rho_0(1 + z)^3}. \quad (2.29)$$

During the numerical integration, we check at each redshift  $z$  whether Eq. (2.25) is satisfied by  $T_{\text{D}} = T$ ,  $\alpha_{\text{D}} = \alpha$  and  $\eta_{\text{D}} = \eta_*$ . If Eq. (2.25) is satisfied, we stop integrating Eqs. (2.15) and (2.16), and identify  $z$ ,  $T$  and  $\alpha$  at this moment with  $z_*$ ,  $T_*$  and  $\alpha_*$ , respectively. For our LTB universe model, we have obtained

$$\frac{T_*}{T_0} = 1 + z_* \simeq 1130, \quad (2.30)$$

$$\alpha_* \simeq 5.184, \quad (2.31)$$

### 3. Kinematic Sunyaev-Zel'dovich effect

We consider the kSZ effect caused by the hot gases bound within clusters of galaxies which are assumed to be at rest in the spatial coordinates of the LTB universe model. Let us consider a cluster of galaxies at redshift  $z = z_c$ . In order to know how the CMB is observed at the position of this cluster of galaxies, we numerically integrate pastward the null geodesic equations from this cluster to every direction (see Fig. 2). Without loss of generality, we may focus on null geodesics in the plane  $\varphi = 0$ . Then the non-radial null geodesic equations are given by

$$t'' = -\frac{(\partial_r R)\partial_t \partial_r R}{1 - kr^2} r'^2 - R(\partial_t R) \vartheta'^2, \quad (3.1)$$

$$r'' = -2[\partial_t(\ln \partial_r R)] t' r' + \frac{1}{2} [\partial_r \ln(1 - kr^2) - 2\partial_r(\ln \partial_r R)] r'^2 + \frac{(1 - kr^2)R}{\partial_r R} \vartheta'^2, \quad (3.2)$$

$$\vartheta'' = 2(\partial_t \ln R) t' \vartheta' - 2(\partial_r \ln R) r' \vartheta', \quad (3.3)$$

where the prime denotes differentiation with an affine parameter. From the null condition, we have

$$r'^2 = \frac{1 - kr^2}{(\partial_r R)^2} (t'^2 - R^2 \vartheta'^2). \quad (3.4)$$

The initial conditions  $(t_i, r_i, \vartheta_i, t'_i, r'_i, \vartheta'_i)$  to integrate the null geodesic equations are given by

$$t_i = t_c := t_{\text{lc}}(z_c), \quad (3.5)$$

$$r_i = r_c := r_{\text{lc}}(z_c), \quad (3.6)$$

$$\vartheta_i = 0, \quad (3.7)$$

$$t'_i = -(1 + z_c), \quad (3.8)$$

$$r'_i = \frac{\sqrt{1 - k(r_c)r_c^2}}{\partial_r R|_{t=t_c, r=r_c}} (1 + z_c) \cos \theta, \quad (3.9)$$

$$\vartheta'_i = \frac{1}{R|_{t=t_c, r=r_c}}(1+z_c)\sin\theta, \quad (3.10)$$

where  $\theta$  describes the direction of the null geodesic in the cluster rest frame (see Fig. 2). Note that Eq. (3.8) is a condition to fix the degree of freedom for the affine transformation. It is easy to see that Eq. (3.4) is satisfied by these initial conditions. The redshift at each point on the null geodesic is defined by

$$1+z = -t'. \quad (3.11)$$

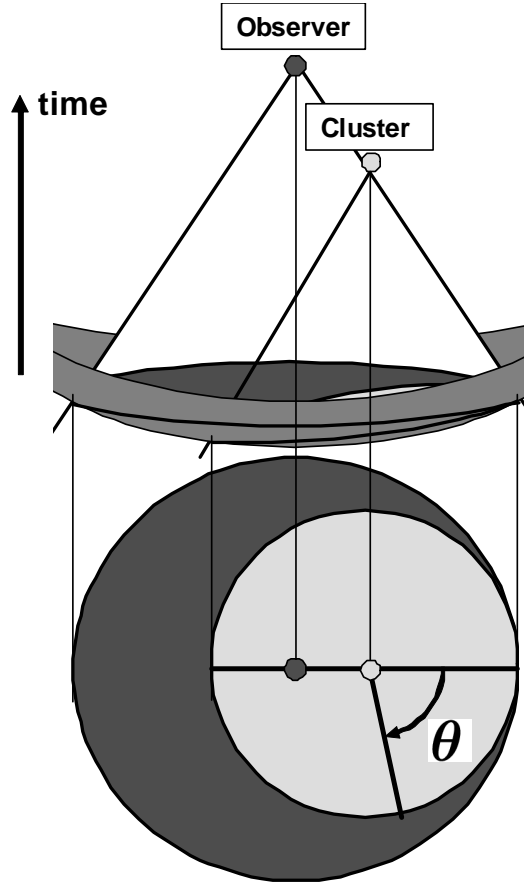

**Figure 2:** A schematic figure of the spacetime and the LSS.

At the intersection between the past light-cone of the cluster of galaxies located at  $z = z_c$  and the decoupling hypersurface, we stop integrating Eqs. (3.1)–(3.3) and label the redshift at this intersection as  $z_D(\theta; z_c)$ . Here note that  $z_D(0; z_c) = z_*$ . Then, the CMB temperature  $T_{cl}(\theta; z_c)$  observed at the cluster of galaxies located at  $z = z_c$  is obtained by

$$T_{cl}(\theta; z_c) = \frac{1+z_c}{1+z_D(\theta; z_c)} T_D(r_D(\theta; z_c)), \quad (3.12)$$

where  $r = r_{\text{D}}(\theta; z_c)$  is the radial coordinate of the intersection between the past light-cone of this cluster and the decoupling hypersurface. If we know the temperature  $T_{\text{D}}(r)$  on the decoupling hypersurface, we find  $T_{\text{cl}}(\theta; z_c)$  by the above equation. Conversely, if we know the information about  $T_{\text{cl}}(\theta; z_c)$  through the kSZ effect, we find  $T_{\text{D}}(r)$  for the domain  $r_{\text{D}}(\pi; z_c) \leq r \leq r_{\text{D}}(0; z_c)$ .

### 3.1 Case of homogeneous decoupling hypersurface

As mentioned in the second to the last paragraph in §2.2, we do not have enough information to determine the physical quantities on the decoupling hypersurface,  $T_{\text{D}}(r)$ ,  $\eta_{\text{D}}(r)$  and  $\alpha_{\text{D}}(r)$  and hence the embedding of the decoupling hypersurface  $t = t_{\text{D}}(r)$ . To determine them, we need to impose two additional assumptions on these quantities. Here, we assume  $T_{\text{D}}(r)$  and  $\eta_{\text{D}}(r)$  are constant, i.e.,  $T_{\text{D}}(r) = T_*$  and  $\eta_{\text{D}}(r) = \eta_*$ . Then  $\alpha_{\text{D}}(r)$  also becomes a constant determined by Eq. (2.25). Consequently, from Eq. (2.24), we can determine the decoupling hypersurface  $t = t_{\text{D}}(r)$ .

Since an LTB universe model is neither homogeneous nor isotropic for an observer at an off-center cluster of galaxies, not only a dipole component but also higher multipole components in  $T_{\text{cl}}(\theta; z_c)$  may exist. However, we find from our numerical results that the anisotropy in  $T_{\text{cl}}(\theta; z_c)$  is dominated by dipole, and thus we can fit  $T_{\text{cl}}(\theta; z_c)$  with the Doppler shifted temperature distribution,

$$T_{\text{dipole}}(\theta; z_c) := \frac{c - v_c(z_c)}{c - v_c(z_c) \cos \theta} T_c(0; z_c), \quad (3.13)$$

where  $v_c(z_c)$  is regarded as the effective drift velocity of the cluster at  $z = z_c$  relative to the CMB rest frame, and is determined by using the least-square method (see Fig. 3).

The result is shown in Fig. 4 compared with the observed values for nine clusters reported in [34, 35, 36]. The observational data are listed in Table 1. Obviously, the

**Table 1:** Observed drift velocities for nine clusters.

$i(1 - 9)$ : name	redshift( $z_i$ )	drift velocity[km/s]( $v_i$ )	$\sigma_i^+$ [km/s]	$\sigma_i^-$ [km/s]
1: A1689[34]	0.18	+170	+815	-630
2: A2163[34]	0.20	+490	+1370	-880
3: A2261[35]	0.22	-1575	+1500	-975
4: A2396[35]	0.23	+1900	+6225	-2650
5: A1835[35]	0.25	-175	+1675	-1275
6: Zw 3146[35]	0.29	-400	+3700	-1925
7: RX J1347-1145[36]	0.45	+1420	+1170	-1270
8: Cl 0016 + 16[35]	0.55	-4100	+2650	-1625
9: MS 0451[35]	0.55	+490	+1370	-880

effective drift velocity in our model is far larger than the observed values. This fact means that our LTB universe model whose  $T_{\text{D}}(r)$ ,  $\eta_{\text{D}}(r)$  and  $\alpha_{\text{D}}(r)$  are constant cannot explain the observational data.

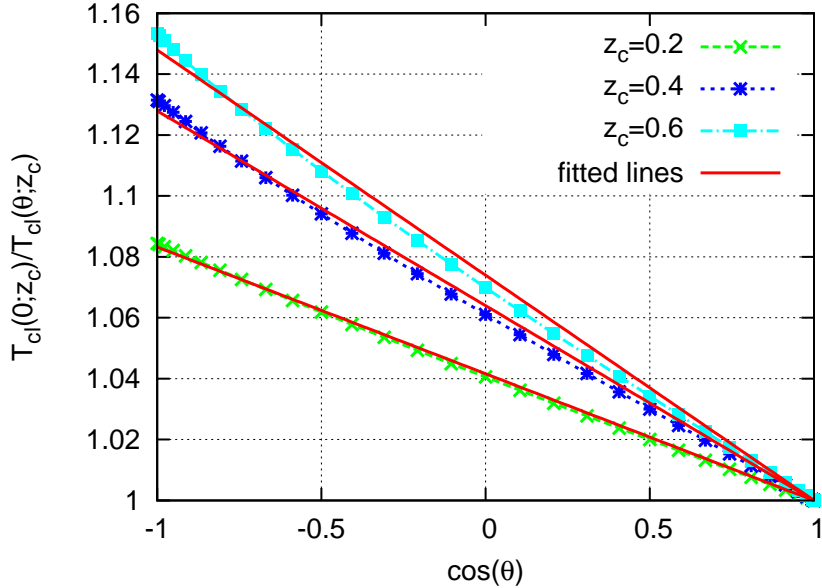

**Figure 3:** The temperature anisotropy seen at a cluster of galaxies,  $T_{\text{cl}}(\theta; z_c)$ , and the dipole fit to it,  $T_{\text{dipole}}(\theta; z_c)$ , for several values of  $z_c$ .

Here we have assumed that the ratios of two of any physical quantities (the energy densities of baryon, dark matter, photons, temperature of photon) are constant on the decoupling hypersurface. Since, by virtue of the assumption (2.10), our background LTB universe model is very close to a homogeneous Einstein-de Sitter universe at the decoupling epoch, these assumptions imply that inhomogeneities are small and adiabatic at that time. Therefore the above result strongly indicates that anti-Copernican LTB cosmological models are virtually excluded by the observational data within the context of the conventional adiabatic perturbation scenario for the structure formation.

In [17, 27], homogeneity at the last scattering surface was also assumed and their results are qualitatively consistent with the result obtained in this section.

### 3.2 Case of inhomogeneous decoupling hypersurface

We now consider the possibility of an inhomogeneous LSS and look for an  $r$ -dependent decoupling hypersurface  $t = t_D(r)$  and the physical quantities  $T_D(r)$ ,  $\eta_D(r)$  and  $\alpha_D(r)$  so that the observational results of the kSZ effect can be explained by our LTB universe model.

First, for simplicity, we assume  $\eta_D(r) = \eta_*$  (see [25] about inhomogeneity of  $\eta_D$ ). Then, to fix the decoupling epoch, we consider a comoving fiducial cluster of galaxies at redshift  $z_c = z_f$ . We assume that the anisotropy of the CMB temperature observed in the rest frame of the fiducial cluster is purely dipolar, i.e.,

$$T_{\text{cl}}(\theta; z_f) = \frac{c - v_f}{c - v_f \cos \theta} T_{\text{cl}}(0; z_f) = \frac{c - v_f}{c - v_f \cos \theta} (1 + z_f) T_0, \quad (3.14)$$

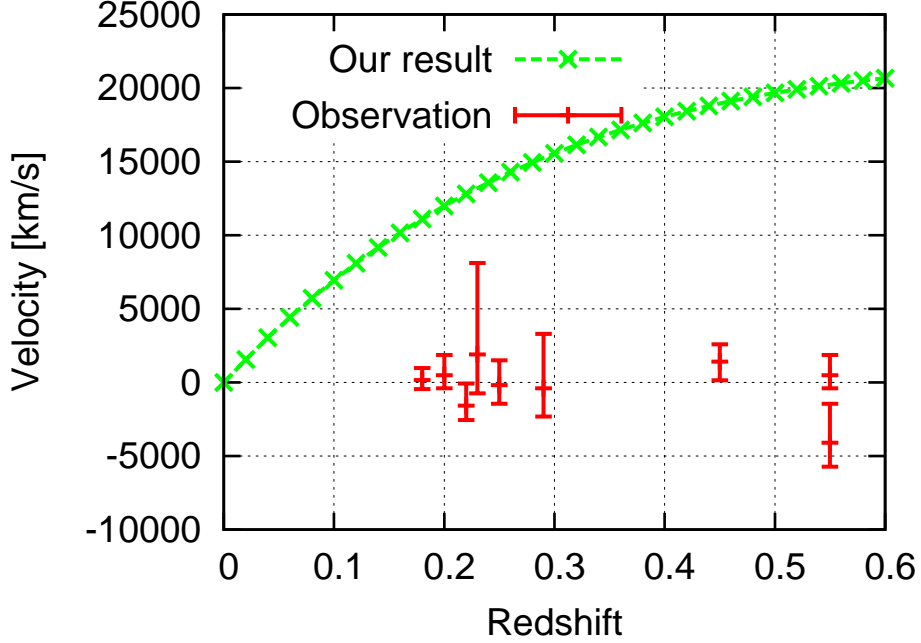

**Figure 4:** Effective drift velocity at each cluster redshift for a homogeneous temperature distribution on the decoupling hypersurface.

where  $v_f$  is the effective drift velocity of the fiducial cluster of galaxies relative to the CMB rest frame. Then, the decoupling hypersurface,  $t = t_D(r)$  is obtained from the above CMB temperature  $T_{\text{cl}}(\theta; z_f)$  in the following manner: We numerically integrate null geodesic equations (3.1)–(3.3) pastward from this fiducial cluster of galaxies to every direction. At each redshift  $z$  on the null geodesic to the direction specified by  $\theta$ , we define  $T$  and  $\alpha$  by

$$T = \frac{1+z}{1+z_f} T_{\text{cl}}(\theta; z_f), \quad (3.15)$$

$$\alpha = \frac{\rho(t_g(z; \theta), r_g(z; \theta))}{\rho_0} \left( \frac{T_0}{T} \right)^3, \quad (3.16)$$

where  $t = t_g(z; \theta)$  and  $r = r_g(z; \theta)$  represent the trajectory of this null geodesic (see Fig. 5).

During the numerical integration, we check at each redshift  $z$  whether Eq. (2.25) is satisfied by  $T_D = T$ ,  $\alpha_D = \alpha$  and  $\eta_D = \eta_*$ . If Eq. (2.25) is satisfied, we stop integrating Eqs. (3.1)–(3.3). At this moment, we have  $z = z_D(\theta; z_f)$  and  $r_g(z; \theta) = r_D(\theta; z_f)$ . This determines  $T$  and  $\alpha$  as functions of  $r$ :  $T = T_D(r_D(\theta; z_f))$  and  $\alpha = \alpha_D(r_D(\theta; z_f))$ , respectively. The schematic figure for the trajectory  $r = r_D(\theta; z_f)$  is shown in Fig. 5. We find from this figure that

$$r_D(\pi; z_f) \leq r_D(\theta; z_f) \leq r_D(0; z_f) = r_{\text{lc}}(z_*) \quad \text{for } 0 \leq \theta \leq \pi. \quad (3.17)$$

The above inequality means that the functional forms of  $T_D(r)$  and  $\alpha_D(r)$  are determined only for the range  $r_D(\pi; z_f) \leq r \leq r_{\text{lc}}(z_*)$ . However, this information is enough for the calculation of the temperature anisotropies from other clusters at redshift  $z_c < z_f$ , because

the past light-cone emanated from this cluster intersects with the decoupling hypersurface inside the region  $r_D(\pi; z_f) \leq r \leq r_{lc}(z_*)$  as shown in Fig. 5.

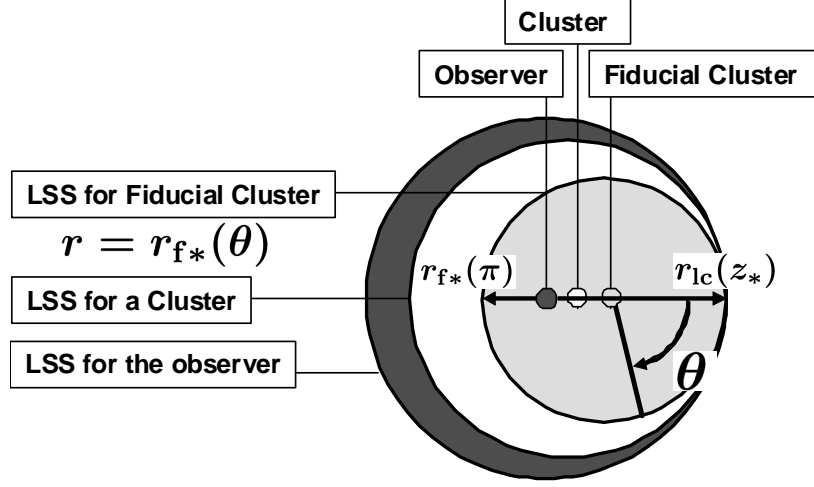

**Figure 5:** Schematic figure of LSSs on the decoupling hypersurface for the fiducial cluster, a cluster at a redshift  $z_c < z_f$  and the observer at  $z = 0$  (us).

Applying the same procedure as in the previous section, we obtain the CMB temperature  $T_{cl}(\theta; z_c)$  observed at a cluster of galaxies located at  $z = z_c < z_f$ . Results are shown in Fig. 6, where we set  $z_f = 0.6$ . The effective velocities  $v_c(z_c)$  for various values of  $v_f$  are

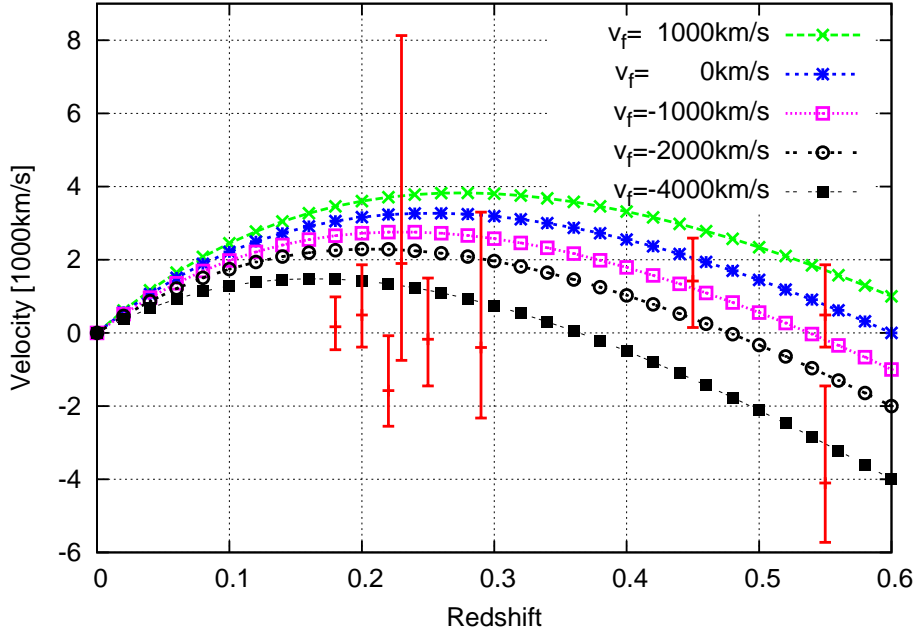

**Figure 6:** The effective velocities as functions of the cluster redshift  $z_c$  are shown for various values of  $v_f$ . The fiducial cluster is at  $z_f = 0.6$ .

shown as functions of the cluster redshift  $z_c$ . The effective velocity of a cluster is evaluated from the temperature anisotropy seen from the cluster using the least-square method. It is clear that the result has much better consistency with the observational data than the model with an adiabatic situation in §3.1.

In order to compare our result with that obtained in [17], we have calculated the same log-likelihood as theirs,

$$-2 \ln \mathcal{L} = \sum_i \frac{(v_i - v_c(z_i) + v_{\text{sys}})^2}{\sigma_i^{\pm 2} + \sigma_{\text{pv}}^2}. \quad (3.18)$$

As shown in the cases  $\sigma_{\text{pv}} = 1600\text{km/s}$ , even though our model has an extremely large void, it turns out to be consistent with the observational data in the 1- $\sigma$  level.

However, it is too early to conclude from the above result that the LTB-type anti-Copernican cosmology is consistent with observation. There is a very important point to be reminded. In Fig. 8, we depict the temperature and density distributions on the decoupling hypersurface,  $T_D(r)$  and  $\rho_D(r) := \rho(t_D(r), r)$ . We can see from Fig. 8 that there is a factor of two difference in the matter density  $\rho_D(r)$  on the decoupling hypersurface over the range of  $r$  of our interest, while the temperature  $T_D(r)$  is nearly uniform. Thus the uniform temperature hypersurfaces are far different from uniform density hypersurfaces, implying the existence of an isocurvature perturbation with the amplitude of order unity. In particular, on a  $\rho = \text{const.}$  hypersurface, the distribution of the radiation is highly inhomogeneous. Therefore it would be wrong to assume the evolution of the universe to be the same as in a homogeneous and isotropic universe in the radiation dominated era.

The above result leads to a significant difficulty in predicting almost all observables related to the structure formation. To begin with, it implies that an LTB model in which the photon energy density is neglected ceases to be a good approximation to the universe at the decoupling epoch. Therefore we first have to obtain spherically symmetric background universe models with radiation and dust, in which the radial profiles of radiation and dust are different. Then we need to perform cosmological perturbation analyses of these models in order to make theoretical predictions. This is an issue well beyond the scope of this paper. We just mention that there have been some advancements in this direction recently [37, 28].

#### 4. Summary and Discussion

In this paper, we have discussed the kSZ effect in an LTB universe model whose distance-redshift relation observed at the center agrees with the concordance  $\Lambda\text{CDM}$  model at redshift  $z \lesssim 2$ . Since the LTB universe model is spherically symmetric, it is natural to assume that physical quantities at the decoupling epoch are functions of the radial coordinate. We have assumed the decoupling between baryons and photon occurs instantaneously, or in other words, it occurs on a single spacelike hypersurface. To determine this decoupling hypersurface we have adopted Gamow's criterion,  $H = \Gamma$ , for simplicity, where  $H$  is the Hubble parameter and  $\Gamma$  is the rate of collisions between photons and electrons. However, this criterion is not sufficient to determine the decoupling hypersurface. Instead, we

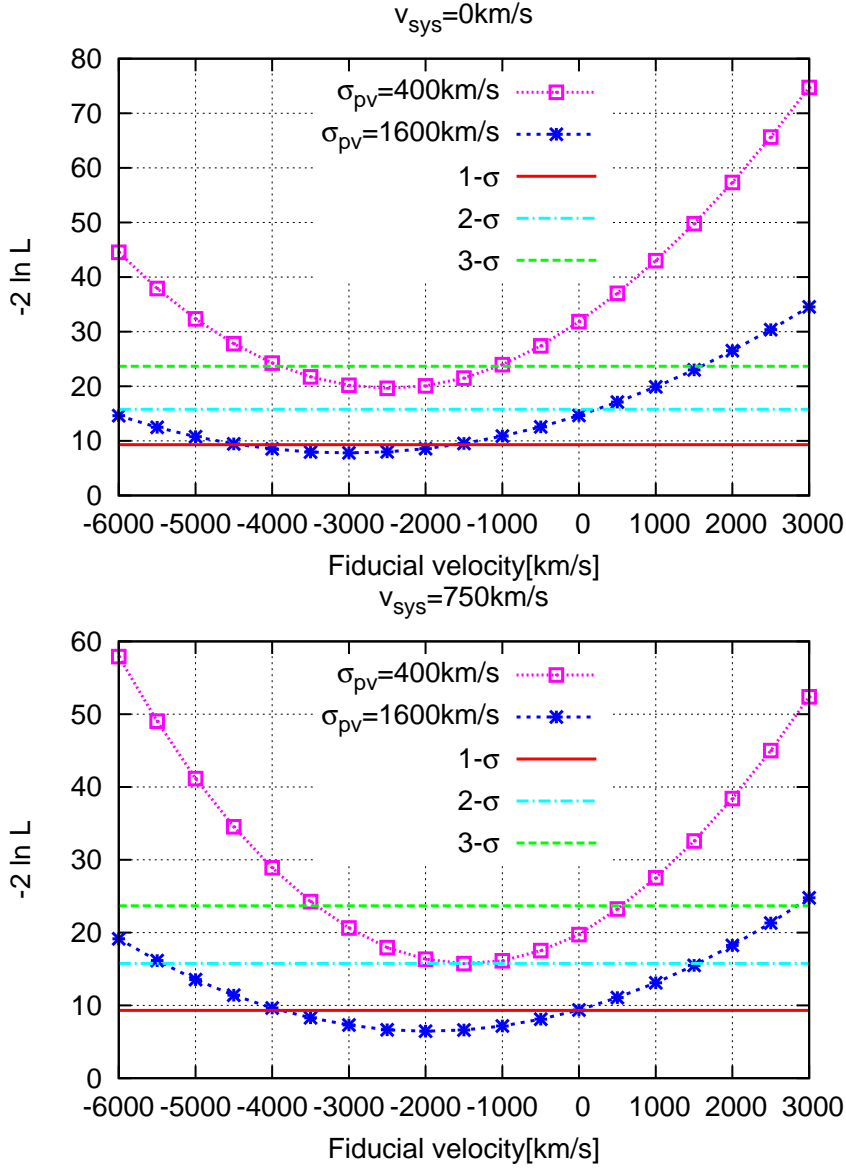
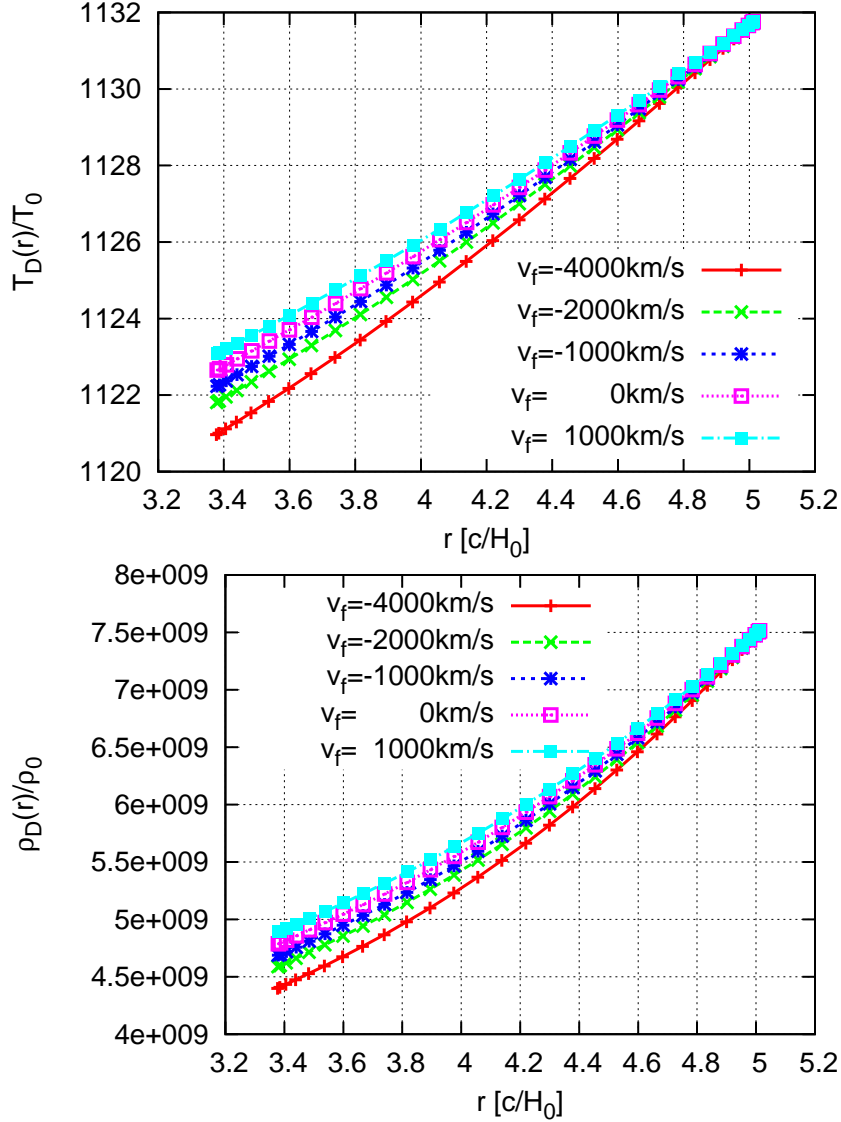

**Figure 7:** Log-likelihoods for  $(\sigma_{\text{pv}}, v_{\text{sys}}) = (400, 0)$ ,  $(400, 750)$ ,  $(1600, 0)$  and  $(1600, 750)$ .

have found that we need two more conditions for the physical quantities (the energy densities of dark matter, baryons and photons, the temperature of photon) on the decoupling hypersurface.

In §3.1, we have assumed the adiabatic perturbation scenario, namely we have fixed the ratios between two of any physical quantities (e.g., baryon-to-photon ratio) to be constant on the decoupling hypersurface. Then, it turned out that the CMB dipole anisotropy in each cluster rest frame is much larger than the observational data deduced from the kSZ effect. Therefore we conclude that our LTB universe model in the context of the conventional adiabatic perturbation scenario is ruled out.





**Figure 8:**  $r$ -dependence of  $T_D(r)$  and  $\rho_D(r)$ .

Then in §3.2, we have introduced radial non-adiabatic (isocurvature) inhomogeneities in the non-relativistic matter on the decoupling hypersurface. We assumed that the baryon-to-photon ratio is constant on the decoupling hypersurface. Then, we have shown that appropriate spatial distributions of isocurvature inhomogeneities can improve the consistency with observational results. It should be noted that we have introduced only a radial inhomogeneity. Hence it does not contribute directly to the CMB temperature anisotropy observed at the center. Actually, we may have a much larger value of the likelihood than the result in [17]. Thus, at present, the LTB universe model has not yet been ruled out completely by the observation of the kSZ effect. However, we must be cautioned by the fact that the necessary magnitude of isocurvature inhomogeneities is so large that our simple

LTB universe model that neglects the photon energy density ceases to be a good approximation to the universe at the decoupling. Therefore our result should be taken not as evidence but as an indication that the presence of large isocurvature perturbations may save the LTB universe model.

Finally, we mention that the possibility to consider the off-center observer in LTB universe models. In [11], Alnes and Amarzguioui claimed that the observer has to be located within a radius of 15Mpc from the center for the induced dipole to be less than that observed by the COBE satellite. Kodama et al. also reported similar constraints on several LTB models [26]. However, as shown in §3.2, it is possible to make an off-center observer in an LTB universe see a vanishing dipole anisotropy if we turn on radial isocurvature inhomogeneities at the decoupling epoch. It may be also interesting to investigate the relation of the kSZ effect in LTB universe models to the large scale coherent bulk flow reported by Kashlinsky et al. [38, 39, 40].

## Acknowledgments

C.Y. would like to thank the organizers and all the participants of the workshop LLTB2009 in KEK Tsukuba, Japan, for helpful comments. We would also like to thank all the participants of the Long-term Workshop on Gravity and Cosmology (GC2010: YITP-T-10-01) for fruitful discussions. In particular, we thank Dmitry Gorbunov and Valery Rubakov for an enlightening explanation of the decoupling process. C.Y. acknowledges the Korea Ministry of Education, Science and Technology (MEST) for the support of the Young Scientist Training Program at the Asia Pacific Center for Theoretical Physics (APCTP). This work was also supported in part by Korea Institute for Advanced Study under the KIAS Scholar program, by the Grant-in-Aid for the Global COE Program “The Next Generation of Physics, Spun from Universality and Emergence” from the Ministry of Education, Culture, Sports, Science and Technology (MEXT) of Japan, by Grant-in-Aid for Scientific Research (C), No. 21540276 from the Ministry of Education, Science, Sports and Culture, by JSPS Grant-in-Aid for Scientific Research (A) No. 21244033, and by JSPS Grant-in-Aid for Creative Scientific Research No. 19GS0219.

## References

- [1] I. Zehavi, A. G. Riess, R. P. Kirshner, and A. Dekel, *A Local Hubble Bubble from SNe Ia?*, *Astrophys. J.* **503** (1998) 483, [[astro-ph/9802252](#)].
- [2] K. Tomita, *Distances and lensing in cosmological void models*, *Astrophys. J.* **529** (2000) 38, [[astro-ph/9906027](#)].
- [3] K. Tomita, *A Local Void and the Accelerating Universe*, *Mon. Not. Roy. Astron. Soc.* **326** (2001) 287, [[astro-ph/0011484](#)].
- [4] K. Tomita, *Analyses of Type Ia Supernova Data in Cosmological Models with a Local Void*, *Prog. Theor. Phys.* **106** (2001) 929–939, [[astro-ph/0104141](#)].
- [5] M.-N. Celerier, *Do we really see a cosmological constant in the supernovae data ?*, *Astron. Astrophys.* **353** (2000) 63–71, [[astro-ph/9907206](#)].

- [6] N. Mustapha, C. Hellaby, and G. F. R. Ellis, *Large scale inhomogeneity versus source evolution: Can we distinguish them observationally?*, *Mon. Not. Roy. Astron. Soc.* **292** (1997) 817–830, [gr-qc/9808079].
- [7] H. Iguchi, T. Nakamura, and K.-i. Nakao, *Is dark energy the only solution to the apparent acceleration of the present universe?*, *Prog. Theor. Phys.* **108** (2002) 809–818, [astro-ph/0112419].
- [8] C.-M. Yoo, T. Kai, and K.-i. Nakao, *Solving Inverse Problem with Inhomogeneous Universe*, *Prog. Theor. Phys.* **120** (2008) 937–960, [arXiv:0807.0932].
- [9] M.-N. Celerier, K. Bolejko, A. Krasinski, and C. Hellaby, *A (giant) void is not mandatory to explain away dark energy with a Lemaitre – Tolman model*, arXiv:0906.0905.
- [10] E. W. Kolb and C. R. Lamb, *Light-cone observations and cosmological models: implications for inhomogeneous models mimicking dark energy*, arXiv:0911.3852.
- [11] H. Alnes and M. Amarzguioui, *CMB anisotropies seen by an off-center observer in a spherically symmetric inhomogeneous universe*, *Phys. Rev.* **D74** (2006) 103520, [astro-ph/0607334].
- [12] H. Alnes, M. Amarzguioui, and O. Gron, *An inhomogeneous alternative to dark energy?*, *Phys. Rev.* **D73** (2006) 083519, [astro-ph/0512006].
- [13] S. Alexander, T. Biswas, A. Notari, and D. Vaid, *Local Void vs Dark Energy: Confrontation with WMAP and Type Ia Supernovae*, *JCAP* **0909** (2009) 025, [arXiv:0712.0370].
- [14] K. Bolejko and J. S. B. Wyithe, *Testing the Copernican Principle via Cosmological Observations*, *JCAP* **0902** (2009) 020, [arXiv:0807.2891].
- [15] C. A. Clarkson and R. Barrett, *Does the Isotropy of the CMB Imply a Homogeneous Universe? Some Generalised EGS Theorems*, *Class. Quant. Grav.* **16** (1999) 3781–3794, [gr-qc/9906097].
- [16] R. R. Caldwell and A. Stebbins, *A Test of the Copernican Principle*, *Phys. Rev. Lett.* **100** (2008) 191302, [arXiv:0711.3459].
- [17] J. Garcia-Bellido and T. Haugboelle, *Looking the void in the eyes - the kSZ effect in LTB models*, *JCAP* **0809** (2008) 016, [arXiv:0807.1326].
- [18] J. Garcia-Bellido and T. Haugboelle, *Confronting Lemaitre-Tolman-Bondi models with Observational Cosmology*, *JCAP* **0804** (2008) 003, [arXiv:0802.1523].
- [19] J. Garcia-Bellido and T. Haugboelle, *The radial BAO scale and Cosmic Shear, a new observable for Inhomogeneous Cosmologies*, *JCAP* **0909** (2009) 028, [arXiv:0810.4939].
- [20] J. Goodman, *Geocentrism reexamined*, *Phys. Rev.* **D52** (1995) 1821–1827, [astro-ph/9506068].
- [21] W. Godlowski, J. Stelmach, and M. Szydlowski, *Can the Stephani model be an alternative to FRW accelerating models?*, *Class. Quant. Grav.* **21** (2004) 3953–3972, [astro-ph/0403534].
- [22] J. P. Zibin, *Scalar Perturbations on Lemaitre-Tolman-Bondi Spacetimes*, (2008) [arXiv:0804.1787].
- [23] J. P. Zibin, A. Moss, and D. Scott, *Can we avoid dark energy?*, *Phys. Rev. Lett.* **101** (2008) 251303, [arXiv:0809.3761].

- [24] T. Clifton, P. G. Ferreira, and J. Zuntz, *What the small angle CMB really tells us about the curvature of the Universe*, *JCAP* **0907** (2009) 029, [[arXiv:0902.1313](#)].
- [25] M. Regis and C. Clarkson, *Do primordial Lithium abundances imply there's no Dark Energy?*, [arXiv:1003.1043](#).
- [26] H. Kodama, K. Saito, and A. Ishibashi, *Analytic formulae for the off-center CMB anisotropy in a general spherically symmetric universe*, [arXiv:1004.3089](#).
- [27] D. Garfinkle, *The motion of galaxy clusters in inhomogeneous cosmologies*, *Class. Quant. Grav.* **27** (2010) 065002, [[arXiv:0908.4102](#)].
- [28] C. Clarkson and M. Regis, *The Cosmic Microwave Background in an Inhomogeneous Universe*, [arXiv:1007.3443](#).
- [29] A. Moss, J. P. Zibin, and D. Scott, *Precision Cosmology Defeats Void Models for Acceleration*, [arXiv:1007.3725](#).
- [30] T. Biswas, A. Notari, and W. Valkenburg, *Testing the Void against Cosmological data: fitting CMB, BAO, SN and  $H_0$* , [arXiv:1007.3065](#).
- [31] C.-M. Yoo, K.-i. Nakao, and M. Sasaki, *CMB observations in LTB universes: Part I: Matching peak positions in the CMB spectrum*, [arXiv:1005.0048](#).
- [32] M. Tanimoto and Y. Nambu, *Luminosity distance-redshift relation for the LTB solution near the center*, *Class. Quant. Grav.* **24** (2007) 3843–3857, [[gr-qc/0703012](#)].
- [33] S. Weinberg, *Cosmology*, . Oxford, UK: Oxford Univ. Pr. (2008) 593 p.
- [34] W. L. Holzapfel *et. al.*, *Limits on the Peculiar Velocities of Two Distant Clusters Using the Kinematic Sunyaev-Zel'dovich Effect*, *Astrophys. J.* **481** (1997) 35–48, [[astro-ph/9702223](#)].
- [35] B. A. Benson *et. al.*, *Peculiar Velocity Limits from Measurements of the Spectrum of the Sunyaev-Zel'dovich Effect in Six Clusters of Galaxies*, *Astrophys. J.* **592** (2003) 674–691, [[astro-ph/0303510](#)].
- [36] T. Kitayama *et. al.*, *Exploring Cluster Physics with High-resolution Sunyaev- Zel'dovich Effect Images and X-ray Data: A Case of the Most X-ray Luminous Galaxy Cluster RXJ1347-1145*, *Publ. Astron. Soc. Jap.* **56** (2004) 17–28, [[astro-ph/0311574](#)].
- [37] C. Clarkson and R. Maartens, *Inhomogeneity and the foundations of concordance cosmology*, *Class. Quant. Grav.* **27** (2010) 124008, [[arXiv:1005.2165](#)].
- [38] A. Kashlinsky, F. Atrio-Barandela, H. Ebeling, A. Edge, and D. Kocevski, *A new measurement of the bulk flow of X-ray luminous clusters of galaxies*, *Astrophys. J.* **712** (2010) L81–L85, [[arXiv:0910.4958](#)].
- [39] A. Kashlinsky, F. Atrio-Barandela, D. Kocevski, and H. Ebeling, *A measurement of large-scale peculiar velocities of clusters of galaxies: results and cosmological implications*, *Astrophys. J.* **686** (2008) L49–L52, [[arXiv:0809.3734](#)].
- [40] A. Kashlinsky, F. Atrio-Barandela, D. Kocevski, and H. Ebeling, *A measurement of large-scale peculiar velocities of clusters of galaxies: technical details*, *Astrophys. J.* **691** (2009) 1479–1493, [[arXiv:0809.3733](#)].