

Berge-Fulkerson coloring for infinite families of snarks

Ting Zheng, Rong-Xia Hao*

Department of Mathematics, Beijing Jiaotong University,
Beijing, 100044, P.R.China

March 12, 2022

Abstract

It is conjectured by Berge and Fulkerson that *every bridgeless cubic graph has six perfect matchings such that each edge is contained in exactly two of them*. Hägglund constructed two graphs $\text{Blowup}(K_4, C)$ and $\text{Blowup}(\text{Prism}, C_4)$. Based on these two graphs, Chen constructed infinite families of bridgeless cubic graphs $M_{0,1,2,\dots,k-2,k-1}$ which is obtained from cyclically 4-edge-connected and having a Fulkerson-cover cubic graphs G_0, G_1, \dots, G_{k-1} by recursive process. If each G_i for $1 \leq i \leq k-1$ is a cyclically 4-edge-connected snarks with excessive index at least 5, Chen proved that these infinite families are snarks. He obtained that each graph in $M_{0,1,2,3}$ has a Fulkerson-cover and gave the open problem that whether every graph in $M_{0,1,2,\dots,k-2,k-1}$ has a Fulkerson-cover. In this paper, we solve this problem and prove that every graph in $M_{0,1,2,\dots,k-2,k-1}$ has a Fulkerson-cover.

Keyword: Berge-Fulkerson conjecture, Fulkerson-cover, perfect matching.

MSC(2010): Primary: 05C70; Secondary: 05C75, 05C40, 05C15.

1 Introduction

Let G be a simple graph with vertex set $V(G)$ and edge set $E(G)$. A *circuit* of G is a 2-regular connected subgraph. An *even graph* is a graph with even degree at every vertex. A perfect matching of G is a 1-regular spanning subgraph of G . The excessive index of G , denoted by $\chi'_e(G)$, is the least integer k , such that G can be covered by k perfect matchings. A cubic graph is a *snark* if it is bridgeless and not 3-edge-colorable. A cubic graph G is *Berge-Fulkerson colorable* if $2G$ is 6-edge-colorable. It is an equivalent description of the Berge-Fulkerson conjecture.

The following is a famous open problem called Berge-Fulkerson conjecture.

*Corresponding author, rxhao@bjtu.edu.cn

Conjecture 1.1. (Berge-Fulkerson Conjecture [4], or see [10]) *Every bridgeless cubic graph has six perfect matchings such that each edge belongs to exactly two of them.*

Although there are some results related with this conjecture, as examples, see [2],[5], [7],[9],[8], Berge-Fulkerson conjecture is still open for many bridgeless cubic graphs even for some simple snarks.

Häggglund [7] constructed two graphs $\text{Blowup}(K_4, C)$ and $\text{Blowup}(\text{Prism}, C_4)$. Based on $\text{Blowup}(K_4, C)$, Esperet et al. [3] constructed infinite families of cyclically 4-edge-connected snarks with excessive index at least five. Based on these two graphs, Chen [1] constructed infinite families of cyclically 4-edge-connected snarks $E_{0,1,2,\dots,(k-1)}$ obtained from cyclically 4-edge-connected snarks G_0, G_1, \dots, G_{k-1} , in which $E_{0,1,2}$ is Esperet et al.' construction. If only assume that each graph in $\{G_0, G_1, \dots, G_{k-1}\}$ has a Fulkerson-cover, then these infinite families of bridgeless cubic graphs are denoted by $M_{0,1,2,\dots,k-2,k-1}$. Chen [1] obtained that every graph in $M_{0,1}$ has a Fulkerson-cover and each graph in $M_{0,1,2,3}$ has a Fulkerson-cover and gave the following problem.

Problem 1.2. [1] *If $H = \{G; G_0, G_1, \dots, G_{k-2}, G_{k-1}\} \in M_{0,1,2,\dots,k-2,k-1}$, Does H have a Fulkerson-cover?*

In this paper, we solve Problem 1.2. The main result is Theorem 1.3.

Theorem 1.3. *Each graph in $M_{0,1,2,\dots,k-2,k-1}$ for $k > 2$ has a Fulkerson-cover.*

2 Preliminaries

In this section, some necessary definitions, constructions and Lemma are given.

Let $X \subseteq V(G)$ and $Y \subseteq E(G)$. We use $G \setminus X$ to denote the subgraph of G obtained from G by deleting all the vertices of X and all the edges incident with X . While $G \setminus Y$ to denote the subgraph of G obtained from G by deleting all the edges of Y . The edge-cut of G associated with X , denoted by $\partial_G(X)$, is the set of edges of G with exactly one end in X . The edge set $C = \partial_G(X)$ is called a k -edge-cut if $|\partial_G(X)| = k$. A cycle of G is a subgraph of G with each vertex of even degree. A circuit of G is a minimal 2-regular cycle of G . A graph G is called cyclically k -edge-connected if at least k edges must be removed to disconnect it into two components, each of which contains a circuit.

Let G_i be a cyclically 4-edge-connected snark with excessive index at least 5, for $i = 0, 1$. Let $x_i y_i$ be an edge of G_i and $x_i^0, x_i^1 (y_i^0, y_i^1)$ be the neighbours of $x_i (y_i)$. Let H_i be the graph obtained from G_i by deleting the vertices x_i and y_i . Let $\{G; G_0, G_1\}$ be the graph obtained from the disjoint union of H_0, H_1 by adding six vertices $a_0, b_0, c_0, a_1, b_1, c_1$ and

13 edges $a_0y_0^0, a_0x_1^0, a_0c_0, c_0b_0, b_0y_0^1, b_0x_1^1, b_1x_0^1, b_1y_1^1, b_1c_1, c_1a_1, a_1x_0^0, a_1y_1^0, c_0c_1$. The graphs of this type are denoted as $E_{0,1}$ (see Figure 1).

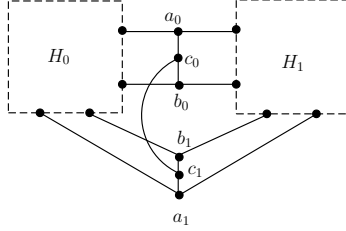

Figure 1: $\{G; G_0, G_1\}$

The family of graphs $E_{0,1,\dots,(k-1)}$ ($k \geq 2$) and $M_{0,1,\dots,(k-1)}$ ($k \geq 2$) are constructed by Chen as follows:

- (1) $\{G; G_0, G_1\} \in E_{0,1}$ with $A_j = \{a_j, b_j, c_j\}$ for $j = 0, 1$.
- (2) For $3 \leq i \leq k$, $\{G; G_0, G_1, \dots, G_{i-1}\}$ is obtained from $\{G; G_0, G_1, \dots, G_{i-2}\} \in E_{0,1,\dots,(i-2)}$ by adding H_{i-1} and $A_{i-1} = \{a_{i-1}, b_{i-1}, c_{i-1}\}$ and by inserting a vertex v_{i-3} into e_0 , such that
 - (i) G_{i-1} is a cyclically 4-edge-connected snark with excessive index at least 5 ($x_{i-1}y_{i-1}$ is an edge of G_{i-1} and x_{i-1}^0, x_{i-1}^1 (y_{i-1}^0, y_{i-1}^1) are the neighbours of x_{i-1} (y_{i-1}));
 - (ii) $H_{i-1} = G_{i-1} \setminus \{x_{i-1}, y_{i-1}\}$;
 - (iii) $e_0 \in E(\{G; G_0, G_1, \dots, G_{i-2}\}) - \bigcup_{j=0}^{i-2} E(H_j) - \bigcup_{j=0}^{i-2} \{a_jc_j, c_jb_j\}$ and e_0 is incident with c_0 ;
 - (iv) a_{i-1} is adjacent to x_0^0 and y_{i-1}^0 , b_{i-1} is adjacent to x_0^1 and y_{i-1}^1 , a_{i-2} is adjacent to x_{i-1}^0 and y_{i-2}^0 , b_{i-2} is adjacent to x_{i-1}^1 and y_{i-2}^1 , c_{i-1} is adjacent to a_{i-1}, b_{i-1} and v_{i-3} , the other edges of $\{G; G_0, G_1, \dots, G_{i-2}\}$ remain the same;
 - (v) $\{G; G_0, G_1, \dots, G_{i-1}\} \in E_{0,1,\dots,(i-1)}$.

The class of graphs constructed by Esperet et al. is a special case for $k = 3$ of $E_{0,1,\dots,(k-1)}$. If the excessive index and non 3-edge-colorability of G_i ($i = 0, 1, 2, \dots, (k-1)$) is ignored and only assume that G_i has a Fulkerson-cover, then we obtain infinite families of bridgeless cubic graphs. We denote graphs of this type as $M_{0,1,2,\dots,(k-1)}$ ($k \geq 2$).

The following Lemma is very import in our main proofs.

Lemma 2.1. (Hao, Niu, Wang, Zhang and Zhang [6]) *A bridgeless cubic graph G has a Fulkerson-cover if and only if there are two disjoint matchings E_0 and E_2 , such that $E_0 \cup E_2$ is a cycle and $\overline{G \setminus E_i}$ is 3-edge colorable, for each $i = 0, 2$.*

3 Each graph in $M_{0,1,2,\dots,k-2,k-1}$ has a Fulkerson cover

We give the results according to the parity of k .

Theorem 3.1. *Let k be an even integer and $k \geq 4$. If $\Gamma \in M_{0,1,2,\dots,k-2,k-1}$, then Γ has a Fulkerson-cover.*

Proof. Since $\Gamma \in M_{0,1,2,\dots,k-2,k-1}$, assume $\Gamma = \{G; G_0, G_1, \dots, G_{k-2}, G_{k-1}\}$.

Since G_i has a Fulkerson-cover, for each $i = 0, 1, \dots, k-1$, suppose that $\{M_i^1, M_i^2, M_i^3, M_i^4, M_i^5, M_i^6\}$ is the Fulkerson-cover of G_i . Let E_i^2 be the set of edges in G_i covered twice by $\{M_i^1, M_i^2, M_i^3\}$ and E_i^0 be the set of edges in G_i which are not covered by $\{M_i^1, M_i^2, M_i^3\}$. Note that $E_i^2 \cup E_i^0$ is an even cycle, and $\overline{G_i \setminus E_i^2}$ and $\overline{G_i \setminus E_i^0}$ can be colored by three colors. Then E_i^2 and E_i^0 are the desired disjoint matchings of G_i as in Lemma 2.1. By choosing three perfect matchings of G_i , for each $i = 0, 1, \dots, k-1$, we can obtain two desired disjoint matchings E_i^2 and E_i^0 such that $x_i y_i \in E_i^2 \cup E_i^0$ or $x_i, y_i \notin V(E_i^2 \cup E_i^0)$.

Three perfect matchings $\{M_i^1, M_i^2, M_i^3\}$ of G_i are chosen such that $x_i, y_i \notin V(E_i^2 \cup E_i^0)$ if i is even; And three perfect matchings $\{M_i^1, M_i^2, M_i^3\}$ of G_i are chosen such that $x_i y_i \in E_i^2 \cup E_i^0$ if i is odd. Without loss of generality, assume that $x_i y_i \in E_i^2$ and $x_i^0 x_i, y_i^0 y_i \in E_i^0$ for odd i .

Let

$$E_0 = (E_0^2 - x_0 y_0) \cup (E_1^0 - \{x_1^0 x_1, y_1^0 y_1\}) \cup \bigcup_{i=2}^{k-1} (E_i^2 - x_i y_i) \cup \bigcup_{i=2}^{k-1} a_i c_i \\ \cup \bigcup_{j=1}^{\frac{k-4}{2}} v_{2j-1} v_{2j} \cup \{c_0 v_{k-3}, c_1 v_0, y_1^0 a_1, x_1^0 a_0\}$$

and

$$E_2 = (E_0^0 - \{x_0 x_0^0, y_0 y_0^0\}) \cup (E_1^2 - x_1 y_1) \cup \bigcup_{i=2}^{k-1} (E_i^0 - \{x_i x_i^0, y_i y_i^0\}) \\ \cup \bigcup_{j=1}^{\frac{k-2}{2}} \{y_{2j+1}^0 a_{2j+1}, x_{2j+1}^0 a_{2j}\} \cup \bigcup_{i=2}^{k-1} v_{i-2} c_i \cup \{a_0 c_0, a_1 c_1\}.$$

Clearly, $E_0 \cup E_2$ is an even cycle C . (See Figure 2.)

If i is odd, by $x_i y_i \in E_i^2$, there exists a maximal path containing only 2-degree vertices as inter vertices in the graph $G_i \setminus E_i^0$, say $u_i^0 \dots y_i x_i \dots u_i^1$, which corresponds to an edge $u_i^0 u_i^1$ in the graph $\overline{G_i \setminus E_i^0}$ (see Figure 3). From $x_i^0 x_i, y_i^0 y_i \in E_i^0$, there exists two maximal paths containing only 2-degree vertices as inter vertices in the graph $G_i \setminus E_i^2$, say $u_i^2 \dots x_i^0 x_i x_i^1 \dots u_i^3$ and $u_i^5 \dots y_i^0 y_i y_i^1 \dots u_i^4$, which corresponds to an edge $u_i^2 u_i^3$ and $u_i^4 u_i^5$, respectively, in the graph $\overline{G_i \setminus E_i^2}$ (see Figure 4).

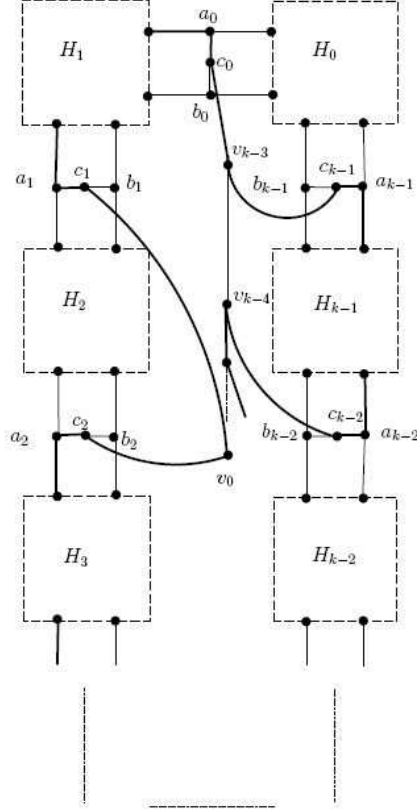

Figure 2: $\{G; G_0, G_1, \dots, G_{k-1}\}$

If i is even, by $x_i, y_i \notin V(E_i^2)$, there exist four maximal paths containing only 2-degree vertices as inter vertices in the graph $G_i \setminus E_i^2$, say $u_i^0 \dots x_i^1 x_i$ (maybe $u_i^0 = x_i^1$), $u_i^1 \dots x_i^0 x_i$ (maybe $u_i^1 = x_i^0$), $u_i^2 \dots y_i^1 y_i$ (maybe $u_i^2 = y_i^1$) and $u_i^3 \dots y_i^0 y_i$, which correspond to four edges $u_i^0 x_i$, $u_i^1 x_i$, $u_i^2 y_i$ and $u_i^3 y_i$, respectively, in the graph $\overline{G_i \setminus E_i^2}$ (see Figure 5).

Similarly, by $x_i, y_i \notin V(E_i^0)$, there exist four maximal paths containing only 2-degree vertices as inter vertices in the graph $G_i \setminus E_i^0$, say $u_i^4 \dots x_i^1 x_i$ (maybe $u_i^4 = x_i^1$), $u_i^5 \dots x_i^0 x_i$ (maybe $u_i^5 = x_i^0$), $u_i^6 \dots y_i^1 y_i$ (maybe $u_i^6 = y_i^1$) and $u_i^7 \dots y_i^0 y_i$ (maybe $u_i^7 = y_i^0$), which correspond to four edges $u_i^4 x_i$, $u_i^5 x_i$, $u_i^6 y_i$ and $u_i^7 y_i$, respectively, in $\overline{G_i \setminus E_i^0}$ (see Figure 6).

From the construction of Γ , we know that $\overline{\Gamma \setminus E_0}$ (see Figure 7) is

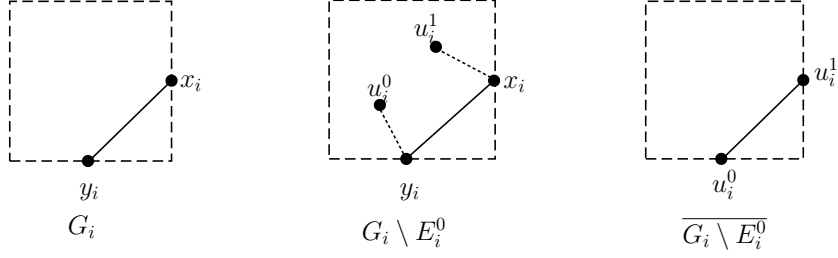

Figure 3

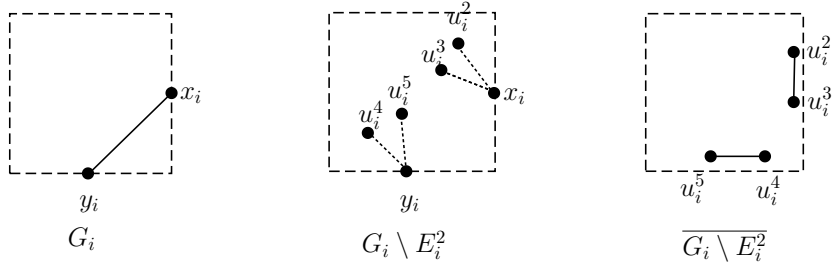

Figure 4

$$\begin{aligned}
& \overline{(G_1 \setminus E_1^0 - u_1^0 u_1^1)} \cup \bigcup_{j=0}^{\frac{k-2}{2}} \overline{(G_{2j} \setminus E_{2j}^2 - \{x_{2j}, y_{2j}\})} \\
& \cup \bigcup_{j=1}^{\frac{k-2}{2}} \overline{(G_{2j+1} \setminus E_{2j+1}^2 - \{u_{2j+1}^2 u_{2j+1}^3, u_{2j+1}^4 u_{2j+1}^5\})} \cup \{u_1^0 b_1, u_1^1 b_0, b_1 u_2^0, b_1 u_2^1, u_0^2 b_0, u_0^3 b_0\} \\
& \cup \bigcup_{j=1}^{\frac{k-2}{2}} \{u_{2j}^3 u_{2j+1}^2, u_{2j}^2 b_{2j}, u_{2j+1}^3 b_{2j}, u_{2j+1}^5 u_{2j+2}^1, u_{2j+1}^4 b_{2j+1}, u_{2j+2}^0 b_{2j+1}, b_{2j} b_{2j+1}\}
\end{aligned}$$

and $\overline{\Gamma \setminus E_2}$ (see Figure 7) is

$$\begin{aligned}
& \overline{(G_1 \setminus E_1^2 - \{u_1^2 u_1^3, u_1^4 u_1^5\})} \cup \bigcup_{j=0}^{\frac{k-2}{2}} \overline{(G_{2j} \setminus E_{2j}^0 - \{x_{2j}, y_{2j}\})} \\
& \cup \bigcup_{j=1}^{\frac{k-2}{2}} \overline{(G_{2j+1} \setminus E_{2j+1}^0 - u_{2j+1}^0 u_{2j+1}^1)} \\
& \cup \{u_1^4 b_1, u_1^5 u_2^5, b_1 u_2^4, u_1^3 b_0, u_0^7 u_1^2, u_0^6 b_0, b_0 b_1\} \\
& \cup \bigcup_{j=1}^{\frac{k-2}{2}} \{u_{2j}^6 b_{2j}, u_{2j}^7 b_{2j}, b_{2j} u_{2j+1}^1, u_{2j+1}^0 b_{2j+1}, b_{2j+1} u_{2j+2}^4, b_{2j+1} u_{2j+2}^5\}.
\end{aligned}$$

If i is odd, because E_i^2 and E_i^0 are the desired disjoint matchings of G_i as in Lemma 2.1, $\overline{G_i \setminus E_i^0}$ is 3-edge colorable. Thus there exists a 2-factor, say C_i^0 , such that each component

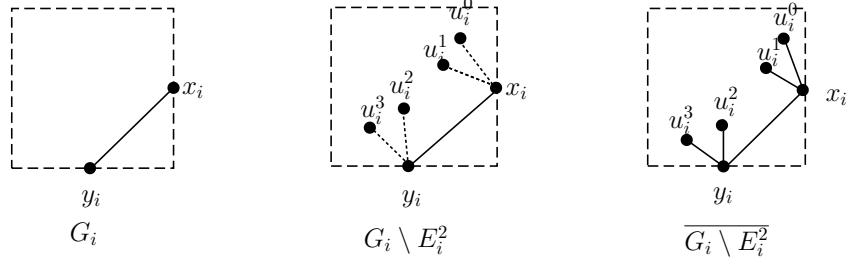

Figure 5

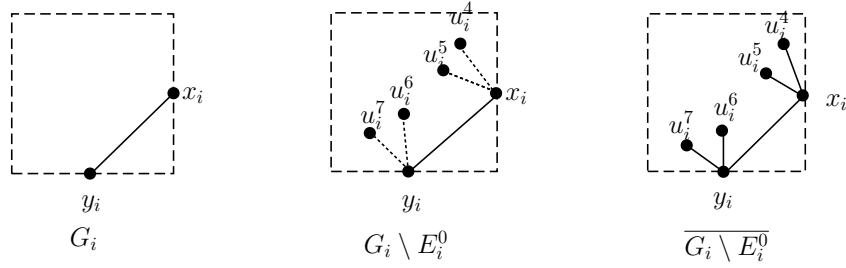

Figure 6

is an even circuit and $u_i^0 u_i^1$ is not in the 2-factor C_i^0 . Similarly, because $\overline{G_i \setminus E_i^2}$ is 3-edge colorable, there exists a 2-factor C_i^2 such that each component is an even circuit and $\{u_i^2 u_i^3, u_i^4 u_i^5\}$ is in the 2-factor C_i^2 .

If i is even, because $\overline{G_i \setminus E_i^2}$ is 3-edge colorable, there exists a 2-factor C_i^2 such that each component is an even circuit and $u_i^0 x_i u_i^1$ and $u_i^2 y_i u_i^3$ are in the 2-factor C_i^2 . Because $\overline{G_i \setminus E_i^0}$ is 3-edge colorable, there exists a 2-factor C_i^0 such that each component is an even circuit and $\{u_i^4 x_i u_i^5, u_i^6 y_i u_i^7\}$ is in the 2-factor C_i^0 .

Then $\overline{\Gamma \setminus E_0}$ has a 2-factor:

$$C_1^0 \cup \bigcup_{j=1}^{\frac{k-2}{2}} (C_{2j+1}^2 - \{u_{2j+1}^2 u_{2j+1}^3, u_{2j+1}^4 u_{2j+1}^5\}) \cup \bigcup_{j=0}^{\frac{k-2}{2}} (C_{2j}^2 - \{x_{2j}, y_{2j}\}) \cup \{b_0 u_0^3, b_0 u_0^2, b_1 u_2^0, b_1 u_2^1\} \cup \bigcup_{j=1}^{\frac{k-2}{2}} \{b_{2j} u_{2j+1}^3, b_{2j} u_{2j}^2, u_{2j}^3 u_{2j+1}^2, b_{2j+1} u_{2j+1}^4, b_{2j+1} u_{2j+2}^0, u_{2j+1}^5 u_{2j+2}^1\}.$$

And each component is an even circuit.

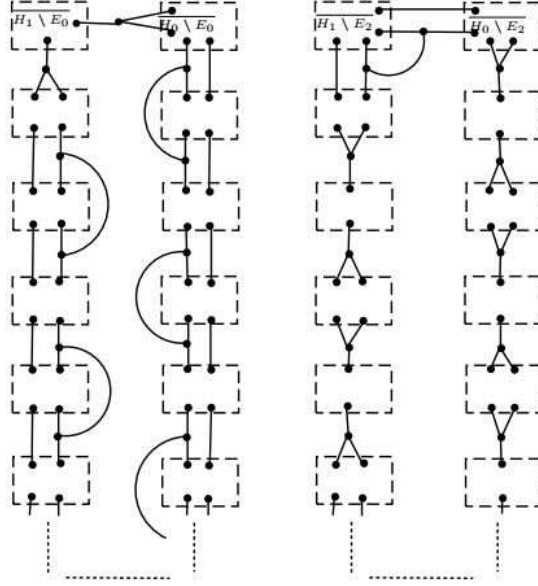

Figure 7: $\overline{\{G; G_0, G_1, \dots, G_{k-1}\} \setminus E_0}$ and $\overline{\{G; G_0, G_1, \dots, G_{k-1}\} \setminus E_2}$

And $\overline{\Gamma \setminus E_2}$ has a 2-factor:

$$\begin{aligned} & \bigcup_{j=1}^{\frac{k-2}{2}} C_{2j+1}^0 \cup (C_1^2 - \{u_1^2 u_1^3, u_1^4 u_1^5\}) \cup \bigcup_{j=0}^{\frac{k-2}{2}} (C_{2j}^0 - \{x_{2j}, y_{2j}\}) \cup \{b_0 u_0^6, b_0 u_1^3, u_0^7 u_1^2, \\ & b_1 u_1^4, u_1^5 u_2^5, b_1 u_2^4\} \cup \bigcup_{j=1}^{\frac{k-2}{2}} \{u_{2j}^6 b_{2j}, u_{2j}^7 b_{2j}, u_{2j+2}^4 b_{2j+1}, u_{2j+2}^5 b_{2j+1}\}. \end{aligned}$$

And each component is an even circuit.

So $\overline{\Gamma \setminus E_0}$ and $\overline{\Gamma \setminus E_2}$ are 3-edge colorable. Therefore E_0 and E_2 are the desired matchings in Γ of Lemma 2.1. So $\Gamma = \{G; G_0, G_1, \dots, G_{k-2}, G_{k-1}\}$ has a Fulkerson-cover. \square

Theorem 3.2. *Let k be an odd integer. If $H \in M_{0,1,2,\dots,k-2,k-1}$, then H has a Fulkerson-cover.*

Proof. By $H \in M_{0,1,2,\dots,k-2,k-1}$, assume $H = \{G; G_0, G_1, \dots, G_{k-2}, G_{k-1}\}$. Since G_i has a Fulkerson-cover, for each $i = 0, 1, \dots, k-1$, suppose that $\{M_i^1, M_i^2, M_i^3, M_i^4, M_i^5, M_i^6\}$ is the Fulkerson-cover of G_i . Let E_i^2 be the set of edges covered twice by $\{M_i^1, M_i^2, M_i^3\}$ and E_i^0 be the set of edges not covered by $\{M_i^1, M_i^2, M_i^3\}$. Now $E_i^2 \cup E_i^0$ is an even cycle, and $\overline{G_i \setminus E_i^2}$ and $\overline{G_i \setminus E_i^0}$ can be colored by three colors. Then E_i^2 and E_i^0 are the desired disjoint matchings of G_i as in Lemma 2.1. By choosing three perfect matchings of G_i , for each $i = 0, 1, \dots, k-1$, we can obtain two desired disjoint matchings E_i^2 and E_i^0 such that $x_i y_i \in E_i^2 \cup E_i^0$ or $x_i, y_i \notin V(E_i^2 \cup E_i^0)$. If i is even and $i \neq 0$, three perfect matchings of G_i

are chosen such that $x_i, y_i \notin V(E_i^2 \cup E_i^0)$. If i is odd or $i = 0$, three perfect matchings of G_i are chosen such that $x_i y_i \in E_i^2 \cup E_i^0$. Without loss of generality, assume that $x_i y_i \in E_i^2$ and $x_i^0 x_i, y_i^0 y_i \in E_i^0$ for $i = 0$ or i is odd.

Let

$$E_0 = (E_0^2 - x_0 y_0) \cup (E_1^0 - \{x_1^0 x_1, y_1^0 y_1\}) \cup \bigcup_{i=2}^{k-1} (E_i^2 - x_i y_i) \cup \{y_1^0 a_1, x_1^0 a_0, c_1 v_0\}$$

$$\cup \bigcup_{i=2}^{k-1} a_i c_i \cup \bigcup_{j=0}^{\frac{k-5}{2}} v_{2j+1} v_{2j+2}$$

and

$$E_2 = (E_1^2 - x_1 y_1) \cup \bigcup_{i=2}^{k-1} (E_i^0 - \{x_i x_i^0, y_i y_i^0\}) \cup (E_0^0 - \{x_0 x_0^0, y_0 y_0^0\})$$

$$\cup \{a_1 c_1\} \cup \bigcup_{i=1}^{\frac{k-1}{2}} \{a_{2i} x_{2i+1}^0, a_{2i+1} y_{2i+1}^0\} \cup \bigcup_{i=2}^{k-1} \{v_{i-2} c_i\}.$$

(See Figure 8). Clearly, $E_0 \cup E_2$ is an even cycle C .

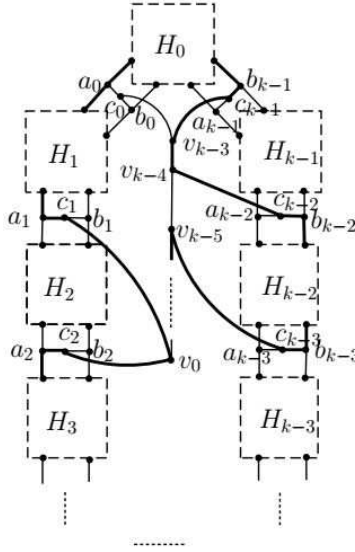

Figure 8: $\{G; G_0, G_1, \dots, G_{k-2}, G_{k-1}\}$

If i is odd or $i = 0$, by $x_i y_i \in E_i^2$, there exists a maximal path containing only 2-degree vertices as inter vertices in the graph $G_i \setminus E_i^0$, say $u_i^0 \dots y_i x_i \dots u_i^1$, which corresponds to an edge $u_i^0 u_i^1$ in the graph $\overline{G_i \setminus E_i^0}$ (see Figure 3); By $x_i^0 x_i, y_i^0 y_i \in E_i^0$, there exists two distinct maximal path containing only 2-degree vertices as inter vertices in the graph $G_i \setminus E_i^2$, say

$u_i^2 \dots x_i^0 x_i x_i^1 \dots u_i^3$ and $u_i^5 \dots y_i^0 y_i y_i^1 \dots u_i^4$ which correspond to the edges $u_i^2 u_i^3$ and $u_i^4 u_i^5$ respectively in the graph $\overline{G_i \setminus E_i^2}$ (see Figure 4).

If i is even and $i \neq 0$, since $x_i, y_i \notin V(E_i^2)$, there exist four maximal paths containing only 2-degree vertices as inter vertices in the graph $G_i \setminus E_i^2$, say $u_i^0 \dots x_i^1 x_i$ (maybe $u_i^0 = x_i^1$), $u_i^1 \dots x_i^0 x_i$ (maybe $u_i^1 = x_i^0$), $u_i^2 \dots y_i^1 y_i$ (maybe $u_i^2 = y_i^1$) and $u_i^3 \dots y_i^0 y_i$ (maybe $u_i^3 = y_i^0$), which correspond to the edges $u_i^0 x_i$, $u_i^1 x_i$, $u_i^2 y_i$ and $u_i^3 y_i$, respectively, in the graph $\overline{G_i \setminus E_i^2}$. (See Figure 5). Similarly, by $x_i, y_i \notin V(E_i^0)$, there exist four maximal paths containing only 2-degree vertices as inter vertices in the graph $G_i \setminus E_i^0$, say $u_i^4 \dots x_i^1 x_i$ (maybe $u_i^4 = x_i^1$), $u_i^5 \dots x_i^0 x_i$ (maybe $u_i^5 = x_i^0$), $u_i^6 \dots y_i^1 y_i$ (maybe $u_i^6 = y_i^1$) and $u_i^7 \dots y_i^0 y_i$ which correspond to the edges $u_i^4 x_i$, $u_i^5 x_i$, $u_i^6 y_i$ and $u_i^7 y_i$, respectively, in the graph $\overline{G_i \setminus E_i^0}$.

If $k = 1$, then $H = G_0$ which has a Fulkerson-cover.

If $k \geq 2$, we will prove $\overline{H \setminus E_0}$ and $\overline{H \setminus E_2}$ are 3-edge colorable in the following.

From the construction of H , one has that $\overline{H \setminus E_0}$ (see Figure 9) is

$$\begin{aligned} & (\overline{G_0 \setminus E_0^2} - \{u_0^2 u_0^3, u_0^4 u_0^5\}) \cup (\overline{G_1 \setminus E_1^0} - u_1^0 u_1^1) \cup Q_0 \cup Q_1 \cup \bigcup_{j=1}^{\frac{k-1}{2}} \{u_{2j}^2 b_{2j}, u_{2j+1}^3 b_{2j}, u_{2j+1}^2 u_{2j}^3\} \\ & \cup \bigcup_{j=1}^{\frac{k-3}{2}} \{u_{2j+1}^4 b_{2j+1}, u_{2j+1}^5 u_{2j+2}^1, u_{2j+2}^0 b_{2j+1}, b_{2j} b_{2j+1}\} \cup \{u_0^5 c_0, u_0^4 b_0, b_0 c_0, b_{k-1} c_0, u_1^1 b_0, u_1^0 b_1, u_2^0 b_1, u_2^1 b_1\}. \end{aligned}$$

Where, $Q_0 = \bigcup_{j=1}^{\frac{k-1}{2}} (\overline{G_{2j} \setminus E_{2j}^2} - \{x_{2j}, y_{2j}\})$ and $Q_1 = \bigcup_{j=1}^{\frac{k-3}{2}} (\overline{G_{2j+1} \setminus E_{2j+1}^2} - \{u_{2j+1}^2 u_{2j+1}^3, u_{2j+1}^4 u_{2j+1}^5\})$

And $\overline{H \setminus E_2}$ (see Figure 9) is

$$\begin{aligned} & (\overline{G_1 \setminus E_1^2} - \{u_1^2 u_1^3, u_1^4 u_1^5\}) \cup (\overline{G_0 \setminus E_0^0} - u_0^0 u_0^1) \\ & \cup \bigcup_{j=1}^{\frac{k-1}{2}} (\overline{G_{2j} \setminus E_{2j}^0} - \{x_{2j}, y_{2j}\}) \cup \bigcup_{j=1}^{\frac{k-3}{2}} (\overline{G_{2j+1} \setminus E_{2j+1}^0} - \{u_{2j+1}^0 u_{2j+1}^1\}) \\ & \cup \bigcup_{j=1}^{\frac{k-1}{2}} \{u_{2j}^6 b_{2j}, u_{2j+1}^1 b_{2j}, u_{2j}^7 b_{2j}\} \cup \bigcup_{j=1}^{\frac{k-3}{2}} \{u_{2j+1}^0 b_{2j+1}, u_{2j+2}^4 b_{2j+1}, u_{2j+2}^5 b_{2j+1}\} \\ & \cup \{u_1^5 u_2^5, u_1^4 b_1, u_2^4 b_1, u_1^2 c_0, u_1^3 b_0, b_0 c_0, u_0^0 b_0, c_0 b_1\}. \end{aligned}$$

If i is odd or $i = 0$, because $\overline{G_i \setminus E_i^0}$ is 3-edge colorable, there exists a 2-factor C_i^0 such that each component is an even circuit and $u_i^0 u_i^1$ is not in the 2-factor C_i^0 . Because $\overline{G_i \setminus E_i^2}$ is 3-edge colorable, there exists a 2-factor C_i^2 such each component is an even circuit and $u_i^2 u_i^3, u_i^4 u_i^5$ are in the 2-factor C_i^2 .

If i is even and $i \neq 0$, because $\overline{G_i \setminus E_i^2}$ is 3-edge colorable, there exists a 2-factor C_i^2 such each component is an even circuit and two paths with length two $u_i^0 x_i u_i^1$ and $u_i^2 y_i u_i^3$ are in the 2-factor C_i^2 . Similarly, because $\overline{G_i \setminus E_i^0}$ is 3-edge colorable, there exists a 2-factor C_i^0 such each component is an even circuit and $u_i^4 x_i u_i^5, u_i^6 y_i u_i^7$ are in the 2-factor C_i^0 .

Then $\overline{H \setminus E_0}$ (see Figure 9) has a 2-factor:

$$\begin{aligned}
& (C_0^2 - \{u_0^4 u_0^5, u_0^2 u_0^3\}) \cup C_1^0 \cup \bigcup_{j=1}^{\frac{k-3}{2}} (C_{2j+1}^2 - \{u_{2j+1}^2 u_{2j+1}^3, u_{2j+1}^4 u_{2j+1}^5\}) \\
& \cup \bigcup_{j=1}^{\frac{k-1}{2}} (C_{2j}^2 - \{x_{2j}, y_{2j}\}) \cup \bigcup_{j=1}^{\frac{k-1}{2}} \{b_{2j} u_{2j+1}^3, b_{2j} u_{2j}^2, u_{2j}^3 u_{2j+1}^2\} \cup \bigcup_{j=1}^{\frac{k-3}{2}} \{b_{2j+1} u_{2j+1}^4, \\
& b_{2j+1} u_{2j+2}^0, u_{2j+1}^5 u_{2j+2}^1\} \cup \{b_0 u_0^4, b_1 u_2^0, b_1 u_2^1, b_0 c_0, u_0^5 c_0\}
\end{aligned}$$

and each component is an even circuit.

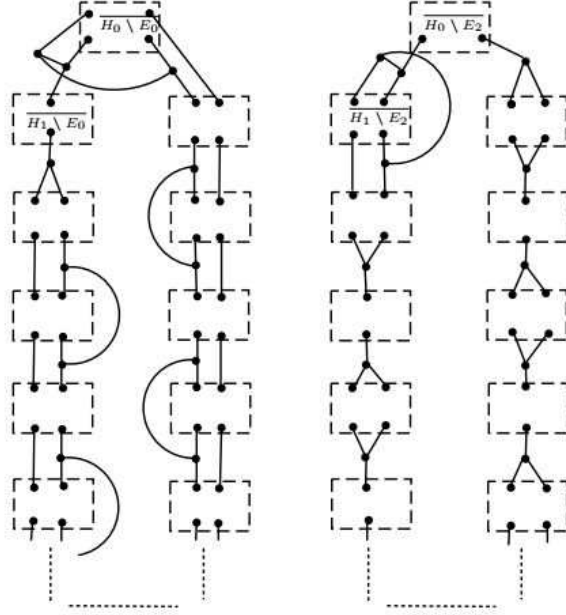

Figure 9: $\overline{H \setminus E_0}$ and $\overline{H \setminus E_2}$

$$H = \{G; G_0, G_1, \dots, G_{k-2}, G_{k-1}\}$$

$\overline{H \setminus E_2}$ has a 2-factor:

$$\begin{aligned}
& C_0^0 \cup (C_1^2 - \{u_1^2 u_1^3, u_1^4 u_1^5\}) \cup \bigcup_{j=1}^{\frac{k-1}{2}} (C_{2j}^0 - \{x_{2j}, y_{2j}\}) \cup \bigcup_{j=1}^{\frac{k-3}{2}} C_{2j+1}^0 \cup \bigcup_{j=1}^{\frac{k-1}{2}} \{u_{2j}^6 b_{2j}, u_{2j}^7 b_{2j}\} \\
& \cup \bigcup_{j=1}^{\frac{k-3}{2}} \{u_{2j+2}^4 b_{2j+1}, u_{2j+2}^5 b_{2j+1}\} \cup \{c_0 u_1^2, b_0 c_0, b_0 u_1^3, u_1^5 u_2^5, u_1^4 b_1, u_2^4 b_1\}.
\end{aligned}$$

And each component is an even circuit.

So $\overline{H \setminus E_0}$ and $\overline{H \setminus E_2}$ are 3-edge colorable. Therefore E_0 and E_2 are the desired matchings of Lemma 2.1 and $H = \{G; G_0, G_1, \dots, G_{k-2}, G_{k-1}\}$ has a Fulkerson-cover.

□

From Theorem 3.1 and Theorem 3.2, we get the Theorem 1.3 that every graph in $M_{0,1,2,\dots,(k-1)}$ has a Fulkerson-cover.

Acknowledgments

This work was supported by the NSFC (No.11371052), the Fundamental Research Funds for the Central Universities (Nos. 2016JBM071, 2016JBZ012), the 111 Project of China (B16002).

References

- [1] F. Chen, A note on Fouquet-Vanherpe's question and Fulkerson conjecture, Bulletin of Iranian Mathematical Society, 42(5)(2016) 1247-1258.
- [2] F. Chen and G. Fan, Fulkerson-covers of hypohamiltonian graphs, *Discrete Applied Mathematics* 186(2015) 66-73.
- [3] L. Esperet and G. Mazzuocolo, On cubic bridgeless graphs whose edge-set cannot be covered by four perfect matchings, *J. Graph Theory* 77(2)(2014) 144-157.
- [4] D.R. Fulkerson, Blocking and anti-blocking pairs of polyhedra, *Math. Program.* 1(1971) 168-194.
- [5] G. Fan and A. Raspaud, Fulkerson's conjecture and circuit covers, *J. Combin. Theory Ser. B.* 61 (1994) 133-138.
- [6] Rngxia Hao, Jianbin Niu, Xiaofeng Wang, Cun-Quan Zhang and T.Y. Zhang, A note on Berge-Fulkerson coloring, *Discrete Mathematics*, 309(2009) 4235-4240.
- [7] J. Hägglund, On snarks that are far from being 3-edge colorable, *Electron. J. Combin.* 23(2)(2016) 10 pages.
- [8] G. Mazzuocolo, The equivalence of two conjectures of Berge and Fulkerson, *J. Graph Theory* 68(2011) 125-128.
- [9] E. Máčajová and M. Škoviera, On a Conjecture of Fan and Raspaud, *Electronic Notes in Discrete Mathematics*, Volume 34, 1 August 2009, Pages 237-241
- [10] P.D. Seymour, On multi-colourings of cubic graphs, and conjectures of Fulkerson and Tutte, *Proc. Lond. Math. Soc.* 38(1979) 423-460.

- [11] C.-Q. Zhang, Integer Flows and Cycle Covers of Graphs, *Marcel Dekker Inc.*, New York, 1997.