

---

# A STRONG BISIMULATION FOR A CLASSICAL TERM CALCULUS BY MEANS OF MULTIPLICATIVE AND EXPONENTIAL REDUCTION

EDUARDO BONELLI, DELIA KESNER, AND ANDRÉS VISO

Stevens Institute of Technology, USA  
*e-mail address:* eabonelli@gmail.com

Université de Paris, CNRS, IRIF and Institut Universitaire de France, France  
*e-mail address:* kesner@irif.fr

Inria, France  
*e-mail address:* andres-ezequiel.viso@inria.fr

---

**ABSTRACT.** It is well-known that when translating terms into graphical formalisms many inessential details are abstracted away. In the case of  $\lambda$ -calculus and proof-nets, these inessential details are captured by a notion of equivalence on  $\lambda$ -terms known as  $\simeq_\sigma$ -equivalence in both the intuitionistic (due to Regnier) and classical (due to Laurent) cases. The purpose of this paper is to uncover a strong bisimulation behind  $\simeq_\sigma$ -equivalence, as formulated by Laurent for Parigot's  $\lambda\mu$ -calculus. This is achieved by introducing a relation  $\simeq$ , defined over a revised presentation of  $\lambda\mu$ -calculus we dub  $\Lambda M$ .

More precisely, we first identify the reasons behind Laurent's  $\simeq_\sigma$ -equivalence failing to be a strong bisimulation. Inspired by Laurent's *Polarized Proof-Nets*, this leads us to distinguish multiplicative and exponential reduction steps on terms. Second, we provide an enriched syntax that allows to keep track of the renaming operation. These technical ingredients are crucial to pave the way towards a strong bisimulation for the classical case. We thus introduce a calculus  $\Lambda M$  and a relation  $\simeq$  that we show to be a strong bisimulation with respect to reduction in  $\Lambda M$ , *i.e.* two  $\simeq$ -equivalent terms have the exact same reduction semantics, a result which fails for Regnier's  $\simeq_\sigma$ -equivalence in  $\lambda$ -calculus as well as for Laurent's  $\simeq_\sigma$ -equivalence in  $\lambda\mu$ . We also show that two  $\simeq$ -equivalent terms translate to equivalent Polarized Proof-Nets. Although  $\simeq$  is not strictly included in Laurent's  $\simeq_\sigma$ , it can be seen as a restriction of it.

## 1. INTRODUCTION

An important topic in the study of programming language theories is unveiling structural similarities between expressions denoting programs. They are widely known as *structural equivalences*; equivalent expressions behaving exactly in the same way. Process calculi are a rich source of examples. In CCS, expressions stand for processes in a concurrent system. For example,  $P \parallel Q$  denotes the parallel composition of processes  $P$  and  $Q$ . Structural equivalence includes equations such as the one stating that  $P \parallel Q$  and  $Q \parallel P$  are equivalent. This minor reshuffling of subexpressions has little impact on the behavior of the overall expression: structural equivalence is a *strong bisimulation* for process reduction. This paper is concerned with such notions of reshuffling of expressions in  *$\lambda$ -calculi with control*

*operators*. The induced notion of structural equivalence, in the sequel  $\simeq$ , should identify terms having exactly the same reduction semantics too. Stated equivalently,  $\simeq$  should be a strong bisimulation with respect to reduction in these calculi. This means that  $\simeq$  should be symmetric and moreover  $o \simeq p$  and  $o \rightsquigarrow o'$  should imply the existence of  $p'$  such that  $p \rightsquigarrow p'$  and  $o' \simeq p'$ , where  $\rightsquigarrow$  denotes some given notion of reduction for control operators. Graphically,

$$\begin{array}{ccc} o & \simeq & p \\ \Downarrow & & \Downarrow \\ o' & \simeq & p' \end{array} \quad (1.1)$$

It is worth mentioning that we are not after a general theory of program equivalence. On the one hand, not all terms having the same reduction semantics are identified, only those resulting from reshuffling in the sense made precise below. On the other hand, there are terms that do not have the same reduction semantics but would still be considered to “behave in the same way”. In particular, our proposed notion of equivalence is not a bisimilarity: there are terms that have the same reduction behavior but are not related by our  $\simeq$ -equivalence.

Before addressing  $\lambda$ -calculi with control operators, we comment on the state of affairs in the  $\lambda$ -calculus. Formulating structural equivalences for the  $\lambda$ -calculus is hindered by the sequential (left-to-right) orientation in which expressions are written. Consider for example the terms  $(\lambda x.(\lambda y.t)u)v$  and  $(\lambda x.\lambda y.t)vu$ . They seem to have the same redexes, only permuted, similar to the situation captured by the above mentioned CCS equation. A closer look, however, reveals that this is not entirely correct. The former has two redexes (one indicated below by underlining and another by overlining) and the latter has only one (underlined):

$$\underline{(\lambda x.(\lambda y.t)u)}v \text{ and } \overline{(\lambda x.(\lambda y.t)vu)} \quad (1.2)$$

The overlined redex on the left-hand side is not visible on the right-hand side; it will only reappear, as a newly *created* redex, once the underlined redex is computed. Despite the fact that the syntax gets in the way, Regnier [Reg94] managed to prove that these terms behave in *essentially* the same way. More precisely, he introduced a structural equivalence for  $\lambda$ -terms, known as  $\sigma$ -equivalence and proved that  $\sigma$ -equivalent terms have head, leftmost, perpetual and, more generally, maximal reductions of the same length. However, the mismatch between the terms in (1.2) is unsatisfying since there clearly seems to be an underlying strong bisimulation, which is not showing itself due to a notational shortcoming. It turns out that through the graphical intuition provided by linear logic *proof-nets* (PN), one can define an enriched  $\lambda$ -calculus with explicit substitutions (ES) that unveils a strong bisimulation for the intuitionistic case [ABKL14]. In this paper, we resort to this same intuition to explore whether it is possible to uncover a strong bisimulation behind the notion of  $\sigma$ -equivalence formulated by Laurent [Lau03] in the setting of classical logic. Thus, we will not only capture structural equivalence on pure functions, but also on *programs with control operators*. In our case it is *polarised proof-nets* (PPN) that will serve as semantic yardstick. We next briefly revisit proof-nets and discuss how they help unveil structural equivalence as strong bisimulation for  $\lambda$ -calculi. An explanation of the challenges that we face in addressing the classical case will follow.

**Proof-nets.** A proof-net is a graph-like structure whose nodes denote logical inferences and whose edges or wires denote the formula they operate on (*cf.* Sec. 5). Proof-nets were introduced in the setting of linear logic [Gir87], which provides a mechanism to explicitly control the use of resources by restricting the application of the *structural* rules of weakening and contraction. Proof-nets are equipped with an operational semantics specified by graph transformation rules which captures cut elimination in sequent calculus. The resulting cut elimination rules on proof-nets are split into two different kinds: *multiplicative*, that essentially reconfigure wires, and *exponential*, which are the only ones that are able to erase or duplicate (sub)proof-nets. Most notably, proof-nets abstract away the order in which certain rules occur in a sequent derivation. As an example, assume three derivations of the judgements  $\vdash \Gamma; A$ ,  $\vdash \Delta; A^\perp; B$  and  $\vdash \Pi; B^\perp$ , resp. The order in which these derivations are composed via cuts into a single derivation is abstracted away in the resulting proof-net:

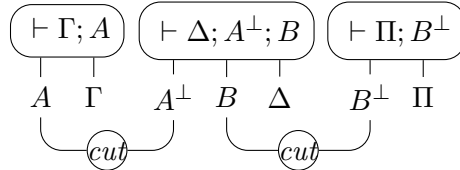

In other words, *different* terms/derivations are represented by the *same* proof-net. Hidden structural similarity between terms can thus be studied by translating them to proof-nets. Moreover, following the Curry–Howard isomorphism which relates computation and logic, this correspondence between a term language and a graphical formalism can also be extended to their reduction behavior [Acc18]. In this paper, however, we concentrate only on identifying those different derivations in classical logic which translate to the same graph representation. As is standard in the literature, the notion of proof-net identity we adopt goes beyond isomorphism of the underlying graphs and includes simple equalities such as *associativity* of contraction nodes and other similar rewirings (*cf.* notion of *structural equivalence* of proof-nets in Sec. 5).

**Intuitionistic  $\sigma$ -Equivalence.** As mentioned before, Regnier introduced a notion of  *$\sigma$ -equivalence* on  $\lambda$ -terms (written here  $\simeq_\sigma$  and depicted in Fig. 1), and proved that  $\sigma$ -equivalent terms behave in essentially identical way. This equivalence relation involves permuting certain redexes, and was unveiled through the study of proof-nets. In particular, following Girard’s encoding of intuitionistic logic into linear logic [Gir87],  $\sigma$ -equivalent terms are mapped to the same proof-net (modulo multiplicative cuts and structural equivalence of PN).

$$\begin{array}{l} (\lambda x. \lambda y. t) u \simeq_{\sigma_1} \lambda y. (\lambda x. t) u \quad y \notin u \\ (\lambda x. t v) u \simeq_{\sigma_2} (\lambda x. t) u v \quad x \notin v \end{array}$$

Figure 1:  $\sigma$ -Equivalence for  $\lambda$ -terms

The reason why Regnier’s result is not immediate is that redexes present on one side of an equation may disappear on the other side of it, as illustrated with the terms in (1.2). One might rephrase this observation by stating that  $\simeq_\sigma$  is *not a strong bisimulation* over the set of  $\lambda$ -terms. If it were, then establishing that  $\sigma$ -equivalent terms behave essentially in the same way would be trivial.

Adopting a more refined view of  $\lambda$ -calculus as suggested by linear logic, which splits cut elimination on logical derivations into multiplicative and exponential steps, yields a decomposition of  $\beta$ -reduction on terms into multiplicative/exponential steps. The theory of *explicit substitutions* (a survey can be found in [Kes09]) provides a convenient syntax to reflect this splitting at the term level. Indeed,  $\beta$ -reduction can be decomposed into two steps, namely **B** (for Beta), and **S** (for Substitution):

$$\begin{aligned} (\lambda x.t)u &\mapsto_{\mathbf{B}} t[x \setminus u] \\ t[x \setminus u] &\mapsto_{\mathbf{S}} t\{x \setminus u\} \end{aligned} \quad (1.3)$$

or, more generally, the *reduction at a distance* version for **B**, introduced in [AK10], and written **dB**:

$$\begin{aligned} (\lambda x.t)[x_1 \setminus v_1] \dots [x_n \setminus v_n]u &\mapsto_{\mathbf{dB}} t[x \setminus u][x_1 \setminus v_1] \dots [x_n \setminus v_n] \\ t[x \setminus u] &\mapsto_{\mathbf{S}} t\{x \setminus u\} \end{aligned} \quad (1.4)$$

Firing the **dB**-rule creates an *explicit substitution* operator, written  $t[x \setminus u]$ , so that **dB** essentially reconfigures symbols (is in some sense an innocuous or *plain* rule), and indeed reads as a multiplicative cut in proof-nets. The **S**-rule executes the substitution by performing a replacement of all free occurrences of  $x$  in  $t$  with  $u$ , written  $t\{x \setminus u\}$ , so that it is **S** that performs interesting or *meaningful* computation in the sense that it performs an exponential cut in proof-nets.

A term without any occurrence of the left-hand side of rule **dB** is called a **dB**-normal form; we shall refer to these terms as *plain forms*. More generally, we shall consider that plain forms are normal forms with respect to plain rules. Decomposition of  $\beta$ -reduction by means of the reduction rules in (1.4) prompts one to replace Regnier's  $\simeq_{\sigma}$  (Fig. 1) with a new relation [AK12b] that we write here  $\simeq_{\bar{\sigma}}$  (Fig. 2). The latter is formed essentially by taking the **dB**-normal form of each side of the  $\simeq_{\sigma}$  equations. Also included in  $\simeq_{\bar{\sigma}}$  is a third equation  $\simeq_{\bar{\sigma}_3}$  allowing commutation of orthogonal (independent) substitutions. Notice however that the **dB**-expansion of  $\simeq_{\bar{\sigma}_3}$  results in  $\sigma$ -equivalent terms, since  $t[y \setminus v][x \setminus u] \simeq_{\bar{\sigma}} t[x \setminus u][y \setminus v]$ , with  $x \notin v$  and  $y \notin u$ , **dB**-expands to  $(\lambda y.(\lambda x.t)u)v \simeq_{\sigma} (\lambda x.(\lambda y.t)v)u$ , both of which are  $\sigma$ -equivalent by  $\simeq_{\sigma_1}$  and  $\simeq_{\sigma_2}$ .

$$\begin{array}{lll} (\lambda y.t)[x \setminus u] & \simeq_{\bar{\sigma}_1} & \lambda y.t[x \setminus u] \quad y \notin u \\ (tv)[x \setminus u] & \simeq_{\bar{\sigma}_2} & t[x \setminus u]v \quad x \notin v \\ t[y \setminus v][x \setminus u] & \simeq_{\bar{\sigma}_3} & t[x \setminus u][y \setminus v] \quad x \notin v, y \notin u \end{array}$$

Figure 2: Strong Bisimulation for  $\lambda$ -Terms

With these considerations in mind, it is now possible to unveil a strong bisimulation for the intuitionistic case by working on  $\lambda$ -terms with ES. Given an appropriate notion of *meaningful computation*, one shows [AK12b] that  $\simeq_{\bar{\sigma}}$  is a strong bisimulation with respect to meaningful computation. We take here, for now, meaningful computation to be the reduction relation  $\rightarrow_{\mathbf{S}}$  defined above:

**Theorem 1.1** (Strong Bisimulation for the Intuitionistic Case I). *Let  $t \simeq_{\bar{\sigma}} t'$ . If  $t \rightarrow_{\mathbf{S}} u$ , then there exists  $u'$  such that  $t' \rightarrow_{\mathbf{S}} u'$  and  $t' \simeq_{\bar{\sigma}} u'$ . Graphically,*

$$\begin{array}{ccc} t & \simeq_{\tilde{\sigma}} & t' \\ \text{s} \downarrow & & \downarrow \text{s} \\ u & \simeq_{\tilde{\sigma}} & u' \end{array}$$

While any two  $\simeq_{\tilde{\sigma}}$ -equivalent  $\lambda$ -terms with ES translate to the same proof-net (and also to the same polarised proof-net), the converse is not true. For example, the terms  $(\lambda x.t v) u$  and  $(\lambda x.t) u v$ , where  $x \notin v$ , translate to the same proof-net (indeed, they are  $\sigma$ -equivalent), however they are not  $\simeq_{\tilde{\sigma}}$ -equivalent. Still, as remarked in [AK12b], the **dB**-normal forms of those terms, namely  $(t v)[x \setminus u]$  and  $t[x \setminus u] v$ , are  $\simeq_{\tilde{\sigma}}$ -equivalent, thus suggesting an alternative equivalence relation that we define only on **dB**-normal forms. Indeed, *plain forms* are  $\lambda$ -terms with ES that are in **dB**-normal form (which are intuitively, those terms that are in multiplicative normal form from the proof-net point of view). Similarly, *plain computation* is given by **dB**-reduction; plain computation to normal form produces plain forms. We write  $\simeq$  for this refined equivalence notion on plain forms, which will in fact be included in the strong bisimulation that we propose in this paper (*cf.* Def. 7.5). The following result, an instance of the more general theorem mentioned above, is then obtained:

**Theorem 1.2** (Strong Bisimulation for the Intuitionistic Case II). *Let  $\rightsquigarrow$  be  $\rightarrow_{\mathfrak{S}}$  followed by  $\rightarrow_{\mathbf{dB}}$ -reduction to **dB**-normal form. Let  $t, t'$  be two terms in **dB**-normal form such that  $t \simeq t'$ . If  $t \rightsquigarrow u$ , then there exists  $u'$  such that  $t' \rightsquigarrow u'$  and  $t' \simeq u'$ . Graphically,*

$$\begin{array}{ccc} t & \simeq & t' \\ \text{s} \downarrow & & \downarrow \text{s} \\ v & & v' \\ \mathbf{dB} \downarrow & & \mathbf{dB} \downarrow \\ u & \simeq & u' \end{array} \quad \text{or equivalently} \quad \begin{array}{ccc} t & \simeq & t' \\ \text{wavy} \downarrow & & \text{wavy} \downarrow \\ u & \simeq & u' \end{array}$$

Thus, a strong bisimulation can be defined on a set of *plain forms* (here  $\lambda$ -terms with ES which are in **dB**-normal form), with respect to a *meaningful computation* relation (here  $\rightarrow_{\mathfrak{S}}$ ) followed by **dB**-reduction to **dB**-normal form. Summing up, a strong bisimulation was obtained by decomposing  $\beta$ -reduction as follows:

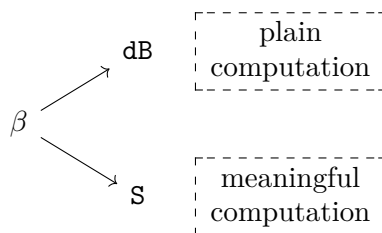

This methodology consisting in identifying an appropriate notion of plain form and meaningful computation, both over terms, allows for a strong bisimulation to surface. This requires establishing a corresponding distinction between multiplicative and exponential steps in the underlying term semantics. We propose following this same methodology for the classical case. However, as we will see, the notion of plain computation as well as that of meaningful one

are not so easy to construct. We next briefly introduce Parigot’s  $\lambda\mu$ -calculus [Par92, Par93] and  $\sigma$ -equivalence as introduced by Laurent [Lau03].

**Classical  $\sigma$ -Equivalence.**  $\lambda$ -calculi with control operators include operations to manipulate the context in which a program is executed. We focus here on Parigot’s  $\lambda\mu$ -calculus [Par92], which extends the  $\lambda$ -calculus with two new operations:  $[\alpha]t$  (*command*) and  $\mu\alpha.c$  ( $\mu$ -*abstraction*). The former may informally be understood as “call continuation  $\alpha$  with  $t$  as argument” and the latter as “record the current continuation as  $\alpha$  and continue as  $c$ ”. Reduction in  $\lambda\mu$  consists of the  $\beta$ -rule together with:

$$(\mu\alpha.c)u \mapsto_{\mu} \mu\alpha.c\{\{\alpha \setminus u\}\}$$

where  $c\{\{\alpha \setminus u\}\}$ , called here *replacement*, replaces all subexpressions of the form  $[\alpha]t$  in  $c$  with  $[\alpha](tu)$ . Regnier’s notion of  $\sigma$ -equivalence for  $\lambda$ -terms was extended to  $\lambda\mu$  by Laurent [Lau03] (*cf.* Fig. 4 in Sec. 4). Here is an example of terms related by this extension, where the redexes are underlined/overlined and  $\simeq_{\sigma}$  denotes Laurent’s aforementioned relation:

$$((\lambda x.\mu\alpha.[\gamma]u)w)v \simeq_{\sigma} \overline{(\mu\alpha.[\gamma](\lambda x.u)w)v}$$

Once again, the fact that a harmless permutation of redexes has taken place is not obvious. The term on the right has two redexes ( $\mu$  and  $\beta$ ) but the one on the left only has one ( $\beta$ ) redex. Another, more subtle, example of terms related by Laurent’s extension clearly suggests that operational indistinguishability cannot rely on relating arbitrary  $\mu$ -redexes; the underlined  $\mu$ -redex (on the left) does not appear at all on the right:

$$\underline{(\mu\alpha.[\alpha]x)y} \simeq_{\sigma} xy \tag{1.5}$$

Clearly,  $\sigma$ -equivalence on  $\lambda\mu$ -terms *fails to be a strong bisimulation*.

**Towards a Strong Bisimulation for Control Operators.** We seek to formulate a similar notion of equivalence for calculi with control operators in the sense that it is concerned with harmless permutation of redexes possibly involving control operators and induces a strong bisimulation. As per the Curry–Howard isomorphism, proof normalisation in classical logic corresponds to computation in  $\lambda$ -calculi with control operators [Gri90, Par92]. Moreover, since classical logic can be translated into polarised proof-nets, as defined by O. Laurent [Lau02, Lau03], we use PPN to guide the development in this work. In particular, we would ideally like our relation to equate terms that translate to structurally equivalent PPNs. However, we will not be able to equate all such terms: a subset of them must be excluded in order to achieve our strong bisimulation result, as we explain in what follows.

A first step towards our goal involves decomposing the  $\mu$ -rule as was done for the  $\beta$ -rule in (1.4) on page 4: this produces a rule **dM** (for **Mu** at a **d**istance), to introduce an *explicit replacement*, and another rule **R** (for **R**eplacement), that executes explicit replacements:

$$\begin{array}{l} (\mu\alpha.c)[x_1 \setminus v_1] \dots [x_n \setminus v_n]u \mapsto_{\mathbf{dM}} (\mu\alpha'.c\{\{\alpha \setminus^{\alpha'} u\}\})[x_1 \setminus v_1] \dots [x_n \setminus v_n] \\ c\{\{\alpha \setminus^{\alpha'} u\}\} \mapsto_{\mathbf{R}} c\{\{\alpha \setminus^{\alpha'} u\}\} \end{array} \tag{1.6}$$

where  $c\{\{\alpha \setminus^{\alpha'} u\}\}$  replaces each sub-expression of the form  $[\alpha]t$  in  $c$  by  $[\alpha'](tu)$ . Meaningful computation seems to be performed by **R** rather than **dM**. This observation is further supported by the fact that both sides of the **dM**-rule translate into the same proof-net (*cf.* Sec. 8).

Therefore, we tentatively fix our notion of meaningful computation to be **SUR** over the set of plain forms, the latter now obtained by taking *both* **dB** and **dM**-normal forms. However,

in contrast to the intuitionistic case where the decomposition of  $\beta$  into a multiplicative rule  $\mathbf{dB}$  and an exponential rule  $\mathbf{S}$  suffices for unveiling the strong bisimulation behind Regnier's  $\sigma$ -equivalence in  $\lambda$ -calculus, it turns out that splitting the  $\mu$ -rule into  $\mathbf{dM}$  and  $\mathbf{R}$  is not enough. There are various examples that illustrate that the resulting relation  $\simeq$  is still not a strong bisimulation. These examples fall into two categories that we discuss below.

**Multiplicative/Exponential Steps on Terms:** A first example results from taking the  $(\mathbf{dB}, \mathbf{dM})$ -normal form (plain forms are momentarily terms in  $(\mathbf{dB}, \mathbf{dM})$ -normal form) of the terms in (1.5):

$$\begin{array}{ccc} \mu\alpha'.([\alpha]x)[\alpha \setminus^{\alpha'} y] & \simeq & xy \\ \mathbf{R} \downarrow & & \downarrow \mathbf{R} \\ \mu\alpha'.[\alpha']xy & \simeq & xy \end{array} \quad (1.7)$$

The relation  $\simeq$  will formally be introduced in Sec. 7 (Def. 7.5).

Notice that this particular use of  $\mathbf{R}$  on the left in (1.7) seems innocuous. This example prompts us to further inquire on the fine structure of  $\mathbf{R}$ . In particular,  $\mathbf{R}$ -steps may translate to either identical proof-nets, or proof-nets related only by multiplicative steps, or to proof-nets related only by exponential steps. This phenomenon will guide the introduction of appropriate notions of plain and meaningful steps in our classical term calculus, by accordingly decomposing  $\mathbf{R}$  into several smaller relations. Refining  $\mathbf{R}$  constitutes one of the two pillars on which the proposed strong bisimulation is based.

**Implicit vs Explicit Renaming:** In  $\lambda\mu$ , an expression such as  $[\alpha]\mu\beta.c$  may be simplified to another expression  $c\{\beta \setminus \alpha\}$  where all occurrences of the name  $\beta$  are replaced with  $\alpha$ . Such an equation, dubbed  $\simeq_\rho$ , is included in Laurent's  $\simeq_\sigma$  and also breaks strong bisimulation. However, one cannot simply drop  $\simeq_\rho$  since one loses completeness with respect to structural equivalence of PPNs. Moreover, one also needs this equation, or some analogue of it, to close diagrams involving other equations (Example 7.11). Our proposed way out is to leave a trace of the implicit renaming operation in terms of an explicit one and adjust the behavior of replacement accordingly. This results in a splitting of  $\simeq_\rho$  into two finer equations:

$$\begin{array}{ccc} [\alpha]\mu\beta.c & \simeq_{\mathbf{p}} & c[\beta \setminus \alpha] \\ c[\alpha \setminus \beta] & \simeq_{\mathbf{ren}} & c\{\alpha \setminus \beta\} \end{array}$$

The expression  $c[\beta \setminus \alpha]$  is called an explicit renaming. Although the first of these equations is included in our equivalence  $\simeq$ , the second is not. This choice constitutes the second pillar on which the strong bisimulation is based.

In summary, we propose a relation  $\simeq$  over a presentation of  $\lambda\mu$  that includes explicit substitution, explicit replacement and explicit renaming. This relation does not capture structural equivalence of PPNs entirely, but does constitute a strong bisimulation. The pairs of terms that are left out of this relation are those given by the equation  $\simeq_{\mathbf{ren}}$  which is exactly the one that would break the strong bisimulation property of our relation. As mentioned above, adding  $\simeq_{\mathbf{ren}}$  into  $\simeq$  produces a relation that characterizes structural equivalence of PPNs entirely (*cf.* Thm. 8.11), as does Laurent's  $\simeq_\sigma$ .

**Contributions.** Our contributions may be summarised as follows:

- (1) A refinement of  $\lambda\mu$ , called  $\Lambda M$ -calculus, including explicit substitutions for variables, explicit replacement for names and explicit renamings.  $\Lambda M$  is proved to be confluent (Thm. 4.3);
- (2) A natural interpretation of  $\Lambda M$  into polarised proof-nets. More precisely,  $\Lambda M$ -reduction can be implemented by PPN cut elimination (Thm. 6.6), in the sense that one-step reduction in  $\Lambda M$  translates to a reduction sequence in PPN.
- (3) A notion of structural equivalence  $\simeq$  for  $\Lambda M$  enjoying the following properties:
  - (a)  $\simeq$  is a strong bisimulation with respect to exponential steps (Thm. 7.10).
  - (b)  $\simeq$ -equivalent terms translate to structurally equivalent PPN (Thm. 8.4);
  - (c)  $\simeq_{\text{er}}$  is conservative with respect to Laurent's original equivalence  $\simeq_{\sigma}$  (Thm. 8.11), where  $\simeq_{\text{er}}$  is  $\simeq \cup \simeq_{\text{ren}}$ .

This paper is an extended and revised version of [KBV20].

**Structure of the paper.** After some preliminaries on notation introduced in Sec 2, Sec. 3 and Sec. 4 present  $\lambda\mu$  and  $\Lambda M$ , resp. Sec. 5 defines polarised proof-nets, and Sec. 6 presents the translation from  $\Lambda M$  to PPN. Sec. 7 discusses the difficulties in formulating  $\simeq$ -equivalence and presents the strong bisimulation result. Its properties are discussed and proved in Sec. 8. Finally, Sec. 9 concludes and describes related work. Most proofs are relegated to the Appendix.

## 2. SOME BASIC PRELIMINARY NOTIONS

We start this section by some generic notations. Let  $\mathcal{R}$  be any reduction relation on a set of elements  $\mathcal{O}$ . We write  $\twoheadrightarrow_{\mathcal{R}}$  for the reflexive-transitive closure of  $\rightarrow_{\mathcal{R}}$ . If  $\mathcal{S}$  is another reduction relation on  $\mathcal{O}$ , we use  $\twoheadrightarrow_{\mathcal{R},\mathcal{S}}$  to denote  $\twoheadrightarrow_{\mathcal{R}} \cup \twoheadrightarrow_{\mathcal{S}}$ . We say there is an  $\mathcal{R}$ -reduction sequence starting at  $t_0 \in \mathcal{O}$  if there exists  $t_1 \dots, t_n \in \mathcal{O}$  with  $n \geq 0$ , such that  $t_0 \rightarrow_{\mathcal{R}} t_1$ ,  $t_1 \rightarrow_{\mathcal{R}} t_2$ ,  $\dots$ ,  $t_{n-1} \rightarrow_{\mathcal{R}} t_n$ . We occasionally refer to  $\mathcal{R}$ -reduction as  $\mathcal{R}$ -computation. An element  $t \in \mathcal{O}$  is said to be  **$\mathcal{R}$ -confluent** iff for every  $u, v \in \mathcal{O}$  such that  $t \twoheadrightarrow_{\mathcal{R}} u$  and  $t \twoheadrightarrow_{\mathcal{R}} v$ , there exists  $t'$  such that  $u \twoheadrightarrow_{\mathcal{R}} t'$  and  $v \twoheadrightarrow_{\mathcal{R}} t'$ . A reduction relation  $\mathcal{R}$  is **confluent** iff every  $t \in \mathcal{O}$  is  $\mathcal{R}$ -confluent. An element  $t \in \mathcal{O}$  is said to be  **$\mathcal{R}$ -terminating** iff there is no infinite  $\mathcal{R}$ -reduction sequence starting at  $t$ . A reduction relation  $\mathcal{R}$  is **terminating** iff every  $t \in \mathcal{O}$  is  $\mathcal{R}$ -terminating. An element  $t \in \mathcal{O}$  is said to be in  **$\mathcal{R}$ -normal form** iff there is no  $t'$  such that  $t \rightarrow_{\mathcal{R}} t'$ . We use  $\mathcal{NF}_{\mathcal{R}}$  to denote all the normal forms of  $\mathcal{R}$ , *i.e.* the set of all the elements in  $\mathcal{O}$  which are in  $\mathcal{R}$ -normal form. Given  $t \in \mathcal{O}$ , we say that  $u$  is an  **$\mathcal{R}$ -normal form of  $t$**  if  $t \twoheadrightarrow_{\mathcal{R}} u$  and  $u$  is in  $\mathcal{R}$ -normal form. We denote by  $\text{nf}_{\mathcal{R}}(t)$  the set of all  $\mathcal{R}$ -normal forms of  $t$ ; this set is always a singleton when  $\mathcal{R}$  is confluent and terminating.

## 3. THE $\lambda\mu$ -CALCULUS

In this section we introduce the untyped  $\lambda\mu$ -calculus as well as its simply typed version.



**3.1. The Untyped  $\lambda\mu$ -Calculus.** Given a countably infinite set of variables  $\mathbb{V} (x, y, \dots)$  and names  $\mathbb{N} (\alpha, \beta, \dots)$ , the set of **objects**  $\mathbb{O}_{\lambda\mu}$ , **terms**  $\mathbb{T}_{\lambda\mu}$ , **commands**  $\mathbb{C}_{\lambda\mu}$  and **contexts** of the  $\lambda\mu$ -calculus are defined by means of the following grammar:

$$\begin{array}{ll}
\text{(Objects)} & o ::= t \mid c \\
\text{(Terms)} & t ::= x \mid tt \mid \lambda x.t \mid \mu\alpha.c \\
\text{(Commands)} & c ::= [\alpha]t \\
\text{(Contexts)} & \mathbb{O} ::= \mathbb{T} \mid \mathbb{C} \\
\text{(Term Contexts)} & \mathbb{T} ::= \square \mid \mathbb{T}t \mid t\mathbb{T} \mid \lambda x.\mathbb{T} \mid \mu\alpha.\mathbb{C} \\
\text{(Command Contexts)} & \mathbb{C} ::= \sqsupset \mid [\alpha]\mathbb{T}
\end{array}$$

The grammar extends the terms of the  $\lambda$ -calculus with two new constructors: **commands**  $[\alpha]t$  and  **$\mu$ -abstractions**  $\mu\alpha.c$ . The term  $(\dots((tu_1)u_2)\dots)u_n$  abbreviates as  $tu_1u_2\dots u_n$  or  $t\vec{u}$  when  $n$  is clear from the context. Regarding contexts, there are two holes  $\square$  and  $\sqsupset$  of sort **term** ( $t$ ) and **command** ( $c$ ) respectively. We write  $\mathbb{O}\langle o \rangle$  to denote the replacement of the hole  $\square$  (resp.  $\sqsupset$ ) by a term (resp. by a command). We often decorate contexts or functions over expressions with one of the sorts  $t$  and  $c$  to be more clear. For example,  $\mathbb{O}_t$  is a context  $\mathbb{O}$  with a hole of sort **term**. The subscript is omitted if it is clear from the context.

**Free and bound variables** of objects are defined as expected, in particular  $\text{fv}(\mu\alpha.c) \triangleq \text{fv}(c)$  and  $\text{fv}([\alpha]t) \triangleq \text{fv}(t)$ . **Free and bound names** are defined as follows:

$$\begin{array}{ll}
\text{fn}(x) \triangleq \emptyset & \text{bn}(x) \triangleq \emptyset \\
\text{fn}(tu) \triangleq \text{fn}(t) \cup \text{fn}(u) & \text{bn}(tu) \triangleq \text{bn}(t) \cup \text{bn}(u) \\
\text{fn}(\lambda x.t) \triangleq \text{fn}(t) & \text{bn}(\lambda x.t) \triangleq \text{bn}(t) \\
\text{fn}(\mu\alpha.c) \triangleq \text{fn}(c) \setminus \{\alpha\} & \text{bn}(\mu\alpha.c) \triangleq \text{bn}(c) \cup \{\alpha\} \\
\text{fn}([\alpha]t) \triangleq \text{fn}(t) \cup \{\alpha\} & \text{bn}([\alpha]t) \triangleq \text{bn}(t)
\end{array}$$

We use  $\text{fv}_x(o)$  and  $\text{fn}_\alpha(o)$  to denote the number of free occurrences of the variable  $x$  and the name  $\alpha$  in the object  $o$  respectively. Additionally, we write  $x \notin o$  ( $\alpha \notin o$ ) when  $x \notin \text{fv}(o) \cup \text{bv}(o)$  (respectively  $\alpha \notin \text{fn}(o) \cup \text{bn}(o)$ ). This notion is naturally extended to contexts.

We work with the standard notion of  $\alpha$ -conversion, *i.e.* renaming of bound variables and names, thus for example  $[\delta](\mu\alpha.[\alpha]\lambda x.x)z =_\alpha [\delta](\mu\beta.[\beta]\lambda y.y)z$ . In particular, when using two different symbols to denote bound variables or names, we assume that they are different without explicitly mentioning it.

**Application** of the **implicit substitution**  $\{x \setminus u\}$  to the object  $o$ , written  $o\{x \setminus u\}$ , may require  $\alpha$ -conversion in order to avoid capture of free variables/names, and it is defined as expected.

**Application** of the **implicit replacement**  $\{\alpha \setminus^{\alpha'} u\}$  to an object  $o$ , written  $o\{\alpha \setminus^{\alpha'} u\}$ , passes the term  $u$  as an argument to any sub-command of  $o$  of the form  $[\alpha]t$  and changes the name of  $\alpha$  to  $\alpha'$ . This operation is also defined modulo  $\alpha$ -conversion in order to avoid the capture of free variables/names. Formally:

$$\begin{array}{ll}
x\{\alpha \setminus^{\alpha'} u\} \triangleq x & \\
(tv)\{\alpha \setminus^{\alpha'} u\} \triangleq t\{\alpha \setminus^{\alpha'} u\}v\{\alpha \setminus^{\alpha'} u\} & \\
(\lambda x.t)\{\alpha \setminus^{\alpha'} u\} \triangleq \lambda x.t\{\alpha \setminus^{\alpha'} u\} & x \notin u \\
(\mu\beta.c)\{\alpha \setminus^{\alpha'} u\} \triangleq \mu\beta.c\{\alpha \setminus^{\alpha'} u\} & \beta \notin u, \beta \neq \alpha' \\
([\alpha]c)\{\alpha \setminus^{\alpha'} u\} \triangleq [\alpha'](c\{\alpha \setminus^{\alpha'} u\}u) & \\
([\beta]c)\{\alpha \setminus^{\alpha'} u\} \triangleq [\beta]c\{\alpha \setminus^{\alpha'} u\} & \beta \neq \alpha
\end{array}$$

For example, if  $I = \lambda z.z$ , then

$$\begin{aligned} ((\mu\alpha.[\alpha]x)(\lambda z.zx))\{x \setminus I\} &= (\mu\alpha.[\alpha]I)(\lambda z.zI) \\ ([\alpha]x(\mu\beta.[\alpha]y))\{\alpha \setminus^{\alpha'} I\} &= [\alpha']x(\mu\beta.[\alpha']y)I \end{aligned}$$

The **one-step reduction relation**  $\rightarrow_{\lambda\mu}$  is given by the closure by *all* contexts  $\mathbf{0}_t$  of the following rewriting rules  $\beta$  and  $\mu$ , *i.e.*  $\rightarrow_{\lambda\mu} \triangleq \mathbf{0}_t \langle \mapsto_{\beta} \cup \mapsto_{\mu} \rangle$ :

$$\begin{aligned} (\lambda x.t)u &\mapsto_{\beta} t\{x \setminus u\} \\ (\mu\alpha.c)u &\mapsto_{\mu} \mu\alpha'.c\{\alpha \setminus^{\alpha'} u\} \end{aligned}$$

Given  $X \in \{\beta, \mu\}$ , we define an  **$X$ -redex** to be a term having the form of the left-hand side of the rule  $\mapsto_X$ . A similar notion will be used for all the rewriting rules used in this paper. It is worth noticing that Parigot's [Par92]  $\mu$ -rule of the  $\lambda\mu$ -calculus relies on a binary implicit replacement operation  $\{\alpha \setminus u\}$  assigning  $[\alpha](t\{\alpha \setminus u\})u$  to each sub-expression of the form  $[\alpha]t$  (thus not changing the name of the command). We remark that  $\mu\alpha.c\{\alpha \setminus u\} =_{\alpha} \mu\alpha'.c\{\alpha \setminus^{\alpha'} u\}$ ; thus *e.g.*  $\mu\alpha.([\alpha]x)\{\alpha \setminus u\} = \mu\alpha.([\alpha]xu) =_{\alpha} \mu\gamma.([\gamma]xu) = \mu\gamma.([\alpha]x)\{\alpha \setminus^{\gamma} u\}$ . We adopt here the ternary presentation [KV19] of the implicit replacement operator, because it naturally extends to that of the  $\Lambda M$ -calculus in Sec 4.

Various control operators can be expressed in the  $\lambda\mu$ -calculus [dG94, Lau03]. A typical example is the control operator **call-cc** [Gri90], specified by the term  $\lambda x.\mu\alpha.[\alpha]x(\lambda y.\mu\delta.[\alpha]y)$ .

**3.2. The Simply Typed  $\lambda\mu$ -Calculus.** In this section we introduce the simply typed system  $\mathcal{M}$  for the  $\lambda\mu$ -calculus. The set of **types**  $\mathcal{T}$  is generated by the following grammar:

$$\text{Simple Types } A ::= \iota \mid A \rightarrow A$$

where  $\iota$  is a base type. As usual, the functional type  $\rightarrow$  is assumed to be right associative. We use two different sorts of **type contexts**. Indeed, a **variable context**  $\Gamma$  (resp. **name context**  $\Delta$ ) is a (partial) function from variables (resp. names) to types whose domain, written  $\text{dom}(\Gamma)$  (resp.  $\text{dom}(\Delta)$ ), is finite. We may use sets of pairs of the form  $x : A$  (resp.  $\alpha : A$ ) to represent a context. We write  $\Gamma \cup \Gamma'$  and  $\Delta \cup \Delta'$  for the **compatible union** between assignments meaning that if  $x \in \text{dom}(\Gamma \cap \Gamma')$  then  $\Gamma(x) = \Gamma'(x)$ , and similarly for  $\Delta$  and  $\Delta'$ . In the particular case when  $\text{dom}(\Gamma)$  and  $\text{dom}(\Delta)$  are disjoint we may write  $\Gamma; \Delta$  instead of  $\Gamma \cup \Delta$ , thus in particular  $\Gamma; x : A$  means that  $x \notin \text{dom}(\Gamma)$ . The notation  $\Gamma; (x : A)^{\leq 1}$  is used to denote either  $\Gamma$  or  $\Gamma; x : A$ , *i.e.* either  $x \notin \text{dom}(\Gamma; (x : A)^{\leq 1})$  or else  $(\Gamma; (x : A)^{\leq 1})(x) = A$ . Analogously for name contexts.

The typing rules of system  $\mathcal{M}$  for the  $\lambda\mu$ -calculus are given in Fig. 3. There are two kinds of **typing judgments**:  $\Gamma \vdash t : A \mid \Delta$  for terms and  $\Gamma \vdash c \mid \Delta$  for commands. Note that commands have no type, *cf.* rule (NAME).

We use the abbreviation  $\Gamma \vdash o : T \mid \Delta$  for the two kinds of typing judgments, resulting  $o = t$  and  $T = A$  in the case of the terms; and  $o = c$  and no type  $T$  for the commands. We write  $\pi \triangleright_{\mathcal{M}} \Gamma \vdash o : T \mid \Delta$  when the typing judgment  $\Gamma \vdash o : T \mid \Delta$  is derivable in  $\mathcal{M}$  and  $\pi$  is its associated derivation. In this case, we say that  $o$  is the **subject** of  $\pi$ . For convenience, we may abbreviate  $\pi_o$  a derivation with subject  $o$ .

The simply typed  $\lambda\mu$ -calculus turns out to be a propositions-as-types interpretation for classical logic in the sense that terms encode sequent derivations and term reduction

$$\begin{array}{c}
\frac{}{x : A \vdash x : A \mid \emptyset} \text{(VAR)} \quad \frac{\Gamma \vdash t : A \rightarrow B \mid \Delta \quad \Gamma' \vdash u : A \mid \Delta'}{\Gamma \cup \Gamma' \vdash t u : B \mid \Delta \cup \Delta'} \text{(APP)} \\
\\
\frac{\Gamma; (x : A)^{\leq 1} \vdash t : B \mid \Delta}{\Gamma \vdash \lambda x. t : A \rightarrow B \mid \Delta} \text{(ABS)} \quad \frac{\Gamma \vdash c \mid \Delta; (\alpha : A)^{\leq 1}}{\Gamma \vdash \mu \alpha. c : A \mid \Delta} \text{(CONT)} \\
\\
\frac{\Gamma \vdash t : A \mid \Delta; (\alpha : A)^{\leq 1}}{\Gamma \vdash [\alpha] t \mid \Delta; \alpha : A} \text{(NAME)}
\end{array}$$

Figure 3: Typing Rules of System  $\mathcal{M}$  for the  $\lambda\mu$ -Calculus

encodes proof normalisation. This allows to type *e.g.* the **call-cc** operator with type  $((A \rightarrow B) \rightarrow A) \rightarrow A$  (Peirce's Law):

$$\begin{array}{c}
\frac{}{y : A \vdash y : A \mid \emptyset} \text{(VAR)} \\
\frac{}{y : A \vdash [\alpha] y \mid \alpha : A} \text{(NAME)} \\
\frac{}{y : A \vdash \mu \delta. [\alpha] y : B \mid \alpha : A} \text{(CONT)} \\
\frac{}{x : (A \rightarrow B) \rightarrow A \vdash x : (A \rightarrow B) \rightarrow A \mid \emptyset} \text{(VAR)} \quad \frac{}{\emptyset \vdash \lambda y. \mu \delta. [\alpha] y : A \rightarrow B \mid \alpha : A} \text{(ABS)} \\
\frac{}{x : (A \rightarrow B) \rightarrow A \vdash x (\lambda y. \mu \delta. [\alpha] y) : A \mid \alpha : A} \text{(APP)} \\
\frac{}{x : (A \rightarrow B) \rightarrow A \vdash [\alpha] x (\lambda y. \mu \delta. [\alpha] y) \mid \alpha : A} \text{(NAME)} \\
\frac{}{x : (A \rightarrow B) \rightarrow A \vdash \mu \alpha. [\alpha] x (\lambda y. \mu \delta. [\alpha] y) : A \mid \emptyset} \text{(CONT)} \\
\frac{}{\emptyset \vdash \lambda x. \mu \alpha. [\alpha] x (\lambda y. \mu \delta. [\alpha] y) : ((A \rightarrow B) \rightarrow A) \rightarrow A \mid \emptyset} \text{(ABS)}
\end{array}$$

System  $\mathcal{M}$  enjoys the following properties (a non-relevant version of subject reduction appears in [Par92]):

**Lemma 3.1** (Relevance). *Let  $o \in \mathbb{O}_{\lambda\mu}$ . If  $\pi \triangleright_{\mathcal{M}} \Gamma \vdash o : T \mid \Delta$ , then  $\text{dom}(\Gamma) = \text{fv}(o)$  and  $\text{dom}(\Delta) = \text{fn}(o)$ .*

Free variables and names of objects may decrease in the case of erasing reduction steps, preserving however the derivability relation. For example,  $(\lambda x. y) z \rightarrow y$  or  $(\mu \alpha. [\gamma] x) z \rightarrow \mu \alpha. [\gamma] x$ . More precisely,

**Lemma 3.2** (Subject Reduction). *Let  $o \in \mathbb{O}_{\lambda\mu}$ . If  $\pi \triangleright_{\mathcal{M}} \Gamma \vdash o : T \mid \Delta$  and  $o \rightarrow_{\lambda\mu} o'$ , then there exist  $\Gamma' \subseteq \Gamma$ ,  $\Delta' \subseteq \Delta$  and  $\pi'$  such that  $\pi' \triangleright_{\mathcal{M}} \Gamma' \vdash o' : T \mid \Delta'$ .*

From now on, when  $\pi \triangleright_{\mathcal{M}} \Gamma \vdash o : T \mid \Delta$ ,  $o \rightarrow_{\lambda\mu} o'$  and  $\pi' \triangleright_{\mathcal{M}} \Gamma' \vdash o' : T \mid \Delta'$ , we will refer to  $\pi$  and  $\pi'$  as two **related** typing derivations, *i.e.*  $\pi'$  is the type derivation obtained from  $\pi$  by the proof of Lem. 3.2.

**3.3. The notion of  $\sigma$ -equivalence for  $\lambda\mu$ -terms.** As in  $\lambda$ -calculus, structural equivalence for the  $\lambda\mu$ -calculus captures inessential permutation of redexes, but this time also involving the control constructs.

**Definition 3.3.** *Laurent's notion of  $\sigma$ -equivalence for  $\lambda\mu$ -terms [Lau03] (written here also  $\simeq_\sigma$ ) is depicted in Fig. 4, where  $\{\beta \setminus \alpha\}$  denotes the **implicit renaming** of all the free occurrences of the name  $\beta$  by  $\alpha$  (a formal definition is given in Sec. 4.3).*

$$\begin{array}{llll}
(\lambda y. \lambda x. t) v & \simeq_{\sigma_1} & \lambda x. (\lambda y. t) v & x \notin v \\
(\lambda x. t v) u & \simeq_{\sigma_2} & (\lambda x. t) u v & x \notin v \\
(\lambda x. \mu \alpha. [\beta] u) w & \simeq_{\sigma_3} & \mu \alpha. [\beta] (\lambda x. u) w & \alpha \notin w \\
[\alpha'] (\mu \alpha. [\beta'] (\mu \beta. c) w) v & \simeq_{\sigma_4} & [\beta'] (\mu \beta. [\alpha'] (\mu \alpha. c) v) w & \alpha \notin w, \beta \notin v, \beta \neq \alpha', \alpha \neq \beta' \\
[\alpha'] (\mu \alpha. [\beta'] \lambda x. \mu \beta. c) v & \simeq_{\sigma_5} & [\beta'] \lambda x. \mu \beta. [\alpha'] (\mu \alpha. c) v & x \notin v, \beta \notin v, \beta \neq \alpha', \alpha \neq \beta' \\
[\alpha'] \lambda x. \mu \alpha. [\beta'] \lambda y. \mu \beta. c & \simeq_{\sigma_6} & [\beta'] \lambda y. \mu \beta. [\alpha'] \lambda x. \mu \alpha. c & \beta \neq \alpha', \alpha \neq \beta' \\
[\alpha] \mu \beta. c & \simeq_{\sigma_7} & c\{\beta \setminus \alpha\} & \\
\mu \alpha. [\alpha] v & \simeq_{\sigma_8} & v & \alpha \notin v
\end{array}$$

Figure 4:  $\sigma$ -equivalence for  $\lambda\mu$ -terms

The first two equations are exactly those of Regnier (hence  $\simeq_\sigma$  on  $\lambda\mu$ -terms strictly extends  $\simeq_\sigma$  on  $\lambda$ -terms); the remaining ones involve interactions between control operators themselves or control operators and application and abstraction. It is worth noticing that our equations  $\simeq_{\sigma_7}$  and  $\simeq_{\sigma_8}$  are called, respectively,  $\simeq_\rho$  and  $\simeq_\theta$  in [Lau03].

**Lemma 3.4** (Type Preservation [Lau03]). *Let  $o \in \mathbb{O}_{\lambda\mu}$ . If  $\pi \triangleright_{\mathcal{M}} \Gamma \vdash o : T \mid \Delta$  and  $o \simeq_\sigma o'$ , then there exists  $\pi'$  such that  $\pi' \triangleright_{\mathcal{M}} \Gamma \vdash o' : T \mid \Delta$ .*

Laurent proved properties for  $\simeq_\sigma$  on  $\lambda\mu$ -terms similar to those of Regnier for  $\simeq_\sigma$  on  $\lambda$ -terms. More precisely,  $u \simeq_\sigma v$  implies that  $u$  is normalisable (resp. is head normalisable, strongly normalisable) iff  $v$  is normalisable (resp. is head normalisable, strongly normalisable) [Lau03, Prop. 35]. Based on Girard's encoding of classical into intuitionistic logic [Gir91], he also proved that the translation of the left and right-hand sides of the equations of  $\simeq_\sigma$ , in a typed setting, yield structurally equivalent (polarised) proof-nets [Lau03, Thm. 41]. These results are non-trivial because the left and right-hand side of the equations in Fig. 4 do not have the same  $\beta$  and  $\mu$  redexes. For example,  $(\mu \alpha. [\alpha] x) y$  and  $x y$  are related by equation  $\sigma_8$ , however the former has a  $\mu$ -redex (more precisely it has a *linear*  $\mu$ -redex) and the latter has none. Indeed,  $\simeq_\sigma$  is not a strong bisimulation with respect to  $\lambda\mu$ -reduction, as mentioned in the Introduction (*cf.* the terms in (1.5)):

$$\begin{array}{ccc}
(\mu \alpha. [\alpha] x) y & \simeq_{\sigma_8} & x y \\
\mu \downarrow & & \downarrow \mu \\
\mu \alpha. [\alpha] x y & \simeq_{\sigma_8} & x y
\end{array} \tag{3.1}$$

There are other examples illustrating that  $\simeq_\sigma$  is not a strong bisimulation (*cf.* Sec. 7). It seems natural to wonder whether, just like in the intuitionistic case, a more refined notion of  $\lambda\mu$ -reduction could change this state of affairs; a challenge we take up in this paper.

#### 4. THE $\Lambda M$ -CALCULUS

As a first step towards the definition of an adequate strongly bisimilar structural equivalence for the  $\lambda$ -calculus with control operators, we extend the syntax and operational semantics of

the  $\lambda\mu$ -calculus to a term calculus with explicit operators for substitution, replacement and renaming. We present its untyped and simply typed versions.

4.1. **Terms for  $\Lambda M$ .** We consider again a countably infinite set of **variables**  $\mathbb{V}$  ( $x, y, \dots$ ) and **names**  $\mathbb{N}$  ( $\alpha, \beta, \dots$ ). The set of **objects**  $\mathbb{O}_{\Lambda M}$ , **terms**  $\mathbb{T}_{\Lambda M}$ , **commands**  $\mathbb{C}_{\Lambda M}$ , **stacks** and **contexts** of the  $\Lambda M$ -calculus are given by the following grammar:

$$\begin{array}{ll}
\text{(Objects)} & o ::= t \mid c \mid s \\
\text{(Terms)} & t ::= x \mid tt \mid \lambda x.t \mid \mu\alpha.c \mid t[x \setminus t] \\
\text{(Commands)} & c ::= [\alpha]t \mid c[\alpha \setminus^{\alpha'} s] \mid c[\alpha \setminus \beta] \\
\text{(Stacks)} & s ::= t \mid t \cdot s \\
\text{(Contexts)} & \mathbb{O} ::= \mathbb{T} \mid \mathbb{C} \mid \mathbb{S} \\
\text{(Term Contexts)} & \mathbb{T} ::= \square \mid \mathbb{T}t \mid t\mathbb{T} \mid \lambda x.\mathbb{T} \mid \mu\alpha.\mathbb{C} \mid \mathbb{T}[x \setminus t] \mid t[x \setminus \mathbb{T}] \\
\text{(Command Contexts)} & \mathbb{C} ::= \square \mid [\alpha]\mathbb{T} \mid \mathbb{C}[\alpha \setminus^{\alpha'} s] \mid c[\alpha \setminus^{\alpha'} \mathbb{S}] \mid \mathbb{C}[\alpha \setminus \beta] \\
\text{(Stack Contexts)} & \mathbb{S} ::= \mathbb{T} \mid \mathbb{T} \cdot s \mid t \cdot \mathbb{S} \\
\text{(Substitution Contexts)} & \mathbb{L} ::= \square \mid \mathbb{L}[x \setminus t] \\
\text{(Repl./Ren. Contexts)} & \mathbb{R} ::= \square \mid \mathbb{R}[\alpha \setminus^{\alpha'} s] \mid \mathbb{R}[\alpha \setminus \beta]
\end{array}$$

Terms are those of the  $\lambda\mu$ -calculus enriched with **explicit substitutions (ES)** of the form  $[x \setminus u]$ . The subterm  $u$  in a term of the form  $tu$  (resp. the ES  $t[x \setminus u]$ ) is called the **argument** of the application (resp. substitution). Commands are enriched with **explicit replacements** and **explicit renamings**: the former are of the form  $[\alpha \setminus^{\alpha'} s]$  (where the stack  $s$  is to be considered as list of arguments, as *e.g.* in [Her94]), while the latter are of the form  $[\alpha \setminus \beta]$ , where the name  $\alpha$  is supposed to be substituted by  $\beta$ . An important remark is that one would be tempted, in principle, to consider only one constructor to capture at the same time explicit renamings and explicit replacements, in such a way that the former ones result as a special case (*empty* stacks) of the latter (arbitrary stacks). However, both behave differently (see the forthcoming definition of implicit replacement), and this distinction is crucial to guarantee our bisimulation result (*cf.* Sec. 7). They are thus denoted with different constructors, and stacks inside explicit renamings are required to be *non-empty*.

Stacks can be concatenated as expected (denoted  $s \cdot s'$  by abuse of notation): if  $s = t_0 \cdot \dots \cdot t_n$ , then  $s \cdot s' \triangleq t_0 \cdot \dots \cdot t_n \cdot s'$ ; where  $\_ \cdot \_$  is right associative. Given a term  $u$ , we use the abbreviation  $u :: s$  for the term resulting from the application of  $u$  to all the terms of the stack  $s$ , *i.e.* if  $s = t_0 \cdot \dots \cdot t_n$ , then  $u :: s \triangleq u t_0 \dots t_n$ . Recall that application is left associative, so that this operation also is; hence  $u :: s :: s'$  means  $(u :: s) :: s'$ .

**Free and bound variables** of  $\Lambda M$ -objects are defined as expected, having the new explicit operators binding symbols: *i.e.*  $\text{fv}(t[x \setminus u]) \triangleq (\text{fv}(t) \setminus \{x\}) \cup \text{fv}(u)$  and  $\text{bv}(t) = \text{bv}(t) \cup \text{bv}(u) \cup \{x\}$ . Concerning **free and bound names** of  $\Lambda M$ -objects, we remark in particular that the occurrences of  $\alpha'$  in the explicit replacements  $c[\alpha \setminus^{\alpha'} s]$  are not bound:

$$\begin{array}{ll}
\text{fn}(c[\alpha \setminus^{\alpha'} s]) \triangleq (\text{fn}(c) \setminus \{\alpha\}) \cup \text{fn}(s) \cup \{\alpha'\} & \text{bn}(c[\alpha \setminus^{\alpha'} s]) \triangleq \text{bn}(c) \cup \text{bn}(s) \cup \{\alpha\} \\
\text{fn}(c[\alpha \setminus \beta]) \triangleq (\text{fn}(c) \setminus \{\alpha\}) \cup \{\beta\} & \text{bn}(c[\alpha \setminus \beta]) \triangleq \text{bn}(c) \cup \{\alpha\}
\end{array}$$

We work, as usual, modulo  $\alpha$ -conversion so that bound variables and names can be renamed. Thus *e.g.*  $x[x \setminus u] =_{\alpha} y[y \setminus u]$ ,  $([\gamma]x)[\gamma \setminus^{\alpha} u] =_{\alpha} ([\beta]x)[\beta \setminus^{\alpha} u]$  and  $([\gamma]x)[\gamma \setminus \alpha] =_{\alpha} ([\beta]x)[\beta \setminus \alpha]$ . In particular, we assume by  $\alpha$ -conversion that  $x \notin \text{fv}(u)$  in  $t[x \setminus u]$ ,  $\alpha \notin \text{fn}(s)$  in  $c[\alpha \setminus^{\alpha'} s]$  and  $\alpha \neq \beta$  in  $c[\alpha \setminus \beta]$ .

The notions of free and bound variables and names are extended to contexts by defining  $\text{fv}(\square) = \text{fv}(\square) = \text{fn}(\square) = \text{fn}(\square) = \emptyset$ . Then *e.g.*  $x$  is bound in  $\lambda x.\square$ ,  $(\lambda x.x)\square$ , and  $\alpha$  is

bound in  $\square\{\alpha \setminus^{\alpha'} s\}$ . Bound names whose scope includes a hole  $\square$  or  $\square$  cannot be  $\alpha$ -renamed. An object  $o$  is **free for a context**  $\mathbf{O}$ , written  $\text{fc}(o, \mathbf{O})$ , if  $\text{fv}(o)$  are not captured by binders of  $\mathbf{O}$  in  $\mathbf{O}\langle o \rangle$ . Thus *e.g.*  $\text{fc}(zy, \lambda x. \square[x' \setminus w])$  and  $\text{fc}(x, (\lambda x. x) \square)$  hold but  $\text{fc}(xy, \lambda x. \square)$  does not hold. This notion is naturally extended to sets of objects, *i.e.*  $\text{fc}(\mathcal{S}, \mathbf{O})$  iff  $\text{fc}(o, \mathbf{O})$  holds for every  $o \in \mathcal{S}$ .

**4.2. Substitution, Renaming and Replacement in  $\Lambda M$ .** The **application of the implicit substitution**  $\{x \setminus u\}$  to an  $\Lambda M$ -object  $o$  is defined as the natural extension of that of the  $\lambda\mu$ -calculus (Sec. 3.1). We now detail the applications of implicit replacements and renamings, which are more subtle. The **application of the implicit replacement**  $\{\alpha \setminus^{\alpha'} s\}$  to an  $\Lambda M$ -object, is defined as the following capture-avoiding operation (recall that by  $\alpha$ -conversion  $\alpha \notin \text{fn}(s)$  and  $\alpha \neq \alpha'$ ):

$$\begin{array}{ll}
x\{\alpha \setminus^{\alpha'} s\} & \triangleq x \\
(tu)\{\alpha \setminus^{\alpha'} s\} & \triangleq t\{\alpha \setminus^{\alpha'} s\}u\{\alpha \setminus^{\alpha'} s\} \\
(\lambda x.t)\{\alpha \setminus^{\alpha'} s\} & \triangleq \lambda x.t\{\alpha \setminus^{\alpha'} s\} & x \notin s \\
(\mu\beta.c)\{\alpha \setminus^{\alpha'} s\} & \triangleq \mu\beta.c\{\alpha \setminus^{\alpha'} s\} & \beta \notin s, \beta \neq \alpha' \\
(t[x \setminus u])\{\alpha \setminus^{\alpha'} s\} & \triangleq (t\{\alpha \setminus^{\alpha'} s\})[x \setminus u\{\alpha \setminus^{\alpha'} s\}] & x \notin s \\
([\alpha]t)\{\alpha \setminus^{\alpha'} s\} & \triangleq [\alpha'](t\{\alpha \setminus^{\alpha'} s\}) :: s \\
([\beta]t)\{\alpha \setminus^{\alpha'} s\} & \triangleq [\beta]t\{\alpha \setminus^{\alpha'} s\} & \alpha \neq \beta \\
(c[\gamma \setminus^{\alpha} s'])\{\alpha \setminus^{\alpha'} s\} & \triangleq (c\{\alpha \setminus^{\alpha'} s\})[\gamma \setminus^{\alpha'} s'\{\alpha \setminus^{\alpha'} s\}] \cdot s & \gamma \notin s, \gamma \neq \alpha' \\
(c[\gamma \setminus^{\beta} s'])\{\alpha \setminus^{\alpha'} s\} & \triangleq (c\{\alpha \setminus^{\alpha'} s\})[\gamma \setminus^{\beta} s'\{\alpha \setminus^{\alpha'} s\}] & \alpha \neq \beta, \gamma \notin s, \gamma \neq \alpha' \\
(c[\gamma \setminus \alpha])\{\alpha \setminus^{\alpha'} s\} & \triangleq (c\{\alpha \setminus^{\alpha'} s\})[\gamma \setminus^{\beta} s][\beta \setminus \alpha'] & \beta \text{ fresh}, \gamma \notin s, \gamma \neq \alpha' \\
(c[\gamma \setminus \beta])\{\alpha \setminus^{\alpha'} s\} & \triangleq (c\{\alpha \setminus^{\alpha'} s\})[\gamma \setminus \beta] & \alpha \neq \beta, \gamma \notin s, \gamma \neq \alpha' \\
(t \cdot s')\{\alpha \setminus^{\alpha'} s\} & \triangleq t\{\alpha \setminus^{\alpha'} s\} \cdot s'\{\alpha \setminus^{\alpha'} s\}
\end{array}$$

Most of the cases in the definition above are straightforward, we only comment on the interesting ones. When the implicit replacement affects an explicit replacement, *i.e.* in the case  $(c[\gamma \setminus^{\alpha} s'])\{\alpha \setminus^{\alpha'} s\}$ , the explicit replacement is *blocking* the implicit replacement operation over  $\gamma$ . This means that  $\gamma$  and  $\alpha$  denote the same command, but the arguments of  $\alpha$  must not be passed to  $\gamma$  yet. This is why the resulting explicit replacement will accumulate all these arguments in a *stack*, which explains the need for this data structure inside explicit replacements. Also, when an implicit replacement affects an explicit renaming, *i.e.* in the case  $(c[\gamma \setminus \alpha])\{\alpha \setminus^{\alpha'} s\}$ , the explicit renaming  $[\gamma \setminus \alpha]$  is *blocking* the implicit replacement operation, as in the previous case. In this situation, the need to pass the arguments  $s$  to the command  $\gamma$  is *saved* through the creation of a new explicit replacement  $[\gamma \setminus^{\beta} s]$  over a fresh name  $\beta$  that, in turn, is explicitly renamed to  $\alpha'$  (*i.e.* the replacement name over  $\alpha$ ). Examples of these operations are  $([\alpha]x)\{\alpha \setminus^{\gamma} y_0 \cdot y_1\} = [\gamma]x y_0 y_1$ , and  $(([\alpha]x)[\beta \setminus^{\alpha} z_0])\{\alpha \setminus^{\gamma} y_0\} = ([\gamma]x y_0)[\beta \setminus^{\gamma} z_0 \cdot y_0]$ , while  $(([\alpha]x)[\beta \setminus \alpha])\{\alpha \setminus^{\gamma} y_0 \cdot y_1\} = ([\gamma]x y_0 y_1)[\beta \setminus^{\gamma'} y_0 \cdot y_1][\gamma' \setminus \gamma]$ .

The application of the implicit renaming  $\{\alpha \setminus \beta\}$  to an  $\Lambda M$ -object is defined as:

$$\begin{aligned}
x\{\alpha \setminus \beta\} &\triangleq x \\
(tu)\{\alpha \setminus \beta\} &\triangleq t\{\alpha \setminus \beta\}u\{\alpha \setminus \beta\} \\
(\lambda x.t)\{\alpha \setminus \beta\} &\triangleq \lambda x.t\{\alpha \setminus \beta\} \\
(\mu\gamma.c)\{\alpha \setminus \beta\} &\triangleq \mu\gamma.c\{\alpha \setminus \beta\} && \gamma \neq \beta \\
(t[x \setminus u])\{\alpha \setminus \beta\} &\triangleq (t\{\alpha \setminus \beta\})[x \setminus u\{\alpha \setminus \beta\}] \\
([\alpha]t)\{\alpha \setminus \beta\} &\triangleq [\beta]t\{\alpha \setminus \beta\} \\
([\delta]t)\{\alpha \setminus \beta\} &\triangleq [\delta]t\{\alpha \setminus \beta\} && \alpha \neq \delta \\
(c[\gamma \setminus^\alpha s])\{\alpha \setminus \beta\} &\triangleq (c\{\alpha \setminus \beta\})[[\gamma \setminus^\beta s\{\alpha \setminus \beta\}]] && \gamma \neq \beta \\
(c[[\gamma \setminus^\delta s]])\{\alpha \setminus \beta\} &\triangleq (c\{\alpha \setminus \beta\})[[\gamma \setminus^\delta s\{\alpha \setminus \beta\}]] && \alpha \neq \delta, \gamma \neq \beta \\
(c[\gamma \setminus \alpha])\{\alpha \setminus \beta\} &\triangleq (c\{\alpha \setminus \beta\})[\gamma \setminus \beta] && \gamma \neq \beta \\
(c[\gamma \setminus \delta])\{\alpha \setminus \beta\} &\triangleq (c\{\alpha \setminus \beta\})[\gamma \setminus \delta] && \gamma \neq \beta \\
(t \cdot s)\{\alpha \setminus \beta\} &\triangleq t\{\alpha \setminus \beta\} \cdot s\{\alpha \setminus \beta\}
\end{aligned}$$

The three operations  $\{x \setminus u\}$ ,  $\{\{\alpha \setminus^{\alpha'} s\}\}$  and  $\{\alpha \setminus \beta\}$  are extended to contexts as expected. The table below summarises the notions of implicit and explicit operations introduced above:

$t\{x \setminus u\}$	Implicit Substitution	Substitute a term for a variable
$t[x \setminus u]$	Explicit Substitution	
$c\{\{\alpha \setminus^{\alpha'} s\}\}$	Implicit Replacement	Substitute a stack for a name
$c[\{\alpha \setminus^{\alpha'} s\}]$	Explicit Replacement	
$c\{\alpha \setminus \beta\}$	Implicit Renaming	Substitute a name for a name
$c[\alpha \setminus \beta]$	Explicit Renaming	

**4.3. Reduction Semantics of  $\Lambda M$ .** The reduction semantics for  $\Lambda M$  will be presented in terms of reduction rules. With an eye placed on the upcoming notion of structural equivalence  $\simeq$ , we will classify these rules as performing mere reshuffling of symbols or performing more elaborate work. This classification is, for now, relegated to informal observation. It will be made precise once the connection is established between  $\Lambda M$  and proof-nets.

The first two reduction rules for  $\Lambda M$  arise from the simple decomposition of  $\beta$ -reduction discussed in the introduction:

$$\begin{aligned}
L\langle \lambda x.t \rangle u &\mapsto_{\text{dB}} L\langle t[x \setminus u] \rangle \\
t[x \setminus u] &\mapsto_{\text{S}} t\{x \setminus u\}
\end{aligned}$$

where  $\mapsto_{\text{dB}}$  is constrained by the condition  $\text{fc}(u, L)$ . These have already been studied in the literature, where, as discussed in the introduction, they suffice to be able to state and prove a strong bisimulation result for the intuitionistic case (*cf.* Thm. 1.2). As mentioned there, the first is a simple reshuffling of symbols, which we thus consider to be *plain* computation, but the second is not. It may substitute  $u$  deep within a term or possibly even erase  $u$ , involving the use of exponential cuts in its proof-net semantics and hence considered *meaningful* computation. Note that  $\text{dB}$  operates *at a distance* [AK12a], in the sense that an abstraction and its argument may be separated by an arbitrary number of explicit substitutions.

The next reduction rules we consider arise from a more subtle decomposition of  $\mu$ -reduction. The third reduction rule for  $\Lambda M$  is:

$$L\langle \mu\alpha.c \rangle u \mapsto_{\text{dM}} L\langle \mu\alpha'.c[\{\alpha \setminus^{\alpha'} u\}] \rangle$$



subject to the constraint  $\text{fc}(u, L)$ , and  $\alpha'$  is a fresh name (*i.e.*  $\alpha' \neq \alpha$ ,  $\alpha' \notin c$  and  $\alpha' \notin L$ ). This rule is similar in nature to  $\text{dB}$  in the sense that it fires a  $\mu$ -redex and may be seen to reshuffle symbols. In particular no replacement actually takes place since it introduces an explicit replacement. Rule  $\text{dM}$  is therefore also considered to perform *plain* computation. Note that  $\text{dM}$  operates at a distance too. With the introduction of  $\text{dM}$  our notation for explicit replacement can now be justified. Indeed, following Parigot [Par92], one might be tempted to rephrase the reduct of  $\text{dM}$  with a binary constructor, writing  $L\langle\mu\alpha.c\llbracket\alpha \setminus u\rrbracket\rangle$  on the right-hand side of the rule  $\text{dM}$ . This would be incorrect since all free occurrences of  $\alpha$  in  $c$  are bound by the  $\alpha$  in  $c\llbracket\alpha \setminus u\rrbracket$  which renders the role of “ $\mu\alpha$ ” meaningless.

We have not yet finished introducing the reduction rules for  $\Lambda M$ . All that is missing is a means to execute the explicit replacements introduced by  $\text{dM}$ . The natural candidate for executing replacement would be to have just one reduction rule, namely:  $c\llbracket\alpha \setminus^{\alpha'} s\rrbracket \mapsto_{\text{R}}$   $c\{\{\alpha \setminus^{\alpha'} s\}\}$ . However, this is too coarse grained to be able to obtain our strong bisimulation result (*cf.* Sec. 7) and therefore explicit replacement will be implemented not by one, but rather by multiple reduction rules. In particular, these resulting reduction rules can be easily categorised into *plain* and *meaningful* behavior, according to our proof-nets semantics to be presented shortly (*cf.* Sec 5). We will next present these rules gradually. We may avoid proof-net details for now by breaking down the presentation in terms of a series of linearity conditions, namely whether  $\alpha$  occurs linearly in  $c$  or not and, if so, exactly where in  $c$  it occurs. The first of these rules is the case where  $\alpha$  does not occur linearly in  $c$  and results in the fourth reduction rule for  $\Lambda M$ :

$$c\llbracket\alpha \setminus^{\alpha'} s\rrbracket \mapsto_{\text{Rn1}} c\{\{\alpha \setminus^{\alpha'} s\}\} \quad \text{fn}_{\alpha}(c) \neq 1$$

We still have to address the case where there is a unique occurrence of  $\alpha$  in  $c$ . Replacing that unique occurrence is not necessarily an act of mere reshuffling; that depends on where the occurrence of  $\alpha$  appears in  $c$ . If  $\alpha$  appears inside the argument of an application, an explicit substitution or an explicit replacement, then this single occurrence of  $\alpha$  could be further erased or duplicated. One might say replacing  $s$  performs *hereditarily* meaningful work. Let us make this more precise. If  $\alpha$  occurs exactly once in  $c$ , then the left-hand side  $c\llbracket\alpha \setminus^{\alpha'} s\rrbracket$  of the reduction rule  $\text{Rn1}$  must have one of the following forms:

$$\begin{aligned} & \mathbf{C}\langle[\alpha]t\rangle\llbracket\alpha \setminus^{\alpha'} s\rrbracket \\ & \mathbf{C}\langle c'[\beta \setminus^{\alpha} s']\rangle\llbracket\alpha \setminus^{\alpha'} s\rrbracket \\ & \mathbf{C}\langle c'[\beta \setminus \alpha]\rangle\llbracket\alpha \setminus^{\alpha'} s\rrbracket \end{aligned}$$

where the unique free occurrence of  $\alpha$  in  $c$  has been highlighted in bold and  $\alpha$  does not occur in any of  $\mathbf{C}$ ,  $t$ ,  $c'$ ,  $s'$ . These determine the following three instances of the reduction rule  $c\llbracket\alpha \setminus^{\alpha'} s\rrbracket \mapsto_{\text{R}} c\{\{\alpha \setminus^{\alpha'} s\}\}$  with  $\text{fn}_{\alpha}(c) = 1$ :

$$\begin{aligned} \mathbf{C}\langle[\alpha]t\rangle\llbracket\alpha \setminus^{\alpha'} s\rrbracket & \mapsto_{\text{Name}} \mathbf{C}\langle[\alpha']t :: s\rangle & \alpha \notin \mathbf{C}, \alpha \notin t \\ \mathbf{C}\langle c'[\beta \setminus^{\alpha} s']\rangle\llbracket\alpha \setminus^{\alpha'} s\rrbracket & \mapsto_{\text{Comp}} \mathbf{C}\langle c'[\beta \setminus^{\alpha'} s' \cdot s]\rangle & \alpha \notin \mathbf{C}, \alpha \notin c', \alpha \notin s' \\ \mathbf{C}\langle c'[\beta \setminus \alpha]\rangle\llbracket\alpha \setminus^{\alpha'} s\rrbracket & \mapsto_{\text{sWap}} \mathbf{C}\langle c'[\beta \setminus^{\gamma} s][\gamma \setminus \alpha']\rangle & \gamma \text{ fresh}, \alpha \notin \mathbf{C}, \alpha \notin c' \end{aligned}$$

The first rule applies the explicit replacement when finding the (only) occurrence of the name  $\alpha$ ; the second rule composes the explicit replacements by concatenating their respective stacks; while the third one *swaps* the explicit replacement with the explicit renaming, because there are no other occurrences of the name  $\alpha$  in the command. As mentioned above, we would like to further identify the case when  $\alpha$  appears inside the argument of an application, an explicit substitution or an explicit replacement in each of these reduction rules. The ones





**Definition 4.1.** *Reduction in the  $\Lambda M$ -calculus is given by the following reduction rules closed under arbitrary contexts:*

$$\begin{array}{lll}
L\langle \lambda x.t \rangle u & \mapsto_{\text{dB}} & L\langle t[x \setminus u] \rangle & \text{fc}(u, L) \\
t[x \setminus u] & \mapsto_{\text{S}} & t\{x \setminus u\} & \\
L\langle \mu \alpha.c \rangle u & \mapsto_{\text{dM}} & L\langle \mu \alpha'.c[\alpha \setminus \alpha' u] \rangle & \text{fc}(u, L), \alpha' \text{ fresh} \\
\text{LCC}\langle [\alpha] t \rangle [\alpha \setminus \alpha' s] & \mapsto_{\text{N}} & \text{LCC}\langle [\alpha'] t :: s \rangle & \alpha \notin \text{LCC}, \alpha \notin t \\
\text{LCC}\langle c'[\beta \setminus \alpha s'] \rangle [\alpha \setminus \alpha' s] & \mapsto_{\text{C}} & \text{LCC}\langle c'[\beta \setminus \alpha' s' \cdot s] \rangle & \alpha \notin \text{LCC}, \alpha \notin c', \alpha \notin s' \\
\text{LCC}\langle c'[\beta \setminus \alpha] \rangle [\alpha \setminus \alpha' s] & \mapsto_{\text{W}} & \text{LCC}\langle c'[\beta \setminus \alpha s][\alpha \setminus \alpha'] \rangle & \alpha \notin \text{LCC}, \alpha \notin c' \\
\text{C}\langle [\alpha] t \rangle [\alpha \setminus \alpha' s] & \mapsto_{\text{Nn1}} & \text{C}\langle [\alpha'] t :: s \rangle & \text{C non linear}, \alpha \notin \text{C}, \alpha \notin t \\
\text{C}\langle c'[\beta \setminus \alpha s'] \rangle [\alpha \setminus \alpha' s] & \mapsto_{\text{Cn1}} & \text{C}\langle c'[\beta \setminus \alpha' s' \cdot s] \rangle & \text{C non linear}, \alpha \notin \text{C}, \alpha \notin c', \alpha \notin s' \\
\text{C}\langle c'[\beta \setminus \alpha] \rangle [\alpha \setminus \alpha' s] & \mapsto_{\text{Wn1}} & \text{C}\langle c'[\beta \setminus \alpha s][\gamma \setminus \alpha'] \rangle & \text{C non linear}, \gamma \text{ fresh}, \alpha \notin \text{C}, \alpha \notin c' \\
c[\alpha \setminus \alpha' s] & \mapsto_{\text{Rn1}} & c\{\alpha \setminus \alpha' s\} & \text{fn}_\alpha(c) \neq 1
\end{array}$$

Note that  $o \rightarrow_{\text{R}} o'$  iff  $o$  reduces to  $o'$  using the reduction obtained from the union of the rules  $\mapsto_{\text{N}} \cup \mapsto_{\text{C}} \cup \mapsto_{\text{W}} \cup \mapsto_{\text{Nn1}} \cup \mapsto_{\text{Cn1}} \cup \mapsto_{\text{Wn1}} \cup \mapsto_{\text{Rn1}}$ .

We can then say that the  $\Lambda M$ -calculus refines the  $\lambda\mu$ -calculus by decomposing  $\beta$  and  $\mu$  in more atomic steps.

**Lemma 4.2.** *Let  $o \in \mathcal{O}_{\lambda\mu}$ . If  $o \rightarrow_{\lambda\mu} o'$ , then  $o \rightarrow_{\Lambda M} o'$ .*

*Proof.* By induction on  $o \rightarrow_{\lambda\mu} o'$ . □

As in the case of the  $\lambda\mu$ -calculus, the  $\Lambda M$ -calculus is confluent too.

**Theorem 4.3.** *The reduction relation  $\rightarrow_{\Lambda M}$  is confluent (CR).*

*Proof.* We first proof confluence of the  $\Lambda M$ -calculus. The proof uses the interpretation method [CHL96], by projecting the  $\Lambda M$ -calculus into a variant of the  $\lambda\mu$ -calculus with explicit renamings, which, in turn, is shown to be confluent. Then confluence of  $\Lambda M$  is obtained. Details in the Appendix A. □

**4.4. The Simply Typed  $\Lambda M$ -Calculus.** In this section we introduce a system with simple types for the  $\Lambda M$ -calculus, which extends the type system in [Par92] to our syntax with explicit operators. The set of **types**  $\mathcal{T}$  is essentially the same one introduced in Sec. 3.2, but we add **stack types** to type the stack constructors of  $\Lambda M$ :

$$\text{Stack Types } S ::= A \mid A \cdot S$$

The constructor type  $\cdot$  is to be understood as a non-commutative conjunction, which will be interpreted later as the tensor of linear logic (*cf.* Sec. 5). The role of a stack constructor is to accumulate arguments to be passed to a term typed with functional type, that is why we use the notation  $S \rightarrow B$  (which is not in the type grammar) as an abbreviation of the type  $A_1 \rightarrow \dots \rightarrow A_n \rightarrow B$ , where  $S = A_1 \cdot \dots \cdot A_n$ .

The **typing rules** of system  $\mathcal{E}$  for the  $\Lambda M$ -calculus are given by those of system  $\mathcal{M}$  (*cf.* Fig. 3) plus those in Fig. 5. These new rules type the new constructors introduced in the  $\Lambda M$ -calculus, and we consider a third class of **typing judgements**  $\Gamma \vdash s : S \mid \Delta$  for the stacks. Notice that any typing judgement for a term is in particular a typing judgement for a stack (having only one element), being in this way the base case of the inductive construction of stacks. Similarly to system  $\mathcal{M}$ , commands have no type, *cf.* rules (REPL)

$$\begin{array}{c}
\frac{\Gamma; (x : B)^{\leq 1} \vdash t : A \mid \Delta \quad \Gamma' \vdash u : B \mid \Delta'}{\Gamma \cup \Gamma' \vdash t[x \setminus u] : A \mid \Delta \cup \Delta'} \text{ (SUBS)} \\
\\
\frac{\Gamma \vdash c \mid \Delta; (\alpha : S \rightarrow B)^{\leq 1}; (\alpha' : B)^{\leq 1} \quad \Gamma' \vdash s : S \mid \Delta'; (\alpha' : B)^{\leq 1}}{\Gamma \cup \Gamma' \vdash c[\alpha \setminus^{\alpha'} s] \mid \Delta \cup \Delta'; \alpha' : B} \text{ (REPL)} \\
\\
\frac{\Gamma \vdash c \mid \Delta; (\alpha : A)^{\leq 1}; (\beta : A)^{\leq 1}}{\Gamma \vdash c[\alpha \setminus \beta] \mid \Delta; \beta : A} \text{ (REN)} \quad \frac{\Gamma \vdash t : A \mid \Delta \quad \Gamma' \vdash s : S \mid \Delta'}{\Gamma \cup \Gamma' \vdash t \cdot s : A \cdot S \mid \Delta \cup \Delta'} \text{ (STK)}
\end{array}$$

Figure 5: Additional Typing Rules of System  $\mathcal{E}$  for the  $\Lambda M$ -Calculus.

and (REN); while stack constructors are typed with stack types, *cf.* rule (STK), which are essentially heterogeneous lists, *i.e.* each component of the list can be typed with a different type. An interesting case is (REPL), which is a logical modus ponens rule, where the fresh variable  $\alpha'$  may, in principle, be already present in the name assignment of the command  $c$  or the stack  $s$ .

We use the generic notation  $\Gamma \vdash o : T \mid \Delta$  for the three kinds of typing judgements:  $o = t$  and  $T = A$  for terms;  $o = c$  and no type  $T$  for commands; and  $o = s$  and  $T = S$  for stacks. We use  $\pi \triangleright_{\mathcal{E}} \Gamma \vdash o : T \mid \Delta$  to indicate that the judgement  $\Gamma \vdash o : T \mid \Delta$  is derivable in  $\mathcal{E}$  by naming the derivation  $\pi$ .

System  $\mathcal{E}$  enjoys the following properties:

**Lemma 4.4** (Relevance). *Let  $o \in \mathbb{O}_{\Lambda M}$ . If  $\pi \triangleright_{\mathcal{E}} \Gamma \vdash o : T \mid \Delta$ , then  $\text{dom}(\Gamma) = \text{fv}(o)$  and  $\text{dom}(\Delta) = \text{fn}(o)$ .*

*Proof.* By induction on  $\pi$ . □

**Theorem 4.5** (Subject Reduction). *Let  $o \in \mathbb{O}_{\Lambda M}$ . If  $\pi \triangleright_{\mathcal{E}} \Gamma \vdash o : T \mid \Delta$  and  $o \rightarrow_{\Lambda M} o'$ , then there is  $\pi' \triangleright_{\mathcal{E}} \Gamma' \vdash o' : T \mid \Delta'$  such that  $\Gamma' \subseteq \Gamma$  and  $\Delta' \subseteq \Delta$ .*

*Proof.* By induction on  $o \rightarrow_{\Lambda M} o'$ , using relevance and appropriate lemmas for substitution and replacement. Details in Appendix B. □

## 5. POLARISED PROOF-NETS

Proof-nets [Gir87] are a geometric presentation of linear logic proofs. They abstract away from the irrelevant order of inference schemes and provide an elegant reading of cut-elimination as graph-transformation. *polarised linear logic* (PLL) [Lau02] arises from introducing polarities [Gir91, And90] into linear logic. Polarised linear logic formulae are defined as follows<sup>1</sup>, where  $\iota$  is assumed to be a propositional variable and  $\iota^{\perp}$  a negated propositional variable:

$$\begin{array}{ll}
\text{(Polarised Formulae)} & F ::= N \mid P \\
\text{(Negative Formulae)} & N ::= O \mid ?Q \\
\text{(Positive Formulae)} & P ::= Q \mid !O \\
\text{(Output Formulae)} & O ::= \iota \mid ?Q \wp O \\
\text{(Anti-Output Formulae)} & Q ::= \iota^{\perp} \mid !O \otimes Q
\end{array}$$

<sup>1</sup>We follow [Lau03].

$$\begin{array}{c}
\frac{}{\vdash O^\perp; O} \text{ (AX)} \quad \frac{\vdash \Gamma; N \quad \vdash \Delta; N^\perp}{\vdash \Gamma; \Delta} \text{ (CUT)} \quad \frac{\vdash \Gamma}{\vdash \Gamma; N} \text{ (W)} \\
\frac{\vdash \Gamma; N; N}{\vdash \Gamma; N} \text{ (C)} \quad \frac{\vdash \Gamma; ?Q; O}{\vdash \Gamma; ?Q \wp O} \text{ (\wp)} \quad \frac{\vdash \Gamma; !O \quad \vdash \Delta; Q}{\vdash \Gamma; \Delta; !O \otimes Q} \text{ (\otimes)} \\
\frac{\vdash \Gamma; Q}{\vdash \Gamma; ?Q} \text{ (?) } \quad \frac{\vdash O; O_1; \dots; O_n; ?Q_1; \dots; ?Q_m}{\vdash !O; O_1; \dots; O_n; ?Q_1; \dots; ?Q_m} \text{ (!)}
\end{array}$$

Figure 6: Sequent presentation of PLL

Negation is now extended to all formulae. The negation of  $F$ , denoted  $F^\perp$ , is defined as follows<sup>2</sup>:

$$\begin{aligned}
(\iota)^\perp &= \iota^\perp \\
(\iota^\perp)^\perp &= \iota \\
(?Q \wp O)^\perp &= !Q^\perp \otimes O^\perp \\
(?Q)^\perp &= !Q^\perp \\
(!O \otimes Q)^\perp &= ?O^\perp \wp Q^\perp \\
(!O)^\perp &= ?O^\perp
\end{aligned}$$

Note that negation is involutive (*i.e.*  $F^{\perp\perp} = F$ ). Formulae of the form  $?Q$  are called **Input Formulae**, while those of the form  $!O$  are called **Anti-Input Formulae**. The one-sided sequent presentation of PLL is given in Fig. 6. PLL extends the use of structural rules, usually defined only on  $?$  formulae, to negative formulae.

PLL is equipped with a graphical notion of proof called *polarised proof-nets* (PPN). Rather than presenting PPN in full generality together with their correctness criterion, we consider here the class of PPN that arise from the proofs constructed with the rules of Fig. 6. These PPN are correct by construction and are presented in Fig. 7. Remark that each wire is labelled with a formula. In particular, conclusions in boxes have only one bang formula  $!O$ , all others being negative formulae. When using an uppercase greek letter to label a wire, *e.g.*  $\Gamma$ , we mean that there are actually  $|\Gamma|$  wires, each one labelled with a formula in  $\Gamma$ . This abbreviated notation will be useful to define proof-net reduction and term translations.

**Definition 5.1. Structural equivalence**  $\equiv$  **for polarised proof-nets** is given by the closure by contexts of the identities in Fig. 8, where in the last two identities, the weakening node is assumed to be final (not bound by any other context).

The first equation specifies associativity of contraction nodes, the second one axiomatises permeability of contraction with respect to boxes, the third one specifies neutrality of weakening with respect to the contraction operation, the fourth one pushes final weakening nodes to the top level, and the fifth one removes final weakening nodes.

The **basic reduction relation for PPN**, denoted  $\rightarrow_{\text{PPN-}}$ , is given by the set of *cut elimination rules* appearing in Figures 9, 10 and 11 closed by all (proof-net) contexts. The formula  $F$  in the rule  $\mathcal{C}(ax)$  is meant to capture two specific instances of this rule, one where  $F$  is taken to be an  $O$ , and the other where it is taken to be  $O^\perp$ .

<sup>2</sup>By a slight abuse of notation, we use the “ $\perp$ ” symbol both for denoting negated atoms and for the negation of arbitrary formulae.

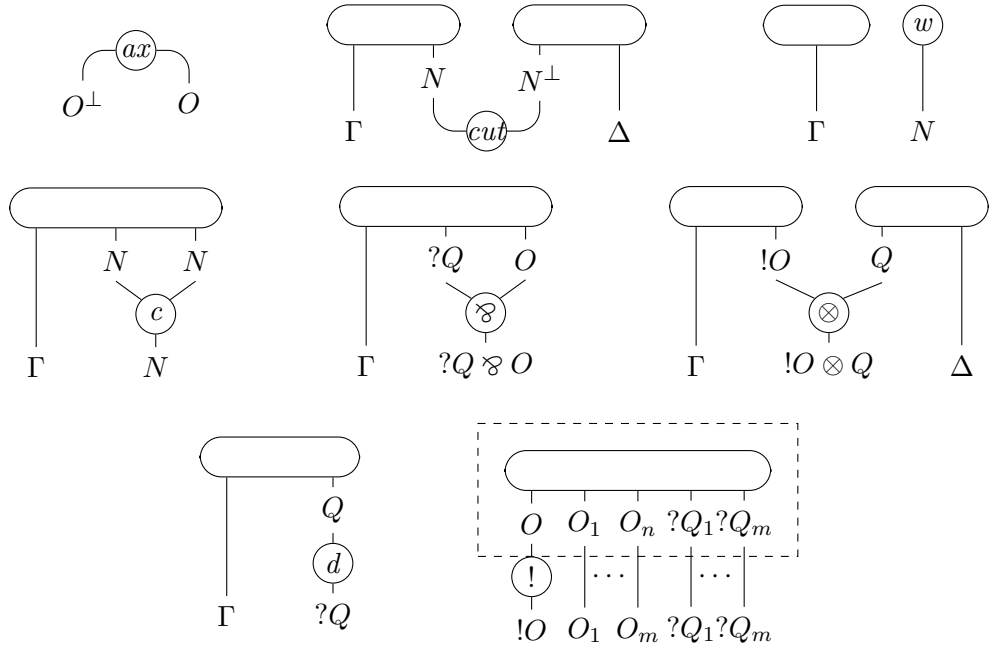

Figure 7: Inductively defined PPN

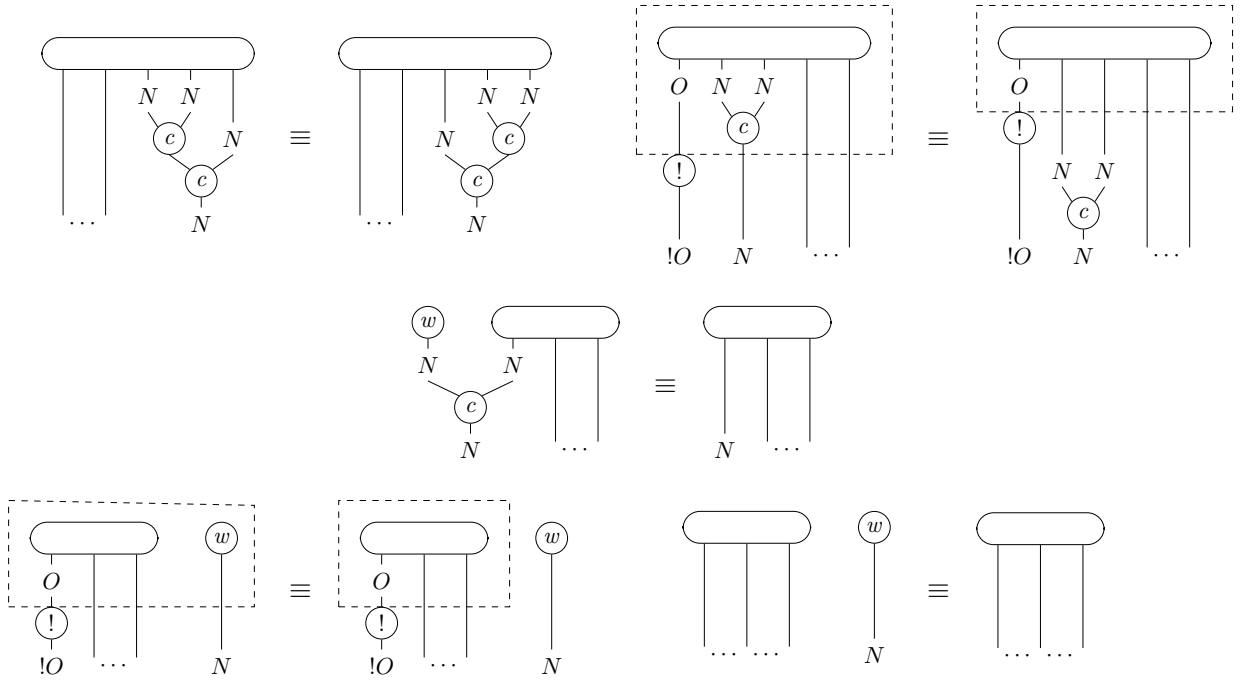

Figure 8: Identities for structural equivalence of polarised proof-nets

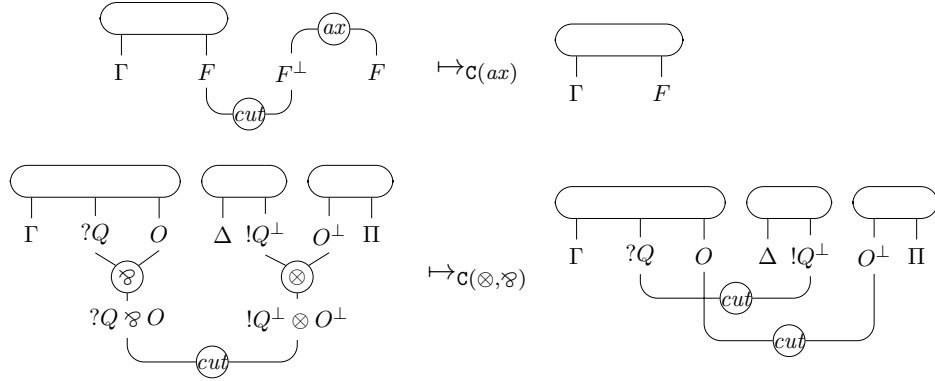

Figure 9: Cut elimination for PPN: multiplicative cuts (1/3)

**Definition 5.2.** *The reduction relation modulo for PPN, denoted  $\rightarrow_{\text{PPN}}$ , is given by  $\rightarrow_{\text{PPN-}}$  modulo the structural equivalence  $\equiv$ . More precisely,*

$$r \rightarrow_{\text{PPN}} r' \text{ iff } r \equiv o \rightarrow_{\text{PPN-}} o' \equiv r'$$

While the first two figures contain the standard cut elimination rules for MELL [Gir87], split into multiplicative and exponential rules respectively, the third one contains new rules specific to PPN [Lau03] which are also exponential. Rules in Fig. 11 deal with cuts between weakening/contraction/box and  $\otimes$ -trees, which are recursive structures whose base case is an axiom, and whose inductive case are formed by internal  $\otimes$ -nodes whose premises are a box and a  $\otimes$ -tree.

Remark that  $\mathbf{C}(\otimes, w)$ ,  $\mathbf{C}(\otimes, c)$  and  $\mathbf{C}(\otimes, !)$  are similar to  $\mathbf{C}(!, w)$ ,  $\mathbf{C}(!, c)$  and  $\mathbf{C}(!, !)$  respectively, if one considers  $\otimes$ -trees as boxes.

The reduction relation  $\rightarrow_{\text{PPN}}$  is confluent (CR) [Lau03, Cor. 14] and strongly normalising (SN) [Lau03, Cor. 15]. Moreover, the reduction relation resulting from considering only the subset of rules  $\{\mathbf{C}(ax), \mathbf{C}(\otimes, \otimes)\}$  is also CR and SN, and their (unique) normal forms are called *multiplicative normal forms*. This is used below to define the translation of the typed objects of the  $\Lambda M$ -calculus into PPN.

## 6. TRANSLATION TO PROOF-NETS

This section presents a translation of  $\Lambda M$ -objects to polarised proof-nets, which is an extension of that introduced in [Lau03] for  $\lambda\mu$ -objects.

The translation is defined over simply typed objects because they are, thanks to the Curry–Howard isomorphism, witnesses of the proofs of theorems of classical logic, and they are in this sense, closely related to PPN.

We start by translating the set of types  $\mathcal{T}$  into polarised formulae, and more precisely, into output formulae. One feature of particular interest is that it is possible to translate classical logic into PLL by interpreting  $A \rightarrow B$  as  $?A^\perp \wp B$ , obtaining a translation which is a straightforward extension of that from intuitionistic logic to PLL, thus, in particular, capturing the translation from  $\lambda$ -calculus to PLL. In fact, this translation extends the one from intuitionistic logic to standard, *i.e.* non-polarised, linear logic. Indeed, following

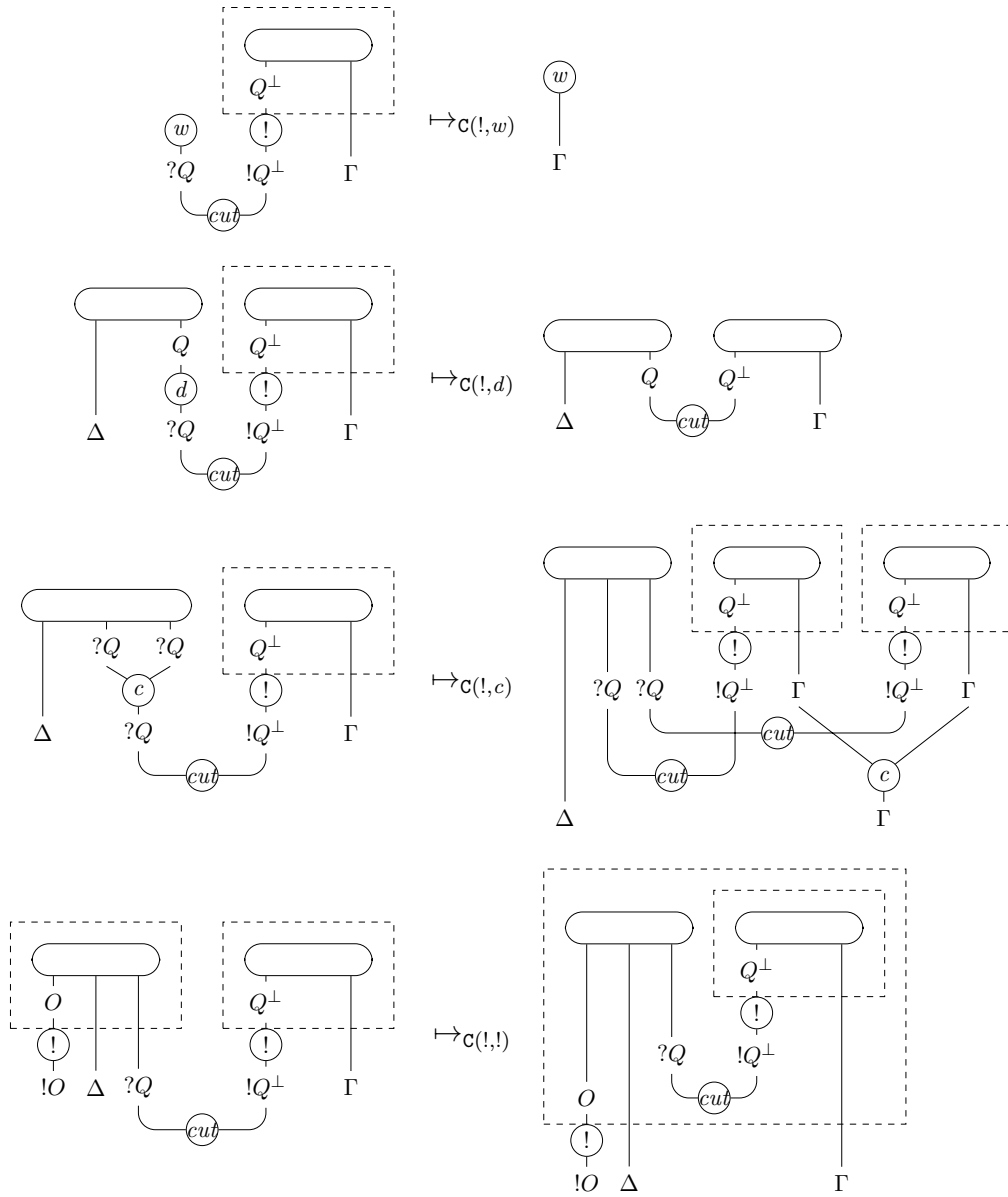

Figure 10: Cut elimination for PPN: exponential cuts for ! (2/3)

Girard’s translation of classical formulae, one may interpret the simple types from Sec. 4.4 as PLL types:

**Definition 6.1.** *The translation of a simple type  $A$  into a polarised output formula, written  $A^\diamond$ , follows Girard’s translation of classical formulae, and is inductively defined as follows:*

$$\begin{aligned} \iota^\diamond &\triangleq \iota \\ (A \rightarrow B)^\diamond &\triangleq ?(A^{\diamond\perp}) \wp B^\diamond \end{aligned}$$

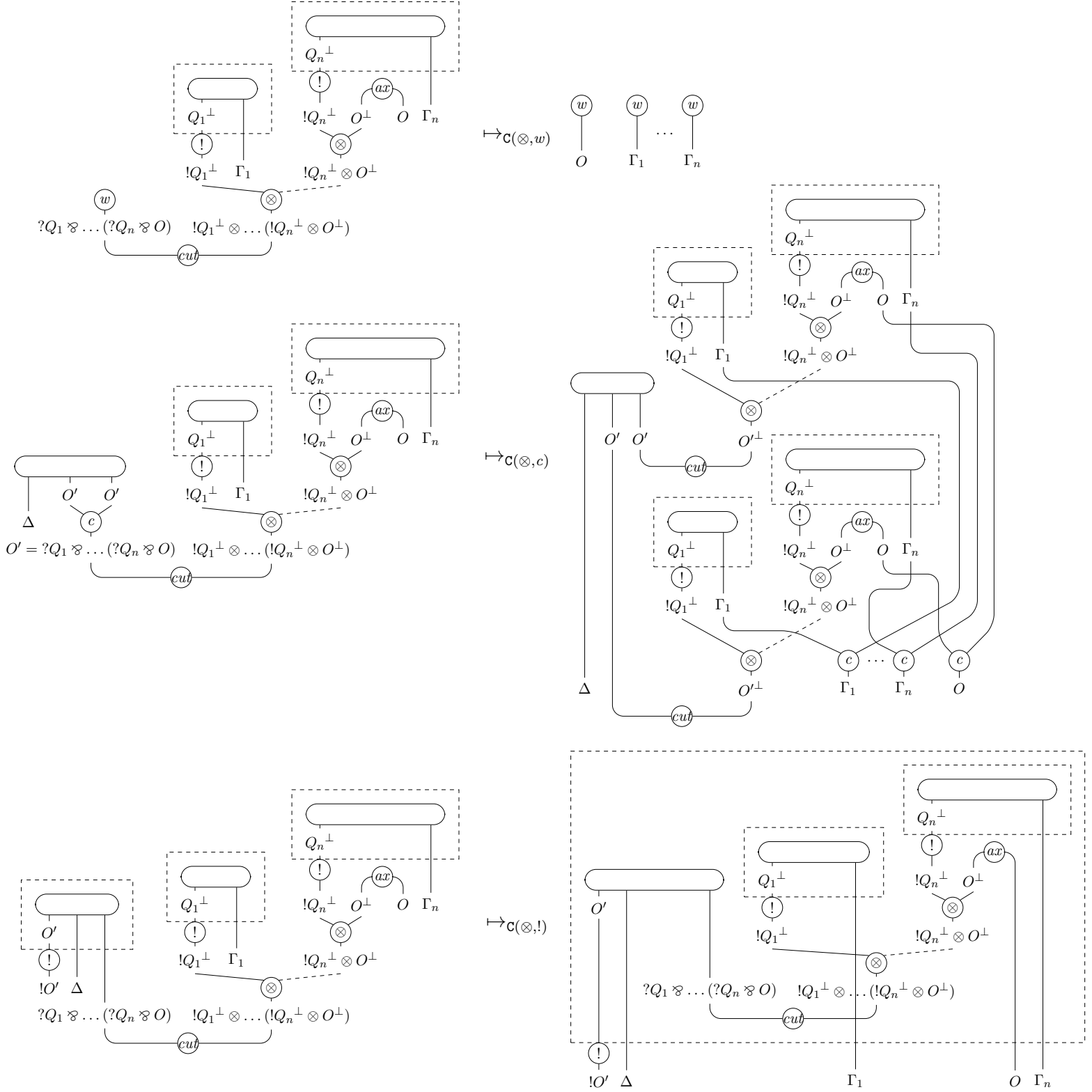

Figure 11: Cut elimination for PPN: exponential cuts for  $\otimes$  (3/3)



This translation is extended to stack types by considering a simple type  $B$  as an additional parameter of the translation, it represents the codomain of the function consuming the stack (cf. rule (REPL)).

**Definition 6.2.** *The translation of a stack type  $S$  relative to a simple type  $B$  into a polarised output formula, is defined as  $S_B^\diamond \triangleq (S \rightarrow B)^\diamond$  (introduced in Sec. 4.4).*

We define the translation of contexts as well: if  $\Gamma = x_1 : A_1; \dots; x_n : A_n$  and  $\Delta = \alpha_1 : B_1; \dots; \alpha_m : B_m$ , then  $\Gamma^\diamond = A_1^\diamond; \dots; A_n^\diamond$  and  $\Delta^\diamond = B_1^\diamond; \dots; B_m^\diamond$ . We use the abbreviated notation  $?( \Gamma^{\diamond\perp} )$  for  $?(A_1^{\diamond\perp}); \dots; ?(A_n^{\diamond\perp})$ .

The forthcoming translation of (typed)  $\Lambda M$ -objects to polarised proof-nets is defined by induction on typing derivations. Given  $\pi \triangleright_{\mathcal{M}} \Gamma \vdash o : T \mid \Delta$ , the resulting polarised proof-net contains in particular a conclusion for each formula in  $?( \Gamma^{\diamond\perp} )$ , for each formula in  $\Delta^\diamond$ , and for  $T^\diamond$ . We add a labelling to each conclusion in the resulting proof-net: the corresponding variable is used as label for formulae in  $\Gamma$  and the corresponding name is used as label for formulae in  $\Delta$ . We write a variable/name which is erased during some inductive step of the translation, between parentheses. The conclusion  $T^\diamond$  is said to be **distinguished** and is the only one that has no name. The distinguished conclusion for  $T^\diamond$  is written with  $\rightarrow$  and results in an output formula. The distinguished conclusion of the inductive step (if it exists) is written with  $\dashv$ , denoting that this wire is no longer distinguished. Proof-net equality takes both variable labels and name labels into account. In particular, we would like the translation of the type derivations  $x : A \vdash x : A \mid \emptyset$  and  $y : A \vdash y : A \mid \emptyset$  (Def. 6.4), to result in different proof-nets. As mentioned above, labels between parenthesis are assumed to have been erased and hence are not taken into account in proof-net equality. Moreover, the type derivations for stacks are translated with respect to a simple type  $B$ . They too have a distinguished conclusion, as explained below. In summary:

- **(Terms)** A typing derivation  $\pi \triangleright_{\mathcal{E}} \Gamma \vdash t : A \mid \Delta$  is translated to a proof-net with conclusions  $?( \Gamma^{\diamond\perp} )$ ,  $A^\diamond$  and  $\Delta^\diamond$ , where  $A^\diamond$  (an output formula) is the distinguished one.
- **(Commands)** A typing derivation  $\pi \triangleright_{\mathcal{E}} \Gamma \vdash c \mid \Delta$  is translated to a proof-net with conclusions  $?( \Gamma^{\diamond\perp} )$  and  $\Delta^\diamond$ . There is no distinguished conclusion in this case.
- **(Stacks)** A typing derivation  $\pi \triangleright_{\mathcal{E}} \Gamma \vdash s : S \mid \Delta$  is translated, for every type  $B$ , into a polarised proof-net with conclusions  $?( \Gamma^{\diamond\perp} )$ ,  $(S \rightarrow B)^{\diamond\perp}$ ,  $B^\diamond$  and  $\Delta^\diamond$ , where  $(S \rightarrow B)^{\diamond\perp}$  (anti-output formula) is the distinguished conclusion. The parameter  $B$  in the translation of stacks corresponds to the codomain of the functional type that consumes the stack.

**Remark 6.3.** *In all the type derivations based on two different premises, the translation adds contractions nodes for sharing common variables and names, but we omit these contraction nodes in the figures to make them more readable. Moreover, we only draw the wires that actively participate in the construction, thus omitting those conclusions of the obtained proof-nets which are not relevant for the translation itself.*

**Definition 6.4.** *The translation of a type derivation  $\pi \triangleright_{\mathcal{M}} \Gamma \vdash o : T \mid \Delta$  (for a term or a command) into a polarised proof-net, written  $\pi^\diamond$ , is defined inductively as follows:*

- (VAR): i.e.  $\pi \triangleright_{\mathcal{M}} x : A \vdash x : A \mid \emptyset$ . Then,

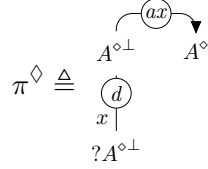

- (APP): i.e.  $\pi \triangleright_{\mathcal{M}} \Gamma \cup \Gamma' \vdash tu : B \mid \Delta \cup \Delta'$  with premises  $\pi_t \triangleright_{\mathcal{M}} \Gamma \vdash t : A \rightarrow B \mid \Delta$  and  $\pi_u \triangleright_{\mathcal{M}} \Gamma' \vdash u : A \mid \Delta'$ . Then,

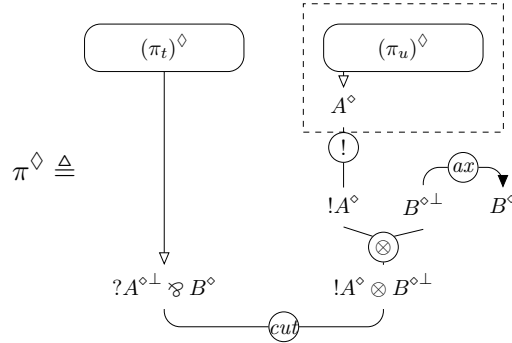

Recall that we add contraction nodes for all the conclusions corresponding to common variables/names of  $t$  and  $u$ .

- (ABS): i.e.  $\pi \triangleright_{\mathcal{M}} \Gamma \vdash \lambda x.t : A \rightarrow B \mid \Delta$  with premise  $\pi_t$ :
  - if  $x \in \text{fv}(t)$ , then  $\pi_t \triangleright_{\mathcal{M}} \Gamma; x : A \vdash t : B \mid \Delta$  and

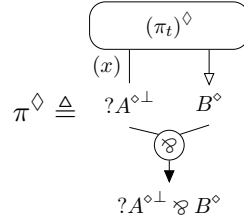

- if  $x \notin \text{fv}(t)$ , then  $\pi_t \triangleright_{\mathcal{M}} \Gamma \vdash t : B \mid \Delta$  with  $x \notin \text{dom}(\Gamma)$  and

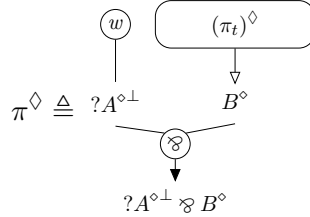

- (CONT): i.e.  $\pi \triangleright_{\mathcal{M}} \Gamma \vdash \mu \alpha.c : A \mid \Delta$  with premise  $\pi_c$ :
  - if  $\alpha \in \text{fn}(c)$ , then  $\pi_c \triangleright_{\mathcal{M}} \Gamma \vdash c \mid \Delta; \alpha : A$  and

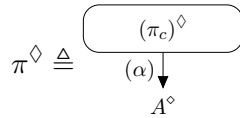

- if  $\alpha \notin \text{fn}(c)$ , then  $\pi_t \triangleright_{\mathcal{M}} \Gamma \vdash c \mid \Delta$  with  $\alpha \notin \text{dom}(\Delta)$  and

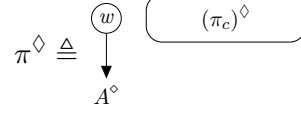

- (NAME): i.e.  $\pi \triangleright_{\mathcal{M}} \Gamma \vdash [\alpha]t \mid \Delta; \alpha : A$  with premise  $\pi_t$ :
  - if  $\alpha \in \text{fn}(t)$ , then  $\pi_t \triangleright_{\mathcal{M}} \Gamma \vdash t : A \mid \Delta; \alpha : A$  and

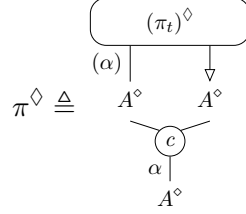

- if  $\alpha \notin \text{fn}(t)$ , then  $\pi_t \triangleright_{\mathcal{M}} \Gamma \vdash t : A \mid \Delta$  with  $\alpha \notin \text{dom}(\Delta)$  and

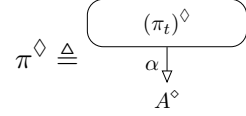

- (SUBS): i.e.  $\pi \triangleright_{\mathcal{E}} \Gamma \cup \Gamma' \vdash t[x \setminus u] : A \mid \Delta \cup \Delta'$  with premises  $\pi_t$  and  $\pi_u \triangleright_{\mathcal{E}} \Gamma' \vdash u : B \mid \Delta'$ :
  - if  $x \in \text{fv}(t)$ , then  $\pi_t \triangleright_{\mathcal{E}} \Gamma; x : B \vdash t : A \mid \Delta$  and

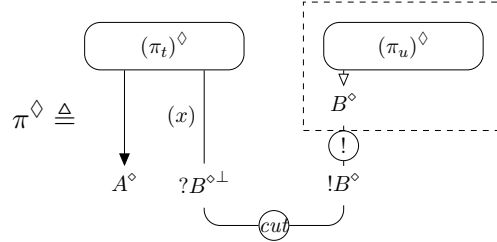

- if  $x \notin \text{fv}(t)$ , then  $\pi_t \triangleright_{\mathcal{E}} \Gamma \vdash t : A \mid \Delta$  con  $x \notin \text{dom}(\Gamma)$  and

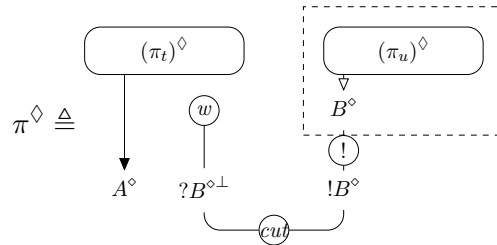

We recall that we add contraction nodes for all the conclusions corresponding to common variables/names of  $t$  and  $u$ .

- (REPL): i.e.  $\pi \triangleright_{\mathcal{E}} \Gamma \cup \Gamma' \vdash c[\alpha \setminus^{\alpha'} s] \mid \Delta \cup \Delta'; \alpha' : B$  with premises  $\pi_c$  and premise  $\pi_s \triangleright_{\mathcal{E}} \Gamma' \vdash s : S \mid \Delta'; (\alpha' : B)^{\leq 1}$ . We only detail here the cases where  $\alpha' \notin \text{fn}(s)$  and, as a consequence,  $\alpha' \notin \text{dom}(\Delta')$ :

- if  $\alpha, \alpha' \in \text{fn}(c)$ , then  $\pi_c \triangleright_{\mathcal{E}} \Gamma \vdash c \mid \Delta; \alpha : S \rightarrow B; \alpha' : B$  and

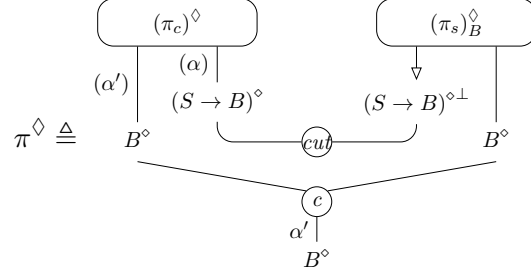

- if  $\alpha \in \text{fn}(c)$  and  $\alpha' \notin \text{fn}(c)$ , then  $\pi_c \triangleright_{\mathcal{E}} \Gamma \vdash c \mid \Delta; \alpha : S \rightarrow B$  with  $\alpha' \notin \text{dom}(\Delta)$  and

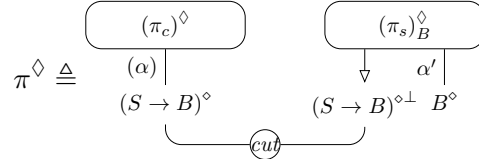

- if  $\alpha \notin \text{fn}(c)$  and  $\alpha' \in \text{fn}(c)$ , then  $\pi_c \triangleright_{\mathcal{E}} \Gamma \vdash c \mid \Delta; \alpha' : B$  with  $\alpha \notin \text{dom}(\Delta)$  and

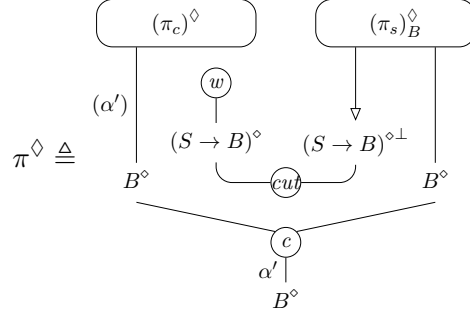

- if  $\alpha, \alpha' \notin \text{fn}(c)$ , then  $\pi_c \triangleright_{\mathcal{E}} \Gamma \vdash c \mid \Delta$  with  $\alpha, \alpha' \notin \text{dom}(\Delta)$  and

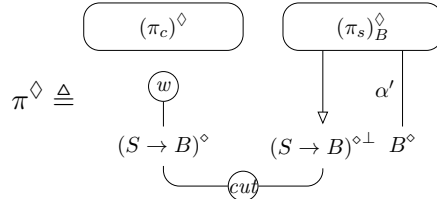

We recall that we add contraction nodes for all the conclusions corresponding to common variables/names of  $c$  and  $s$ . In the case  $\alpha' \in \text{fn}(s)$  we simply add an extra contraction node linked to the conclusion  $\alpha'$ .

- (REN): i.e.  $\pi \triangleright_{\mathcal{E}} \Gamma \vdash c[\alpha \setminus \beta] \mid \Delta; \beta : A$  with premise  $\pi_c$ :
  - if  $\alpha, \beta \in \text{fn}(c)$ , then  $\pi_c \triangleright_{\mathcal{E}} \Gamma \vdash c \mid \Delta; \alpha : A; \beta : A$  and

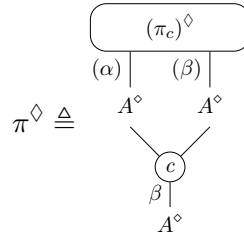

– if  $\alpha \in \text{fn}(c)$  and  $\beta \notin \text{fn}(c)$ , then  $\pi_c \triangleright_{\mathcal{E}} \Gamma \vdash c \mid \Delta; \alpha : A$  with  $\beta \notin \text{dom}(\Delta)$  and

$$\pi^{\diamond} \triangleq \frac{\boxed{(\pi_c)^{\diamond}}}{(\alpha) \mid \beta} \Big|_{A^{\circ}}$$

– if  $\alpha \notin \text{fn}(c)$  and  $\beta \in \text{fn}(c)$ , then  $\pi_c \triangleright_{\mathcal{E}} \Gamma \vdash c \mid \Delta; \beta : A$  with  $\alpha \notin \text{dom}(\Delta)$  and

$$\pi^{\diamond} \triangleq \frac{\boxed{(\pi_c)^{\diamond}}}{\beta \mid} \Big|_{A^{\circ}}$$

– if  $\alpha, \beta \notin \text{fn}(c)$ , then  $\pi_c \triangleright_{\mathcal{E}} \Gamma \vdash c \mid \Delta$ , with  $\alpha, \beta \notin \text{dom}(\Delta)$  and

$$\pi^{\diamond} \triangleq \frac{\textcircled{w} \quad \boxed{(\pi_c)^{\diamond}}}{\beta \mid} \Big|_{A^{\circ}}$$

where the translation of a type derivation  $\pi \triangleright_{\mathcal{E}} \Gamma \vdash s : A \mid \Delta$  into a polarised proof-net relative to a simple type  $B$ , written  $\pi_B^{\diamond}$ , is defined by induction on  $s$  as follows:

•  $s = t$ : i.e.  $\pi \triangleright_{\mathcal{E}} \Gamma \vdash t : A \mid \Delta$ . Then,

$$\pi^{\diamond} \triangleq \frac{\boxed{(\pi_t)^{\diamond}} \Big|_{A^{\circ}} \quad \textcircled{ax} \Big|_{B^{\circ\perp}}}{\otimes} \Big|_{(A \rightarrow B)^{\circ\perp}}$$

•  $s = t \cdot s'$ : i.e.  $\pi \triangleright_{\mathcal{E}} \Gamma \cup \Gamma' \vdash t \cdot s' : A \cdot S' \mid \Delta \cup \Delta'$  with premises  $\pi_t \triangleright_{\mathcal{E}} \Gamma \vdash t : A \mid \Delta$  and  $\pi_{s'} \triangleright_{\mathcal{E}} \Gamma' \vdash s' : S' \mid \Delta'$  by rule (STK). Then,

$$\pi^{\diamond} \triangleq \frac{\boxed{(\pi_t)^{\diamond}_{S' \rightarrow B}} \quad \boxed{(\pi_{s'})^{\diamond}_B}}{(A \cdot S' \rightarrow B)^{\circ\perp} \quad \textcircled{cut} \quad B^{\circ}}$$

We recall that we add contraction nodes for all the conclusions corresponding to common variables/names of  $t$  and  $s'$ .

Notice that the only typing rules whose translation introduces cuts are (APP), (SUBS), (REPL) and (STK). The case (SUBS) necessarily introduces an exponential cut for  $!$ , depending on the role of the substituted variable. The case (STK) always results in a multiplicative cut  $\text{C}(ax)$ . More interestingly and subtle are cases (APP) and (REPL). In particular, based on the nature of the left-hand side of the application, (APP) may result in a multiplicative cut or an exponential cut for  $\otimes$ . Similarly, (REPL) with subject  $c[\alpha \setminus \alpha' s]$  may result on the same cuts as before depending on the number of free occurrences of the name  $\alpha$  in the command  $c$  (i.e.  $\text{fn}_{\alpha}(c)$ ). This is related to our decomposition of rule R in Sec. 4.3.

This translation is able in particular to simulate reduction in  $\lambda\mu$ -calculus:

**Theorem 6.5** (Simulation [Lau03]). *Let  $o, p \in \mathbb{O}_{\lambda\mu}$  be typed. If  $o \rightarrow_{\lambda\mu} p$  and  $\pi_o, \pi_p$  are their corresponding type derivations respectively, then  $(\pi_o)^\diamond \rightarrow_{\text{PPN}} (\pi_p)^\diamond$ .*

This result extends to  $\Lambda M$  as expected:

**Theorem 6.6** (Simulation). *Let  $o, p \in \mathbb{O}_{\Lambda M}$  be typed. If  $o \rightarrow_{\Lambda M} p$  and  $\pi_o, \pi_p$  are their corresponding type derivations respectively, then  $(\pi_o)^\diamond \rightarrow_{\text{PPN}} (\pi_p)^\diamond$ .*

*Proof.* By induction on  $o \rightarrow_{\Lambda M} p$ . Details can be found in the Appendix C.  $\square$

The detailed correspondence between  $\Lambda M$ -steps and PPN-steps in the previous proof are summarized in the following table. In particular, the simulation theorem explains in terms of linear logic why the rules **dB**, **dM**, **N**, **C**, **W** are called plain (*i.e.* multiplicative), while rules **S**, **Nn1**, **Cn1**, **Wn1**, **Rn1** are the meaningful ones (*i.e.* exponential).

$\Lambda M$ -reduction	PPN-reduction
<b>dB</b>	$\equiv, \mathbf{C}(ax), \mathbf{C}(\otimes, \wp)$
<b>S</b>	$\equiv, \mathbf{C}(ax), \mathbf{C}(!, w), \mathbf{C}(!, d), \mathbf{C}(!, c), \mathbf{C}(!, !)$
<b>dM</b>	$\equiv$
<b>N</b>	$\equiv$
<b>C</b>	$\equiv$
<b>W</b>	$\equiv$
<b>Nn1</b>	$\equiv, \mathbf{C}(\otimes, w), \mathbf{C}(\otimes, c), \mathbf{C}(\otimes, !)$
<b>Cn1</b>	$\equiv, \mathbf{C}(\otimes, w), \mathbf{C}(\otimes, c), \mathbf{C}(\otimes, !)$
<b>Wn1</b>	$\equiv, \mathbf{C}(\otimes, w), \mathbf{C}(\otimes, c), \mathbf{C}(\otimes, !)$
<b>Rn1</b>	$\equiv, \mathbf{C}(\otimes, w), \mathbf{C}(\otimes, c), \mathbf{C}(\otimes, !)$

## 7. A STRONG BISIMULATION FOR $\Lambda M$

We introduce our notion of structural equivalence for  $\Lambda M$ , written  $\simeq$ , breaking down the presentation into three key tools on which we have based our development: plain forms, linear contexts and explicit renaming.

**Plain Forms.** As discussed in Sec. 1, the initial intuition in defining a strong bisimulation for  $\Lambda M$  arises from the intuitionistic case: Regnier's equivalence  $\sigma$  is not a strong bisimulation, but decomposing the  $\beta$ -rule and taking the **dB**-normal form of the left and right hand sides of the equations in Fig. 1, results in the  $\tilde{\sigma}$ -equivalence relation terms on  $\lambda$ -terms with explicit substitutions. This relation turns out to be a strong bisimulation with respect to the notion of meaningful computation (the relation  $\rightarrow_{\mathfrak{S}}$  in the case of  $\lambda$ -calculus).

One can identify **dB** as performing innocuous or plain computation, a fact that can also be supported by how this step translates as a multiplicative cut in PPNs. Similarly, one can identify **S** as performing non-trivial or meaningful work. In the classical case, this leads us to introduce two restrictions of reduction in  $\Lambda M$  (*cf.* Def. 4.1), one called plain and one called meaningful.

**Definition 7.1.** *The plain reduction relation  $\rightarrow_{\mathcal{P}}$  is defined as the closure by contexts of the following plain rules:*

$$\begin{array}{llll}
L\langle\lambda x.t\rangle u & \mapsto_{\text{dB}} & L\langle t[x \setminus u]\rangle & \text{fc}(u, L) \\
L\langle\mu\alpha.c\rangle u & \mapsto_{\text{dM}} & L\langle\mu\alpha'.c\llbracket\alpha \setminus^{\alpha'} u\rrbracket\rangle & \text{fc}(u, L), \alpha' \text{ fresh} \\
\text{LCC}\langle[\alpha]t\rrbracket\llbracket\alpha \setminus^{\alpha'} s\rrbracket & \mapsto_{\text{N}} & \text{LCC}\langle[\alpha']t :: s\rangle & \alpha \notin \text{LCC}, \alpha \notin t \\
\text{LCC}\langle c'\llbracket\beta \setminus^{\alpha} s'\rrbracket\rrbracket\llbracket\alpha \setminus^{\alpha'} s\rrbracket & \mapsto_{\text{C}} & \text{LCC}\langle c'\llbracket\beta \setminus^{\alpha'} s' \cdot s\rrbracket\rangle & \alpha \notin \text{LCC}, \alpha \notin c', \alpha \notin s' \\
\text{LCC}\langle c'\llbracket\beta \setminus \alpha\rrbracket\rrbracket\llbracket\alpha \setminus^{\alpha'} s\rrbracket & \mapsto_{\text{W}} & \text{LCC}\langle c'\llbracket\beta \setminus^{\alpha} s\rrbracket\llbracket\alpha \setminus \alpha'\rrbracket\rangle & \alpha \notin \text{LCC}, \alpha \notin c'
\end{array}$$

i.e.

$$\rightarrow_{\mathcal{P}} \triangleq \mathcal{O}_{\text{t}}\langle\mapsto_{\text{dB}} \cup \mapsto_{\text{dM}}\rangle \cup \mathcal{O}_{\text{c}}\langle\mapsto_{\text{N}} \cup \mapsto_{\text{C}} \cup \mapsto_{\text{W}}\rangle$$

The set of **plain forms** of the  $\Lambda M$ -calculus is given by  $\mathcal{NF}_{\mathcal{P}} \triangleq \mathcal{NF}_{\text{dB, dM, N, C, W}}$ . Moreover, the relation  $\rightarrow_{\mathcal{P}}$  is terminating and confluent (cf. Appendix D).

**Theorem 7.2.** *The relation  $\rightarrow_{\mathcal{P}}$  is terminating.*

*Proof.* We prove this result by resorting to a polynomial interpretation. Details in the Appendix D.  $\square$

**Theorem 7.3.** *The relation  $\rightarrow_{\mathcal{P}}$  is confluent.*

*Proof.* We prove that the relation  $\rightarrow_{\mathcal{P}}$  is locally confluent (WCR) and we conclude by Newman's Lemma [BN98] using Theorem 7.2.  $\square$

From now on, we will refer to the (unique) **plain form** of an object  $o$  as  $\mathcal{P}(o) \triangleq \text{nf}_{\mathcal{P}}(o)$ .

**Definition 7.4.** *The meaningful replacement reduction relation  $\rightarrow_{\mathbf{R}\bullet}$  is defined as the closure by contexts of the non-linear rules  $\text{Rnl}$ ,  $\text{Nnl}$ ,  $\text{Cnl}$  and  $\text{Wnl}$ , i.e.*

$$\rightarrow_{\mathbf{R}\bullet} \triangleq \mathcal{O}_{\text{c}}\langle\mapsto_{\text{Rnl}} \cup \mapsto_{\text{Nnl}} \cup \mapsto_{\text{Cnl}} \cup \mapsto_{\text{Wnl}}\rangle$$

The **meaningful reduction relation**  $\rightsquigarrow$  for the  $\Lambda M$ -calculus on plain forms is given by:

$$o \rightsquigarrow o' \quad \text{iff} \quad o \rightarrow_{\mathbf{S, R}\bullet} p \text{ and } o' = \mathcal{P}(p)$$

We occasionally use  $\rightsquigarrow_{\mathbf{S}}$  and  $\rightsquigarrow_{\mathbf{R}\bullet}$  to make explicit which rule is used in a  $\rightsquigarrow$ -step.

In the classical case, a first attempt to obtaining a strong bisimulation is to consider the rules that result from taking the  $\mathcal{P}$ -normal form at each side of those from Laurent's  $\sigma$ -equivalence relation (cf. Fig. 4). The obtained relation  $\simeq_{\bar{\sigma}}$  on  $\Lambda M$ -objects is depicted in Fig. 12. This equational theory would be a natural candidate for our strong bisimulation, but unfortunately it is not the case as we explain below.

**Explicit Renaming.** The implicit renaming operation introduced by rule  $\simeq_{\bar{\sigma}_7}$  turns out to be problematic for the strong bisimulation property we seek. Here is an example:

$$\begin{array}{ccc}
(\mu\alpha.[\alpha]\mu\beta.c)u & \simeq_{\sigma_7} & (\mu\alpha.c\{\beta \setminus \alpha\})u \\
\mu \downarrow & & \mu \downarrow \\
\mu\alpha'.[\alpha'](\mu\beta.c\{\{\alpha \setminus^{\alpha'} u\}\})u & \not\simeq_{\sigma} & \mu\alpha'.c\{\beta \setminus \alpha\}\{\{\alpha \setminus^{\alpha'} u\}\}
\end{array} \tag{7.1}$$

This is the reason why we introduce the explicit renaming operator in the  $\Lambda M$ -calculus: it allows us to replace the rule  $\simeq_{\bar{\sigma}_7}$  with:

$$[\alpha]\mu\beta.c \simeq_{\mathbf{P}} c[\beta \setminus \alpha]$$

$$\begin{aligned}
(\lambda y.t)[x \setminus u] &\simeq_{\tilde{\sigma}_1} \lambda y.t[x \setminus u] \\
&y \notin u \\
(tv)[x \setminus u] &\simeq_{\tilde{\sigma}_2} t[x \setminus u]v \\
&x \notin v \\
(\mu\beta.[\alpha]t)[x \setminus u] &\simeq_{\tilde{\sigma}_3} \mu\beta.[\alpha]t[x \setminus u] \\
&\beta \notin u \\
[\alpha']\mu\alpha''.([\beta']\mu\beta''.c[\beta \setminus^{\beta''} v])[\alpha \setminus^{\alpha''} u] &\simeq_{\tilde{\sigma}_4} [\beta']\mu\beta''.([\alpha']\mu\alpha''.c[\alpha \setminus^{\alpha''} u])[\beta \setminus^{\beta''} v] \\
&\alpha \notin v, \alpha'' \notin v, \beta \notin u, \beta'' \notin u \\
[\alpha']\mu\alpha''.([\beta']\lambda y.\mu\beta.c)[\alpha \setminus^{\alpha''} u] &\simeq_{\tilde{\sigma}_5} [\beta']\lambda y.\mu\beta.[\alpha']\mu\alpha''.c[\alpha \setminus^{\alpha''} u] \\
&y \notin u, \beta \notin u, \alpha'' \notin u \\
[\alpha']\lambda x.\mu\alpha.[\beta']\lambda y.\mu\beta.c &\simeq_{\tilde{\sigma}_6} [\beta']\lambda y.\mu\beta.[\alpha']\lambda x.\mu\alpha.c \\
[\beta]\mu\alpha.c &\simeq_{\tilde{\sigma}_7} c\{\alpha \setminus \beta\} \\
\mu\alpha.[\alpha]t &\simeq_{\tilde{\sigma}_8} t \\
&\alpha \notin t \\
t[y \setminus v][x \setminus u] &\simeq_{\tilde{\sigma}_9} t[x \setminus u][y \setminus v] \\
&y \notin u, x \notin v
\end{aligned}$$

Figure 12:  $\tilde{\sigma}$ -equivalence on  $\Lambda M$ -objects.

This allows to circumvent the problem by resorting to  $\simeq_{\mathcal{P}}$  and the notion of plain computation. For instance, consider the initial equation of the previous example (7.1) where  $\text{fn}_{\alpha}(c) > 1$ , changing implicit by explicit renaming, and taking the  $\mathcal{P}$ -normal form of the objects involved:

$$\begin{array}{ccc}
\mu\alpha'.([\alpha]\mu\beta.c)[\alpha \setminus^{\alpha'} u] & \simeq_{\mathcal{P}} & \mu\alpha'.c[\beta \setminus \alpha][\alpha \setminus^{\alpha'} u] \\
\mathbf{R} \bullet \downarrow & & \mathbf{R} \bullet \downarrow \\
\mu\alpha'.[\alpha'](\mu\beta.c\{\alpha \setminus^{\alpha'} u\})u & & \mu\alpha'.c[\beta \setminus \alpha]\{\alpha \setminus^{\alpha'} u\} \\
\mathcal{P} \downarrow & & \mathcal{P} \downarrow \\
\mu\alpha'.[\alpha']\mu\beta'.\mathcal{P}(c\{\alpha \setminus^{\alpha'} u\}[\beta \setminus^{\beta'} u]) & \simeq_{\mathcal{P}} & \mu\alpha'.\mathcal{P}(c\{\alpha \setminus^{\alpha'} u\}[\beta \setminus^{\beta'} u])[\beta' \setminus \alpha']
\end{array}$$

Note that the behavior of the implicit replacement over the explicit renaming plays a key role in the resulting  $\rho$ -equivalence at the bottom of the diagram.

**Linear Contexts.** The linear contexts turn out to be very useful when decomposing the rewriting rule  $\mathbf{R}$  (*cf.* Sec. 4.3). Here they are used once again to reduce the amount of necessary rules for the equivalence relation. Note that linear contexts are not only used to support commutation of explicit substitution and replacement but also for explicit renaming.



Indeed, the equations  $\simeq_{\tilde{\sigma}_1}$ ,  $\simeq_{\tilde{\sigma}_2}$ ,  $\simeq_{\tilde{\sigma}_3}$  and  $\simeq_{\tilde{\sigma}_9}$  in Fig. 12 are generalised into a single equation reflecting the fact that an explicit substitution commutes with linear contexts. Something similar can be stated for rules  $\simeq_{\tilde{\sigma}_4}$  and  $\simeq_{\tilde{\sigma}_5}$ , between linear contexts and explicit replacement. Moreover, linear contexts can be skipped by any explicit operator (substitution, replacement or renaming) as long as they are independent, *i.e.* no undesired capture of free variables/names takes place.

Therefore, we introduce into our equivalence relation  $\simeq$  three equations that in turn replace rules  $\simeq_{\tilde{\sigma}_1}$ ,  $\simeq_{\tilde{\sigma}_2}$ ,  $\simeq_{\tilde{\sigma}_3}$ ,  $\simeq_{\tilde{\sigma}_4}$ ,  $\simeq_{\tilde{\sigma}_5}$  and  $\simeq_{\tilde{\sigma}_9}$  from Fig. 12, while extending its behavior to explicit renaming as well:

$$\begin{array}{lll} \text{LTT}\langle t \rangle [x \setminus u] & \simeq_{\text{exsubs}} & \text{LTT}\langle t \rangle [x \setminus u] \quad x \notin \text{LTT}, \text{fc}(u, \text{LTT}) \\ \text{LCC}\langle c \rangle [\alpha \setminus \alpha' s] & \simeq_{\text{exrepl}} & \text{LCC}\langle c \rangle [\alpha \setminus \alpha' s] \quad \alpha \notin \text{LCC}, \text{fc}(\alpha', \text{LCC}), \text{fc}(s, \text{LCC}) \\ \text{LCC}\langle c \rangle [\alpha \setminus \beta] & \simeq_{\text{exren}} & \text{LCC}\langle c \rangle [\alpha \setminus \beta] \quad \alpha \notin \text{LCC}, \text{fc}(\beta, \text{LCC}) \end{array}$$

**Structural Equivalence.** We are now ready to present  $\simeq$ .

**Definition 7.5** (Structural Equivalence over Plain Forms). *The structural equivalence relation  $\simeq$  is the least congruence relation over plain forms of the  $\Lambda M$ -calculus generated by the rules in Fig. 13.*

$$\begin{array}{lll} \text{LTT}\langle t \rangle [x \setminus u] & \simeq_{\text{exsubs}} & \text{LTT}\langle t \rangle [x \setminus u] \quad x \notin \text{LTT}, \text{fc}(u, \text{LTT}) \\ \text{LCC}\langle c \rangle [\alpha \setminus \alpha' s] & \simeq_{\text{exrepl}} & \text{LCC}\langle c \rangle [\alpha \setminus \alpha' s] \quad \alpha \notin \text{LCC}, \text{fc}(\alpha', \text{LCC}), \text{fc}(s, \text{LCC}) \\ \text{LCC}\langle c \rangle [\alpha \setminus \beta] & \simeq_{\text{exren}} & \text{LCC}\langle c \rangle [\alpha \setminus \beta] \quad \alpha \notin \text{LCC}, \text{fc}(\beta, \text{LCC}) \\ [\alpha'] \lambda x. \mu \alpha. [\beta'] \lambda y. \mu \beta. c & \simeq_{\text{ppop}} & [\beta'] \lambda y. \mu \beta. [\alpha'] \lambda x. \mu \alpha. c \quad \beta \neq \alpha', \alpha \neq \beta' \\ [\beta] \mu \alpha. c & \simeq_{\text{p}} & c[\alpha \setminus \beta] \\ \mu \alpha. [\alpha] t & \simeq_{\theta} & t \quad \alpha \notin t \end{array}$$

Figure 13: Structural equivalence  $\simeq$  on  $\Lambda M$ -objects.

Note that  $\simeq$  is not a congruence on arbitrary terms. For example,  $\mu \alpha. [\alpha] x$  and  $x$  are both in plain form and moreover  $\mu \alpha. [\alpha] x \simeq x$ . However,  $(\mu \alpha. [\alpha] x) y \not\approx xy$  since  $(\mu \alpha. [\alpha] x) y$  is not a plain form. Nevertheless,  $\mathcal{P}((\mu \alpha. [\alpha] x) y) = \mu \alpha. [\alpha] xy \simeq xy = \mathcal{P}(xy)$ . More generally:

**Lemma 7.6.** *Let  $o \in \mathcal{O}_{\Lambda M}$ . If  $o \simeq o'$ , then for all context  $\mathcal{O}$  of appropriate sort,  $\mathcal{P}(\mathcal{O}\langle o \rangle) \simeq \mathcal{P}(\mathcal{O}\langle o' \rangle)$ .*

Hence, commutation rules  $\simeq_{\tilde{\sigma}_1}$ ,  $\simeq_{\tilde{\sigma}_2}$ ,  $\simeq_{\tilde{\sigma}_3}$  and  $\simeq_{\tilde{\sigma}_9}$  from Fig. 12 are replaced by  $\simeq_{\text{exsubs}}$ , while  $\simeq_{\text{exrepl}}$  replaces both  $\simeq_{\tilde{\sigma}_4}$  and  $\simeq_{\tilde{\sigma}_5}$ , and  $\simeq_{\text{p}}$  replaces  $\simeq_{\tilde{\sigma}_7}$ . Also, we incorporate the new rule  $\simeq_{\text{exren}}$  discussed before, and only rules  $\simeq_{\tilde{\sigma}_6}$  and  $\simeq_{\tilde{\sigma}_8}$  remain unaltered, here called  $\simeq_{\text{ppop}}$  (for pop/pop) and  $\simeq_{\theta}$  respectively (see [Lau03] for the origin of these names). The following table summarises the correspondence between the different rules:

New rule	Captured rule from $\tilde{\sigma}$ -equivalence
$\simeq_{\text{exsubs}}$	$\simeq_{\tilde{\sigma}_1}, \simeq_{\tilde{\sigma}_2}, \simeq_{\tilde{\sigma}_3}$ and $\simeq_{\tilde{\sigma}_9}$
$\simeq_{\text{exrepl}}$	$\simeq_{\tilde{\sigma}_4}$ and $\simeq_{\tilde{\sigma}_5}$
$\simeq_{\text{exren}}$	
$\simeq_{\text{ppop}}$	$\simeq_{\tilde{\sigma}_6}$
$\simeq_{\text{p}}$	$\simeq_{\tilde{\sigma}_7}$
$\simeq_{\theta}$	$\simeq_{\tilde{\sigma}_8}$

The resulting equivalence relation  $\simeq$  is in fact a strong bisimulation with respect to the the notion of meaningful computation, as we will show.

We present next some admissible equivalences of interest. First a result on commutation between linear contexts and explicit operators:

**Lemma 7.7.**

- (1) Let  $t \in \mathbb{T}_{\Lambda M}$ . Then,  $\mathcal{P}(\mathbf{L}\langle \text{LTT}\langle t \rangle \rangle) \simeq \mathcal{P}(\text{LTT}\langle \mathbf{L}\langle t \rangle \rangle)$  if  $\text{bv}(\mathbf{L}) \notin \text{LTT}$  and  $\text{fc}(\mathbf{L}, \text{LTT})$ .
- (2) Let  $c \in \mathbb{C}_{\Lambda M}$ . Then,  $\mathcal{P}(\mathbf{R}\langle \text{LCC}\langle c \rangle \rangle) \simeq \mathcal{P}(\text{LCC}\langle \mathbf{R}\langle c \rangle \rangle)$  if  $\text{bn}(\mathbf{R}) \notin \text{LCC}$  and  $\text{fc}(\mathbf{R}, \text{LCC})$ .

*Proof.* Each case is proved by induction on  $\mathbf{L}$  or  $\mathbf{R}$  respectively, using some auxiliary results. Details in the Appendix E.  $\square$

A direct consequence of this result is that rules from Fig. 12 that were replaced as stated before are indeed admissible:

- $(\lambda y.t)[x \setminus u] \simeq \lambda y.t[x \setminus u]$  with  $y \notin u$ ,  $\mathbf{L} = \square[x \setminus u]$  and  $\text{LTT} = \lambda y.\square$ .
- $(tv)[x \setminus u] \simeq t[x \setminus u]v$  with  $x \notin v$ ,  $\mathbf{L} = \square[x \setminus u]$  and  $\text{LTT} = \square v$ .
- $(\mu\beta.[\alpha]t)[x \setminus u] \simeq \mu\beta.[\alpha]t[x \setminus u]$  with  $\alpha \notin u$ ,  $\mathbf{L} = \square[x \setminus u]$  and  $\text{LTT} = \mu\beta.[\alpha]\square$ .
- $t[y \setminus v][x \setminus u] \simeq t[x \setminus u][y \setminus v]$  with  $y \notin u$ ,  $x \notin v$ ,  $\mathbf{L} = \square[x \setminus u]$  and  $\text{LTT} = \square[y \setminus v]$ .
- $[\alpha']\mu\alpha''.([\beta']\mu\beta''.c[\beta \setminus \beta''v])[\alpha \setminus \alpha''u] \simeq [\beta']\mu\beta''.([\alpha']\mu\alpha''.c[\alpha \setminus \alpha''u])[\beta \setminus \beta''v]$  with  $\alpha \notin v$ ,  $\alpha'' \notin v$ ,  $\beta \notin u$ ,  $\beta'' \notin u$ ,  $\beta'' \neq \alpha'$ ,  $\alpha'' \neq \beta'$ . This case is particularly interesting since rule  $\simeq_{\text{p}}$  plays a key role in it. It is by applying  $\simeq_{\text{p}}$  on both sides of the equality that it is enough to prove

$$(c[\beta \setminus \beta''v][\beta'' \setminus \beta'])[\alpha \setminus \alpha''u][\alpha'' \setminus \alpha'] \simeq (c[\alpha \setminus \alpha''u][\alpha'' \setminus \alpha'])[\beta \setminus \beta''v][\beta'' \setminus \beta']$$

which in turn follows from Lem. 7.7 (2) taking  $\mathbf{R} = \square[\alpha \setminus \alpha''u][\alpha'' \setminus \alpha']$  and  $\text{LCC} = \square[\beta \setminus \beta''v][\beta'' \setminus \beta']$ .

- $[\alpha']\mu\alpha''.([\beta']\lambda y.\mu\beta.c)[\alpha \setminus \alpha''u] \simeq [\beta']\lambda y.\mu\beta.[\alpha']\mu\alpha''.c[\alpha \setminus \alpha''u]$  with  $y \notin u$ ,  $\beta \notin u$ ,  $\beta'' \notin u$ ,  $\beta'' \neq \alpha'$ ,  $\alpha'' \neq \beta'$ . As in the previous case, by  $\simeq_{\text{p}}$  it is enough to show

$$([\beta']\lambda y.\mu\beta.c)[\alpha \setminus \alpha''u][\alpha'' \setminus \alpha'] \simeq [\beta']\lambda y.\mu\beta.c[\alpha \setminus \alpha''u][\alpha'' \setminus \alpha']$$

and we conclude by Lem. 7.7 (2) taking  $\mathbf{R} = \square[\alpha \setminus \alpha''u][\alpha'' \setminus \alpha']$  and  $\text{LCC} = [\beta']\lambda y.\mu\beta.\square$ .

As a further result, we show that  $\simeq$  preserves the type of  $\Lambda M$ -objects in the same way that  $\simeq_{\sigma}$  does so for objects of the  $\lambda\mu$ -calculus (Lem. 3.4).

**Lemma 7.8** (Type Preservation for  $\simeq$ ). *Let  $o \in \mathbb{O}_{\Lambda M}$ . If  $\pi \triangleright_{\varepsilon} \Gamma \vdash o : T \mid \Delta$  and  $o \simeq o'$ , then there exists  $\pi' \triangleright_{\varepsilon} \Gamma \vdash o' : T \mid \Delta$ .*

*Proof.* The proof is by induction on  $o \simeq o'$  and is straightforward. It uses Lem. 4.4.  $\square$

**Strong Bisimulation Result.**

**Lemma 7.9.** *Let  $u, s, o \in \mathbb{O}_{\Lambda M}$  in  $\mathcal{P}$ -normal form such that  $o \simeq o'$ ,  $u \simeq u'$  and  $s \simeq s'$ , where  $u, u'$  are terms and  $s, s'$  are stacks. Then,*

- (1)  $\mathcal{P}(o\{x \setminus u\}) \simeq \mathcal{P}(o'\{x \setminus u\})$  and  $\mathcal{P}(o\{x \setminus u'\}) \simeq \mathcal{P}(o'\{x \setminus u'\})$ .
- (2)  $\mathcal{P}(o\{\{\alpha \setminus^{\alpha'} s\}\}) \simeq \mathcal{P}(o'\{\{\alpha \setminus^{\alpha'} s\}\})$  and  $\mathcal{P}(o\{\{\alpha \setminus^{\alpha'} s'\}\}) \simeq \mathcal{P}(o'\{\{\alpha \setminus^{\alpha'} s'\}\})$ .

We are now able to state the promised result, namely, the fact that  $\simeq$  is a strong bisimulation with respect to the meaningful computation relation.

**Theorem 7.10.** *Let  $o \in \mathbb{O}_{\Lambda M}$ . If  $o \simeq p$  and  $o \rightsquigarrow o'$ , then there exists  $p'$  such that  $p \rightsquigarrow p'$  and  $o' \simeq p'$ .*

*Proof.* The proof is by induction on  $o \simeq p$  and uses Lem. 7.7, Lem. 7.6 and Lem. 7.9. All the details are in the Appendix F.  $\square$

**Example 7.11.** *We illustrate the previous theorem with the following example. Let  $o = o_0[\alpha \setminus^{\alpha'} u] \simeq_{\text{ppop}} p_0[\alpha \setminus^{\alpha'} u] = p$ , where  $o_0 = [\alpha] \lambda x. \mu \gamma. [\alpha] \lambda y. \mu \delta. c \simeq_{\text{ppop}} [\alpha] \lambda y. \mu \delta. [\alpha] \lambda x. \mu \gamma. c = p_0$ . Notice in particular that  $o_0, o, p_0$  and  $p$  are all plain forms. We have*

$$\begin{array}{ccc}
 o = ([\alpha] \lambda x. \mu \gamma. [\alpha] \lambda y. \mu \delta. c)[\alpha \setminus^{\alpha'} u] & \simeq & ([\alpha] \lambda y. \mu \delta. [\alpha] \lambda x. \mu \gamma. c)[\alpha \setminus^{\alpha'} u] = p \\
 \begin{array}{c} \mathbf{R}^\bullet \downarrow \\ [\alpha'] (\lambda x. \mu \gamma. [\alpha'] (\lambda y. \mu \delta. c') u) u \end{array} & & \begin{array}{c} \mathbf{R}^\bullet \downarrow \\ [\alpha'] (\lambda y. \mu \delta. [\alpha'] (\lambda x. \mu \gamma. c') u) u \end{array} \\
 \begin{array}{c} \mathcal{P} \downarrow \\ o' = [\alpha'] (\mu \gamma. [\alpha'] (\mu \delta. c'') [y \setminus u])[x \setminus u] \end{array} & \simeq & \begin{array}{c} \mathcal{P} \downarrow \\ [\alpha'] (\mu \delta. [\alpha'] (\mu \gamma. c'') [x \setminus u])[y \setminus u] = p' \end{array}
 \end{array}$$

so that  $o \rightsquigarrow o'$  and  $p \rightsquigarrow p'$ . We conclude  $o' \simeq p'$  as follows:

$$\begin{array}{l}
 [\alpha'] (\mu \gamma. [\alpha'] (\mu \delta. c'') [y \setminus u])[x \setminus u] \simeq_{\text{exsubs}} \\
 [\alpha'] \mu \gamma. [\alpha'] \mu \delta. c'' [y \setminus u][x \setminus u] \simeq_{\text{p}} \\
 c'' [y \setminus u][x \setminus u][\delta \setminus \alpha'] [\gamma \setminus \alpha'] \simeq_{\text{exren}} \\
 c'' [y \setminus u][x \setminus u][\gamma \setminus \alpha'] [\delta \setminus \alpha'] \simeq_{\text{p}} \\
 [\alpha'] \mu \delta. [\alpha'] \mu \gamma. c'' [y \setminus u][x \setminus u] \simeq_{\text{exsubs}} \\
 [\alpha'] (\mu \delta. [\alpha'] (\mu \gamma. c'') [x \setminus u])[y \setminus u]
 \end{array}$$

Note the use of  $\simeq_{\text{p}}$  to swap the occurrences of  $[\alpha'] \mu \gamma \dots$  and  $[\alpha'] \mu \delta \dots$ .

## 8. TWO CORRESPONDENCE RESULTS

In this section we study how structural equivalence over plain forms  $\simeq$  (Def. 7.5) correlates with Laurent's  $\simeq_{\sigma}$  (Def. 3.3) and with structural equivalence  $\equiv$  for polarised proof-nets (Def. 5.1). As the reader may recall, Laurent's  $\simeq_{\sigma}$  is defined over  $\lambda\mu$  whereas our  $\simeq$  is defined over  $\Lambda M$ . Moreover, our  $\simeq$  relates  $\Lambda M$  terms in *plain form*. The naive attempt at correlating them by simply taking the plain form would be stated as follows, where  $o, p \in \mathbb{O}_{\lambda\mu}$ :

$$o \simeq_{\sigma} p \quad \text{iff} \quad \mathcal{P}(o) \simeq \mathcal{P}(p)$$

However, this does not work. The reason is that in obtaining  $\simeq$  we dropped the equation:

$$[\beta] \mu \alpha. c \simeq_{\sigma_7} c\{\alpha \setminus \beta\}$$

since it breaks the strong bisimulation we are looking for (*cf.* Diagram 7.1). At the same time, we added:

$$[\beta] \mu \alpha. c \simeq_{\mathcal{P}} c[\alpha \setminus \beta]$$

motivating the introduction of the explicit renaming operator in  $\Lambda M$ -calculus. Since plain computation (Def. 7.4) does not execute explicit renamings, taking the plain form of both sides of equation  $\sigma_7$  would not necessarily yield  $\simeq$ -equivalent  $\Lambda M$ -terms. In order to account for this and for the purposes of this section only, we extend  $\simeq$  with the following equation:

$$c[\alpha \setminus \beta] \simeq_{\text{ren}} c\{\alpha \setminus \beta\}$$

The resulting equivalence is dubbed  $\simeq_{\text{er}}$ . We can now state the main result we prove in this section (*cf.* Thm. 8.11), namely that for all  $o, p \in \mathcal{O}_{\lambda\mu}$ :

$$o \simeq_{\sigma} p \quad \text{iff} \quad \mathcal{P}(o) \simeq_{\text{er}} \mathcal{P}(p)$$

The left-to-right direction is relatively straightforward. We'll state it formally since we will refer to it later:

**Lemma 8.1.** *Let  $o, p \in \mathcal{O}_{\lambda\mu}$ . If  $o \simeq_{\sigma} p$ , then  $\mathcal{P}(o) \simeq_{\text{er}} \mathcal{P}(p)$ .*

The reciprocal is our main focus here. It relies on first establishing a formal relation between  $\simeq_{\text{er}}$  and  $\equiv$  (Thm. 8.10).

**Correspondence between  $\simeq_{\text{er}}$  and  $\equiv$ .** This section studies the soundness and completeness of  $\simeq_{\text{er}}$  with respect to the PPN semantics. This result is based on the completeness property for  $\simeq_{\sigma}$  [Lau03], which we describe next. The equivalence relation  $\simeq_{\sigma}$  has the interesting property that any two typable objects  $o$  and  $p$  of the  $\lambda\mu$ -calculus are  $\sigma$ -equivalent if and only if their corresponding type derivations are structurally equivalent when translated using the following:

**Definition 8.2.** *The multiplicative translation of a type derivation  $\pi$  into a polarised proof-nets, written  $\pi^{\diamond}$ , is defined as the multiplicative normal form of  $\pi^{\diamond}$ .*

In other words, two  $\sigma$ -equivalent objects have the same PPN representation modulo multiplicative cuts, and vice-versa:

**Theorem 8.3** ([Lau03]). *Let  $o, p \in \mathcal{O}_{\lambda\mu}$ . Then  $o \simeq_{\sigma} p$  iff  $(\pi_o)^{\diamond} \equiv (\pi_p)^{\diamond}$ , where  $\pi_o$  and  $\pi_p$  are the corresponding related type derivations.*

Note the use of  $\_{}^{\diamond}$  rather than  $\_{}^{\diamond}$ . For the latter, the result does not hold. It suffices to consider equation  $\simeq_{\sigma_1}$  from Fig. 4.

A soundness result also holds for  $\Lambda M$ :

**Theorem 8.4.** *Let  $o, p \in \mathcal{O}_{\Lambda M}$ . Then  $o \simeq p$  implies  $(\pi_o)^{\diamond} \equiv (\pi_p)^{\diamond}$ , where  $\pi_o$  and  $\pi_p$  are the corresponding related type derivations.*

*Proof.* By induction on  $o \simeq p$ . Details in Appendix G. □

The previous soundness property can be extended to the equivalence  $\simeq_{\text{ren}}$ . Indeed, the equivalence relation  $\simeq_{\text{er}}$  also preserves the multiplicative normal forms of the associated PPN.

**Lemma 8.5.** *Let  $o, p \in \mathcal{O}_{\Lambda M}$  be typed. If  $o \simeq_{\text{er}} p$ , then  $(\pi_o)^{\diamond} \equiv (\pi_p)^{\diamond}$ , where  $\pi_o$  and  $\pi_p$  are the corresponding related type derivations.*

An interesting, though expected, result is that the multiplicative normal forms of the PPN are preserved by plain computation.

**Lemma 8.6.** *Let  $o, p \in \mathbb{O}_{\Lambda M}$  be typed. If  $o \rightarrow_{\mathcal{P}} p$ , then  $(\pi_o)^\blacklozenge \equiv (\pi_p)^\blacklozenge$ , where  $\pi_o$  and  $\pi_p$  are the corresponding related type derivations.*

*Proof.* By induction on  $o \rightarrow_{\mathcal{P}} p$ . Details in Appendix G.  $\square$

To obtain the desired completeness result of  $\simeq_{\text{er}}$  with respect to  $\equiv$ , it is necessary to relate the sets  $\mathbb{O}_{\Lambda M}$  and  $\mathbb{O}_{\lambda\mu}$ . We do so by means of an *expansion function*  $\mathbf{e}(\_)$ , that eliminates the explicit operators of an object by  $\text{dBdM}\rho$ -expansions:

$$\begin{array}{ll} \mathbf{e}(x) & \triangleq x \\ \mathbf{e}(tu) & \triangleq \mathbf{e}(t)\mathbf{e}(u) \\ \mathbf{e}(\lambda x.t) & \triangleq \lambda x.\mathbf{e}(t) \\ \mathbf{e}(\mu\alpha.c) & \triangleq \mu\alpha.\mathbf{e}(c) \\ \mathbf{e}(t[x \setminus u]) & \triangleq (\lambda x.\mathbf{e}(t))\mathbf{e}(u) \end{array} \quad \begin{array}{ll} \mathbf{e}([\alpha]t) & \triangleq [\alpha]\mathbf{e}(t) \\ \mathbf{e}(c[[\alpha \setminus \alpha' s]]) & \triangleq [\alpha'](\mu\alpha.\mathbf{e}(c)) :: \mathbf{e}(s) \\ \mathbf{e}(c[\alpha \setminus \beta]) & \triangleq [\beta]\mu\alpha.\mathbf{e}(c) \\ \mathbf{e}(t \cdot s) & \triangleq \mathbf{e}(t) \cdot \mathbf{e}(s) \end{array}$$

Note that  $\mathbf{e}(\_)$  is not the left-inverse of  $\mathcal{P}(\_)$ , *i.e.* given  $o \in \mathbb{O}_{\lambda\mu}$ , it is not necessarily the case  $\mathbf{e}(\mathcal{P}(o)) = o$ . For example, take  $o = (\mu\alpha.[\alpha]x)yz$ . Then,  $\mathcal{P}(o) = \mu\alpha'.([\alpha]x)[[\alpha \setminus \alpha' y \cdot z]]$  while  $\mathbf{e}(\mathcal{P}(o)) = \mu\alpha'.[\alpha'](\mu\alpha.[\alpha]x)yz$ . However, it yields an equivalent object thanks to rule  $\simeq_{\sigma_8}$ .

**Lemma 8.7.** *Let  $o \in \mathbb{O}_{\Lambda M}$ .*

- $\pi \triangleright_{\mathcal{E}} \Gamma \vdash o : T \mid \Delta$  if and only if  $\pi' \triangleright_{\mathcal{E}} \Gamma \vdash \mathcal{P}(o) : T \mid \Delta$ .
- $\pi \triangleright_{\mathcal{E}} \Gamma \vdash o : T \mid \Delta$  if and only if  $\pi' \triangleright_{\mathcal{E}} \Gamma \vdash \mathbf{e}(o) : T \mid \Delta$ .

Given that the expansion steps on the  $\Lambda M$ -calculus are translated into multiplicative cuts in the PPN, we have:

**Lemma 8.8.**

- (1) *Let  $o \in \mathbb{O}_{\lambda\mu}$ . Then,  $(\pi_o)^\blacklozenge \equiv (\pi_{\mathcal{P}(o)})^\blacklozenge$ , where  $\pi_o$  and  $\pi_{\mathcal{P}(o)}$  are the corresponding related type derivations.*
- (2) *Let  $o \in \mathbb{O}_{\Lambda M}$ . Then,  $(\pi_o)^\blacklozenge \equiv (\pi_{\mathbf{e}(o)})^\blacklozenge$ , where  $\pi_o$  and  $\pi_{\mathbf{e}(o)}$  are the corresponding related type derivations.*

*Proof.* Item 1 is by induction on the length of  $o \rightarrow_{\mathcal{P}} \mathcal{P}(o)$ . Item 2 is by induction on  $o$ . Details in Appendix G.  $\square$

Hence, as an immediate corollary we have:

**Corollary 8.9.** *Let  $o \in \mathbb{O}_{\lambda\mu}$  and  $o' \in \mathbb{O}_{\Lambda M}$  be typed. Then,  $(\pi_o)^\blacklozenge \equiv (\pi_{\mathbf{e}(\mathcal{P}(o))})^\blacklozenge$  and  $(\pi_{o'})^\blacklozenge \equiv (\pi_{\mathcal{P}(\mathbf{e}(o'))})^\blacklozenge$ .*

These auxiliary results lead to the sought-for correspondence between  $\simeq_{\text{er}}$  and the structural equivalence for PPN.

**Theorem 8.10.** *Let  $o, p \in \mathbb{O}_{\lambda\mu}$  be typed. Then,  $\mathcal{P}(o) \simeq_{\text{er}} \mathcal{P}(p)$  iff  $(\pi_{\mathcal{P}(o)})^\blacklozenge \equiv (\pi_{\mathcal{P}(p)})^\blacklozenge$ , where  $\pi_{\mathcal{P}(o)}$  and  $\pi_{\mathcal{P}(p)}$  are the corresponding related type derivations.*

*Proof.*  $\Rightarrow$ ) First remark that given  $o, p \in \mathbb{O}_{\lambda\mu}$  we have  $\mathcal{P}(o), \mathcal{P}(p) \in \mathbb{O}_{\Lambda M}$ . By Lem. 8.5,  $\mathcal{P}(o) \simeq_{\text{er}} \mathcal{P}(p)$  implies  $(\pi_{\mathcal{P}(o)})^\blacklozenge \equiv (\pi_{\mathcal{P}(p)})^\blacklozenge$ .

$\Leftarrow$ ) Let  $(\pi_{\mathcal{P}(o)})^\blacklozenge \equiv (\pi_{\mathcal{P}(p)})^\blacklozenge$ . By Lem. 8.8 (2),  $(\pi_{\mathbf{e}(\mathcal{P}(o))})^\blacklozenge \equiv (\pi_{\mathbf{e}(\mathcal{P}(p))})^\blacklozenge$  and, by Cor. 8.9,  $(\pi_o)^\blacklozenge \equiv (\pi_p)^\blacklozenge$ . Then, by Thm. 8.3,  $o \simeq_{\sigma} p$  and we conclude by Lem. 8.1,  $\mathcal{P}(o) \simeq_{\text{er}} \mathcal{P}(p)$ .  $\square$

**Correspondence between  $\simeq_{\text{er}}$  and  $\simeq_{\sigma}$ .** The correspondence between  $\simeq_{\text{er}}$  and  $\equiv$  (Thm. 8.10) ends up relating the notion of equivalence for the  $\Lambda M$ -calculus developed in this work with the usual one in the literature for the  $\lambda\mu$ -calculus.

**Theorem 8.11.** *Let  $o, p \in \mathbb{O}_{\lambda\mu}$ . Then,  $o \simeq_{\sigma} p$  iff  $\mathcal{P}(o) \simeq_{\text{er}} \mathcal{P}(p)$ .*

*Proof.*  $\Rightarrow$ ) By Lem. 8.1,  $o \simeq_{\sigma} p$  implies  $\mathcal{P}(o) \simeq_{\text{er}} \mathcal{P}(p)$ .

$\Leftarrow$ ) Let  $\mathcal{P}(o) \simeq_{\text{er}} \mathcal{P}(p)$ . By Lem. 8.5,  $(\pi_{\mathcal{P}(o)})^{\blacklozenge} \equiv (\pi_{\mathcal{P}(p)})^{\blacklozenge}$  and, by Lem. 8.8 (1),  $(\pi_o)^{\blacklozenge} \equiv (\pi_p)^{\blacklozenge}$ . Then, by Thm. 8.3,  $(\pi_o)^{\blacklozenge} \equiv (\pi_p)^{\blacklozenge}$  implies  $o \simeq_{\sigma} p$ .  $\square$

This constitutes the main result of the current section, which can be graphically depicted by the following diagram:

$$\begin{array}{ccc}
 o \simeq_{\sigma} p & \xleftarrow{\text{Thm. 8.11}} & \mathcal{P}(o) \simeq_{\text{er}} \mathcal{P}(p) \\
 \text{Thm. 8.3} \updownarrow & & \updownarrow \text{Thm. 8.10} \\
 (\pi_o)^{\blacklozenge} \equiv (\pi_p)^{\blacklozenge} & & (\pi_{\mathcal{P}(o)})^{\blacklozenge} \equiv (\pi_{\mathcal{P}(p)})^{\blacklozenge}
 \end{array}$$

It is particularly interesting to remark the fact that  $\simeq_{\sigma}$  *strictly* contains  $\simeq$ , but the difference between these relations resides exclusively in how they manage the renaming (implicit vs. explicit). This is succinctly captured by rule  $\simeq_{\text{ren}}$ .

## 9. CONCLUSION

This paper is about  $\sigma$ -equivalence in classical logic and the negligible effect it has on the operational behavior of the terms it relates. It refines the  $\lambda\mu$ -calculus with explicit operators for renaming, substitution and replacement, by splitting in particular each of the rules  $\beta$  and  $\mu$  of  $\lambda\mu$  into multiplicative and exponential fragments, thus resulting in the introduction of a new calculus called  $\Lambda M$ . This new presentation of  $\lambda\mu$  allows to reformulate  $\sigma$ -equivalence on  $\lambda\mu$ -terms as a strong bisimulation relation  $\simeq$  on  $\Lambda M$ -terms. The main obstacle to extract a bisimulation on  $\Lambda M$  from the original Laurent's  $\sigma$ -equivalence on  $\lambda\mu$ -terms is axiom  $\simeq_{\rho}$ , which leads to  $\sigma$ -equivalence failing to be a strong bisimulation. We learn that we cannot remove  $\simeq_{\rho}$  entirely, since it is needed to close other commutation diagrams in the proof of strong bisimulation. However, a restriction of  $\simeq_{\rho}$  turns out to suffice. This restriction is formulated thanks to the notion of explicit renaming, which we introduce in our calculus  $\Lambda M$ . More concisely, the use of explicit renamings allows us to show that  $\sigma$ -equivalence is exactly captured by our strong bisimulation together with a simple axiom identifying explicit with implicit renaming (axiom  $\simeq_{\text{ren}}$ ). Failing to distinguish these two forms of renaming in Laurent's  $\sigma$ -equivalence makes impossible the bisimulation property.

Besides [Lau03], which inspired this paper and has been discussed at length, we briefly mention further related work. In [Acc13], polarised MELL are represented by proof-nets without boxes, by using the polarity information to transform explicit !-boxes into more compact structures.

In [KV19], the  $\lambda\mu$ -calculus is refined to a calculus  $\lambda\mu\mathbf{s}$  with explicit operators, together with a *linear* substitution/replacement operational semantics *at a distance*. At first sight  $\lambda\mu\mathbf{s}$  seems to be more atomic than  $\Lambda M$ . However,  $\lambda\mu\mathbf{s}$  forces the explicit replacements to be evaluated from left to right, *i.e.* there is no mechanism of composition. Moreover, explicit replacements in  $\lambda\mu\mathbf{s}$  are defined on terms, and not on stacks, and renamings are

still implicit, thus the calculus is not able to capture an appropriate notion of bisimulation such as the one presented in this paper.

Other classical term calculi exist, *e.g.* [CH00, Aud94, Pol04, vBV14], but none of these formalisms decomposes term reduction by means of a fine distinction between multiplicative and exponential rules. Moreover, all these calculi lack an explicit renaming operation. Thus, the main ingredients needed to build a strong bisimulation are simply not available. Of particular interest would be to understand how to integrate explicit renaming in  $\lambda\mu\tilde{\mu}$  [CH00], a calculus inspired from sequent calculus which is constructed as a perfectly symmetric formalism to deal uniformly with CBN and CBV.

A further related reference is [HL10], where PPNs are used to interpret processes from the  $\pi$ -calculus. A precise correspondence is established between PPN and a typed version of the asynchronous  $\pi$ -calculus. Moreover, they show that Laurent’s  $\simeq_\sigma$  corresponds exactly to structural equivalence of  $\pi$ -calculus processes (Prop. 1 in *op.cit.*). In [LR03] Laurent and Regnier show that there is a precise correspondence between CPS translations from classical calculi (such as  $\lambda\mu$ ) into intuitionistic ones on the one hand, and translations between LLP and LL on the other.

It would be interesting to analyse other rewriting properties of our term language such as preservation of  $\lambda\mu$ -strong normalisation of the reduction relations  $\rightarrow_{\Lambda M}$  and  $\rightsquigarrow$  or confluence of  $\rightsquigarrow$ .

Moreover, following the computational interpretation of *deep inference* provided by the intuitionistic atomic lambda-calculus [GHP13], it would be interesting to investigate a classical extension and its corresponding notion of strong bisimulation. It is also natural to wonder what would be an ideal syntax for classical logic, that is able to capture strong bisimulation by reducing the syntactical axioms to a small and simple set of equations.

Explicit Substitutions are a means of modeling sharing in lambda calculi and hence well suited for capturing call-by-need [ABM14]. We believe  $\Lambda M$  may prove useful in devising a notion of call-by-need for classical computation.

Finally, our notion of  $\simeq$ -equivalence could facilitate proofs of correctness between abstract machines and  $\lambda\mu$  (like [ABM14] for lambda-calculus) and help establish whether abstract machines for  $\lambda\mu$  are “reasonable” [ABM14].

## REFERENCES

- [ABKL14] Beniamino Accattoli, Eduardo Bonelli, Delia Kesner, and Carlos Lombardi. A nonstandard standardization theorem. In *The 41st Annual ACM SIGPLAN-SIGACT Symposium on Principles of Programming Languages, POPL ’14, San Diego, CA, USA, January 20-21, 2014*, pages 659–670, 2014.
- [ABM14] Beniamino Accattoli, Pablo Barenbaum, and Damiano Mazza. Distilling abstract machines. In *Proceedings of the 19th ACM SIGPLAN international conference on Functional programming, Gothenburg, Sweden, September 1-3, 2014*, pages 363–376, 2014.
- [Acc13] Beniamino Accattoli. Compressing polarized boxes. In *28th Annual ACM/IEEE Symposium on Logic in Computer Science, LICS 2013, New Orleans, LA, USA, June 25-28, 2013*, pages 428–437, 2013.
- [Acc18] Beniamino Accattoli. Proof nets and the linear substitution calculus. In *Theoretical Aspects of Computing - ICTAC 2018 - 15th International Colloquium, Stellenbosch, South Africa, October 16-19, 2018, Proceedings*, pages 37–61, 2018.
- [AK10] Beniamino Accattoli and Delia Kesner. The structural *lambda*-calculus. In Anuj Dawar and Helmut Veith, editors, *Computer Science Logic, 24th International Workshop, CSL 2010, 19th Annual Conference of the EACSL, Brno, Czech Republic, August 23-27, 2010. Proceedings*, volume 6247 of *Lecture Notes in Computer Science*, pages 381–395. Springer, 2010.

- [AK12a] Beniamino Accattoli and Delia Kesner. The permutative  $\lambda$ -calculus. In *Logic for Programming, Artificial Intelligence, and Reasoning - 18th International Conference, LPAR-18, Mérida, Venezuela, March 11-15, 2012. Proceedings*, pages 23–36, 2012.
- [AK12b] Beniamino Accattoli and Delia Kesner. Preservation of strong normalisation modulo permutations for the structural lambda-calculus. *Log. Methods Comput. Sci.*, 8(1), 2012.
- [And90] Jean-Marc Andreoli. *Proposition pour une synthèse des paradigmes de la programmation logique et de la programmation par objets*. PhD thesis, Université Paris VI, 1990.
- [Aud94] Philippe Audebaud. Explicit substitutions for the lambda-mu-calculus. Technical Report RR-1994-26, LIP, Ecole Normale Supérieure de Lyon, Lyon, 1994.
- [BKvO03] Marc Bezem, Jan Willem Klop, and Vincent van Oostrom. *Term Rewriting Systems (TeReSe)*. Cambridge University Press, 2003.
- [BN98] Franz Baader and Tobias Nipkow. *Term rewriting and all that*. Cambridge University Press, 1998.
- [CH00] Pierre-Louis Curien and Hugo Herbelin. The duality of computation. In *Proceedings of the Fifth ACM SIGPLAN International Conference on Functional Programming (ICFP '00), Montreal, Canada, September 18-21, 2000.*, pages 233–243, 2000.
- [CHL96] Pierre-Louis Curien, Thérèse Hardin, and Jean-Jacques Lévy. Confluence properties of weak and strong calculi of explicit substitutions. *J. ACM*, 43(2):362–397, 1996.
- [dG94] Philippe de Groote. On the relation between the lambda-mu-calculus and the syntactic theory of sequential control. In *Logic Programming and Automated Reasoning, 5th International Conference, LPAR'94, Kiev, Ukraine, July 16-22, 1994, Proceedings*, pages 31–43, 1994.
- [GHP13] Tom Gundersen, Willem Heijltjes, and Michel Parigot. Atomic lambda calculus: A typed lambda-calculus with explicit sharing. In *28th Annual ACM/IEEE Symposium on Logic in Computer Science, LICS 2013, New Orleans, LA, USA, June 25-28, 2013*, pages 311–320, 2013.
- [Gir87] Jean-Yves Girard. Linear logic. *Theoretical Computer Science*, 50:1–102, 1987.
- [Gir91] Jean-Yves Girard. A new constructive logic: Classical logic. *Math. Struct. Comput. Sci.*, 1(3):255–296, 1991.
- [Gri90] Timothy Griffin. A formulae-as-types notion of control. In *Conference Record of the Seventeenth Annual ACM Symposium on Principles of Programming Languages, San Francisco, California, USA, January 1990*, pages 47–58, 1990.
- [Her94] Hugo Herbelin. A lambda-calculus structure isomorphic to gentzen-style sequent calculus structure. In Leszek Pacholski and Jerzy Tiuryn, editors, *Computer Science Logic, 8th International Workshop, CSL '94, Kazimierz, Poland, September 25-30, 1994, Selected Papers*, volume 933 of *Lecture Notes in Computer Science*, pages 61–75. Springer, 1994.
- [HL10] Kohei Honda and Olivier Laurent. An exact correspondence between a typed pi-calculus and polarised proof-nets. *Theor. Comput. Sci.*, 411(22-24):2223–2238, 2010.
- [KBV20] Delia Kesner, Eduardo Bonelli, and Andrés Viso. Strong bisimulation for control operators (invited talk). In *28th EACSL Annual Conference on Computer Science Logic, CSL 2020, January 13-16, 2020, Barcelona, Spain*, pages 4:1–4:23, 2020.
- [Kes09] Delia Kesner. A theory of explicit substitutions with safe and full composition. *Logical Methods in Computer Science*, 5(3), 2009.
- [KV19] Delia Kesner and Pierre Vial. Non-idempotent types for classical calculi in natural deduction style. *Logical Methods in Computer Science*, 16(1), 2019.
- [Lau02] Olivier Laurent. *A study of polarization in logic*. PhD thesis, Université de la Méditerranée - Aix-Marseille II, 2002.
- [Lau03] Olivier Laurent. Polarized proof-nets and lambda- $\mu$ -calculus. *Theor. Comput. Sci.*, 290(1):161–188, 2003.
- [LR03] Olivier Laurent and Laurent Regnier. About translations of classical logic into polarized linear logic. In *18th IEEE Symposium on Logic in Computer Science (LICS 2003), 22-25 June 2003, Ottawa, Canada, Proceedings*, pages 11–20, 2003.
- [Nip90] Tobias Nipkow. A critical pair lemma for higher-order rewrite systems and its applications to  $\lambda^*$ . In *Proceedings of the First Workshop on Logical Frameworks, Antibes, France, May 1990*, pages 361–376, 1990.



- [Par92] Michel Parigot. Lambda-mu-calculus: An algorithmic interpretation of classical natural deduction. In Andrei Voronkov, editor, *Logic Programming and Automated Reasoning, International Conference LPAR'92, St. Petersburg, Russia, July 15-20, 1992, Proceedings*, volume 624 of *Lecture Notes in Computer Science*, pages 190–201. Springer, 1992.
- [Par93] Michel Parigot. Classical proofs as programs. In *Computational Logic and Proof Theory, Third Kurt Gödel Colloquium, KGC'93, Brno, Czech Republic, August 24-27, 1993, Proceedings*, pages 263–276, 1993.
- [Pol04] Emmanuel Polonovski. *Substitutions explicites, logique et normalisation. (Explicit substitutions, logic and normalization)*. PhD thesis, Paris Diderot University, France, 2004.
- [Reg94] Laurent Regnier. Une équivalence sur les lambda-termes. *Theor. Comput. Sci.*, 126(2):281–292, 1994.
- [Tak95] Masako Takahashi. Parallel reductions in lambda-calculus. *Inf. Comput.*, 118(1):120–127, 1995.
- [vBV14] Steffen van Bakel and Maria Grazia Vigliotti. A fully-abstract semantics of lambda-mu in the pi-calculus. In *Proceedings Fifth International Workshop on Classical Logic and Computation, CL&C 2014, Vienna, Austria, July 13, 2014*, pages 33–47, 2014.

#### APPENDIX A. CONFLUENCE OF THE $\Lambda M$ -CALCULUS

To prove confluence of the  $\Lambda M$ -calculus we use the interpretation method [CHL96], where  $\Lambda M$  is projected into the  $\lambda\mu\rho$ -calculus, introduced in what follows. Notice that we cannot simply project the  $\Lambda M$ -calculus into the  $\lambda\mu$ -calculus because of our built-in explicit renamings: indeed, it is not possible to purify our objects w.r.t. explicit renamings since there are no operations to do that inside the  $\Lambda M$ -calculus itself.

Given a countably infinite set of variables  $\mathbb{V} (x, y, \dots)$  and names  $\mathbb{N} (\alpha, \beta, \dots)$ , the sets of *objects*  $\mathbb{O}_{\lambda\mu\rho}$ , *terms*  $\mathbb{T}_{\lambda\mu\rho}$ , *commands*  $\mathbb{C}_{\lambda\mu\rho}$ , *stacks* and *contexts* of the  $\lambda\mu\rho$ -calculus are defined by the following grammar:

<b>(Objects)</b>	$o$	$::=$	$t \mid c \mid s$
<b>(Terms)</b>	$t$	$::=$	$x \mid tt \mid \lambda x.t \mid \mu\alpha.c$
<b>(Commands)</b>	$c$	$::=$	$[\alpha]t \mid c[\alpha \setminus \beta]$
<b>Stacks</b>	$s$	$::=$	$t \mid t \cdot s$
<b>(Contexts)</b>	$\mathbb{O}$	$::=$	$\mathbb{T} \mid \mathbb{C} \mid \mathbb{S}$
<b>(Term Contexts)</b>	$\mathbb{T}$	$::=$	$\square \mid \mathbb{T}t \mid t\mathbb{T} \mid \lambda x.\mathbb{T} \mid \mu\alpha.\mathbb{C}$
<b>(Command Contexts)</b>	$\mathbb{C}$	$::=$	$\square \mid [\alpha]\mathbb{T} \mid \mathbb{C}[\alpha \setminus \beta]$
<b>(Stack Contexts)</b>	$\mathbb{S}$	$::=$	$\square \mid \mathbb{T} \cdot s \mid t \cdot \mathbb{S}$

The commands of the  $\lambda\mu$ -calculus are enriched with an *explicit renaming*  $[\alpha \setminus \beta]$ . Notice that  $\mathbb{O}_{\lambda\mu\rho} \subset \mathbb{O}_{\Lambda M}$  (similarly  $\mathbb{T}_{\lambda\mu\rho} \subset \mathbb{T}_{\Lambda M}$  and  $\mathbb{C}_{\lambda\mu\rho} \subset \mathbb{C}_{\Lambda M}$ ).

We write  $\vec{\alpha}$  for a non-empty sequence of distinct names  $\alpha_1, \dots, \alpha_n$  and  $\text{sz}(\vec{\alpha})$  for the number of names in the sequence. The **simultaneous replacement operation** is inductively

defined as follows:

$$\begin{aligned}
x \langle \vec{\alpha} \setminus \vec{\beta} \ s \rangle &\triangleq x \\
(tu) \langle \vec{\alpha} \setminus \vec{\beta} \ s \rangle &\triangleq t \langle \vec{\alpha} \setminus \vec{\beta} \ s \rangle u \langle \vec{\alpha} \setminus \vec{\beta} \ s \rangle \\
(\lambda x.t) \langle \vec{\alpha} \setminus \vec{\beta} \ s \rangle &\triangleq \lambda x.t \langle \vec{\alpha} \setminus \vec{\beta} \ s \rangle && x \notin s \\
(\mu \gamma.c) \langle \vec{\alpha} \setminus \vec{\beta} \ s \rangle &\triangleq \mu \gamma.c \langle \vec{\alpha} \setminus \vec{\beta} \ s \rangle && \gamma \notin s, \gamma \notin \vec{\alpha}, \gamma \notin \vec{\beta} \\
([\alpha]t) \langle \vec{\alpha}_1 \alpha \vec{\alpha}_2 \setminus \vec{\beta}_1 \beta \vec{\beta}_2 \ s \rangle &\triangleq [\beta] (t \langle \vec{\alpha}_1 \alpha \vec{\alpha}_2 \setminus \vec{\beta}_1 \beta \vec{\beta}_2 \ s \rangle) :: s \\
([\gamma]t) \langle \vec{\alpha} \setminus \vec{\beta} \ s \rangle &\triangleq [\gamma] t \langle \vec{\alpha} \setminus \vec{\beta} \ s \rangle && \gamma \notin \vec{\alpha} \\
(c[\gamma \setminus \alpha]) \langle \vec{\alpha}_1 \alpha \vec{\alpha}_2 \setminus \vec{\beta}_1 \beta \vec{\beta}_2 \ s \rangle &\triangleq c \langle \gamma \vec{\alpha}_1 \alpha \vec{\alpha}_2 \setminus \delta \vec{\beta}_1 \beta \vec{\beta}_2 \ s \rangle [\delta \setminus \beta] && \delta \text{ fresh} \\
(c[\gamma \setminus \beta]) \langle \vec{\alpha} \setminus \vec{\beta} \ s \rangle &\triangleq (c \langle \vec{\alpha} \setminus \vec{\beta} \ s \rangle) [\gamma \setminus \beta] && \gamma \notin \vec{\alpha}, \gamma \notin \vec{\beta} \\
(t \cdot s') \langle \vec{\alpha} \setminus \vec{\beta} \ s \rangle &\triangleq t \langle \vec{\alpha} \setminus \vec{\beta} \ s \rangle \cdot s' \langle \vec{\alpha} \setminus \vec{\beta} \ s \rangle
\end{aligned}$$

Notice in the 7th line of the definition the case of a replacement affecting an explicit renaming which causes the accumulation of the names  $\gamma$  and  $\delta$  (this one fresh) in the replacement affecting the command  $c$ .

The **application of the substitution**  $\{x \setminus u\}$  to an  $\lambda\mu\rho$ -object  $o$  naturally extends that of the  $\lambda\mu$ -calculus (Sec. 3.1).

The **one-step reduction relation**  $\rightarrow_{\lambda\mu\rho}$  is defined as the closure by contexts  $\mathcal{O}_t$  of the rewriting rules  $\beta$  and  $\mu^s$ :

$$\begin{aligned}
(\lambda x.t)u &\mapsto_{\beta} t\{x \setminus u\} \\
(\mu\alpha.c) :: s &\mapsto_{\mu^s} \mu\alpha'.c \langle \alpha \setminus s \rangle
\end{aligned}$$

where  $\mapsto_{\mu^s}$  requires  $\alpha'$  to be a fresh name (*i.e.*  $\alpha' \neq \alpha$  and  $\alpha' \notin c$ ).

In what follows we introduce some auxiliary results about the simultaneous replacement operation.

**Lemma A.1.** *Let  $o \in \mathcal{O}_{\lambda\mu\rho}$  and let  $s$  be a stack. Then,*

- (1)  $o \langle \vec{\alpha} \setminus \vec{\beta} \ s \rangle = o \langle p(\vec{\alpha}) \setminus p(\vec{\beta}) \ s \rangle$  for every permutation  $p$  on  $[1, \text{sz}(\vec{\alpha})]$ , where  $\text{sz}(\vec{\alpha})$  measures the number of names in  $\vec{\alpha}$ .
- (2) If  $\alpha \notin \text{fn}(o)$ , then  $o \langle \vec{\alpha}_1 \alpha \vec{\alpha}_2 \setminus \vec{\beta}_1 \beta \vec{\beta}_2 \ s \rangle = o \langle \vec{\alpha}_1 \vec{\alpha}_2 \setminus \vec{\beta}_1 \beta \vec{\beta}_2 \ s \rangle$ .

*Proof.* By induction on  $o$ . □

**Corollary A.2.** *Let  $o \in \mathcal{O}_{\lambda\mu\rho}$  and let  $s$  be a stack. If  $\vec{\alpha} \cap \text{fn}(o) = \emptyset$ , then  $o \langle \vec{\alpha} \setminus \vec{\beta} \ s \rangle = o$ .*

**Lemma A.3.** *Let  $o \in \mathcal{O}_{\lambda\mu\rho}$ ,  $u \in \mathbb{T}_{\lambda\mu\rho}$  and let  $s$  be a stack.*

- (1) If  $x \notin \text{fv}(s)$ , then  $o\{x \setminus u\} \langle \vec{\alpha} \setminus \vec{\beta} \ s \rangle = o \langle \vec{\alpha} \setminus \vec{\beta} \ s \rangle \{x \setminus u \langle \vec{\alpha} \setminus \vec{\beta} \ s \rangle\}$ .
- (2) If  $\vec{\alpha} \cap \text{fn}(u) = \emptyset$ , then  $o \langle \vec{\alpha} \setminus \vec{\beta} \ s \rangle \{x \setminus u\} = o\{x \setminus u\} \langle \vec{\alpha} \setminus \vec{\beta} \ s \{x \setminus u\} \rangle$ .

*Proof.* By induction on  $o$ , using Cor. A.2. □

**Lemma A.4.** *Let  $o \in \mathcal{O}_{\lambda\mu\rho}$  and let  $s, s'$  be stacks. If the name sequences  $\vec{\alpha} = \vec{\alpha}_1 \vec{\alpha}_2$ ,  $\vec{\beta} = \vec{\beta}_1 \vec{\beta}_2$ ,  $\vec{\gamma} = \vec{\gamma}_1 \vec{\gamma}_2$  and  $\vec{\delta} = \vec{\delta}_1 \vec{\delta}_2$  are such that  $\vec{\beta}_1 = \vec{\gamma}_1$ ,  $\vec{\beta}_2 \cap \vec{\gamma}_2 = \emptyset$ ,  $\chi \notin s'$  for all  $\chi \in \vec{\alpha}$ , and  $\vec{\beta} \vec{\delta}$  are fresh names, then  $o \langle \vec{\alpha} \setminus \vec{\beta} \ s \rangle \langle \vec{\gamma} \setminus \vec{\delta} \ s' \rangle = o \langle \vec{\gamma}_2 \setminus \vec{\delta}_2 \ s' \rangle \langle \vec{\alpha}_1 \setminus \vec{\delta}_1 \ s \langle \vec{\gamma}_1 \setminus \vec{\delta}_1 \ s' \rangle \cdot s' \rangle \langle \vec{\alpha}_2 \setminus \vec{\beta}_2 \ s \langle \vec{\gamma}_1 \setminus \vec{\delta}_1 \ s' \rangle \rangle$ .*

*Proof.* By induction on  $o$  using Lem. A.1. □

**Lemma A.5.** *Let  $o \in \mathbb{O}_{\lambda\mu\rho}$  and  $s$  be a stack. If the name sequences  $\vec{\alpha}$ ,  $\vec{\beta}$ ,  $\vec{\gamma}$  and  $\vec{\delta}$  are such that  $\vec{\beta} \cap \vec{\gamma} = \emptyset$  and  $\chi \notin s$  for all  $\chi \in \vec{\gamma}$ , then  $o \langle \vec{\alpha} \setminus \vec{\beta} \ s \rangle \langle \vec{\gamma} \setminus \vec{\delta} \ s \rangle = o \langle \vec{\gamma} \vec{\alpha} \setminus \vec{\delta} \vec{\beta} \ s \rangle$ .*

*Proof.* By induction on  $o$  using Cor. A.2 and Lem. A.1.  $\square$

**Confluence of the  $\lambda\mu\rho$ -calculus.** Confluence of  $\lambda\mu\rho$  is shown by means of Tait–Martin–Löf’s method [Tak95]. For that, we introduce a notion of parallel reduction on  $\lambda\mu\rho$ -objects.

The **parallel reduction relation**  $\Rightarrow_{\lambda\mu\rho}$  for  $\lambda\mu\rho$ -objects is defined by induction as follows:

$$\begin{array}{c} \frac{}{x \Rightarrow_{\lambda\mu\rho} x} \text{ (R-VAR)} \quad \frac{t \Rightarrow_{\lambda\mu\rho} t' \quad u \Rightarrow_{\lambda\mu\rho} u'}{t u \Rightarrow_{\lambda\mu\rho} t' u'} \text{ (R-APP)} \quad \frac{t \Rightarrow_{\lambda\mu\rho} t'}{\lambda x.t \Rightarrow_{\lambda\mu\rho} \lambda x.t'} \text{ (R-ABS)} \\ \\ \frac{c \Rightarrow_{\lambda\mu\rho} c'}{\mu\alpha.c \Rightarrow_{\lambda\mu\rho} \mu\alpha.c'} \text{ (R-CONT)} \quad \frac{t \Rightarrow_{\lambda\mu\rho} t'}{[\alpha]t \Rightarrow_{\lambda\mu\rho} [\alpha]t'} \text{ (R-NAME)} \\ \\ \frac{c \Rightarrow_{\lambda\mu\rho} c'}{c[\alpha \setminus \beta] \Rightarrow_{\lambda\mu\rho} c'[\alpha \setminus \beta]} \text{ (R-REN)} \quad \frac{t \Rightarrow_{\lambda\mu\rho} t' \quad s \Rightarrow_{\lambda\mu\rho} s'}{t \cdot s \Rightarrow_{\lambda\mu\rho} t' \cdot s'} \text{ (R-PUSH)} \\ \\ \frac{t \Rightarrow_{\lambda\mu\rho} t' \quad u \Rightarrow_{\lambda\mu\rho} u'}{(\lambda x.t) u \Rightarrow_{\lambda\mu\rho} s' \{x \setminus t'\}} \text{ (R-BETA)} \quad \frac{c \Rightarrow_{\lambda\mu\rho} c' \quad s \Rightarrow_{\lambda\mu\rho} s'}{(\mu\alpha.c) :: s \Rightarrow_{\lambda\mu\rho} \mu\alpha'.c' \langle \alpha \setminus \alpha' \ s' \rangle} \text{ (R-MU)} \end{array}$$

Notice that the parallel reduction relation is reflexive.

In what follows we study the stability of  $\Rightarrow_{\lambda\mu\rho}$  by substitution and replacement.

**Lemma A.6.** *Let  $o, o' \in \mathbb{O}_{\lambda\mu\rho}$ ,  $u, u' \in \mathbb{T}_{\lambda\mu\rho}$  and  $s, s'$  be stacks such that  $o \Rightarrow_{\lambda\mu\rho} o'$ ,  $u \Rightarrow_{\lambda\mu\rho} u'$  and  $s \Rightarrow_{\lambda\mu\rho} s'$ . Then,  $o \{x \setminus u\} \Rightarrow_{\lambda\mu\rho} o' \{x \setminus u'\}$  and  $o \langle \vec{\alpha} \setminus \vec{\beta} \ s \rangle \Rightarrow_{\lambda\mu\rho} o' \langle \vec{\alpha} \setminus \vec{\beta} \ s' \rangle$ .*

*Proof.* Both statements are by induction on  $o \Rightarrow_{\lambda\mu\rho} o'$ . The second one uses Lem. A.3 and Lem. A.4.  $\square$

A last auxiliary result shows that the parallel reduction starting at a term of the form  $(\mu\alpha.c) :: s$  represents a  $\mu$ -abstraction consuming all, some or none of the arguments  $s$ .

**Lemma A.7.** *Let  $t \in \mathbb{T}_{\lambda\mu\rho}$ ,  $c \in \mathbb{C}_{\lambda\mu\rho}$  and let  $s$  be a stack such that  $(\mu\alpha.c) :: s \Rightarrow_{\lambda\mu\rho} t$ . Then,*

- (1)  $t = (\mu\alpha'.c') :: s'$  with  $c \Rightarrow_{\lambda\mu\rho} c'$  and  $s \Rightarrow_{\lambda\mu\rho} s'$ ; or
- (2)  $t = \mu\alpha'.c' \langle \alpha \setminus \alpha' \ s' \rangle$  with  $c \Rightarrow_{\lambda\mu\rho} c'$  and  $s \Rightarrow_{\lambda\mu\rho} s'$ ; or
- (3)  $t = (\mu\alpha'.c' \langle \alpha \setminus \alpha' \ s'_0 \rangle) :: s'_1$  with  $s = s_0 \cdot s_1$ ,  $c \Rightarrow_{\lambda\mu\rho} c'$  and  $s \Rightarrow_{\lambda\mu\rho} s'_0 \cdot s'_1$ .

*Proof.* By induction on  $(\mu\alpha.c) :: s \Rightarrow_{\lambda\mu\rho} t$ .  $\square$

Confluence of the parallel reduction relation is a consequence of the fact that  $\Rightarrow_{\lambda\mu\rho}$  enjoys the diamond property [Nip90, BKvO03]. The proof uses the previous auxiliary lemmas.

**Lemma A.8.** *The parallel reduction relation  $\Rightarrow_{\lambda\mu\rho}$  satisfies the diamond property, and thus is confluent (CR).*

*Proof.* Let  $o \Rightarrow_{\lambda\mu\rho} o_0$  and  $o \Rightarrow_{\lambda\mu\rho} o_1$ . We prove that there is  $o'$  such that  $o_0 \Rightarrow_{\lambda\mu\rho} o'$  and  $o_1 \Rightarrow_{\lambda\mu\rho} o'$ . The proof is by induction on  $o$  and uses Lem. A.6, and Lem. A.7.  $\square$

Last, in order to deduce confluence of  $\lambda\mu\rho$  by means of Tait–Martin-Löf’s method, it is sufficient to prove that  $\Rightarrow_{\lambda\mu\rho}$  extends  $\rightarrow_{\lambda\mu\rho}$  and at the same time is included in the reflexive-transitive closure  $\twoheadrightarrow_{\lambda\mu\rho}$ .

**Lemma A.9.**  $\rightarrow_{\lambda\mu\rho} \subseteq \Rightarrow_{\lambda\mu\rho} \subseteq \twoheadrightarrow_{\lambda\mu\rho}$ .

*Proof.* To show  $o \rightarrow_{\lambda\mu\rho} o'$  implies  $o \Rightarrow_{\lambda\mu\rho} o'$  one proceeds by induction on  $o \rightarrow_{\lambda\mu\rho} o'$ . To show  $o \Rightarrow_{\lambda\mu\rho} o'$  implies  $o \twoheadrightarrow_{\lambda\mu\rho} o'$  one also proceeds by induction on  $o \Rightarrow_{\lambda\mu\rho} o'$ .  $\square$

Confluence of  $\rightarrow_{\lambda\mu\rho}$  is an immediate consequence of Lem. A.8 and Lem. A.9.

**Theorem A.10.** *The reduction relation  $\rightarrow_{\lambda\mu\rho}$  is confluent (CR).*

*Proof.* From Lem. A.9 we get  $\Rightarrow_{\lambda\mu\rho}^* = \twoheadrightarrow_{\lambda\mu\rho}$ . Then, the following diagram holds:

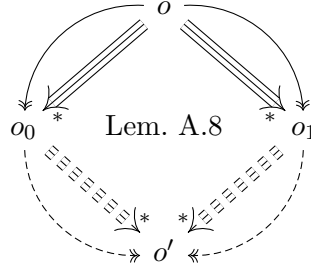

$\square$

**Confluence of the  $\Lambda M$ -calculus.** Confluence of the  $\Lambda M$ -calculus is proved by using the interpretation method [CHL96], which projects  $\Lambda M$ -objects into  $\lambda\mu\rho$ -objects.

**Definition A.11.** *The projection  $\downarrow$  from  $\Lambda M$ -objects to  $\lambda\mu\rho$ -objects is defined as*

$$\begin{array}{ll}
 x^\downarrow \triangleq x & ([\alpha]t)^\downarrow \triangleq [\alpha]t^\downarrow \\
 (tu)^\downarrow \triangleq t^\downarrow u^\downarrow & (c[\alpha \setminus^{\alpha'} s])^\downarrow \triangleq c^\downarrow \langle \alpha \setminus^{\alpha'} s^\downarrow \rangle \\
 (\lambda x.t)^\downarrow \triangleq \lambda x.t^\downarrow & (c[\alpha \setminus \beta])^\downarrow \triangleq c^\downarrow [\alpha \setminus \beta] \\
 (\mu \alpha.c)^\downarrow \triangleq \mu \alpha.c^\downarrow & (s \cdot t)^\downarrow \triangleq s^\downarrow \cdot t^\downarrow \\
 (t[x \setminus u])^\downarrow \triangleq t^\downarrow \{x \setminus u^\downarrow\} & 
 \end{array}$$

**Lemma A.12.** *Let  $o \in \mathcal{O}_{\Lambda M}$ ,  $u \in \mathbb{T}_{\Lambda M}$  and  $s$  be a stack. Then,  $(o\{x \setminus u\})^\downarrow = o^\downarrow \{x \setminus u^\downarrow\}$  and  $(o\langle \alpha \setminus^{\alpha'} s \rangle)^\downarrow = o^\downarrow \langle \alpha \setminus^{\alpha'} s^\downarrow \rangle$ .*

*Proof.* Both statements are by induction on  $o$ , using Lem. A.3, Lem. A.4, and Lem. A.5.  $\square$

**Lemma A.13.** *Let  $o, o' \in \mathcal{O}_{\lambda\mu\rho}$  and  $u, u' \in \mathbb{T}_{\lambda\mu\rho}$  and  $s, s'$  be stacks such that  $o \rightarrow_{\lambda\mu\rho} o'$ ,  $u \rightarrow_{\lambda\mu\rho} u'$  and  $s \rightarrow_{\lambda\mu\rho} s'$ . Then,*

- (1)  $o\{x \setminus u\} \rightarrow_{\lambda\mu\rho} o'\{x \setminus u\}$ .
- (2)  $o\{x \setminus u\} \twoheadrightarrow_{\lambda\mu\rho} o\{x \setminus u'\}$ .
- (3)  $o\langle \vec{\alpha} \setminus^{\vec{\alpha}'} s \rangle \rightarrow_{\lambda\mu\rho} o'\langle \vec{\alpha} \setminus^{\vec{\alpha}'} s \rangle$ .
- (4)  $o\langle \vec{\alpha} \setminus^{\vec{\alpha}'} s \rangle \twoheadrightarrow_{\lambda\mu\rho} o\langle \vec{\alpha} \setminus^{\vec{\alpha}'} s' \rangle$ .

*Proof.* Items (1) and (3) are by induction on  $o \rightarrow_{\lambda\mu\rho} o'$ , while items (2) and (4) are by induction on  $o$ . The proof uses Lem. A.3 and Lem. A.4.  $\square$

Given a stack  $s$  in the  $\lambda\mu\rho$ -calculus and sequence of distinct names  $\vec{\alpha}$  and  $\vec{\alpha}'$  such that  $\text{sz}(\alpha) = \text{sz}(\alpha') = n$ , we denote by  $(\{\alpha_i \setminus^{\alpha'_i} s\})_{i \leq n}$  the sequence of single replacements over each name of the sequence  $\vec{\alpha}$  (in the same order),  $\{\alpha_n \setminus^{\alpha'_n} s\} \dots \{\alpha_1 \setminus^{\alpha'_1} s\}$ .

**Lemma A.14.** *Let  $o \in \mathbb{O}_{\lambda\mu\rho}$ , let  $s$  be a stack,  $\vec{\alpha}$  and  $\vec{\alpha}'$  be sequences of distinct names such that  $\vec{\alpha} \cap \text{fn}(s) = \emptyset$ . Then,  $o(\{\alpha_i \setminus^{\alpha'_i} s\})_{i \leq \text{sz}(\vec{\alpha})} \twoheadrightarrow_{\Lambda M} o\langle\vec{\alpha} \setminus^{\vec{\alpha}'} s\rangle$ .*

*Proof.* By induction on  $o$ , using Lem. A.1 □

Last, to apply the interpretation method we need to relate the relations  $\twoheadrightarrow_{\Lambda M}$  and  $\twoheadrightarrow_{\lambda\mu\rho}$  by means the projection function  $\_ \downarrow$ .

**Lemma A.15.**

- (1) *Let  $o \in \mathbb{O}_{\Lambda M}$ . Then,  $o \twoheadrightarrow_{\Lambda M} o^\downarrow$ .*
- (2) *Let  $o, o' \in \mathbb{O}_{\lambda\mu\rho}$ . If  $o \twoheadrightarrow_{\lambda\mu\rho} o'$ , then  $o \twoheadrightarrow_{\Lambda M} o'$ .*
- (3) *Let  $o, o' \in \mathbb{O}_{\Lambda M}$ . If  $o \twoheadrightarrow_{\Lambda M} o'$ , then  $o^\downarrow \twoheadrightarrow_{\lambda\mu\rho} o'^\downarrow$ .*

*Proof.*

- (1) By induction on  $o$  using Lem. A.14.
- (2) By induction on  $o \twoheadrightarrow_{\lambda\mu\rho} o'$  using Lem. A.14, Lem. A.4, Cor. A.2
- (3) By induction on  $o \twoheadrightarrow_{\Lambda M} o'$  using Lem. A.12, Lem. A.13, Lem. A.14.

□

Confluence of  $\twoheadrightarrow_{\Lambda M}$  is a consequence of Lem. A.15 and confluence of  $\twoheadrightarrow_{\lambda\mu\rho}$  (Thm. A.10).

**Theorem 4.3.** *The reduction relation  $\twoheadrightarrow_{\Lambda M}$  is confluent (CR).*

*Proof.* By the interpretation method, using confluence of  $\twoheadrightarrow_{\lambda\mu\rho}$  and Lem. A.15:

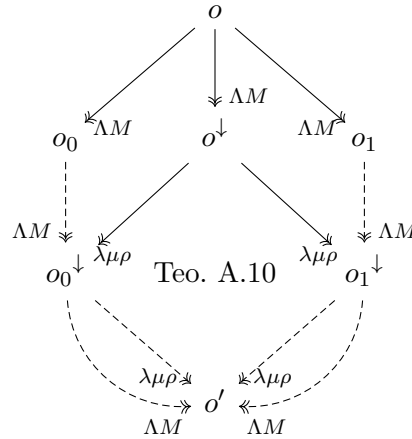

where  $o \twoheadrightarrow_{\Lambda M} o_0$  and  $o \twoheadrightarrow_{\Lambda M} o_1$  are the hypothesis of the theorem. The three vertical reductions are justified by Lem. A.15 (1), since  $p \twoheadrightarrow_{\Lambda M} p^\downarrow$  for all  $o \in \mathbb{O}_{\Lambda M}$ . The reductions  $o^\downarrow \twoheadrightarrow_{\lambda\mu\rho} o_0^\downarrow$  and  $o^\downarrow \twoheadrightarrow_{\lambda\mu\rho} o_1^\downarrow$  come from Lem. A.15 (3). The diagram is closed by Theorem A.10 thus obtaining  $o_0^\downarrow \twoheadrightarrow_{\Lambda M} o^\downarrow$  y  $o_1^\downarrow \twoheadrightarrow_{\Lambda M} o^\downarrow$  by Lem. A.15 (2). □

APPENDIX B. THE SIMPLY TYPED  $\Lambda M$ -CALCULUS

**Lemma B.1** (Stacks).

- (1) Let  $\pi_s \triangleright_{\mathcal{E}} \Gamma \vdash s : S \mid \Delta$  and  $\pi_{s'} \triangleright_{\mathcal{E}} \Gamma' \vdash s' : S' \mid \Delta'$ .  
Then, there exists  $\pi_{s \cdot s'} \triangleright_{\mathcal{E}} \Gamma \cup \Gamma' \vdash s \cdot s' : S \cdot S' \mid \Delta \cup \Delta'$ .
- (2) Let  $\pi_{s \cdot s'} \triangleright_{\mathcal{E}} \Gamma^* \vdash s \cdot s' : S^* \mid \Delta^*$ . Then, there exist  $\pi_s \triangleright_{\mathcal{E}} \Gamma \vdash s : S \mid \Delta$  and  $\pi_{s'} \triangleright_{\mathcal{E}} \Gamma' \vdash s' : S' \mid \Delta'$  such that  $S^* = S \cdot S'$ ,  $\Gamma^* = \Gamma \cup \Gamma'$  and  $\Delta^* = \Delta \cup \Delta'$ .
- (3) Let  $\pi_t \triangleright_{\mathcal{E}} \Gamma \vdash t : S \rightarrow A \mid \Delta$  and  $\pi_s \triangleright_{\mathcal{E}} \Gamma' \vdash s : S \mid \Delta'$ .  
Then, there exists  $\pi_{t :: s} \triangleright_{\mathcal{E}} \Gamma \cup \Gamma' \vdash t :: s : A \mid \Delta \cup \Delta'$ .
- (4) Let  $\pi_{t :: s} \triangleright_{\mathcal{E}} \Gamma^* \vdash t :: s : A \mid \Delta^*$ . Then, there exist  $\pi_t \triangleright_{\mathcal{E}} \Gamma \vdash t : S \rightarrow A \mid \Delta$  and  $\pi_s \triangleright_{\mathcal{E}} \Gamma' \vdash s : S \mid \Delta'$  such that  $\Gamma^* = \Gamma \cup \Gamma'$  and  $\Delta^* = \Delta \cup \Delta'$ .

*Proof.* By induction on  $s$  □

**Lemma B.2** (Substitution). Let  $\pi_o \triangleright_{\mathcal{E}} \Gamma; (x : B)^{\leq 1} \vdash o : T \mid \Delta$  and  $\pi_u \triangleright_{\mathcal{E}} \Gamma' \vdash u : B \mid \Delta'$ . Then, there exists  $\pi_{o\{x \setminus u\}} \triangleright_{\mathcal{E}} \Gamma^* \vdash o\{x \setminus u\} : T \mid \Delta^*$  such that  $\Gamma^* \subseteq \Gamma \cup \Gamma'$  and  $\Delta^* \subseteq \Delta \cup \Delta'$ .

*Proof.* By induction on  $o$ . □

**Lemma B.3** (Replacement). Let  $\pi_o \triangleright_{\mathcal{E}} \Gamma \vdash o : T \mid \Delta; (\alpha : S \rightarrow B)^{\leq 1}$  and  $\pi_s \triangleright_{\mathcal{E}} \Gamma' \vdash s : S \mid \Delta'$ . Then, there exists  $\pi_{o\{\alpha \setminus \alpha' s\}} \triangleright_{\mathcal{E}} \Gamma^* \vdash o\{\alpha \setminus \alpha' s\} : T \mid \Delta^*$  such that  $\Gamma^* \subseteq \Gamma \cup \Gamma'$  and  $\Delta^* \subseteq \Delta \cup \Delta' \cup \alpha' : B$ .

*Proof.* By induction on  $o$  using Lem. B.1. □

**Theorem 4.5** (Subject Reduction). Let  $o \in \mathcal{O}_{\Lambda M}$ . If  $\pi \triangleright_{\mathcal{E}} \Gamma \vdash o : T \mid \Delta$  and  $o \rightarrow_{\Lambda M} o'$ , then there is  $\pi' \triangleright_{\mathcal{E}} \Gamma' \vdash o' : T \mid \Delta'$  such that  $\Gamma' \subseteq \Gamma$  and  $\Delta' \subseteq \Delta$ .

*Proof.* By definition  $o \rightarrow_{\Lambda M} o'$  implies  $o = \mathcal{O}\langle l \rangle$  and  $o' = \mathcal{O}\langle r \rangle$  with  $l \mapsto_* r$ ,  $* \in \{\text{dB}, \text{dM}, \text{S}, \text{R}\}$ . The proof is by induction on  $\mathcal{O}$ .

- $\mathcal{O} = \square$ . Then, there are three possible cases:
  - (1) dB. Then  $o = L\langle \lambda x.t \rangle u \rightarrow_{\text{dB}} L\langle t[x \setminus u] \rangle = o'$ . This case can be formally proved by induction on  $L$  and is immediate (the inductive case uses Lem. 4.4).
  - (2) S. Then  $o = t[x \setminus u] \rightarrow_{\text{S}} t\{x \setminus u\} = o'$ . We conclude by Lem. B.2.
  - (3) dM. Then  $o = L\langle \mu \alpha.c \rangle u \rightarrow_{\text{dM}} L\langle \mu \alpha'.c \{\alpha \setminus \alpha' u\} \rangle = o'$ , where  $\alpha'$  is fresh. This case can be formally proved by induction on  $L$  and is immediate (the inductive case uses Lem. 4.4).
- $\mathcal{O} = \square$ . Then we necessarily have  $o = c\{\alpha \setminus \alpha' s\} \rightarrow_{\text{R}} c\{\alpha \setminus \alpha' s\} = o'$ . We then conclude by Lem. B.3.
- All the inductive cases are straightforward. □

## APPENDIX C. TRANSLATION TO PROOF-NETS

Given a typed object  $o \in \mathcal{O}_{\Lambda M}$  and variables  $x$  and  $y$ ,  $(\pi_o)^{\diamond, x, y}$  denotes the polarised proof-net which results from adding a contraction node between the wires  $x$  and  $y$ , assuming  $x, y \in \text{fv}(o)$ . If  $x \in \text{fv}(o)$  and  $y \notin \text{fv}(o)$ , then  $(\pi_o)^{\diamond, x, y}$  denotes the polarised proof-net that results from simply replacing all labels  $x$  with  $y$ . Otherwise,  $(\pi_o)^{\diamond, x, y} \triangleq (\pi_o)^{\diamond}$ . Similarly for names  $\alpha$  and  $\beta$ , respectively. Note that given a command  $c$ , we have  $(\pi_c)^{\diamond, \alpha, \beta} = (\pi_{c[\alpha \setminus \beta]})^{\diamond}$ .

**Lemma C.1.** *Let  $o \in \mathcal{O}_{\Lambda M}$  be typed. Then  $(\pi_{o\{x \setminus y\}})^\diamond \equiv (\pi_o)^{\diamond, x, y}$  and  $(\pi_{o\{\alpha \setminus \beta\}})^\diamond \equiv (\pi_o)^{\diamond, \alpha, \beta}$ .*

*Proof.* By induction on  $o$ . We illustrate only the case where  $o = tu$ . Then  $o\{x \setminus y\} = t\{x \setminus y\}u\{x \setminus y\}$ . By *i.h.* we have  $(\pi_{t\{x \setminus y\}})^\diamond \equiv (\pi_t)^{\diamond, x, y}$  and  $(\pi_{u\{x \setminus y\}})^\diamond \equiv (\pi_u)^{\diamond, x, y}$ . We only depict the case  $x, y \in \text{fv}(t)$  and  $x, y \in \text{fv}(u)$ , the remaining ones result in simpler PPNs. Thus we have:

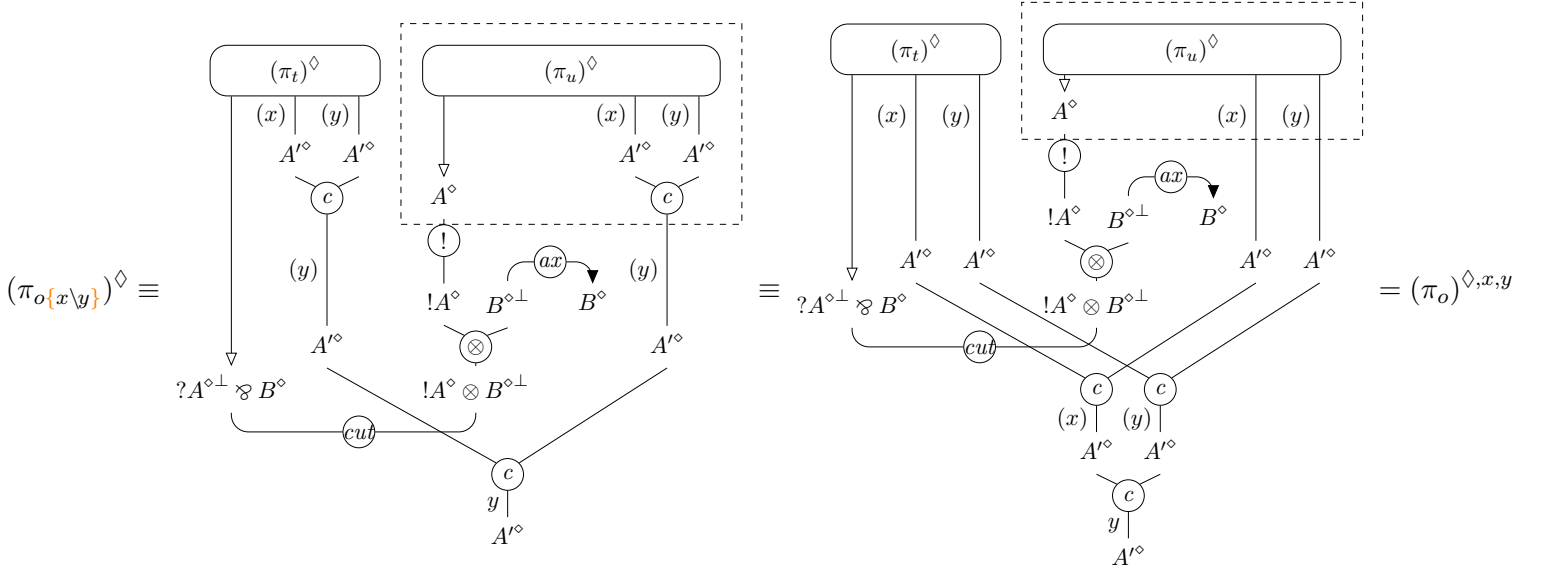

The case for  $\alpha$  and  $\beta$  is analogous. □

**Lemma C.2** (Substitution). *Let  $o \in \mathcal{O}_{\Lambda M}$  and  $u \in \mathbb{T}_{\Lambda M}$  be typed such that  $\text{fv}(o) \cap \text{fv}(u) = \emptyset$  and  $\text{fn}(o) \cap \text{fn}(u) = \emptyset$ . Then*

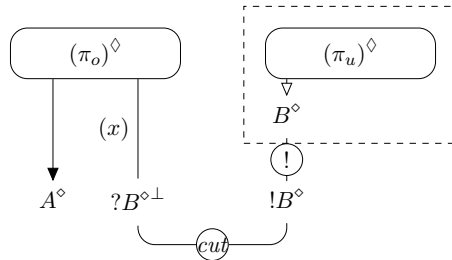

*reduces to a PPN structurally equivalent to  $(\pi_{o\{x \setminus u\}})^\diamond$ .*

*Proof.* By induction on  $o$  as in [Lau02] Lem. 11.7, using our definition of the translation. Notice that the case where  $x \notin \text{fv}(o)$  is trivial since  $o\{x \setminus u\} = o$  and applying  $\mathcal{C}(!, w)$  allows to obtain a proof-net structurally equivalent to  $(\pi_o)^\diamond$  by the fifth rule in Fig. 8. Thus, in the sequel we assume  $x \in \text{fv}(o)$ .

- $o = x$ . Then we perform a  $\mathcal{C}(!, d)$ -step followed by a  $\mathcal{C}(ax)$ -step to obtain  $(\pi_u)^\diamond = (\pi_{o\{x \setminus u\}})^\diamond$  and conclude.
- $o = y \neq x$ . This case does not apply since  $x \notin \text{fv}(o)$ .

- $o = tv$ . If  $x \in \text{fv}(t)$  and  $x \in \text{fv}(v)$ , then  $(\pi_o)^\diamond$  has a contraction node between the edges labelled  $x$  in  $(\pi_t)^\diamond$  and  $(\pi_v)^\diamond$ . Then, performing one  $\mathcal{C}(!, c)$ -step followed by one  $\mathcal{C}(!, !)$ -step, we obtain the following proof-net (where  $\Gamma$  and  $\Delta$  are variable/name contexts in  $\pi_u$ ):

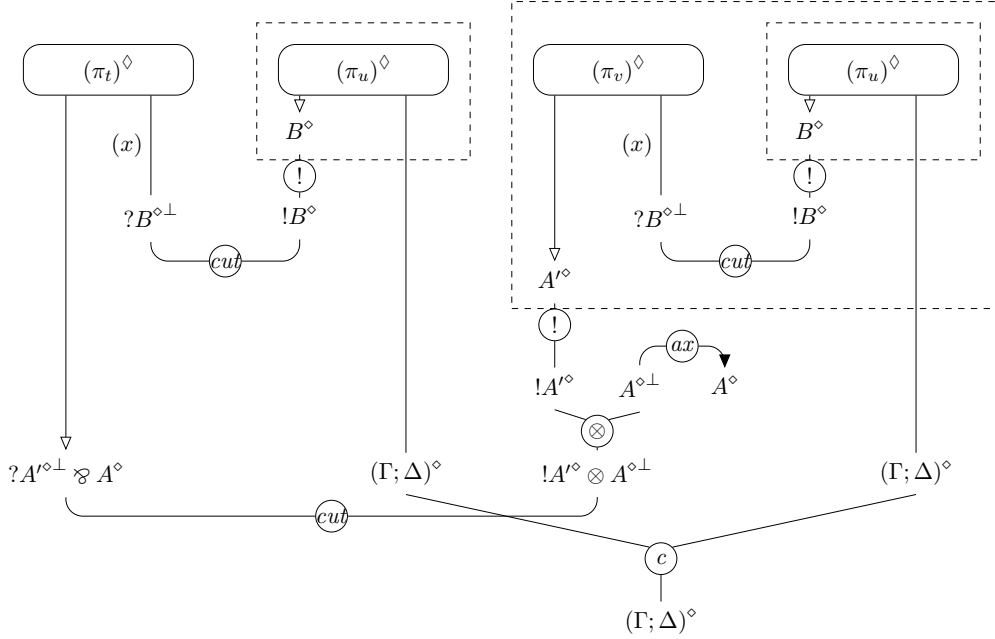

Finally, we apply the *i.h.* on both  $t$  and  $v$  to conclude. If  $x \notin \text{fv}(t)$ , then it is enough to perform one  $\mathcal{C}(!, !)$ -step to conclude by *i.h.* on  $v$ . Otherwise, we conclude by *i.h.* on  $t$ .

- $o = \lambda y.t$ . Without loss of generality we can assume  $y \notin \text{fv}(u)$ . Then we apply the *i.h.* on  $t$ , and reconstruct the  $\lambda$ -abstraction to conclude.
- $o = \mu \alpha.c$ . Without loss of generality we can assume  $\alpha \notin \text{fn}(u)$ . Then we apply the *i.h.* on  $c$ , and reconstruct the  $\mu$ -abstraction to conclude.
- $o = t[y \setminus v]$ . This case is similar to the application case above. Without loss of generality we can assume  $y \notin \text{fv}(u)$ , and we have three different cases to consider. If  $x \in \text{fv}(t)$  and  $x \in \text{fv}(v)$ , then we need to perform one  $\mathcal{C}(!, c)$ -step followed by one  $\mathcal{C}(!, !)$ -step before applying the *i.h.* on both  $t$  and  $v$  to conclude. If  $x \notin \text{fv}(v)$ , then we perform one  $\mathcal{C}(!, !)$ -step and conclude by *i.h.* on  $v$ . Otherwise, we conclude directly from the *i.h.* on  $t$ .
- $o = [\alpha]t$ . This case follows immediately from the *i.h.* on  $t$ .
- $o = c[\alpha \setminus \alpha' s]$ . Without loss of generality we can assume  $\alpha \notin \text{fn}(u)$ . Then, there are three possible cases: either  $x \in \text{fv}(c)$  and  $x \in \text{fv}(s)$ ; or  $x \notin \text{fv}(c)$ ; or  $x \notin \text{fv}(s)$ . The last two follow from applying the *i.h.* on the sub-object containing  $x$ . The former requires performing one  $\mathcal{C}(!, c)$ -step before resorting to the *i.h.* on both  $c$  and  $s$ .
- $o = c[\alpha \setminus \beta]$ . This case follows immediately from the *i.h.* on  $c$ .
- $o = t \cdot s$ . Notice that  $(\pi_t)^\diamond$  is placed inside a box by the translation (as well as each element in  $s$ ). If  $x \in \text{fv}(t)$  and  $x \notin \text{fv}(s)$  we need to perform one  $\mathcal{C}(!, !)$ -step and conclude by *i.h.* on  $t$ . If  $x \in \text{fv}(s)$  we may proceed by induction on  $s$ , (possibly) applying an extra  $\mathcal{C}(!, c)$ -step before the  $\mathcal{C}(!, !)$ -step, and resorting to the corresponding *i.h.* to conclude.

□



**Lemma C.3** (Replacement). *Let  $o \in \mathbb{C}_{\Lambda M}$  and  $s \in \mathbb{O}_{\Lambda M}$  be typed with  $s$  a stack such that  $\text{fv}(o) \cap \text{fv}(s) = \emptyset$  and  $\text{fn}(o) \cap \text{fn}(s) = \emptyset$ . Then*

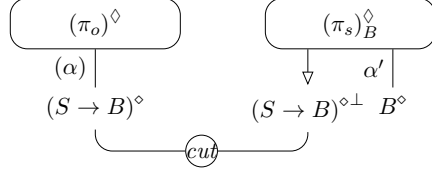

reduces to a PPN structurally equivalent to  $(\pi_o\{\alpha \setminus \alpha' s\})^\diamond$ .

*Proof.* By induction on  $o$  as in [Lau02] Lem. 11.8, using our definition of the translation. Notice that the case where  $\alpha \notin \text{fn}(o)$  is trivial since  $o\{\alpha \setminus \alpha' s\} = o$  and applying  $\mathbb{C}(\otimes, w)$  allows to obtain a proof-net structural equivalent to  $(\pi_o)^\diamond$  by the fourth and fifth rules in Fig. 8. Thus, in the sequel we assume  $\alpha \in \text{fn}(o)$ .

- $o = x$ . This case does not apply since  $\alpha \notin \text{fn}(o)$ .
- $o = tu$ . If  $\alpha \in \text{fn}(t)$  and  $\alpha \in \text{fn}(u)$ , then  $(\pi_o)^\diamond$  has a contraction node between the edges labelled  $\alpha$  in  $(\pi_t)^\diamond$  and  $(\pi_u)^\diamond$ . Then, performing one  $\mathbb{C}(\otimes, c)$ -step followed by one  $\mathbb{C}(\otimes, !)$ -step for each element in  $s$ , we obtain the following proof-net:

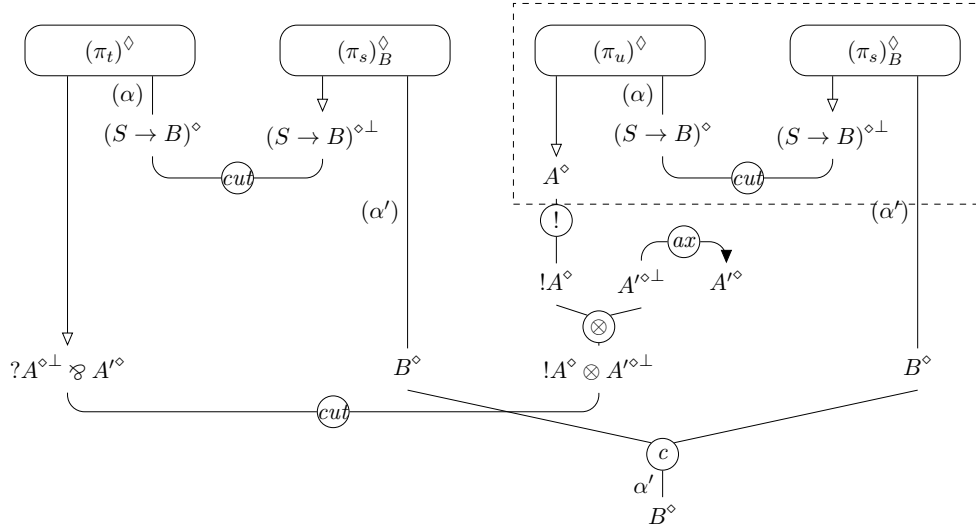

Finally, we apply the *i.h.* on both  $t$  and  $u$  to conclude. If  $\alpha \notin \text{fn}(t)$ , then it is enough to perform one  $\mathbb{C}(\otimes, !)$ -step for each element in  $s$  to conclude by *i.h.* on  $u$ . Otherwise, we simply conclude by *i.h.* on  $t$ .

- $o = \lambda x.t$ . Without loss of generality we can assume  $x \notin \text{fv}(s)$ . Then we apply the *i.h.* on  $t$ , and reconstruct the  $\lambda$ -abstraction to conclude.
- $o = \mu \gamma.c$ . Without loss of generality we can assume  $\gamma \notin \text{fn}(s)$ . Then we apply the *i.h.* on  $c$ , and reconstruct the  $\mu$ -abstraction to conclude.
- $o = t[x \setminus u]$ . This case is similar to the application case above. Without loss of generality we can assume  $x \notin \text{fv}(s)$ , and we have three different cases to consider. If  $\alpha \in \text{fn}(t)$  and  $\alpha \in \text{fn}(u)$ , then we need to perform one  $\mathbb{C}(\otimes, c)$ -step followed by one  $\mathbb{C}(\otimes, !)$ -step for each element in  $s$  before applying the *i.h.* on both  $t$  and  $u$  to conclude. If  $\alpha \notin \text{fn}(t)$ , then we perform one  $\mathbb{C}(\otimes, !)$ -step for each element in  $s$ , and conclude by *i.h.* on  $u$ . Otherwise, we conclude directly from the *i.h.* on  $t$ .

- $o = [\alpha] t$ . Then, we have two possible cases: either  $\alpha \notin \text{fn}(t)$ ; or  $\alpha \in \text{fn}(t)$ . In the former, the obtained proof-net happens to be exactly  $(\pi_{o \llbracket \alpha \setminus \alpha' s \rrbracket})^\diamond$ , hence we conclude directly. In the latter, the edge labelled  $\alpha$  in  $(\pi_o)^\diamond$  comes from a contraction node. Then, we should apply one  $\mathcal{C}(\otimes, c)$ -step for each element in  $s$  and conclude by *i.h.* on  $t$ .
- $o = [\gamma] t$  with  $\gamma \neq \alpha$ . This case follows immediately from the *i.h.* on  $t$ .
- $o = c \llbracket \gamma \setminus \alpha' s' \rrbracket$ . Without loss of generality we can assume  $\gamma \notin \text{fn}(s)$ . Then, there are four possible cases: either  $\alpha \in \text{fn}(c)$  and  $\alpha \in \text{fn}(s')$ ; or  $\alpha \notin \text{fn}(c)$ ; or  $\alpha \notin \text{fn}(s')$ ; or both. The latter case allows us to conclude directly, since the only occurrence of  $\alpha$  in  $o$  is the one from the outermost explicit replacement, and hence the obtained proof-net is exactly  $(\pi_{o \llbracket \alpha \setminus \alpha' s \rrbracket})^\diamond$ . If  $\alpha \notin \text{fn}(c)$  and  $\alpha \in \text{fn}(s')$ , then we need to perform one  $\mathcal{C}(\otimes, c)$ -step for each element in  $s$  and conclude by *i.h.* on  $s'$ . The case where  $\alpha \in \text{fn}(c)$  and  $\alpha \notin \text{fn}(s')$  is similar, resorting to the *i.h.* on  $c$ . Finally, if  $\alpha \in \text{fn}(c)$  and  $\alpha \in \text{fn}(s')$ , there is an extra contraction node for  $\alpha$  between  $(\pi_c)^\diamond$  and  $(\pi_{s'})^\diamond$ . Thus, we needed to perform two  $\mathcal{C}(\otimes, c)$ -step for each element in  $s$ , and conclude by *i.h.* on both  $c$  and  $s'$ .
- $o = c \llbracket \gamma \setminus \delta s' \rrbracket$  with  $\delta \neq \alpha$ . This case is similar to the previous one. Without loss of generality we can assume  $\gamma \notin \text{fn}(s)$ . Then, there are three possible cases: either  $\alpha \in \text{fn}(c)$  and  $\alpha \in \text{fn}(s')$ ; or  $\alpha \notin \text{fn}(c)$ ; or  $\alpha \notin \text{fn}(s')$ . The last two follow from applying the *i.h.* on the sub-object containing  $\alpha$ . The former requires performing one  $\mathcal{C}(\otimes, c)$ -step for each element in  $s$ , and then resorting to the *i.h.* on both  $c$  and  $s'$ .
- $o = c \llbracket \gamma \setminus \alpha \rrbracket$ . Without loss of generality we can assume  $\gamma \notin \text{fn}(s)$ . Then, there are two possible cases: either  $\alpha \notin \text{fn}(c)$ ; or  $\alpha \in \text{fn}(c)$ . In the former, the obtained proof-net happens to be exactly  $(\pi_{o \llbracket \alpha \setminus \alpha' s \rrbracket})^\diamond$ , hence we conclude directly. In the latter, the edge labelled  $\alpha$  in  $(\pi_o)^\diamond$  comes from a contraction node. Then, we should apply one  $\mathcal{C}(\otimes, c)$ -step for each element in  $s$  and conclude by *i.h.* on  $c$ .
- $o = c \llbracket \gamma \setminus \delta \rrbracket$  with  $\delta \neq \alpha$ . This case follows immediately from the *i.h.* on  $c$ .
- $o = t \cdot s'$ . Notice that  $(\pi_t)^\diamond$  is placed inside a box by the translation (as well as each element in  $s'$ ). If  $\alpha \in \text{fn}(t)$  and  $\alpha \notin \text{fn}(s')$  we need to perform one  $\mathcal{C}(\otimes, !)$ -step for each element in  $s$ , and conclude by *i.h.* on  $t$ . If  $\alpha \in \text{fn}(s')$  we may proceed by induction on  $s'$ , (possibly) applying an extra  $\mathcal{C}(\otimes, c)$ -step for each element in  $s$  before each  $\mathcal{C}(\otimes, !)$ -step, and resorting to the corresponding *i.h.* to conclude.

□

**Theorem 6.6** (Simulation). *Let  $o, p \in \mathcal{O}_{\Lambda M}$  be typed. If  $o \rightarrow_{\Lambda M} p$  and  $\pi_o, \pi_p$  are their corresponding type derivations respectively, then  $(\pi_o)^\diamond \rightarrow_{\text{PPN}} (\pi_p)^\diamond$ .*

*Proof.* By induction on  $o \rightarrow_{\Lambda M} p$  using the auxiliar lemmas above. In particular, the base case for **dB** resorts to  $\mathcal{C}(ax)$  and  $\mathcal{C}(\otimes, \wp)$  rules for proof-nets; rule **S** follows from Lem. C.1 and C.2; rule **dM** turns out to be a structural equivalence from the proof-nets point of view; and the remaining rules from Def. 4.1 follow from Lem. C.1 and C.3.

□

#### APPENDIX D. STRONG NORMALISATION OF PLAIN COMPUTATION

To show that plain computation is strongly normalising we define a measure over objects of the  $\Lambda M$ -calculus. It is worth noticing that using the size of an object (*i.e.* counting all its

constructors) is not enough since it does not strictly decrease under computation due to the following remarks:

- (1) Rule **dM** discards an application while introducing a new explicit replacement, thus preserving the number of constructors in the object.
- (2) Rule **N** discards a linear explicit replacement with a stack of  $n$  elements, replacing it with  $n$  applications. The number of stack constructors in a stack of  $n$  elements turns out to be  $n - 1$  which, together with the discarded explicit replacement, compensates the  $n$  introduced applications.
- (3) Rule **C** discards a linear explicit replacement by combining it with another one, appending their respective stacks. This introduces a new stack constructor, preserving the total number of constructors in the object.
- (4) Rule **W** simply reorders the constructors of the object, pushing explicit replacements below explicit renamings.

The first remark suggests that the application constructor should have more weight than the replacement constructor to guarantee normalisation by means of a polynomial interpretation. However, the second remark suggests exactly the opposite. On another note, the third remark requires explicit replacements to have more weight than stacks. The fourth simply suggest that explicit replacements to-the-left of an explicit renaming should have less weight than those to-the-right.

Under these considerations we define the following measure over objects of the  $\Lambda M$ -calculus which turns out to be decreasing w.r.t. reduction  $\rightarrow_{\mathcal{P}}$ .

$$\begin{array}{ll}
\langle x \rangle & \triangleq 3 & \langle [\alpha] t \rangle & \triangleq \langle t \rangle \\
\langle t u \rangle & \triangleq \langle t \rangle * \langle u \rangle & \langle c[\alpha \setminus \alpha' s] \rangle & \triangleq \langle c \rangle * \langle s \rangle + 1 \\
\langle \lambda x.t \rangle & \triangleq \langle t \rangle & \langle c[\alpha \setminus \beta] \rangle & \triangleq \langle c \rangle + 1 \\
\langle \mu \alpha.c \rangle & \triangleq \langle c \rangle + 1 & & \\
\langle t[x \setminus u] \rangle & \triangleq \langle t \rangle + \langle u \rangle & \langle t \cdot s \rangle & \triangleq \langle t \rangle * \langle u \rangle
\end{array}$$

Notice that  $\langle o \rangle \geq 3$  for every  $o \in \mathcal{O}_{\Lambda M}$ . We also have  $\langle o \rangle + \langle o' \rangle < \langle o \rangle * \langle o' \rangle$ . The measure  $\langle \_ \rangle$  can be extended to contexts as follows:

$$\begin{array}{ll}
\langle \square \rangle & \triangleq 0 & \langle \sqsupset \rangle & \triangleq 0 \\
\langle \mathbb{T} t \rangle & \triangleq \langle \mathbb{T} \rangle * \langle t \rangle & \langle [\alpha] \mathbb{T} \rangle & \triangleq \langle \mathbb{T} \rangle \\
\langle t \mathbb{T} \rangle & \triangleq \langle \mathbb{T} \rangle * \langle t \rangle & \langle \mathbb{C}[\alpha \setminus \alpha' s] \rangle & \triangleq \langle \mathbb{C} \rangle * \langle s \rangle + 1 \\
\langle \lambda x.\mathbb{T} \rangle & \triangleq \langle \mathbb{T} \rangle & \langle c[\alpha \setminus \alpha' \mathbb{S}] \rangle & \triangleq \langle c \rangle * \langle \mathbb{S} \rangle + 1 \\
\langle \mu \alpha.\mathbb{C} \rangle & \triangleq \langle \mathbb{C} \rangle + 1 & \langle \mathbb{C}[\alpha \setminus \beta] \rangle & \triangleq \langle \mathbb{C} \rangle + 1 \\
\langle \mathbb{T}[x \setminus t] \rangle & \triangleq \langle \mathbb{T} \rangle + \langle t \rangle & \langle \mathbb{T} \cdot s \rangle & \triangleq \langle \mathbb{T} \rangle * \langle s \rangle + 1 \\
\langle t[x \setminus \mathbb{T}] \rangle & \triangleq \langle \mathbb{T} \rangle + \langle t \rangle & \langle t \cdot \mathbb{S} \rangle & \triangleq \langle t \rangle * \langle \mathbb{S} \rangle + 1
\end{array}$$

**Lemma D.1.** *For every  $\mathbb{O}$ , there is  $f_{\mathbb{O}} : x \mapsto a * x + b$  with  $a > 0$  and  $b \geq 0$ , such that for every  $o$ , one has  $\langle \mathbb{O} \langle o \rangle \rangle = f_{\mathbb{O}}(\langle o \rangle)$ .*

*Proof.* By induction on  $\mathbb{O}$ .

- For  $\mathbb{O} = \square$  and  $\mathbb{O} = \sqsupset$  we take  $f_{\mathbb{O}}(x) = 1 * x + 0$ .
- For  $\mathbb{O} = \mathbb{T}[x \setminus t]$  and  $\mathbb{O} = t[x \setminus \mathbb{T}]$ , we take  $f_{\mathbb{O}}(x) = a' * x + (b' + \langle t \rangle)$ , where  $f_{\mathbb{T}}(x) = a' * x + b'$ .
- For  $\mathbb{O} = \mathbb{T} t$  and  $\mathbb{O} = t \mathbb{T}$  we take  $f_{\mathbb{O}}(x) = (a' * \langle t \rangle) * x + (b' * \langle t \rangle)$ , where  $f_{\mathbb{T}}(x) = a' * x + b'$ .
- For  $\mathbb{O} = \lambda x.\mathbb{T}$  and  $\mathbb{O} = [\alpha] \mathbb{T}$  we take  $f_{\mathbb{O}}(x) = a' * x + b'$ , where  $f_{\mathbb{T}}(x) = a' * x + b'$ .

- For  $0 = \mu\alpha.C$  we take  $f_0(x) = a' * x + (b' + 1)$ , where  $f_C(x) = a' * x + b'$ .
- For  $0 = C[\alpha \setminus^{\alpha'} s]$  we take  $f_0(x) = (a' * \langle s \rangle) * x + (b' * \langle s \rangle + 1)$ , where  $f_C(x) = a' * x + b'$ .
- For  $0 = c[\alpha \setminus^{\alpha'} S]$  we take  $f_0(x) = (a' * \langle c \rangle) * x + (b' * \langle c \rangle + 1)$ , where  $f_S(x) = a' * x + b'$ .
- For  $0 = T \cdot s$  we take  $f_0(x) = (a' * \langle s \rangle) * x + (b' * \langle s \rangle + 1)$ , where  $f_T(x) = a' * x + b'$ .
- For  $0 = t \cdot S$  we take  $f_0(x) = (a' * \langle t \rangle) * x + (b' * \langle t \rangle + 1)$ , where  $f_S(x) = a' * x + b'$ .
- For  $0 = C[\alpha \setminus \beta]$  we take  $f_0(x) = a' * x + (b' + 1)$ , where  $f_C(x) = a' * x + b'$ .

□

**Theorem 7.2.** *The relation  $\rightarrow_{\mathcal{P}}$  is terminating.*

*Proof.* We prove  $o \rightarrow_{\mathcal{P}} p$  implies  $\langle o \rangle > \langle p \rangle$  by induction on the relation  $\rightarrow_{\mathcal{P}}$ . We first analyse all the base cases:

- $o = L\langle \lambda x.t \rangle u \mapsto_{\text{dB}} L\langle t[x \setminus u] \rangle = p$ , where  $\text{fc}(u, L)$ . Then Lem. D.1 gives  $f_L(x) = a * x + b$ , with  $a > 0$  and  $b \geq 0$ . We conclude by

$$\begin{aligned}
 \langle o \rangle &= (a * \langle t \rangle + b) * \langle u \rangle \\
 &= a * \langle t \rangle * \langle u \rangle + b * \langle u \rangle \\
 &> a * (\langle t \rangle + \langle u \rangle) + b * \langle u \rangle \\
 &> a * (\langle t \rangle + \langle u \rangle) + b \\
 &= \langle p \rangle
 \end{aligned}$$

- $o = L\langle \mu\alpha.c \rangle u \mapsto_{\text{dM}} L\langle \mu\alpha'.c[\alpha \setminus^{\alpha'} u] \rangle = p$ , where  $\alpha'$  is fresh. Then Lem. D.1 gives  $f_L(x) = a * x + b$ , with  $a > 0$  and  $b \geq 0$ . We conclude by

$$\begin{aligned}
 \langle o \rangle &= (a * (\langle c \rangle + 1) + b) * \langle u \rangle \\
 &= a * \langle c \rangle * \langle u \rangle + \langle u \rangle * a + \langle u \rangle * b \\
 &> a * \langle c \rangle * \langle u \rangle + 2 * a + b \\
 &= a * ((\langle c \rangle * \langle u \rangle + 1) + 1) + b \\
 &= \langle p \rangle
 \end{aligned}$$

- $o = \text{LCC}\langle [\alpha]t \rangle [\alpha \setminus^{\alpha'} s] \mapsto_{\text{N}} \text{LCC}\langle [\alpha']t :: s \rangle = p$ , where  $\alpha \notin \text{LCC}$  and  $\alpha \notin t$ . Assume  $s = u_0 \dots u_n$ . Lem. D.1 gives  $f_{\text{LCC}}(x) = a * x + b$ , with  $a > 0$  and  $b \geq 0$ . We conclude by

$$\begin{aligned}
 \langle o \rangle &= (a * \langle t \rangle + b) * \langle u_0 \rangle * \dots * \langle u_n \rangle + n + 1 \\
 &= a * \langle t \rangle * \langle u_0 \rangle * \dots * \langle u_n \rangle + b * \langle u_0 \rangle * \dots * \langle u_n \rangle + n + 1 \\
 &> a * \langle t \rangle * \langle u_0 \rangle * \dots * \langle u_n \rangle + b \\
 &= \langle p \rangle
 \end{aligned}$$

- $o = \text{LCC}\langle c'[\beta \setminus^{\alpha} s'] \rangle [\alpha \setminus^{\alpha'} s] \mapsto_{\text{C}} \text{LCC}\langle c'[\beta \setminus^{\alpha'} s' \cdot s] \rangle = p$ , where  $\alpha \notin \text{LCC}$ ,  $\alpha \notin c'$  and  $\alpha \notin s'$ . Lem. D.1 gives  $f_{\text{LCC}}(x) = a * x + b$ , with  $a > 0$  and  $b \geq 0$ . We conclude by

$$\begin{aligned}
 \langle o \rangle &= (a * (\langle c' \rangle * \langle s' \rangle + 1) + b) * \langle s \rangle + 1 \\
 &= a * \langle c' \rangle * \langle s' \rangle * \langle s \rangle + (a + b) * \langle s \rangle + 1 \\
 &> (a * \langle c' \rangle * \langle s' \rangle * \langle s \rangle) + a + b \\
 &= a * (\langle c' \rangle * \langle s' \rangle * \langle s \rangle + 1) + b \\
 &= \langle p \rangle
 \end{aligned}$$

- $o = \text{LCC}\langle c'[\beta \setminus \alpha] \rangle \llbracket \alpha \setminus^{\alpha'} s \rrbracket \mapsto_{\text{W}} \text{LCC}\langle c'[\beta \setminus^{\alpha} s] \rrbracket \llbracket \alpha \setminus^{\alpha'} s \rrbracket = p$ , where  $\alpha \notin \text{LCC}$  and  $\alpha \notin c'$ . Lem. D.1 gives  $f_{\text{LCC}}(x) = a * x + b$ , with  $a > 0$  and  $b \geq 0$ . We conclude by

$$\begin{aligned}
\langle o \rangle &= (a * (\langle c' \rangle + 1) + b) * \langle s \rangle + 1 \\
&= a * \langle c' \rangle * \langle s \rangle + (a + b) * \langle s \rangle + 1 \\
&> a * \langle c' \rangle * \langle s \rangle + 2 * a + b \\
&= a * (\langle c' \rangle * \langle s \rangle + 1 + 1) + b \\
&= \langle p \rangle
\end{aligned}$$

For every inductive case of the form  $o = \mathbb{O}\langle o' \rangle \rightarrow_{\mathcal{P}} \mathbb{O}\langle p' \rangle = p$  where  $o' \rightarrow_{\mathcal{P}} p'$  is a base reduction step, we get  $\langle o' \rangle > \langle p' \rangle$  by the *i.h.* We then use Lem. D.1 to get  $\langle o \rangle = f_{\mathbb{O}}(\langle o' \rangle)$  and  $\langle p \rangle = f_{\mathbb{O}}(\langle p' \rangle)$ . We conclude  $\langle o \rangle > \langle p \rangle$  since  $f_{\mathbb{O}}$  is clearly strictly monotone by construction.  $\square$

**Theorem 7.3.** *The relation  $\rightarrow_{\mathcal{P}}$  is confluent.*

*Proof.* We prove that the relation is *weakly confluent* (WCR) by analyzing all the critical pairs [BN98] and conclude using Newman's Lemma by resorting to Thm. 7.2.

We thus consider the critical pairs between the rules dB, dM, N, C, W and check that they converge. There are only three critical pairs:

- (1) N–C. We have  $o = \text{LCC}_2\langle \text{LCC}_1\langle [\delta] t \rangle \rrbracket \llbracket \delta \setminus^{\alpha} s' \rrbracket \llbracket \alpha \setminus^{\alpha'} s \rrbracket$  with the conditions  $\alpha \notin \text{LCC}_2$ ,  $\alpha \notin \text{LCC}_1\langle [\delta] t \rangle$ ,  $\alpha \notin s$ ,  $\text{fc}(\alpha', \text{LCC}_2)$ ,  $\text{fc}(s, \text{LCC}_2)$  given by rule C, and the conditions  $\delta \notin t$ ,  $\delta \notin \text{LCC}_1$ ,  $\text{fc}(\alpha, \text{LCC}_1)$  and  $\text{fc}(s', \text{LCC}_1)$  given by rule N. We conclude since  $(t :: s') :: s = t :: (s' \cdot s)$ , thus obtaining the diagram:

$$\begin{array}{ccc}
\text{LCC}_2\langle \text{LCC}_1\langle [\delta] t \rangle \rrbracket \llbracket \delta \setminus^{\alpha} s' \rrbracket \llbracket \alpha \setminus^{\alpha'} s \rrbracket & \rightarrow_{\text{N}} & \text{LCC}_2\langle \text{LCC}_1\langle [\alpha] t :: s' \rangle \rrbracket \llbracket \alpha \setminus^{\alpha'} s \rrbracket \\
\downarrow \text{C} & & \downarrow \text{N} \\
\text{LCC}_2\langle \text{LCC}_1\langle [\delta] t \rangle \rrbracket \llbracket \delta \setminus^{\alpha'} s' \cdot s \rrbracket & \rightarrow_{\text{N}} & \text{LCC}_2\langle \text{LCC}_1\langle [\alpha'] (t :: s') :: s \rangle \rrbracket
\end{array}$$

- (2) C–C. Then we have  $o = \text{LCC}_2\langle \text{LCC}_1\langle c[\gamma \setminus^{\delta} s''] \rangle \rrbracket \llbracket \delta \setminus^{\alpha} s' \rrbracket \llbracket \alpha \setminus^{\alpha'} s \rrbracket$  with the conditions  $\alpha \notin \text{LCC}_2$ ,  $\alpha \notin \text{LCC}_1\langle c[\gamma \setminus^{\delta} s''] \rangle$ ,  $\alpha \notin s$ ,  $\text{fc}(\alpha', \text{LCC}_2)$ ,  $\text{fc}(s, \text{LCC}_2)$  due to the outermost application of the rule, and the conditions  $\delta \notin c$ ,  $\delta \notin \text{LCC}_1$ ,  $\delta \notin s'$ ,  $\text{fc}(\alpha, \text{LCC}_1)$  and  $\text{fc}(s', \text{LCC}_1)$  due to the innermost one. We conclude since  $s'' \cdot (s' \cdot s) = (s'' \cdot s') \cdot s$ , thus obtaining the following diagram:

$$\begin{array}{ccc}
\text{LCC}_2\langle \text{LCC}_1\langle c[\gamma \setminus^{\delta} s''] \rangle \rrbracket \llbracket \delta \setminus^{\alpha} s' \rrbracket \llbracket \alpha \setminus^{\alpha'} s \rrbracket & \rightarrow_{\text{C}} & \text{LCC}_2\langle \text{LCC}_1\langle c[\gamma \setminus^{\alpha} s'' \cdot s'] \rangle \rrbracket \llbracket \alpha \setminus^{\alpha'} s \rrbracket \\
\downarrow \text{C} & & \downarrow \text{C} \\
\text{LCC}_2\langle \text{LCC}_1\langle c[\gamma \setminus^{\delta} s''] \rangle \rrbracket \llbracket \delta \setminus^{\alpha'} s' \cdot s \rrbracket & \rightarrow_{\text{C}} & \text{LCC}_2\langle \text{LCC}_1\langle c[\gamma \setminus^{\alpha'} s'' \cdot s'] \rangle \rrbracket
\end{array}$$

- (3) W–C. Then we have  $o = \text{LCC}_2\langle \text{LCC}_1\langle c[\gamma \setminus \delta] \rangle \rrbracket \llbracket \delta \setminus^{\alpha} s' \rrbracket \llbracket \alpha \setminus^{\alpha'} s \rrbracket$  with the conditions  $\alpha \notin \text{LCC}_2$ ,  $\alpha \notin \text{LCC}_1\langle c[\gamma \setminus \delta] \rangle$ ,  $\alpha \notin s$ ,  $\text{fc}(\alpha', \text{LCC}_2)$ ,  $\text{fc}(s, \text{LCC}_2)$  given by rule C, and the conditions  $\delta \notin c$ ,  $\delta \notin \text{LCC}_1$ ,  $\text{fc}(\alpha, \text{LCC}_1)$  and  $\text{fc}(s', \text{LCC}_1)$  by rule W. We conclude by  $\alpha$ -conversion with

$\beta$  a fresh name, thus obtaining the diagram:

$$\begin{array}{ccc}
\text{LCC}_2\langle \text{LCC}_1\langle c[\gamma \setminus \delta] \llbracket \delta \setminus^\alpha s' \rrbracket \llbracket \alpha \setminus^{\alpha'} s \rrbracket \rangle \rangle & \rightarrow_{\mathbb{W}} & \text{LCC}_2\langle \text{LCC}_1\langle c[\gamma \setminus^\delta s' \llbracket \delta \setminus \alpha \rrbracket] \llbracket \alpha \setminus^{\alpha'} s \rrbracket \rangle \rangle \\
\downarrow c & & \downarrow \mathbb{W} \\
& & \text{LCC}_2\langle \text{LCC}_1\langle c[\gamma \setminus^\delta s' \llbracket \delta \setminus^\alpha s \rrbracket \llbracket \alpha \setminus^{\alpha'} \rrbracket \rangle \rangle \\
& & \downarrow c \\
\text{LCC}_2\langle \text{LCC}_1\langle c[\gamma \setminus \delta] \llbracket \delta \setminus^{\alpha'} s' \cdot s \rrbracket \rangle \rangle & \rightarrow_{\mathbb{W}} & \text{LCC}_2\langle \text{LCC}_1\langle c[\gamma \setminus^\beta s' \cdot s \llbracket \beta \setminus^{\alpha'} \rrbracket \rangle \rangle
\end{array}$$

□

**Lemma D.2** (Subject Reduction). *Let  $o \in \mathbb{O}_{\Lambda M}$ . If  $\pi \triangleright_{\mathcal{E}} \Gamma \vdash o : T \mid \Delta$  and  $o \rightarrow_{\mathcal{P}} o'$ , then there exists  $\pi' \triangleright_{\mathcal{E}} \Gamma \vdash o' : T \mid \Delta$ .*

*Proof.* By definition,  $o \rightarrow_{\mathcal{P}} o'$  implies  $o = \mathbb{O}\langle l \rangle$  y  $o' = \mathbb{O}\langle r \rangle$  with  $l \mapsto_* r$ ,  $* \in \{\text{dB}, \text{dM}, \text{N}, \text{C}, \mathbb{W}\}$ . The proof is by induction on  $\mathbb{O}$ .

- $\mathbb{O} = \square$ . Then there are two possible cases according to the rewrite rule that is applied while reducing.
  - (1) **dB**. Then  $o = \text{L}\langle \lambda x.t \rangle u$  and  $o' = \text{L}\langle t[x \setminus u] \rangle$ . Due to (APP) we have  $\Gamma = \Gamma_0 \cup \Gamma_1$  and  $\Delta = \Delta_0 \cup \Delta_1$  with  $\pi_{\text{L}\langle \lambda x.t \rangle} \triangleright_{\mathcal{E}} \Gamma_0 \vdash \text{L}\langle \lambda x.t \rangle : A \rightarrow T \mid \Delta_0$  and  $\pi_u \triangleright_{\mathcal{E}} \Gamma_1 \vdash u : A \mid \Delta_1$ . We proceed by induction on L.
    - $\text{L} = \square$ . Then from  $\pi_{\text{L}\langle \lambda x.t \rangle}$  we have  $\pi_t \triangleright_{\mathcal{E}} \Gamma_0; (x : A)^{\leq 1} \vdash t : T \mid \Delta_0$  from (ABS). We conclude by (SUBS) with  $\pi_t$  and  $\pi_u$ , obtaining  $\pi' \triangleright_{\mathcal{E}} \Gamma \vdash t[x \setminus u] : T \mid \Delta$ .
    - $\text{L} = \text{L}'\langle y \setminus v \rangle$  with  $y \notin u$ . Then by Lem. 4.4,  $y \notin \text{dom}(\Gamma_1)$ . From  $\pi_{\text{L}\langle \lambda x.t \rangle}$  by (SUBS) we have typing contexts  $\Gamma_0 = \Gamma'_0 \cup \Gamma''_0$  and  $\Delta_0 = \Delta'_0 \cup \Delta''_0$  derivations  $\pi_{\text{L}\langle \lambda x.t \rangle} \triangleright_{\mathcal{E}} \Gamma'_0; (y : B)^{\leq 1} \vdash \text{L}'\langle \lambda x.t \rangle : A \rightarrow T \mid \Delta'_0$  and  $\pi_v \triangleright_{\mathcal{E}} \Gamma''_0 \vdash v : B \mid \Delta''_0$ . Then by (APP) with  $\pi_{\text{L}\langle \lambda x.t \rangle}$  and  $\pi_u$  we obtain  $\pi_{\text{L}\langle \lambda x.t \rangle u} \triangleright_{\mathcal{E}} \Gamma'_0 \cup \Gamma_1; (y : B)^{\leq 1} \vdash \text{L}'\langle \lambda x.t \rangle u : T \mid \Delta'_0 \cup \Delta_1$ . Due to *i.h.* there exists  $\pi_{\text{L}'\langle t[x \setminus u] \rangle} \triangleright_{\mathcal{E}} \Gamma'_0 \cup \Gamma_1; (y : B)^{\leq 1} \vdash \text{L}'\langle t[x \setminus u] \rangle : T \mid \Delta'_0 \cup \Delta_1$ . Finally, we conclude by (SUBS) with  $\pi_v$ ,  $\pi' \triangleright_{\mathcal{E}} \Gamma \vdash \text{L}\langle t[x \setminus u] \rangle : T \mid \Delta$ .
  - (2) **dM**. Then  $o = \text{L}\langle \mu \alpha.c \rangle u$  and  $o' = \text{L}\langle \mu \alpha'.c \llbracket \alpha \setminus^{\alpha'} u \rrbracket \rangle$  with  $\alpha'$  a fresh name. Due to (APP) we have  $\Gamma = \Gamma_0 \cup \Gamma_1$  and  $\Delta = \Delta_0 \cup \Delta_1$  with  $\pi_{\text{L}\langle \mu \alpha.c \rangle} \triangleright_{\mathcal{E}} \Gamma_0 \vdash \text{L}\langle \mu \alpha.c \rangle : A \rightarrow T \mid \Delta_0$  and  $\pi_u \triangleright_{\mathcal{E}} \Gamma_1 \vdash u : A \mid \Delta_1$ . We proceed by induction on L.
    - $\text{L} = \square$ . Then  $\pi_{\text{L}\langle \mu \alpha.c \rangle}$  we have  $\pi_c \triangleright_{\mathcal{E}} \Gamma_1 \vdash c \mid \Delta_1; (\alpha : A \rightarrow T)^{\leq 1}$  by (CONT). Due to (REPL) with  $\pi_c$  and  $\pi_u$  we obtain  $\pi_{c \llbracket \alpha \setminus^{\alpha'} u \rrbracket} \triangleright_{\mathcal{E}} \Gamma \vdash c \llbracket \alpha \setminus^{\alpha'} u \rrbracket \mid \Delta; \alpha' : T$ . Then we conclude by (CONT),  $\pi' \triangleright_{\mathcal{E}} \Gamma \vdash \mu \alpha'.c \llbracket \alpha \setminus^{\alpha'} u \rrbracket : T \mid \Delta$ .
    - $\text{L} = \text{L}'\langle y \setminus v \rangle$  with  $y \notin u$ . Then by Lem. 4.4,  $y \notin \text{dom}(\Gamma_1)$ . From  $\pi_{\text{L}\langle \mu \alpha.c \rangle}$  by (SUBS) we have contexts  $\Gamma_0 = \Gamma'_0 \cup \Gamma''_0$  and  $\Delta_0 = \Delta'_0 \cup \Delta''_0$  with derivations  $\pi_{\text{L}\langle \mu \alpha.c \rangle} \triangleright_{\mathcal{E}} \Gamma'_0; (y : B)^{\leq 1} \vdash \text{L}'\langle \mu \alpha.c \rangle : A \rightarrow T \mid \Delta'_0$  and  $\pi_v \triangleright_{\mathcal{E}} \Gamma''_0 \vdash v : B \mid \Delta''_0$ . Due to (APP) with  $\pi_u$ , we obtain  $\pi_{\text{L}'\langle \mu \alpha.c \rangle u} \triangleright_{\mathcal{E}} \Gamma'_0 \cup \Gamma_1; (y : B)^{\leq 1} \vdash \text{L}'\langle \mu \alpha.c \rangle u : T \mid \Delta'_0 \cup \Delta_1$ . Then, by the *i.h.*  $\pi_{\text{L}'\langle \mu \alpha'.c \llbracket \alpha \setminus^{\alpha'} u \rrbracket \rangle} \triangleright_{\mathcal{E}} \Gamma'_0 \cup \Gamma_1; (y : B)^{\leq 1} \vdash \text{L}'\langle \mu \alpha'.c \llbracket \alpha \setminus^{\alpha'} u \rrbracket \rangle : T \mid \Delta'_0 \cup \Delta_1$ . Finally, we conclude from (SUBS) with  $\pi_v$ ,  $\pi' \triangleright_{\mathcal{E}} \Gamma \vdash \text{L}\langle \mu \alpha'.c \llbracket \alpha \setminus^{\alpha'} u \rrbracket \rangle : T \mid \Delta$ .
- $\mathbb{O} = \square$ . Then we have three possible cases according to the rewrite rule applied.
  - (1) **N**. Then  $o = \text{LCC}\langle [\alpha] t \llbracket \alpha \setminus^{\alpha'} s \rrbracket \rangle$  and  $o' = \text{LCC}\langle [\alpha'] t :: s \rangle$ . Due to (REPL) we have typing contexts  $\Gamma = \Gamma_0 \cup \Gamma_1$  and  $\Delta = \Delta_0 \cup \Delta_1; \alpha' : A$  with derivations  $\pi_{\text{LCC}\langle [\alpha] t \rangle} \triangleright_{\mathcal{E}} \Gamma_0 \vdash \text{LCC}\langle [\alpha] t \rangle \mid \Delta_0; (\alpha : S \rightarrow A)^{\leq 1}; (\alpha' : A)^{\leq 1}$  and  $\pi_s \triangleright_{\mathcal{E}} \Gamma_1 \vdash s : S \mid \Delta_1; (\alpha' : A)^{\leq 1}$ . We proceed by induction on LCC.

- $\text{LCC} = \square$ . Then by (NAME) we have  $(\alpha : S \rightarrow A)^{\leq 1}$  non-empty in  $\pi_{\text{LCC}\langle[\alpha]t\rangle}$  with  $\pi_t \triangleright_{\mathcal{E}} \Gamma_0 \vdash t : S \rightarrow A \mid \Delta_0; (\alpha : S \rightarrow A)^{\leq 1}; (\alpha' : A)^{\leq 1}$ . Moreover, by hypothesis of the rule  $\mathbb{N}$ ,  $\alpha \notin t$ . Then by Lem. 4.4,  $(\alpha : S \rightarrow A)^{\leq 1}$  is non-empty in  $\pi_t$ . From Lem. B.1 (3), there exists  $\pi_{t::s} \triangleright_{\mathcal{E}} \Gamma \vdash t :: s : A \mid \Delta_0 \cup \Delta_1; (\alpha' : A)^{\leq 1}$ . Then we conclude from (NAME),  $\pi_{\sigma'} \triangleright_{\mathcal{E}} \Gamma \vdash [\alpha']t :: s \mid \Delta$ .
- $\text{LCC} = [\gamma]\text{LTC}$ . Then by (NAME), we have the context  $\Delta_0 = \Delta_2; \gamma : B$  with the derivation  $\pi_{\text{LTC}\langle[\alpha]t\rangle} \triangleright_{\mathcal{E}} \Gamma_0 \vdash \text{LTC}\langle[\alpha]t\rangle : B \mid \Delta_2; (\alpha : S \rightarrow A)^{\leq 1}; ((\alpha' : A)^{\leq 1} \cup (\gamma : B)^{\leq 1})$ . We proceed by analysing the form of LTC.
  - \*  $\text{LTC} = \text{LTC}'u$ . Then by (APP), we have  $\Gamma_0 = \Gamma'_0 \cup \Gamma''_0$  and  $\Delta_2 = \Delta'_2 \cup \Delta''_2$  with  $\pi_{\text{LTC}'\langle[\alpha]t\rangle} \triangleright_{\mathcal{E}} \Gamma'_0 \vdash \text{LTC}'\langle[\alpha]t\rangle : B' \rightarrow B \mid \Delta'_2; (\alpha : S \rightarrow A)^{\leq 1}; ((\alpha' : A)^{\leq 1} \cup (\gamma : B)^{\leq 1})$  and  $\pi_u \triangleright_{\mathcal{E}} \Gamma''_0 \vdash u : B' \mid \Delta''_2; (\alpha : S \rightarrow A)^{\leq 1}; ((\alpha' : A)^{\leq 1} \cup (\gamma : B)^{\leq 1})$ . Consider  $p = \text{LCC}'\langle[\alpha]t\rangle \llbracket \alpha \setminus^{\alpha'} s \rrbracket$  where  $\text{LCC}' = [\delta]\text{LTC}'$  with  $\delta$  a fresh name. Then, by (NAME) and (REPL) with  $\pi_s, \pi_p \triangleright_{\mathcal{E}} \Gamma'_0 \cup \Gamma_1 \vdash p \mid \Delta_1 \cup \Delta'_2; \delta : B' \rightarrow B; (\alpha' : A \cup (\gamma : B)^{\leq 1})$ . Moreover, since  $p \rightarrow_{\mathbb{N}} p' = \text{LCC}'\langle[\alpha']t :: s\rangle$ , by the *i.h.* there exists a derivation  $\pi_{p'} \triangleright_{\mathcal{E}} \Gamma'_0 \cup \Gamma_1 \vdash p' \mid \Delta_1 \cup \Delta'_2; \delta : B' \rightarrow B; (\alpha' : A \cup (\gamma : B)^{\leq 1})$ . Then from (NAME),  $\pi_{\text{LTC}'\langle[\alpha']t :: s\rangle} \triangleright_{\mathcal{E}} \Gamma'_0 \cup \Gamma_1 \vdash \text{LTC}'\langle[\alpha']t :: s\rangle : B' \rightarrow B \mid \Delta_1 \cup \Delta'_2; (\alpha' : A \cup (\gamma : B)^{\leq 1})$ , since  $\delta$  is fresh. Finally, we conclude by (APP) with  $\pi_u$  and then (NAME) with  $\gamma, \pi_{\sigma'} \triangleright_{\mathcal{E}} \Gamma \vdash \sigma' \mid \Delta$ . Note that, by hypothesis of the rule  $\mathbb{N}$ ,  $\alpha \notin u$  and by Lem. 4.4,  $(\alpha : S \rightarrow A)^{\leq 1}$  is empty in  $\pi_u$ .
  - \*  $\text{LTC} = \lambda x.\text{LTC}'$ . Then by (ABS), we have  $B = B' \rightarrow B''$  with  $\pi_{\text{LTC}'\langle[\alpha]t\rangle} \triangleright_{\mathcal{E}} \Gamma_0; (x : B')^{\leq 1} \vdash \text{LTC}'\langle[\alpha]t\rangle : B'' \mid \Delta_2; (\alpha : S \rightarrow A)^{\leq 1}; ((\alpha' : A)^{\leq 1} \cup (\gamma : B)^{\leq 1})$ . Let  $p = \text{LCC}'\langle[\alpha]t\rangle \llbracket \alpha \setminus^{\alpha'} s \rrbracket$  where  $\text{LCC}' = [\delta]\text{LTC}'$  with  $\delta$  a fresh name. Then, by (NAME) with the name  $\delta$  and (REPL) with  $\pi_s$ , we obtain the derivation  $\pi_p \triangleright_{\mathcal{E}} \Gamma; (x : B')^{\leq 1} \vdash p \mid \Delta_1 \cup \Delta_2; \delta : B''; (\alpha' : A \cup (\gamma : B)^{\leq 1})$ . Moreover, since  $p \rightarrow_{\mathbb{N}} p' = \text{LCC}'\langle[\alpha']t :: s\rangle$ , applying the *i.h.* there exists a derivation  $\pi_{p'} \triangleright_{\mathcal{E}} \Gamma; (x : B')^{\leq 1} \vdash p' \mid \Delta_1 \cup \Delta_2; \delta : B''; (\alpha' : A \cup (\gamma : B)^{\leq 1})$ . Then, by (NAME) we get  $\pi_{\text{LTC}'\langle[\alpha']t :: s\rangle} \triangleright_{\mathcal{E}} \Gamma; (x : B')^{\leq 1} \vdash \text{LTC}'\langle[\alpha']t :: s\rangle : B'' \mid \Delta_1 \cup \Delta_2; (\alpha' : A \cup (\gamma : B)^{\leq 1})$ , since  $\delta$  is fresh. Finally, we conclude from (ABS) and (NAME) with  $\gamma, \pi_{\sigma'} \triangleright_{\mathcal{E}} \Gamma \vdash \sigma' \mid \Delta$ .
  - \*  $\text{LTC} = \mu\delta.\text{LCC}'$ . Then from  $\pi_{\text{LTC}\langle[\alpha]t\rangle}$  by (CONT), we the derivation  $\pi_{\text{LCC}'\langle[\alpha]t\rangle} \triangleright_{\mathcal{E}} \Gamma_0 \vdash \text{LCC}'\langle[\alpha]t\rangle \mid \Delta'_0; (\alpha : S \rightarrow A)^{\leq 1}; ((\alpha' : A)^{\leq 1} \cup (\gamma : B)^{\leq 1}); (\delta : B)^{\leq 1}$ . Also, by applying rule (REPL) with  $\pi_s$ , we obtain the type derivation  $\pi_{\text{LCC}'\langle[\alpha]t\rangle \llbracket \alpha \setminus^{\alpha'} s \rrbracket} \triangleright_{\mathcal{E}} \Gamma \vdash \text{LCC}'\langle[\alpha]t\rangle \llbracket \alpha \setminus^{\alpha'} s \rrbracket \mid \Delta; (\alpha' : A \cup (\gamma : B)^{\leq 1}); (\delta : B)^{\leq 1}$ . Due to the *i.h.* there exists  $\pi_{\text{LCC}'\langle[\alpha']t :: s\rangle} \triangleright_{\mathcal{E}} \Gamma \vdash \text{LCC}'\langle[\alpha']t :: s\rangle \mid \Delta; (\alpha' : A \cup (\gamma : B)^{\leq 1}); (\delta : B)^{\leq 1}$ . Finally, we conclude from (CONT) and (NAME),  $\pi_{\sigma'} \triangleright_{\mathcal{E}} \Gamma \vdash \sigma' \mid \Delta$ .
  - \*  $\text{LTC} = \text{LTC}'[x \setminus u]$ . Then by rule (SUBS), we have typing context  $\Gamma_0 = \Gamma'_0 \cup \Gamma''_0$  and  $\Delta_2 = \Delta'_2 \cup \Delta''_2$  with proper typing derivations for the premisses  $\pi_{\text{LTC}'\langle[\alpha]t\rangle} \triangleright_{\mathcal{E}} \Gamma'_0; (x : B')^{\leq 1} \vdash \text{LTC}'\langle[\alpha]t\rangle : B \mid \Delta'_2; (\alpha : S \rightarrow A)^{\leq 1}; ((\alpha' : A)^{\leq 1} \cup (\gamma : B)^{\leq 1})$  and  $\pi_u \triangleright_{\mathcal{E}} \Gamma''_0 \vdash u : B' \mid \Delta''_2; (\alpha : S \rightarrow A)^{\leq 1}; ((\alpha' : A)^{\leq 1} \cup (\gamma : B)^{\leq 1})$ . Moreover, by the hypothesis of the rule  $\mathbb{N}$ , we have  $\alpha \notin u$ . Then by Lem. 4.4,  $(\alpha : S \rightarrow A)^{\leq 1}$  is empty in  $\pi_u$ . Consider  $p = \text{LCC}'\langle[\alpha]t\rangle \llbracket \alpha \setminus^{\alpha'} s \rrbracket$  where  $\text{LCC}' = [\gamma]\text{LTC}'$ . Then, by (NAME) with  $\gamma$  and (REPL) with  $\pi_s$ , we may build the type derivation  $\pi_p \triangleright_{\mathcal{E}} \Gamma'_0 \cup \Gamma_1; (x : B')^{\leq 1} \vdash p \mid \Delta_1 \cup \Delta'_2; (\alpha' : A \cup \gamma : B)$ . Moreover, since  $p \rightarrow_{\mathbb{N}} p' = \text{LCC}'\langle[\alpha']t :: s\rangle$ , by the *i.h.* there exists a typing derivation for the reduct:  $\pi_{p'} \triangleright_{\mathcal{E}} \Gamma'_0 \cup \Gamma_1; (x : B')^{\leq 1} \vdash p' \mid \Delta_1 \cup \Delta'_2; (\alpha' : A \cup \gamma : B)$ . This derivation necessarily



- ends in an application of (NAME) with  $\gamma$ . Then we have the premiss  $\pi_{\text{LTC}'\langle[\alpha']t::s\rangle} \triangleright_{\mathcal{E}} \Gamma'_0 \cup \Gamma_1; (x : B')^{\leq 1} \vdash \text{LTC}'\langle[\alpha']t :: s\rangle : B \mid \Delta_1 \cup \Delta'_2; (\alpha' : A \cup (\gamma : B))^{\leq 1}$ . We conclude by (SUBS) with  $\pi_u$  and therefore (NAME),  $\pi_{o'} \triangleright_{\mathcal{E}} \Gamma \vdash o' \mid \Delta$ .
- $\text{LCC} = \text{LCC}'\llbracket\gamma \setminus^\delta s'\rrbracket$ . Then from  $\pi_{\text{LCC}\langle[\alpha]t\rangle}$  by the rule (REPL), we have typing contexts  $\Gamma_0 = \Gamma'_0 \cup \Gamma''_0$  and  $\Delta_0 = \Delta'_0 \cup \Delta''_0; \delta : B$  with a derivation for  $\pi_{\text{LCC}\langle[\alpha]t\rangle}, \pi_{\text{LCC}'\langle[\alpha]t\rangle} \triangleright_{\mathcal{E}} \Gamma'_0 \vdash \text{LCC}'\langle[\alpha]t\rangle \mid \Delta'_0; (\alpha : S \rightarrow A)^{\leq 1}; (\gamma : S' \rightarrow B)^{\leq 1}; ((\alpha' : A)^{\leq 1} \cup (\delta : B)^{\leq 1})$  and another for  $s', \pi_{s'} \triangleright_{\mathcal{E}} \Gamma''_0 \vdash s' : S' \mid \Delta''_0; (\alpha : S \rightarrow A)^{\leq 1}; ((\alpha' : A)^{\leq 1} \cup (\delta : B)^{\leq 1})$ . Then, applying rule (REPL) with  $\pi_s$ , we obtain the typing derivation  $\pi_{\text{LCC}'\langle[\alpha]t\rrbracket[\alpha \setminus^{\alpha'} s] \triangleright_{\mathcal{E}} \Gamma'_0 \cup \Gamma_1 \vdash \text{LCC}'\langle[\alpha]t\rrbracket[\alpha \setminus^{\alpha'} s] \mid \Delta'_0 \cup \Delta_1; (\gamma : S' \rightarrow B)^{\leq 1}; ((\alpha' : A)^{\leq 1} \cup (\delta : B)^{\leq 1})$ . By the *i.h.* on  $\text{LCC}'$ , we know that there exists a derivation for the reduct  $\pi_{\text{LCC}'\langle[\alpha']t::s\rangle} \triangleright_{\mathcal{E}} \Gamma'_0 \cup \Gamma_1 \vdash \text{LCC}'\langle[\alpha']t :: s\rangle \mid \Delta'_0 \cup \Delta_1; (\gamma : S' \rightarrow B)^{\leq 1}; ((\alpha' : A)^{\leq 1} \cup (\delta : B)^{\leq 1})$ . We finally conclude by (REPL) with  $\pi_{s'}, \pi_{o'} \triangleright_{\mathcal{E}} \Gamma \vdash o' \mid \Delta$ . Note that, by the hypothesis of the rule N,  $\alpha \notin s'$  and by Lem. 4.4,  $(\alpha : S \rightarrow A)^{\leq 1}$  is empty in  $\pi_{s'}$ .
  - $\text{LCC} = \text{LCC}'\llbracket\gamma \setminus \delta\rrbracket$ . Then by (REN), we have  $\Delta_0 = \Delta'_0; \delta : B$  with the derivation  $\pi_{\text{LCC}'\langle[\alpha]t\rangle} \triangleright_{\mathcal{E}} \Gamma_0 \vdash \text{LCC}'\langle[\alpha]t\rangle \mid \Delta_0; (\alpha : S \rightarrow A)^{\leq 1}; ((\alpha' : A)^{\leq 1} \cup (\delta : B)^{\leq 1}); (\gamma : B)^{\leq 1}$ . Combining this derivation with  $\pi_s$  via the rule (REPL), we obtain  $\pi_{\text{LCC}'\langle[\alpha]t\rrbracket[\alpha \setminus^{\alpha'} s] \triangleright_{\mathcal{E}} \Gamma_0 \cup \Gamma_1 \vdash \text{LCC}'\langle[\alpha]t\rrbracket[\alpha \setminus^{\alpha'} s] \mid \Delta'_0 \cup \Delta_1; (\alpha' : A \cup (\delta : B))^{\leq 1}; (\gamma : B)^{\leq 1}$ . Then applying the *i.h.* on  $\text{LCC}'$ , we deduce that there exists a derivation for the reduct  $\pi_{\text{LCC}'\langle[\alpha']t::s\rangle} \triangleright_{\mathcal{E}} \Gamma_0 \cup \Gamma_1 \vdash \text{LCC}'\langle[\alpha']t :: s\rangle \mid \Delta'_0 \cup \Delta_1; (\alpha' : A \cup (\delta : B))^{\leq 1}; (\gamma : B)^{\leq 1}$ . We conclude from (REN),  $\pi_{o'} \triangleright_{\mathcal{E}} \Gamma \vdash o' \mid \Delta$ .
- (2) **C.** Then  $o = \text{LCC}\langle c\llbracket\beta \setminus^\alpha s'\rrbracket\rrbracket\llbracket[\alpha \setminus^{\alpha'} s]\rrbracket$  and  $o' = \text{LCC}\langle c\llbracket\beta \setminus^{\alpha'} s' \cdot s\rrbracket\rrbracket$ . Due to (REPL), we have contexts  $\Gamma = \Gamma_0 \cup \Gamma_1$  and  $\Delta = \Delta_0 \cup \Delta_1; \alpha' : A$  with the derivations  $\pi_{\text{LCC}\langle c\llbracket\beta \setminus^\alpha s'\rrbracket\rrbracket} \triangleright_{\mathcal{E}} \Gamma_0 \vdash \text{LCC}\langle c\llbracket\beta \setminus^\alpha s'\rrbracket\rrbracket \mid \Delta_0; (\alpha : S \rightarrow A)^{\leq 1}; (\alpha' : A)^{\leq 1}$  and  $\pi_s \triangleright_{\mathcal{E}} \Gamma_1 \vdash s : S \mid \Delta_1; (\alpha' : A)^{\leq 1}$ . We proceed by induction on  $\text{LCC}$ .
- $\text{LCC} = \square$ . Then by (REPL) we have contexts  $\Gamma_0 = \Gamma'_0 \cup \Gamma''_0$  and  $\Delta = \Delta'_0 \cup \Delta''_0$  with  $(\alpha : S \rightarrow A)^{\leq 1}$  non empty in  $\pi_{\text{LCC}\langle c\llbracket\beta \setminus^\alpha s'\rrbracket\rrbracket}$  and the derivation for  $c$ , on the one hand,  $\pi_c \triangleright_{\mathcal{E}} \Gamma'_0 \vdash c \mid \Delta'_0; (\beta : S' \rightarrow S \rightarrow A)^{\leq 1}; (\alpha : S \rightarrow A)^{\leq 1}; (\alpha' : A)^{\leq 1}$  and another one for  $s'$ , on the other,  $\pi_{s'} \triangleright_{\mathcal{E}} \Gamma''_0 \vdash s' : S' \mid \Delta''_0; (\alpha : S \rightarrow A)^{\leq 1}; (\alpha' : A)^{\leq 1}$ . Moreover, by the hypothesis of the rule C, we have  $\alpha \notin c$  and  $\alpha \notin s'$ . Then by Lem. 4.4,  $(\alpha : S \rightarrow A)^{\leq 1}$  is empty in  $\pi_c$  and  $\pi_{s'}$ . Due to Lem. B.1 (1), there exists  $\pi_{s',s} \triangleright_{\mathcal{E}} \Gamma''_0 \cup \Gamma_1 \vdash s' \cdot s : S' \cdot S \mid \Delta''_0 \cup \Delta_1; (\alpha' : A)^{\leq 1}$ . Note that  $S' \rightarrow S \rightarrow A = S' \cdot S \rightarrow A$ . Then we conclude by (REPL),  $\pi_{o'} \triangleright_{\mathcal{E}} \Gamma \vdash c\llbracket\beta \setminus^{\alpha'} s' \cdot s\rrbracket \mid \Delta$ .
  - $\text{LCC} = [\gamma]\text{LTC}$ . Then by (NAME), we have  $\Delta_0 = \Delta_2; \gamma : B$  with  $\pi_{\text{LTC}\langle c\llbracket\beta \setminus^\alpha s'\rrbracket\rrbracket} \triangleright_{\mathcal{E}} \Gamma_0 \vdash \text{LTC}\langle c\llbracket\beta \setminus^\alpha s'\rrbracket\rrbracket : B \mid \Delta_2; (\alpha : S \rightarrow A)^{\leq 1}; ((\alpha' : A)^{\leq 1} \cup (\gamma : B)^{\leq 1})$ . We proceed by analyzing the form of  $\text{LTC}$ .
    - \*  $\text{LTC} = \text{LTC}'u$ . Then from  $\pi_{\text{LTC}\langle c\llbracket\beta \setminus^\alpha s'\rrbracket\rrbracket}$  by (APP), we have the contexts  $\Gamma_0 = \Gamma'_0 \cup \Gamma''_0$  and  $\Delta_2 = \Delta'_2 \cup \Delta''_2$  with derivations for the premisses  $\pi_{\text{LTC}'\langle c\llbracket\beta \setminus^\alpha s'\rrbracket\rrbracket} \triangleright_{\mathcal{E}} \Gamma'_0 \vdash \text{LTC}'\langle c\llbracket\beta \setminus^\alpha s'\rrbracket\rrbracket : B' \rightarrow B \mid \Delta'_2; (\alpha : S \rightarrow A)^{\leq 1}; ((\alpha' : A)^{\leq 1} \cup (\gamma : B)^{\leq 1})$  and  $\pi_u \triangleright_{\mathcal{E}} \Gamma''_0 \vdash u : B' \mid \Delta''_2; (\alpha : S \rightarrow A)^{\leq 1}; ((\alpha' : A)^{\leq 1} \cup (\gamma : B)^{\leq 1})$ . Consider therefore  $p = \text{LCC}'\langle c\llbracket\beta \setminus^\alpha s'\rrbracket\rrbracket\llbracket[\alpha \setminus^{\alpha'} s]\rrbracket$  where  $\text{LCC}' = [\delta]\text{LTC}'$  with  $\delta$  a fresh name. Due to rules (NAME) with  $\delta$  and (REPL) with  $\pi_s$ , we obtain the typing derivation  $\pi_p \triangleright_{\mathcal{E}} \Gamma'_0 \cup \Gamma_1 \vdash p \mid \Delta_1 \cup \Delta'_2; \delta : B' \rightarrow B; (\alpha' : A \cup (\gamma : B))^{\leq 1}$ . Moreover, since  $p \rightarrow_{\text{C}} p' = \text{LCC}'\langle c\llbracket\beta \setminus^{\alpha'} s' \cdot s\rrbracket\rrbracket$ , by the *i.h.* there exists a derivation  $\pi_{p'} \triangleright_{\mathcal{E}} \Gamma'_0 \cup \Gamma_1 \vdash p' \mid \Delta_1 \cup \Delta'_2; \delta : B' \rightarrow B; (\alpha' : A \cup (\gamma : B))^{\leq 1}$ . This derivation necessarily ends with the rule (NAME) over  $\delta$ . Then we have  $\pi_{\text{LTC}'\langle c\llbracket\beta \setminus^{\alpha'} s' \cdot s\rrbracket\rrbracket} \triangleright_{\mathcal{E}}$



$\Gamma'_0 \cup \Gamma_1 \vdash \text{LTC}'\langle c[\beta \setminus^{\alpha'} s' \cdot s] \rangle : B' \rightarrow B \mid \Delta_1 \cup \Delta'_2; (\alpha' : A \cup (\gamma : B))^{\leq 1}$ , since  $\delta$  is fresh. Finally, we conclude by (APP) with  $\pi_u$  and therefore (NAME) with  $\gamma$ ,  $\pi_{o'} \triangleright_{\mathcal{E}} \Gamma \vdash o' \mid \Delta$ . Note that, by the hypothesis of the rule  $\mathbf{C}$ , we have  $\alpha \notin u$  and, by Lem. 4.4,  $(\alpha : S \rightarrow A)^{\leq 1}$  is empty in  $\pi_u$ .

- \*  $\text{LTC} = \lambda x. \text{LTC}'$ . Then by (ABS), we have  $B = B' \rightarrow B''$  with  $\pi_{\text{LTC}'\langle c[\beta \setminus^{\alpha'} s'] \rangle} \triangleright_{\mathcal{E}} \Gamma_0; (x : B')^{\leq 1} \vdash \text{LTC}'\langle c[\beta \setminus^{\alpha'} s'] \rangle : B'' \mid \Delta_2; (\alpha : S \rightarrow A)^{\leq 1}; ((\alpha' : A)^{\leq 1} \cup (\gamma : B)^{\leq 1})$ . Consider  $p = \text{LCC}'\langle c[\beta \setminus^{\alpha'} s'] \rangle[\alpha \setminus^{\alpha'} s]$  where  $\text{LCC}' = [\delta] \text{LTC}'$  with  $\delta$  a fresh name. Then, by (NAME) with  $\delta$  and (REPL) with  $\pi_s$ , we obtain the derivation  $\pi_p \triangleright_{\mathcal{E}} \Gamma; (x : B')^{\leq 1} \vdash p \mid \Delta_1 \cup \Delta_2; \delta : B''; (\alpha' : A \cup (\gamma : B))^{\leq 1}$ . Moreover, we have  $p \rightarrow_{\mathbf{C}} p' = \text{LCC}'\langle c[\beta \setminus^{\alpha'} s' \cdot s] \rangle$ . Then, by the *i.h.* there exists a derivation  $\pi_{p'} \triangleright_{\mathcal{E}} \Gamma; (x : B')^{\leq 1} \vdash p' \mid \Delta_1 \cup \Delta_2; \delta : B''; (\alpha' : A \cup (\gamma : B))^{\leq 1}$ . This derivation necessarily ends with the rule (NAME) over  $\delta$ . Then we have  $\pi_{\text{LTC}'\langle c[\beta \setminus^{\alpha'} s' \cdot s] \rangle} \triangleright_{\mathcal{E}} \Gamma; (x : B')^{\leq 1} \vdash \text{LTC}'\langle c[\beta \setminus^{\alpha'} s' \cdot s] \rangle : B'' \mid \Delta_1 \cup \Delta_2; (\alpha' : A \cup (\gamma : B))^{\leq 1}$ , since  $\delta$  is fresh. Finally, we conclude by (ABS) and (NAME) with  $\gamma$ ,  $\pi_{o'} \triangleright_{\mathcal{E}} \Gamma \vdash o' \mid \Delta$ .
- \*  $\text{LTC} = \mu \delta. \text{LCC}'$ . Then, from  $\pi_{\text{LTC}'\langle c[\beta \setminus^{\alpha'} s'] \rangle}$  by rule (CONT), we have  $\pi_{\text{LCC}'\langle c[\beta \setminus^{\alpha'} s'] \rangle} \triangleright_{\mathcal{E}} \Gamma_0 \vdash \text{LCC}'\langle c[\beta \setminus^{\alpha'} s'] \rangle \mid \Delta'_0; (\alpha : S \rightarrow A)^{\leq 1}; ((\alpha' : A)^{\leq 1} \cup (\gamma : B)^{\leq 1}); (\delta : B)^{\leq 1}$ . Applying rule (REPL) with  $\pi_s$ , we obtain the typing derivation  $\pi_{\text{LCC}'\langle c[\beta \setminus^{\alpha'} s'] \rangle[\alpha \setminus^{\alpha'} s]} \triangleright_{\mathcal{E}} \Gamma \vdash \text{LCC}'\langle c[\beta \setminus^{\alpha'} s'] \rangle[\alpha \setminus^{\alpha'} s] \mid \Delta; (\alpha' : A \cup (\gamma : B))^{\leq 1}; (\delta : B)^{\leq 1}$ . Then, by the *i.h.*  $\pi_{\text{LCC}'\langle c[\beta \setminus^{\alpha'} s' \cdot s] \rangle} \triangleright_{\mathcal{E}} \Gamma \vdash \text{LCC}'\langle c[\beta \setminus^{\alpha'} s' \cdot s] \rangle \mid \Delta; (\alpha' : A \cup (\gamma : B))^{\leq 1}; (\delta : B)^{\leq 1}$ . Finally, we conclude by (CONT) and (NAME),  $\pi_{o'} \triangleright_{\mathcal{E}} \Gamma \vdash o' \mid \Delta$ .
- \*  $\text{LTC} = \text{LTC}'[x \setminus u]$ . Then by (SUBS), we have typing contexts  $\Gamma_0 = \Gamma'_0 \cup \Gamma''_0$  and  $\Delta_2 = \Delta'_2 \cup \Delta''_2$  with a derivation for the premis  $\text{LTC}'\langle c[\beta \setminus^{\alpha'} s'] \rangle$ ,  $\pi_{\text{LTC}'\langle c[\beta \setminus^{\alpha'} s'] \rangle} \triangleright_{\mathcal{E}} \Gamma'_0; (x : B')^{\leq 1} \vdash \text{LTC}'\langle c[\beta \setminus^{\alpha'} s'] \rangle : B \mid \Delta'_2; (\alpha : S \rightarrow A)^{\leq 1}; ((\alpha' : A)^{\leq 1} \cup (\gamma : B)^{\leq 1})$ , and another for  $u$ ,  $\pi_u \triangleright_{\mathcal{E}} \Gamma''_0 \vdash u : B' \mid \Delta''_2; (\alpha : S \rightarrow A)^{\leq 1}; ((\alpha' : A)^{\leq 1} \cup (\gamma : B)^{\leq 1})$ . Moreover, by the hypothesis of the rule  $\mathbf{C}$ , we have  $\alpha \notin u$ . Then by Lem. 4.4,  $(\alpha : S \rightarrow A)^{\leq 1}$  is empty and  $\pi_u$ . Consider  $p = \text{LCC}'\langle c[\beta \setminus^{\alpha'} s'] \rangle[\alpha \setminus^{\alpha'} s]$  where  $\text{LCC}' = [\gamma] \text{LTC}'$ . Therefore, by (NAME) with  $\gamma$  and (REPL) with  $\pi_s$ , we have the derivation  $\pi_p \triangleright_{\mathcal{E}} \Gamma'_0 \cup \Gamma_1; (x : B')^{\leq 1} \vdash p \mid \Delta_1 \cup \Delta'_2; (\alpha' : A \cup \gamma : B)$ . In fact, we have  $p \rightarrow_{\mathbf{C}} p' = \text{LCC}'\langle c[\beta \setminus^{\alpha'} s' \cdot s] \rangle$ . Then by the *i.h.* on  $\text{LCC}'$ , we deduce the existence of a derivation  $\pi_{p'} \triangleright_{\mathcal{E}} \Gamma'_0 \cup \Gamma_1; (x : B')^{\leq 1} \vdash p' \mid \Delta_1 \cup \Delta'_2; (\alpha' : A \cup \gamma : B)$ . This derivation necessarily ends with (NAME) over  $\gamma$ . Then  $\pi_{\text{LTC}'\langle c[\beta \setminus^{\alpha'} s' \cdot s] \rangle} \triangleright_{\mathcal{E}} \Gamma'_0 \cup \Gamma_1; (x : B')^{\leq 1} \vdash \text{LTC}'\langle c[\beta \setminus^{\alpha'} s' \cdot s] \rangle : B \mid \Delta_1 \cup \Delta'_2; (\alpha' : A \cup (\gamma : B))^{\leq 1}$ . From the latter, we conclude applying the rule (SUBS) with  $\pi_u$  followed by (NAME) with  $\gamma$ ,  $\pi_{o'} \triangleright_{\mathcal{E}} \Gamma \vdash o' \mid \Delta$ .
- $\text{LCC} = \text{LCC}'[\gamma \setminus^{\delta} s'']$ . Then from  $\pi_{\text{LCC}'\langle c[\beta \setminus^{\alpha'} s'] \rangle}$  by (REPL), we have contexts  $\Gamma_0 = \Gamma'_0 \cup \Gamma''_0$  and  $\Delta_0 = \Delta'_0 \cup \Delta''_0; \delta : B$  with derivations for the premisses  $\pi_{\text{LCC}'\langle c[\beta \setminus^{\alpha'} s'] \rangle} \triangleright_{\mathcal{E}} \Gamma'_0 \vdash \text{LCC}'\langle c[\beta \setminus^{\alpha'} s'] \rangle \mid \Delta'_0; (\alpha : S \rightarrow A)^{\leq 1}; (\gamma : S'' \rightarrow B)^{\leq 1}; ((\alpha' : A)^{\leq 1} \cup (\delta : B)^{\leq 1})$  and  $\pi_{s''} \triangleright_{\mathcal{E}} \Gamma''_0 \vdash s'' : S'' \mid \Delta''_0; (\alpha : S \rightarrow A)^{\leq 1}; ((\alpha' : A)^{\leq 1} \cup (\delta : B)^{\leq 1})$ . Therefore, combining  $\pi_{\text{LCC}'\langle c[\beta \setminus^{\alpha'} s'] \rangle}$  and  $\pi_s$  via the rule (REPL), we obtain  $\pi_{\text{LCC}'\langle c[\beta \setminus^{\alpha'} s'] \rangle[\alpha \setminus^{\alpha'} s]} \triangleright_{\mathcal{E}} \Gamma'_0 \cup \Gamma_1 \vdash \text{LCC}'\langle c[\beta \setminus^{\alpha'} s'] \rangle[\alpha \setminus^{\alpha'} s] \mid \Delta'_0 \cup \Delta_1; (\gamma : S'' \rightarrow B)^{\leq 1}; ((\alpha' : A)^{\leq 1} \cup (\delta : B)^{\leq 1})$ . Then by the *i.h.* over  $\text{LCC}'$ , there exists a derivation for the reduct  $\pi_{\text{LCC}'\langle c[\beta \setminus^{\alpha'} s' \cdot s] \rangle} \triangleright_{\mathcal{E}} \Gamma'_0 \cup \Gamma_1 \vdash \text{LCC}'\langle c[\beta \setminus^{\alpha'} s' \cdot s] \rangle \mid \Delta'_0 \cup \Delta_1; (\gamma : S'' \rightarrow B)^{\leq 1}; ((\alpha' : A)^{\leq 1} \cup (\delta : B)^{\leq 1})$ . Finally, we conclude by (REPL) with  $\pi_{s''}$ ,  $\pi_{o'} \triangleright_{\mathcal{E}} \Gamma \vdash o' \mid \Delta$ . Note that, by the hypothesis of the rule  $\mathbf{C}$ ,  $\alpha \notin s''$  and, by Lem. 4.4,  $(\alpha : S \rightarrow A)^{\leq 1}$  is empty and  $\pi_{s''}$ .

- $\text{LCC} = \text{LCC}'[\gamma \setminus \delta]$ . Then by (REN) we have  $\Delta_0 = \Delta'_0; \delta : B$  with  $\pi_{\text{LCC}'\langle c[\beta \setminus \alpha s'] \rangle} \triangleright_{\mathcal{E}} \Gamma_0 \vdash \text{LCC}'\langle c[\beta \setminus \alpha s'] \rangle \mid \Delta_0; (\alpha : S \rightarrow A)^{\leq 1}; ((\alpha' : A)^{\leq 1} \cup (\delta : B)^{\leq 1}); (\gamma : B)^{\leq 1}$ . Therefore, applying (REPL) with  $\pi_{\text{LCC}'\langle c[\beta \setminus \alpha s'] \rangle}$  and  $\pi_s$ , we obtain  $\pi_{\text{LCC}'\langle c[\beta \setminus \alpha s'] \rangle}[\alpha \setminus \alpha' s] \triangleright_{\mathcal{E}} \Gamma_0 \cup \Gamma_1 \vdash \text{LCC}'\langle c[\beta \setminus \alpha s'] \rangle[\alpha \setminus \alpha' s] \mid \Delta'_0 \cup \Delta_1; (\alpha' : A \cup (\delta : B)^{\leq 1}); (\gamma : B)^{\leq 1}$ . By the *i.h.* over  $\text{LCC}'$ , we deduce the existence of a derivation for the reduct  $\pi_{\text{LCC}'\langle c[\beta \setminus \alpha' s' \cdot s] \rangle} \triangleright_{\mathcal{E}} \Gamma_0 \cup \Gamma_1 \vdash \text{LCC}'\langle c[\beta \setminus \alpha' s' \cdot s] \rangle \mid \Delta'_0 \cup \Delta_1; (\alpha' : A \cup (\delta : B)^{\leq 1}); (\gamma : B)^{\leq 1}$ . We conclude applying (REN) with  $\gamma$  and  $\delta$ ,  $\pi_{o'} \triangleright_{\mathcal{E}} \Gamma \vdash o' \mid \Delta$ .
- (3)  $\mathbb{W}$ . Then  $o = \text{LCC}\langle c[\beta \setminus \alpha] \rangle[\alpha \setminus \alpha' s]$  and  $o' = \text{LCC}\langle c[\beta \setminus \alpha s] \rangle[\alpha \setminus \alpha']$ . Due to (REPL) we have the contexts  $\Gamma = \Gamma_0 \cup \Gamma_1$  and  $\Delta = \Delta_0 \cup \Delta_1; \alpha' : A$  with derivations for the premisses  $\pi_{\text{LCC}\langle c[\beta \setminus \alpha] \rangle} \triangleright_{\mathcal{E}} \Gamma_0 \vdash \text{LCC}\langle c[\beta \setminus \alpha] \rangle \mid \Delta_0; (\alpha : S \rightarrow A)^{\leq 1}; (\alpha' : A)^{\leq 1}$  and  $\pi_s \triangleright_{\mathcal{E}} \Gamma_1 \vdash s : S \mid \Delta_1; (\alpha' : A)^{\leq 1}$ . We proceed by induction on  $\text{LCC}$ .
  - $\text{LCC} = \square$ . Then from  $\pi_{\text{LCC}\langle c[\beta \setminus \alpha] \rangle}$  by (REN), we have the derivation for the premiss  $\pi_c \triangleright_{\mathcal{E}} \Gamma_0 \vdash c \mid \Delta_0; (\beta : S \rightarrow A)^{\leq 1}; (\alpha : S \rightarrow A)^{\leq 1}; (\alpha' : A)^{\leq 1}$ . Moreover, by the hypothesis of the rule  $\mathbb{W}$ , we have  $\alpha \notin c$ . Then by Lem. 4.4,  $(\alpha : S \rightarrow A)^{\leq 1}$  is empty in  $\pi_c$ . Therefore,  $\alpha$  is fresh, by (REPL) with  $\pi_s$ , we obtain  $\pi_{c[\beta \setminus \alpha s]} \triangleright_{\mathcal{E}} \Gamma \vdash c[\beta \setminus \alpha s] \mid \Delta; \alpha : A; (\alpha' : A)^{\leq 1}$ . Then we conclude by (REPL), with the derivation  $\pi_{o'} \triangleright_{\mathcal{E}} \Gamma \vdash c[\beta \setminus \alpha' s][\alpha \setminus \alpha'] \mid \Delta$ .
  - $\text{LCC} = [\gamma] \text{LTC}$ . Then by (NAME), we have the context  $\Delta_0 = \Delta_2; \gamma : B$  with  $\pi_{\text{LTC}\langle c[\beta \setminus \alpha] \rangle} \triangleright_{\mathcal{E}} \Gamma_0 \vdash \text{LTC}\langle c[\beta \setminus \alpha] \rangle : B \mid \Delta_2; (\alpha : S \rightarrow A)^{\leq 1}; ((\alpha' : A)^{\leq 1} \cup (\gamma : B)^{\leq 1})$ . We proceed by analysing the form of  $\text{LTC}$ .
    - \*  $\text{LTC} = \text{LTC}' u$ . Then from  $\pi_{\text{LTC}\langle c[\beta \setminus \alpha] \rangle}$  by (APP), we have the contexts  $\Gamma_0 = \Gamma'_0 \cup \Gamma''_0$  and  $\Delta_2 = \Delta'_2 \cup \Delta''_2$  with derivations for  $\text{LTC}'\langle c[\beta \setminus \alpha] \rangle$ ,  $\pi_{\text{LTC}'\langle c[\beta \setminus \alpha] \rangle} \triangleright_{\mathcal{E}} \Gamma'_0 \vdash \text{LTC}'\langle c[\beta \setminus \alpha] \rangle : B' \rightarrow B \mid \Delta'_2; (\alpha : S \rightarrow A)^{\leq 1}; ((\alpha' : A)^{\leq 1} \cup (\gamma : B)^{\leq 1})$ , and  $u$ ,  $\pi_u \triangleright_{\mathcal{E}} \Gamma''_0 \vdash u : B' \mid \Delta''_2; (\alpha : S \rightarrow A)^{\leq 1}; ((\alpha' : A)^{\leq 1} \cup (\gamma : B)^{\leq 1})$ . Consider  $p = \text{LCC}'\langle c[\beta \setminus \alpha] \rangle[\alpha \setminus \alpha' s]$  where  $\text{LCC}' = [\delta] \text{LTC}'$  with  $\delta$  a fresh name. Therefore, applying (NAME) with  $\delta$  and (REPL) with  $\pi_s$ , we obtain the derivation  $\pi_p \triangleright_{\mathcal{E}} \Gamma'_0 \cup \Gamma_1 \vdash p \mid \Delta_1 \cup \Delta'_2; (\alpha' : A \cup (\gamma : B)^{\leq 1}); \delta : B' \rightarrow B$ . In fact, we have  $p \rightarrow_{\mathbb{W}} p' = \text{LCC}'\langle c[\beta \setminus \alpha s] \rangle[\alpha \setminus \alpha']$ . Then by the *i.h.* there exists a derivation for the reduct  $\pi_{p'} \triangleright_{\mathcal{E}} \Gamma'_0 \cup \Gamma_1 \vdash p' \mid \Delta_1 \cup \Delta'_2; (\alpha' : A \cup (\gamma : B)^{\leq 1}); \delta : B' \rightarrow B$ . This derivation necessarily ends with the rule (NAME) over  $\delta$ . Then we have  $\pi_{\text{LTC}'\langle c[\beta \setminus \alpha s] \rangle}[\alpha \setminus \alpha'] \triangleright_{\mathcal{E}} \Gamma'_0 \cup \Gamma_1 \vdash \text{LTC}'\langle c[\beta \setminus \alpha s] \rangle[\alpha \setminus \alpha'] : B' \rightarrow B \mid \Delta_1 \cup \Delta'_2; (\alpha' : A \cup (\gamma : B)^{\leq 1})$ , since  $\delta$  is fresh. Finally, we conclude by (APP) with  $\pi_u$  and therefore (NAME) with  $\gamma$ ,  $\pi_{o'} \triangleright_{\mathcal{E}} \Gamma \vdash o' \mid \Delta$ . Note that, by the hypothesis of the rule  $\mathbb{W}$ ,  $\alpha \notin u$  and, by Lem. 4.4,  $(\alpha : S \rightarrow A)^{\leq 1}$  is empty in  $\pi_u$ .
    - \*  $\text{LTC} = \lambda x. \text{LTC}'$ . Then by (ABS), we have  $B = B' \rightarrow B''$  with  $\pi_{\text{LTC}'\langle c[\beta \setminus \alpha] \rangle} \triangleright_{\mathcal{E}} \Gamma_0; (x : B')^{\leq 1} \vdash \text{LTC}'\langle c[\beta \setminus \alpha] \rangle : B'' \mid \Delta_2; (\alpha : S \rightarrow A)^{\leq 1}; ((\alpha' : A)^{\leq 1} \cup (\gamma : B)^{\leq 1})$ . Let  $p = \text{LCC}'\langle c[\beta \setminus \alpha] \rangle[\alpha \setminus \alpha' s]$  where  $\text{LCC}' = [\delta] \text{LTC}'$  with  $\delta$  a fresh name. Due to (NAME) and (REPL) with  $\pi_s$ , we have a proper typing derivation for  $p$ ,  $\pi_p \triangleright_{\mathcal{E}} \Gamma; (x : B')^{\leq 1} \vdash p \mid \Delta_1 \cup \Delta_2; (\alpha' : A \cup (\gamma : B)^{\leq 1}); \delta : B''$ . Moreover, since  $p \rightarrow_{\mathbb{W}} p' = \text{LCC}'\langle c[\beta \setminus \alpha s] \rangle[\alpha \setminus \alpha']$ , by the *i.h.* there exists a derivation  $\pi_{p'} \triangleright_{\mathcal{E}} \Gamma; (x : B')^{\leq 1} \vdash p' \mid \Delta_1 \cup \Delta_2; (\alpha' : A \cup (\gamma : B)^{\leq 1}); \delta : B''$ . This derivation necessarily termina with la regla (NAME) sobre  $\delta$ . Then we have  $\pi_{\text{LTC}'\langle c[\beta \setminus \alpha s] \rangle}[\alpha \setminus \alpha'] \triangleright_{\mathcal{E}} \Gamma; (x : B')^{\leq 1} \vdash \text{LTC}'\langle c[\beta \setminus \alpha s] \rangle[\alpha \setminus \alpha'] : B'' \mid \Delta_1 \cup \Delta_2; (\alpha' : A \cup (\gamma : B)^{\leq 1})$ , since  $\delta$  is fresh. Finally, we conclude by (ABS) and (NAME) with  $\gamma$ ,  $\pi_{o'} \triangleright_{\mathcal{E}} \Gamma \vdash o' \mid \Delta$ .

- \*  $\text{LTC} = \mu\delta.\text{LCC}'$ . Then  $\pi_{\text{LTC}\langle c[\beta]\backslash\alpha \rangle}$  by (CONT), we have the derivation  $\pi_{\text{LCC}'\langle c[\beta]\backslash\alpha \rangle} \triangleright_{\mathcal{E}} \Gamma_0 \vdash \text{LCC}'\langle c[\beta]\backslash\alpha \rangle \mid \Delta'_0; (\alpha : S \rightarrow A)^{\leq 1}; ((\alpha' : A)^{\leq 1} \cup (\gamma : B)^{\leq 1}); (\delta : B)^{\leq 1}$ . Moreover, applying rule (REPL) with  $\pi_s$ , we obtain the derivation  $\pi_{\text{LCC}'\langle c[\beta]\backslash\alpha \rangle} \llbracket \alpha \backslash \alpha' s \rrbracket \triangleright_{\mathcal{E}} \Gamma \vdash \text{LCC}'\langle c[\beta]\backslash\alpha \rangle \llbracket \alpha \backslash \alpha' s \rrbracket \mid \Delta; (\alpha' : A \cup (\gamma : B)^{\leq 1}); (\delta : B)^{\leq 1}$ . Then by the *i.h.* on  $\text{LCC}'$ , we deduce the existence of a derivation for the reduct  $\pi_{\text{LCC}'\langle c[\beta]\backslash\alpha \rangle} \llbracket \alpha \backslash \alpha' \rrbracket \triangleright_{\mathcal{E}} \Gamma \vdash \text{LCC}'\langle c[\beta]\backslash\alpha \rangle \llbracket \alpha \backslash \alpha' \rrbracket \mid \Delta; (\alpha' : A \cup (\gamma : B)^{\leq 1}); (\delta : B)^{\leq 1}$ . Finally, we conclude by (CONT) and (NAME),  $\pi_{o'} \triangleright_{\mathcal{E}} \Gamma \vdash o' \mid \Delta$ .
- \*  $\text{LTC} = \text{LTC}'[x \backslash u]$ . Then from  $\pi_{\text{LTC}\langle c[\beta]\backslash\alpha \rangle}$  by (SUBS), we have contexts  $\Gamma_0 = \Gamma'_0 \cup \Gamma''_0$  and  $\Delta_2 = \Delta'_2 \cup \Delta''_2$  with a derivation for  $\pi_{\text{LTC}'\langle c[\beta]\backslash\alpha \rangle}, \pi_{\text{LTC}'\langle c[\beta]\backslash\alpha \rangle} \triangleright_{\mathcal{E}} \Gamma'_0; (x : B')^{\leq 1} \vdash \text{LTC}'\langle c[\beta]\backslash\alpha \rangle : B \mid \Delta'_2; (\alpha : S \rightarrow A)^{\leq 1}; ((\alpha' : A)^{\leq 1} \cup (\gamma : B)^{\leq 1})$ , and another for  $u, \pi_u \triangleright_{\mathcal{E}} \Gamma''_0 \vdash u : B' \mid \Delta''_2; (\alpha : S \rightarrow A)^{\leq 1}; ((\alpha' : A)^{\leq 1} \cup (\gamma : B)^{\leq 1})$ . Moreover, by the hypothesis of the rule  $\mathbb{W}$ , we have  $\alpha \notin u$ . Then by Lem. 4.4,  $(\alpha : S \rightarrow A)^{\leq 1}$  is empty in  $\pi_u$ . Consider  $p = \text{LCC}'\langle c[\beta]\backslash\alpha \rangle \llbracket \alpha \backslash \alpha' s \rrbracket$  where  $\text{LCC}' = [\gamma] \text{LTC}'$ . Therefore, applying the rule (NAME) with  $\gamma$  and (REPL) with  $\pi_s$ , we obtain the derivation  $\pi_p \triangleright_{\mathcal{E}} \Gamma'_0 \cup \Gamma_1; (x : B')^{\leq 1} \vdash p \mid \Delta_1 \cup \Delta'_2; (\alpha' : A \cup \gamma : B)$ . Moreover, we have  $p \rightarrow_{\mathbb{W}} p' = \text{LCC}'\langle c[\beta]\backslash\alpha \rangle \llbracket \alpha \backslash \alpha' \rrbracket$ . Then by the *i.h.* there exists the derivation  $\pi_{p'} \triangleright_{\mathcal{E}} \Gamma'_0 \cup \Gamma_1; (x : B')^{\leq 1} \vdash p' \mid \Delta_1 \cup \Delta'_2; (\alpha' : A \cup \gamma : B)$ . This derivation necessarily ends with (NAME) over  $\gamma$ . Then we have the premiss  $\pi_{\text{LTC}'\langle c[\beta]\backslash\alpha \rangle} \llbracket \alpha \backslash \alpha' \rrbracket \triangleright_{\mathcal{E}} \Gamma'_0 \cup \Gamma_1; (x : B')^{\leq 1} \vdash \text{LTC}'\langle c[\beta]\backslash\alpha \rangle \llbracket \alpha \backslash \alpha' \rrbracket : B \mid \Delta_1 \cup \Delta'_2; (\alpha' : A \cup (\gamma : B)^{\leq 1})$ . Finally, we conclude applying (SUBS) with  $\pi_u$  and (NAME) with  $\gamma$ ,  $\pi_{o'} \triangleright_{\mathcal{E}} \Gamma \vdash o' \mid \Delta$ .
- $\text{LCC} = \text{LCC}'[\gamma \backslash \delta]$ . Then by (REPL), we have the typing contexts  $\Gamma_0 = \Gamma'_0 \cup \Gamma''_0$  and  $\Delta_0 = \Delta'_0 \cup \Delta''_0; \delta : B$  with a derivation for  $\text{LCC}'\langle c[\beta]\backslash\alpha \rangle, \pi_{\text{LCC}'\langle c[\beta]\backslash\alpha \rangle} \triangleright_{\mathcal{E}} \Gamma'_0 \vdash \text{LCC}'\langle c[\beta]\backslash\alpha \rangle \mid \Delta'_0; (\alpha : S \rightarrow A)^{\leq 1}; (\gamma : S' \rightarrow B)^{\leq 1}; ((\alpha' : A)^{\leq 1} \cup (\delta : B)^{\leq 1})$ , and another  $s', \pi_{s'} \triangleright_{\mathcal{E}} \Gamma''_0 \vdash s' : S' \mid \Delta''_0; (\alpha : S \rightarrow A)^{\leq 1}; ((\alpha' : A)^{\leq 1} \cup (\delta : B)^{\leq 1})$ . Combining  $\pi_{\text{LCC}'\langle c[\beta]\backslash\alpha \rangle}$  and  $\pi_s$  via the rule (REPL), we get the derivation  $\pi_{\text{LCC}'\langle c[\beta]\backslash\alpha \rangle} \llbracket \alpha \backslash \alpha' s \rrbracket \triangleright_{\mathcal{E}} \Gamma'_0 \cup \Gamma_1 \vdash \text{LCC}'\langle c[\beta]\backslash\alpha \rangle \llbracket \alpha \backslash \alpha' s \rrbracket \mid \Delta'_0 \cup \Delta_1; (\gamma : S' \rightarrow B)^{\leq 1}; (\alpha' : A \cup (\delta : B)^{\leq 1})$ . The *i.h.* over  $\text{LCC}'$  guarantees the existence of a derivation for the reduct  $\pi_{\text{LCC}'\langle c[\beta]\backslash\alpha \rangle} \llbracket \alpha \backslash \alpha' \rrbracket \triangleright_{\mathcal{E}} \Gamma'_0 \cup \Gamma_1 \vdash \text{LCC}'\langle c[\beta]\backslash\alpha \rangle \llbracket \alpha \backslash \alpha' \rrbracket \mid \Delta'_0 \cup \Delta_1; (\gamma : S' \rightarrow B)^{\leq 1}; (\alpha' : A \cup (\delta : B)^{\leq 1})$ . We conclude by (REPL) with  $\pi_{s'}, \pi_{o'} \triangleright_{\mathcal{E}} \Gamma \vdash o' \mid \Delta$ . Note that, by the hypothesis of the rule  $\mathbb{W}$ ,  $\alpha \notin s'$  and, by Lem. 4.4,  $(\alpha : S \rightarrow A)^{\leq 1}$  is empty in  $\pi_{s'}$ .
- $\text{LCC} = \text{LCC}'[\gamma \backslash \delta]$ . Then by (REN), we have  $\Delta_0 = \Delta'_0; \delta : B$  with  $\pi_{\text{LCC}'\langle c[\beta]\backslash\alpha \rangle} \triangleright_{\mathcal{E}} \Gamma_0 \vdash \text{LCC}'\langle c[\beta]\backslash\alpha \rangle \mid \Delta_0; (\alpha : S \rightarrow A)^{\leq 1}; ((\alpha' : A)^{\leq 1} \cup (\delta : B)^{\leq 1}); (\gamma : B)^{\leq 1}$ . By rule (REPL), combining  $\pi_{\text{LCC}'\langle c[\beta]\backslash\alpha \rangle}$  and  $\pi_s$ , we obtain the derivation  $\pi_{\text{LCC}'\langle c[\beta]\backslash\alpha \rangle} \llbracket \alpha \backslash \alpha' s \rrbracket \triangleright_{\mathcal{E}} \Gamma_0 \cup \Gamma_1 \vdash \text{LCC}'\langle c[\beta]\backslash\alpha \rangle \llbracket \alpha \backslash \alpha' s \rrbracket \mid \Delta_0 \cup \Delta_1; (\alpha' : A \cup (\delta : B)^{\leq 1}); (\gamma : B)^{\leq 1}$ . Then the *i.h.* on  $\text{LCC}'$  guarantees the existence of a derivation for the reduct  $\pi_{\text{LCC}'\langle c[\beta]\backslash\alpha \rangle} \llbracket \alpha \backslash \alpha' \rrbracket \triangleright_{\mathcal{E}} \Gamma_0 \cup \Gamma_1 \vdash \text{LCC}'\langle c[\beta]\backslash\alpha \rangle \llbracket \alpha \backslash \alpha' \rrbracket \mid \Delta_0 \cup \Delta_1; (\alpha' : A \cup (\delta : B)^{\leq 1}); (\gamma : B)^{\leq 1}$ . From the latter, we conclude by applying (REN) with  $\gamma$ ,  $\pi_{o'} \triangleright_{\mathcal{E}} \Gamma \vdash o' \mid \Delta$ .
- $\mathbb{0} = \text{T}u$ . Then  $o = tu$  and  $o' = t'u$  with  $t \rightarrow_{\mathcal{P}} t'$ . Moreover, by (APP) we have  $\Gamma = \Gamma_0 \cup \Gamma_1$  and  $\Delta = \Delta_0 \cup \Delta_1$  with  $\pi_t \triangleright_{\mathcal{E}} \Gamma_0 \vdash t : A \rightarrow T \mid \Delta_0$  and  $\pi_u \triangleright_{\mathcal{E}} \Gamma_1 \vdash u : A \mid \Delta_1$ . Due to the *i.h.* there exists  $\pi_{t'} \triangleright_{\mathcal{E}} \Gamma_0 \vdash t' : A \rightarrow T \mid \Delta_0$ . Finally, we conclude by (APP),  $\pi' \triangleright_{\mathcal{E}} \Gamma \vdash o' : T \mid \Delta$ .
- $\mathbb{0} = \text{T}T$ . Then  $o = tu$  and  $o' = tu'$  with  $u \rightarrow_{\mathcal{P}} u'$ . Moreover, by (APP) we have  $\Gamma = \Gamma_0 \cup \Gamma_1$  and  $\Delta = \Delta_0 \cup \Delta_1$  with  $\pi_t \triangleright_{\mathcal{E}} \Gamma_0 \vdash t : A \rightarrow T \mid \Delta_0$  and  $\pi_u \triangleright_{\mathcal{E}} \Gamma_1 \vdash u : A \mid \Delta_1$ . Due to the *i.h.* there exists  $\pi_{u'} \triangleright_{\mathcal{E}} \Gamma_1 \vdash u' : A \mid \Delta_1$ . Finally, we conclude by (APP),  $\pi' \triangleright_{\mathcal{E}} \Gamma \vdash o' : T \mid \Delta$ .

- $\mathbf{0} = \lambda x.T$ . Then  $o = \lambda x.t$  and  $o' = \lambda x.t'$  with  $t \rightarrow_{\mathcal{P}} t'$ . Moreover, by (ABS) we have  $T = A \rightarrow B$  with  $\pi_t \triangleright_{\mathcal{E}} \Gamma; (x : A)^{\leq 1} \vdash t : B \mid \Delta$ . Due to the *i.h.* there exists  $\pi_{t'} \triangleright_{\mathcal{E}} \Gamma; (x : A)^{\leq 1} \vdash t' : B \mid \Delta$ . Finally, we conclude by (ABS),  $\pi' \triangleright_{\mathcal{E}} \Gamma \vdash o' : T \mid \Delta$ .
- $\mathbf{0} = \mu \alpha.C$ . Then  $o = \mu \alpha.c$  and  $o' = \mu \alpha.c'$  with  $c \rightarrow_{\mathcal{P}} c'$ . Moreover, by (CONT) we have  $\pi_c \triangleright_{\mathcal{E}} \Gamma \vdash c \mid \Delta; (\alpha : T)^{\leq 1}$ . Due to the *i.h.* there exists a derivation  $\pi_{c'} \triangleright_{\mathcal{E}} \Gamma \vdash c' \mid \Delta; (\alpha : T)^{\leq 1}$ . Finally, we conclude by (CONT),  $\pi' \triangleright_{\mathcal{E}} \Gamma \vdash o' : T \mid \Delta$ .
- $\mathbf{0} = \mathbf{T}[x \setminus u]$ . Then  $o = t[x \setminus u]$  and  $o' = t'[x \setminus u]$  with  $t \rightarrow_{\mathcal{P}} t'$ . Moreover, by (SUBS),  $\Gamma = \Gamma_0 \cup \Gamma_1$  and  $\Delta = \Delta_0 \cup \Delta_1$  with  $\pi_t \triangleright_{\mathcal{E}} \Gamma_0; (x : A)^{\leq 1} \vdash t : T \mid \Delta_0$  and  $\pi_u \triangleright_{\mathcal{E}} \Gamma_1 \vdash u : A \mid \Delta_1$ . Due to the *i.h.* there exists  $\pi_{t'} \triangleright_{\mathcal{E}} \Gamma_0; (x : A)^{\leq 1} \vdash t' : T \mid \Delta_0$ . Finally, we conclude by (SUBS),  $\pi' \triangleright_{\mathcal{E}} \Gamma \vdash o' : T \mid \Delta$ .
- $\mathbf{0} = t[x \setminus \mathbf{T}]$ . Then  $o = t[x \setminus u]$  and  $o' = t[x \setminus u']$  with  $u \rightarrow_{\mathcal{P}} u'$ . Moreover, by (SUBS) we have  $\Gamma = \Gamma_0 \cup \Gamma_1$  and  $\Delta = \Delta_0 \cup \Delta_1$  with  $\pi_t \triangleright_{\mathcal{E}} \Gamma_0; (x : A)^{\leq 1} \vdash t : T \mid \Delta_0$  and  $\pi_u \triangleright_{\mathcal{E}} \Gamma_1 \vdash u : A \mid \Delta_1$ . Due to the *i.h.* there exists  $\pi_{u'} \triangleright_{\mathcal{E}} \Gamma_1 \vdash u' : A \mid \Delta_1$ . Finally, we conclude by (SUBS),  $\pi' \triangleright_{\mathcal{E}} \Gamma \vdash o' : T \mid \Delta$ .
- $\mathbf{0} = [\alpha]T$ . Then  $o = [\alpha]t$  and  $o' = [\alpha]t'$  with  $t \rightarrow_{\mathcal{P}} t'$ . Moreover, by (NAME) we have  $\Delta = \Delta_0; \alpha : A$  with  $\pi_t \triangleright_{\mathcal{E}} \Gamma \vdash t : A \mid \Delta_0; (\alpha : A)^{\leq 1}$ . Due to the *i.h.* there exists  $\pi_{t'} \triangleright_{\mathcal{E}} \Gamma \vdash t' : A \mid \Delta_0; (\alpha : A)^{\leq 1}$ . We conclude by (NAME),  $\pi' \triangleright_{\mathcal{E}} \Gamma \vdash o' : T \mid \Delta_0; \alpha : A$ .
- $\mathbf{0} = \mathbf{C}[\alpha \setminus \alpha' s]$ . Then  $o = c[\alpha \setminus \alpha' s]$  and  $o' = c'[\alpha \setminus \alpha' s]$  with  $c \rightarrow_{\mathcal{P}} c'$ . Moreover, by (REPL) we have  $\Gamma = \Gamma_0 \cup \Gamma_1$  and  $\Delta = \Delta_0 \cup \Delta_1; \alpha' : A$  with  $\pi_c \triangleright_{\mathcal{E}} \Gamma_0 \vdash c \mid \Delta_0; (\alpha : S \rightarrow A)^{\leq 1}; (\alpha' : A)^{\leq 1}$  and  $\pi_s \triangleright_{\mathcal{E}} \Gamma_1 \vdash s : A \mid \Delta_1; (\alpha' : A)^{\leq 1}$ . Due to the *i.h.* there exists a typing derivation  $\pi_{c'} \triangleright_{\mathcal{E}} \Gamma_0 \vdash c' \mid \Delta_0; (\alpha : S \rightarrow A)^{\leq 1}; (\alpha' : A)^{\leq 1}$ . Finally, we conclude by (REPL),  $\pi' \triangleright_{\mathcal{E}} \Gamma \vdash o' : T \mid \Delta$ .
- $\mathbf{0} = c[\alpha \setminus \alpha' S]$ . Then  $o = c[\alpha \setminus \alpha' s]$  and  $o' = c[\alpha \setminus \alpha' s']$  with  $s \rightarrow_{\mathcal{P}} s'$ . Moreover, by (REPL) we have  $\Gamma = \Gamma_0 \cup \Gamma_1$  and  $\Delta = \Delta_0 \cup \Delta_1; \alpha' : A$  with  $\pi_c \triangleright_{\mathcal{E}} \Gamma_0 \vdash c \mid \Delta_0; (\alpha : S \rightarrow A)^{\leq 1}; (\alpha' : A)^{\leq 1}$  and  $\pi_s \triangleright_{\mathcal{E}} \Gamma_1 \vdash s : A \mid \Delta_1; (\alpha' : A)^{\leq 1}$ . Due to the *i.h.* there exist a derivation  $\pi_{s'} \triangleright_{\mathcal{E}} \Gamma_1 \vdash s' : A \mid \Delta_1; (\alpha' : A)^{\leq 1}$ . Finally, we conclude by (REPL),  $\pi' \triangleright_{\mathcal{E}} \Gamma \vdash o' : T \mid \Delta$ .
- $\mathbf{0} = \mathbf{C}[\alpha \setminus \beta]$ . Then  $o = c[\alpha \setminus \beta]$  and  $o' = c'[\alpha \setminus \beta]$  with  $c \rightarrow_{\mathcal{P}} c'$ . Moreover, by (REN) we have  $\Delta = \Delta_0; \beta : A$  with  $\pi_c \triangleright_{\mathcal{E}} \Gamma \vdash c \mid \Delta_0; (\alpha : A)^{\leq 1}; (\beta : A)^{\leq 1}$ . Due to the *i.h.* there exists a derivation  $\pi_{c'} \triangleright_{\mathcal{E}} \Gamma \vdash c' \mid \Delta_0; (\alpha : A)^{\leq 1}; (\beta : A)^{\leq 1}$ . Finally, we conclude by (REN),  $\pi' \triangleright_{\mathcal{E}} \Gamma \vdash o' : T \mid \Delta$ .
- $\mathbf{0} = \mathbf{T} \cdot s$ . Then  $o = t \cdot s$  and  $o' = t' \cdot s$  with  $t \rightarrow_{\mathcal{P}} t'$ . Moreover, by (STK) we have  $T = A \cdot S$ ,  $\Gamma = \Gamma_0 \cup \Gamma_1$  and  $\Delta = \Delta_0 \cup \Delta_1$  with  $\pi_t \triangleright_{\mathcal{E}} \Gamma_0 \vdash t : A \mid \Delta_0$  and  $\pi_s \triangleright_{\mathcal{E}} \Gamma_1 \vdash s : S \mid \Delta_1$ . Due to the *i.h.* there exists  $\pi_{t'} \triangleright_{\mathcal{E}} \Gamma_0 \vdash t' : A \mid \Delta_0$ . Finally, we conclude by (STK),  $\pi' \triangleright_{\mathcal{E}} \Gamma \vdash o' : T \mid \Delta$ .
- $\mathbf{0} = t \cdot \mathbf{S}$ . Then  $o = t \cdot s$  and  $o' = t \cdot s'$  with  $s \rightarrow_{\mathcal{P}} s'$ . Moreover, by (STK) we have  $T = A \cdot S$ ,  $\Gamma = \Gamma_0 \cup \Gamma_1$  and  $\Delta = \Delta_0 \cup \Delta_1$  with  $\pi_t \triangleright_{\mathcal{E}} \Gamma_0 \vdash t : A \mid \Delta_0$  and  $\pi_s \triangleright_{\mathcal{E}} \Gamma_1 \vdash s : S \mid \Delta_1$ . Due to the *i.h.* there exists  $\pi_{s'} \triangleright_{\mathcal{E}} \Gamma_1 \vdash s' : S \mid \Delta_1$ . Finally, we conclude with (STK),  $\pi' \triangleright_{\mathcal{E}} \Gamma \vdash o' : T \mid \Delta$ .

□

**Lemma D.3** (Subject Expansion). *Let  $o \in \mathbb{O}_{\Lambda M}$ . If  $\pi \triangleright_{\mathcal{E}} \Gamma \vdash o : T \mid \Delta$   $y \ o' \rightarrow_{\mathcal{P}} o$ , then there exists  $\pi' \triangleright_{\mathcal{E}} \Gamma \vdash o' : T \mid \Delta$ .*

*Proof.* By definition,  $o' \rightarrow_{\mathcal{P}} o$  implies  $o' = \mathbf{0}\langle l \rangle$  and  $o = \mathbf{0}\langle r \rangle$  with  $l \mapsto_* r$ ,  $*$   $\in \{\mathbf{dB}, \mathbf{dM}, \mathbf{N}, \mathbf{C}, \mathbf{W}\}$ . The proof is by induction on  $\mathbf{0}$ .

- $\mathbf{0} = \square$ . Therefore, we have two possible case according to the rewrite rule applied.

(1) **dB**. Therefore,  $o = \mathbf{L}\langle t[x \setminus u] \rangle$  and  $o' = \mathbf{L}\langle \lambda x.t \rangle u$ . We proceed by induction on  $\mathbf{L}$ .

- $L = \square$ . Therefore, by (SUBS) we have  $\Gamma = \Gamma_0 \cup \Gamma_1$  and  $\Delta = \Delta_0 \cup \Delta_1$  with the derivations  $\pi_t \triangleright_{\mathcal{E}} \Gamma_0; (x : A)^{\leq 1} \vdash t : T \mid \Delta_0$  and  $\pi_u \triangleright_{\mathcal{E}} \Gamma_1 \vdash u : A \mid \Delta_1$ . By (ABS) with  $\pi_t$  we obtain  $\pi_{L\langle\lambda x.t\rangle} \triangleright_{\mathcal{E}} \Gamma_0 \vdash L\langle\lambda x.t\rangle : A \rightarrow T \mid \Delta_0$ . We conclude by (APP) with  $\pi_u$ ,  $\pi' \triangleright_{\mathcal{E}} \Gamma \vdash L\langle\lambda x.t\rangle u : T \mid \Delta$ .
  - $L = L'[y \setminus v]$  with  $y \notin u$ . Therefore, by (SUBS) we have  $\Gamma = \Gamma_0 \cup \Gamma_1$  and  $\Delta = \Delta_0 \cup \Delta_1$  with  $\pi_{L'\langle t[x \setminus u]\rangle} \triangleright_{\mathcal{E}} \Gamma_0; (y : B)^{\leq 1} \vdash L'\langle t[x \setminus u]\rangle : T \mid \Delta_0$  and  $\pi_v \triangleright_{\mathcal{E}} \Gamma_1 \vdash v : B \mid \Delta_1$ . By the *i.h.* there exists a derivation  $\pi_{L'\langle\lambda x.t\rangle u} \triangleright_{\mathcal{E}} \Gamma_0; (y : B)^{\leq 1} \vdash L'\langle\lambda x.t\rangle u : T \mid \Delta_0$ . Moreover, from (APP) we have  $\Gamma_0 = \Gamma'_0 \cup \Gamma''_0$  and  $\Delta_0 = \Delta'_0 \cup \Delta''_0$  with derivations  $\pi_{L'\langle\lambda x.t\rangle} \triangleright_{\mathcal{E}} \Gamma'_0; (y : B)^{\leq 1} \vdash L'\langle\lambda x.t\rangle : A \rightarrow T \mid \Delta'_0$  and  $\pi_u \triangleright_{\mathcal{E}} \Gamma''_0 \vdash u : A \mid \Delta''_0$ . Note that, by Lem. 4.4,  $y \notin \text{dom}(\Gamma''_0)$ . Therefore, by (SUBS) with  $\pi_{L'\langle\lambda x.t\rangle}$  and  $\pi_v$  we obtain the derivation  $\pi_{L\langle\lambda x.t\rangle} \triangleright_{\mathcal{E}} \Gamma'_0 \cup \Gamma_1 \vdash L\langle\lambda x.t\rangle : A \rightarrow T \mid \Delta'_0 \cup \Delta_1$ . Finally, we conclude by (APP) with  $\pi_u$ ,  $\pi' \triangleright_{\mathcal{E}} \Gamma \vdash L\langle\lambda x.t\rangle u : T \mid \Delta$ .
- (2) **dM**. Therefore,  $o = L\langle\mu\alpha'.c[\alpha \setminus^{\alpha'} u]\rangle$  and  $o' = L\langle\mu\alpha.c\rangle u$  with  $\alpha'$  a fresh name. We proceed by induction on  $L$ .
- $L = \square$ . Then, by (CONT) we have the derivation  $\pi_{c[\alpha \setminus^{\alpha'} u]} \triangleright_{\mathcal{E}} \Gamma \vdash c[\alpha \setminus^{\alpha'} u] \mid \Delta; \alpha' : T$ . Moreover, by (REPL), we have the contexts  $\Gamma = \Gamma_0 \cup \Gamma_1$  and  $\Delta = \Delta_0 \cup \Delta_1$  with the derivations  $\pi_c \triangleright_{\mathcal{E}} \Gamma_0 \vdash c \mid \Delta_0; (\alpha : A \rightarrow T)^{\leq 1}; (\alpha' : T)^{\leq 1}$  and  $\pi_u \triangleright_{\mathcal{E}} \Gamma_1 \vdash u : A \mid \Delta_1$ . Note that, by Lem. 4.4,  $\alpha'$  fresh implies  $(\alpha' : T)^{\leq 1}$  empty in  $\pi_c$ . Therefore, by (CONT) we obtain  $\pi_{\mu\alpha.c} \triangleright_{\mathcal{E}} \Gamma_0 \vdash \mu\alpha.c : A \rightarrow T \mid \Delta_0$ . Finally, we conclude by (APP) with  $\pi_u$ ,  $\pi' \triangleright_{\mathcal{E}} \Gamma \vdash L\langle\mu\alpha.c\rangle u : T \mid \Delta$ .
  - $L = L'[y \setminus v]$  with  $y \notin u$ . Therefore, by (SUBS),  $\Gamma = \Gamma_0 \cup \Gamma_1$  and  $\Delta = \Delta_0 \cup \Delta_1$  with typing derivations  $\pi_{L'\langle\mu\alpha'.c[\alpha \setminus^{\alpha'} u]\rangle} \triangleright_{\mathcal{E}} \Gamma_0; (y : B)^{\leq 1} \vdash L'\langle\mu\alpha'.c[\alpha \setminus^{\alpha'} u]\rangle : T \mid \Delta_0$  and  $\pi_v \triangleright_{\mathcal{E}} \Gamma_1 \vdash v : B \mid \Delta_1$ . By the *i.h.* there exists a derivation  $\pi_{L'\langle\mu\alpha.c\rangle u} \triangleright_{\mathcal{E}} \Gamma_0; (y : B)^{\leq 1} \vdash L'\langle\mu\alpha.c\rangle u : T \mid \Delta_0$ . Moreover, from (APP) we have  $\Gamma_0 = \Gamma'_0 \cup \Gamma''_0$  and  $\Delta_0 = \Delta'_0 \cup \Delta''_0$  with derivations  $\pi_{L'\langle\mu\alpha.c\rangle} \triangleright_{\mathcal{E}} \Gamma'_0; (y : B)^{\leq 1} \vdash L'\langle\mu\alpha.c\rangle : A \rightarrow T \mid \Delta'_0$  and  $\pi_u \triangleright_{\mathcal{E}} \Gamma''_0 \vdash u : A \mid \Delta''_0$ . Note that, by Lem. 4.4,  $y \notin \text{dom}(\Gamma''_0)$ . Therefore, by (SUBS) with  $\pi_{L'\langle\mu\alpha.c\rangle}$  and  $\pi_v$  we obtain  $\pi_{L\langle\mu\alpha.c\rangle} \triangleright_{\mathcal{E}} \Gamma'_0 \cup \Gamma_1 \vdash L\langle\mu\alpha.c\rangle : A \rightarrow T \mid \Delta'_0 \cup \Delta_1$ . Finally, we conclude by (APP) with  $\pi_u$ ,  $\pi' \triangleright_{\mathcal{E}} \Gamma \vdash L\langle\mu\alpha.c\rangle u : T \mid \Delta$ .
- $\mathbf{0} = \square$ . Therefore, we have three possible case according to the rewrite rule applied.
- (1) **N**. Therefore,  $o = \text{LCC}\langle[\alpha'] t :: s\rangle$  and  $o' = \text{LCC}\langle[\alpha] t\rangle[\alpha \setminus^{\alpha'} s]$ . We proceed by induction on **LCC**.
- **LCC** =  $\square$ . Therefore, by (NAME) we obtain the context  $\Delta = \Delta'; \alpha' : A$  with the derivation  $\pi_{t::s} \triangleright_{\mathcal{E}} \Gamma \vdash t :: s : A \mid \Delta'; (\alpha' : A)^{\leq 1}$ . By Lem. B.1 (4), we have  $\Gamma = \Gamma_0 \cup \Gamma_1$  and  $\Delta' = \Delta_0 \cup \Delta_1$  with  $\pi_t \triangleright_{\mathcal{E}} \Gamma_0 \vdash t : S \rightarrow A \mid \Delta_0; (\alpha' : A)^{\leq 1}$  and  $\pi_s \triangleright_{\mathcal{E}} \Gamma_1 \vdash s : S \mid \Delta_1; (\alpha' : A)^{\leq 1}$ . Moreover, by hypothesis of the rule **N**,  $\alpha \notin t$ . Therefore, by (NAME) with  $\alpha$  and  $\pi_t$ , we have  $\pi_{[\alpha]t} \triangleright_{\mathcal{E}} \Gamma_0 \vdash [\alpha]t \mid \Delta_0; \alpha : S \rightarrow A; (\alpha' : A)^{\leq 1}$ . Finally, we conclude by (REPL) with  $\pi_s$ ,  $\pi_{o'} \triangleright_{\mathcal{E}} \Gamma \vdash o' \mid \Delta$ .
  - **LCC** =  $[\gamma] \text{LTC}$ . Therefore, by Lem. 4.4 with  $\alpha' \in o$  and (NAME), we have the typing context  $\Delta = \Delta'; (\alpha' : A \cup \gamma : B)$  with the following derivation  $\pi_{\text{LTC}\langle[\alpha'] t::s\rangle} \triangleright_{\mathcal{E}} \Gamma \vdash \text{LTC}\langle[\alpha'] t :: s\rangle : B \mid \Delta'; (\alpha' : A \cup (\gamma : B)^{\leq 1})$ . We proceed by analysing the form of **LTC**.
    - \* **LTC** =  $\text{LTC}' u$ . Therefore, by (APP), we have the typing contexts  $\Gamma = \Gamma_0 \cup \Gamma_1$  and  $\Delta' = \Delta_0 \cup \Delta_1$  with a derivation for  $\text{LTC}'\langle[\alpha'] t :: s\rangle$ ,  $\pi_{\text{LTC}'\langle[\alpha'] t::s\rangle} \triangleright_{\mathcal{E}} \Gamma_0 \vdash \text{LTC}'\langle[\alpha'] t :: s\rangle : B' \rightarrow B \mid \Delta_0; (\alpha' : A \cup (\gamma : B)^{\leq 1})$ , and another for  $u$ ,  $\pi_u \triangleright_{\mathcal{E}} \Gamma_1 \vdash u : B' \mid \Delta_1; (\alpha' : A \cup (\gamma : B)^{\leq 1})$ . Consider  $p = \text{LCC}'\langle[\alpha'] t :: s\rangle$  where  $\text{LCC}' =$



$[\delta] \text{LTC}'$  with  $\delta$  a fresh name. Therefore, by (NAME), we have the derivation  $\pi_p \triangleright_{\mathcal{E}} \Gamma_0 \vdash p \mid \Delta_0; (\alpha' : A \cup (\gamma : B)^{\leq 1}); \delta : B' \rightarrow B$ . Moreover, since the reduct  $p' = \text{LCC}'\langle[\alpha]t\rangle \llbracket \alpha \setminus^{\alpha'} s \rrbracket \rightarrow_{\mathbb{N}} p$ , we may apply the *i.h.* to guarantee the existence of  $\pi_{p'} \triangleright_{\mathcal{E}} \Gamma_0 \vdash p' \mid \Delta_0; (\alpha' : A \cup (\gamma : B)^{\leq 1}); \delta : B' \rightarrow B$ . This derivation necessarily ends with applications of the rules (REPL) and (NAME) with  $\delta$ . Therefore, we have the contexts  $\Gamma_0 = \Gamma'_0 \cup \Gamma''_0$  and  $\Delta_0 = \Delta'_0 \cup \Delta''_0$  with derivations  $\pi_{\text{LTC}'\langle[\alpha]t\rangle} \triangleright_{\mathcal{E}} \Gamma'_0 \vdash \text{LTC}'\langle[\alpha]t\rangle : B' \rightarrow B \mid \Delta'_0; \alpha : S \rightarrow A; ((\alpha' : A)^{\leq 1} \cup (\gamma : B)^{\leq 1})$  as well as  $\pi_s \triangleright_{\mathcal{E}} \Gamma''_0 \vdash s : S \mid \Delta''_0; ((\alpha' : A)^{\leq 1} \cup (\gamma : B)^{\leq 1})$ , given that  $\delta$  is fresh. Therefore, applying (APP) with  $\pi_u$  seguido de (NAME) with  $\gamma$ , we obtain the derivation  $\pi_{\text{LCC}\langle[\alpha]t\rangle} \triangleright_{\mathcal{E}} \Gamma'_0 \cup \Gamma_1 \vdash \text{LCC}\langle[\alpha]t\rangle \mid \Delta'_0 \cup \Delta_1; \alpha : S \rightarrow A; ((\alpha' : A)^{\leq 1} \cup \gamma : B)$ . Finally, we conclude by (REPL) with  $\pi_s, \pi_{o'} \triangleright_{\mathcal{E}} \Gamma \vdash o' \mid \Delta$ .

\*  $\text{LTC} = \lambda x. \text{LTC}'$ . Therefore, by (ABS), we have  $B = B' \rightarrow B''$  with the derivation  $\pi_{\text{LTC}'\langle[\alpha']t::s\rangle} \triangleright_{\mathcal{E}} \Gamma; (x : B')^{\leq 1} \vdash \text{LTC}'\langle[\alpha']t::s\rangle : B'' \mid \Delta'; (\alpha' : A \cup (\gamma : B)^{\leq 1})$ . Consider  $p = \text{LCC}'\langle[\alpha']t::s\rangle$  where  $\text{LCC}' = [\delta] \text{LTC}'$  with  $\delta$  a fresh name. Then, by (NAME), we obtain  $\pi_p \triangleright_{\mathcal{E}} \Gamma; (x : B')^{\leq 1} \vdash p \mid \Delta'; (\alpha' : A \cup (\gamma : B)^{\leq 1}); \delta : B''$ . Moreover, since the reduct  $p' = \text{LCC}'\langle[\alpha]t\rangle \llbracket \alpha \setminus^{\alpha'} s \rrbracket \rightarrow_{\mathbb{N}} p$ , we may apply the *i.h.* to guarantee the existence of  $\pi_{p'} \triangleright_{\mathcal{E}} \Gamma; (x : B')^{\leq 1} \vdash p' \mid \Delta'; (\alpha' : A \cup (\gamma : B)^{\leq 1}); \delta : B''$ . As before, from (REPL) and (NAME), given that  $\delta$  is fresh, we have the typing contexts  $\Gamma = \Gamma_0 \cup \Gamma_1$  and  $\Delta' = \Delta_0 \cup \Delta_1$  with derivations  $\pi_{\text{LTC}'\langle[\alpha]t\rangle} \triangleright_{\mathcal{E}} \Gamma_0; (x : B')^{\leq 1} \vdash \text{LTC}'\langle[\alpha]t\rangle : B'' \mid \Delta_0; \alpha : S \rightarrow A; ((\alpha' : A)^{\leq 1} \cup (\gamma : B)^{\leq 1})$  as well as  $\pi_s \triangleright_{\mathcal{E}} \Gamma_1 \vdash s : S \mid \Delta_1; ((\alpha' : A)^{\leq 1} \cup (\gamma : B)^{\leq 1})$ . Therefore, applying rule (ABS) followed by (NAME) with  $\gamma$ , we construct the typing derivation  $\pi_{\text{LCC}\langle[\alpha]t\rangle} \triangleright_{\mathcal{E}} \Gamma_0 \vdash \text{LCC}\langle[\alpha]t\rangle \mid \Delta_0; \alpha : S \rightarrow A; ((\alpha' : A)^{\leq 1} \cup \gamma : B)$ . Finally, we conclude from (REPL) with  $\pi_s, \pi_{o'} \triangleright_{\mathcal{E}} \Gamma \vdash o' \mid \Delta$ .

\*  $\text{LTC} = \mu \delta. \text{LCC}'$ . Therefore, from  $\pi_{\text{LTC}\langle[\alpha']t::s\rangle}$  by (CONT), we have the premiss  $\pi_{\text{LCC}'\langle[\alpha']t::s\rangle} \triangleright_{\mathcal{E}} \Gamma \vdash \text{LCC}'\langle[\alpha']t::s\rangle \mid \Delta'; (\alpha' : A \cup (\gamma : B)^{\leq 1}); (\delta : B)^{\leq 1}$ . Moreover, by applying the *i.h.* on  $\text{LCC}'$ , we guarantee the existence of a typing derivation  $\pi_{\text{LCC}'\langle[\alpha]t\rangle \llbracket \alpha \setminus^{\alpha'} s \rrbracket} \triangleright_{\mathcal{E}} \Gamma \vdash \text{LCC}'\langle[\alpha]t\rangle \llbracket \alpha \setminus^{\alpha'} s \rrbracket \mid \Delta'; (\alpha' : A \cup (\gamma : B)^{\leq 1}); (\delta : B)^{\leq 1}$ . From (REPL), we have  $\Gamma = \Gamma_0 \cup \Gamma_1$  and  $\Delta' = \Delta_0 \cup \Delta_1$  with the premiss  $\pi_{\text{LCC}'\langle[\alpha]t\rangle} \triangleright_{\mathcal{E}} \Gamma_0 \vdash \text{LCC}'\langle[\alpha]t\rangle \mid \Delta_0; \alpha : S \rightarrow A; ((\alpha' : A)^{\leq 1} \cup (\gamma : B)^{\leq 1}); (\delta : B)^{\leq 1}$  and also  $\pi_s \triangleright_{\mathcal{E}} \Gamma_1 \vdash s : S \mid \Delta_1; ((\alpha' : A)^{\leq 1} \cup (\gamma : B)^{\leq 1}); (\delta : B)^{\leq 1}$ . By (CONT) with  $\delta$  and (NAME) with  $\gamma$ , we obtain  $\pi_{\text{LCC}\langle[\alpha]t\rangle} \triangleright_{\mathcal{E}} \Gamma_0 \vdash \text{LCC}\langle[\alpha]t\rangle \mid \Delta_0; \alpha : S \rightarrow A; ((\alpha' : A)^{\leq 1} \cup \gamma : B)$ . Finally, we conclude by (REPL) with  $\pi_s, \pi_{o'} \triangleright_{\mathcal{E}} \Gamma \vdash o' \mid \Delta$ .

\*  $\text{LTC} = \text{LTC}'[x \setminus u]$ . Therefore, by rule (SUBS), we have typing contexts  $\Gamma = \Gamma_0 \cup \Gamma_1$  and  $\Delta' = \Delta_0 \cup \Delta_1$  with a derivation for the premiss  $\pi_{\text{LTC}'\langle[\alpha']t::s\rangle} \triangleright_{\mathcal{E}} \Gamma_0; (x : B')^{\leq 1} \vdash \text{LTC}'\langle[\alpha']t::s\rangle : B \mid \Delta_0; (\alpha' : A \cup (\gamma : B)^{\leq 1})$  as well as for  $\pi_u \triangleright_{\mathcal{E}} \Gamma_1 \vdash u : B' \mid \Delta_1; ((\alpha' : A)^{\leq 1} \cup (\gamma : B)^{\leq 1})$ . Consider  $p = \text{LCC}'\langle[\alpha']t::s\rangle$  where  $\text{LCC}' = [\gamma] \text{LTC}'$ . By (NAME),  $\pi_p \triangleright_{\mathcal{E}} \Gamma_0; (x : B')^{\leq 1} \vdash p \mid \Delta_0; (\alpha' : A \cup (\gamma : B)^{\leq 1})$ . Moreover, since  $p' = \text{LCC}'\langle[\alpha]t\rangle \llbracket \alpha \setminus^{\alpha'} s \rrbracket \rightarrow_{\mathbb{N}} p$ , by the *i.h.* there exists a derivation  $\pi_{p'} \triangleright_{\mathcal{E}} \Gamma_0; (x : B')^{\leq 1} \vdash p' \mid \Delta_0; (\alpha' : A \cup (\gamma : B)^{\leq 1})$ . This derivation necessarily ends in applications of the rules (REPL) and (NAME) with  $\gamma$ . Therefore, we have the contexts  $\Gamma_0 = \Gamma'_0 \cup \Gamma''_0$  and  $\Delta_0 = \Delta'_0 \cup \Delta''_0$  with the premisses  $\pi_{\text{LTC}'\langle[\alpha]t\rangle} \triangleright_{\mathcal{E}} \Gamma'_0; (x : B')^{\leq 1} \vdash \text{LTC}'\langle[\alpha]t\rangle : B \mid \Delta'_0; \alpha : S \rightarrow A; ((\alpha' : A)^{\leq 1} \cup (\gamma : B)^{\leq 1})$  and  $\pi_s \triangleright_{\mathcal{E}} \Gamma''_0 \vdash s : S \mid \Delta''_0; ((\alpha' : A)^{\leq 1} \cup (\gamma : B)^{\leq 1})$ . By applying rule (SUBS) with  $\pi_u$  followed by (NAME) with  $\gamma$ , we obtain the typing derivation  $\pi_{\text{LCC}\langle[\alpha]t\rangle} \triangleright_{\mathcal{E}}$

- $\Gamma'_0 \cup \Gamma_1 \vdash \text{LCC}\langle[\alpha] t \mid \Delta'_0 \cup \Delta_1; \alpha : S \rightarrow A; ((\alpha' : A)^{\leq 1} \cup \gamma : B)\rangle$ . Finally, we conclude by (REPL) with  $\pi_s, \pi_{o'} \triangleright_{\mathcal{E}} \Gamma \vdash o' \mid \Delta$ .
- $\text{LCC} = \text{LCC}'\llbracket \gamma \setminus^\delta s' \rrbracket$ . Therefore, by Lem. 4.4 with  $\alpha' \in o$  and (REPL), we have the contexts  $\Gamma = \Gamma_0 \cup \Gamma_1$  and  $\Delta = \Delta_0 \cup \Delta_1; (\alpha' : A \cup \delta : B)$  with the premiss  $\pi_{\text{LCC}'\langle[\alpha] t :: s \rangle} \triangleright_{\mathcal{E}} \Gamma_0 \vdash \text{LCC}'\langle[\alpha] t :: s \mid \Delta_0; (\gamma : S' \rightarrow B)^{\leq 1}; (\alpha' : A \cup (\delta : B)^{\leq 1})\rangle$  together with  $\pi_{s'} \triangleright_{\mathcal{E}} \Gamma_1 \vdash s' : S' \mid \Delta_1; ((\alpha' : A)^{\leq 1} \cup (\delta : B)^{\leq 1})$ . By the *i.h.* there exists  $\pi_{\text{LCC}'\langle[\alpha] t \llbracket \alpha \setminus^{\alpha'} s \rrbracket \rangle} \triangleright_{\mathcal{E}} \Gamma_0 \vdash \text{LCC}'\langle[\alpha] t \llbracket \alpha \setminus^{\alpha'} s \rrbracket \mid \Delta_0; (\gamma : S' \rightarrow B)^{\leq 1}; (\alpha' : A \cup (\delta : B)^{\leq 1})\rangle$ . This derivation necessarily ends in an application of the rule (REPL). Therefore, we obtain the contexts  $\Gamma_0 = \Gamma'_0 \cup \Gamma''_0$  and  $\Delta_0 = \Delta'_0 \cup \Delta''_0$  with typing derivations  $\pi_{\text{LCC}'\langle[\alpha] t \rangle} \triangleright_{\mathcal{E}} \Gamma'_0 \vdash \text{LCC}'\langle[\alpha] t \mid \Delta'_0; (\alpha : S \rightarrow A)^{\leq 1}; (\gamma : S' \rightarrow B)^{\leq 1}; ((\alpha' : A)^{\leq 1} \cup (\delta : B)^{\leq 1})\rangle$  and  $\pi_s \triangleright_{\mathcal{E}} \Gamma''_0 \vdash s : S \mid \Delta''_0; (\gamma : S' \rightarrow B)^{\leq 1}; ((\alpha' : A)^{\leq 1} \cup (\delta : B)^{\leq 1})$ . Therefore, applying the rule (REPL) with the premisses  $\pi_{\text{LCC}'\langle[\alpha] t \rangle}$  and  $\pi_{s'}$ , we obtain the derivation  $\pi_{\text{LCC}\langle[\alpha] t \rangle} \triangleright_{\mathcal{E}} \Gamma'_0 \cup \Gamma_1 \vdash \text{LCC}\langle[\alpha] t \mid \Delta'_0 \cup \Delta_1; (\alpha : S \rightarrow A)^{\leq 1}; ((\alpha' : A)^{\leq 1} \cup \delta : B)\rangle$ . Finally, we conclude by (REPL) with  $\pi_s, \pi_{o'} \triangleright_{\mathcal{E}} \Gamma \vdash o' \mid \Delta$ . Note that, without loss of generality, we may assume  $\gamma \notin s$  and, by Lem. 4.4, we then have  $(\gamma : S' \rightarrow B)^{\leq 1}$  empty in  $\pi_s$ .
  - $\text{LCC} = \text{LCC}'\llbracket \gamma \setminus \delta \rrbracket$ . Therefore, by Lem. 4.4 with  $\alpha' \in o$  and (REN), we have the typing context  $\Delta = \Delta'; (\alpha' : A \cup \delta : B)$  with the derivation  $\pi_{\text{LCC}'\langle[\alpha] t :: s \rangle} \triangleright_{\mathcal{E}} \Gamma \vdash \text{LCC}' : [\alpha] t :: s \mid \Delta'; (\alpha' : A \cup (\delta : B)^{\leq 1}); (\gamma : B)^{\leq 1}$ . By *i.h.*  $\pi_{\text{LCC}'\langle[\alpha] t \llbracket \alpha \setminus^{\alpha'} s \rrbracket \rangle} \triangleright_{\mathcal{E}} \Gamma \vdash \text{LCC}'\langle[\alpha] t \llbracket \alpha \setminus^{\alpha'} s \rrbracket \mid \Delta; (\alpha' : A \cup (\delta : B)^{\leq 1}); (\gamma : B)^{\leq 1}\rangle$ . This derivation necessarily ends in the rule (REPL). Therefore, we have  $\Gamma = \Gamma_0 \cup \Gamma_1$  and  $\Delta' = \Delta_0 \cup \Delta_1$  with  $\pi_{\text{LCC}'\langle[\alpha] t \rangle} \triangleright_{\mathcal{E}} \Gamma_0 \vdash \text{LCC}'\langle[\alpha] t \mid \Delta_0; (\alpha : S \rightarrow A)^{\leq 1}; ((\alpha' : A)^{\leq 1} \cup (\delta : B)^{\leq 1}); (\gamma : B)^{\leq 1}\rangle$  and another premiss  $\pi_s \triangleright_{\mathcal{E}} \Gamma_1 \vdash s : S \mid \Delta_1; ((\alpha' : A)^{\leq 1} \cup (\delta : B)^{\leq 1}); (\gamma : B)^{\leq 1}$ . Therefore, applying the rule (REN) on  $\pi_{\text{LCC}'\langle[\alpha] t \rangle}$  with  $\gamma$  and  $\delta$ , we obtain the derivation  $\pi_{\text{LCC}\langle[\alpha] t \rangle} \triangleright_{\mathcal{E}} \Gamma_0 \vdash \text{LCC}\langle[\alpha] t \mid \Delta_0; (\alpha : S \rightarrow A)^{\leq 1}; ((\alpha' : A)^{\leq 1} \cup \delta : B)\rangle$ . Finally, we conclude applying (REPL) with  $\pi_s, \pi_{o'} \triangleright_{\mathcal{E}} \Gamma \vdash o' \mid \Delta$ . Note that, without loss of generality, we may assume  $\gamma \notin s$  and, by Lem. 4.4, we have  $(\gamma : S'' \rightarrow B)^{\leq 1}$  empty in  $\pi_s$ .
- (2) C. Therefore,  $o = \text{LCC}\langle c \llbracket \beta \setminus^{\alpha'} s' \cdot s \rrbracket \rangle$  and  $o' = \text{LCC}\langle c \llbracket \beta \setminus^{\alpha} s' \rrbracket \llbracket \alpha \setminus^{\alpha'} s \rrbracket \rangle$ . We proceed by induction on LCC.
- $\text{LCC} = \square$ . Therefore, by rule (REPL) we have the typing contexts  $\Gamma = \Gamma_0 \cup \Gamma_1$  and  $\Delta = \Delta_0 \cup \Delta_1; \alpha' : A$  with proper derivations for the premisses  $\pi_c \triangleright_{\mathcal{E}} \Gamma_0 \vdash c \mid \Delta_0; (\beta : S'' \rightarrow A)^{\leq 1}; (\alpha' : A)^{\leq 1}$  and  $\pi_{s' \cdot s} \triangleright_{\mathcal{E}} \Gamma_1 \vdash s' \cdot s : S'' \mid \Delta_1; (\alpha' : A)^{\leq 1}$ . By Lem. B.1 (2), we have  $S'' = S' \cdot S$ ,  $\Gamma_1 = \Gamma'_1 \cup \Gamma''_1$  and  $\Delta_1 = \Delta'_1 \cup \Delta''_1$  with derivations  $\pi_{s'} \triangleright_{\mathcal{E}} \Gamma'_1 \vdash s' : S' \mid \Delta'_1; (\alpha' : A)^{\leq 1}$  and  $\pi_s \triangleright_{\mathcal{E}} \Gamma''_1 \vdash s : S \mid \Delta''_1; (\alpha' : A)^{\leq 1}$ . Note that  $S'' \rightarrow A = S' \rightarrow S \rightarrow A$ . Moreover, by hypothesis of the rule C,  $\alpha \notin c$ . Therefore, we may add the empty hypothesis  $(\alpha : S \rightarrow A)^{\leq 1}$  to the context of names in  $\pi_c$ . By (REPL) with  $\pi_{s'}, \pi_{c \llbracket \beta \setminus^{\alpha} s' \rrbracket} \triangleright_{\mathcal{E}} \Gamma_0 \cup \Gamma'_1 \vdash c \llbracket \beta \setminus^{\alpha} s' \rrbracket \mid \Delta_0 \cup \Delta'_1; \alpha : S \rightarrow A; (\alpha' : A)^{\leq 1}$ . Finally, we conclude by (REPL) with  $\pi_s, \pi_{o'} \triangleright_{\mathcal{E}} \Gamma \vdash o' \mid \Delta$ .
  - $\text{LCC} = \llbracket \gamma \rrbracket \text{LTC}$ . Therefore, by Lem. 4.4 with  $\alpha' \in o$  and rule (NAME), we have the typing context  $\Delta = \Delta'; (\alpha' : A \cup \gamma : B)$  and the derivation  $\pi_{\text{LTC}\langle c \llbracket \beta \setminus^{\alpha'} s' \cdot s \rrbracket \rangle} \triangleright_{\mathcal{E}} \Gamma \vdash \text{LTC}\langle c \llbracket \beta \setminus^{\alpha'} s' \cdot s \rrbracket : B \mid \Delta'; (\alpha' : A \cup (\gamma : B)^{\leq 1})\rangle$ . We proceed by analysing the form of LTC.
    - \*  $\text{LTC} = \text{LTC}' u$ . Therefore, by (APP), we have contexts  $\Gamma = \Gamma_0 \cup \Gamma_1$  and  $\Delta' = \Delta_0 \cup \Delta_1$  with  $\pi_{\text{LTC}'\langle c \llbracket \beta \setminus^{\alpha'} s' \cdot s \rrbracket \rangle} \triangleright_{\mathcal{E}} \Gamma_0 \vdash \text{LTC}'\langle c \llbracket \beta \setminus^{\alpha'} s' \cdot s \rrbracket : B' \rightarrow B \mid \Delta_0; (\alpha' : A \cup (\gamma : B)^{\leq 1})\rangle$

and  $\pi_u \triangleright_{\mathcal{E}} \Gamma_1 \vdash u : B' \mid \Delta_1; (\alpha' : A \cup (\gamma : B)^{\leq 1})$ . Consider  $p = \text{LCC}'\langle c[\beta \setminus^{\alpha'} s' \cdot s] \rangle$  where  $\text{LCC}' = [\delta] \text{LTC}'$  with  $\delta$  a fresh name. Then, by (NAME), we have the derivation  $\pi_p \triangleright_{\mathcal{E}} \Gamma_0 \vdash p \mid \Delta_0; (\alpha' : A \cup (\gamma : B)^{\leq 1}); \delta : B' \rightarrow B$ . Moreover, we have  $p' = \text{LCC}'\langle c[\beta \setminus^{\alpha} s'] \rangle [\alpha \setminus^{\alpha'} s] \rightarrow_{\mathcal{C}} p$ . Therefore, by the *i.h.* there exists a derivation  $\pi_{p'} \triangleright_{\mathcal{E}} \Gamma_0 \vdash p' \mid \Delta_0; (\alpha' : A \cup (\gamma : B)^{\leq 1}); \delta : B' \rightarrow B$ . From rules (REPL) and (NAME), given that  $\delta$  is fresh, we obtain the typing contexts  $\Gamma_0 = \Gamma'_0 \cup \Gamma''_0$  and  $\Delta_0 = \Delta'_0 \cup \Delta''_0$  with proper type derivations for the premisses  $\pi_{\text{LTC}'\langle c[\beta \setminus^{\alpha} s'] \rangle} \triangleright_{\mathcal{E}} \Gamma'_0 \vdash \text{LTC}'\langle c[\beta \setminus^{\alpha} s'] \rangle : B' \rightarrow B \mid \Delta'_0; \alpha : S \rightarrow A; ((\alpha' : A)^{\leq 1} \cup (\gamma : B)^{\leq 1})$  and  $\pi_s \triangleright_{\mathcal{E}} \Gamma''_0 \vdash s : S \mid \Delta''_0; ((\alpha' : A)^{\leq 1} \cup (\gamma : B)^{\leq 1})$ . Therefore, applying the rule (APP) with  $\pi_u$  followed by the rule (NAME) with  $\gamma$ , we obtain the derivation  $\pi_{\text{LCC}'\langle c[\beta \setminus^{\alpha} s'] \rangle} \triangleright_{\mathcal{E}} \Gamma'_0 \cup \Gamma_1 \vdash \text{LCC}'\langle c[\beta \setminus^{\alpha} s'] \rangle \mid \Delta'_0 \cup \Delta_1; \alpha : S \rightarrow A; ((\alpha' : A)^{\leq 1} \cup \gamma : B)$ . Finally, we conclude by (REPL) with  $\pi_s, \pi_{o'} \triangleright_{\mathcal{E}} \Gamma \vdash o' \mid \Delta$ .

\*  $\text{LTC} = \lambda x. \text{LTC}'$ . Therefore, by (ABS), we have  $B = B' \rightarrow B''$  with  $\pi_{\text{LTC}'\langle c[\beta \setminus^{\alpha'} s' \cdot s] \rangle} \triangleright_{\mathcal{E}} \Gamma; (x : B')^{\leq 1} \vdash \text{LTC}'\langle c[\beta \setminus^{\alpha'} s' \cdot s] \rangle : B'' \mid \Delta'; (\alpha' : A \cup (\gamma : B)^{\leq 1})$ . Consider the object  $p = \text{LCC}'\langle c[\beta \setminus^{\alpha'} s' \cdot s] \rangle$  where  $\text{LCC}' = [\delta] \text{LTC}'$  with  $\delta$  a fresh name. Then, by (NAME), we have  $\pi_p \triangleright_{\mathcal{E}} \Gamma; (x : B')^{\leq 1} \vdash p \mid \Delta'; (\alpha' : A \cup (\gamma : B)^{\leq 1}); \delta : B''$ . Moreover, since  $p' = \text{LCC}'\langle c[\beta \setminus^{\alpha} s'] \rangle [\alpha \setminus^{\alpha'} s] \rightarrow_{\mathcal{C}} p$ , by the *i.h.* there exists a derivation  $\pi_{p'} \triangleright_{\mathcal{E}} \Gamma; (x : B')^{\leq 1} \vdash p' \mid \Delta'; (\alpha' : A \cup (\gamma : B)^{\leq 1}); \delta : B''$ . From rules (REPL) and (NAME), given that  $\delta$  is fresh, we obtain the typing contexts  $\Gamma = \Gamma_0 \cup \Gamma_1$  and  $\Delta' = \Delta_0 \cup \Delta_1$  with proper type derivations for the premisses  $\pi_{\text{LTC}'\langle c[\beta \setminus^{\alpha} s'] \rangle} \triangleright_{\mathcal{E}} \Gamma_0; (x : B')^{\leq 1} \vdash \text{LTC}'\langle c[\beta \setminus^{\alpha} s'] \rangle : B'' \mid \Delta_0; \alpha : S \rightarrow A; ((\alpha' : A)^{\leq 1} \cup (\gamma : B)^{\leq 1})$  and  $\pi_s \triangleright_{\mathcal{E}} \Gamma_1 \vdash s : S \mid \Delta_1; ((\alpha' : A)^{\leq 1} \cup (\gamma : B)^{\leq 1})$ . Therefore, applying rule (ABS) followed by an application of (NAME) with  $\gamma$ , we obtain the derivation  $\pi_{\text{LCC}'\langle c[\beta \setminus^{\alpha} s'] \rangle} \triangleright_{\mathcal{E}} \Gamma_0 \vdash \text{LCC}'\langle c[\beta \setminus^{\alpha} s'] \rangle \mid \Delta_0; \alpha : S \rightarrow A; ((\alpha' : A)^{\leq 1} \cup \gamma : B)$ . Finally, we conclude by (REPL) with  $\pi_s, \pi_{o'} \triangleright_{\mathcal{E}} \Gamma \vdash o' \mid \Delta$ .

\*  $\text{LTC} = \mu \delta. \text{LCC}'$ . Therefore, from  $\pi_{\text{LTC}'\langle c[\beta \setminus^{\alpha'} s' \cdot s] \rangle}$  by (CONT), we have a derivation for  $\pi_{\text{LCC}'\langle c[\beta \setminus^{\alpha'} s' \cdot s] \rangle} \triangleright_{\mathcal{E}} \Gamma \vdash \text{LCC}'\langle c[\beta \setminus^{\alpha'} s' \cdot s] \rangle \mid \Delta'; (\alpha' : A \cup (\gamma : B)^{\leq 1}); (\delta : B)^{\leq 1}$ . By the *i.h.* on  $\text{LCC}'$ , we can guarantee the existence of a derivation  $\pi_{\text{LCC}'\langle c[\beta \setminus^{\alpha} s'] \rangle} [\alpha \setminus^{\alpha'} s] \triangleright_{\mathcal{E}} \Gamma \vdash \text{LCC}'\langle c[\beta \setminus^{\alpha} s'] \rangle [\alpha \setminus^{\alpha'} s] \mid \Delta'; (\alpha' : A \cup (\gamma : B)^{\leq 1}); (\delta : B)^{\leq 1}$ . This derivation necessarily ends with an application of the rule (REPL). Therefore, we obtain the contexts  $\Gamma = \Gamma_0 \cup \Gamma_1$  and  $\Delta' = \Delta_0 \cup \Delta_1$  with the derivation  $\pi_{\text{LCC}'\langle c[\beta \setminus^{\alpha} s'] \rangle} \triangleright_{\mathcal{E}} \Gamma_0 \vdash \text{LCC}'\langle c[\beta \setminus^{\alpha} s'] \rangle \mid \Delta_0; \alpha : S \rightarrow A; ((\alpha' : A)^{\leq 1} \cup (\gamma : B)^{\leq 1}); (\delta : B)^{\leq 1}$  together with the derivation  $\pi_s \triangleright_{\mathcal{E}} \Gamma_1 \vdash s : S \mid \Delta_1; ((\alpha' : A)^{\leq 1} \cup (\gamma : B)^{\leq 1}); (\delta : B)^{\leq 1}$ . Therefore, applying (CONT) with  $\delta$  followed by (NAME) with  $\gamma$ , we obtain the derivation  $\pi_{\text{LCC}'\langle c[\beta \setminus^{\alpha} s'] \rangle} \triangleright_{\mathcal{E}} \Gamma_0 \vdash \text{LCC}'\langle c[\beta \setminus^{\alpha} s'] \rangle \mid \Delta_0; \alpha : S \rightarrow A; ((\alpha' : A)^{\leq 1} \cup \gamma : B)$ . Finally, we conclude by (REPL) with  $\pi_s, \pi_{o'} \triangleright_{\mathcal{E}} \Gamma \vdash o' \mid \Delta$ .

\*  $\text{LTC} = \text{LTC}'[x \setminus u]$ . Therefore, by rule (SUBS), we have the typing contexts  $\Gamma = \Gamma_0 \cup \Gamma_1$  and  $\Delta' = \Delta_0 \cup \Delta_1$  with proper a derivation for the premiss  $\pi_{\text{LTC}'\langle c[\beta \setminus^{\alpha'} s' \cdot s] \rangle} \triangleright_{\mathcal{E}} \Gamma_0; (x : B')^{\leq 1} \vdash \text{LTC}'\langle c[\beta \setminus^{\alpha'} s' \cdot s] \rangle : B \mid \Delta_0; (\alpha' : A \cup (\gamma : B)^{\leq 1})$  as well as  $\pi_u \triangleright_{\mathcal{E}} \Gamma_1 \vdash u : B' \mid \Delta_1; ((\alpha' : A)^{\leq 1} \cup (\gamma : B)^{\leq 1})$ . Consider  $p = \text{LCC}'\langle c[\beta \setminus^{\alpha'} s' \cdot s] \rangle$  where  $\text{LCC}' = [\gamma] \text{LTC}'$ . By (NAME),  $\pi_p \triangleright_{\mathcal{E}} \Gamma_0; (x : B')^{\leq 1} \vdash p \mid \Delta_0; (\alpha' : A \cup (\gamma : B)^{\leq 1})$ . Moreover, we have  $p' = \text{LCC}'\langle c[\beta \setminus^{\alpha} s'] \rangle [\alpha \setminus^{\alpha'} s] \rightarrow_{\mathcal{C}} p$ . Therefore, by applying the *i.h.* we can guarantee the existence of a derivation for the redex  $\pi_{p'} \triangleright_{\mathcal{E}} \Gamma_0; (x : B')^{\leq 1} \vdash p' \mid \Delta_0; (\alpha' : A \cup (\gamma : B)^{\leq 1})$ . From rules (REPL) and (NAME), we



- have contexts  $\Gamma_0 = \Gamma'_0 \cup \Gamma''_0$  and  $\Delta_0 = \Delta'_0 \cup \Delta''_0$  with derivations  $\pi_{\text{LTC}'\langle c[\beta \setminus^\alpha s'] \rangle} \triangleright_{\mathcal{E}} \Gamma'_0; (x : B')^{\leq 1} \vdash \text{LTC}'\langle c[\beta \setminus^\alpha s'] \rangle : B \mid \Delta'_0; \alpha : S \rightarrow A; ((\alpha' : A)^{\leq 1} \cup (\gamma : B)^{\leq 1})$  and  $\pi_s \triangleright_{\mathcal{E}} \Gamma''_0 \vdash s : S \mid \Delta''_0; ((\alpha' : A)^{\leq 1} \cup (\gamma : B)^{\leq 1})$ . Then, applying the rule (SUBS) with  $\pi_u$  followed by the rule (NAME) with  $\gamma$ , we obtain the derivation  $\pi_{\text{LCC}'\langle c[\beta \setminus^\alpha s'] \rangle} \triangleright_{\mathcal{E}} \Gamma'_0 \cup \Gamma_1 \vdash \text{LCC}'\langle c[\beta \setminus^\alpha s'] \rangle \mid \Delta'_0 \cup \Delta_1; \alpha : S \rightarrow A; ((\alpha' : A)^{\leq 1} \cup \gamma : B)$ . Finally, we conclude by (REPL) with  $\pi_s, \pi_{o'} \triangleright_{\mathcal{E}} \Gamma \vdash o' \mid \Delta$ .
- $\text{LCC} = \text{LCC}'[\gamma \setminus^\delta s'']$ . Therefore, by Lem. 4.4 with  $\alpha' \in o$  and rule (REPL), we have typing contexts  $\Gamma = \Gamma_0 \cup \Gamma_1$  and  $\Delta = \Delta_0 \cup \Delta_1; (\alpha' : A \cup \delta : B)$  with derivations  $\pi_{\text{LCC}'\langle c[\beta \setminus^{\alpha'} s' \cdot s] \rangle} \triangleright_{\mathcal{E}} \Gamma_0 \vdash \text{LCC}'\langle c[\beta \setminus^{\alpha'} s' \cdot s] \rangle \mid \Delta_0; (\gamma : S'' \rightarrow B)^{\leq 1}; (\alpha' : A \cup (\delta : B)^{\leq 1})$  and  $\pi_{s''} \triangleright_{\mathcal{E}} \Gamma_1 \vdash s'' : S'' \mid \Delta_1; ((\alpha' : A)^{\leq 1} \cup (\delta : B)^{\leq 1})$ . Moreover, by applying the *i.h.* we can guarantee the existence of a type derivation  $\pi_{\text{LCC}'\langle c[\beta \setminus^{\alpha'} s] \rangle} \triangleright_{\mathcal{E}} \Gamma_0 \vdash \text{LCC}'\langle c[\beta \setminus^{\alpha'} s] \rangle \mid \Delta_0; (\gamma : S'' \rightarrow B)^{\leq 1}; (\alpha' : A \cup (\delta : B)^{\leq 1})$ . By (REPL) we have contexts  $\Gamma_0 = \Gamma'_0 \cup \Gamma''_0$  and  $\Delta_0 = \Delta'_0 \cup \Delta''_0$  with the premiss  $\pi_{\text{LCC}'\langle c[\beta \setminus^{\alpha'} s] \rangle} \triangleright_{\mathcal{E}} \Gamma'_0 \vdash \text{LCC}'\langle c[\beta \setminus^{\alpha'} s] \rangle \mid \Delta'_0; (\alpha : S \rightarrow A)^{\leq 1}; (\gamma : S'' \rightarrow B)^{\leq 1}; ((\alpha' : A)^{\leq 1} \cup (\delta : B)^{\leq 1})$  and the premiss  $\pi_s \triangleright_{\mathcal{E}} \Gamma''_0 \vdash s : S \mid \Delta''_0; (\gamma : S'' \rightarrow B)^{\leq 1}; ((\alpha' : A)^{\leq 1} \cup (\delta : B)^{\leq 1})$ . By applying the rule (REPL) with  $\pi_{\text{LCC}'\langle c[\beta \setminus^{\alpha'} s] \rangle}$  and  $\pi_{s''}$  we may construct  $\pi_{\text{LCC}'\langle c[\beta \setminus^{\alpha'} s] \rangle} \triangleright_{\mathcal{E}} \Gamma'_0 \cup \Gamma_1 \vdash \text{LCC}'\langle c[\beta \setminus^{\alpha'} s] \rangle \mid \Delta'_0 \cup \Delta_1; (\alpha : S \rightarrow A)^{\leq 1}; ((\alpha' : A)^{\leq 1} \cup \delta : B)$ . Finally, we conclude by (REPL) with  $\pi_s, \pi_{o'} \triangleright_{\mathcal{E}} \Gamma \vdash o' \mid \Delta$ . Note that, without loss of generality, we may assume  $\gamma \notin s$  and, by Lem. 4.4, we have  $(\gamma : S'' \rightarrow B)^{\leq 1}$  empty in  $\pi_s$ .
  - $\text{LCC} = \text{LCC}'[\gamma \setminus \delta]$ . Therefore, by Lem. 4.4 with  $\alpha' \in o$  and rule (REN), we have the typing context  $\Delta = \Delta'; (\alpha' : A \cup \delta : B)$  with the derivation  $\pi_{\text{LCC}'\langle c[\beta \setminus^{\alpha'} s' \cdot s] \rangle} \triangleright_{\mathcal{E}} \Gamma \vdash \text{LCC}'\langle c[\beta \setminus^{\alpha'} s' \cdot s] \rangle \mid \Delta'; (\alpha' : A \cup (\delta : B)^{\leq 1}); (\gamma : B)^{\leq 1}$ . Therefore, by applying the *i.h.* on  $\text{LCC}'$ , we can guarantee the existence of a derivation  $\pi_{\text{LCC}'\langle c[\beta \setminus^{\alpha'} s] \rangle} \triangleright_{\mathcal{E}} \Gamma \vdash \text{LCC}'\langle c[\beta \setminus^{\alpha'} s] \rangle \mid \Delta; (\alpha' : A \cup (\delta : B)^{\leq 1}); (\gamma : B)^{\leq 1}$ . By rule (REPL) we have contexts  $\Gamma = \Gamma_0 \cup \Gamma_1$  and  $\Delta' = \Delta_0 \cup \Delta_1$  with the premiss  $\pi_{\text{LCC}'\langle c[\beta \setminus^{\alpha'} s] \rangle} \triangleright_{\mathcal{E}} \Gamma_0 \vdash \text{LCC}'\langle c[\beta \setminus^{\alpha'} s] \rangle \mid \Delta_0; (\alpha : S \rightarrow A)^{\leq 1}; ((\alpha' : A)^{\leq 1} \cup (\delta : B)^{\leq 1}); (\gamma : B)^{\leq 1}$  and the premiss  $\pi_s \triangleright_{\mathcal{E}} \Gamma_1 \vdash s : S \mid \Delta_1; ((\alpha' : A)^{\leq 1} \cup (\delta : B)^{\leq 1}); (\gamma : B)^{\leq 1}$ . Therefore, applying the rule (REN) on  $\pi_{\text{LCC}'\langle c[\beta \setminus^{\alpha'} s] \rangle}$  with names  $\gamma$  and  $\delta$ , we obtain the derivation  $\pi_{\text{LCC}'\langle c[\beta \setminus^{\alpha'} s] \rangle} \triangleright_{\mathcal{E}} \Gamma_0 \vdash \text{LCC}'\langle c[\beta \setminus^{\alpha'} s] \rangle \mid \Delta_0; (\alpha : S \rightarrow A)^{\leq 1}; ((\alpha' : A)^{\leq 1} \cup \delta : B)$ . We conclude by (REPL) with  $\pi_s, \pi_{o'} \triangleright_{\mathcal{E}} \Gamma \vdash o' \mid \Delta$ . Note that, without loss of generality, we may assume  $\gamma \notin s$  and, by Lem. 4.4, we have  $(\gamma : S'' \rightarrow B)^{\leq 1}$  empty in  $\pi_s$ .
- (3) **W**. Therefore,  $o = \text{LCC}'\langle c[\beta \setminus^\alpha s][\alpha \setminus \alpha'] \rangle$  and  $o' = \text{LCC}'\langle c[\beta \setminus \alpha][\alpha \setminus \alpha'] \rangle$ . We proceed by induction on  $\text{LCC}$ .
- $\text{LCC} = \square$ . Therefore, by rules (REN) and (REPL), we have typing contexts  $\Gamma = \Gamma_0 \cup \Gamma_1$  and  $\Delta = \Delta_0 \cup \Delta_1; \alpha' : A$  with proper derivations for the premisses  $\pi_c \triangleright_{\mathcal{E}} \Gamma_0 \vdash c \mid \Delta_0; (\alpha : A)^{\leq 1}; (\alpha' : A)^{\leq 1}; (\beta : S \rightarrow A)^{\leq 1}$  and  $\pi_s \triangleright_{\mathcal{E}} \Gamma_1 \vdash s : S \mid \Delta_1; (\alpha' : A)^{\leq 1}$ . Note that, by hypothesis of the rule **W**,  $\alpha \notin c$ . Therefore, by Lem. 4.4,  $(\alpha : A)^{\leq 1}$  is empty in  $\pi_c$ . Moreover, we may add the empty hypothesis  $(\alpha : S \rightarrow A)^{\leq 1}$  to  $\pi_c$  and, by (REN), we obtain the derivation  $\pi_{c[\beta \setminus \alpha]} \triangleright_{\mathcal{E}} \Gamma_0 \vdash c[\beta \setminus \alpha] \mid \Delta_0; \alpha : S \rightarrow A; (\alpha' : A)^{\leq 1}$ . Finally, we conclude by (REPL) with  $\pi_s, \pi_{o'} \triangleright_{\mathcal{E}} \Gamma \vdash o' \mid \Delta$ .
  - $\text{LCC} = [\gamma] \text{LTC}$ . Therefore, by Lem. 4.4 with  $\alpha' \in o$  and rule (NAME), we have the typing context  $\Delta = \Delta'; (\alpha' : A \cup \gamma : B)$  with the derivation  $\pi_{\text{LTC}'\langle c[\beta \setminus^\alpha s][\alpha \setminus \alpha'] \rangle} \triangleright_{\mathcal{E}} \Gamma \vdash \text{LTC}'\langle c[\beta \setminus^\alpha s][\alpha \setminus \alpha'] \rangle : B \mid \Delta'; (\alpha' : A \cup (\gamma : B)^{\leq 1})$ . We proceed by analysing the form of  $\text{LTC}$ .

- \*  $\text{LTC} = \text{LTC}' u$ . Therefore, by rule (APP), we have the typing contexts  $\Gamma = \Gamma_0 \cup \Gamma_1$  and  $\Delta' = \Delta_0 \cup \Delta_1$  with the proper derivations for the premisses  $\pi_{\text{LTC}'\langle c[\beta^\alpha s][\alpha \setminus \alpha'] \rangle} \triangleright_{\mathcal{E}} \Gamma_0 \vdash \text{LTC}'\langle c[\beta \setminus^\alpha s][\alpha \setminus \alpha'] \rangle : B' \rightarrow B \mid \Delta_0; (\alpha' : A \cup (\gamma : B)^{\leq 1})$  and  $\pi_u \triangleright_{\mathcal{E}} \Gamma_1 \vdash u : B' \mid \Delta_1; (\alpha' : A \cup (\gamma : B)^{\leq 1})$ . Consider the command  $p = \text{LCC}'\langle c[\beta \setminus^\alpha s][\alpha \setminus \alpha'] \rangle$  where  $\text{LCC}' = [\delta] \text{LTC}'$  with  $\delta$  a fresh name. Then, by (NAME), we have the derivation  $\pi_p \triangleright_{\mathcal{E}} \Gamma_0 \vdash p \mid \Delta_0; (\alpha' : A \cup (\gamma : B)^{\leq 1}); \delta : B' \rightarrow B$ . Moreover, we have  $p' = \text{LCC}'\langle c[\beta \setminus \alpha] \rangle [\alpha \setminus \alpha'] \rightarrow_w p$ . Therefore, by the *i.h.* we can guarantee the existence of  $\pi_{p'} \triangleright_{\mathcal{E}} \Gamma_0 \vdash p' \mid \Delta_0; (\alpha' : A \cup (\gamma : B)^{\leq 1}); \delta : B' \rightarrow B$ . From (REPL) and (NAME), given that  $\delta$  is fresh, we have typing contexts  $\Gamma_0 = \Gamma'_0 \cup \Gamma''_0$  and  $\Delta_0 = \Delta'_0 \cup \Delta''_0$  with derivations for the premisses  $\pi_{\text{LTC}'\langle c[\beta \setminus \alpha] \rangle} \triangleright_{\mathcal{E}} \Gamma'_0 \vdash \text{LTC}'\langle c[\beta \setminus \alpha] \rangle : B' \rightarrow B \mid \Delta'_0; \alpha : S \rightarrow A; ((\alpha' : A)^{\leq 1} \cup (\gamma : B)^{\leq 1})$  and  $\pi_s \triangleright_{\mathcal{E}} \Gamma''_0 \vdash s : S \mid \Delta''_0; ((\alpha' : A)^{\leq 1} \cup (\gamma : B)^{\leq 1})$ . Therefore, applying the rule (APP) with  $\pi_u$  followed by an application of (NAME) with  $\gamma$ , we obtain the derivation  $\pi_{\text{LCC}\langle c[\beta \setminus \alpha] \rangle} \triangleright_{\mathcal{E}} \Gamma'_0 \cup \Gamma''_0 \vdash \text{LCC}\langle c[\beta \setminus \alpha] \rangle \mid \Delta'_0 \cup \Delta''_0; \alpha : S \rightarrow A; ((\alpha' : A)^{\leq 1} \cup \gamma : B)$ . We conclude by (REPL) with  $\pi_s, \pi_{o'} \triangleright_{\mathcal{E}} \Gamma \vdash o' \mid \Delta$ .
- \*  $\text{LTC} = \lambda x. \text{LTC}'$ . By (ABS), we have  $B = B' \rightarrow B''$  with  $\pi_{\text{LTC}'\langle c[\beta^\alpha s][\alpha \setminus \alpha'] \rangle} \triangleright_{\mathcal{E}} \Gamma; (x : B')^{\leq 1} \vdash \text{LTC}'\langle c[\beta \setminus^\alpha s][\alpha \setminus \alpha'] \rangle : B'' \mid \Delta'; (\alpha' : A \cup (\gamma : B)^{\leq 1})$ . Consider  $p = \text{LCC}'\langle c[\beta \setminus^\alpha s][\alpha \setminus \alpha'] \rangle$  where  $\text{LCC}' = [\delta] \text{LTC}'$  with  $\delta$  a fresh name. Then, by (NAME), we have the derivation  $\pi_p \triangleright_{\mathcal{E}} \Gamma; (x : B')^{\leq 1} \vdash p \mid \Delta'; (\alpha' : A \cup (\gamma : B)^{\leq 1}); \delta : B''$ . Moreover, we have  $p' = \text{LCC}'\langle c[\beta \setminus \alpha] \rangle [\alpha \setminus \alpha'] \rightarrow_w p$ . Therefore, by the *i.h.* there exists a derivation  $\pi_{p'} \triangleright_{\mathcal{E}} \Gamma; (x : B')^{\leq 1} \vdash p' \mid \Delta'; (\alpha' : A \cup (\gamma : B)^{\leq 1}); \delta : B''$ . From rules (REPL) and (NAME), given that  $\delta$  is fresh, we have the typing contexts  $\Gamma = \Gamma_0 \cup \Gamma_1$  and  $\Delta' = \Delta_0 \cup \Delta_1$  with derivations for the premisses  $\pi_{\text{LTC}'\langle c[\beta \setminus \alpha] \rangle} \triangleright_{\mathcal{E}} \Gamma_0; (x : B')^{\leq 1} \vdash \text{LTC}'\langle c[\beta \setminus \alpha] \rangle : B'' \mid \Delta_0; \alpha : S \rightarrow A; ((\alpha' : A)^{\leq 1} \cup (\gamma : B)^{\leq 1})$  and  $\pi_s \triangleright_{\mathcal{E}} \Gamma_1 \vdash s : S \mid \Delta_1; ((\alpha' : A)^{\leq 1} \cup (\gamma : B)^{\leq 1})$ . Therefore, applying the rule (ABS) followed by an application of (NAME) with el nombre  $\gamma$ , we obtain the derivation  $\pi_{\text{LCC}\langle c[\beta \setminus \alpha] \rangle} \triangleright_{\mathcal{E}} \Gamma_0 \vdash \text{LCC}\langle c[\beta \setminus \alpha] \rangle \mid \Delta_0; \alpha : S \rightarrow A; ((\alpha' : A)^{\leq 1} \cup \gamma : B)$ . Finally, we conclude by (REPL) with  $\pi_s, \pi_{o'} \triangleright_{\mathcal{E}} \Gamma \vdash o' \mid \Delta$ .
- \*  $\text{LTC} = \mu \delta. \text{LCC}'$ . Therefore, by (CONT), we have the derivation  $\pi_{\text{LCC}'\langle c[\beta^\alpha s][\alpha \setminus \alpha'] \rangle} \triangleright_{\mathcal{E}} \Gamma \vdash \text{LCC}'\langle c[\beta \setminus^\alpha s][\alpha \setminus \alpha'] \rangle \mid \Delta'; (\alpha' : A \cup (\gamma : B)^{\leq 1}); (\delta : B)^{\leq 1}$ . Moreover, by the *i.h.* on  $\text{LCC}'$  there exists a derivation for the expansion  $\pi_{\text{LCC}'\langle c[\beta \setminus \alpha] \rangle} [\alpha \setminus \alpha'] \triangleright_{\mathcal{E}} \Gamma \vdash \text{LCC}'\langle c[\beta \setminus \alpha] \rangle [\alpha \setminus \alpha'] \mid \Delta'; (\alpha' : A \cup (\gamma : B)^{\leq 1}); (\delta : B)^{\leq 1}$ . This derivation necessarily ends with an application of the rule (REPL). Therefore, we have contexts  $\Gamma = \Gamma_0 \cup \Gamma_1$  and  $\Delta' = \Delta_0 \cup \Delta_1$  with derivations for the premiss  $\pi_{\text{LCC}'\langle c[\beta \setminus \alpha] \rangle} \triangleright_{\mathcal{E}} \Gamma_0 \vdash \text{LCC}'\langle c[\beta \setminus \alpha] \rangle \mid \Delta_0; \alpha : S \rightarrow A; ((\alpha' : A)^{\leq 1} \cup (\gamma : B)^{\leq 1}); (\delta : B)^{\leq 1}$  and the premiss  $\pi_s \triangleright_{\mathcal{E}} \Gamma_1 \vdash s : S \mid \Delta_1; ((\alpha' : A)^{\leq 1} \cup (\gamma : B)^{\leq 1}); (\delta : B)^{\leq 1}$ . Therefore, applying the rule (CONT) with  $\delta$  and the rule (NAME) with  $\gamma$ , we obtain the derivation  $\pi_{\text{LCC}\langle c[\beta \setminus \alpha] \rangle} \triangleright_{\mathcal{E}} \Gamma_0 \vdash \text{LCC}\langle c[\beta \setminus \alpha] \rangle \mid \Delta_0; \alpha : S \rightarrow A; ((\alpha' : A)^{\leq 1} \cup \gamma : B)$ . Finally, we conclude by (REPL) with  $\pi_s, \pi_{o'} \triangleright_{\mathcal{E}} \Gamma \vdash o' \mid \Delta$ .
- \*  $\text{LTC} = \text{LTC}'[x \setminus u]$ . Therefore, from  $\pi_{\text{LTC}'\langle c[\beta^\alpha s][\alpha \setminus \alpha'] \rangle}$  by (SUBS), we have contexts  $\Gamma = \Gamma_0 \cup \Gamma_1$  and  $\Delta' = \Delta_0 \cup \Delta_1$  with a derivation for the premiss  $\pi_{\text{LTC}'\langle c[\beta^\alpha s][\alpha \setminus \alpha'] \rangle} \triangleright_{\mathcal{E}} \Gamma_0; (x : B')^{\leq 1} \vdash \text{LTC}'\langle c[\beta \setminus^\alpha s][\alpha \setminus \alpha'] \rangle : B \mid \Delta_0; (\alpha' : A \cup (\gamma : B)^{\leq 1})$  as well as for  $\pi_u \triangleright_{\mathcal{E}} \Gamma_1 \vdash u : B' \mid \Delta_1; ((\alpha' : A)^{\leq 1} \cup (\gamma : B)^{\leq 1})$ . Consider therefore the object  $p = \text{LCC}'\langle c[\beta \setminus^\alpha s][\alpha \setminus \alpha'] \rangle$  where  $\text{LCC}' = [\gamma] \text{LTC}'$ . Applying (NAME) with  $\gamma$ , we obtain  $\pi_p \triangleright_{\mathcal{E}} \Gamma_0; (x : B')^{\leq 1} \vdash p \mid \Delta_0; (\alpha' : A \cup (\gamma : B)^{\leq 1})$ . Moreover, we have  $p' =$

$\text{LCC}'\langle c[\beta \setminus \alpha] \rangle \llbracket \alpha \setminus^{\alpha'} s \rrbracket \rightarrow_w p$ . Therefore, by the *i.h.* there exists a derivation for the expansion of  $p$ ,  $\pi_{p'} \triangleright_{\mathcal{E}} \Gamma_0; (x : B')^{\leq 1} \vdash p' \mid \Delta_0; (\alpha' : A \cup (\gamma : B)^{\leq 1})$ . This derivation necessarily ends with applications of the rules (REPL) and (NAME) with  $\gamma$ . Therefore, we have contexts  $\Gamma_0 = \Gamma'_0 \cup \Gamma''_0$  and  $\Delta_0 = \Delta'_0 \cup \Delta''_0$  with  $\pi_{\text{LTC}'\langle c[\beta \setminus \alpha] \rangle} \triangleright_{\mathcal{E}} \Gamma'_0; (x : B')^{\leq 1} \vdash \text{LTC}'\langle c[\beta \setminus \alpha] \rangle : B \mid \Delta'_0; \alpha : S \rightarrow A; ((\alpha' : A)^{\leq 1} \cup (\gamma : B)^{\leq 1})$  and  $\pi_s \triangleright_{\mathcal{E}} \Gamma''_0 \vdash s : S \mid \Delta''_0; ((\alpha' : A)^{\leq 1} \cup (\gamma : B)^{\leq 1})$ . Therefore, applying the rule (SUBS) with  $\pi_u$  followed by an application of (NAME) with  $\gamma$ , we obtain the derivation  $\pi_{\text{LCC}\langle c[\beta \setminus \alpha] \rangle} \triangleright_{\mathcal{E}} \Gamma'_0 \cup \Gamma_1 \vdash \text{LCC}\langle c[\beta \setminus \alpha] \rangle \mid \Delta'_0 \cup \Delta_1; \alpha : S \rightarrow A; ((\alpha' : A)^{\leq 1} \cup \gamma : B)$ .

We conclude by (REPL) with  $\pi_s, \pi_{o'} \triangleright_{\mathcal{E}} \Gamma \vdash o' \mid \Delta$ .

- $\text{LCC} = \text{LCC}' \llbracket \gamma \setminus^{\delta} s' \rrbracket$ . Therefore, by Lem. 4.4 with  $\alpha' \in o$  and (REPL), we have contexts  $\Gamma = \Gamma_0 \cup \Gamma_1$  and  $\Delta = \Delta_0 \cup \Delta_1; (\alpha' : A \cup \delta : B)$  with the premiss  $\pi_{\text{LCC}'\langle c[\beta \setminus \alpha] \rangle \llbracket \alpha \setminus^{\alpha'} \rrbracket} \triangleright_{\mathcal{E}} \Gamma_0 \vdash \text{LCC}'\langle c[\beta \setminus \alpha] \rangle \llbracket \alpha \setminus^{\alpha'} \rrbracket \mid \Delta_0; (\gamma : S' \rightarrow B)^{\leq 1}; (\alpha' : A \cup (\delta : B)^{\leq 1})$  as well as  $\pi_{s'} \triangleright_{\mathcal{E}} \Gamma_1 \vdash s' : S' \mid \Delta_1; ((\alpha' : A)^{\leq 1} \cup (\delta : B)^{\leq 1})$ . By the *i.h.* on  $\text{LCC}'$ ,  $\pi_{\text{LCC}'\langle c[\beta \setminus \alpha] \rangle \llbracket \alpha \setminus^{\alpha'} \rrbracket} \triangleright_{\mathcal{E}} \Gamma_0 \vdash \text{LCC}'\langle c[\beta \setminus \alpha] \rangle \llbracket \alpha \setminus^{\alpha'} s \rrbracket \mid \Delta_0; (\gamma : S' \rightarrow B)^{\leq 1}; (\alpha' : A \cup (\delta : B)^{\leq 1})$ . This derivation necessarily ends with an application of the rule (REPL). Therefore, we have contexts  $\Gamma_0 = \Gamma'_0 \cup \Gamma''_0$  and  $\Delta_0 = \Delta'_0 \cup \Delta''_0$  with derivations for the premisses  $\pi_{\text{LCC}'\langle c[\beta \setminus \alpha] \rangle} \triangleright_{\mathcal{E}} \Gamma'_0 \vdash \text{LCC}'\langle c[\beta \setminus \alpha] \rangle \mid \Delta'_0; (\alpha : S \rightarrow A)^{\leq 1}; (\gamma : S' \rightarrow B)^{\leq 1}; ((\alpha' : A)^{\leq 1} \cup (\delta : B)^{\leq 1})$  and  $\pi_s \triangleright_{\mathcal{E}} \Gamma''_0 \vdash s : S \mid \Delta''_0; (\gamma : S' \rightarrow B)^{\leq 1}; ((\alpha' : A)^{\leq 1} \cup (\delta : B)^{\leq 1})$ . Therefore, one may apply rule (REPL) with premisses  $\pi_{\text{LCC}'\langle c[\beta \setminus \alpha] \rangle}$  and  $\pi_{s'}$ , obtaining the derivation  $\pi_{\text{LCC}\langle c[\beta \setminus \alpha] \rangle} \triangleright_{\mathcal{E}} \Gamma'_0 \cup \Gamma_1 \vdash \text{LCC}\langle c[\beta \setminus \alpha] \rangle \mid \Delta'_0 \cup \Delta_1; (\alpha : S \rightarrow A)^{\leq 1}; ((\alpha' : A)^{\leq 1} \cup \delta : B)$ . We conclude by (REPL) with  $\pi_s, \pi_{o'} \triangleright_{\mathcal{E}} \Gamma \vdash o' \mid \Delta$ . Note that, without loss of generality, we may assume  $\gamma \notin s$  and, by Lem. 4.4, we have  $(\gamma : S' \rightarrow B)^{\leq 1}$  empty in  $\pi_s$ .

- $\text{LCC} = \text{LCC}' \llbracket \gamma \setminus \delta \rrbracket$ . Therefore, by Lem. 4.4 with  $\alpha' \in o$  and rule (REN), we have the typing context  $\Delta = \Delta'; (\alpha' : A \cup \delta : B)$  and a derivation for the premiss  $\pi_{\text{LCC}'\langle c[\beta \setminus \alpha] \rangle \llbracket \alpha \setminus^{\alpha'} \rrbracket} \triangleright_{\mathcal{E}} \Gamma \vdash \text{LCC}'\langle c[\beta \setminus \alpha] \rangle \llbracket \alpha \setminus^{\alpha'} \rrbracket \mid \Delta'; (\alpha' : A \cup (\delta : B)^{\leq 1}); (\gamma : B)^{\leq 1}$ . By the *i.h.* on  $\text{LCC}'$ , we guarantee the existence of a derivation  $\pi_{\text{LCC}'\langle c[\beta \setminus \alpha] \rangle \llbracket \alpha \setminus^{\alpha'} s \rrbracket} \triangleright_{\mathcal{E}} \Gamma \vdash \text{LCC}'\langle c[\beta \setminus \alpha] \rangle \llbracket \alpha \setminus^{\alpha'} s \rrbracket \mid \Delta; (\alpha' : A \cup (\delta : B)^{\leq 1}); (\gamma : B)^{\leq 1}$ . This derivation necessarily ends with an application of the rule (REPL). Therefore, we have contexts  $\Gamma = \Gamma_0 \cup \Gamma_1$  and  $\Delta' = \Delta_0 \cup \Delta_1$  with derivations for the premiss  $\pi_{\text{LCC}'\langle c[\beta \setminus \alpha] \rangle} \triangleright_{\mathcal{E}} \Gamma_0 \vdash \text{LCC}'\langle c[\beta \setminus \alpha] \rangle \mid \Delta_0; (\alpha : S \rightarrow A)^{\leq 1}; ((\alpha' : A)^{\leq 1} \cup (\delta : B)^{\leq 1}); (\gamma : B)^{\leq 1}$  and the premiss  $\pi_s \triangleright_{\mathcal{E}} \Gamma_1 \vdash s : S \mid \Delta_1; ((\alpha' : A)^{\leq 1} \cup (\delta : B)^{\leq 1}); (\gamma : B)^{\leq 1}$ . Therefore, applying the rule (REN) with  $\pi_{\text{LCC}'\langle c[\beta \setminus \alpha] \rangle}$  and names  $\gamma$  and  $\delta$ , we obtain the derivation  $\pi_{\text{LCC}\langle c[\beta \setminus \alpha] \rangle} \triangleright_{\mathcal{E}} \Gamma_0 \vdash \text{LCC}\langle c[\beta \setminus \alpha] \rangle \mid \Delta_0; (\alpha : S \rightarrow A)^{\leq 1}; ((\alpha' : A)^{\leq 1} \cup \delta : B)$ . Finally, we conclude by (REPL) with  $\pi_s, \pi_{o'} \triangleright_{\mathcal{E}} \Gamma \vdash o' \mid \Delta$ . Note that, without loss of generality, we may assume  $\gamma \notin s$  and, by Lem. 4.4, we have  $(\gamma : S'' \rightarrow B)^{\leq 1}$  empty in  $\pi_s$ .

- $0 = \text{T}u$ . Therefore,  $o = tu$  and  $o' = t'u$  with  $t' \rightarrow_p t$ . Moreover, by (APP) we have  $\Gamma = \Gamma_0 \cup \Gamma_1$  and  $\Delta = \Delta_0 \cup \Delta_1$  with  $\pi_t \triangleright_{\mathcal{E}} \Gamma_0 \vdash t : A \rightarrow T \mid \Delta_0$  and  $\pi_u \triangleright_{\mathcal{E}} \Gamma_1 \vdash u : A \mid \Delta_1$ . By the *i.h.* there exists  $\pi_{t'} \triangleright_{\mathcal{E}} \Gamma_0 \vdash t' : A \rightarrow T \mid \Delta_0$ . Finally, we conclude by (APP),  $\pi' \triangleright_{\mathcal{E}} \Gamma \vdash o' : T \mid \Delta$ .
- $0 = t\text{T}$ . Therefore,  $o = tu$  and  $o' = tu'$  with  $u' \rightarrow_p u$ . Moreover, by (APP) we have  $\Gamma = \Gamma_0 \cup \Gamma_1$  and  $\Delta = \Delta_0 \cup \Delta_1$  with  $\pi_t \triangleright_{\mathcal{E}} \Gamma_0 \vdash t : A \rightarrow T \mid \Delta_0$  and  $\pi_u \triangleright_{\mathcal{E}} \Gamma_1 \vdash u : A \mid \Delta_1$ . By the *i.h.* there exists  $\pi_{u'} \triangleright_{\mathcal{E}} \Gamma_1 \vdash u' : A \mid \Delta_1$ . Finally, we conclude by (APP),  $\pi' \triangleright_{\mathcal{E}} \Gamma \vdash o' : T \mid \Delta$ .

- $0 = \lambda x.T$ . Therefore,  $o = \lambda x.t$  and  $o' = \lambda x.t'$  with  $t' \rightarrow_{\mathcal{P}} t$ . Moreover, by (ABS) we have  $T = A \rightarrow B$  with  $\pi_t \triangleright_{\mathcal{E}} \Gamma; (x : A)^{\leq 1} \vdash t : B \mid \Delta$ . By the *i.h.* there exists  $\pi_{t'} \triangleright_{\mathcal{E}} \Gamma; (x : A)^{\leq 1} \vdash t' : B \mid \Delta$ . Finally, we conclude by (ABS),  $\pi' \triangleright_{\mathcal{E}} \Gamma \vdash o' : T \mid \Delta$ .
- $0 = \mu \alpha.C$ . Therefore,  $o = \mu \alpha.c$  and  $o' = \mu \alpha.c'$  with  $c' \rightarrow_{\mathcal{P}} c$ . Moreover, by (CONT) we have  $\pi_c \triangleright_{\mathcal{E}} \Gamma \vdash c \mid \Delta; (\alpha : T)^{\leq 1}$ . By the *i.h.* there exists a derivation  $\pi_{c'} \triangleright_{\mathcal{E}} \Gamma \vdash c' \mid \Delta; (\alpha : T)^{\leq 1}$ . Finally, we conclude by (CONT),  $\pi' \triangleright_{\mathcal{E}} \Gamma \vdash o' : T \mid \Delta$ .
- $0 = T[x \setminus u]$ . Therefore,  $o = t[x \setminus u]$  and  $o' = t'[x \setminus u]$  with  $t' \rightarrow_{\mathcal{P}} t$ . Moreover, by (SUBS),  $\Gamma = \Gamma_0 \cup \Gamma_1$  and  $\Delta = \Delta_0 \cup \Delta_1$  with  $\pi_t \triangleright_{\mathcal{E}} \Gamma_0; (x : A)^{\leq 1} \vdash t : T \mid \Delta_0$  and  $\pi_u \triangleright_{\mathcal{E}} \Gamma_1 \vdash u : A \mid \Delta_1$ . By the *i.h.* there exists  $\pi_{t'} \triangleright_{\mathcal{E}} \Gamma_0; (x : A)^{\leq 1} \vdash t' : T \mid \Delta_0$ . Finally, we conclude by (SUBS),  $\pi' \triangleright_{\mathcal{E}} \Gamma \vdash o' : T \mid \Delta$ .
- $0 = t[x \setminus T]$ . Therefore,  $o = t[x \setminus u]$  and  $o' = t[x \setminus u']$  with  $u' \rightarrow_{\mathcal{P}} u$ . Moreover, by (SUBS) we have  $\Gamma = \Gamma_0 \cup \Gamma_1$  and  $\Delta = \Delta_0 \cup \Delta_1$  with  $\pi_t \triangleright_{\mathcal{E}} \Gamma_0; (x : A)^{\leq 1} \vdash t : T \mid \Delta_0$  and  $\pi_u \triangleright_{\mathcal{E}} \Gamma_1 \vdash u : A \mid \Delta_1$ . By the *i.h.* there exists  $\pi_{u'} \triangleright_{\mathcal{E}} \Gamma_1 \vdash u' : A \mid \Delta_1$ . Finally, we conclude by (SUBS),  $\pi' \triangleright_{\mathcal{E}} \Gamma \vdash o' : T \mid \Delta$ .
- $0 = [\alpha]T$ . Therefore,  $o = [\alpha]t$  and  $o' = [\alpha]t'$  with  $t' \rightarrow_{\mathcal{P}} t$ . Moreover, by (NAME) we have  $\Delta = \Delta_0; \alpha : A$  with  $\pi_t \triangleright_{\mathcal{E}} \Gamma \vdash t : A \mid \Delta_0; (\alpha : A)^{\leq 1}$ . By the *i.h.* there exists  $\pi_{t'} \triangleright_{\mathcal{E}} \Gamma \vdash t' : A \mid \Delta_0; (\alpha : A)^{\leq 1}$ . We conclude by (NAME),  $\pi' \triangleright_{\mathcal{E}} \Gamma \vdash o' : T \mid \Delta_0; \alpha : A$ .
- $0 = C[\alpha \setminus^{\alpha'} s]$ . Therefore,  $o = c[\alpha \setminus^{\alpha'} s]$  and  $o' = c'[\alpha \setminus^{\alpha'} s]$  with  $c' \rightarrow_{\mathcal{P}} c$ . Moreover, by (REPL) we have the typing contexts  $\Gamma = \Gamma_0 \cup \Gamma_1$  and  $\Delta = \Delta_0 \cup \Delta_1; \alpha' : A$  with derivations for the premisses  $\pi_c \triangleright_{\mathcal{E}} \Gamma_0 \vdash c \mid \Delta_0; (\alpha : S \rightarrow A)^{\leq 1}; (\alpha' : A)^{\leq 1}$  and  $\pi_s \triangleright_{\mathcal{E}} \Gamma_1 \vdash s : A \mid \Delta_1; (\alpha' : A)^{\leq 1}$ . By the *i.h.* there exists a typing derivation for the expansion of the command  $\pi_{c'} \triangleright_{\mathcal{E}} \Gamma_0 \vdash c' \mid \Delta_0; (\alpha : S \rightarrow A)^{\leq 1}; (\alpha' : A)^{\leq 1}$ . Finally, we conclude by (REPL),  $\pi' \triangleright_{\mathcal{E}} \Gamma \vdash o' : T \mid \Delta$ .
- $0 = c[\alpha \setminus^{\alpha'} S]$ . Therefore,  $o = c[\alpha \setminus^{\alpha'} s]$  and  $o' = c'[\alpha \setminus^{\alpha'} s']$  with  $s' \rightarrow_{\mathcal{P}} s$ . Moreover, by (REPL) we have the typing contexts  $\Gamma = \Gamma_0 \cup \Gamma_1$  and  $\Delta = \Delta_0 \cup \Delta_1; \alpha' : A$  with derivations for the premisses  $\pi_c \triangleright_{\mathcal{E}} \Gamma_0 \vdash c \mid \Delta_0; (\alpha : S \rightarrow A)^{\leq 1}; (\alpha' : A)^{\leq 1}$  and  $\pi_s \triangleright_{\mathcal{E}} \Gamma_1 \vdash s : A \mid \Delta_1; (\alpha' : A)^{\leq 1}$ . By the *i.h.* there exists a typing derivation for the expansion of the stack  $\pi_{s'} \triangleright_{\mathcal{E}} \Gamma_1 \vdash s' : A \mid \Delta_1; (\alpha' : A)^{\leq 1}$ . Finally, we conclude by (REPL),  $\pi' \triangleright_{\mathcal{E}} \Gamma \vdash o' : T \mid \Delta$ .
- $0 = C[\alpha \setminus \beta]$ . Therefore,  $o = c[\alpha \setminus \beta]$  and  $o' = c'[\alpha \setminus \beta]$  with  $c' \rightarrow_{\mathcal{P}} c$ . Moreover, by (REN) we have  $\Delta = \Delta_0; \beta : A$  with  $\pi_c \triangleright_{\mathcal{E}} \Gamma \vdash c \mid \Delta_0; (\alpha : A)^{\leq 1}; (\beta : A)^{\leq 1}$ . By the *i.h.* there exists a derivation  $\pi_{c'} \triangleright_{\mathcal{E}} \Gamma \vdash c' \mid \Delta_0; (\alpha : A)^{\leq 1}; (\beta : A)^{\leq 1}$ . Finally, we conclude by (REN),  $\pi' \triangleright_{\mathcal{E}} \Gamma \vdash o' : T \mid \Delta$ .
- $0 = T \cdot s$ . Therefore,  $o = t \cdot s$  and  $o' = t' \cdot s$  with  $t' \rightarrow_{\mathcal{P}} t$ . Moreover, by (STK) we have  $T = A \cdot S$ ,  $\Gamma = \Gamma_0 \cup \Gamma_1$  and  $\Delta = \Delta_0 \cup \Delta_1$  with  $\pi_t \triangleright_{\mathcal{E}} \Gamma_0 \vdash t : A \mid \Delta_0$  and  $\pi_s \triangleright_{\mathcal{E}} \Gamma_1 \vdash s : S \mid \Delta_1$ . By the *i.h.* there exists  $\pi_{t'} \triangleright_{\mathcal{E}} \Gamma_0 \vdash t' : A \mid \Delta_0$ . Finally, we conclude by (STK),  $\pi' \triangleright_{\mathcal{E}} \Gamma \vdash o' : T \mid \Delta$ .
- $0 = t \cdot S$ . Therefore,  $o = t \cdot s$  and  $o' = t \cdot s'$  with  $s' \rightarrow_{\mathcal{P}} s$ . Moreover, by (STK) we have  $T = A \cdot S$ ,  $\Gamma = \Gamma_0 \cup \Gamma_1$  and  $\Delta = \Delta_0 \cup \Delta_1$  with  $\pi_t \triangleright_{\mathcal{E}} \Gamma_0 \vdash t : A \mid \Delta_0$  and  $\pi_s \triangleright_{\mathcal{E}} \Gamma_1 \vdash s : S \mid \Delta_1$ . By the *i.h.* there exists  $\pi_{s'} \triangleright_{\mathcal{E}} \Gamma_1 \vdash s' : S \mid \Delta_1$ . Finally, we conclude by (STK),  $\pi' \triangleright_{\mathcal{E}} \Gamma \vdash o' : T \mid \Delta$ .

□

APPENDIX E. STRUCTURAL EQUIVALENCE FOR THE  $\Lambda M$ -CALCULUS

To prove Lem. 7.7 we introduce two auxiliary results about contexts LTT and LCC.

**Lemma E.1.** *Let  $u, v \in \mathbb{T}_{\Lambda M}$  and consider the following relation:*

$$\mathcal{S} \triangleq \{ \langle u, v \rangle \mid \exists L. \exists \text{LTT}. \exists t. u = L \langle \text{LTT} \langle t \rangle \rangle \text{ and } v = \text{LTT} \langle L \langle t \rangle \rangle \text{ and } \text{bv}(L) \notin \text{LTT} \text{ and } \text{fc}(L, \text{LTT}) \}$$

*Then  $\mathcal{S}$  is a strong bisimulation w.r.t. the plain computation relation.*

*Proof.* We prove that if  $u \mathcal{S} v$  and  $u \rightarrow_{\mathcal{P}} u'$ , then there exists  $v'$  such that  $v \rightarrow_{\mathcal{P}} v'$  and  $u' \mathcal{S} v'$ . From  $u \mathcal{S} v$ , there exists  $L, \text{LTT}$  and  $t$  such that  $u = L \langle \text{LTT} \langle t \rangle \rangle$  and  $v = \text{LTT} \langle L \langle t \rangle \rangle$ . The proof proceeds by analysing all the overlapping cases between the step  $L \langle \text{LTT} \langle t \rangle \rangle \rightarrow_{\mathcal{P}} u'$  and  $L, \text{LTT}$  and  $t$ . For each such case, we deduce the existence of  $\text{LTT}', L'$  and  $t'$  such that  $v = L' \langle \text{LTT}' \langle t' \rangle \rangle$  and moreover, prove that we can set  $v' = \text{LTT}' \langle L' \langle t' \rangle \rangle$ . In a diagram:

$$\begin{array}{ccc} u = L \langle \text{LTT} \langle t \rangle \rangle & \mathcal{S} & \text{LTT} \langle L \langle t \rangle \rangle = v \\ \mathcal{P} \downarrow & & \mathcal{P}' \downarrow \\ u' = L' \langle \text{LTT}' \langle t' \rangle \rangle & \mathcal{S} & \text{LTT}' \langle L' \langle t' \rangle \rangle = v' \end{array}$$

And the same for the symmetric case (which is similar and omitted).

The possible overlap between  $\mathcal{P}$ -steps and  $L \langle \text{LTT} \langle t \rangle \rangle$  can be broken down as follows:

- The step is entirely within  $t$ , i.e.  $t \rightarrow_{\mathcal{P}} t'$ . Then it suffices to take  $L' = L$  and  $\text{LTT}' = \text{LTT}$ .
- The step is entirely within  $L$ , i.e.  $L \rightarrow_{\mathcal{P}} L'$ . Then we take  $t' = t$  and  $\text{LTT}' = \text{LTT}$ .
- The step is entirely within  $\text{LTT}$ , i.e.  $\text{LTT} \rightarrow_{\mathcal{P}} \text{LTT}'$ . Then we take  $t' = t$  and  $L' = L$ .
- The step overlaps with  $\text{LTT}$ . There are four cases according to the reduction rule applied:

(1) **dB**. There are two further cases.

- (a) It overlaps with  $t$ . Then,  $t = L_1 \langle \lambda x.v \rangle$ ,  $\text{LTT} = \text{LTT}_2 \langle L_2 u \rangle$  and the LHS of the rule **dB** is  $L_2 \langle L_1 \langle \lambda x.v \rangle \rangle u$ . We conclude by setting  $t' = L_1 \langle v[x \setminus u] \rangle$ ,  $L' = L$  and  $\text{LTT}' = \text{LTT}_2 \langle L_2 \rangle$ :

$$\begin{array}{ccc} L \langle \text{LTT} \langle t \rangle \rangle & \mathcal{S} & \text{LTT}_2 \langle L_2 \langle L \langle L_1 \langle \lambda x.v \rangle \rangle \rangle u \\ \text{dB} \downarrow & & \text{dB}' \downarrow \\ L' \langle \text{LTT}' \langle t' \rangle \rangle & \mathcal{S} & \text{LTT}_2 \langle L_2 \langle L' \langle L_1 \langle v[x \setminus u] \rangle \rangle \rangle \end{array}$$

- (b) It does not overlap with  $t$ . Then,  $\text{LTT} = \text{LTT}_2 \langle L_2 \langle \lambda x. \text{LTT}_1 \rangle u \rangle$ . We conclude with  $t' = t$ ,  $L' = L$  and  $\text{LTT}' = \text{LTT}_2 \langle L_2 \langle \text{LTT}_1[x \setminus u] \rangle \rangle$ :

$$\begin{array}{ccc} L \langle \text{LTT} \langle t \rangle \rangle & \mathcal{S} & \text{LTT}_2 \langle L_2 \langle \lambda x. \text{LTT}_1 \langle L \langle t \rangle \rangle \rangle u \\ \text{dB} \downarrow & & \text{dB}' \downarrow \\ L' \langle \text{LTT}' \langle t' \rangle \rangle & \mathcal{S} & \text{LTT}_2 \langle L_2 \langle \text{LTT}_1 \langle L' \langle t' \rangle \rangle [x \setminus u] \rangle \end{array}$$

(2) **dM**. There are two further cases.

- (a) It overlaps with  $t$ . Then,  $t = L_1 \langle \mu \alpha.c \rangle$ ,  $\text{LTT} = \text{LTT}_2 \langle L_2 u \rangle$  and the LHS of the step **dM** is  $L_2 \langle L_1 \langle \mu \alpha.c \rangle \rangle u$ . We conclude with  $t' = L_1 \langle \mu \alpha'.c[\alpha \setminus \alpha' u] \rangle$ ,  $L' = L$  and  $\text{LTT}' = \text{LTT}_2 \langle L_2 \rangle$ :

$$\begin{array}{ccc} L \langle \text{LTT} \langle t \rangle \rangle & \mathcal{S} & \text{LTT}_2 \langle L_2 \langle L \langle L_1 \langle \mu \alpha.c \rangle \rangle \rangle u \\ \text{dM} \downarrow & & \text{dM}' \downarrow \\ L' \langle \text{LTT}' \langle t' \rangle \rangle & \mathcal{S} & \text{LTT}_2 \langle L_2 \langle L' \langle L_1 \langle \mu \alpha'.c[\alpha \setminus \alpha' u] \rangle \rangle \rangle \end{array}$$

- (b) It does not overlap with  $t$ . Then,  $\text{LTT} = \text{LTT}_2 \langle L_2 \langle \mu \alpha. \text{LCT} \rangle u \rangle$ . We conclude with  $t' = t$ ,  $L' = L$  and  $\text{LTT}' = \text{LTT}_2 \langle L_2 \langle \mu \alpha'. \text{LCT}[\alpha \setminus \alpha' u] \rangle \rangle$ :

$$\begin{array}{ccc}
L\langle LTT\langle t \rangle \rangle & \mathcal{S} & LTT_2\langle L_2\langle \mu\alpha.LCT\langle L\langle t \rangle \rangle \rangle u \\
\text{dM} \downarrow & & \text{dM} \downarrow \\
L'\langle LTT'\langle t' \rangle \rangle & \mathcal{S} & LTT_2\langle L_2\langle \mu\alpha'.LCT\langle L'\langle t' \rangle \rangle \rangle [\alpha \setminus^{\alpha'} u]
\end{array}$$

(3) N. There are two further cases.

- (a) It overlaps with  $t$ . Then,  $t = LTT_1\langle \mu\gamma.LCC_1\langle [\alpha] u \rangle \rangle$ ,  $LTT = LTT_2\langle \mu\delta.LCC_2\langle LCT\langle [\alpha \setminus^{\alpha'} s] \rangle \rangle$  and the LHS of the step N is  $LCT\langle LTT_1\langle \mu\gamma.LCC_1\langle [\alpha] u \rangle \rangle \rangle [\alpha \setminus^{\alpha'} s]$ . We conclude by setting  $t' = LTT_1\langle \mu\gamma.LCC_1\langle [\alpha'] u :: s \rangle \rangle$ ,  $L' = L$  and  $LTT' = LTT_2\langle \mu\delta.LCC_2\langle LCT \rangle \rangle$ :

$$\begin{array}{ccc}
L\langle LTT\langle t \rangle \rangle & \mathcal{S} & LTT_2\langle \mu\delta.LCC_2\langle LCT\langle L\langle LTT_1\langle \mu\gamma.LCC_1\langle [\alpha] u \rangle \rangle \rangle \rangle [\alpha \setminus^{\alpha'} s] \rangle \\
\text{N} \downarrow & & \text{N} \downarrow \\
L'\langle LTT'\langle t' \rangle \rangle & \mathcal{S} & LTT_2\langle \mu\delta.LCC_2\langle LCT\langle L'\langle LTT_1\langle \mu\gamma.LCC_1\langle [\alpha'] u :: s \rangle \rangle \rangle \rangle \rangle
\end{array}$$

- (b) It does not overlap with  $t$ . Then,  $LTT = LTT_2\langle \mu\gamma.LCC_2\langle LCC\langle [\alpha] LCT \rangle \rangle [\alpha \setminus^{\alpha'} s] \rangle$ . We conclude with  $t' = t$ ,  $L' = L$  and  $LTT' = LTT_2\langle \mu\gamma.LCC_2\langle LCC\langle [\alpha'] LTT_1 :: s \rangle \rangle \rangle$ :

$$\begin{array}{ccc}
L\langle LTT\langle t \rangle \rangle & \mathcal{S} & LTT_2\langle \mu\gamma.LCC_2\langle LCC\langle [\alpha] LCT\langle L\langle t \rangle \rangle \rangle \rangle [\alpha \setminus^{\alpha'} s] \rangle \\
\text{N} \downarrow & & \text{N} \downarrow \\
L'\langle LTT'\langle t' \rangle \rangle & \mathcal{S} & LTT_2\langle \mu\gamma.LCC_2\langle LCC\langle [\alpha'] LTT_1\langle L'\langle t' \rangle \rangle :: s \rangle \rangle
\end{array}$$

(4) C. There are two further cases.

- (a) It overlaps with  $t$ . Then,  $t = LTT_1\langle \mu\gamma.LCC_1\langle c\langle [\beta \setminus^{\alpha} s'] \rangle \rangle \rangle$ ,  $LTT = LTT_2\langle \mu\delta.LCC_2\langle LCT\langle [\alpha \setminus^{\alpha'} s] \rangle \rangle$  and the LHS of the step C is  $LCT\langle LTT_1\langle \mu\gamma.LCC_1\langle c\langle [\beta \setminus^{\alpha} s'] \rangle \rangle \rangle \rangle [\alpha \setminus^{\alpha'} s]$ . We conclude by setting  $t' = LTT_1\langle \mu\gamma.LCC_1\langle c\langle [\beta \setminus^{\alpha'} s' \cdot s] \rangle \rangle \rangle$ ,  $L' = L$  and  $LTT' = LTT_2\langle \mu\delta.LCC_2\langle LCT \rangle \rangle$ :

$$\begin{array}{ccc}
L\langle LTT\langle t \rangle \rangle & \mathcal{S} & LTT_2\langle \mu\delta.LCC_2\langle LCT\langle L\langle LTT_1\langle \mu\gamma.LCC_1\langle c\langle [\beta \setminus^{\alpha} s'] \rangle \rangle \rangle \rangle \rangle [\alpha \setminus^{\alpha'} s] \rangle \\
\text{c} \downarrow & & \text{c} \downarrow \\
L'\langle LTT'\langle t' \rangle \rangle & \mathcal{S} & LTT_2\langle \mu\delta.LCC_2\langle LCT\langle L'\langle LTT_1\langle \mu\gamma.LCC_1\langle c\langle [\beta \setminus^{\alpha'} s' \cdot s] \rangle \rangle \rangle \rangle \rangle \rangle
\end{array}$$

- (b) It does not overlap with  $t$ . Then,  $LTT = LTT_2\langle \mu\gamma.LCC_2\langle LCC\langle LCT\langle [\beta \setminus^{\alpha} s'] \rangle \rangle \rangle [\alpha \setminus^{\alpha'} s] \rangle$ . We conclude with  $t' = t$ ,  $L' = L$  and  $LTT' = LTT_2\langle \mu\gamma.LCC_2\langle LCC\langle LCT\langle [\beta \setminus^{\alpha'} s' \cdot s] \rangle \rangle \rangle \rangle$ :

$$\begin{array}{ccc}
L\langle LTT\langle t \rangle \rangle & \mathcal{S} & LTT_2\langle \mu\gamma.LCC_2\langle LCC\langle LCT\langle L\langle t \rangle \rangle \rangle \rangle [\beta \setminus^{\alpha} s'] \rangle [\alpha \setminus^{\alpha'} s] \rangle \\
\text{c} \downarrow & & \text{c} \downarrow \\
L'\langle LTT'\langle t' \rangle \rangle & \mathcal{S} & LTT_2\langle \mu\gamma.LCC_2\langle LCC\langle LCT\langle L'\langle t' \rangle \rangle \rangle \rangle [\beta \setminus^{\alpha'} s' \cdot s] \rangle
\end{array}$$

(5) W. There are two further cases.

- (a) It overlaps with  $t$ . Then,  $t = LTT_1\langle \mu\gamma.LCC_1\langle c\langle [\beta \setminus^{\alpha}] \rangle \rangle \rangle$ ,  $LTT = LTT_2\langle \mu\delta.LCC_2\langle LCT\langle [\alpha \setminus^{\alpha'} s] \rangle \rangle$  and the LHS of the step W is  $LCT\langle LTT_1\langle \mu\gamma.LCC_1\langle c\langle [\beta \setminus^{\alpha}] \rangle \rangle \rangle \rangle [\alpha \setminus^{\alpha'} s]$ . We conclude with  $t' = LTT_1\langle \mu\gamma.LCC_1\langle c\langle [\beta \setminus^{\alpha} s] \rangle \rangle [\alpha \setminus^{\alpha'}] \rangle$ ,  $L' = L$  and  $LTT' = LTT_2\langle \mu\delta.LCC_2\langle LCT \rangle \rangle$ :

$$\begin{array}{ccc}
L\langle LTT\langle t \rangle \rangle & \mathcal{S} & LTT_2\langle \mu\delta.LCC_2\langle LCT\langle L\langle LTT_1\langle \mu\gamma.LCC_1\langle c\langle [\beta \setminus^{\alpha}] \rangle \rangle \rangle \rangle \rangle [\alpha \setminus^{\alpha'} s] \rangle \\
\text{w} \downarrow & & \text{w} \downarrow \\
L'\langle LTT'\langle t' \rangle \rangle & \mathcal{S} & LTT_2\langle \mu\delta.LCC_2\langle LCT\langle L'\langle LTT_1\langle \mu\gamma.LCC_1\langle c\langle [\beta \setminus^{\alpha} s] \rangle \rangle [\alpha \setminus^{\alpha'}] \rangle \rangle \rangle \rangle
\end{array}$$

- (b) It does not overlap with  $t$ . Then,  $LTT = LTT_2\langle \mu\gamma.LCC_2\langle LCC\langle LCT\langle [\beta \setminus^{\alpha}] \rangle \rangle \rangle [\alpha \setminus^{\alpha'} s] \rangle$ . We conclude with  $t' = t$ ,  $L' = L$  and  $LTT' = LTT_2\langle \mu\gamma.LCC_2\langle LCC\langle LCT\langle [\beta \setminus^{\alpha} s] \rangle \rangle [\alpha \setminus^{\alpha'}] \rangle \rangle$ :



$$\begin{array}{ccc}
L\langle\text{LTT}\langle t \rangle\rangle & \mathcal{S} & \text{LTT}_2\langle\mu\gamma.\text{LCC}_2\langle\text{LCC}\langle\text{LCT}\langle L\langle t \rangle\rangle[\beta \setminus \alpha][\alpha \setminus^{\alpha'} s]\rangle\rangle \\
\downarrow w & & \downarrow w \\
L'\langle\text{LTT}'\langle t' \rangle\rangle & \mathcal{S} & \text{LTT}_2\langle\mu\gamma.\text{LCC}_2\langle\text{LCC}\langle\text{LCT}\langle L'\langle t' \rangle\rangle[\beta \setminus^{\alpha'} s][\alpha \setminus^{\alpha'}]\rangle\rangle
\end{array}$$

- There are not other cases given the definition of the relation  $\mathcal{S}$ .

□

**Lemma E.2.** *Let  $d, e \in \mathbb{C}_{\Lambda M}$  and consider the following relation*

$$\mathcal{R} \triangleq \{\langle d, e \rangle \mid \exists R, \text{LCC}, c. d = R\langle\text{LCC}\langle c \rangle\rangle \text{ and } e = \text{LCC}\langle R\langle c \rangle\rangle \text{ and } \text{bn}(R) \notin \text{LCC} \text{ and } \text{fc}(R, \text{LCC})\}$$

*Then  $\mathcal{R}$  is a strong bisimulation w.r.t. the plain computation relation.*

*Proof.* We prove that

$$\begin{array}{ccc}
R\langle\text{LCC}\langle c \rangle\rangle & \mathcal{R} & \text{LCC}\langle R\langle c \rangle\rangle \\
\downarrow \mathcal{P} & & \downarrow \mathcal{P} \\
R'\langle\text{LCC}'\langle c' \rangle\rangle & \mathcal{R} & \text{LCC}'\langle R'\langle c' \rangle\rangle
\end{array}$$

for some  $R'$ ,  $\text{LCC}'$  and  $c'$ . And the same for the symmetric case (omitted here since it is similar). The proof proceeds by analysing all the overlapping cases between  $\mathcal{P}$  and the LHS of the  $\mathcal{R}$ -step  $R\langle\text{LCC}\langle c \rangle\rangle$ :

- The step is completely within  $c$ , i.e.  $c \rightarrow_{\mathcal{P}} c'$ . Then, it suffices to set  $R' = R$  and  $\text{LCC}' = \text{LCC}$ .
- The step is completely within  $R$ , i.e.  $R \rightarrow_{\mathcal{P}} R'$ . Then, it suffices to set  $c' = c$  and  $\text{LCC}' = \text{LCC}$ .
- The step is completely within  $\text{LCC}$ , i.e.  $\text{LCC} \rightarrow_{\mathcal{P}} \text{LCC}'$ . Then it suffices to set  $c' = c$  and  $R' = R$ .
- The step overlaps with  $\text{LCC}$ . There are four further cases depending on the reduction step applied:

- (1) dB. Then,  $\text{LCC} = \text{LCC}_1\langle[\gamma] \text{LTC}_1\langle L\langle\lambda x.\text{LTC}_2\rangle u\rangle\rangle$ . We conclude with  $c' = c$ ,  $R' = R$  and  $\text{LCC}' = \text{LCC}_1\langle[\gamma] \text{LTC}_1\langle L\langle\text{LTC}_2[x \setminus u]\rangle\rangle\rangle$ :

$$\begin{array}{ccc}
R\langle\text{LCC}\langle c \rangle\rangle & \mathcal{R} & \text{LCC}_1\langle[\gamma] \text{LTC}_1\langle L\langle\lambda x.\text{LTC}_2\langle R\langle c \rangle\rangle\rangle u\rangle\rangle \\
\downarrow \text{dB} & & \downarrow \text{dB} \\
R'\langle\text{LCC}'\langle c' \rangle\rangle & \mathcal{R} & \text{LCC}_1\langle[\gamma] \text{LTC}_1\langle L\langle\text{LTC}_2\langle R'\langle c' \rangle\rangle[x \setminus u]\rangle\rangle
\end{array}$$

- (2) dM. Then,  $\text{LCC} = \text{LCC}_1\langle[\gamma] \text{LTC}_1\langle L\langle\mu\alpha.\text{LTC}_2\rangle u\rangle\rangle$ . We conclude with  $c' = c$ ,  $R' = R$  and  $\text{LCC}' = \text{LCC}_1\langle[\gamma] \text{LTC}_1\langle L\langle\mu\alpha'.\text{LTC}_2[\alpha \setminus^{\alpha'} u]\rangle\rangle\rangle$ :

$$\begin{array}{ccc}
R\langle\text{LCC}\langle c \rangle\rangle & \mathcal{R} & \text{LCC}_1\langle[\gamma] \text{LTC}_1\langle L\langle\mu\alpha.\text{LTC}_2\langle R\langle c \rangle\rangle\rangle u\rangle\rangle \\
\downarrow \text{dM} & & \downarrow \text{dM} \\
R'\langle\text{LCC}'\langle c' \rangle\rangle & \mathcal{R} & \text{LCC}_1\langle[\gamma] \text{LTC}_1\langle L\langle\mu\alpha'.\text{LTC}_2\langle R'\langle c' \rangle\rangle[\alpha \setminus^{\alpha'} u]\rangle\rangle
\end{array}$$

- (3) N. Then there are two further cases.

- (a) It overlaps with  $c$ . Then we have  $c = \text{LCC}_1\langle[\alpha] t\rangle$ ,  $\text{LCC} = \text{LCC}_3\langle\text{LCC}_2[\alpha \setminus^{\alpha'} s]\rangle$  and the rule N applies to  $\text{LCC}_2\langle\text{LCC}_1\langle[\alpha] t\rangle\rangle[\alpha \setminus^{\alpha'} s]$ . We conclude by setting  $c' = \text{LCC}_1\langle[\alpha'] t :: sc_1\rangle$ ,  $R' = R$  and  $\text{LCC}' = \text{LCC}_3\langle\text{LCC}_2\rangle$ :

$$\mathcal{R}\langle \text{LCC}\langle c \rangle \rangle \quad \mathcal{R} \quad \text{LCC}_3\langle \text{LCC}_2\langle \mathcal{R}\langle \text{LCC}_1\langle [\alpha] t \rangle \rangle \rangle \llbracket \alpha \setminus^{\alpha'} s \rrbracket \rangle$$

$$\mathbb{N} \downarrow$$

$$\mathcal{R}'\langle \text{LCC}'\langle c' \rangle \rangle \quad \mathcal{R} \quad \text{LCC}_3\langle \text{LCC}_2\langle \mathcal{R}'\langle \text{LCC}_1\langle [\alpha'] t :: s \rangle \rangle \rangle$$

$$\mathbb{N} \downarrow$$

- (b) It does not overlap with  $c$ . Then,  $\text{LCC} = \text{LCC}_3\langle \text{LCC}_2\langle [\alpha] \text{LTC} \rangle \llbracket \alpha \setminus^{\alpha'} s \rrbracket \rangle$ . We conclude with  $c' = c$ ,  $\mathcal{R}' = \mathcal{R}$  and  $\text{LCC}' = \text{LCC}_3\langle \text{LCC}_2\langle [\alpha'] \text{LTC} :: s \rangle \rangle$ :

$$\mathcal{R}\langle \text{LCC}\langle c \rangle \rangle \quad \mathcal{R} \quad \text{LCC}_3\langle \text{LCC}_2\langle [\alpha] \text{LTC}\langle \mathcal{R}\langle c \rangle \rangle \rangle \llbracket \alpha \setminus^{\alpha'} s \rrbracket \rangle$$

$$\mathbb{N} \downarrow$$

$$\mathcal{R}'\langle \text{LCC}'\langle c' \rangle \rangle \quad \mathcal{R} \quad \text{LCC}_3\langle \text{LCC}_2\langle [\alpha'] \text{LTC}\langle \mathcal{R}'\langle c' \rangle \rangle :: s \rangle \rangle$$

$$\mathbb{N} \downarrow$$

- (4) **C**. Then there are two possibilities.

- (a) It overlaps with  $c$ . Then we have  $c = \text{LCC}_1\langle c_1 \llbracket \beta \setminus^{\alpha} s' \rrbracket \rangle$ ,  $\text{LCC} = \text{LCC}_3\langle \text{LCC}_2\llbracket \alpha \setminus^{\alpha'} s \rrbracket \rangle$  and the rule **C** applies to  $\text{LCC}_2\langle \text{LCC}_1\langle c_1 \llbracket \beta \setminus^{\alpha} s' \rrbracket \rangle \rangle \llbracket \alpha \setminus^{\alpha'} s \rrbracket$ . We conclude by setting  $c' = \text{LCC}_1\langle c_1 \llbracket \beta \setminus^{\alpha'} s' \cdot s \rrbracket \rangle$ ,  $\mathcal{R}' = \mathcal{R}$  and  $\text{LCC}' = \text{LCC}_3\langle \text{LCC}_2 \rangle$ :

$$\mathcal{R}\langle \text{LCC}\langle c \rangle \rangle \quad \mathcal{R} \quad \text{LCC}_3\langle \text{LCC}_2\langle \mathcal{R}\langle \text{LCC}_1\langle c_1 \llbracket \beta \setminus^{\alpha} s' \rrbracket \rangle \rangle \rangle \llbracket \alpha \setminus^{\alpha'} s \rrbracket \rangle$$

$$c \downarrow$$

$$\mathcal{R}'\langle \text{LCC}'\langle c' \rangle \rangle \quad \mathcal{R} \quad \text{LCC}_3\langle \text{LCC}_2\langle \mathcal{R}'\langle \text{LCC}_1\langle c_1 \llbracket \beta \setminus^{\alpha'} s' \cdot s \rrbracket \rangle \rangle \rangle$$

$$c \downarrow$$

- (b) It does not overlap with  $c$ . Then,  $\text{LCC} = \text{LCC}_3\langle \text{LCC}_2\langle \text{LCC}_1\llbracket \beta \setminus^{\alpha} s' \rrbracket \rangle \llbracket \alpha \setminus^{\alpha'} s \rrbracket \rangle$ . We conclude with  $c' = c$ ,  $\mathcal{R}' = \mathcal{R}$  and  $\text{LCC}' = \text{LCC}_3\langle \text{LCC}_2\langle \text{LCC}_1\llbracket \beta \setminus^{\alpha'} s' \cdot s \rrbracket \rangle \rangle$ :

$$\mathcal{R}\langle \text{LCC}\langle c \rangle \rangle \quad \mathcal{R} \quad \text{LCC}_3\langle \text{LCC}_2\langle \text{LCC}_1\langle \mathcal{R}\langle c \rangle \rangle \llbracket \beta \setminus^{\alpha} s' \rrbracket \rangle \llbracket \alpha \setminus^{\alpha'} s \rrbracket \rangle$$

$$c \downarrow$$

$$\mathcal{R}'\langle \text{LCC}'\langle c' \rangle \rangle \quad \mathcal{R} \quad \text{LCC}_3\langle \text{LCC}_2\langle \text{LCC}_1\langle \mathcal{R}'\langle c' \rangle \rangle \llbracket \beta \setminus^{\alpha'} s' \cdot s \rrbracket \rangle \rangle$$

$$c \downarrow$$

- (5) **W**. Then there are two further cases.

- (a) It overlaps with  $c$ . Then we have  $c = \text{LCC}_1\langle c_1 \llbracket \beta \setminus^{\alpha} \alpha \rrbracket \rangle$ ,  $\text{LCC} = \text{LCC}_3\langle \text{LCC}_2\llbracket \alpha \setminus^{\alpha'} s \rrbracket \rangle$  and the rule **W** applies to  $\text{LCC}_2\langle \text{LCC}_1\langle c_1 \llbracket \beta \setminus^{\alpha} \alpha \rrbracket \rangle \rangle \llbracket \alpha \setminus^{\alpha'} s \rrbracket$ . We conclude by setting  $c' = \text{LCC}_1\langle c \llbracket \beta \setminus^{\alpha} s \rrbracket \llbracket \alpha \setminus^{\alpha'} \alpha \rrbracket \rangle$ ,  $\mathcal{R}' = \mathcal{R}$  and  $\text{LCC}' = \text{LCC}_3\langle \text{LCC}_2 \rangle$ :

$$\mathcal{R}\langle \text{LCC}\langle c \rangle \rangle \quad \mathcal{R} \quad \text{LCC}_3\langle \text{LCC}_2\langle \mathcal{R}\langle \text{LCC}_1\langle c_1 \llbracket \beta \setminus^{\alpha} \alpha \rrbracket \rangle \rangle \rangle \llbracket \alpha \setminus^{\alpha'} s \rrbracket \rangle$$

$$w \downarrow$$

$$\mathcal{R}'\langle \text{LCC}'\langle c' \rangle \rangle \quad \mathcal{R} \quad \text{LCC}_3\langle \text{LCC}_2\langle \mathcal{R}'\langle \text{LCC}_1\langle c \llbracket \beta \setminus^{\alpha} s \rrbracket \llbracket \alpha \setminus^{\alpha'} \alpha \rrbracket \rangle \rangle \rangle$$

$$w \downarrow$$

- (b) It does not overlap with  $c$ . Then,  $\text{LCC} = \text{LCC}_3\langle \text{LCC}_2\langle \text{LCC}_1\llbracket \beta \setminus^{\alpha} \alpha \rrbracket \rangle \llbracket \alpha \setminus^{\alpha'} s \rrbracket \rangle$ . We conclude with  $c' = c$ ,  $\mathcal{R}' = \mathcal{R}$  and  $\text{LCC}' = \text{LCC}_3\langle \text{LCC}_2\langle \text{LCC}_1\llbracket \beta \setminus^{\alpha} s \rrbracket \llbracket \alpha \setminus^{\alpha'} \alpha \rrbracket \rangle \rangle$ :

$$\mathcal{R}\langle \text{LCC}\langle c \rangle \rangle \quad \mathcal{R} \quad \text{LCC}_3\langle \text{LCC}_2\langle \text{LCC}_1\langle \mathcal{R}\langle c \rangle \rangle \llbracket \beta \setminus^{\alpha} \alpha \rrbracket \rangle \llbracket \alpha \setminus^{\alpha'} s \rrbracket \rangle$$

$$w \downarrow$$

$$\mathcal{R}'\langle \text{LCC}'\langle c' \rangle \rangle \quad \mathcal{R} \quad \text{LCC}_3\langle \text{LCC}_2\langle \text{LCC}_1\langle \mathcal{R}'\langle c' \rangle \rangle \llbracket \beta \setminus^{\alpha} s \rrbracket \llbracket \alpha \setminus^{\alpha'} \alpha \rrbracket \rangle \rangle$$

$$w \downarrow$$

- There are no further cases.

□

**Lemma 7.7.**



- (1) Let  $t \in \mathbb{T}_{\Lambda M}$ . Then,  $\mathcal{P}(L\langle LTT\langle t \rangle \rangle) \simeq \mathcal{P}(LTT\langle L\langle t \rangle \rangle)$  if  $\text{bv}(L) \notin LTT$  and  $\text{fc}(L, LTT)$ .  
(2) Let  $c \in \mathbb{C}_{\Lambda M}$ . Then,  $\mathcal{P}(R\langle LCC\langle c \rangle \rangle) \simeq \mathcal{P}(LCC\langle R\langle c \rangle \rangle)$  if  $\text{bn}(R) \notin LCC$  and  $\text{fc}(R, LCC)$ .

*Proof.*

- (1) Let  $L\langle LTT\langle t \rangle \rangle \in \mathbb{T}_{\Lambda M}$  with  $\text{bv}(L) \notin LTT$  and  $\text{fc}(L, LTT)$ . By resorting to Lem. E.1, we get  $\langle L\langle LTT\langle t \rangle \rangle, LTT\langle L\langle t \rangle \rangle \rangle \in \mathcal{S}$ . Moreover,  $\mathcal{S}$  is a strong bisimulation w.r.t. the plain computation. Then,  $\mathcal{P}(L\langle LTT\langle t \rangle \rangle) = L'\langle LTT'\langle t' \rangle \rangle$ . Similarly,  $\mathcal{P}(LTT\langle L\langle t \rangle \rangle) = LTT'\langle L'\langle t' \rangle \rangle$ . By a simple induction on  $L$  using  $\simeq_{\text{exsubs}}$  we conclude  $L'\langle LTT'\langle t' \rangle \rangle \simeq LTT'\langle L'\langle t' \rangle \rangle$ .  
(2) Let  $R\langle LCC\langle c \rangle \rangle \in \mathbb{C}_{\Lambda M}$  with  $\text{bn}(R) \notin LCC$  and  $\text{fc}(R, LCC)$ . By resorting to Lem. E.2, we get  $\langle R\langle LCC\langle c \rangle \rangle, LCC\langle R\langle c \rangle \rangle \rangle \in \mathcal{R}$ . Moreover,  $\mathcal{R}$  is a strong bisimulation w.r.t. the plain computation. Then,  $\mathcal{P}(R\langle LCC\langle c \rangle \rangle) = R'\langle LCC'\langle c' \rangle \rangle$ . Similarly,  $\mathcal{P}(LCC\langle R\langle c \rangle \rangle) = LCC'\langle R'\langle c' \rangle \rangle$ . By a simple induction on  $R$  using  $\simeq_{\text{exrep1}}$  we conclude  $R'\langle LCC'\langle c' \rangle \rangle \simeq LCC'\langle R'\langle c' \rangle \rangle$ .  $\square$

## APPENDIX F. STRONG BISIMULATION RESULT

**Lemma F.1.** *Let  $o, o' \in \mathbb{O}_{\Lambda M}$  such that  $o \simeq_* o'$  with  $\simeq_*$  any rule from Fig. 13. If  $o = LXC\langle c \rangle$  for some  $LXC$  and some  $c$ , with  $\mathbf{x} \in \{\mathbf{T}, \mathbf{C}\}$ ,  $\alpha \notin LXC$ ,  $\text{fc}(\alpha', LXC)$  and  $\text{fc}(s, LXC)$ , then there exist  $LXC'$  and  $c'$  such that  $o' = LXC'\langle c' \rangle$  with  $\alpha \notin LXC'$ ,  $\text{fc}(\alpha', LXC')$ ,  $\text{fc}(s, LXC')$  and  $\mathcal{P}(LXC\langle c[\alpha \setminus \alpha' s] \rangle) \simeq \mathcal{P}(LXC'\langle c'[\alpha \setminus \alpha' s] \rangle)$ .*

*Proof.* By cases on  $LXC$ . We only illustrate one of the base cases, namely when  $LXC = \square$ , the others being similar. In the case that  $LXC = \square$ , we must have  $o = c$ . There are four possible rules for commands:  $\simeq_{\text{exrep1}}$ ,  $\simeq_{\text{exren}}$ ,  $\simeq_{\text{ppop}}$ , and  $\simeq_{\text{p}}$ . The first two follow by using 7.7 (2), the last one is direct. We provide details on the  $\simeq_{\text{ppop}}$  case.

- $\simeq_{\text{ppop}}$ . Then,  $o = [\gamma'] \lambda x. \mu \gamma. [\delta'] \lambda y. \mu \delta. c_0$  and  $o' = [\delta'] \lambda y. \mu \delta. [\gamma'] \lambda x. \mu \gamma. c_0$  with  $\delta \neq \gamma'$  and  $\gamma \neq \delta'$ . By  $\alpha$ -conversion we also assume  $x \notin s$ ,  $y \notin s$ ,  $\gamma \neq \alpha'$ ,  $\gamma \notin s$ ,  $\delta \neq \alpha'$  and  $\delta \notin s$ . Then, there are four possible cases.

- (1)  $o[\alpha \setminus \alpha' s] \rightarrow_{\text{N}} [\alpha'] (\lambda x. \mu \gamma. [\delta'] \lambda y. \mu \delta. c_0) :: s$  (i.e.  $\alpha = \gamma'$ ,  $\alpha \neq \delta'$  and  $\gamma' \notin c_0$ ). Assume  $s = u \cdot s'$  (the case  $s = u$  is slightly simpler) and consider fresh names  $\gamma'', \delta''$ . Then,  $\mathcal{P}(o[\alpha \setminus \alpha' s]) = \mathcal{P}([\alpha'] (\mu \gamma''. ([\delta'] \lambda y. \mu \delta. c_0) [\gamma \setminus \gamma'' s'])[x \setminus u])$ . Similarly,  $\mathcal{P}(o'[\alpha \setminus \alpha' s]) = \mathcal{P}([\delta'] \lambda y. \mu \delta. [\alpha'] (\mu \gamma''. c_0 [\gamma \setminus \gamma'' s'])[x \setminus u])$ . In the case  $s = u$  we simply avoid explicit replacement. Then, by Lem. 7.7, we have on the one hand

$$\mathcal{P}(o[\alpha \setminus \alpha' s]) \simeq \mathcal{P}([\alpha'] \mu \gamma''. [\delta'] (\lambda y. \mu \delta. c_0 [\gamma \setminus \gamma'' s'])[x \setminus u])$$

and on the other hand

$$\mathcal{P}(o'[\alpha \setminus \alpha' s]) \simeq \mathcal{P}([\delta'] (\lambda y. \mu \delta. [\alpha'] \mu \gamma''. c_0 [\gamma \setminus \gamma'' s'])[x \setminus u])$$

resorting to item (1) of the lemma that positions explicit substitutions and item (2) on explicit replacement. Finally, applying  $\simeq_{\text{p}}$  twice and Lem. 7.7 (2) we can adequately

position the explicit renaming introduced by the rule and deduce:

$$\begin{aligned}
\mathcal{P}(o[\alpha \setminus^{\alpha'} s]) &\simeq \mathcal{P}([\alpha'] \mu \gamma''. [\delta'] (\lambda y. \mu \delta. c_0 [\gamma \setminus^{\gamma''} s']) [x \setminus u]) \\
&= [\alpha'] \mu \gamma''. [\delta'] (\lambda y. \mu \delta. \mathcal{P}(c_0 [\gamma \setminus^{\gamma''} s'])) [x \setminus \mathcal{P}(u)] \\
&\simeq_{\mathcal{P}} ([\delta'] (\lambda y. \mu \delta. \mathcal{P}(c_0 [\gamma \setminus^{\gamma''} s']))) [x \setminus \mathcal{P}(u)] [\gamma'' \setminus \alpha'] \\
&\simeq [\delta'] (\lambda y. \mu \delta. \mathcal{P}(c_0 [\gamma \setminus^{\gamma''} s'])) [\gamma'' \setminus \alpha'] [x \setminus \mathcal{P}(u)] \\
&\simeq_{\mathcal{P}} [\delta'] (\lambda y. \mu \delta. [\alpha'] \mu \gamma''. \mathcal{P}(c_0 [\gamma \setminus^{\gamma''} s']))) [x \setminus \mathcal{P}(u)] \\
&= \mathcal{P}([\delta'] (\lambda y. \mu \delta. [\alpha'] \mu \gamma''. c_0 [\gamma \setminus^{\gamma''} s'])) [x \setminus u] \\
&\simeq \mathcal{P}(o'[\alpha \setminus^{\alpha'} s])
\end{aligned}$$

We conclude with  $\text{LXC}' = \square$  and  $c' = o'$ .

- (2)  $o[\alpha \setminus^{\alpha'} s] \rightarrow_{\mathbb{N}} [\gamma'] \lambda x. \mu \gamma. [\alpha'] (\lambda y. \mu \delta. c_0) :: s$  (i.e.  $\alpha \neq \gamma'$ ,  $\alpha = \delta'$  and  $\delta' \notin c_0$ ). Similar to the previous case.
- (3)  $o[\alpha \setminus^{\alpha'} s] \rightarrow_{\mathbb{N}, \mathcal{C}, \mathbb{W}} [\gamma'] \lambda x. \mu \gamma. [\delta'] \lambda y. \mu \delta. c'_0$  (i.e.  $\text{fn}_{\alpha}(o) = 1$ ,  $\alpha \neq \gamma'$  and  $\alpha \neq \delta'$ ). Then,  $\mathcal{P}(o[\alpha \setminus^{\alpha'} s]) = [\gamma'] \lambda x. \mu \gamma. [\delta'] \lambda y. \mu \delta. \mathcal{P}(c'_0) \simeq_{\text{ppop}} [\delta'] \lambda y. \mu \delta. [\gamma'] \lambda x. \mu \gamma. \mathcal{P}(c'_0) = \mathcal{P}(o'[\alpha \setminus^{\alpha'} s])$ . We conclude with  $\text{LXC}' = \square$  and  $c' = o'$ .
- (4) Otherwise,  $\mathcal{P}(o[\alpha \setminus^{\alpha'} s]) = o[\alpha \setminus^{\alpha'} \mathcal{P}(s)] \simeq o'[\alpha \setminus^{\alpha'} \mathcal{P}(s)] = \mathcal{P}(o'[\alpha \setminus^{\alpha'} s])$ , since  $o \simeq o'$  implies  $\mathcal{P}(o) = o$  and  $\mathcal{P}(o') = o'$ . We conclude with  $\text{LXC}' = \square$  and  $c' = o'$ .

□

**Lemma F.2.** *Let  $o, o' \in \mathbb{O}_{\Lambda M}$  such that  $o \simeq o'$ .*

- (1) *If  $o, o' \in \mathbb{T}_{\Lambda M}$ , then  $\mathcal{P}(o :: s) \simeq \mathcal{P}(o' :: s)$ .*
- (2) *If  $o, o' \in \mathbb{C}_{\Lambda M}$ , then  $\mathcal{P}(o[\alpha \setminus^{\alpha'} s]) \simeq \mathcal{P}(o'[\alpha \setminus^{\alpha'} s])$ .*

*Proof.* We prove both items by simultaneous induction on  $o \simeq o'$ . The cases where  $o \simeq o'$  holds by reflexivity, transitivity or symmetry are straightforward. For congruence, we reason by induction on the context  $\mathbb{O}$  such that  $o = \mathbb{O}\langle p \rangle$  and  $o' = \mathbb{O}\langle p' \rangle$  with  $p \simeq_* p'$ , where  $\simeq_*$  is an axiom in Fig. 13.

- $\mathbb{O} = \square$ . Then there are only two possible cases which are  $\simeq_{\text{exsubs}}$  and  $\simeq_{\theta}$ . Then we conclude by Lem. 7.7 in the former case, and straightforwardly in the latter.
- $\mathbb{O} = \square$ . We conclude by Lem. F.1 and Lem. 7.7.
- Cases  $\mathbb{O} = \mathbb{T}v$ ,  $\mathbb{O} = t\mathbb{T}$  and  $\mathbb{O} = \mu\gamma.\mathbb{C}$  are immediate by the *i.h.*
- In cases  $\mathbb{O} = \lambda x.\mathbb{T}$ ,  $\mathbb{O} = \mathbb{T}[x \setminus v]$ ,  $\mathbb{O} = t[x \setminus \mathbb{T}]$ ,  $\mathbb{O} = \mathbb{C}[\gamma \setminus^{\delta} s']$ ,  $\mathbb{O} = c[\gamma \setminus^{\delta} \mathbb{S}]$ ,  $\mathbb{O} = \mathbb{C}[\gamma \setminus \delta]$ ,  $\mathbb{O} = \mathbb{T} \cdot s$  and  $\mathbb{O} = t \cdot \mathbb{S}$  we conclude by the *i.h.* and Lem. 7.7.
- $\mathbb{O} = [\delta]\mathbb{T}$ . Then  $o = [\delta]\mathbb{T}\langle p \rangle$  and  $o' = [\delta]\mathbb{T}\langle p' \rangle$ . Let  $t = \mathbb{T}\langle p \rangle$  and  $t' = \mathbb{T}\langle p' \rangle$ . We then have  $t \simeq t'$  and we consider three possible cases:
  - (1)  $\alpha = \delta$  and  $\alpha \notin t$ . We conclude by the *i.h.*
  - (2)  $o[\alpha \setminus^{\alpha'} s] \rightarrow_{\mathbb{N}, \mathcal{C}, \mathbb{W}} [\delta]u$  (i.e.  $\alpha \neq \delta$  and  $\alpha \in t$ ). There are two cases:
    - (a)  $u = \mathbb{T}'\langle p \rangle$  for some  $\mathbb{T}'$ . Then we conclude by the *i.h.*
    - (b)  $u = \mathbb{T}\langle q \rangle$  for some  $q$ . Then there is a linear context  $\text{LTC}$  such that  $\text{LTC} = \text{LTX}\langle \text{LXC} \rangle$ ,  $\mathbb{T} = \text{LTX}$  and  $p = \text{LXC}\langle c \rangle$  with  $\alpha \neq \delta$ ,  $\alpha \notin \text{LTC}$  and  $\alpha \in c$ . By  $\alpha$ -conversion we assume  $\text{fc}(\alpha', \text{LTC})$  and  $\text{fc}(s, \text{LTC})$ , so that  $c[\alpha \setminus^{\alpha'} s] \rightarrow_{\mathbb{N}, \mathcal{C}, \mathbb{W}} q$ . Then, by Lem. F.1 with  $p \simeq_* p'$  we have  $p' = \text{LXC}'\langle c' \rangle$  such that  $\alpha \notin \text{LXC}'$ ,  $\text{fc}(\alpha', \text{LXC}')$ ,  $\text{fc}(s, \text{LXC}')$  and  $\mathcal{P}(\text{LXC}\langle c[\alpha \setminus^{\alpha'} s] \rangle) \simeq \mathcal{P}(\text{LXC}'\langle c'[\alpha \setminus^{\alpha'} s] \rangle)$ . Finally,  $o = [\delta]\mathbb{T}\langle p \rangle = [\delta]\text{LTX}\langle \text{LXC}\langle c \rangle \rangle$

and  $o' = [\delta] \mathsf{T}\langle p' \rangle = [\delta] \mathsf{LTX}\langle \mathsf{LXC}'\langle c' \rangle \rangle$ , and by Lem. 7.7 (2), we conclude

$$\begin{aligned} \mathcal{P}(o[\alpha \setminus^{\alpha'} s]) &\simeq \mathcal{P}([\delta] \mathsf{LTX}\langle \mathsf{LXC}\langle c[\alpha \setminus^{\alpha'} s] \rangle \rangle) \\ &= [\delta] \mathsf{LTX}\langle \mathcal{P}(\mathsf{LXC}\langle c[\alpha \setminus^{\alpha'} s] \rangle) \rangle \\ &\simeq [\delta] \mathsf{LTX}\langle \mathcal{P}(\mathsf{LXC}'\langle c'[\alpha \setminus^{\alpha'} s] \rangle) \rangle \\ &= \mathcal{P}([\delta] \mathsf{LTX}\langle \mathsf{LXC}'\langle c'[\alpha \setminus^{\alpha'} s] \rangle \rangle) \\ &\simeq \mathcal{P}(o'[\alpha \setminus^{\alpha'} s]) \end{aligned}$$

- (3) Otherwise,  $\mathcal{P}(o[\alpha \setminus^{\alpha'} s]) = o[\alpha \setminus^{\alpha'} \mathcal{P}(s)] \simeq o'[\alpha \setminus^{\alpha'} \mathcal{P}(s)] = \mathcal{P}(o'[\alpha \setminus^{\alpha'} s])$ , since  $o \simeq o'$  implies  $\mathcal{P}(o) = o$  and  $\mathcal{P}(o') = o'$ . □

**Lemma 7.6.** *Let  $o \in \mathcal{O}_{\Lambda M}$ . If  $o \simeq o'$ , then for all context  $\mathbb{0}$  of appropriate sort,  $\mathcal{P}(\mathbb{0}\langle o \rangle) \simeq \mathcal{P}(\mathbb{0}\langle o' \rangle)$ .*

*Proof.* By induction on  $\text{sz}(\mathbb{0})$ , where  $\text{sz}(\_)$  measures the size of contexts, *i.e.* its number of constructors (excluding  $\square$  and  $\boxplus$ ).

- $\mathbb{0} = \square$  and  $\mathbb{0} = \boxplus$ . Immediate since  $o \simeq o'$  implies  $\mathcal{P}(o) = o$  and  $\mathcal{P}(o') = o'$  by definition.
- $\mathbb{0} = \mathsf{T}u$ . We conclude by the *i.h.* and Lem. F.2 (1).
- $\mathbb{0} = \mathsf{C}[\alpha \setminus^{\alpha'} s]$ . We conclude by the *i.h.* and Lem. F.2 (2).
- In all the other cases we conclude by the *i.h.* □

**Lemma F.3.** *Let  $o, o' \in \mathcal{O}_{\Lambda M}$  and  $u, u' \in \mathbb{T}_{\Lambda M}$  such that  $o \simeq o'$  and  $u \simeq u'$ .*

- (1) *Then,  $\mathcal{P}(o\{x \setminus u\}) \simeq \mathcal{P}(o'\{x \setminus u\})$ .*
- (2) *Then,  $\mathcal{P}(o\{x \setminus u\}) \simeq \mathcal{P}(o\{x \setminus u'\})$ .*

*Proof.* (1) By induction on  $o \simeq o'$  which, by definition, implies verifying the cases for reflexivity, transitivity, symmetry and congruence (*i.e.* closure by contexts). All are straightforward but the latter.

For congruence we proceed by induction on the closure context  $\mathbb{0}$  such that  $o = \mathbb{0}\langle p \rangle$  and  $o' = \mathbb{0}\langle p' \rangle$  with  $p \simeq_* p'$ , where  $\simeq_*$  is any rule from Fig. 13.

- $\mathbb{0} = \square$ . Then,  $o = p \simeq_* p' = o'$ . Moreover,  $o, o' \in \mathbb{T}_{\Lambda M}$ . Only two rules are applicable to terms:
    - $\simeq_{\text{exsubs}}$ . Follows from Lem. 7.7 (1).
    - $\simeq_{\theta}$ . Straightforward.
  - $\mathbb{0} = \boxplus$ . Then,  $o = p \simeq_* p' = o'$ . Moreover, we have  $o, o' \in \mathbb{C}_{\Lambda M}$ . Four rules are applicable to commands:
    - $\simeq_{\text{exrep1}}$  and  $\simeq_{\text{exren}}$ . Follows from Lem. 7.7 (2).
    - $\simeq_{\text{ppop}}$  and  $\simeq_{\text{p}}$ . Straightforward.
  - $\mathbb{0} = \mathsf{T}v$  and  $\mathbb{0} = t\mathsf{T}$ . Both follow from the *i.h.* and Lem. 7.6.
  - All the remaining cases follow from the *i.h.*
- (2) By induction on  $o$ . All cases are by the *i.h.* except for  $o = tv$  which resorts to Lem. 7.6. □

**Lemma F.4.** *Let  $o, o', s, s' \in \mathcal{O}_{\Lambda M}$  with  $s$  and  $s'$  stacks such that  $o \simeq o'$  and  $s \simeq s'$ .*

- (1) *Then,  $\mathcal{P}(o\{\{\alpha \setminus^{\alpha'} s\}\}) \simeq \mathcal{P}(o'\{\{\alpha \setminus^{\alpha'} s\}\})$ .*
- (2) *Then,  $\mathcal{P}(o\{\{\alpha \setminus^{\alpha'} s\}\}) \simeq \mathcal{P}(o\{\{\alpha \setminus^{\alpha'} s'\}\})$ .*

*Proof.* (1) By induction on  $o \simeq o'$ . By definition this implies verifying four conditions: reflexivity, transitivity, symmetry and congruence (*i.e.* closure under contexts). All but the latter are immediate; we thus focus on the latter.

Congruence is proved by induction on the closure context  $\mathbb{0}$  such that  $o = \mathbb{0}\langle p \rangle$  and  $o' = \mathbb{0}\langle p' \rangle$  with  $p \simeq_* p'$ , where  $\simeq_*$  is any rule from Fig. 13.

- $\mathbb{0} = \square$ . Follows from Lem. 7.7 (1).
- $\mathbb{0} = \square$ . Then,  $o = p \simeq_* p' = o'$ . Moreover,  $o, o' \in \mathbb{C}_{\Lambda M}$ . Five rules are applicable to commands:

- $\simeq_{\text{exrep1}}$  and  $\simeq_{\text{exren}}$ . Follow from Lem. 7.7 (2).
- $\simeq_{\text{ppop}}$ . Then,  $o = [\gamma'] \lambda x. \mu \gamma. [\delta'] \lambda y. \mu \delta. c$  and  $o' = [\delta'] \lambda y. \mu \delta. [\gamma'] \lambda x. \mu \gamma. c$  with  $\delta \neq \gamma'$  and  $\gamma \neq \delta'$ . Without loss of generality, we also assume  $x \notin s$ ,  $y \notin s$ ,  $\gamma \neq \alpha'$ ,  $\delta \neq \alpha'$ ,  $\gamma \notin s$  and  $\delta \notin s$ . There are four possible subcases:

- (a)  $\gamma' = \alpha$  and  $\delta' = \alpha$ . Then,  $o\{\{\alpha \setminus \alpha' s\}\} = [\alpha'] (\lambda x. \mu \gamma. [\alpha'] (\lambda y. \mu \delta. c') :: s) :: s$  and  $o'\{\{\alpha \setminus \alpha' s\}\} = [\alpha'] (\lambda y. \mu \delta. [\alpha'] (\lambda x. \mu \gamma. c') :: s) :: s$  with  $c' = c\{\{\alpha \setminus \alpha' s\}\}$ . Suppose  $s = u \cdot s'$  (the case  $s = u$  is slightly simpler) and consider fresh names  $\gamma'', \delta''$ . Then,

$$\mathcal{P}(o\{\{\alpha \setminus \alpha' s\}\}) = \mathcal{P}([\alpha'] (\mu \gamma''. ([\alpha'] (\mu \delta''. c' [\delta \setminus \delta'' s']) [y \setminus u]) [\gamma \setminus \gamma'' s']) [x \setminus u])$$

where the explicit substitutions result from contracting the dB-redexes in  $u$  and the explicit replacements result from contracting the dM-redexes in  $s'$  followed by the resulting C-redexes. If  $s = u$ , then there are no dM-redexes to contract, and there are only explicit substitutions. Similarly,

$$\mathcal{P}(o'\{\{\alpha \setminus \alpha' s\}\}) = \mathcal{P}([\alpha'] (\mu \delta''. ([\alpha'] (\mu \gamma''. c' [\gamma \setminus \gamma'' s']) [x \setminus u]) [\delta \setminus \delta'' s']) [y \setminus u])$$

Let  $c'' = c' [\gamma \setminus \gamma'' s'] [\delta \setminus \delta'' s']$ . Then by Lem. 7.7, on the one hand we have:  $\mathcal{P}(o\{\{\alpha \setminus \alpha' s\}\}) \simeq \mathcal{P}([\alpha'] \mu \gamma''. ([\alpha'] (\mu \delta''. c'') [x \setminus u] [y \setminus u]))$ , and on the other hand we have:  $\mathcal{P}(o'\{\{\alpha \setminus \alpha' s\}\}) \simeq \mathcal{P}([\alpha'] \mu \delta''. ([\alpha'] (\mu \gamma''. c'') [x \setminus u] [y \setminus u]))$ ; resorting to item (1) of that lemma to position the explicit substitutions and item (2) for the explicit replacements. We then conclude by applying  $\simeq_{\text{P}}$  twice and Lem. 7.7 (2) to correctly position the explicit renaming introduced by the rule

$$\begin{aligned} \mathcal{P}(o\{\{\alpha \setminus \alpha' s\}\}) &\simeq \mathcal{P}([\alpha'] \mu \gamma''. ([\alpha'] (\mu \delta''. c'') [x \setminus u] [y \setminus u])) \\ &= [\alpha'] \mu \gamma''. ([\alpha'] (\mu \delta''. \mathcal{P}(c'')) [x \setminus \mathcal{P}(u)] [y \setminus \mathcal{P}(u)]) \\ &\simeq_{\text{P}} ([\alpha'] (\mu \delta''. \mathcal{P}(c'')) [x \setminus \mathcal{P}(u)] [y \setminus \mathcal{P}(u)]) [\gamma'' \setminus \alpha'] \\ &\simeq [\alpha'] (\mu \delta''. \mathcal{P}(c'') [\gamma'' \setminus \alpha']) [x \setminus \mathcal{P}(u)] [y \setminus \mathcal{P}(u)] \\ &\simeq_{\text{P}} [\alpha'] (\mu \delta''. ([\alpha'] \mu \gamma''. \mathcal{P}(c'')) [x \setminus \mathcal{P}(u)] [y \setminus \mathcal{P}(u)]) \\ &= \mathcal{P}([\alpha'] \mu \delta''. ([\alpha'] (\mu \gamma''. c'') [x \setminus u] [y \setminus u])) \\ &\simeq \mathcal{P}(o'\{\{\alpha \setminus \alpha' s\}\}) \end{aligned}$$

- (b)  $\gamma' = \alpha$  and  $\delta' \neq \alpha$ , and the case  $\gamma' \neq \alpha$  and  $\delta' = \alpha$ . Similar to the previous case.

- (c)  $\gamma' \neq \alpha$  and  $\delta' \neq \alpha$ . Straightforward.

- $\simeq_{\text{P}}$ . Then,  $o = [\delta] \mu \gamma. c$  and  $o' = c [\gamma \setminus \delta]$ . Without loss of generality, we assume  $\gamma \neq \alpha'$  and  $\gamma \notin s$ . There are two possible subcases:

- (a)  $\delta = \alpha$ . Then,  $o\{\{\alpha \setminus \alpha' s\}\} = [\alpha] (\mu \gamma. c') :: s$  and  $o'\{\{\alpha \setminus \alpha' s\}\} = c' [\gamma \setminus \gamma' s] [\gamma' \setminus \alpha']$  with  $c' = c\{\{\alpha \setminus \alpha' s\}\}$  and  $\gamma'$  a fresh name. Moreover,  $\mathcal{P}(o\{\{\alpha \setminus \alpha' s\}\}) = \mathcal{P}([\alpha'] \mu \gamma'. c' [\gamma \setminus \gamma' s])$ , where the explicit replacement results from contracting the dM-redexes in  $s$  followed by the possible resulting C-redexes. Then, we

conclude from  $\mathcal{P}(o\{\alpha \setminus^{\alpha'} s\}) = [\alpha']\mu\gamma'.\mathcal{P}(c'[\gamma \setminus^{\gamma'} s]) \simeq_{\mathcal{P}} \mathcal{P}(c'[\gamma \setminus^{\gamma'} s])[\gamma' \setminus^{\alpha'}] = \mathcal{P}(o'\{\alpha \setminus^{\alpha'} s\})$ .

(b)  $\delta \neq \alpha$ . Then,  $o\{\alpha \setminus^{\alpha'} s\} = [\delta]\mu\gamma.c'$  and  $o'\{\alpha \setminus^{\alpha'} s\} = c'[\gamma \setminus \delta]$  with  $c' = c\{\alpha \setminus^{\alpha'} s\}$ . We thus conclude since  $\mathcal{P}(o\{\alpha \setminus^{\alpha'} s\}) = [\delta]\mu\gamma.\mathcal{P}(c') \simeq_{\mathcal{P}} \mathcal{P}(c')[\gamma \setminus \delta] = \mathcal{P}(o'\{\alpha \setminus^{\alpha'} s\})$ .

- $\mathbf{0} = \mathbf{T}u$  and  $\mathbf{0} = t\mathbf{T}$ . Follow from Lem. 7.6.
- $\mathbf{0} = \lambda x.\mathbf{T}$ ,  $\mathbf{0} = \mu\gamma.\mathbf{C}$ ,  $\mathbf{0} = \mathbf{T}[x \setminus u]$ , and  $\mathbf{0} = t[x \setminus \mathbf{T}]$ . Similar to the previous case.
- $\mathbf{0} = [\gamma]\mathbf{T}$ . If  $\gamma = \alpha$  it follows from Lem. 7.6, otherwise from the *i.h.*
- $\mathbf{0} = \mathbf{C}[\gamma \setminus^{\delta} s']$  and  $\mathbf{0} = c[\gamma \setminus^{\delta} \mathbf{S}]$ . By the *i.h.*
- $\mathbf{0} = \mathbf{C}[\gamma \setminus \delta]$ . If  $\delta = \alpha$  then it follows from Lem. 7.6, otherwise we use the *i.h.*
- $\mathbf{0} = \mathbf{T} \cdot s'$  and  $\mathbf{0} = t \cdot \mathbf{S}$ . We use the *i.h.*

(2) By induction on  $o$ . All cases follow from the *i.h.* and/or Lem. 7.6. □

**Lemma 7.9.** *Let  $u, s, o \in \mathcal{O}_{\Delta M}$  in  $\mathcal{P}$ -normal form such that  $o \simeq o'$ ,  $u \simeq u'$  and  $s \simeq s'$ , where  $u, u'$  are terms and  $s, s'$  are stacks. Then,*

- (1)  $\mathcal{P}(o\{x \setminus u\}) \simeq \mathcal{P}(o'\{x \setminus u\})$  and  $\mathcal{P}(o\{x \setminus u\}) \simeq \mathcal{P}(o\{x \setminus u'\})$ .
- (2)  $\mathcal{P}(o\{\alpha \setminus^{\alpha'} s\}) \simeq \mathcal{P}(o'\{\alpha \setminus^{\alpha'} s\})$  and  $\mathcal{P}(o\{\alpha \setminus^{\alpha'} s\}) \simeq \mathcal{P}(o\{\alpha \setminus^{\alpha'} s'\})$ .

*Proof.* By Lem. F.3 and F.4, resp. □

**Theorem 7.10.** *Let  $o \in \mathcal{O}_{\Delta M}$ . If  $o \simeq p$  and  $o \rightsquigarrow o'$ , then there exists  $p'$  such that  $p \rightsquigarrow p'$  and  $o' \simeq p'$ .*

*Proof.* By induction on  $o \simeq p$ . By definition this requires verifying four cases: reflexivity, transitivity, symmetry and congruence (*i.e.* closure under contexts). The cases where  $o \simeq p$  holds by reflexivity or transitivity are straightforward. We focus on the other two, which are dealt with simultaneously by induction on the closure context  $\mathbf{Q}$  such that  $o = \mathbf{Q}\langle q \rangle$  and  $p = \mathbf{Q}\langle q' \rangle$  with  $q \simeq_* q'$ , where  $\simeq_*$  is any rule in Fig. 13. Note that  $o \rightsquigarrow o'$  implies  $o = \mathbf{0}\langle l \rangle$  and  $o' = \mathcal{P}(\mathbf{0}\langle r \rangle)$  with  $l \mapsto_* r$ ,  $* \in \{\mathbf{S}, \mathbf{R}^\bullet\}$ . We thus consider all possible forms for  $\mathbf{Q}$  and  $\mathbf{0}$ :

- $\mathbf{Q} = \square$ . Then  $o = q \simeq_* q' = p$ . Moreover, in this case  $o, p \in \mathbb{T}_{\Delta M}$ . Only two rules are applicable to terms:

–  $\simeq_{\text{exsubs}}$ . Then,  $o = \text{LTT}\langle t \rangle[x \setminus u]$  and  $p = \text{LTT}\langle t[x \setminus u] \rangle$  with  $x \notin \text{LTT}$  and  $\text{fc}(u, \text{LTT})$ .

There are three further possible cases:

- (1) **S**-redex at the root.

$$\begin{array}{ccc} o = \text{LTT}\langle t \rangle[x \setminus u] & \simeq_{\text{exsubs}} & \text{LTT}\langle t[x \setminus u] \rangle = p \\ \text{s}\{\} & & \text{s}\{\} \\ o' = \mathcal{P}(\text{LTT}\langle t \rangle\{x \setminus u\}) & = & \mathcal{P}(\text{LTT}\langle t \rangle\{x \setminus u\}) = p' \end{array}$$

- (2) **S**-redex overlaps **LTT**. Then we have  $\text{LTT} = \text{LTT}_1\langle \text{LTT}_2[y \setminus v] \rangle$  with commands  $o' = \text{LTT}_1\langle \text{LTT}_2\langle t \rangle\{y \setminus v\} \rangle[x \setminus u] = \text{LTT}_1\langle \text{LTT}'_2\langle t' \rangle \rangle[x \setminus u]$  and  $p' = \text{LTT}_1\langle \text{LTT}'_2\langle t' \rangle[x \setminus u] \rangle$  since  $\text{fc}(u, \text{LTT})$  implies  $y \notin u$ . We conclude by Lem. 7.7 (1):

$$\begin{array}{ccc} o = \text{LTT}_1\langle \text{LTT}_2\langle t \rangle\{y \setminus v\} \rangle[x \setminus u] & \simeq_{\text{exsubs}} & \text{LTT}_1\langle \text{LTT}_2\langle t[x \setminus u] \rangle\{y \setminus v\} \rangle = p \\ \text{s}\{\} & & \text{s}\{\} \\ o' = \mathcal{P}(\text{LTT}_1\langle \text{LTT}_2\langle t \rangle\{y \setminus v\} \rangle[x \setminus u]) & \simeq & \mathcal{P}(\text{LTT}_1\langle \text{LTT}_2\langle t[x \setminus u] \rangle\{y \setminus v\} \rangle) = p' \end{array}$$

- (3)  $R^\bullet$ -redex overlaps LTT. Then we have  $LTT = LTC\langle LCT[\alpha \setminus^{\alpha'} s] \rangle$  with commands  $o' = LTC\langle LCT\langle t \rangle \{\{\alpha \setminus^{\alpha'} s\}\} [x \setminus u] = LTC\langle LTC'\langle t' \rangle \rangle [x \setminus u]$  and  $p' = LTC\langle LTC'\langle t' [x \setminus u] \rangle \rangle$  since  $fc(u, LTT)$  implies  $\alpha \notin u$ . We conclude by Lem. 7.7 (1):

$$o = LTC\langle LCT\langle t \rangle \{\{\alpha \setminus^{\alpha'} s\}\} [x \setminus u] \quad \simeq_{\text{exsubs}} \quad LTC\langle LCT\langle t [x \setminus u] \rangle \{\{\alpha \setminus^{\alpha'} s\}\} \rangle = p$$

$$\begin{array}{c} R^\bullet \downarrow \\ R^\bullet \downarrow \end{array}$$

$$o' = \mathcal{P}(LTC\langle LCT\langle t \rangle \{\{\alpha \setminus^{\alpha'} s\}\} [x \setminus u] \rangle) \simeq \mathcal{P}(LTC\langle LCT\langle t [x \setminus u] \rangle \{\{\alpha \setminus^{\alpha'} s\}\} \rangle) = p'$$

–  $\simeq_\theta$ . Then,  $o = \mu\alpha.[\alpha] t$  and  $p = t$  with  $\alpha \notin t$ . This case is immediate since all reduction steps must be in  $t$ .

- $Q = \square$ . Then,  $o = q \simeq_* q' = p$ . Moreover, in this case  $o, p \in \mathbb{C}_{\Lambda M}$ . There are four rules applicable to commands:

–  $\simeq_{\text{exrepl}}$ . Then,  $o = LCC\langle c \rangle [\alpha \setminus^{\alpha'} s]$  and  $p = LCC\langle c [\alpha \setminus^{\alpha'} s] \rangle$  with  $\alpha \notin LCC$ ,  $fc(\alpha', LCC)$  and  $fc(s, LCC)$ . There are three further subcases:

- (1)  $R^\bullet$ -redex at the root.

$$o = LCC\langle c \rangle [\alpha \setminus^{\alpha'} s] \quad \simeq_{\text{exrepl}} \quad LCC\langle c [\alpha \setminus^{\alpha'} s] \rangle = p$$

$$\begin{array}{c} R^\bullet \downarrow \\ R^\bullet \downarrow \end{array}$$

$$o' = \mathcal{P}(LCC\langle c \rangle \{\{\alpha \setminus^{\alpha'} s\}\}) = \mathcal{P}(LCC\langle c [\alpha \setminus^{\alpha'} s] \rangle) = p'$$

- (2)  $S$ -redex overlaps LCC. Then  $LCC = LCT\langle LTC[x \setminus u] \rangle$  with  $o' = LCT\langle LTC\langle c \rangle \{x \setminus u\} \rangle [\alpha \setminus^{\alpha'} s] = LCT\langle LTC'\langle c' \rangle \rangle [\alpha \setminus^{\alpha'} s]$  and  $p' = LCT\langle LTC'\langle c' [\alpha \setminus^{\alpha'} s] \rangle \rangle$  since  $fc(s, LCC)$  implies  $x \notin s$ . We conclude by Lem. 7.7 (2):

$$o = LCT\langle LTC\langle c \rangle \{x \setminus u\} \rangle [\alpha \setminus^{\alpha'} s] \quad \simeq_{\text{exrepl}} \quad LCT\langle LTC\langle c [\alpha \setminus^{\alpha'} s] \rangle \{x \setminus u\} \rangle = p$$

$$\begin{array}{c} s \downarrow \\ s \downarrow \end{array}$$

$$o' = \mathcal{P}(LCT\langle LTC\langle c \rangle \{x \setminus u\} \rangle [\alpha \setminus^{\alpha'} s] \rangle) \simeq \mathcal{P}(LCT\langle LTC\langle c [\alpha \setminus^{\alpha'} s] \rangle \{x \setminus u\} \rangle) = p'$$

- (3)  $R^\bullet$ -redex overlaps LCC. Then  $LCC = LCC_1\langle LCC_2[\gamma \setminus^\delta s'] \rangle$  with commands  $o' = LCC_1\langle LCC_2\langle c \rangle \{\{\gamma \setminus^\delta s'\}\} \rangle [\alpha \setminus^{\alpha'} s] = LCC_1\langle LCC_2'\langle c' \rangle \rangle [\alpha \setminus^{\alpha'} s]$  and  $p' = LCC_1\langle LCC_2'\langle c' [\alpha \setminus^{\alpha'} s] \rangle \rangle$  since  $fc(\alpha, LCC)$  implies  $\gamma \neq \alpha$ , and  $fc(s, LCC)$  implies  $\alpha \notin s$ . We conclude by Lem. 7.7 (2):

$$o = LCC_1\langle LCC_2\langle c \rangle \{\{\gamma \setminus^\delta s'\}\} \rangle [\alpha \setminus^{\alpha'} s] \quad \simeq_{\text{exrepl}} \quad LCC_1\langle LCC_2\langle c [\alpha \setminus^{\alpha'} s] \rangle \{\{\gamma \setminus^\delta s'\}\} \rangle = p$$

$$\begin{array}{c} R^\bullet \downarrow \\ R^\bullet \downarrow \end{array}$$

$$o' = \mathcal{P}(LCC_1\langle LCC_2\langle c \rangle \{\{\gamma \setminus^\delta s'\}\} \rangle [\alpha \setminus^{\alpha'} s] \rangle) \simeq \mathcal{P}(LCC_1\langle LCC_2\langle c [\alpha \setminus^{\alpha'} s] \rangle \{\{\gamma \setminus^\delta s'\}\} \rangle) = p'$$

–  $\simeq_{\text{exren}}$ . Then,  $o = LCC\langle c \rangle [\alpha \setminus \beta]$  and  $p = LCC\langle c [\alpha \setminus \beta] \rangle$  with  $\alpha \notin LCC$  and  $fc(\beta, LCC)$ . There are two further possible cases:

- (1)  $S$ -redex overlaps LCC. Then  $LCC = LCT\langle LTC[x \setminus u] \rangle$  with  $o' = LCT\langle LTC\langle c \rangle \{x \setminus u\} \rangle [\alpha \setminus \beta] = LCT\langle LTC'\langle c' \rangle \rangle [\alpha \setminus \beta]$  and  $p' = LCT\langle LTC'\langle c' [\alpha \setminus \beta] \rangle \rangle$ . We conclude by Lem. 7.7 (2):

$$o = LCT\langle LTC\langle c \rangle \{x \setminus u\} \rangle [\alpha \setminus \beta] \quad \simeq_{\text{exrepl}} \quad LCT\langle LTC\langle c [\alpha \setminus \beta] \rangle \{x \setminus u\} \rangle = p$$

$$\begin{array}{c} s \downarrow \\ s \downarrow \end{array}$$

$$o' = \mathcal{P}(LCT\langle LTC\langle c \rangle \{x \setminus u\} \rangle [\alpha \setminus \beta] \rangle) \simeq \mathcal{P}(LCT\langle LTC\langle c [\alpha \setminus \beta] \rangle \{x \setminus u\} \rangle) = p'$$

- (2)  $\mathbf{R}^\bullet$ -redex overlaps LCC. Then  $\text{LCC} = \text{LCC}_1\langle \text{LCC}_2\llbracket \gamma \setminus^\delta s \rrbracket \rangle$  with commands  $o' = \text{LCC}_1\langle \text{LCC}_2\langle c \rangle \{\{\gamma \setminus^\delta s\}\} \llbracket \alpha \setminus \beta \rrbracket \rangle = \text{LCC}_1\langle \text{LCC}'_2\langle c' \rangle \llbracket \alpha \setminus \beta \rrbracket \rangle$  and  $p' = \text{LCC}_1\langle \text{LCC}'_2\langle c' \llbracket \alpha \setminus \beta \rrbracket \rangle \rangle$  since  $\text{fc}(\alpha, \text{LCC})$  implies  $\gamma \neq \alpha$ . We conclude by Lem. 7.7 (2):

$$o = \text{LCC}_1\langle \text{LCC}_2\langle c \rangle \llbracket \gamma \setminus^\delta s \rrbracket \llbracket \alpha \setminus \beta \rrbracket \rangle \underset{\mathbf{R}^\bullet \wr}{\simeq_{\text{exrep1}}} \text{LCC}_1\langle \text{LCC}_2\langle c \llbracket \alpha \setminus \beta \rrbracket \rangle \llbracket \gamma \setminus^\delta s \rrbracket \rangle = p$$

$$o' = \mathcal{P}(\text{LCC}_1\langle \text{LCC}_2\langle c \rangle \{\{\gamma \setminus^\delta s\}\} \llbracket \alpha \setminus \beta \rrbracket \rangle) \simeq \mathcal{P}(\text{LCC}_1\langle \text{LCC}_2\langle c \llbracket \alpha \setminus \beta \rrbracket \rangle \{\{\gamma \setminus^\delta s\}\} \rangle) = p'$$

- $\simeq_{\text{ppop}}$ . Then,  $o = [\alpha'] \lambda z. \mu \alpha. [\beta'] \lambda y. \mu \beta. c$  and  $p = [\beta'] \lambda y. \mu \beta. [\alpha'] \lambda z. \mu \alpha. c$  with  $\beta \neq \alpha'$  and  $\alpha \neq \beta'$ . This case is immediate since all possible reductions are in  $c$ .
- $\simeq_{\text{p}}$ . Then,  $o = [\beta] \mu \alpha. c$  and  $p = c \llbracket \alpha \setminus \beta \rrbracket$ . This case is immediate since all possible reductions are in  $c$ .
- $\mathbf{Q} = \mathbf{T}u$  or  $\mathbf{Q} = t\mathbf{T}$ . We use the *i.h.* and Lem. 7.6.
- $\mathbf{Q} = \lambda x. \mathbf{T}$  and  $\mathbf{Q} = \mu \alpha. \mathbf{C}$ . By the *i.h.*
- $\mathbf{Q} = \mathbf{T}[x \setminus u]$ . Then,  $o = \mathbf{T}\langle q \rangle [x \setminus u]$  and  $p = \mathbf{T}\langle q' \rangle [x \setminus u]$ . If the  $\rightsquigarrow_{\mathbf{S}}$  step executes the outermost explicit substitution, we use Lem. F.3 (1), otherwise we use Lem. 7.6 and the *i.h.*
- $\mathbf{Q} = t[x \setminus \mathbf{T}]$ . Then,  $o = t[x \setminus \mathbf{T}\langle q \rangle]$  and  $p = t[x \setminus \mathbf{T}\langle q' \rangle]$ . If the  $\rightsquigarrow_{\mathbf{S}}$  step executes the outermost explicit substitution, we use Lem. F.3 (2), otherwise we use Lem. 7.6 and the *i.h.*
- $\mathbf{Q} = [\alpha] \mathbf{T}$ . By the *i.h.*
- $\mathbf{Q} = \mathbf{C}\llbracket \alpha \setminus^{\alpha'} s \rrbracket$ . Then,  $o = \mathbf{C}\langle q \rangle \llbracket \alpha \setminus^{\alpha'} s \rrbracket$  and  $p = \mathbf{C}\langle q' \rangle \llbracket \alpha \setminus^{\alpha'} s \rrbracket$ . If the  $\rightsquigarrow_{\mathbf{R}^\bullet}$  step executes the outermost explicit replacement, we use Lem. F.4 (1), otherwise we use Lem. 7.6 and the *i.h.*
- $\mathbf{Q} = s\llbracket \alpha \setminus^{\alpha'} \mathbf{S} \rrbracket$ . Then,  $o = c\llbracket \alpha \setminus^{\alpha'} \mathbf{C}\langle q \rangle \rrbracket$  and  $p = c\llbracket \alpha \setminus^{\alpha'} \mathbf{C}\langle q' \rangle \rrbracket$ . If the  $\rightsquigarrow_{\mathbf{R}^\bullet}$  step executes the outermost explicit replacement, we use Lem. F.4 (2), otherwise we use Lem. 7.6 and the *i.h.*
- $\mathbf{Q} = \mathbf{C}\llbracket \alpha \setminus \beta \rrbracket$ ,  $\mathbf{Q} = \mathbf{T} \cdot s$  and  $\mathbf{Q} = t \cdot \mathbf{S}$ . By the *i.h.*

□

## APPENDIX G. TWO CORRESPONDENCE RESULTS

To show soundness of  $\simeq_\sigma$  w.r.t.  $\simeq_{\text{er}}$ , it is necessary to previously stage a list of auxiliary results.

**Lemma G.1.** *Let  $o, o' \in \mathbb{O}_{\Lambda M}$  such that  $o \simeq_* o'$ , where  $\simeq_*$  is an axiom in Fig. 13 or axiom  $\simeq_{\text{ren}}$ . If  $o = \text{LXC}\langle c \rangle$  with  $\mathbf{X} \in \{\mathbf{T}, \mathbf{C}\}$ ,  $\alpha \notin \text{LXC}$ ,  $\text{fc}(\alpha', \text{LXC})$  and  $\text{fc}(s, \text{LXC})$ , then  $o' = \text{LXC}'\langle c' \rangle$  such that  $\alpha \notin \text{LXC}'$ ,  $\text{fc}(\alpha', \text{LXC}')$ ,  $\text{fc}(s, \text{LXC}')$  and  $\mathcal{P}(\text{LXC}\langle c \llbracket \alpha \setminus^{\alpha'} s \rrbracket \rangle) \simeq_{\text{er}} \mathcal{P}(\text{LXC}'\langle c' \llbracket \alpha \setminus^{\alpha'} s \rrbracket \rangle)$ .*

*Proof.* By cases on LXC. Most of the cases are similar to those already detailed in the proof of Lem. F.1. We only illustrate the base case (*i.e.*  $\text{LXC} = \square$ ) for the new rule  $\simeq_{\text{ren}}$ .

- $\simeq_{\text{ren}}$ . Then  $o = c\llbracket \gamma \setminus \delta \rrbracket$  and  $o' = c\{\{\gamma \setminus \delta\}\}$ . By  $\alpha$ -conversion we assume  $\gamma \neq \alpha'$  and  $\gamma \notin s$ . Then, there are three possible cases.
  - (1)  $o\llbracket \alpha \setminus^{\alpha'} s \rrbracket \rightarrow_{\mathbf{W}} c\llbracket \gamma \setminus^{\alpha} s \rrbracket \llbracket \alpha \setminus \alpha' \rrbracket$  (*i.e.*  $\alpha = \delta$  and  $\delta \notin c$ ). Then,  $\mathcal{P}(o\llbracket \alpha \setminus^{\alpha'} s \rrbracket) = \mathcal{P}(c\llbracket \gamma \setminus^{\alpha} s \rrbracket \llbracket \alpha \setminus \alpha' \rrbracket) \simeq_{\text{ren}} \mathcal{P}(c\llbracket \gamma \setminus^{\alpha} s \rrbracket \{\{\alpha \setminus \alpha'\}\})$ . Moreover,  $\alpha \notin s$  by  $\alpha$ -conversion and  $\alpha = \delta \notin c$  by hypothesis of  $\mathbf{W}$ . Then,  $\mathcal{P}(c\llbracket \gamma \setminus^{\alpha} s \rrbracket \{\{\alpha \setminus \alpha'\}\}) = \mathcal{P}(c\llbracket \gamma \setminus^{\alpha} s \rrbracket)$ . We also



- have  $\mathcal{P}(o'[\alpha \setminus^{\alpha'} s]) = \mathcal{P}((c\{\gamma \setminus \alpha\})[\alpha \setminus^{\alpha'} s])$ . But since  $\alpha = \delta \notin c$ , this last object is  $\alpha$ -equivalent to  $\mathcal{P}(c[\gamma \setminus^{\alpha'} s])$ , so that we conclude with  $\text{LXC}' = \square$  and  $c' = o'$ .
- (2)  $o[\alpha \setminus^{\alpha'} s] \rightarrow_{\text{N,C,W}} c'[\gamma \setminus \delta]$  (i.e.  $\text{fn}_\alpha(o) = 1$  and  $\alpha \neq \delta$ ). Therefore,  $\mathcal{P}(o[\alpha \setminus^{\alpha'} s]) = \mathcal{P}(c'[\gamma \setminus \delta]) \simeq_{\text{ren}} \mathcal{P}(c')\{\gamma \setminus \delta\} = \mathcal{P}(o'[\alpha \setminus^{\alpha'} s])$ . We conclude with  $\text{LXC}' = \square$  and  $c' = o'$ .
- (3) Otherwise,  $\mathcal{P}(o[\alpha \setminus^{\alpha'} s]) = o[\alpha \setminus^{\alpha'} \mathcal{P}(s)] \simeq_{\text{er}} o'[\alpha \setminus^{\alpha'} \mathcal{P}(s)] = \mathcal{P}(o'[\alpha \setminus^{\alpha'} s])$ , because  $o \simeq_{\text{er}} o'$  implies  $\mathcal{P}(o) = o$  and  $\mathcal{P}(o') = o'$ . We conclude with  $\text{LXC}' = \square$  and  $c' = o'$ .  $\square$

**Lemma G.2.** *Let  $o, o' \in \mathbb{O}_{\Lambda M}$  such that  $o \simeq_{\text{er}} o'$ .*

- (1) *If  $o, o' \in \mathbb{T}_{\Lambda M}$ , then  $\mathcal{P}(o :: s) \simeq_{\text{er}} \mathcal{P}(o' :: s)$ .*  
(2) *If  $o, o' \in \mathbb{C}_{\Lambda M}$ , then  $\mathcal{P}(o[\alpha \setminus^{\alpha'} s]) \simeq_{\text{er}} \mathcal{P}(o'[\alpha \setminus^{\alpha'} s])$ .*

*Proof.* This proof is similar to that of Lem. F.2 resorting to Lem. G.1 (instead of Lem. F.1), Lem. 7.7 and the fact that  $\simeq \subseteq \simeq_{\text{er}}$ .  $\square$

**Lemma G.3.** *Let  $o \in \mathbb{O}_{\Lambda M}$ . If  $o \simeq_{\text{er}} o'$ , then for all context  $\mathbb{O}$  of appropriate sort we have  $\mathcal{P}(\mathbb{O}\langle o \rangle) \simeq_{\text{er}} \mathcal{P}(\mathbb{O}\langle o' \rangle)$ .*

*Proof.* Similar to Lem. 7.6 resorting to Lem. G.2 instead of Lem. F.2.  $\square$

Despite the fact that  $\_^\diamond$  was defined for a type derivation  $\pi$  (Def. 8.2), we may use in what follows a slight abuse of notation by writing  $R^\diamond$ , instead of  $\pi^\diamond$ , where  $R$  is the proof-net obtained by first computing  $\pi^\diamond$ .

**Theorem 8.4.** *Let  $o, p \in \mathbb{O}_{\Lambda M}$ . Then  $o \simeq p$  implies  $(\pi_o)^\diamond \equiv (\pi_p)^\diamond$ , where  $\pi_o$  and  $\pi_p$  are the corresponding related type derivations.*

*Proof.* The proof is by induction on  $o \simeq p$ . Reflexivity, transitivity and symmetry are straightforward. For congruence, the proof is by induction on  $\mathbb{O}$  such that  $o = \mathbb{O}\langle o' \rangle$  and  $p = \mathbb{O}\langle p' \rangle$  with  $o' \simeq_* p'$ , where  $\simeq_*$  is a rule in Fig. 13. We only detail the base cases  $\mathbb{O} = \square$  and  $\mathbb{O} = \boxplus$ , since the inductive cases result from the *i.h.* by structural equivalence on proof-nets.

- $\mathbb{O} = \square$ . Then,  $o = o' \simeq_* p' = p$ . We study each possible axiom.
  - $\simeq_{\text{exsubs}}$ . Then,  $o = \text{LTT}\langle t \rangle[x \setminus u]$  and  $p = \text{LTT}\langle t \rangle[x \setminus u]$  with  $x \notin \text{LTT}$  and  $\text{fc}(u, \text{LTT})$ . We analyse the form of LTT:
    - \*  $\text{LTT} = \square$ . Then, we have  $o = p$  and the result is immediate by reflexivity of  $\equiv$ .
    - \*  $\text{LTT} = \text{LTT}'v$  with  $x \notin v$  and  $\text{fc}(u, v)$ . We show the case  $x \in \text{fv}(t)$ , the case  $x \notin \text{fv}(t)$  being similar. Then,  $(\pi_o)^\diamond$  and  $(\pi_p)^\diamond$  are both structurally equivalent, by definition, to

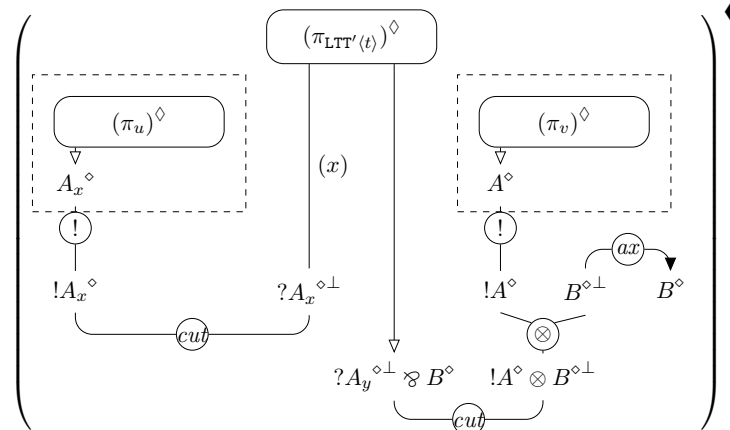



- \*  $\text{LTT} = \lambda y.\text{LTT}'$  with  $y \notin \text{fv}(u)$ . We show the case  $x, y \in \text{fv}(t)$ , the remaining cases being similar. Then,  $(\pi_o)^\diamond$  and  $(\pi_p)^\diamond$  are both structurally equivalent, by definition, to

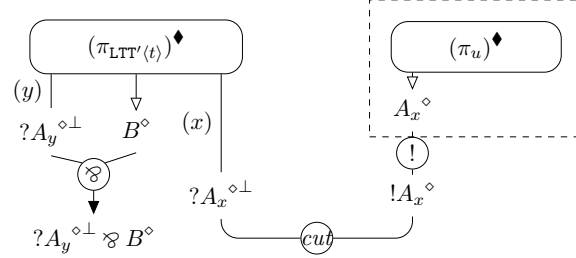

- \*  $\text{LTT} = \mu\alpha.\text{LCT}$ . We analyse the form of  $\text{LCT}$ :
  - $\text{LCT} = [\beta]\text{LTT}'$  with  $\alpha, \beta \notin \text{fn}(u)$ . We show the case  $x \in \text{fv}(t)$ ,  $\alpha \in \text{fn}(t)$  and  $\beta \notin \text{fn}(t)$ , the remaining cases being similar. Then,  $(\pi_o)^\diamond$  and  $(\pi_p)^\diamond$  are both structurally equivalent, by definition, to

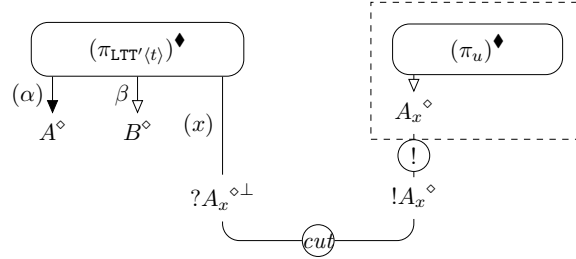

- $\text{LCT} = \text{LCT}'[\beta \setminus^{\beta'} s]$  with  $x \notin s$  and  $\alpha, \beta \notin \text{fn}(u)$ . We show the case where  $\beta'$  is fresh, the remaining cases being similar. Then,  $(\pi_o)^\diamond$  and  $(\pi_p)^\diamond$  are both structurally equivalent, by definition, to

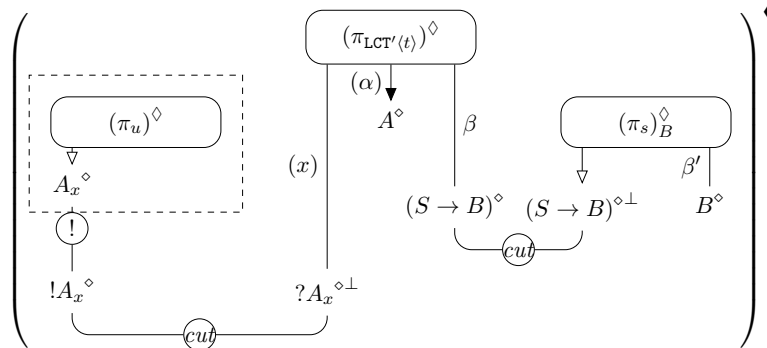

- $\text{LCT} = \text{LCT}'[\beta \setminus \beta']$  with  $\alpha, \beta \notin \text{fn}(u)$ . We show the case  $x \in \text{fv}(t)$ ,  $\alpha \in \text{fn}(t)$  and  $\beta \notin \text{fn}(t)$ , the remaining cases being similar. Then,  $(\pi_o)^\diamond$  and  $(\pi_p)^\diamond$  are both

structurally equivalent, by definition, to

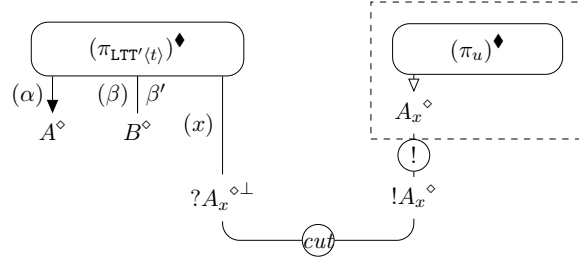

- \*  $LTT = LTT'[x \setminus v]$  with  $x \notin v$  and  $y \notin \text{fv}(u)$ . We show the case  $x, y \in \text{fv}(t)$ , the remaining cases being similar. Then,  $(\pi_o)^\diamond$  and  $(\pi_p)^\diamond$  are both structurally equivalent, by definition, to

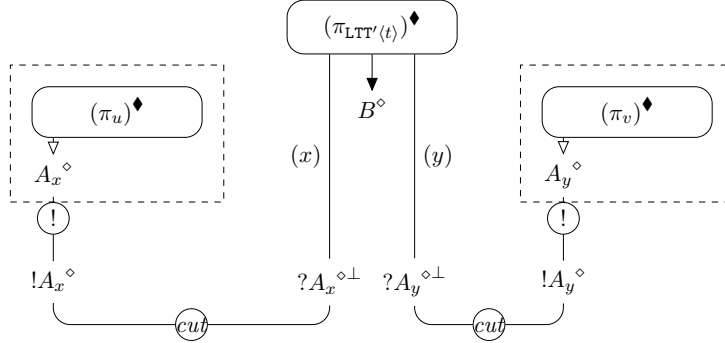

- $\simeq_\theta$ . Then,  $o = \mu\alpha.[\alpha]t$  and  $p = t$  with  $\alpha \notin t$ . The result is immediate since, by definition, we have  $(\pi_{\mu\alpha.[\alpha]t})^\diamond = (\pi_t)^\diamond$ .
- $\mathbf{0} = \square$ . Then,  $o = o' \simeq_* p' = p$ . Moreover, the objects are commands. We study each possible axiom.
  - $\simeq_{\text{exrep1}}$ . Then,  $o = \text{LCC}\langle c \rangle[\alpha \setminus \alpha' s]$  and  $p = \text{LCC}\langle c \rangle[\alpha \setminus \alpha' s]$  with  $\alpha \notin \text{LCC}$ ,  $\text{fc}(\alpha', \text{LCC})$  and  $\text{fc}(s, \text{LCC})$ . We analyse the form of LCC:
    - \*  $\text{LCC} = \square$ . Then,  $o = p$  and the result is immediate by reflexivity of  $\equiv$ .
    - \*  $\text{LCC} = [\beta] \text{LTC}$ . We analyse the form of LTC:
      - $\text{LTC} = \text{LTC}'u$  with  $\alpha \notin u$ . We show  $\alpha \notin \text{fn}(c)$ ,  $\alpha' \notin \text{fn}(c)$  and  $\beta \neq \gamma$ , the remaining cases being similar. Then,  $(\pi_o)^\diamond$  and  $(\pi_p)^\diamond$  are both structurally equivalent, by definition, to

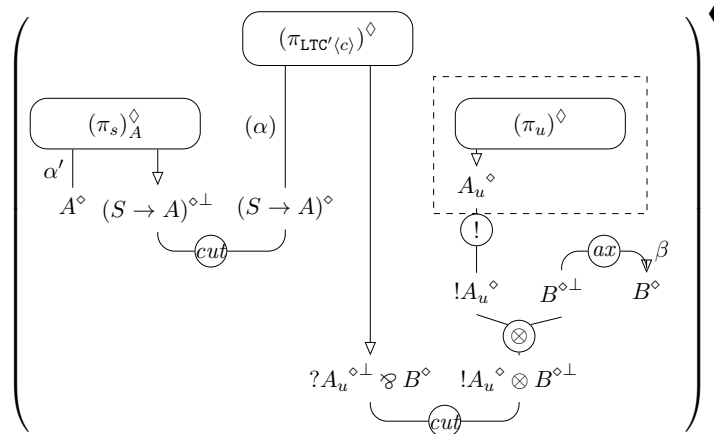



and  $\beta \notin \text{fn}(c)$ . The remaining cases are similar. Notice that the branch holding  $x, \alpha$  and  $\alpha'$  is parallel to that of  $y, \beta$  and  $\beta'$ , and only is contracted at the end if  $\alpha' = \beta'$ .

(1)  $\alpha' = \beta'$  with  $\alpha' \notin \text{fn}(c)$ . Then,  $(\pi_o)^\blacklozenge$  and  $(\pi_p)^\blacklozenge$  are equal, by definition, to

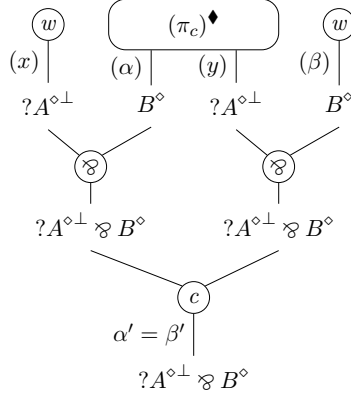

(2)  $\alpha' \neq \beta'$  with  $\alpha' \notin \text{fn}(c)$  and  $\beta' \in \text{fn}(c)$ . Then,  $(\pi_o)^\blacklozenge$  and  $(\pi_p)^\blacklozenge$  are equal, by definition, to

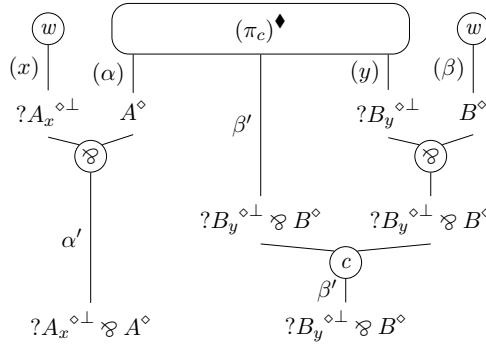

–  $\simeq_p$ . Then,  $o = [\alpha] \mu \beta.c$  and  $p = c[\alpha \setminus \beta]$ . The result is immediate since, by definition,  $(\pi_{[\alpha] \mu \beta.c})^\blacklozenge = (\pi_{c[\alpha \setminus \beta]})^\blacklozenge$ .

□

**Lemma 8.5.** *Let  $o, p \in \mathbb{O}_{\Lambda M}$  be typed. If  $o \simeq_{\text{er}} p$ , then  $(\pi_o)^\blacklozenge \equiv (\pi_p)^\blacklozenge$ , where  $\pi_o$  and  $\pi_p$  are the corresponding related type derivations.*

*Proof.* The proof is similar to that of Thm. 8.4. We only show the base case for the new rule  $\simeq_{\text{ren}}$  (i.e. with  $\mathbb{O} = \square$ ).

•  $\simeq_{\text{ren}}$ . Then,  $o = c[\alpha \setminus \beta]$  and  $p = c\{\alpha \setminus \beta\}$ . We conclude by Lem. C.1, since  $(\pi_{c\{\alpha \setminus \beta\}})^\blacklozenge = (\pi_c)^{\blacklozenge, \alpha, \beta} = (\pi_{c[\alpha \setminus \beta]})^\blacklozenge$  by definition.

□

**Lemma 8.6.** *Let  $o, p \in \mathbb{O}_{\Lambda M}$  be typed. If  $o \rightarrow_p p$ , then  $(\pi_o)^\blacklozenge \equiv (\pi_p)^\blacklozenge$ , where  $\pi_o$  and  $\pi_p$  are the corresponding related type derivations.*

*Proof.* By definition  $o \rightarrow_p p$  implies  $o = \mathbb{O}\langle l \rangle$  and  $p = \mathbb{O}\langle r \rangle$  with  $l \mapsto_* r$ ,  $*$   $\in \{\text{dB}, \text{dM}, \text{N}, \text{C}, \text{W}\}$ . The proof is by induction on  $\mathbb{O}$ . We only detail the cases where  $\mathbb{O} = \square$  and  $\mathbb{O} = \square$ , as all the

other cases follow directly from the *i.h.* by application of the structural equivalence relation on proof-nets.

- $\emptyset = \square$ . There are two cases to consider.

- (1) dB. Then  $o = L\langle\lambda x.t\rangle u$  and  $o' = L\langle t[x \setminus u]\rangle$  with  $\text{fc}(u, L)$ . The proof is by induction on  $L$ . We detail the base case  $L = \square$  and  $x \in \text{fv}(t)$ .

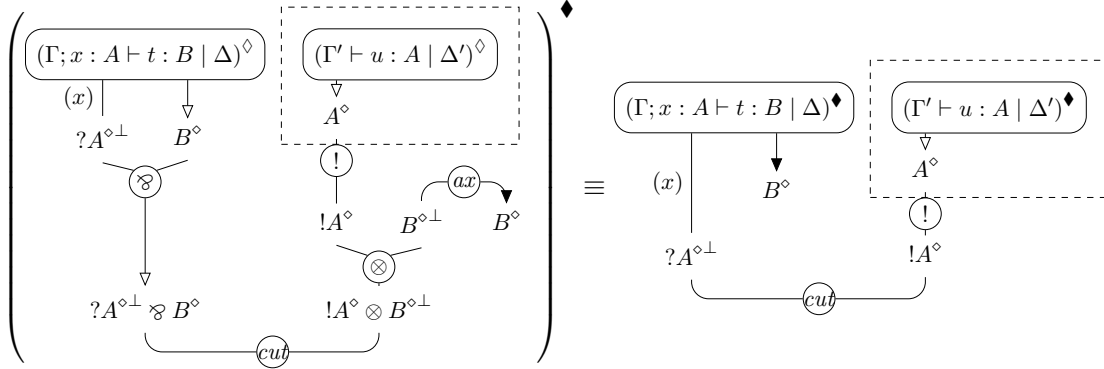

where each side of the structural equivalence is the expansion of  $(\pi_o)^\blacklozenge$  and  $(\pi_p)^\blacklozenge$  respectively. Notice that the multiplicative cut  $C(\otimes, \wp)$  in the left-hand side is contracted by the translation, resulting on one side in the exponential cut  $C(!, d)$  on the right-hand side, and on the other side on a second multiplicative cut  $C(ax)$  between the formulae  $B^\diamond$  and  $B^{\diamond\perp}$ , which is in turn contracted by the translation.

The analysis for  $L = \square$  and  $x \notin \text{fv}(t)$  is similar. The inductive case  $L \neq \square$  follows from the *i.h.* and the structural equivalence on proof-nets.

- (2) dM. Then,  $o = L\langle\mu\alpha.c\rangle u$  and  $o' = L\langle\mu\alpha'.c[\alpha \setminus^{\alpha'} u]\rangle$  with  $\alpha'$  a fresh name. The proof is by induction on  $L$ . We detail the base case  $L = \square$  and  $\alpha \in \text{fn}(c)$ , where both  $(\pi_o)^\blacklozenge$  and  $(\pi_{o'})^\blacklozenge$  are structurally equivalent, by definition, to

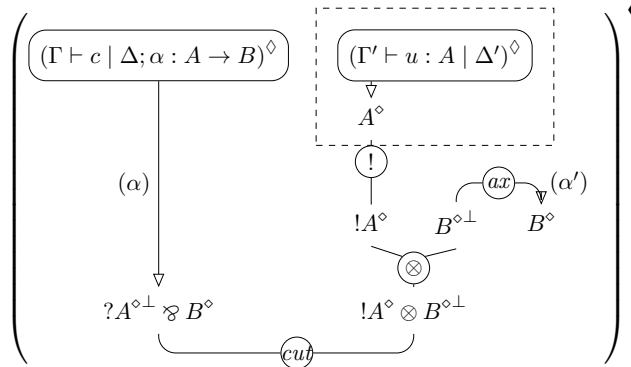

The analysis for  $L = \square$  and  $\alpha \notin \text{fn}(c)$  is similar. The inductive case  $L \neq \square$  follows from the *i.h.* and the structural equivalence on proof-nets.

- $\emptyset = \square$ . Then, there are two possible cases.

- (1) N. Then,  $o = \text{LCC}\langle[\alpha]t\rangle[\alpha \setminus^{\alpha'} s]$  and  $o' = \text{LCC}\langle[\alpha']t :: s\rangle$  with  $\alpha \notin \text{LCC}$  and  $\alpha \notin t$ . The proof is by induction on  $\text{LCC}$ . We show the base case with  $\text{LCC} = \square$  and  $\alpha' \notin \text{fn}(s)$ . More precisely, let  $s = u_0 \dots u_n$ . Then, translating the left-hand-side of the reduction,

$(\Gamma; \Gamma_0; \dots; \Gamma_n \vdash ([\alpha]t)[\alpha \setminus^{\alpha'} s] \mid \Delta; \Delta_0; \dots; \Delta_n; \alpha' : B)^\diamond$ , yields the following proof-net:

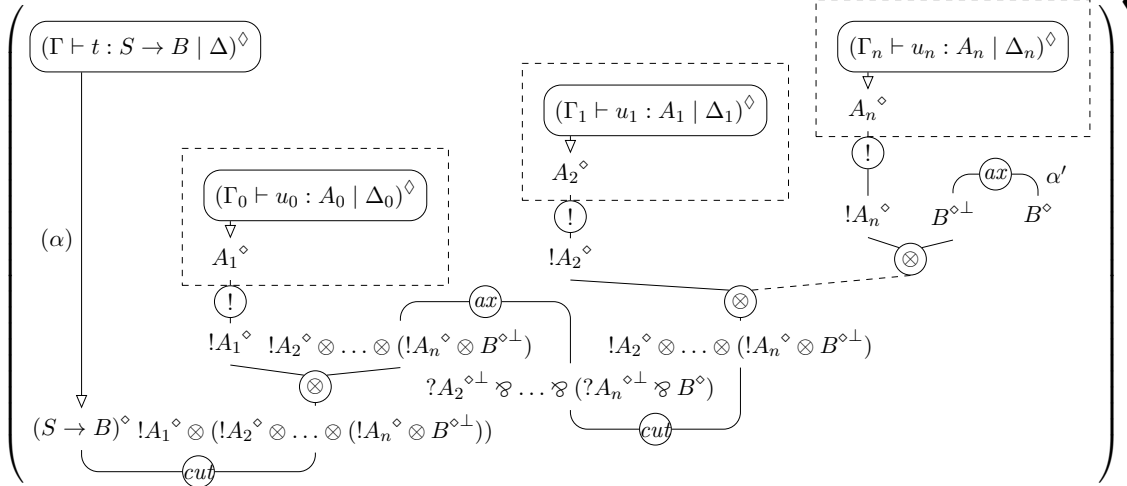

which turns out to be exactly  $(\Gamma; \Gamma_0; \dots; \Gamma_n \vdash [\alpha']t :: s \mid \Delta; \Delta_0; \dots; \Delta_n; \alpha' : B)^\diamond$  as well. The analysis for the other base cases is similar. The inductive cases with  $\text{LCC} \neq \square$  follow directly from the *i.h.* by application of the structural equivalence relation on proof-nets.

- (2) C. Then,  $o = \text{LCC}\langle c[\beta \setminus^{\alpha} s'] \rangle[\alpha \setminus^{\alpha'} s]$  and  $o' = \text{LCC}\langle c[\beta \setminus^{\alpha'} s' \cdot s] \rangle$  with  $\alpha \notin \text{LCC}$ ,  $\alpha \notin c$  and  $\alpha \notin s'$ . The proof is by induction on LCC. We show the base case with  $\text{LCC} = \square$ ,  $\beta \in \text{fn}(c)$  and  $\alpha' \notin \text{fn}(s)$ :

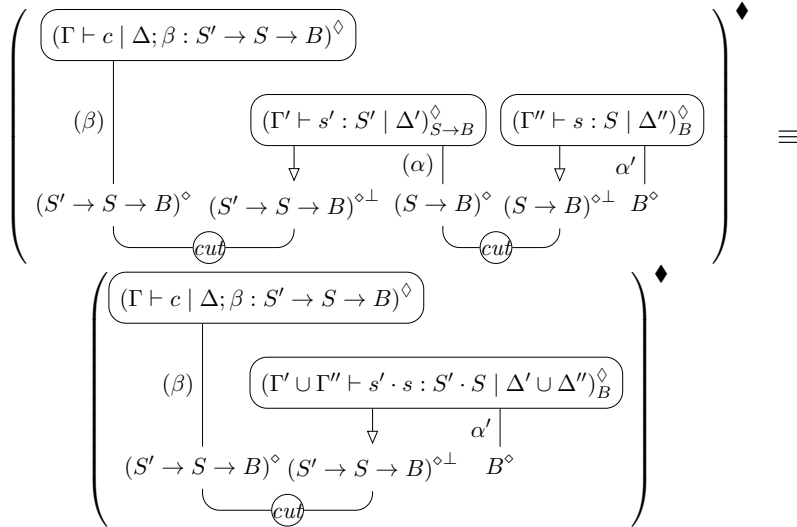

where each side of the structural equivalence is the expansion of  $(\pi_o)^\diamond$  and  $(\pi_p)^\diamond$  respectively. The analysis for the remaining base cases is similar. The inductive cases with  $\text{LCC} \neq \square$  follow directly from the *i.h.* by application of the structural equivalence relation on proof-nets.

- (3) W. Then,  $o = \text{LCC}\langle c[\beta \setminus \alpha] \llbracket \alpha \setminus \alpha' s \rrbracket \rangle$  and  $o' = \text{LCC}\langle c \llbracket \beta \setminus \alpha s \rrbracket \llbracket \alpha \setminus \alpha' \rrbracket \rangle$  with  $\alpha \notin \text{LCC}$ ,  $\alpha \notin c$ . We show the base case with  $\text{LCC} = \square$ ,  $\beta \in \text{fn}(c)$  and  $\alpha' \notin \text{fn}(s)$ .

$$\left( \begin{array}{c} \boxed{(\Gamma \vdash c \mid \Delta; \beta : S \rightarrow B)^\diamond} \\ \downarrow \quad \downarrow \quad \downarrow \\ (\beta) \quad (\alpha) \quad \boxed{(\Gamma' \vdash s : S \mid \Delta')_B^\diamond} \\ \downarrow \quad \downarrow \quad \downarrow \\ (S \rightarrow B)^\diamond \quad (S \rightarrow B)^{\circ\perp} \quad B^\diamond \\ \underbrace{\hspace{10em}}_{cut} \end{array} \right)^\diamond \equiv \left( \begin{array}{c} \boxed{(\Gamma \vdash c \mid \Delta; \beta : S \rightarrow B)^\diamond} \\ \downarrow \quad \downarrow \quad \downarrow \\ (\beta) \quad \quad \quad \boxed{(\Gamma' \vdash s : S \mid \Delta')_B^\diamond} \\ \downarrow \quad \downarrow \quad \downarrow \\ (S \rightarrow B)^\diamond \quad (S \rightarrow B)^{\circ\perp} \quad B^\diamond \\ \underbrace{\hspace{10em}}_{cut} \end{array} \right)^\diamond$$

where each side of the structural equivalence is the expansion of  $(\pi_o)^\diamond$  and  $(\pi_p)^\diamond$  respectively. Notice that the only difference between both proof-nets is the placement of the original (erased) name  $\alpha$ . The analysis for the remaining base cases is similar. The cases inductive with  $\text{LCC} \neq \square$  follow directly from the *i.h.* by application of the structural equivalence relation on proof-nets.  $\square$

**Lemma G.4.** Let  $t \in \mathbb{T}_{\Lambda M}$  and  $s \in \mathbb{O}_{\Lambda M}$  be a stack. Consider typing derivations  $\pi_t$  and  $\pi_s$  assigning types  $S \rightarrow B$  and  $S$  respectively. Then  $(\pi_t)^\diamond \equiv (\pi_{e(t)})^\diamond$  and  $(\pi_s)_B^\diamond \equiv (\pi_{e(s)})_B^\diamond$  imply  $(\pi_{t::s})^\diamond \equiv (\pi_{e(t)::s})^\diamond$ .

*Proof.* By induction on  $s$ .

- $s = u$ . Then  $t :: u = tu$  and  $S = A$ . Moreover, by definition one has

$$\begin{array}{c} \begin{array}{c} \boxed{(\pi_u)^\diamond} \\ \downarrow \\ A^\diamond \\ \downarrow \\ !A^\diamond \end{array} \quad \begin{array}{c} \text{ax} \\ \downarrow \\ B^{\circ\perp} \end{array} \quad \begin{array}{c} \downarrow \\ B^\diamond \end{array} \\ \downarrow \quad \downarrow \\ \otimes \\ \downarrow \\ !A^\diamond \otimes B^{\circ\perp} = (A \rightarrow B)^{\circ\perp} \end{array} \equiv \begin{array}{c} \boxed{(\pi_{e(u)})^\diamond} \\ \downarrow \\ A^\diamond \\ \downarrow \\ !A^\diamond \end{array} \quad \begin{array}{c} \text{ax} \\ \downarrow \\ B^{\circ\perp} \end{array} \quad \begin{array}{c} \downarrow \\ B^\diamond \end{array} \\ \downarrow \quad \downarrow \\ \otimes \\ \downarrow \\ !A^\diamond \otimes B^{\circ\perp} = (A \rightarrow B)^{\circ\perp} \end{array} = (\pi_{e(u)})_B^\diamond$$

which in particular implies  $(\pi_u)^\diamond \equiv (\pi_{e(u)})^\diamond$ . We can then conclude as follows since  $e(t :: u) = e(t) e(u)$ :

$$(\pi_{t::u})^\diamond = \left( \begin{array}{c} \boxed{(\pi_t)^\diamond} \quad \boxed{(\pi_u)_B^\diamond} \\ \downarrow \quad \downarrow \quad \downarrow \\ (A \rightarrow B)^\diamond \quad (A \rightarrow B)^{\circ\perp} \quad B^\diamond \\ \underbrace{\hspace{10em}}_{cut} \end{array} \right)^\diamond \equiv \left( \begin{array}{c} \boxed{(\pi_{e(t)})^\diamond} \quad \boxed{(\pi_{e(u)})_B^\diamond} \\ \downarrow \quad \downarrow \quad \downarrow \\ (A \rightarrow B)^\diamond \quad (A \rightarrow B)^{\circ\perp} \quad B^\diamond \\ \underbrace{\hspace{10em}}_{cut} \end{array} \right)^\diamond = (\pi_{e(t::u)})^\diamond$$





- $o = \mu\alpha.c$ . Then  $e(o) = \mu\alpha.e(c)$ . We conclude by the *i.h.*
- $o = t[x \setminus u]$ . Then,  $e(o) = (\lambda x.e(t))e(u)$ . By the *i.h.* one has  $(\pi_t)^\blacklozenge \equiv (\pi_{e(t)})^\blacklozenge$  and  $(\pi_u)^\blacklozenge \equiv (\pi_{e(u)})^\blacklozenge$ . If  $x \in \text{fv}(t)$ , then  $x \in \text{fv}(e(t))$  so that

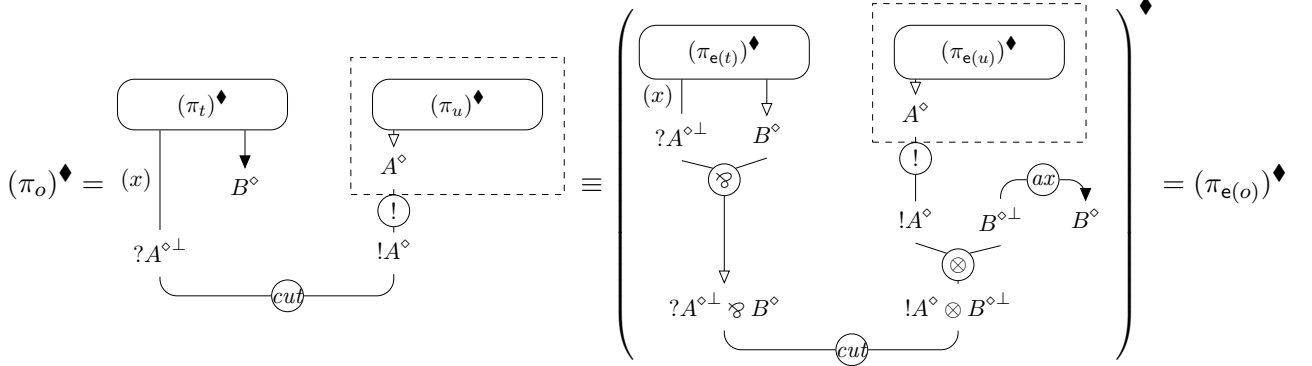

Notice that the multiplicative cut  $\mathbf{C}(\otimes, \wp)$  in the right-hand side is contracted by the translation, resulting in the exponential cut depicted in left-hand side. Moreover, the second multiplicative cut  $\mathbf{C}(ax)$  between the formulae  $B^\diamond$  and  $B^{\perp}$  is also contracted by the translation. If  $x \notin \text{fv}(t)$ , we also have  $x \notin \text{fv}(e(t))$  and the situation is similar

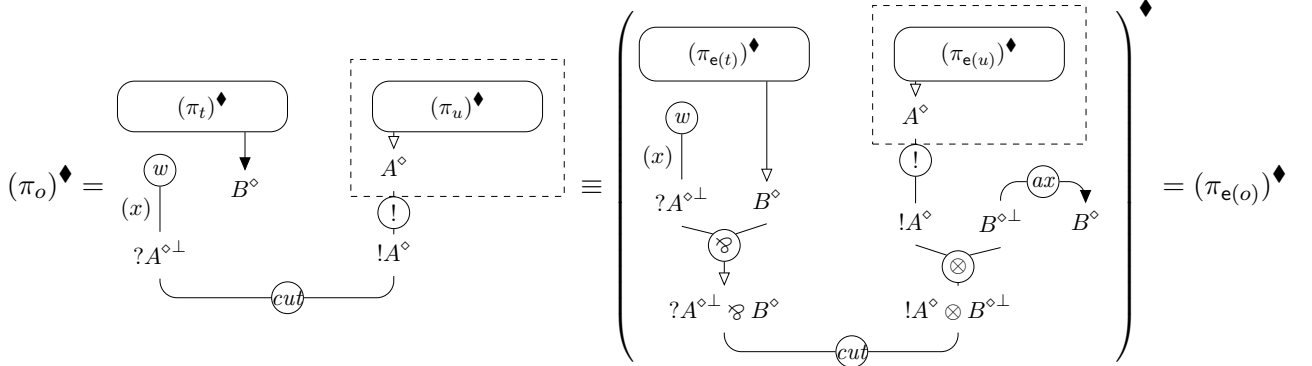

- $o = [\alpha]t$ . Then  $e(o) = [\alpha]e(t)$ . We conclude by the *i.h.*
- $o = c[\alpha \setminus \alpha' s]$ . Then,  $e(o) = [\alpha'](\mu\alpha.e(c)) :: e(s)$ . By the *i.h.* one has  $(\pi_c)^\blacklozenge \equiv (\pi_{e(c)})^\blacklozenge$ . Moreover, by  $\alpha$ -conversion we assume  $\alpha \notin s$ . We prove  $s_B^\blacklozenge \equiv e(s)_B^\blacklozenge$  by induction on  $s$ .
  - $s = t$ . By the *i.h.* one has  $(\pi_t)^\blacklozenge \equiv (\pi_{e(t)})^\blacklozenge$ . Then

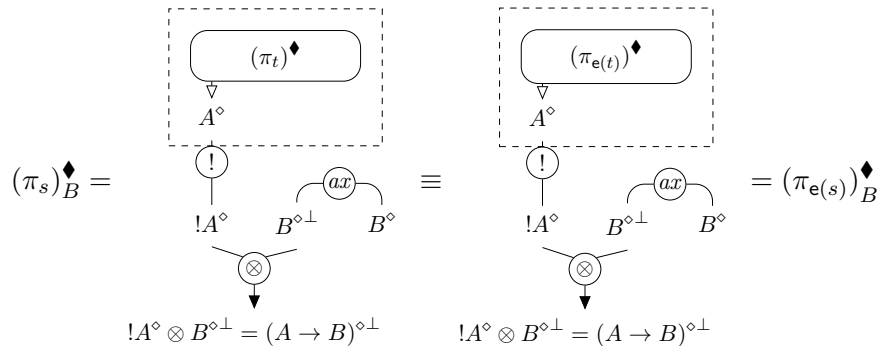

–  $s = t \cdot s'$ . By the *i.h.* one has  $(\pi_t)^\blacklozenge \equiv (\pi_{e(t)})^\blacklozenge$  and  $(\pi_{s'})^\blacklozenge_B \equiv (\pi_{e(s')})^\blacklozenge_B$  respectively. Then

$$\begin{array}{c}
 \begin{array}{ccc}
 \boxed{\begin{array}{c} (\pi_t)^\blacklozenge \\ \downarrow \\ A^\circ \end{array}} & & \boxed{\begin{array}{c} (\pi_{e(t)})^\blacklozenge \\ \downarrow \\ A^\circ \end{array}} \\
 \downarrow & & \downarrow \\
 !A^\circ & & !A^\circ \\
 \downarrow & & \downarrow \\
 \otimes & & \otimes \\
 \downarrow & & \downarrow \\
 !A^\circ \otimes (S' \rightarrow B)^{\circ\perp} & & !A^\circ \otimes (S' \rightarrow B)^{\circ\perp} \\
 \downarrow & & \downarrow \\
 (A \cdot S' \rightarrow B)^{\circ\perp} & & (A \cdot S' \rightarrow B)^{\circ\perp}
 \end{array} \\
 (\pi_s)^\blacklozenge_B = & \equiv & (\pi_{e(s)})^\blacklozenge_B
 \end{array}$$

Therefore, one obtains  $(\pi_c)^\blacklozenge \equiv (\pi_{e(c)})^\blacklozenge$  and  $s_B^\blacklozenge \equiv e(s)_B^\blacklozenge$ . Moreover, by definition, from  $e(\mu\alpha.c) = \mu\alpha.e(c)$  one obtains  $(\pi_{\mu\alpha.c})^\blacklozenge \equiv (\pi_{e(\mu\alpha.c)})^\blacklozenge$ . By Lem. G.4 we get  $(\pi_{(\mu\alpha.c)::s})^\blacklozenge \equiv (\pi_{e((\mu\alpha.c)::s)})^\blacklozenge$ , and by definition one obtains  $(\pi_{[\alpha'](\mu\alpha.c)::s})^\blacklozenge \equiv (\pi_{e([\alpha'](\mu\alpha.c)::s)})^\blacklozenge = (\pi_{e(o)})^\blacklozenge$ . Se concluye pues,  $\pi_o^\blacklozenge$  and  $(\pi_{[\alpha'](\mu\alpha.c)::s})^\blacklozenge$  which are both structurally equivalent to

$$\left( \begin{array}{cc}
 \boxed{(\pi_c)^\blacklozenge} & \boxed{(\pi_s)_B^\blacklozenge} \\
 (\alpha) \downarrow & \downarrow (\alpha') \\
 (A \rightarrow B)^\circ & (A \rightarrow B)^{\circ\perp} B^\circ \\
 \underbrace{\hspace{10em}}_{cut} & 
 \end{array} \right)^\blacklozenge$$

- $o = c[\alpha \setminus \beta]$ . Then,  $e(o) = [\beta]\mu\alpha.e(c)$ . By the *i.h.* one has  $(\pi_c)^\blacklozenge \equiv (\pi_{e(c)})^\blacklozenge$ . If  $\alpha, \beta \in \text{fn}(c)$ , thus  $\alpha, \beta \in \text{fn}(e(c))$  and

$$\begin{array}{c}
 \begin{array}{ccc}
 \boxed{(\pi_c)^\blacklozenge} & & \boxed{(\pi_{e(c)})^\blacklozenge} \\
 (\alpha) \downarrow & \beta \downarrow & (\alpha) \downarrow & \beta \downarrow \\
 A^\circ & A^\circ & A^\circ & A^\circ \\
 \downarrow & & \downarrow & \\
 c & & c \\
 \beta \downarrow & & \beta \downarrow \\
 A^\circ & & A^\circ
 \end{array} \\
 (\pi_o)^\blacklozenge = & \equiv & (\pi_{e(o)})^\blacklozenge
 \end{array}$$

Moreover, if  $\alpha \in \text{fn}(c)$  and  $\beta \notin \text{fn}(c)$ , then  $\alpha \in \text{fn}(e(c))$  and  $\beta \notin \text{fn}(e(c))$ . Therefore

$$\begin{array}{c}
 \begin{array}{ccc}
 \boxed{(\pi_c)^\blacklozenge} & & \boxed{(\pi_{e(c)})^\blacklozenge} \\
 (\alpha) \downarrow & \beta & (\alpha) \downarrow & \beta \\
 A^\circ & & A^\circ & \\
 \downarrow & & \downarrow & \\
 c & & c \\
 \beta \downarrow & & \beta \downarrow \\
 A^\circ & & A^\circ
 \end{array} \\
 (\pi_o)^\blacklozenge = & \equiv & (\pi_{e(o)})^\blacklozenge
 \end{array}$$

If  $\alpha \notin \text{fn}(c)$  and  $\beta \in \text{fn}(c)$ , we get  $\alpha \notin \text{fn}(e(c))$  and  $\beta \in \text{fn}(e(c))$ , therefore

$$(\pi_o)^\blacklozenge = \frac{\boxed{(\pi_c)^\blacklozenge}}{\beta \mid A^\circ} \equiv \frac{\begin{array}{c} (w) \\ \downarrow \\ A^\circ \end{array} \quad \boxed{(\pi_{e(c)})^\blacklozenge}}{\beta \mid A^\circ} \quad \begin{array}{c} c \\ \beta \mid \\ A^\circ \end{array} = (\pi_{e(o)})^\blacklozenge$$

Finally, if  $\alpha, \beta \notin \text{fn}(c)$ , then  $\alpha, \beta \notin \text{fn}(e(c))$  and one concludes

$$(\pi_o)^\blacklozenge = \frac{\begin{array}{c} (w) \\ \beta \mid \\ A^\circ \end{array} \quad \boxed{(\pi_c)^\blacklozenge}}{\beta \mid A^\circ} \equiv \frac{\begin{array}{c} (w) \\ \beta \mid \\ A^\circ \end{array} \quad \boxed{(\pi_{e(c)})^\blacklozenge}}{\beta \mid A^\circ} = (\pi_{e(o)})^\blacklozenge$$

□