

Flow conditions for continuous-variable measurement based quantum computing

Robert I. Booth^{1,2} and Damian Markham^{1,3}

¹ Sorbonne Université, CNRS, LIP6, 4 place Jussieu, F-75005 Paris, France

² LORIA CNRS, Inria Mocqua, Université de Lorraine, F-54000 Nancy, France

³ JFLI, CNRS / National Institute of Informatics, University of Tokyo, Tokyo, Japan

In measurement-based quantum computing (MBQC), computation is carried out by a sequence of measurements and corrections on an entangled state. Flow, and related concepts, are powerful techniques for characterising the dependence of the corrections on previous measurement results. We introduce flow-based methods for quantum computation with continuous-variable graph states, which we call CV-flow. These are inspired by, but not equivalent to, the notions of causal flow and g-flow for qubit MBQC. We also show that an MBQC with CV-flow approximates a unitary arbitrarily well in the infinite-squeezing limit, addressing issues of convergence which are unavoidable in the infinite-dimensional setting. In developing our proofs, we provide a method for converting a CV-MBQC computation into a circuit form, analogous to the circuit extraction method of Miyazaki et al, and an efficient algorithm for finding CV-flow when it exists based on the qubit version by Mhalla and Perdrix. Our results and techniques naturally extend to the cases of MBQC for quantum computation with qudits of prime local dimension.

Causal flow is a graph-theoretical tool for characterising the quantum states used in measurement-based quantum computation (MBQC) and closely related to the measurement calculus [RB01; RB02; DK06]. Its original purpose was to identify a class of qubit graph states that can be used to perform a deterministic MBQC despite inherent randomness in the outcomes of measurements, but it has since found applications to a wide variety of problems in quantum information theory.

Along with its generalisation g-flow [DKP07], causal flow has been used to parallelise quantum circuits by translating them to MBQC [BK09], to construct schemes for the verification of blind quantum computation [FK17; Man+17], to extract bounds on the classical simulatability of MBQC [MK14], to prove depth complexity separations between the circuit and measurement-based models of computation [BK09; MHM15], and to study trade-offs in adiabatic quantum computation [AMA14]. A relaxation of these notions was also used in [Mha+14] to further classify which graph states can be used for MBQC. g-flow can also be viewed as a method for turning protocols with post-selection on the outcomes of measurements into deterministic protocols without post-selection, which has been useful for applying ZX-calculus techniques [Bac+21]. This perspective has been used for the verification of measurement-based quantum computations [DP10], as well as state of the art quantum circuit optimisation techniques [Dun+20] and even to design new models of quantum computation [de +20].

Concurrently, it has become apparent that quantum computing paradigms other than qubit based models might offer viable alternatives for constructing a quantum computer. Continuous-variable (CV) quantum computation, which has a physical interpretation as interacting modes of the quantum electromagnetic field, is such a non-standard model for quantum computation [LB99; Bv05]. CV computation also has implementational advantages over the discrete variable case. To the author’s knowledge, the largest entangled states observed experimentally to date (in terms of number of involved systems) remain those obtained in CV optical experiments using time-multiplexing, beating their discrete counterparts by many orders of magnitude [Yok+13; Yos+16; Asa+19]. That said, there of course remain challenges to a CV quantum computer. While it is relatively easier to generate entanglement in CV, there are other operations necessary for quantum speed-up, dubbed *non-Gaussian* operations, which are much more difficult to obtain since they correspond to interactions typically observed only at very high energies or in very specific states of matter. Some progress has recently been made on this aspect [Miy+16; Kon+21b; Kon+21a]. Secondly, genuinely CV quantum error correction codes have proved elusive. This is partially because it has been shown that no satisfactory CV code is possible without non-Gaussian operations [ESP02; NFC09; Vui+19], but even when assuming access to such operations, results beginning to tackle natural classes of errors have only recently been obtained [NGJ20; Hao+21].

The MBQC framework has been extended to the CV case, with a surprisingly similar semantics [ZB06; Men+06]. Accordingly, some structures transfer naturally from DV to CV, and it is of interest to investigate if it is possible to define notions of flow for CV-MBQC. That one should be interested in CV-MBQC with arbitrary entanglement topologies, as we investigate here, is justified by results such as those of [AM16], in which it is shown that various advantages can be obtained over the standard square-lattice CV cluster states. However, CV-MBQC comes with an additional complication: the gate teleportation protocol is an approximation to the desired unitary gate. This comes about because the unitary can only be understood to be obtained in the limit of infinite squeezing of a physical protocol. The convergence of this approximation is implicit in CV teleportation protocols, but the convergence of an MBQC with arbitrary entanglement topologies is not assured.

In this paper, we define such a notion, converting the results on flow and g-flow from [Bro+07] to continuous variables, and use it to identify a class of graph states that can be used for convergent MBQC protocols. In section 1, we review CV quantum computation and define our computational model. In section 2, we state our CV flow conditions, and prove that they give rise to a suitable MBQC protocol with auxiliary squeezed states [Lvo15]. In section 3, we construct a quantum circuit extraction scheme for our flow-based CV-MBQC protocol, proving convergence in the infinite-squeezing limit. In section 4, we briefly explain how our techniques adapt to the qudit case, yielding an analogous MBQC scheme and a corresponding circuit extraction. Finally, appendix A contains some of the more technical proofs, appendix B a polynomial-time algorithm for determining if a graph has CV-flow, appendix C a comparison of our CV flow conditions to the original DV conditions when this makes sense, and appendix D an example of depth-complexity advantage using CV-MBQC compared to a circuit acting on the same number of inputs.

Acknowledgements The authors were supported by the ANR VanQuTe project (ANR-17-CE24-0035). RIB is now based at the University of Edinburgh, but did all the work at his previous institutions. We thank Simon Perdrix, Elham Kashefi, Ulysse Chabaud and Francesco Arzani for enlightening discussions.

1 Preliminaries

Our model is based on measurement-based quantum computation using continuous variable graph states (CV-MBQC), as described in [ZB06; Men+06; Gu+09]. We first recall some background relevant for continuous-variable quantum computation, and briefly review CV-MBQC, which is the primary motivation for deriving flow conditions for continuous variables. We then introduce open graphs and how they relate to the states used in CV-MBQC.

Notation. We use $|X|$ to denote the cardinality of the set X .

Sans-serif font will denote linear operators on a Hilbert space: A, B, \dots, X, Y, Z , and A^* the Hermitian adjoint of A . I is the identity operator. Cursive fonts are used for completely positive trace non-increasing maps (quantum channels): $\mathcal{A}, \mathcal{B}, \dots$

1.1 Computational model

In CV quantum computation, the basic building block is the **qumode**¹, a complex, countably infinite-dimensional, separable Hilbert space $\mathcal{H} = L^2(\mathbb{R}, \mathbb{C})$ which takes the place of the qubit. \mathcal{H} is a space of square integrable complex valued functions: an element of $\phi \in \mathcal{H}$ is a function $\mathbb{R} \rightarrow \mathbb{C}$ such that

$$\int_{\mathbb{R}} |\phi(x)|^2 dx < \infty, \quad (1)$$

and where the Hilbert inner product is

$$\langle \psi, \phi \rangle := \int_{\mathbb{R}} \bar{\psi}(x)\phi(x) dx, \quad (2)$$

with corresponding norm $\|\psi\|_{\mathcal{H}} := \sqrt{\langle \psi, \psi \rangle}$.

Each qumode is equipped with a pair of unbounded linear position and momentum operators Q and P , which are defined on the dense subspace $\mathcal{S} \subseteq \mathcal{H}$ of Schwartz functions², along with any inhomogeneous polynomial thereof:

$$\text{for any } \phi \in \mathcal{S}, \quad Q\phi(x) := x\phi(x) \quad \text{and} \quad P\phi(x) := -i\frac{d\phi(x)}{dx}. \quad (3)$$

From these, we can define the corresponding translation operators (continuously extendable to all \mathcal{H}):

$$\text{for any } s \in \mathbb{R}, \quad X(s) := \exp(-isP) \quad \text{and} \quad Z(s) := \exp(isQ), \quad (4)$$

such that

$$X(-s)QX(s) = Q + sI; \quad (5)$$

$$Z(-s)PZ(s) = P + sI. \quad (6)$$

¹This terminology comes from quantum optics, where we can identify each quantisation mode of the quantum electromagnetic field with a space $L^2(\mathbb{R})$ [FT20].

²This is a technical condition which ensures that for any real polynomial p in Q and P , $p\phi$ remains a square-integrable function, something which is not true in general. The natural setting for this discussion is the *rigged Hilbert space*, or Gel'fand triple, $\mathcal{S} \subseteq \mathcal{H} \subseteq \mathcal{S}^*$, where \mathcal{S}^* is the continuous dual of Schwartz space or *space of tempered distributions*. We refer the interested reader to the classic series of books by Gel'fand et al. [GS16a; GS16b; GS16c; GV16], and also to [GG02; CGd19] and the references therein for a recent discussion of its application to quantum mechanics.

In fact, all four of these operators are defined by the exponential Weyl commutation relations (up to unitary equivalence, by the Stone-von Neumann theorem, see [Hal13] section 14):

$$\text{for any } s, t \in \mathbb{R}, \quad \mathbf{X}(s)\mathbf{Z}(t) = e^{ist}\mathbf{Z}(t)\mathbf{X}(s), \quad (7)$$

which generalise the canonical commutation relations, and further related by the Fourier transform operator $\mathbf{F} : \mathcal{H} \rightarrow \mathcal{H}$:

$$\mathbf{F}\mathbf{Q}\mathbf{F}^* = \mathbf{P} \quad \text{and} \quad \mathbf{F}\mathbf{P}\mathbf{F}^* = -\mathbf{Q}. \quad (8)$$

The **squeeze operator** is defined for any real number $\eta > 0$, called the **squeezing factor**, by

$$\mathbf{S}(\eta) := \exp(-i \ln(\eta)(\mathbf{Q}\mathbf{P} + \mathbf{P}\mathbf{Q})). \quad (9)$$

Then $\mathbf{S}(\eta)\psi(x) = \sqrt{\eta^{-1}}\psi(\eta^{-1}x)$ so that:

$$\mathbf{S}(\eta)^*\mathbf{Q}\mathbf{S}(\eta) = \eta\mathbf{Q}, \quad \mathbf{S}(\eta)^*\mathbf{P}\mathbf{S}(\eta) = \eta^{-1}\mathbf{P} \quad (10)$$

$$\mathbf{S}(\eta)^*\mathbf{Z}(s)\mathbf{S}(\eta) = \mathbf{Z}(\eta s), \quad \mathbf{S}(\eta)^*\mathbf{X}(s)\mathbf{S}(\eta) = \mathbf{X}(\eta^{-1}s). \quad (11)$$

Following Lloyd and Braunstein [LB99; Bv05], the state of a set of N qumodes can be used to encode information and perform computations just as one would with a register of qubits, using unitaries from the set

$$\{\mathbf{F}, \exp(is\mathbf{Q}_j), \exp(is\mathbf{Q}_j^2), \exp(is\mathbf{Q}_j^3), \exp(is\mathbf{Q}_j\mathbf{Q}_k) \mid s \in \mathbb{R}, j, k \in \{1, \dots, N\}\}, \quad (12)$$

and where states are obtained with the usual tensor product of Hilbert spaces. The indices j, k indicate on which subsystems in the tensor product the operators act. For brevity and by analogy with DV, we write:

$$\mathbf{C}\mathbf{Z}_{j,k}(s) := \exp(is\mathbf{Q}_j\mathbf{Q}_k), \quad (13)$$

$$\mathbf{C}\mathbf{X}_{j,k}(s) := \exp(is\mathbf{Q}_j\mathbf{P}_k) = \mathbf{F}_k \mathbf{C}\mathbf{Z}_{j,k}(s) \mathbf{F}_k^*, \quad (14)$$

$$\mathbf{U}_k(\alpha, \beta, \gamma) := \exp(i\alpha\mathbf{Q}_k) \exp(i\beta\mathbf{Q}_k^2) \exp(i\gamma\mathbf{Q}_k^3). \quad (15)$$

This model of computation is strong enough to encode qubit quantum computation [GKP01], and is universal in the sense that any unitary can be approximated by combinations of applications of (13) - (15) [LB99].

Mixed states

Even ignoring inevitable experimental noise, since the teleportation procedures that we consider are not unitary in general, but only in an ideal limit, we need to work with mixed states. In continuous variables, there are further mathematical technicalities involved with defining density operators, which we deal with here [SH08; Hal13].

Let \mathcal{H} be a separable Hilbert space, and $\mathfrak{B}(\mathcal{H})$ be the algebra of bounded operators on \mathcal{H} . We say that a self-adjoint, positive operator $\mathbf{A} \in \mathfrak{B}(\mathcal{H})$ is **trace-class** if for an arbitrary choice of basis $\{e_i\}$ of \mathcal{H} , we have

$$\sum_{n \in \mathbb{N}} \langle e_n, \mathbf{A}e_n \rangle < +\infty. \quad (16)$$

An operator $\mathbf{A} \in \mathfrak{B}(\mathcal{H})$ is itself trace-class if the positive self-adjoint operator $\sqrt{\mathbf{A}^*\mathbf{A}}$, defined using the functional spectral calculus, is trace-class.

The set of trace-class operators forms a Banach algebra $\mathfrak{T}(\mathcal{H})$ with norm given by the trace:

$$\text{for any } A \in D(\mathcal{H}), \quad \text{tr}(A) := \sum_{n \in \mathbb{N}} \langle e_n, \sqrt{A^* A} e_n \rangle, \quad (17)$$

and a positive self-adjoint operator $\rho \in \mathfrak{T}(\mathcal{H})$ is called a **density operator** if $\text{tr}(\rho) = 1$. We denote $D(\mathcal{H})$ the set of density operators, and for any state $\psi \in \mathcal{H}$, the projector $\rho_\psi : \phi \mapsto \langle \psi, \phi \rangle \psi$ is a density operator since $\text{tr}(\rho_\psi) = \|\psi\|^2$. The set $D(\mathcal{H})$ thus corresponds to a set of quantum states which extends the space \mathcal{H} . If a density operator takes the form ρ_ψ for some $\psi \in \mathcal{H}$, we say it is a **pure state**, otherwise it is a **mixed state**.

However, some of the proofs of convergence we use will depend on stronger assumptions on the set of input states which are allowed. We will need to make use of the fact that the Wigner function of inputs to a quantum teleportation are Schwartz functions. A theory of these density operators, Schwartz density operators, was developed in [KKW16], but since all reasonable physical states are included in this set [BG89], we will simply refer to them as **physical states**.

Topologies on the set of quantum operations

A linear map $\mathcal{V} : \mathfrak{T}(\mathcal{H}) \rightarrow \mathfrak{T}(\mathcal{H})$ is trace non-increasing if for any $\rho \in D(\mathcal{H})$, $\text{tr}(\mathcal{V}[\rho]) \leq 1$, and completely positive if the dual map is completely positive.³ Then, a completely positive, trace non-increasing linear map $\mathfrak{T}(\mathcal{H}) \rightarrow \mathfrak{T}(\mathcal{H})$ implements a physical transformation on the set of states $D(\mathcal{H})$, called a **quantum operation**. For example, for any unitary U acting on \mathcal{H} , there is a quantum operations $\mathcal{U}_U : \mathfrak{T}(\mathcal{H}) \rightarrow \mathfrak{T}(\mathcal{H})$ given by conjugation by U , i.e. $\mathcal{U}_U[\rho] = U\rho U^*$.

The set of all quantum operations $\mathfrak{T}(\mathcal{H}) \rightarrow \mathfrak{T}(\mathcal{H})$ can be given several different topologies. The simplest is the **uniform topology**, given by the norm

$$\|\mathcal{V}\| = \sup_{\rho \in D(\mathcal{H})} \text{tr}(\mathcal{V}[\rho]). \quad (18)$$

However, as discussed in [SH08; Wil18; PLB18], the uniform topology is inappropriate for considering the approximation of arbitrary quantum operations in infinite-dimensional Hilbert spaces. Instead, we use a coarser topology, the **strong topology**, which is generated by the family of semi-norms:

$$\text{for each } \rho \in D(\mathcal{H}), \quad \mathcal{V} \mapsto \text{tr}(\mathcal{V}[\rho]), \quad (19)$$

and a sequence of quantum operations $(\mathcal{V}_k)_{k \in \mathbb{N}}$ converges to \mathcal{V} in the strong topology if and only if for every $\rho \in D(\mathcal{H})$,

$$\lim_{k \rightarrow \infty} \mathcal{V}_k[\rho] = \mathcal{V}[\rho]. \quad (20)$$

Thus, the sequence $(\mathcal{V}_k)_{k \in \mathbb{N}}$ can be viewed as a pointwise approximation to \mathcal{V} , and this is the perspective we take in this paper: we construct an MBQC procedure, associated to a flow condition, which converges strongly to unitary quantum circuits in the ideal limit of the approximation.

³The dual map of \mathcal{V} is the map $\mathcal{V}^* : \mathfrak{B}(\mathcal{H}) \rightarrow \mathfrak{B}(\mathcal{H})$ given by $\text{tr}(A\mathcal{V}[\rho]) = \text{tr}(\mathcal{V}^*[A]\rho)$ for any $\rho \in D(\mathcal{H})$. It is completely positive if for all $n \in \mathbb{N}$, $\mathcal{V}^* \otimes id_n : \mathfrak{B}(\mathcal{H}) \otimes \mathbb{C}^n \rightarrow \mathfrak{B}(\mathcal{H}) \otimes \mathbb{C}^n$ is positive.

1.2 MBQC

The workhorse of MBQC (in DV and CV) is gate teleportation, which makes it possible to apply a unitary operation from a specific set on a qumode by entangling it with another qumode and measuring. Informally, for an input state $\phi \in \mathcal{H}$ the idealised quantum circuit for gate teleportation in CV (assuming infinite squeezing, see below) is:

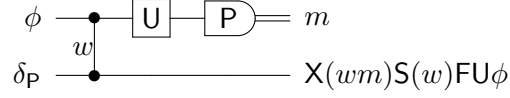

The auxiliary input $\delta_{\mathbf{P}}$ is a momentum eigenstate with eigenvalue 0, or Dirac delta distribution centered at $x = 0$. The two qumode interaction is $\text{CZ}_{12}(w)$ (equation (13)), \mathbf{U} is any unitary gate that commutes with $\text{CZ}_{12}(w)$ (such as the unitary $\mathbf{U}(\alpha, \beta, \gamma)$ from equation (14)), and we measure the first qumode in the \mathbf{P} basis. If we view \mathbf{U} as a change of basis for the measurement, this “gadget” allows us to perform universal computation using only entanglement and measurements, in the sense of Lloyd and Braunstein [Men+06; KQ21]. However, there is an extra gate $\mathbf{X}(w \cdot m)$ on the output of the computation *which depends on the result of the measurement* m . We call this the **measurement error**. In the course of a computation, it is the role of flow to describe how to correct for these measurement errors.

The representation of gate teleportation above is an idealisation, and necessarily only approximates the limit of physically achievable processes. For our needs, we develop this in detail now. Formally, Dirac deltas are tempered distributions in the Schwartz sense but cannot be interpreted as input states (even in principle) since the space of distributions \mathcal{S}^* is much larger than the state space \mathcal{H} . It is necessary to use an approximation, given by the following parametrised Gaussian states, called **squeezed states**. Let g_1 be an \mathcal{L}^2 -normalised Gaussian distribution on \mathbb{R} , explicitly given by

$$g_1(x) := \frac{1}{\sqrt{4\pi}} e^{-\frac{x^2}{2}}, \quad (21)$$

and put $g_\eta := S(\eta)g_1$.⁴ In other words,

$$g_\eta(x) = \frac{1}{\sqrt{4\pi\eta^2}} e^{-\frac{x^2}{2\eta^2}}. \quad (22)$$

In the limit $\eta \rightarrow +\infty$, this state will play the role of the auxiliary state for the teleportation, but as per the previous discussion, $\lim_{\eta \rightarrow +\infty} g_\eta \notin \mathcal{H}$, i.e. the limit is divergent in state space. One might think of this infinitely-squeezed limit as a momentum eigenstate, but it is not formally a member of the Hilbert space and should not be treated as such. In particular, it does not behave well under measurement since this would correspond to taking the inner product of two distributions, which is not well-defined in the Schwartz theory. However, as we shall see, the teleportation map *does* converge to a unitary acting on \mathcal{H} .

The circuit for the gate teleportation procedure with input $\rho \in D(\mathcal{H})$ and denoting σ_η the density operator of a squeezed state g_η (as discussed in section 1.1) is

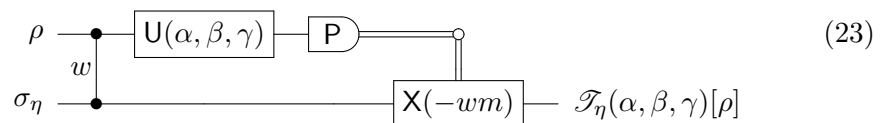

⁴From a physical perspective, g_1 is the vacuum state uniquely defined by $(\mathbf{Q} + i\mathbf{P})g_0 = 0$.

where the output is given by a quantum channel $\mathcal{T}_\eta(\alpha, \beta, \gamma)$ which is not unitary in general.

In order to give an explicit form for $\mathcal{T}_\eta(\alpha, \beta, \gamma)$, we resort to the following “trick”: we identify the circuits

$$\begin{array}{c} \text{---} \text{P} \text{---} \\ \text{---} \text{X}(-wm) \text{---} \end{array} = \begin{array}{c} \text{---} \oplus \text{---} \text{P} \text{---} \\ \text{---} \text{w} \oplus \text{---} \end{array}, \quad (24)$$

where in both circuits the outcome of the measurement is discarded. The two-sided control gate in the RHS represents the unitary gate $\exp(iwP_1P_2)$. That these two circuits are equal is intuitively understood from the finite-dimensional case, and can be verified by explicit calculation, for example on a basis of \mathcal{H} . Then, the output state of the RHS of this equation can be expressed using the partial trace:

$$\rho_{\text{out}} = \text{tr}_1(\exp(iwP_1P_2)\rho_{\text{in}} \exp(-iwP_1P_2)) = \text{tr}_1(\mathcal{U}_{\exp(iwP_1P_2)}[\rho_{\text{in}}]), \quad (25)$$

where \mathcal{U}_{U} is the quantum channel corresponding to conjugation by the unitary U .

It follows that the quantum channel implemented by the quantum gate teleportation protocol (equation (23)) is, for any input state $\rho \in D(\mathcal{H})$,

$$\mathcal{T}_\eta(\alpha, \beta, \gamma, w)[\rho] = \text{tr}_1 \circ \mathcal{U}_{\exp(iwP_1P_2)} \circ \mathcal{U}_{\text{U}_1(\alpha, \beta, \gamma)} \circ \mathcal{U}_{\text{CZ}_{1,2}(w)}[\rho \otimes \sigma_\eta]. \quad (26)$$

Proposition 1 (Teleportation convergence). *For any $\alpha, \beta, \gamma, w \in \mathbb{R}$ and any $\rho \in D(\mathcal{H})$,*

$$\lim_{\eta \rightarrow \infty} \mathcal{T}_\eta(\alpha, \beta, \gamma, w)[\rho] = \mathcal{U}_{\mathcal{S}(w)\text{FU}(\alpha, \beta, \gamma)}[\rho], \quad (27)$$

where \mathcal{U}_{U} is the quantum channel corresponding to conjugation by the unitary U .

Proof. The proof is left to appendix A.1. □

As discussed previously, this is equivalent to convergence in the strong topology on the set of quantum channels, which is a weaker notion than uniform convergence [SH08]. This is the best we can expect for quantum teleportation procedures in CV in general (see [Wil18; PLB18] for a discussion). However, if we restrict the set of states to a compact subset, such as when the total energy is bounded, this result can be strengthened to uniform convergence [SW20].

The question of convergence in the infinite squeezing limit has been considered for some slightly different but related protocols, such as the convergence of the quantum state teleportation protocol of [Wil18; SW20].⁵ Their result does not immediately apply in our case, but we use some of their ideas as well as some standard results of functional analysis in formulating our proof.

1.3 Graph states

An \mathbb{R} -edge-weighted graph G is a pair (V, A) consisting of a set V of vertices and a symmetric matrix $A \in \mathbb{R}^{|V| \times |V|}$, the **adjacency matrix** of G , which identifies the weight of each

⁵The quantum state teleportation protocol should not be confused with the gate teleportation we use in this article. The state teleportation involves three qumodes: an initial qumode is teleported using an auxiliary two qumode state and entangling two-qumode measurement. In contrast, the gate teleportation only involves two qumodes.

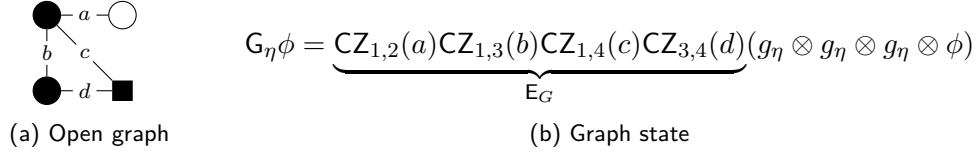

Figure 1: Example of an open graph (a) and the associated graph state (b). Black vertices are to be measured, white vertices are outputs, and the square vertex represents an arbitrary input $\phi \in \mathcal{H}$.

edge. Furthermore: if $A_{j,k} = 0$ then there is no edge between j and k ; and for any $j \in G$, $A_{j,j} = 0$. If $j \in V$ we write $N(j) := \{k \in V \mid A_{j,k} \neq 0\}$ the set of neighbours of j in G , excluding j itself.

A (CV) **open graph** (G, I, O) is an undirected \mathbb{R} -edge-weighted graph $G = (V, A)$, along with two subsets I and O of V , which correspond to the inputs and outputs of a computation. To this abstract graph, we associate a physical resource state, the **graph state**, to be used in a computation: each vertex j of the graph corresponds to a single qumode and thus to a single pair $\{Q_j, P_j\}$ [ZB06; Men+06]. This graphical notation is also somewhat similar to later works for Gaussian states [Zha08; Zha10; MFv11], although with a different focus: our notation only represents a small subset of the full set of multimode Gaussian states, but is used to reason about non-Gaussian operations on that state.

For a given input state ψ on $|I|$ modes, the graph state can be constructed as follows:

1. Initialise each non-input qumode, $j \in I^c$, in the squeezed state g_η , resulting in a separable state of the form $g_\eta^{\otimes |I^c|} \otimes \psi$.
2. For each edge in the graph between vertices j and k with weight $A_{j,k} \in \mathbb{R}$, apply the entangling operation $\text{CZ}_{j,k}(A_{j,k})$ between the corresponding qumodes.

We denote E_G the product of the entanglement operators used to construct the graph state (since these all commute no caution is needed with the order of the product).

For a given open graph (G, I, O) , and input state $\rho \in D(\mathcal{H}^{\otimes |I|})$, we write the corresponding “graph” state:

$$\mathcal{G}_\eta[\rho] = \mathcal{U}_{E_G}(\rho \bigotimes_{j \in I^c} \sigma_\eta). \quad (28)$$

\mathcal{G}_η is a quantum channel as the composition of an isometry and a unitary. For a pure input state $\phi \in \mathcal{H}^{\otimes |I|}$, we of course have the corresponding isometry $G_\eta\phi = E_G(\phi \otimes_{j \in I^c} g_\eta)$. An example of such a graph state is represented figure 1. We shall use the structure of the open graph to study computations using the graph state. These graph states admit approximate stabilisers, which can be understood as stabilisers in the infinite-squeezing limit:

Lemma 2 (Approximate stabilisers). *Let (G, I, O) be an open graph, then, for any $k \in I^c$ and $s \in \mathbb{R}$,*

$$\lim_{\eta \rightarrow \infty} \left\| \mathcal{U}_{X_j(s)} \prod_{k \in N(k)} Z_k(A_{j,k}s) \circ \mathcal{G}_\eta[\rho] - \mathcal{G}_\eta[\rho] \right\| = 0. \quad (29)$$

Proof. Since we do not actually need this lemma to prove our main results, we omit its proof, which is in any case a simpler version of the proof of lemma 16. \square

The main results of this article correspond to direct generalisations of proposition 1 to measurement procedures over arbitrary graph states. The question is: given a graph state, is there an order to measure the vertices (of the graph state) in such that we can

always correct for the resulting measurement errors? In such a scheme, the measurement error spreads over several edges to more than one adjacent vertex and we need a more subtle correction strategy, culminating in our definition of CV-flow and a corresponding correction protocol. In section 2, we exhibit our CV-flow condition and a corresponding MBQC procedure, in theorem I. Then, in section 3 of the paper, we extract the unitary implemented by this MBQC protocol, proving a direct equivalent to proposition 1: when $|I| = |O|$, the protocol converges strongly to the extracted unitary which acts on the input state. This is the content of theorem II.

2 Correction procedures

We are now ready to begin our study of CV graph states for CV-MBQC. We first show that the original flow condition, causal flow [DK06], also holds in continuous variables and results in a nearly identical MBQC protocol. We then state a generalised condition which we call CV-flow, inspired by g-flow but valid for continuous variables and different to g-flow. These conditions are associated with corresponding CV-MBQC correction protocols. While the CV-flow protocol subsumes the original flow protocol as far as CV-MBQC is concerned, causal flow is still worth understanding on its own in this context, not least because the proof of theorem II reduces the CV-flow case to the causal flow case.

Appendices. In addition to the content of this section, appendix B describes a polynomial-time algorithm for determining a CV-flow for an open graph, whenever it has one, following almost exactly the qubit case by Mhalla and Perdrix [MP08]. Appendix C contains a comparison between CV-flow and the original g-flow condition for qubits, when this makes sense. Appendix D contains an example of depth-complexity advantage using CV-MBQC compared to a circuit acting on the same number of inputs.

2.1 Causal flow in continuous variables

In this section, we see how the causal flow condition extends to continuous variables. We additionally allow for weighted graphs, but this does not change the definition.

Definition 3 ([DK06]). An open graph (G, I, O) has **causal flow** if there exists a map $f : O^c \rightarrow I^c$ and a partial order \prec over G such that for all $i \in O^c$:

- $A_{i,f(i)} \neq 0$;
- $i \prec f(i)$;
- for every $k \in N(f(i)) \setminus \{i\}$, we have $i \prec k$. ┘

The order \prec is interpreted as a measurement order for the MBQC. When an open graph has causal flow (f, \prec) , the function f identifies for each measurement of a vertex j a single, *as-of-yet unmeasured* neighbouring vertex $f(j)$ on which it is possible to correct for the measurement error. This renders the corresponding CV-MBQC protocol: after constructing the graph state,

1. measure the non-output vertices in the graph, in any order which is a linear extension of \prec , in the basis corresponding to $U(\alpha, \beta, \gamma)$ —for example, by applying $U(\alpha, \beta, \gamma)$ and measuring P ; and,

2. immediately after each measurement (say of vertex j), and before any other measurement is performed, correct for the measurement error m_j onto $f(j)$, by applying

$$\mathbb{C}_j(m_j) := \mathbb{X}_{f(j)}(-A_{j,f(j)}^{-1}m_j) \prod_{k \in N(f(j)) \setminus \{j\}} \mathbb{Z}_k(-A_{j,f(j)}^{-1}A_{f(j),k}m_j). \quad (30)$$

We will now see how (30) can be viewed as an a-causal correction, through the completion of a stabiliser (as in the discrete case [DK06; Bro+07; MK14]). We first note that the state after measuring vertex j and getting result m_j is equivalent to the state if one had first applied $\mathbb{Z}_j(-m_j)$ and then measured, getting result 0. Since the result 0 corresponds to the ideal computation branch, the correction ideally corresponds to undoing this $\mathbb{Z}_j(-m_j)$. However, this cannot be done on vertex j because we would have to do it before the measurement result were known. From this point of view the above correction acts to a-causally implement $\mathbb{Z}_j(-m_j)$ through the stabiliser relation.

To see this we note that the unitary

$$\mathbb{X}_{f(j)}(-A_{j,f(j)}^{-1}m_j) \prod_{k \in N(f(j))} \mathbb{Z}_k(-A_{j,f(j)}^{-1}A_{f(j),k}m_j) = \mathbb{C}_j(m_j)\mathbb{Z}_{f(j)}(m_j) \quad (31)$$

is a stabiliser for the graph state in the infinite squeezing limit—that is, its action leaves the state unchanged, as described in lemma 2. Thus, application of $\mathbb{C}_j(m_j)$ is, in the limit, equivalent to applying $\mathbb{Z}_{f(j)}(m_j)$.

In this way, we can see the third condition in the definition as merely imposing that all the vertices acted upon by \mathbb{C}_j have not been measured when we try to complete this stabiliser.

To see that the correction (30) affects the a-causal correction of $\mathbb{Z}_j(-m_j)$ another way, we can commute the correction through the graph operations:

$$\mathbb{C}_j(m_j) \prod_{k \in N(f(j))} \mathbb{C}\mathbb{Z}_{j,k}(A_{j,k}) = \mathbb{X}_{f(j)}(-A_{j,f(j)}^{-1}m_j) \prod_{k \in N(f(j)) \setminus \{j\}} \mathbb{Z}_k(-A_{j,f(j)}^{-1}A_{f(j),k}m_j) \cdot \prod_{k \in N(f(j))} \mathbb{C}\mathbb{Z}_{j,k}(A_{j,k}) \quad (32)$$

$$= \prod_{k \in N(f(j)) \setminus \{j\}} \mathbb{C}\mathbb{Z}_{f(j),k}(A_{j,k}) \mathbb{Z}_j(m_j) \mathbb{C}\mathbb{Z}_{f(j),j}(A_{j,f(j)}). \quad (33)$$

In this picture, we see that the correction $\mathbb{C}_j(m_j)$ has a *back-action* $\mathbb{Z}_j(m_j)$ on the vertex j even though it has already been measured. This back-action appears before the measurement, even though the correction is applied after the measurement.

Let $\vec{\alpha}, \vec{\beta}, \vec{\gamma} \in \mathbb{R}^{|O^c|}$ identify measurement angles for each non-output mode as in step 1, then, for a given open graph with causal flow, we denote $\mathcal{F}_\eta(\vec{\alpha}, \vec{\beta}, \vec{\gamma})$ the quantum map corresponding to this MBQC procedure starting with the corresponding graph state with local squeezing factor η . Using the same trick as for the gate teleportation, for any input state $\rho \in D(\mathcal{H}^{\otimes |I|})$ we can write this quantum channel as:

$$\begin{aligned} & \mathcal{F}_\eta(\vec{\alpha}, \vec{\beta}, \vec{\gamma})[\rho] \\ &= \left(\prod_{j \in O^c}^{\prec} \text{tr}_j \circ \mathcal{U}_{\exp(-i\mathbf{P}_j \cdot \mathbf{P}_{f(j)})} \circ \mathcal{U}_{\exp(-i\mathbf{P}_v \sum_{k \in N(f(j)) \setminus \{j\}} A_{j,f(j)}^{-1} A_{f(j),k} \mathbf{Q}_k)} \circ \mathcal{U}_{\mathbf{U}_v(\alpha_v, \beta_v, \gamma_v)} \right) \\ & \quad \circ \mathcal{G}_\eta[\rho], \end{aligned} \quad (34)$$

where the product is to be interpreted as sequential composition of channels, and is ordered by the measurement order \prec . Here once again, the trace over the subspace of qumode j

corresponds to the measurement of that qumode, and the 2-qumode unitaries simulate the classically-controlled corrections in the protocol and described by equation (31). Namely, $\exp(-i\mathbf{P}_j \cdot \mathbf{P}_{f(j)})$ simulates the X part of the correction, and

$$\exp\left(-i\mathbf{P}_v \sum_{k \in N(f(j)) \setminus \{j\}} A_{j,f(j)}^{-1} A_{f(j),k} \mathbf{Q}_k\right) \quad (35)$$

simulates all of the Z parts on neighbours, which commute thus can be written as a single exponential.

Then, we have the following:

Proposition 4 (Causal flow protocol). *Suppose the open graph (G, I, O) has causal flow, then for any $\vec{\alpha}, \vec{\beta}, \vec{\gamma} \in \mathbb{R}^{|O|}$ and any input state, the corresponding MBQC procedure $\mathcal{F}_\eta(\vec{\alpha}, \vec{\beta}, \vec{\gamma})$ is runnable: no corrections depend on the outcome of measurements before they are made, and no corrections are made on vertices after they are measured.*

Proof. This is clear by the condition that $i \prec f(i)$: we always measure node i before the vertex $f(i)$ onto which we perform the corresponding correction. \square

2.2 CV-flow

In Browne et al. [Bro+07] a more general notion of flow was presented for qubit MBQC, by loosening the conditions of causal flow. In particular, this is done by allowing corrections to be applied on more than one neighbour and loosening the condition on neighbours of the correction vertex - they no longer need to all be unmeasured. This is possible by selecting vertices on which to correct in such a way that their different contributions add up to correct the measurement error. As well as allowing for more general correction strategies, which can, for example decrease the depth of a computation (number of measurement rounds), it also allows for measurements on different Pauli planes (the X-Y, X-Z, Y-Z planes).

This leads to the definition of *g-flow*, which is similar to Definition 3 above for causal flow, but where the single vertex $f(i)$ is replaced by a set of vertices, and the conditions on this set are a bit more involved, and depend on the choice of basis measurement (see [Bro+07] and Definition 24 in section 2.3). It can simply be understood from the stabiliser perspective, that this set of vertices correspond to the set of stabilisers that should be applied to correct the measurement error. Then the conditions on their choice are such that i) they can do this correction (i.e. depending on the plane, the corrections are equivalent to applying a Z, Y, or X Pauli on the measured qubit, via the stabiliser relation), and that ii) they should not interfere with previous corrections (i.e. the stabiliser has no part on measured qubits).

In the extension to continuous variables, we instead phrase our conditions in terms of matrices. This form can be used for qubits also, but in the case of CV (and qudits [Boo+21]) it is much simpler to understand than writing a form similar to 3. For this reason, we now develop the matrix formulation, rather than present the original form of [Bro+07]. In section 2.3 the form of [Bro+07] can be found, along with the reduction of the matrix form to the original form for qubits.

To begin, given a candidate measurement order, we consider, at each step of that order, a partition, or cut, of the graph into 2 subsets: vertices that have yet to be measured (that

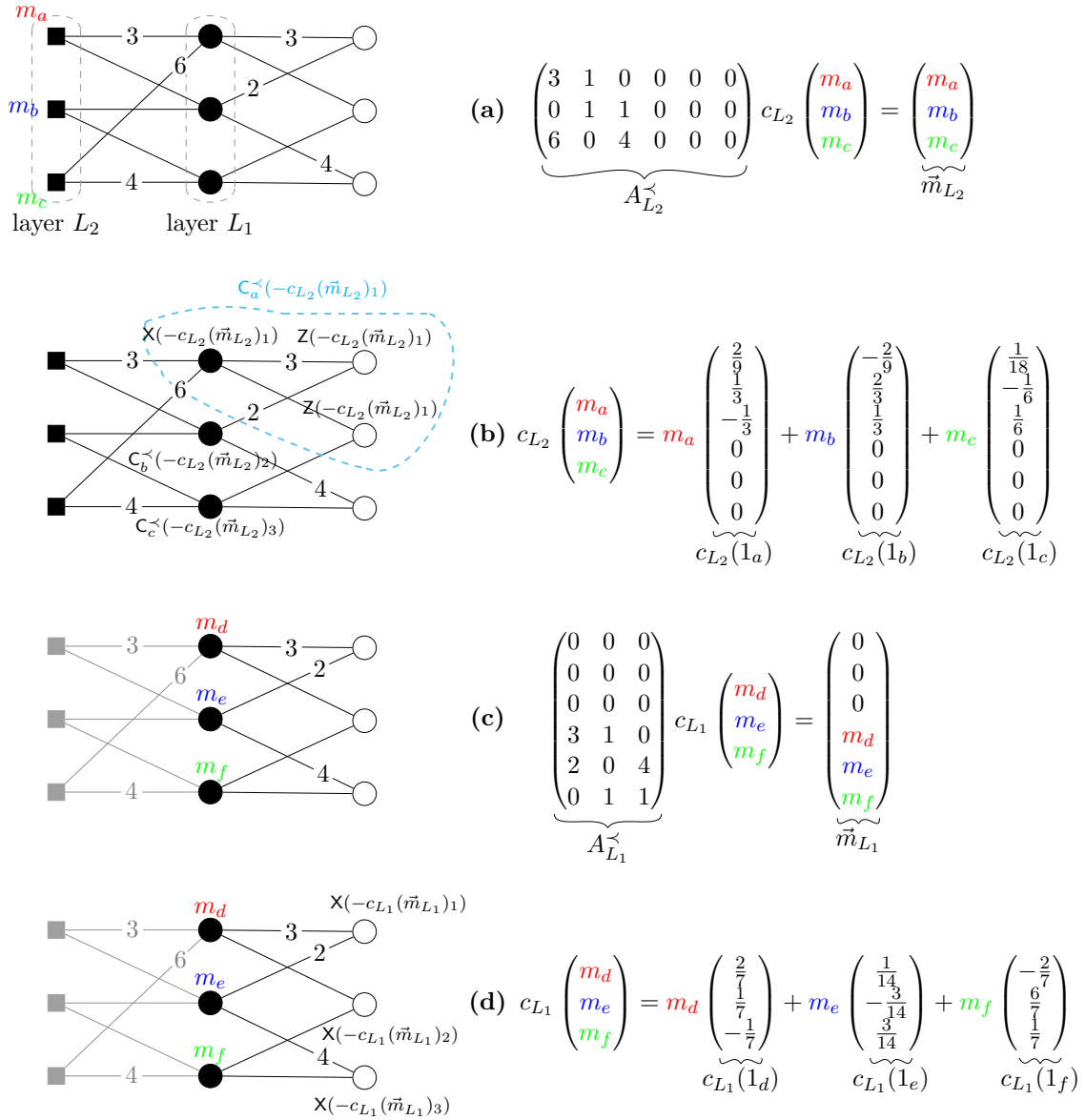

Figure 2: Example of the MBQC procedure based on a CV-flow. **(a)** We start with a graph state with a candidate measurement order: the vertices in layer 2 must be measured before layer 1. As explained in section 3, all CV-flows can be broken up into such a sequence of layers such that all the vertices within a layer can be measured simultaneously. We perform measurements on the vertices in layer 2 (in a given basis for the unitary (14)), obtaining measurement outcomes $\vec{m}_{L_2} = (m_a, m_b, m_c)^T$ and leading to the correction equation on the right of (a), which is a direction application of equation (40). **(b)** This linear equation has a solution for any measurement outcomes giving a CV-flow for layer 2 as per definition 6, which we decompose into the different contributions from the measurement of each vertex as per lemma 8 (right). This leads to a correction procedure for the measurements in the MBQC procedure (left). The corrections C take the form of partial stabilisers as described in equations (69) and (42). **(c)** We then measure the vertices in the layer 1, with measurement outcomes $\vec{m}_{L_1} = (m_d, m_e, m_f)^T$. The previously measured vertices, which are no longer accessible for corrections, have been grayed out. This second set of measurements has its own correction equation. **(d)** The solution to the linear equation (see (41) and (40)), and corresponding correction procedure for layer 1. Since at this point, we have measured all the vertices in the graph, the MBQC procedure is complete. Furthermore, as we have seen, for this measurement order it is possible to correct for any measurement error at any of the measurements and the open graph has a CV-flow.

can be used for corrections), and vertices that have already been measured (for which we need to be careful about unwanted back-actions).

If (X, Y) is a pair of subsets of V , we define $A[X, Y]$ as the submatrix obtained from the adjacency matrix of G by keeping only the rows corresponding to vertices in X and the columns corresponding to vertices in Y .

Definition 5. Let (G, I, O) be an open graph, $<$ a total order over the vertices V of G and $A^<$ be the adjacency matrix of G such that its columns and rows are ordered by $<$. Further, define $P(j)$ (the “past” of node j) as the subset of V such that $k \in P(j)$ implies $k \leq j$. Then the **correction matrix** $A_j^<$ of a vertex $j \in V$ is the matrix $A_j^< := A[P(j), (P(j) \cup I)^c]$. \lrcorner

The correction matrix tells us how X and Z operations on unmeasured nodes are going to affect the previously measured nodes, thus it allows us to determine how to apply a correction on a specific vertex by controlling this back-action.

Definition 6. An open graph (G, I, O) has **CV-flow** if there exists a partial order \prec on O^c such that for any total order $<$ that is a linear extension of \prec and every $j \in O^c$, there is a function $c_j : \mathbb{R} \rightarrow \mathbb{R}^{|V|-|P(j) \cup I|}$ such that for all $m \in \mathbb{R}$ the linear equation

$$A_j^< c_j(m) = \begin{pmatrix} 0 \\ \vdots \\ 0 \\ m \end{pmatrix} \text{ holds,} \quad (36)$$

where $A_j^<$ is the correction matrix of vertex j . Letting $(c_j)_{j \in O^c}$ be such a set of functions, we call the pair $(\prec, (c_j))$ a CV-flow for (G, I, O) . \lrcorner

This definition is somewhat convoluted in order to allow the formalism to describe partial orders of measurement rather than only total orders (which would give a simpler definition). This is so that we can take into account situations where several qumodes can be measured simultaneously without contradictions (see lemma 8 and appendix D).

Lemma 7. *If $(\prec, (c_j)_{j \in O^c})$ is a CV-flow for an open graph (G, I, O) , then the functions c_j can be chosen as \mathbb{R} -linear, that is, for each $i \in O^c$ and any $m \in \mathbb{R}$, $c_j(m) = m \cdot c_j(1)$.*

Proof. Let $c_j(1)$ be such that equation (45) holds. Then,

$$A_j^<(m \cdot c_j(1)) = m \cdot A_j^<c_j(1) = m \cdot \begin{pmatrix} 0 \\ \vdots \\ 0 \\ 1 \end{pmatrix} = \begin{pmatrix} 0 \\ \vdots \\ 0 \\ m \end{pmatrix} \quad (37) \quad \square$$

Now, there is a correction procedure on an open graph (G, I, O) if there is a measurement order such that each measurement error can be corrected for without any backaction on previously measured vertices and such an order is guaranteed by the existence of a CV-flow. For any open graph with CV-flow, the MBQC protocol follows from generalising the causal flow protocol:

1. measure the non-output vertices in the graph in any order which is a linear extension of \prec , in the basis corresponding to $U(\alpha, \beta, \gamma)$; and,
2. immediately after each measurement (say of vertex j), and before any other measurement is performed, correct for the measurement error m_j by applying

$$C_j^{\prec}(m_j) := \prod_{k \in V \setminus P(j) \cup I} \left(X_k(-c_j(m_j)_k) \prod_{\ell \in N(k) \setminus P(j)} Z_\ell(-A_{k,\ell} \cdot c_j(m_j)_k) \right), \quad (38)$$

where $c_j(m_j)_k$ is the k -th element of the vector $c_j(m_j) \in \mathbb{R}^{|V| - |P(j) \cup I|}$.

Keen readers will note that performing the corrections following equation (69) might require performing very large number of Pauli operations (performing all corrections in the MBQC would be approximately $O(|V|^3)$ Pauli operations). This form gives a better intuition for what is going on in terms of partial graph stabilisers, but it can be simplified as follows. The idea is that partial stabilisers for the same measurement error commute: pulling the partial stabilisers through the graph operations to meet the measurement error (as in equation (33)), one recovers full graph stabilisers, which are known to commute. Then, we can sum all of the Z corrections that act on the same vertex, resulting in the reduced form for equation (69):

$$C_j^{\prec}(m_j) := \left(\prod_{k \in V \setminus P(j) \cup I} X_k(-c_j(m_j)_k) \right) \left(\prod_{k \in V \setminus P(j) \cup I} Z_k(-\sum_{\ell \in V} A_{k,\ell} \cdot c_j(m_j)_k) \right), \quad (39)$$

which requires only $O(|V|^2)$ corrections for the MBQC. Typically however, the number of corrections will be much smaller than this since we only ever act on the neighbours of neighbours of the measured vertex at each step, and graphs which are too connected are unlikely to have CV-flow since then the equations (45) become inconsistent.

In fact, under this second description of corrections, one can show that the number of corrections is upper-bounded by $|V|(|V| - 1)$. To prove this would involve introducing more technicalities which are beyond the scope of this article. Instead, we refer to [Boo+21] which treats the question of qudit MBQC but whose arguments lift immediately to CV if one uses the same analogy as we do in section 4 (but in the opposite direction).

Remark. It is straightforward how to extend these definitions to simultaneously correct for a subset $L \subseteq O^c$ of vertices *unrelated* by \prec : for any total linear extension $<$ of \prec let $P(L)$ be the subset of V such that whenever $k \in P(L)$, for some $j \in L$ we have $k \leq j$. We can then define the correction matrix $A_L^< = A^{<}[P(L), V \setminus (P(L) \cup I)]$ of L identically to definition 20. There is a simultaneous correction procedure for L if there is a function $c_L : \mathbb{R}^{|L|} \rightarrow \mathbb{R}^{|V| - |P(L) \cup I|}$ such that

$$A_L^< c_L(\vec{m}) = \begin{pmatrix} 0 \\ \vdots \\ 0 \\ \vec{m} \end{pmatrix} \quad \text{for all potential measurement outcomes } \vec{m} \in \mathbb{R}^{|L|}. \quad (40)$$

From the proof of lemma 7, we can also see that

Lemma 8 (CV-flow linearity). *The function c_L from equation (40) can be chosen as \mathbb{R} -multilinear, in the following sense: for any $\vec{m} \in \mathbb{R}^{|L|}$,*

$$c_L(\vec{m}) = \sum_{k \in L} m_k \cdot c_L(1_k), \quad (41)$$

where 1_k is the column vector with a single 1 in its k -th row and 0 elsewhere.

It is therefore possible to measure several vertices at once in step 1 of the procedure, so long as one never measures two vertices comparable by \prec in a single measurement step. The correction then takes the form of a product of corrections of the form of equation (69):

$$C_L^{\prec}(\vec{m}) := \prod_{j \in L} C_j^{\prec}(m_j), \quad (42)$$

and where $C_j^{\prec}(m_j)$ is calculated using $c_j(m_j) = m_j \cdot c_L(1_j)$ by lemma 8. We will use this form in section 3. A simple example is worked out in figure 2. \lrcorner

As for causal flow, let $\vec{\alpha}, \vec{\beta}, \vec{\gamma} \in \mathbb{R}^{|O^c|}$ identify measurement angles for each non-output mode as in step 1, then, for a given open graph with causal flow, $\mathcal{C}_\eta^\delta(\vec{\alpha}, \vec{\beta}, \vec{\gamma})$ denotes the quantum map corresponding to this MBQC procedure starting with the corresponding graph state with local squeezing η . Once again we can write this channel explicitly by replacing the corrections with multi-qumode unitary gates simulating classical control:

$$\begin{aligned} & \mathcal{C}_\eta(\vec{\alpha}, \vec{\beta}, \vec{\gamma})[\rho] \\ &= \left(\prod_{j \in O^c}^{\prec} \text{tr}_j \circ \mathcal{U}_{\exp(-i\mathbf{P}_j c_j(1) \cdot \vec{\beta})} \circ \mathcal{U}_{\exp(-i\mathbf{P}_v \sum_{k \in N(f(j)) \setminus \{j\}} A_{j,f(j)}^{-1} A_{f(j),k} \mathbf{Q}_k)} \circ \mathcal{U}_{\mathbf{U}_v(\alpha_v, \beta_v, \gamma_v)} \right) \\ & \quad \circ \mathcal{G}_\eta[\rho], \end{aligned} \quad (43)$$

where

$$c_j(1) \cdot \vec{\beta} = \sum_{k \in V \setminus (P(j) \cup I)} c_j(1)_k \mathbf{P}_k. \quad (44)$$

Theorem 1 (CV-flow protocol). *Suppose the open graph (G, I, O) has CV-flow, then for any $\vec{\alpha}, \vec{\beta}, \vec{\gamma} \in \mathbb{R}^{|O^c|}$ and any input state, the corresponding MBQC procedure $\mathcal{C}_\eta(\vec{\alpha}, \vec{\beta}, \vec{\gamma})$ is runnable.*

Proof. This is true by construction, since we only ever consider corrections for a given measurement error that act on unmeasured nodes at that step in the MBQC procedure. \square

2.3 Recovering g-flow

Generalised flow, or g -flow, is the flow condition which inspired CV-flow. It was originally formulated in terms of parity conditions on the connectivity of the open graph for the case of MBQC with qubits [Bro+07]. The Hilbert space of the qubit can be viewed as a space of functions $\mathbb{Z}_2 \rightarrow \mathbb{C}$, and thus the open graphs in question are \mathbb{Z}_2 -edge-weighted. However, note that an open \mathbb{Z}_2 -graph can equivalently be viewed as an unweighted open graph. If $A \subseteq V$, we write $\text{Odd}(A)$ the subset of $\bigcup_{a \in A} N(a)$ of vertices that are neighbours of an odd number of elements of A , then:

Definition 9 ([Bro+07]). An open \mathbb{Z}_2 -graph (G, I, O) has *g-flow* if there exists a map $g : O^c \rightarrow 2^{I^c}$ and a partial order \prec on V such that for all $i \in O^c$,

- if $j \in g(i)$ and $i \neq j$ then $i \prec j$;
- if $j \preceq i$ and $i \neq j$ then $j \notin \text{Odd}(g(i))$;
- $i \notin g(i)$ and $i \in \text{Odd}(g(i))$. ┘

The idea is that, in the case of qubits, the Pauli operations used for correction are all self-inverse, $X^2 = I$ and $Z^2 = I$, and the usual graph stabilisers are used for corrections: $K_j = X_j \prod_{k \in N(j)} Z_k$ for any $j \in I^c$. As a result, $K_j^2 = I$. g-flow has the same interpretation as CV-flow: it controls the back-action of partial stabilisers acting on unmeasured vertices at each step of the measurement procedure.

Making this interpretation explicit, these parity conditions can straightforwardly be reinterpreted as linear equations over \mathbb{Z}_2 , involving (submatrices of) the adjacency matrix of the graph. Using the same notation as for CV-flow:

Proposition 10. *An open graph (G, I, O) has g-flow (g, \prec) if and only if for any total order $<$ that is a linear extension of \prec and every $j \in O^c$, there is a function $c_j : \mathbb{Z}_2 \rightarrow \mathbb{Z}_2^{|V|-|P(j) \cup I|}$ such that for all $m \in \mathbb{Z}_2$ the linear equation*

$$A_j^< c_j(m) = \begin{pmatrix} 0 \\ \vdots \\ 0 \\ m \end{pmatrix} \text{ holds,} \quad (45)$$

where $A_j^<$ is the correction matrix of vertex j .

Hopefully, it should be clear that CV-flow, definition 6, corresponds exactly to this formulation of g-flow, where one replaces the finite field \mathbb{Z}_2 with \mathbb{R} .

The proof of this statement follows from identifying each set $g(j)$ with a column vector $v^j \in \mathbb{Z}_2^{|V|-|P(j) \cup I|}$:

$$v_u^j = \begin{cases} 1 & \text{if } u \in g(j); \\ 0 & \text{otherwise.} \end{cases} \quad (46)$$

Then setting $c_j(m) = m \cdot v^j$ gives the desired function. We omit the formal proof as it mainly involves technical calculation of matrix elements which are therefore not particularly informative.

3 Circuit extraction

We have shown that a correction procedure is possible when the open graph has CV-flow. We now address the induced quantum map and the question of convergence of these teleportations. In general, for an arbitrary graph state, even one with CV-flow, the MBQC procedure is not convergent. It is possible for the output state to contain squeezing dependant components which diverge in the limit.

We will see that for an open graph (G, I, O) with $|I| < |O|$, an MBQC protocol is equivalent to one based on an open graph (G, I', O) , where $I \subseteq I'$ and $|I'| = |O|$. The

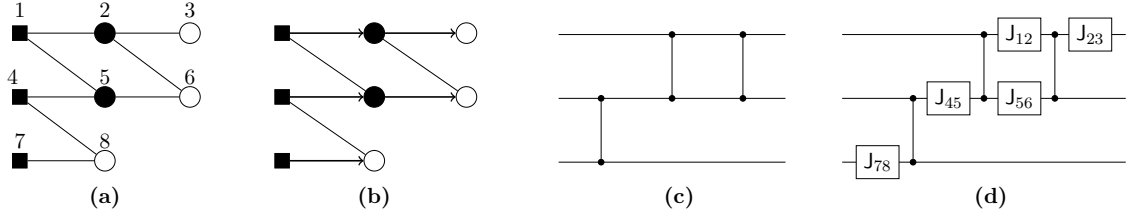

Figure 3: An example of circuit extraction of an MBQC for an open graph with causal flow, using star pattern transformation as described in section 3.1. Starting from an open graph with a causal flow **(a)**, we identify a path cover of the graph that agrees with the causal flow (thick edges directed $u \rightarrow f(u)$ for each $u \in O^c$) **(b)**, and each path as a wire in a quantum circuit **(c)**. The remaining edges of the graph implement CZ gates in the circuit. Finally, each causal flow edge implements a unitary of the form given by equation (47), and we obtain a circuit representation of the unitary implemented by the MBQC **(d)**.

additional states in I' are auxiliary squeezed states g_η reinterpreted as inputs, and this forces divergence from the inputs to the outputs. The simplest example is given by the single-vertex open graph \bigcirc with no input and a single output.⁶ One can readily check that it trivially has CV-flow but the output is a squeezed state. As a result, when if we try to take the infinite squeezing limit the state diverges in \mathcal{H} .

As we shall see, the existence of a CV-flow also implies both that $|I| \leq |O|$ and $|O| \neq 0$, hence we conclude that a necessary and sufficient condition for the protocol to be convergent is that the open graph has as many input vertices as outputs, $|I| = |O| \neq 0$. This clearly excludes the simple counter-example presented above.

The proof will proceed by explicitly constructing the limit of the protocol, via a circuit extraction scheme inspired by [MHM15]. While the circuits extracted by our scheme as well as the broad structure of the proof are entirely analogous to that work, our proof method is quite different. The original graph-theoretical arguments using local complementation in [MHM15] are delicate to adapt to CV, so we reason instead with the adjacency matrix and correction matrices of the open graph. This method extends the DV case, and should also apply to more general MBQC scenarios beyond CV. In particular, it easily applies to qudit MBQC for any prime local dimension, as we shall see in section 4.

3.1 Star pattern transformation

In order to model the computation through the MBQC, the trick is to distinguish between “real” qumodes that undergo a unitary transformation through the MBQC (which act like the wires in a circuit undergoing gates), and auxiliary qumodes that are consumed in teleportations. In the case of causal flow, things work quite nicely as follows.

We use the following which also holds in CV (since the causal flow does not depend on edge weights, only the correction procedure):

Definition 11 ([de 08]). A **path cover** of an open graph (G, I, O) is a collection \mathcal{P} of directed edges (or arcs) in G such that

- each vertex in G is contained in exactly one path in \mathcal{P} ;

⁶This open graph is formally defined on the vertex set $\{\bigcirc\}$ as $(0, \emptyset, \{\bigcirc\})$. That is, the adjacency matrix of the graph is $G = 0$ (since there can be no self-edges from the only vertex to itself), there are no inputs $I = \emptyset$, and the only vertex is an output, $O = \{\bigcirc\}$

- each path in \mathcal{P} is either disjoint from I or intersects I only at its initial point;
- each path in \mathcal{P} intersects O only at its final point. \lrcorner

Lemma 12 (Causal flow path cover [de 08]). *Let (f, \leq) be a causal flow on an open graph (G, I, O) . Then there is a path cover \mathcal{P}_f of (G, I, O) where $x \rightarrow y$ is an arc in some path of \mathcal{P}_f if and only if $y = f(x)$.*

Lemma 12 allows us to interpret the causal flow MBQC procedure as a sequence of single qumode gate teleportations, with additional entangling operations between teleportations. In fact, the path cover \mathcal{P}_f allows us to distinguish between two types of edges in G :

- edges $(j, k) \in \mathcal{P}_f$ correspond to gate teleportations where one end is the input and the other the output;
- edges $(j, k) \notin \mathcal{P}_f$ correspond to CZ $(A_{j,k})$ gates in the final circuit.

Star pattern transformation (STP) [BK09] is a method based on this intuition for turning the MBQC protocol on an open graph with causal flow into an equivalent quantum circuit. While it was originally formulated for DV, an almost identical method functions in CV, the only real difference being the nature of the unitary gates. Assume (G, I, O) is an open graph with causal flow (f, \prec) and corresponding path cover \mathcal{P}_f , and let

$$J(w, \alpha, \beta, \gamma) := S(w)\text{FU}(\alpha, \beta, \gamma), \quad \text{and for any subset } S \subseteq V, \quad \text{CZ}_{j,S}(s) := \prod_{k \in S} \text{CZ}_{j,k}(w), \quad (47)$$

To obtain a circuit for the causal flow MBQC,

1. Interpret each path in \mathcal{P}_f as a wire (qumode) in a quantum circuit, and index the wire by the collection of vertices intersected by the path.
2. For each edge $(j, k) \notin \mathcal{P}_f$, insert a CZ $(A_{j,k})$ gate between the edges indexed by j and k .
3. For each edge $(j, k) \in \mathcal{P}_f$, insert a $J(A_{j,k}, \alpha, \beta, \gamma)$ gate after all the CZ gates for vertices $i \in \mathcal{P}_f$ such that $i \leq j$ but before all such gates for $k \leq i$.

An example is worked out in figure 3. In the ideal limit, the MBQC procedure converges to the CV SPT map. We have that:

Proposition 13 (Causal flow circuit). *Suppose the open graph (G, I, O) has a causal flow and $|I| = |O|$. Then for any $\vec{\alpha}, \vec{\beta}, \vec{\gamma} \in \mathbb{R}^{|O^c|}$ and any $\rho \in D(\mathcal{H}^{\otimes |I|})$,*

$$\lim_{\eta \rightarrow \infty} \mathcal{F}_\eta(\vec{\alpha}, \vec{\beta}, \vec{\gamma})[\rho] = \text{U}_{SPT}(\vec{\alpha}, \vec{\beta}, \vec{\gamma})\rho\text{U}_{SPT}^*(\vec{\alpha}, \vec{\beta}, \vec{\gamma}), \quad (48)$$

where U_{SPT} is the unitary corresponding to the circuit obtained by star pattern transformation of (G, I, O) . Furthermore, the condition $|I| = |O|$ is necessary.

Proof. The proof is left to appendix A.2. \square

3.2 CV-flow triangularisation

The next challenge is to do the same as above and extract a circuit, for CV-flow. From there one can treat convergence through viewing it as a sequence of teleportations. For CV-flow however, it is not obvious how to go about it, for instance one does not directly have an obvious path cover. We follow the ideas of [MHM15], associating open graphs with CV-flow to equivalent open graphs with causal flow which allows circuit extraction, albeit using quite different proof methods.

More precisely, for the general CV-flow case, we show there are totally ordered partitions of O^c called *layer decompositions* such that all the vertices in each layer can be measured simultaneously and corrected for in one step as in lemma 8—that is, there is a CV-flow from the layer into the remaining unmeasured vertices. We then show that this “one-step” CV-flow can be reduced to a causal flow for the same layer, at the cost of some additional gates acting on the unmeasured vertices. Finally, by repeating this procedure for each layer, we extract a circuit for the total MBQC procedure, as a sequence of star pattern transformation circuits and intermediate gates.

From CV-flow to causal flow

We begin by defining the decomposition into layers as follows.

Definition 14. Let (G, I, O) be a graph with CV-flow (c, \prec) . A corresponding **layer decomposition** of (G, I, O) is a partition $\{L_k\}_{k=1}^N$ of O^c such that if $i \in L_m, j \in L_n$ and $i \prec j$ then $n < m$ (as elements of \mathbb{N}). \lrcorner

It is straightforward to see that if $\{L_k\}$ is such a decomposition, we can measure the layers in the order given by $L_{k+1} \prec L_k$ and corrections are always possible. We chose this inverted ordering for layers (from the last layer measured to the first) in accordance with [MP08]. It is equally easy to see that in this procedure, we can measure all the vertices in each layer before applying any correction for measurements errors in the layer.

In order to extract causal flows from CV-flows, we need a matricial characterisation of causal flow:

Lemma 15 (Matrix form of causal flow). *Let (G, I, O) be an open graph with CV-flow for a total measurement order \prec , and $L \subseteq O^c$ a subset of vertices.⁷ Then there is a subset $C \subseteq P(L)^c$ with $|L| = |C|$ and a causal flow $L \rightarrow C$ if and only if the correction matrix A_L^{\prec} of L can be written as*

$$A_L^{\prec} = M \cdot \begin{pmatrix} X & 0 \\ Y & T \end{pmatrix} \cdot N \quad (49)$$

where M and N are permutation matrices, T is a lower triangular $|V| \times |C|$ matrix with non-zero diagonal and X, Y are arbitrary real matrices. In other words, we can turn A_L^{\prec} into the partial triangular form of equation (49) only by reordering rows and columns, which in turn corresponds to relabelling the vertices of the graph G .

Proof. (\Leftarrow) If A_L takes the form described, then the diagonal elements of T determine a single correction vertex in C for each vertex in L , as well as a measurement order such

⁷Intuitively, L can be viewed as a set of unmeasured vertices for which we are looking for a causal flow.

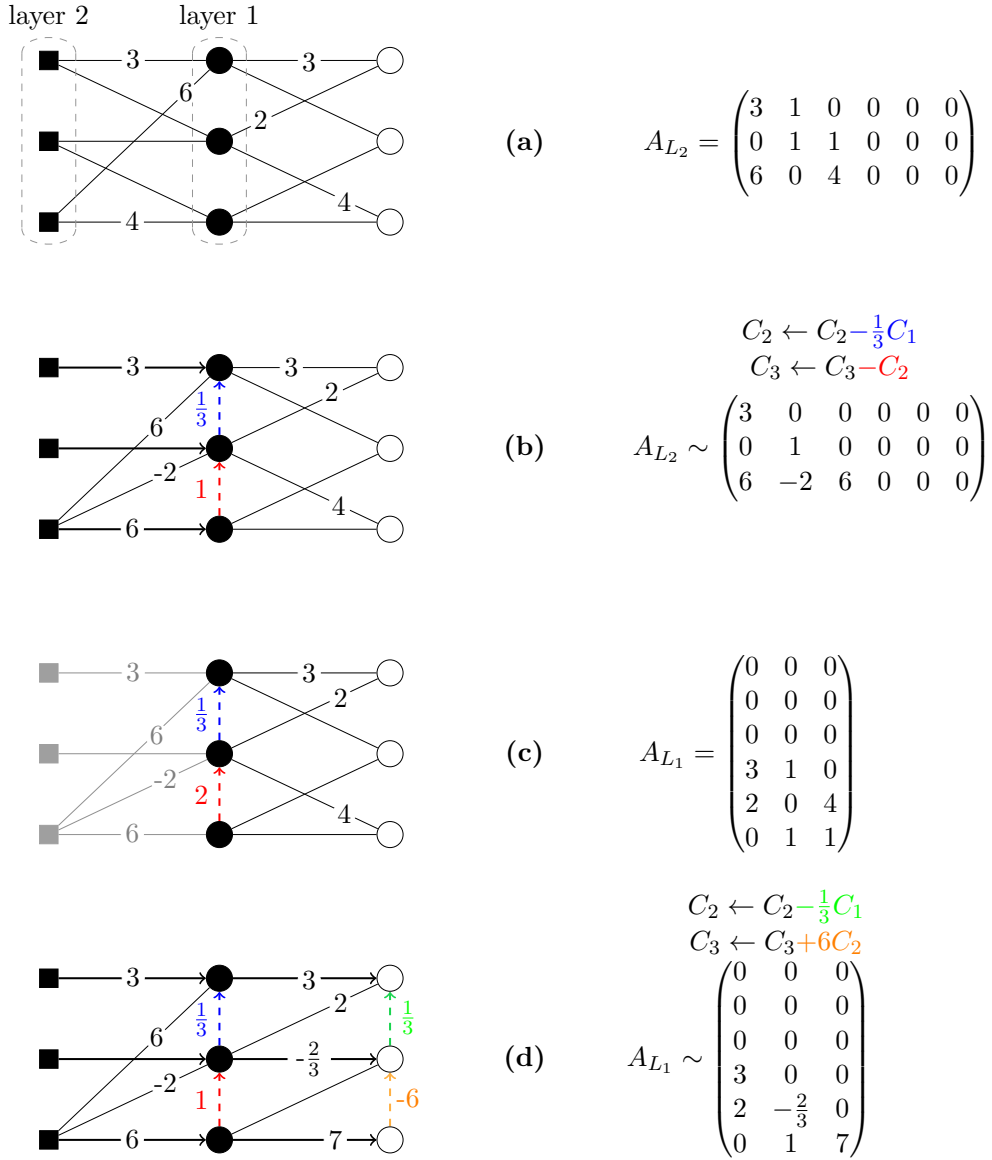

Figure 4: An example of the reduction of CV-flow to causal flow by the triangularisation procedure as described in section 3.2, using the graph with CV-flow from figure 2. We represent the open graphs in the sequential steps of the procedure (left) alongside the corresponding cut matrix for the layer in consideration at that step (right, layer 2 for (a),(b) and layer 1 for (c),(d)) and the column-space operations which are made on the cut matrices throughout. Starting from an open graph with CV-flow in two layers (a), an upper triangularisation of the cut matrix for the first layer gives a new open graph where there is now a causal flow from the vertices in layer 2 into the vertices in layer 1 (b). Since permuting columns of the correction matrix is a “free” operation (it corresponds to relabelling unmeasured nodes), the matrix has the form of lemma 15. This comes at the cost of additional weighted CX gates acting in layer 1 (lemma 17), represented as colored edges directed from the source of the CX to its target. These CX gates in the graph state are colored-matched to the term in the matrix triangularisation from which they come. We repeat this procedure for layer 1, where the vertices in layer 2 cannot be used for corrections since they come before layer 1 in the CV-flow order (c), resulting in a final graph state where the causal flow has been indicated by the bold arrows (d) directed as $u \rightarrow f(u)$ for each vertex $u \in O^c$. As per lemma 19 the endpoints of causal flow edges from different layers in the resulting open graph match up, resulting in a path cover.

that there is no back-action: the order of the columns in T (since all elements above the diagonal are now 0). Thus, there is a causal flow $L \rightarrow C$.

(\implies) If there is a causal flow $L \rightarrow C$, then there is a measurement order $<$ on L such that when measuring vertex $i \in L$, there is a single unmeasured vertex $j \in I^c$ to correct onto, and this correction has no back-action on previously measured vertices. But this implies that if we reorder the columns of j according to $<$, column i has only zeros above row j (otherwise there is a back-action), and a non-zero entry in row j (otherwise it is not possible to correct onto j). Repeating this process for each vertex in L gives $|L|$ such columns, let C be the corresponding correction vertices.

Now, $<$ induces an order $<_C$ on C by the causal flow matching. Extend $<$ by letting all previously measured vertices in $P(L)$ be less than L , and $<_C$ by letting all unmeasured vertices in $P(L)^c$ be less than C . Then, ordering the columns and rows of A_L according to $<$ and $<_C$, respectively, results in a matrix of the form described. \square

This characterisation of causal flow is the key difference between our proof method and that of Miyazaki et al. [MHM15]—where they use arguments based on local complementation to find a causal from a g-flow, we solve the comparatively easier problem of proving it is always possible to map an open state with CV-flow to one where the correction matrix takes this form.

The approach now is, having broken the measurement pattern down into layers, we show that the graph over each pair of layers can be seen as having flow, by transforming the correction matrix such that it takes the above triangular form. Reordering rows and columns of the correction matrix simply corresponds to relabelling of the vertices, however, we will also require linear addition of columns. This matrix or graphical operation, it turns out, is physically equivalent to applying CX gates, which are exactly the additional operations in the equivalence we mentioned.

This emerges from the following stabiliser condition for controlled operators, which is approximate for any finite squeezing and, as for the standard stabiliser conditions, only holds perfectly in the infinite squeezing limit. We need to extend this result beyond just graph states in order to include the states which occur in the MBQC, i.e. those of the form $\mathcal{G}_\eta[\rho]$ (equation (28)). These are essentially graph states but in which some of the auxiliary states g_η are replaced by inputs.

Then, the afore-mentioned result on stabilisers takes the form:

Lemma 16 (Approximate controlled stabilizers). *Let (G, I, O) be an open graph, $j \in G$ and $k \in I^c$. Then, for any physical input state $\rho \in D(\mathcal{H}^{\otimes |I|})$ and $s \in \mathbb{R}$,*

$$\lim_{\eta \rightarrow \infty} \left\| \mathcal{U}_{\text{CX}_{j,k}(-s)} \text{CZ}_{j,N(k)}(s) \circ \mathcal{G}_\eta[\rho] - \mathcal{G}_\eta[\rho] \right\| = 0. \quad (50)$$

Proof. The proof is left to appendix A.3. \square

In this way, the action of specific CZ operations—which are what are used to create or remove edges in the graph—are equivalent (in the infinite squeezing limit) to the application of a CX operation, since we have

$$\mathcal{U}_{\text{CX}_{j,k}(-s)} \circ \mathcal{G}_\eta[\rho] \approx \mathcal{U}_{\text{CZ}_{j,N(k)}(s)} \circ \mathcal{G}_\eta[\rho]. \quad (51)$$

This allows us to achieve the our goal:

Proposition 17 (Triangularisation). *If (G, I, O) is an open graph with CV-flow, and L_1 is the last layer in a corresponding layer decomposition $\{L_k\}_{k=1}^N$ (definition 14), then (G, I, O) is approximately equivalent to an open graph with a causal flow $L_1 \rightarrow O$, up to weighted CX gates acting in O and reordering the vertices in L_1 .*

Proof. Let A_{L_1} be the correction matrix of L_1 for a given CV-flow order. Then, we can reorder the columns of A_{L_1} by relabeling the unmeasured vertices, and we can reorder the rows of A_{L_1} by choosing a different measurement order for vertices in L_1 .

Further let $j, k \in O$, then by lemma 16 applying the gate $\text{CX}_{j,k}(-s)$ on the graph state induces new edges in the graph state *in the infinite squeezing limit*. The result on the correction matrix is the transformation

$$C_j \mapsto C_j + sC_k, \quad (52)$$

where C_j is the j -th column of A_{L_1} .

By the definition of CV-flow, for each $v \in L$ we have that

$$A_{L_1}^< c_v(1_v) = 1_v, \quad (53)$$

so that $c_v(1_v)$ gives a sum of columns A which contains a single 1 in the row corresponding to v . Repeating this for each $v \in L_1$, we obtain $|L_1|$ such columns, each with the 1 on a different row, so that by reordering rows and columns we can write A_{L_1} as

$$A_{L_1} \sim \begin{pmatrix} X & 0 \\ Y & I_{|L_1|} \end{pmatrix} \quad (54)$$

where $I_{|L_1|}$ is the $|L_1| \times |L_1|$ identity matrix. Then, A_{L_1} takes the form described in lemma 15, and this partial triangularisation procedure corresponds to extracting additional CX gates from the graph as described above. Then, the open graph (G, I, O) is approximately equivalent to a graph with causal flow $L_1 \rightarrow O$, up to CX gates acting in O . \square

The fact that the additional controlled gates act only on the outputs is crucial: it will allow us reduce the total physical map to a sequence of single-gate teleportation operations. Since the CX gates never appear in between a measurement and the corresponding CZ gate for the teleportation, nor do they act on the auxiliary squeezed states before they are consumed in the teleportation, the projective measurements can be brought forward and the squeezed inputs delayed to obtain a single gate teleportation circuit within the larger circuit representing the total physical map of the computation.

Path cover of CV-flow

Now, using these two lemmas, we obtain a causal flow from the last layer L_1 of a decomposition into a subset of the outputs by adding CX gates. Most importantly, this subset is then only connected to L_1 so it can be removed from the open graph as far as determining flows on the remainder is concerned. As a result, we can reduce a graph to a sequence of causal flows by peeling off each layer one-by-one.

Lemma 18 (Graph reduction). *If (G, I, O) is an open graph with CV-flow $(\prec, (c_j)_{j=1}^N)$, and corresponding layer decomposition $\{L_k\}_{k=1}^N$ then there is $C_1 \subseteq O$ such that there is a causal flow $L_1 \rightarrow C_1$ with $|L_1| = |C_1|$, up to a product Υ of weighted CX gates acting in O . Furthermore, let G' be the graph state obtained from the triangularisation*

procedure for layer L_1 , then $(G' \setminus C_1, I \setminus C_1, L_1 \cup (O \setminus C_1))$ has CV-flow $(\prec, (c_j)_{j=2}^N)$ and layer decomposition $\{L_k\}_{k=2}^N$.

Proof. The first part follows straightforwardly from lemmas 15 and 17. The second is immediate once one realises the following: by the third condition in the definition of causal flow, if there is a causal flow $C_1 \rightarrow L_1$, C_1 cannot be connected to any vertex in a layer $k > 1$. Since L_1 is measured last, so C_1 must be connected *only* to L_1 (and possibly O). As a result, we can remove C_1 from the graph for subsequent layers: since it is not connected to any previous layer $k > 1$, it never appears in any subsequent correction subgraphs. As a result, the truncated CV-flow and layer decomposition remain valid for the reduced graph. \square

This ‘‘peeling’’ procedure also allows us to determine a path cover of (G, I, O) , by noting that each layer causal flow has a path cover, and the endpoints of each of these covers meet up. So, by a successive applications of this lemma, we obtain the final ingredient to our proof, a CV-flow analogue of lemma 12:

Lemma 19 (CV-flow path cover). *Let (G, I, O) be an open graph with CV-flow, then there is a path cover of (G, I, O) whose edges are causal flow edges of the triangularised graph (17). If $|I| = |O|$, every path is indexed by an input.*

Proof. Let $\{L_k\}$ be a layer decomposition of (G, I, O) , and consider each vertex $j \in O$ the endpoint of a path. Then, by lemma 18 there is $C_1 \subseteq O$ such that there is a causal flow and a bijection $L_1 \rightarrow C_1$; label each vertex in L_1 by its image under the causal flow matching. Then, remove C_1 from the graph as in lemma 18, and repeat the process. Since $\bigcup_{k=1}^N L_k \cup O = G$, we eventually label the whole graph. Furthermore, the resulting paths never cross: if they did, there would be two vertices in the same layer corrected onto the same node—but this is impossible, by the definition of causal flow. Thus the resulting set of paths is a path cover for (G, I, O) .

Finally, if $|I| = |O|$, every input is the beginning of some path, since we measure all $j \in I$ but can never correct onto I . Since there are exactly $|O| = |I|$ paths, every path must begin in I and end in O , and every path is indexed by an input. \square

As a corollary, we obtain bounds on the number of inputs and outputs of an open graph if it has a CV-flow:

Corollary. *Let (G, I, O) be an open graph with CV-flow, then $|I| \leq |O|$.*

Proof. By the proof to the lemma, every input is the beginning of a path that ends in O , and these paths never cross, such that even their endpoints in O cannot coincide. Then, the collection of paths describes an injection $I \rightarrow O$, since each path uniquely associates an endpoint in O to each input. \square

Corollary. *Let (G, I, O) be a non-empty open graph with CV-flow, then $|O| \neq 0$.*

Proof. If $G \neq \emptyset$ and the open graph has CV-flow, then there is a path cover of the open graph which contains at least one path. This path must end at an output vertex, thus $|O| \neq 0$. \square

Putting it all together

We are finally ready to state our main convergence result (the proof is in appendix A):

Theorem II (CV-flow circuit). *If (G, I, O) is an open graph with CV-flow and $|I| = |O|$ then the CV-flow correction protocol converges to a unitary acting on the input state. If $\{L_k\}_{k=1}^n$ is a corresponding layer decomposition, for any $\vec{\alpha}, \vec{\beta}, \vec{\gamma} \in \mathbb{R}^{|O^c|}$ let*

$$\mathbb{W}(\vec{\alpha}, \vec{\beta}, \vec{\gamma}) := \prod_{k=1}^n \mathbb{T}^{(k)} \mathbb{U}_{SPT}^{(k)}(\vec{\alpha}, \vec{\beta}, \vec{\gamma}), \quad (55)$$

where $\mathbb{U}_{SPT}^{(k)}$ is the circuit extracted for the k -th layer using the causal flow from lemma 18, and $\mathbb{T}^{(k)}$ contains the CX gates obtained from the triangularisation of the CV-flow (lemma 17).

Then, for any $\vec{\alpha}, \vec{\beta}, \vec{\gamma} \in \mathbb{R}^{|O^c|}$ and any physical input state $\rho \in D(\mathcal{H}^{\otimes |I|})$,

$$\lim_{\eta \rightarrow \infty} \mathcal{C}_\eta(\vec{\alpha}, \vec{\beta}, \vec{\gamma})[\rho] = \mathbb{W}(\vec{\alpha}, \vec{\beta}, \vec{\gamma}) \rho \mathbb{W}^*(\vec{\alpha}, \vec{\beta}, \vec{\gamma}). \quad (56)$$

$\mathbb{T}^{(k)} \mathbb{U}_{SPT}^{(k)}(\vec{\alpha}, \vec{\beta}, \vec{\gamma})$ acts on the qumodes represented by wires indexed by L_k , and the total product \mathbb{W} acts on the qumodes represented by wires indexed by I .

Proof. The proof is left to appendix A.4 □

In other words, in the ideal limit, we implement the unitary

$$\begin{aligned} \mathbb{W}(\vec{\alpha}, \vec{\beta}, \vec{\gamma}) : \mathcal{H}^{\otimes |I|} &\longrightarrow \mathcal{H}^{\otimes |I|} \\ f &\longmapsto \prod_{k=1}^n \mathbb{T}^{(k)} \mathbb{U}_{SPT}^{(k)}(\vec{\alpha}, \vec{\beta}, \vec{\gamma}) f, \end{aligned} \quad (57)$$

where convergence of the approximation is once again in the strong sense.

An example of the complete circuit extraction procedure for an open graph based on a CV-flow and using the triangularised causal flow from example 4 is given in figure 5.

4 Flow for MBQC with qudit graph states

In this section, we give a brief overview of how our methods apply to the qudit case. We leave a more in-depth discussion for future work, as some results are missing when comparing with the qubit case [Bro+07]. Some of these questions are solved in our follow-up article [Boo+21].

4.1 Computational model

For qudit MBQC, the setup is very analogous to CV: letting d be an odd prime, the state space is also a space of square integrable functions $\mathcal{H} = L^2(\mathbb{Z}_d, \mathbb{C})$ with respect to a discrete measure, consisting of functions $\mathbb{Z}_d \rightarrow \mathbb{C}$ with norm

$$\text{for any } \psi \in \mathcal{H}, \quad \|\psi\| := \sum_{n=1}^d |\psi(n)|^2. \quad (58)$$

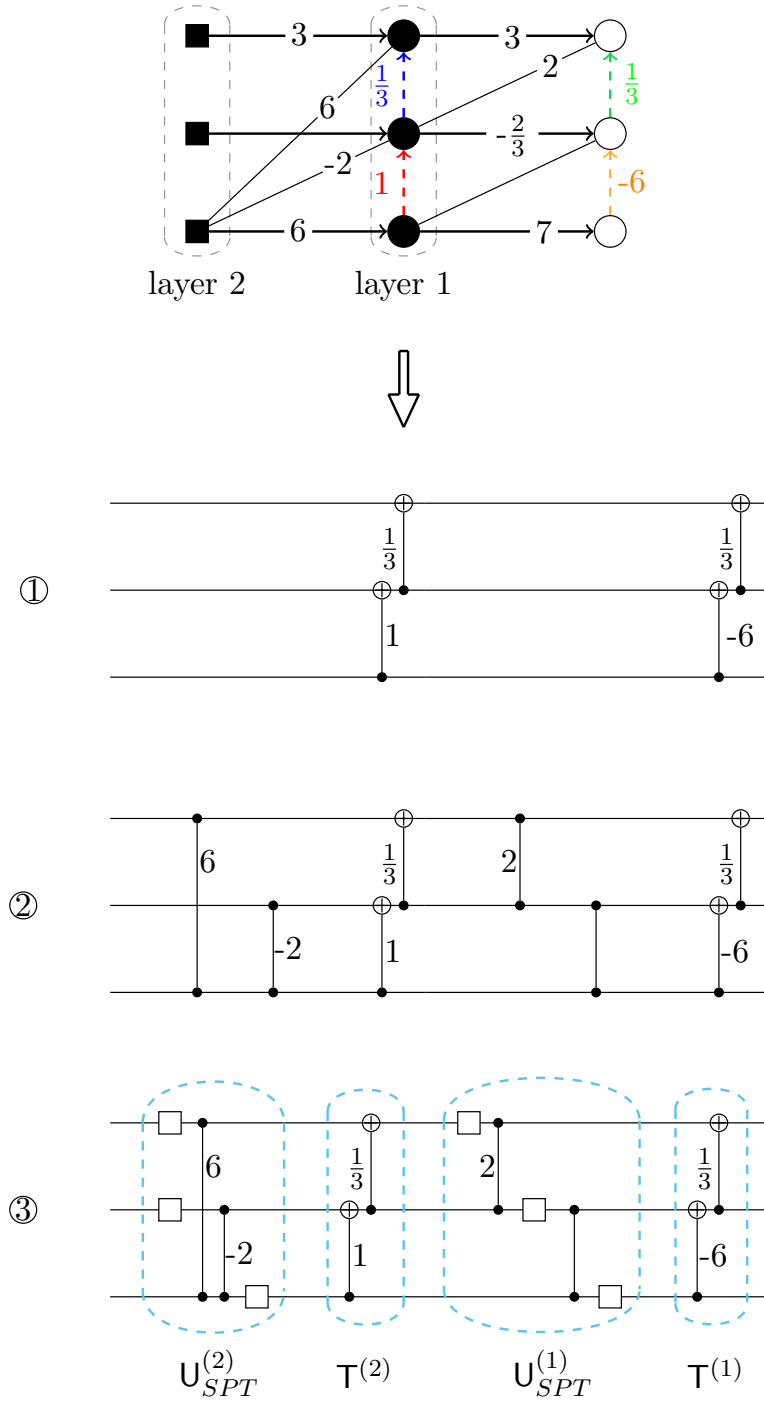

Figure 5: Example of the final circuit extraction procedure for an open graph with CV-flow. We use the open graph state resulting from the triangularisation (figure 4) of the graph state with CV-flow from figure 2. (1) The causal flow edges (bold directed edges) of the open graph are interpreted as edges in a circuit, and the CX gates (colored, dashed, directed edges) from the triangularisations of each layer are added. These are ordered by layer, and within a layer by (the inverse of) the order of column space operations in the triangularisation of the cut matrix for that layer. They separate the final circuit into individual sections, with each section corresponding to a single layer of the open graph. (2) The auxiliary (non-causal flow) edges for each section are added to the circuit as CZ gates. (3) Each of the causal flow edges corresponds to a J gate (equation (47)) in the final circuit. Adding these gates completes the SPT for each layer, and we identify the different sections corresponding to the decomposition of theorem II in the final circuit.

Vectors in \mathcal{H} can be represented with respect to an orthonormal basis $\{|n\rangle\}_{n=1}^d$, and we adopt the bra-ket notation which is better suited to this case than CV:

$$\text{for any } \psi \in \mathcal{H}, \quad |\psi\rangle := \sum_{n=1}^d \psi(n) |n\rangle. \quad (59)$$

This space also comes equipped with two operators X and Z . Writing $m+n$ and $m \cdot n$ the addition and multiplication in the finite field \mathbb{Z}_d (that is, the usual operations modulo d), we have

$$X |n\rangle := |n+1\rangle, \quad (60)$$

$$Z |n\rangle := e^{i\frac{2\pi n}{d}} |n\rangle, \quad (61)$$

$$X^d = I = Z^d, \quad (62)$$

$$ZX = e^{i\frac{2\pi}{d}} XZ. \quad (63)$$

They are also linked by the Hadamard or discrete Fourier transform H ,

$$H |n\rangle := \frac{1}{\sqrt{d}} \sum_{k=1}^d e^{i\frac{2\pi kn}{d}} |k\rangle, \quad (64)$$

so that

$$HZH^{-1} = X \quad \text{and} \quad HXH^{-1} = Z^{-1}. \quad (65)$$

Finally, we define the multiplication, controlled- Z and controlled- X gates:

$$M(w) |n\rangle := |w \cdot n\rangle, \quad (66)$$

$$CZ(w) |m\rangle \otimes |n\rangle := e^{i\frac{2\pi wmn}{d}} |m\rangle \otimes |n\rangle, \quad (67)$$

$$CX(w) |m\rangle \otimes |n\rangle := |m\rangle \otimes |n + w \cdot m\rangle. \quad (68)$$

For $M(w)$ to be unitary, it is necessary for w to be invertible. In fact, as we shall see in the following section, for the techniques we developed for MBQC in the CV case to apply, \mathbb{Z}_d must be a field and therefore d must be prime. It is also clear that, algebraically, these operations are analogous to those used for CV, with the multiplication operator taking the place of squeezing.

4.2 Measurement-based quantum computing

It is straightforward to see that the usual qubit gate teleportation generalises to

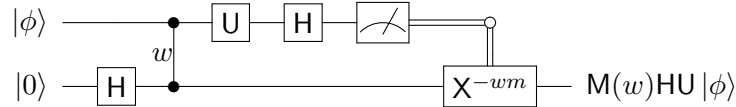

where once again U is any unitary that commutes with $CZ(w)$, and we perform a projective measurement whose elements are projections onto the basis $\{|n\rangle\}$. Therefore, as in the CV case, we can interpret the measurement (including the change-of-basis unitary U) as a measurement apparatus that depends on the choice of a unitary U , with the only condition being that U must commute with Z . It is clear that such a gate teleportation protocol permits one to implement a large enough range of unitaries to obtain MBQCs which are universal for qudit quantum computation [SK17].

Graph states

A **qudit open graph** is an undirected \mathbb{Z}_d -edge-weighted graph $G = (V, A)$,⁸ along with two subsets of vertices I and O , which correspond to the inputs and outputs of a computation [Zho+03]. To this abstract graph, we associate a physical resource state, the **graph state**, to be used in a computation: each vertex j of the graph corresponds to a single qudit and thus to a single pair $\{X_j, Z_j\}$.

For a given input state $|\psi\rangle$ on $|I|$ qudits, the graph state can be constructed as follows:

1. Initialise each non-input qudit, $j \in I^c$, in the auxiliary state $|\tilde{0}\rangle = \mathbf{H}|0\rangle$, resulting in a separable state of the form $|\tilde{0}\rangle^{\otimes |I^c|} \otimes |\psi\rangle$.
2. For each edge in the graph between vertices j and k with weight $A_{j,k} \in \mathbb{Z}_d$, apply the entangling operation $\mathbf{CZ}_{j,k}(A_{j,k})$ between the corresponding qudits.

4.3 Results

Now, all of the results proven for continuous variables function analogously in this setting. Since the all of the arguments in CV simply extend the convergence proof of single gate teleportation to the more general MBQC setting, and we have seen that that proof is replaced by equality in the finite-dimensional case, we can simply take all the results from previous sections, and drop the convergence statements for equality.

For the sake of clarity, we repeat some definitions from section 2:

Definition 20. Let (G, I, O) be a qudit open graph, $<$ a total order over the vertices V of G and $A^<$ be the adjacency matrix of G (which therefore has coefficients in \mathbb{Z}_d), such that its columns and rows are ordered by $<$. Further, define $P(j)$ (the “past” of vertex j) as the subset of V such that $k \in P(j)$ implies $k \leq j$. Then the **correction matrix** $A_j^<$ of a vertex $j \in V$ is the matrix $A_j^< := A[P(j), (P(j) \cup I)^c]$. \lrcorner

The correction matrix tells us how X and Z operations on unmeasured vertices are going to affect the previously measured vertices, thus it allows us to determine how to apply a correction on a specific vertex by controlling this back-action. The generalised flow condition is now given by:

Definition 21. A qudit open graph (G, I, O) has \mathbb{Z}_d -**flow** if there exists a partial order \prec on O^c such that for any total order $<$ that is a linear extension of \prec and every $j \in O^c$ there is a function $c_j : \mathbb{Z}_d \rightarrow \mathbb{Z}_d^{|G|-j}$ such that for all $m \in \mathbb{Z}_d$ the linear equation

$$A_j^< c_j(m) = \begin{pmatrix} 0 \\ \vdots \\ 0 \\ m \end{pmatrix} \text{ holds,} \quad (\star)$$

where $A_j^<$ is the correction matrix of vertex j . Letting $(c_j)_{j \in O^c}$ be a such set of functions, we call the pair $(\prec, (c_j))$ a \mathbb{Z}_d -flow for (G, I, O) . \lrcorner

Let (G, I, O) be an open \mathbb{Z}_d -graph with \mathbb{Z}_d -flow. Since the gate teleportation allows us to implement any unitary which commutes with Z (section 4.2), further assume a choice

⁸Once again, V is the set of vertices of G and A its $V \times V$ adjacency matrix with coefficients in \mathbb{Z}_d .

of unitary $U(k)$ is made for each $k \in O^c$ such that $[U(k), Z] = 0$. Then, by construction we know the following MBQC protocol is runnable:

1. measure the non-output vertices in the graph in any order which is a linear extension of \prec , in the basis corresponding to U ; and,
2. immediately after each measurement (say of vertex j), and before any other measurement is performed, correct for the measurement error m_j by applying

$$C_j^\prec(m_j) := \prod_{k \in V \setminus P(j) \cup I} \left(X_k^{-c_j(m_j)_k} \prod_{\ell \in N(k) \setminus P(j)} Z_\ell^{-A_{k,\ell} \cdot c_j(m_j)_k} \right), \quad (69)$$

where $c_j(m_j)_k$ is the k -th element of the vector $c_j(m_j) \in \mathbb{R}^{|V| - |P(j) \cup I|}$.

We write \mathcal{Z} the quantum channel corresponding to this protocol. Of course, the corrections C_j^\prec can be simplified and reduced, as was done in equation (39) for the CV case.

Quantum circuit extraction

Unlike for continuous-variables, for qudits we do not need to worry about convergence questions, since the gate teleportation protocol holds exactly. However, it is still of interest to obtain a reversible quantum circuit which implements the same quantum operations as a given MBQC. Under the assumption of \mathbb{Z}_d -flow, the methods of section 3 can easily be adapted to this case, only where each convergence statement is replaced by an equality.

The causal flow condition (definition 3) applies to the qudit case as well, with the same intuition as the qubit and CV cases. Denoting \mathcal{F} the corresponding quantum channel, we have

Proposition 22 (Causal flow circuit). *Suppose the qudit open graph (G, I, O) has a causal flow, then for any choice of measurement bases,*

$$\mathcal{F}(\vec{\alpha}, \vec{\beta}, \vec{\gamma}) = \mathcal{U}_{SPT}, \quad (70)$$

where \mathcal{U}_{SPT} is the unitary corresponding to the circuit obtained by star pattern transformation of (G, I, O) .

In the star pattern transformation, the gates are given by $J(i) = HU(i)$. As before, for a unitary U , $\mathcal{U}_U[\rho] = U\rho U^*$.

Sketch of proof. As was explained for continuous-variables, causal flow just identifies gate teleportation in the corresponding MBQC, which are interspersed with intermediate CZ gates. Star pattern transformation simply makes this intuition formal by providing a way to order the teleportations and intermediate CZs to obtain an equivalent circuit. In the CV case, this circuit is an approximation since we then need to consider convergence of the individual gate teleportations, but for qudits this is no longer necessary so we get a proper equality: the teleportation along the edge $i \rightarrow f(i)$ exactly implements a gate $J(i)$. \square

Proposition 23 (\mathbb{Z}_d -flow circuit). *If (G, I, O) is a qudit open graph with \mathbb{Z}_d -flow and $|I| = |O|$ then the \mathbb{Z}_d -flow correction protocol implements a unitary acting on the input*

state. If $\{V_k\}_{k=1}^n$ is a corresponding layer decomposition, for any choice of measurement bases,

$$\mathcal{L}(\vec{\alpha}, \vec{\beta}, \vec{\gamma}) = \mathcal{U}_{\prod_{k=1}^n \mathbb{T}^{(k)} \mathbb{U}_{SPT}^{(k)}}, \quad (71)$$

where $\mathbb{U}_{SPT}^{(k)}$ is the circuit extracted for the k -th layer using the causal flow from the equivalent to lemma 18, and $\mathbb{T}^{(k)}$ contains the CX gates obtained from the equivalent to the triangularisation of the \mathbb{Z}_d -flow (lemma 17). $\mathbb{T}^{(k)} \mathbb{U}_{SPT}^{(k)}$ acts on the qudits represented by wires indexed by V_k , and the total product acts on the qudits represented by wires indexed by I .

Sketch of proof. This proof follows almost entirely the same argument as presented in section 3.2, only where once again all of the limits can be taken to be proper equalities. This reduces the general case down to the case of causal flows, which can then be extracted using proposition 22. \square

To end this section, we make clear why we need to assume that the operations form a field and thus restrict to only prime dimensions. All single-qudit gate extractions occur via the gate teleportation protocol, and for this it suffices for the edge weight w to have a multiplicative inverse, i.e. it belongs to the group of units \mathbb{Z}_d^* . Then the edge weight is extracted as a unitary $M(w)$, as described in section 4.2. So far there is no issue if we allow any dimension but restrict to only open graphs with edge-weights in the group of units \mathbb{Z}_d^* .

The problem if we are not operating over a field arises during the extraction of a more general MBQC, in particular at the triangularisation step. At this point, we need to triangularise a submatrix of the adjacency matrix of the graph. Doing so using a standard technique, say Gaussian elimination, risks us ending up with edge weights that are no longer invertible. If such an edge belongs to the path cover used in the extraction, i.e. the edge is to be extracted as a gate teleportation, then the circuit extraction algorithm gets stuck.

Conclusion

We have defined a notion of flow for continuous variables and proved that it can be used to obtain a desired unitary, provided sufficient squeezing resources are available. We have also obtained a polynomial algorithm for finding CV-flow and a circuit extraction scheme, which might allow further comparison of depth and size complexities between circuit models and MBQC, as has already been obtained in the DV case, with a preliminary result in this direction showing depth separation in Appendix D. We have not considered the question of convergence rates in terms of the squeezing resources available nor the precision of measurements. These are highly dependant on the specific choice of measurements, auxiliary teleportation states, the topology of the graph, and, most problematically, on the input state itself.

There are further extensions possible to the flow framework. In particular, one might consider Hilbert spaces over more general locally compact rings or fields and these come equipped with a different unitary group of translations. It is unclear whether a good notion of flow is possible in these spaces in general, but examples include the cases considered in this article, which correspond to \mathbb{R} and \mathbb{Z}_d . This is also necessary to extend the theory to qudits of arbitrary (non-prime) local dimension. Then, one is interested in general in the case where the edges of the graph are weighted with elements of a ring R , and the correction equations are solved in the R -module R^n .

Finally, we only considered a single choice of measurement “plane”, where the original gflow condition accounted for several. It should be possible to extend our framework to account for more planes using symplectic relations between different measurement bases.

References

- [AU00] Peter M. Alberti and Armin Uhlmann. “On Bures Distance and $*$ -Algebraic Transition Probability between Inner Derived Positive Linear Forms over W^* -Algebras”. In: *Acta Applicandae Mathematica* 60.1 (Jan. 2000), pp. 1–37. DOI: [10.1023/A:1006317508252](https://doi.org/10.1023/A:1006317508252).
- [AM16] Rafael N. Alexander and Nicolas C. Menicucci. “Flexible Quantum Circuits Using Scalable Continuous-Variable Cluster States”. In: *Physical Review A* 93.6 (June 2016), p. 062326. DOI: [10.1103/PhysRevA.93.062326](https://doi.org/10.1103/PhysRevA.93.062326).
- [AMA14] B. Antonio, D. Markham, and J. Anders. “Adiabatic Graph-State Quantum Computation”. In: *New Journal of Physics* 16.11 (Nov. 2014), p. 113070. DOI: [10.1088/1367-2630/16/11/113070](https://doi.org/10.1088/1367-2630/16/11/113070).
- [Asa+19] Warit Asavanant et al. “Time-Domain Multiplexed 2-Dimensional Cluster State: Universal Quantum Computing Platform”. In: *Science* 366.6463 (Oct. 2019), pp. 373–376. DOI: [10.1126/science.aay2645](https://doi.org/10.1126/science.aay2645).
- [Bac+21] Miriam Backens, Hector Miller-Bakewell, Giovanni de Felice, Leo Lobski, and John van de Wetering. “There and Back Again: A Circuit Extraction Tale”. In: *Quantum* 5 (Mar. 2021), p. 421. DOI: [10.22331/q-2021-03-25-421](https://doi.org/10.22331/q-2021-03-25-421).
- [BG89] Arno Bohm and Manuel Gadella. *Dirac Kets, Gamow Vectors and Gel'fand Triplets*. Ed. by Arno Bohm and J. D. Dollard. Vol. 348. Lecture Notes in Physics. Springer Berlin, Heidelberg, 1989. DOI: <https://doi.org/10.1007/3-540-51916-5>.
- [Boo+21] Robert I. Booth, Aleks Kissinger, Damian Markham, Clément Meignant, and Simon Perdrix. “Outcome Determinism in Measurement-Based Quantum Computation with Qudits”. Sept. 28, 2021. DOI: [10.48550/arXiv.2109.13810](https://arxiv.org/abs/2109.13810).
- [Bv05] Samuel L. Braunstein and Peter van Loock. “Quantum Information with Continuous Variables”. In: *Reviews of Modern Physics* 77.2 (June 2005), pp. 513–577. DOI: [10.1103/RevModPhys.77.513](https://doi.org/10.1103/RevModPhys.77.513).
- [BK09] Anne Broadbent and Elham Kashefi. “Parallelizing Quantum Circuits”. In: *Theoretical Computer Science* 410.26 (June 2009), pp. 2489–2510. DOI: [10.1016/j.tcs.2008.12.046](https://doi.org/10.1016/j.tcs.2008.12.046).
- [Bro+07] D. E. Browne, E. Kashefi, M. Mhalla, and S. Perdrix. “Generalized Flow and Determinism in Measurement-based Quantum Computation”. In: *New Journal of Physics* 9.8 (Aug. 2007), pp. 250–250. DOI: [10.1088/1367-2630/9/8/250](https://doi.org/10.1088/1367-2630/9/8/250).
- [CGd19] E. Celeghini, M. Gadella, and M. A. del Olmo. “Groups, Special Functions and Rigged Hilbert Spaces”. In: *Axioms* 8.3 (July 2019). DOI: [10.3390/axioms8030089](https://doi.org/10.3390/axioms8030089).
- [DK06] Vincent Danos and Elham Kashefi. “Determinism in the One-Way Model”. In: *Physical Review A* 74.5 (Nov. 2006), p. 052310. DOI: [10.1103/PhysRevA.74.052310](https://doi.org/10.1103/PhysRevA.74.052310).

- [DKP07] Vincent Danos, Elham Kashefi, and Prakash Panangaden. “The Measurement Calculus”. In: *Journal of the ACM* 54.2 (Apr. 2007), 8–es. DOI: [10.1145/1219092.1219096](https://doi.org/10.1145/1219092.1219096).
- [de 08] Niel de Beaudrap. “Finding Flows in the One-Way Measurement Model”. In: *Physical Review A* 77.2 (Feb. 2008), p. 022328. DOI: [10.1103/PhysRevA.77.022328](https://doi.org/10.1103/PhysRevA.77.022328).
- [de +20] Niel de Beaudrap, Ross Duncan, Dominic Horsman, and Simon Perdrix. “Pauli Fusion: A Computational Model to Realise Quantum Transformations from ZX Terms”. In: *Electronic Proceedings in Theoretical Computer Science* 318.Proceedings QPL 2019 (Apr. 2020), pp. 85–105. DOI: [10.4204/EPTCS.318](https://doi.org/10.4204/EPTCS.318).
- [de 06] Maurice A. de Gosson. *Symplectic Geometry and Quantum Mechanics*. Advances in Partial Differential Equations. Birkhäuser Basel, 2006. DOI: [10.1007/3-7643-7575-2](https://doi.org/10.1007/3-7643-7575-2).
- [Dun+20] Ross Duncan, Aleks Kissinger, Simon Perdrix, and John van de Wetering. “Graph-Theoretic Simplification of Quantum Circuits with the ZX-calculus”. In: *Quantum* 4 (June 2020), p. 279. DOI: [10.22331/q-2020-06-04-279](https://doi.org/10.22331/q-2020-06-04-279).
- [DP10] Ross Duncan and Simon Perdrix. “Rewriting Measurement-Based Quantum Computations with Generalised Flow”. In: *Automata, Languages and Programming*. Ed. by David Hutchison et al. Vol. 6199. Berlin, Heidelberg: Springer Berlin Heidelberg, 2010, pp. 285–296. DOI: [10.1007/978-3-642-14162-1_24](https://doi.org/10.1007/978-3-642-14162-1_24).
- [ESP02] J. Eisert, S. Scheel, and M. B. Plenio. “Distilling Gaussian States with Gaussian Operations Is Impossible”. In: *Physical Review Letters* 89.13 (Sept. 2002), p. 137903. DOI: [10.1103/PhysRevLett.89.137903](https://doi.org/10.1103/PhysRevLett.89.137903).
- [FT20] Claude Fabre and Nicolas Treps. “Modes and States in Quantum Optics”. In: *Reviews of Modern Physics* 92.3 (Sept. 2020), p. 035005. DOI: [10.1103/RevModPhys.92.035005](https://doi.org/10.1103/RevModPhys.92.035005).
- [FK17] Joseph F. Fitzsimons and Elham Kashefi. “Unconditionally Verifiable Blind Quantum Computation”. In: *Physical Review A* 96.1 (July 2017). DOI: [10.1103/PhysRevA.96.012303](https://doi.org/10.1103/PhysRevA.96.012303).
- [GG02] M. Gadella and F. Gómez. “A Unified Mathematical Formalism for the Dirac Formulation of Quantum Mechanics”. In: *Foundations of Physics* 32.6 (June 2002), pp. 815–869. DOI: [10.1023/A:1016069311589](https://doi.org/10.1023/A:1016069311589).
- [GS16a] I. Gel’fand and G. Shilov. *Generalized Functions, Volume 1: Properties and Operations*. Vol. 377. AMS Chelsea Publishing. American Mathematical Society, Apr. 19, 2016. DOI: [10.1090/chel/377](https://doi.org/10.1090/chel/377).
- [GS16b] I. Gel’fand and G. Shilov. *Generalized Functions, Volume 2: Spaces of Fundamental and Generalized Functions*. Vol. 378. AMS Chelsea Publishing. American Mathematical Society, Mar. 30, 2016. DOI: [10.1090/chel/378](https://doi.org/10.1090/chel/378).
- [GS16c] I. Gel’fand and G. Shilov. *Generalized Functions, Volume 3: Theory of Differential Equations*. Vol. 379. AMS Chelsea Publishing. American Mathematical Society, Mar. 30, 2016. DOI: [10.1090/chel/379](https://doi.org/10.1090/chel/379).

- [GV16] I. Gel'fand and N. Ya Vilenkin. *Generalized Functions, Volume 4: Applications of Harmonic Analysis*. Vol. 380. AMS Chelsea Publishing. American Mathematical Society, Apr. 18, 2016. DOI: [10.1090/chel/380](https://doi.org/10.1090/chel/380).
- [GKP01] Daniel Gottesman, Alexei Kitaev, and John Preskill. “Encoding a Qubit in an Oscillator”. In: *Physical Review A* 64.1 (June 2001). DOI: [10.1103/PhysRevA.64.012310](https://doi.org/10.1103/PhysRevA.64.012310).
- [Gu+09] Mile Gu, Christian Weedbrook, Nicolas C. Menicucci, Timothy C. Ralph, and Peter van Loock. “Quantum Computing with Continuous-Variable Clusters”. In: *Physical Review A* 79.6 (June 2009). DOI: [10.1103/PhysRevA.79.062318](https://doi.org/10.1103/PhysRevA.79.062318).
- [Hal13] Brian C. Hall. *Quantum Theory for Mathematicians*. Graduate Texts in Mathematics. New York: Springer-Verlag, 2013. DOI: <https://doi.org/10.1007/978-1-4614-7116-5>.
- [Hao+21] Shuhong Hao, Meihong Wang, Dong Wang, and Xiaolong Su. “Topological Error Correction with a Gaussian Cluster State”. In: *Physical Review A* 103.5 (May 2021), p. 052407. DOI: [10.1103/PhysRevA.103.052407](https://doi.org/10.1103/PhysRevA.103.052407).
- [HQ12] JinChuan Hou and XiaoFei Qi. “Fidelity of States in Infinite-Dimensional Quantum Systems”. In: *Science China Physics, Mechanics and Astronomy* 55.10 (Oct. 2012), pp. 1820–1827. DOI: [10.1007/s11433-012-4840-4](https://doi.org/10.1007/s11433-012-4840-4).
- [KQ21] Timjan Kalajdzievski and Nicolás Quesada. “Exact and Approximate Continuous-Variable Gate Decompositions”. In: *Quantum* 5 (Feb. 2021), p. 394. DOI: [10.22331/q-2021-02-08-394](https://doi.org/10.22331/q-2021-02-08-394).
- [KKW16] Michael Keyl, Jukka Kiukas, and Reinhard F. Werner. “Schwartz Operators”. In: *Reviews in Mathematical Physics* 28.03 (Apr. 2016), p. 1630001. DOI: [10.1142/S0129055X16300016](https://doi.org/10.1142/S0129055X16300016).
- [Kon+21a] Shunya Konno et al. “Non-Clifford Gate on Optical Qubits by Nonlinear Feedforward”. In: *Physical Review Research* 3.4 (Oct. 11, 2021), p. 043026. DOI: [10.1103/PhysRevResearch.3.043026](https://doi.org/10.1103/PhysRevResearch.3.043026).
- [Kon+21b] Shunya Konno et al. “Nonlinear Squeezing for Measurement-Based Non-Gaussian Operations in Time Domain”. In: *Physical Review Applied* 15.2 (Feb. 2021), p. 024024. DOI: [10.1103/PhysRevApplied.15.024024](https://doi.org/10.1103/PhysRevApplied.15.024024).
- [LB99] Seth Lloyd and Samuel L. Braunstein. “Quantum Computation over Continuous Variables”. In: *Physical Review Letters* 82.8 (Feb. 1999), pp. 1784–1787. DOI: [10.1103/PhysRevLett.82.1784](https://doi.org/10.1103/PhysRevLett.82.1784).
- [Lvo15] A. I. Lvovsky. “Squeezed Light”. In: *Photonics*. John Wiley & Sons, Ltd, 2015. Chap. 5, pp. 121–163. DOI: [10.1002/9781119009719.ch5](https://doi.org/10.1002/9781119009719.ch5).
- [Man+17] Atul Mantri, Tommaso F. Demarie, Nicolas C. Menicucci, and Joseph F. Fitzsimons. “Flow Ambiguity: A Path Towards Classically Driven Blind Quantum Computation”. In: *Physical Review X* 7.3 (July 2017). DOI: [10.1103/PhysRevX.7.031004](https://doi.org/10.1103/PhysRevX.7.031004).

- [MK14] Damian Markham and Elham Kashefi. “Entanglement, Flow and Classical Simulatability in Measurement Based Quantum Computation”. In: *Horizons of the Mind. A Tribute to Prakash Panangaden: Essays Dedicated to Prakash Panangaden on the Occasion of His 60th Birthday*. Ed. by Franck van Breugel, Elham Kashefi, Catuscia Palamidessi, and Jan Rutten. Lecture Notes in Computer Science. Cham: Springer International Publishing, 2014, pp. 427–453. DOI: [10.1007/978-3-319-06880-0_22](https://doi.org/10.1007/978-3-319-06880-0_22).
- [MFv11] Nicolas C. Menicucci, Steven T. Flammia, and Peter van Loock. “Graphical Calculus for Gaussian Pure States”. In: *Physical Review A* 83.4 (Apr. 2011). DOI: [10.1103/PhysRevA.83.042335](https://doi.org/10.1103/PhysRevA.83.042335).
- [Men+06] Nicolas C. Menicucci, Peter van Loock, Mile Gu, Christian Weedbrook, Timothy C. Ralph, and Michael A. Nielsen. “Universal Quantum Computation with Continuous-Variable Cluster States”. In: *Physical Review Letters* 97.11 (Sept. 2006). DOI: [10.1103/PhysRevLett.97.110501](https://doi.org/10.1103/PhysRevLett.97.110501).
- [Mha+14] Mehdi Mhalla, Mio Murao, Simon Perdrix, Masato Someya, and Peter S. Turner. “Which Graph States Are Useful for Quantum Information Processing?” In: *Theory of Quantum Computation, Communication, and Cryptography*. Ed. by Dave Bacon, Miguel Martin-Delgado, and Martin Roetteler. Lecture Notes in Computer Science. Berlin, Heidelberg: Springer, 2014, pp. 174–187. DOI: [10.1007/978-3-642-54429-3_12](https://doi.org/10.1007/978-3-642-54429-3_12).
- [MP08] Mehdi Mhalla and Simon Perdrix. “Finding Optimal Flows Efficiently”. In: *Automata, Languages and Programming*. Ed. by Luca Aceto, Ivan Damgård, Leslie Ann Goldberg, Magnús M. Halldórsson, Anna Ingólfssdóttir, and Igor Walukiewicz. Lecture Notes in Computer Science. Berlin, Heidelberg: Springer, 2008, pp. 857–868. DOI: [10.1007/978-3-540-70575-8_70](https://doi.org/10.1007/978-3-540-70575-8_70).
- [Miy+16] Kazunori Miyata et al. “Implementation of a Quantum Cubic Gate by Adaptive Non-Gaussian Measurement”. In: *Physical Review A* 93.2 (Feb. 2016), p. 022301. DOI: [10.1103/PhysRevA.93.022301](https://doi.org/10.1103/PhysRevA.93.022301).
- [MHM15] Jisho Miyazaki, Michal Hajdušek, and Mio Murao. “An Analysis of the Trade-off between Spatial and Temporal Resources for Measurement-Based Quantum Computation”. In: *Physical Review A* 91.5 (May 2015), p. 052302. DOI: [10.1103/PhysRevA.91.052302](https://doi.org/10.1103/PhysRevA.91.052302).
- [NFC09] Julien Niset, Jaromír Fiurášek, and Nicolas J. Cerf. “No-Go Theorem for Gaussian Quantum Error Correction”. In: *Physical Review Letters* 102.12 (Mar. 2009), p. 120501. DOI: [10.1103/PhysRevLett.102.120501](https://doi.org/10.1103/PhysRevLett.102.120501).
- [NGJ20] Kyungjoo Noh, S. M. Girvin, and Liang Jiang. “Encoding an Oscillator into Many Oscillators”. In: *Physical Review Letters* 125.8 (Aug. 2020), p. 080503. DOI: [10.1103/PhysRevLett.125.080503](https://doi.org/10.1103/PhysRevLett.125.080503).
- [PLB18] Stefano Pirandola, Riccardo Laurenza, and Samuel L. Braunstein. “Teleportation Simulation of Bosonic Gaussian Channels: Strong and Uniform Convergence”. In: *The European Physical Journal D* 72.9 (Sept. 2018), p. 162. DOI: [10.1140/epjd/e2018-90253-1](https://doi.org/10.1140/epjd/e2018-90253-1).
- [RB01] Robert Raussendorf and Hans J. Briegel. “A One-Way Quantum Computer”. In: *Physical Review Letters* 86.22 (May 2001), pp. 5188–5191. DOI: [10.1103/PhysRevLett.86.5188](https://doi.org/10.1103/PhysRevLett.86.5188).

- [RB02] Robert Raussendorf and Hans J. Briegel. “Computational Model Underlying the One-Way Quantum Computer”. In: *Quantum Info. Comput.* 2.6 (Oct. 2002), pp. 443–486. DOI: [10.5555/2011492.2011495](https://doi.org/10.5555/2011492.2011495).
- [SK17] Adam Sawicki and Katarzyna Karnas. “Universality of Single Qudit Gates”. In: *Annales Henri Poincaré* 18.11 (Nov. 2017), pp. 3515–3552. DOI: [10.1007/s00023-017-0604-z](https://doi.org/10.1007/s00023-017-0604-z).
- [SW20] Kunal Sharma and Mark M. Wilde. “Characterizing the Performance of Continuous-Variable Gaussian Quantum Gates”. In: *Physical Review Research* 2.1 (Feb. 2020), p. 013126. DOI: [10.1103/PhysRevResearch.2.013126](https://doi.org/10.1103/PhysRevResearch.2.013126).
- [SH08] M. E. Shirokov and A. S. Holevo. “On Approximation of Infinite-Dimensional Quantum Channels”. In: *Problems of Information Transmission* 44.2 (June 2008), pp. 73–90. DOI: [10.1134/S0032946008020014](https://doi.org/10.1134/S0032946008020014).
- [Uhl76] Armin Uhlmann. “The “Transition Probability” in the State Space of a $*$ -Algebra”. In: *Reports on Mathematical Physics* 9.2 (Apr. 1976), pp. 273–279. DOI: [10.1016/0034-4877\(76\)90060-4](https://doi.org/10.1016/0034-4877(76)90060-4).
- [Vui+19] Christophe Vuillot, Hamed Asasi, Yang Wang, Leonid P. Pryadko, and Barbara M. Terhal. “Quantum Error Correction with the Toric-GKP Code”. In: *Physical Review A* 99.3 (Mar. 2019), p. 032344. DOI: [10.1103/PhysRevA.99.032344](https://doi.org/10.1103/PhysRevA.99.032344).
- [WZ15] Richard L. Wheeden and Antoni Zygmund. *Measure and Integral : An Introduction to Real Analysis, Second Edition*. Chapman and Hall/CRC, Apr. 24, 2015. DOI: [10.1201/b18361](https://doi.org/10.1201/b18361).
- [Wil18] Mark M. Wilde. “Strong and Uniform Convergence in the Teleportation Simulation of Bosonic Gaussian Channels”. In: *Physical Review A* 97.6 (June 2018), p. 062305. DOI: [10.1103/PhysRevA.97.062305](https://doi.org/10.1103/PhysRevA.97.062305).
- [Yok+13] Shota Yokoyama et al. “Ultra-Large-Scale Continuous-Variable Cluster States Multiplexed in the Time Domain”. In: *Nature Photonics* 7.12 (Dec. 2013), pp. 982–986. DOI: [10.1038/nphoton.2013.287](https://doi.org/10.1038/nphoton.2013.287).
- [Yos+16] Jun-ichi Yoshikawa et al. “Generation of One-Million-Mode Continuous-Variable Cluster State by Unlimited Time-Domain Multiplexing”. In: *APL Photonics* 1.6 (Sept. 2016), p. 060801. DOI: [10.1063/1.4962732](https://doi.org/10.1063/1.4962732).
- [Zha08] Jing Zhang. “Graphical Description of Local Gaussian Operations for Continuous-Variable Weighted Graph States”. In: *Physical Review A* 78.5 (Nov. 2008), p. 052307. DOI: [10.1103/PhysRevA.78.052307](https://doi.org/10.1103/PhysRevA.78.052307).
- [Zha10] Jing Zhang. “Graphical Rule of Transforming Continuous-Variable Graph States by Local Homodyne Detection”. In: *Physical Review A* 82.3 (Sept. 2010), p. 034303. DOI: [10.1103/PhysRevA.82.034303](https://doi.org/10.1103/PhysRevA.82.034303).
- [ZB06] Jing Zhang and Samuel L. Braunstein. “Continuous-Variable Gaussian Analog of Cluster States”. In: *Physical Review A* 73.3 (Mar. 2006). DOI: [10.1103/PhysRevA.73.032318](https://doi.org/10.1103/PhysRevA.73.032318).
- [Zho+03] D. L. Zhou, B. Zeng, Z. Xu, and C. P. Sun. “Quantum Computation Based on D-Level Cluster States”. In: *Physical Review A* 68.6 (Dec. 2003), p. 062303. DOI: [10.1103/PhysRevA.68.062303](https://doi.org/10.1103/PhysRevA.68.062303).

A Convergence proofs

We use several different, equivalent formulations of quantum theory for the different proofs of convergence:

- the proof of gate teleportation, proposition 1 is done via the Wigner-Weyl-Moyal phase space formulation of quantum theory, which is a standard tool in continuous variables quantum computing;
- the proof that graph states admit approximate controlled stabilisers, lemma 16 is done in the Hilbert space formulation, since this is a statement about pure states;
- the proofs of convergences of the flow MBQC procedures in the density operator formulation, since these two proofs follow from the other two convergence results and a continuity argument for quantum channels on $\mathfrak{T}(\mathcal{H})$.

The Wigner function

We briefly review the Wigner formulation. In fact, we do not need the full phase space picture: it is sufficient for our purposes to understand how to represent states and measurements on those states.

In the phase space formalism, to each density operator $\rho \in D(\mathcal{H})$ such that $\rho = \sum_j c_j \rho_{\psi_j}$, we associate a *real-valued* square-integrable function in a Hilbert space $L^2(\mathbb{R} \times \mathbb{R}, \mathbb{R})$, called the Wigner function:

$$W_\rho(q, p) := \frac{1}{\pi} \sum_j c_j \int_{\mathbb{R}} \psi_j^*(q + y) \psi_j(q - y) e^{2ipy} dy. \quad (72)$$

and it is clear that this association is \mathbb{R} -linear, $W_{\rho + \lambda\sigma} = W_\rho + \lambda W_\sigma$. The norm is given by

$$\|W\| := \sqrt{\int_{\mathbb{R}} \int_{\mathbb{R}} W(x, y)^2 dx dy}, \quad (73)$$

which agrees with the Hilbert-Schmidt norm, $\|W_\rho\|^2 = \text{tr}(\rho^2)$.

A.1 Proof of Proposition 1

We are interested in proving convergence of the quantum map implemented by:

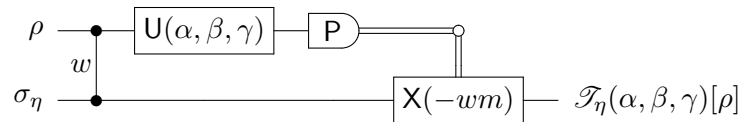

Proposition 1 (Teleportation convergence). *For any $\alpha, \beta, \gamma, w \in \mathbb{R}$ and any $\rho \in D(\mathcal{H})$,*

$$\lim_{\eta \rightarrow \infty} \mathcal{T}_\eta(\alpha, \beta, \gamma, w)[\rho] = \mathcal{U}_{S(w)} \text{FU}(\alpha, \beta, \gamma)[\rho], \quad (27)$$

where \mathcal{U}_U is the quantum channel corresponding to conjugation by the unitary U .

Proof. We first note that we can ignore the parameter w for the $\text{CZ}(w)$ gate: we know that

$$\text{CZ}(w) = \exp(iw\mathbf{Q}_1\mathbf{Q}_2) = \exp(i\mathbf{Q}_1w\mathbf{Q}_2) = \exp(i\mathbf{Q}_1\mathbf{S}_2(w)^*\mathbf{Q}_2\mathbf{S}_2(w)) \quad (74)$$

$$= \mathbf{S}_2(w)^*\exp(i\mathbf{Q}_1\mathbf{Q}_2)\mathbf{S}_2(w) = \mathbf{S}_2(w)^*\text{CZ}(1)\mathbf{S}_2(w) = \mathbf{S}_2(-w)\text{CZ}\mathbf{S}_2(w). \quad (75)$$

Thus, the teleportation circuit is equivalent to

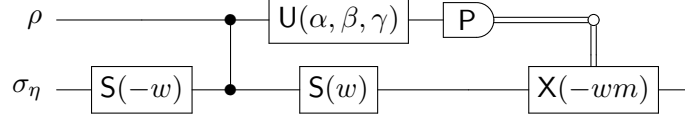

and, commuting the correction with the squeezing operator, to

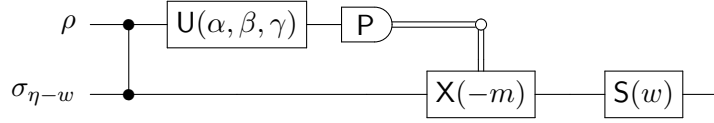

The additional squeezing w in the auxiliary state will be absorbed into the limit, and the final $\mathbf{S}(w)$ gate can be added at the end since it comes after the teleportation (it is unitary thus continuous and preserves limits). Since the “change of basis” unitary $\mathbf{U}(\alpha, \beta, \gamma)$ commutes with the CZ gate, it can be absorbed into the input state which is arbitrary by hypothesis. We have therefore reduced the problem to proving convergence of the simpler circuit:

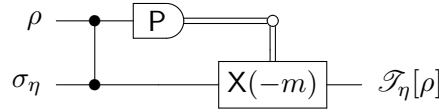

for an arbitrary input $\rho \in D(\mathcal{H})$. From [Gu+09] we know that the output of this circuit is

$$W_{\mathcal{T}_\eta[\rho]}(q, p) = \int_{\mathbb{R}} G_\eta(q-x)W_\rho(x, p) dx = W_{\mathbf{F}\rho\mathbf{F}^*} *_1 g_{\frac{1}{\eta}}(q, p), \quad (76)$$

where $*_1$ indicates convolution with respect to the first variable. We need to bound the trace distance $\|\mathcal{T}_\eta[\rho] - \mathbf{F}\rho\mathbf{F}^*\|$. By [AU00; HQ12] we know that for any $\rho, \sigma \in D(\mathcal{H})$,

$$\|\rho - \sigma\| \leq \sqrt{1 - \mathbf{F}(\rho, \sigma)}, \quad (77)$$

where \mathbf{F} is the Uhlmann fidelity [Uhl76] which can be calculated for pure states as

$$\mathbf{F}(\rho, \sigma) = \frac{1}{\pi} \int_{\mathbb{R}} \int_{\mathbb{R}} W_\rho(q, p)W_\sigma(q, p) dq dp. \quad (78)$$

Assume ρ is a pure state, and furthermore that it is the density operator of $\psi \in L^1(\mathbb{R}) \cap L^2(\mathbb{R})$, i.e. the projector P_ψ onto the one-dimensional subspace generated by ψ . Then we have

$$1 - \mathbf{F}(\mathcal{T}_\eta[\rho], \mathbf{F}\rho\mathbf{F}^*) = 1 - \frac{1}{\pi} \int_{\mathbb{R}} \int_{\mathbb{R}} W_{\mathcal{T}_\eta[\rho]}(q, p)W_\rho(p, -q) dq dp \quad (79)$$

$$= \frac{1}{\pi} \int_{\mathbb{R}} \int_{\mathbb{R}} (W_\rho(p, -q)^2 - W_{\mathcal{T}_\eta[\rho]}(q, p)W_\rho(p, -q)) dq dp \quad (80)$$

$$= \frac{1}{\pi} \int_{\mathbb{R}} \int_{\mathbb{R}} W_\rho(p, -q) (W_\rho(p, -q) - W_{\mathcal{T}_\eta[\rho]}(q, p)) dq dp. \quad (81)$$

since

$$\int_{\mathbb{R}} \int_{\mathbb{R}} W_{\rho}(p, -q)^2 dq dp = \text{tr}\left((F\rho F^*)^2\right) = \text{tr}\left(\rho^2\right) = 1. \quad (82)$$

ψ being L^1 implies that its Wigner transform W_{ρ} is also L^1 ([de 06], proposition 6.43), so

$$1 - F(\mathcal{T}_{\eta}[\rho], F\rho F^*) = |1 - F(\mathcal{T}_{\eta}[\rho], F\rho F^*)| \quad (83)$$

$$= \left| \frac{1}{\pi} \int_{\mathbb{R}} \int_{\mathbb{R}} W_{\rho}(p, -q) \left(W_{\rho}(p, -q) - W_{\mathcal{T}_{\eta}[\rho]}(q, p) \right) dq dp \right| \quad (84)$$

$$\leq \frac{1}{\pi} \int_{\mathbb{R}} \int_{\mathbb{R}} \left| W_{\rho}(p, -q) \left(W_{\rho}(p, -q) - W_{\mathcal{T}_{\eta}[\rho]}(q, p) \right) \right| dq dp \quad (85)$$

$$= \frac{1}{\pi} \int_{\mathbb{R}} \int_{\mathbb{R}} |W_{\rho}(p, -q)| \cdot \left| W_{\rho}(p, -q) - W_{\mathcal{T}_{\eta}[\rho]}(q, p) \right| dq dp \quad (86)$$

$$\leq \frac{1}{\pi^2} \int_{\mathbb{R}} \int_{\mathbb{R}} \left| W_{\rho}(p, -q) - W_{\mathcal{T}_{\eta}[\rho]}(q, p) \right| dq dp \quad (87)$$

$$= \frac{1}{\pi^2} \int_{q \in \mathbb{R}} \int_{p \in \mathbb{R}} \left| W_{\rho}(p, -q) - W_{\rho} *_{1} g_{\frac{1}{\eta}}(p, -q) \right| dq dp, \quad (88)$$

where we have used the inequality $|W_{\rho}(p, -q)| \leq \frac{1}{\pi}$ for pure states ([de 06], section 6.4.3) to go from equation (86) to (87). As a result,

$$\|\mathcal{T}_{\eta}[\rho] - F\rho F^*\| \leq \frac{1}{\pi} \left\| W_{F\rho F^*} - W_{F\rho F^*} *_{1} g_{\frac{1}{\eta}} \right\|_{L^1}. \quad (89)$$

By definition, $G_{\eta}(x) = \eta^{-1}G_1(\eta^{-1}x)$ and $\int_{\mathbb{R}} G_{\eta} = 1$, so that by [WZ15], theorem 9.6, the net $(G_{\eta})_{\eta \in \mathbb{R}_+^*}$ forms an approximation to identity. As a result,

$$\left\| W_{F\rho F^*} - W_{F\rho F^*} *_{1} g_{\frac{1}{\eta}} \right\|_{L^1} \rightarrow 0 \quad \text{as } \eta \rightarrow +\infty, \quad (90)$$

and it follows that

$$\lim_{\eta \rightarrow \infty} \mathcal{T}_{\eta}[\rho] = F\rho F^*, \quad (91)$$

for any such ρ . Since the trace-class norm agrees with the Hilbert space norm for pure states, and $L^1(\mathbb{R}) \cap L^2(\mathbb{R})$ is dense in $L^2(\mathbb{R})$, equation (91) holds by continuity of \mathcal{T}_{η} for any pure $\rho \in D(\mathcal{H})$. Finally, since the set of finite convex sums of pure $\rho \in D(\mathcal{H})$ is dense in $D(\mathcal{H})$ (which is Banach) the result can be extended to mixed states.

Reintroducing the edge-weight and measurement angles, we have

$$\lim_{\eta \rightarrow \infty} \mathcal{T}_{\eta}(\alpha, \beta, \gamma, w)[\rho] = S(w)FU(\alpha, \beta, \gamma)\rho U^*(\alpha, \beta, \gamma)F^*S^*(w), \quad (92)$$

as desired. \square

A.2 Proof of Proposition 13

Proposition 13 (Causal flow circuit). *Suppose the open graph (G, I, O) has a causal flow and $|I| = |O|$. Then for any $\vec{\alpha}, \vec{\beta}, \vec{\gamma} \in \mathbb{R}^{|O|}$ and any $\rho \in D(\mathcal{H}^{\otimes |I|})$,*

$$\lim_{\eta \rightarrow \infty} \mathcal{F}_{\eta}(\vec{\alpha}, \vec{\beta}, \vec{\gamma})[\rho] = U_{SPT}(\vec{\alpha}, \vec{\beta}, \vec{\gamma})\rho U_{SPT}^*(\vec{\alpha}, \vec{\beta}, \vec{\gamma}), \quad (48)$$

where U_{SPT} is the unitary corresponding to the circuit obtained by star pattern transformation of (G, I, O) . Furthermore, the condition $|I| = |O|$ is necessary.

Proof. As explained in section 3.1, we can decompose \mathcal{F}_η as a set of parallel paths with mediating edges. Each of these parallel paths corresponds to a sequence of single gate teleportations. All we need to worry about is ordering the mediating edges such that they appear before any teleportation of a node they are connected to. This is possible since such an ordering exists if and only if there is a causal flow [MHM15]. Then, by proposition 1 each teleportation converges, and since each gate teleportation channel is continuous it preserves limits. \square

A.3 Proof of Lemma 16

Lemma 16 (Approximate controlled stabilizers). *Let (G, I, O) be an open graph, $j \in G$ and $k \in I^c$. Then, for any physical input state $\rho \in D(\mathcal{H}^{\otimes |I|})$ and $s \in \mathbb{R}$,*

$$\lim_{\eta \rightarrow \infty} \left\| \mathcal{U}_{\text{CX}_{j,k}(s)} \text{CZ}_{j,N(k)}(s) \circ \mathcal{G}_\eta[\rho] - \mathcal{G}_\eta[\rho] \right\| = 0. \quad (50)$$

Proof. Let $\phi \in \mathcal{H}$ be normalised and Schwartz, pick $s \in \mathbb{R}$, and consider

$$\text{CX}_{1,2}(s)[\phi \otimes g_\eta](x, y) = \exp(is\mathbf{Q}_1\mathbf{P}_1)[\phi \otimes g_\eta](x, y) = \phi(y)g_\eta(y + sx). \quad (93)$$

Now, since ϕ is square-integrable of norm 1, for any $\varepsilon > 0$ there is some bounded measurable subset $E \subseteq \mathbb{R}$ such that

$$\int_{x \in E^c} |\phi(x)|^2 < \varepsilon, \quad (94)$$

and

$$\|\text{CX}_{1,2}(s)\phi \otimes g_\eta - \phi \otimes g_\eta\|^2 = \frac{1}{\sqrt{\pi\eta^2}} \int_{\mathbb{R}} \int_{\mathbb{R}} \left| \phi(x) e^{-\frac{(y+sx)^2}{2\eta^2}} - \phi(x) e^{-\frac{y^2}{2\eta^2}} \right|^2 dx dy \quad (95)$$

$$\leq \frac{1}{\sqrt{\pi\eta^2}} \int_{\mathbb{R}} \int_{\mathbb{R}} |\phi(x)|^2 \left| e^{-\frac{(y+sx)^2}{2\eta^2}} - e^{-\frac{y^2}{2\eta^2}} \right|^2 dx dy \quad (96)$$

$$\leq \frac{1}{\sqrt{\pi\eta^2}} \int_E \int_{\mathbb{R}} |\phi(x)|^2 \left| e^{-\frac{(y+sx)^2}{2\eta^2}} - e^{-\frac{y^2}{2\eta^2}} \right|^2 dy dx \quad (97)$$

$$+ \frac{1}{\sqrt{\pi\eta^2}} \int_{E^c} \int_{\mathbb{R}} |\phi(x)|^2 \left| e^{-\frac{(y+sx)^2}{2\eta^2}} - e^{-\frac{y^2}{2\eta^2}} \right|^2 dy dx \quad (98)$$

$$\leq \frac{1}{\sqrt{\pi\eta^2}} \int_{x \in E} |\phi(x)|^2 \int_{\mathbb{R}} \left| e^{-\frac{(y+sx)^2}{2\eta^2}} - e^{-\frac{y^2}{2\eta^2}} \right|^2 dy dx + 2 \int_{E^c} |\phi(x)|^2 dx. \quad (99)$$

Furthermore, using for any $x, y \in \mathbb{R}$,

$$\left| e^{-\frac{(y+sx)^2}{2\eta^2}} - e^{-\frac{y^2}{2\eta^2}} \right| \leq |sx| \cdot \max_{t \in \mathbb{R}} \frac{d}{dt} \left(e^{-\frac{t^2}{2\eta^2}} \right) \leq \frac{A}{\eta} |sx| \quad (100)$$

where $A = \max_{t \in \mathbb{R}} \frac{d}{dt} \left(e^{-\frac{t^2}{2}} \right)$. Then,

$$\|\text{CX}_{1,2}(s)\phi \otimes g_\eta - \phi \otimes g_\eta\|^2 \leq \frac{A^2 s^2}{\eta^3 \sqrt{\pi}} \int_E |x\phi(x)|^2 dx + 2\varepsilon, \quad (101)$$

and since ϕ is Schwartz, $\int_{x \in E} |x\phi(x)|^2$ is bounded by some $B > 0$. Finally,

$$\|\text{CX}_{1,2}(s)\phi \otimes g_\eta - \phi \otimes g_\eta\|^2 \leq \frac{A^2 B s^2}{\eta^3 \sqrt{\pi}} + 2\varepsilon, \quad (102)$$

whence picking $\eta > \sqrt[3]{\frac{A^2 B s^2}{\varepsilon \sqrt{\pi}}}$ we have $\|\text{CX}_{1,2}(s)\phi \otimes g_\eta - \phi \otimes g_\eta\|^2 < 3\varepsilon$, and because $\varepsilon > 0$ was arbitrary,

$$\lim_{\eta \rightarrow \infty} \|\text{CX}_{1,2}(s)\phi \otimes g_\eta - \phi \otimes g_\eta\|^2 = 0. \quad (103)$$

As every controlled stabiliser can be reduced to this case by commuting through E_G :

$$\text{CX}_{j,k}(s) \text{CZ}_{j,N(k)}(s) E_G = E_G \text{CX}_{j,k}(s), \quad (104)$$

we can reduce the lemma to just this subcase, and we are done. \square

A.4 Proof of Theorem II

Theorem II (CV-flow circuit). *If (G, I, O) is an open graph with CV-flow and $|I| = |O|$ then the CV-flow correction protocol converges to a unitary acting on the input state. If $\{L_k\}_{k=1}^n$ is a corresponding layer decomposition, for any $\vec{\alpha}, \vec{\beta}, \vec{\gamma} \in \mathbb{R}^{|O|}$ let*

$$\mathbf{W}(\vec{\alpha}, \vec{\beta}, \vec{\gamma}) := \prod_{k=1}^n \mathsf{T}^{(k)} \mathsf{U}_{SPT}^{(k)}(\vec{\alpha}, \vec{\beta}, \vec{\gamma}), \quad (105)$$

where $\mathsf{U}_{SPT}^{(k)}$ is the circuit extracted for the k -th layer using the causal flow from lemma 18, and $\mathsf{T}^{(k)}$ contains the CX gates obtained from the triangularisation of the CV-flow (lemma 17).

Then, for any $\vec{\alpha}, \vec{\beta}, \vec{\gamma} \in \mathbb{R}^{|O|}$ and any physical input state $\rho \in D(\mathcal{H}^{\otimes |I|})$,

$$\lim_{\eta \rightarrow \infty} \mathcal{E}_\eta(\vec{\alpha}, \vec{\beta}, \vec{\gamma})[\rho] = \mathbf{W}(\vec{\alpha}, \vec{\beta}, \vec{\gamma}) \rho \mathbf{W}^*(\vec{\alpha}, \vec{\beta}, \vec{\gamma}). \quad (106)$$

$\mathsf{T}^{(k)} \mathsf{U}_{SPT}^{(k)}(\vec{\alpha}, \vec{\beta}, \vec{\gamma})$ acts on the qumodes represented by wires indexed by L_k , and the total product \mathbf{W} acts on the qumodes represented by wires indexed by I .

Proof. By lemma 19 we obtain a graph G' that is approximately equivalent to G up to CX gates. Let $E_G^{(k)}$ be the product of CZ gates in G' from layer V_k into its outputs and $\mathsf{T}^{(k)}$ the CX gates obtained from the corresponding triangularisation procedure. By lemmas 17 and 19 for any $A > 0$ we have, for high enough squeezing, that

$$\left\| E_G g_\eta^{\otimes |I^c|} \otimes \phi - \prod_{k=1}^n \left(\mathsf{T}^{(k)} E_G^{(k)} \right) g_\eta^{\otimes |I^c|} \otimes \phi \right\| < A. \quad (105)$$

Now, none of the edges in $\mathsf{T}^{(k)} E_G^{(k)}$ for $k < n$ touch the nodes in V_{k+1} , so that we can bring the auxiliary squeezed states $|\eta\rangle_v$ for $v \in V_k$ forward until $E_G^{(k)}$. Since there is a causal flow $V_{k+1} \rightarrow V_k$,

$$\prod_{k=1}^n \left(\mathsf{T}^{(k)} E_G^{(k)} \right) g_\eta^{\otimes |I^c|} \otimes \phi = \mathsf{T}^{(n)} \circ \mathcal{O}^{(n)} \circ \dots \circ \mathsf{T}^{(1)} \circ \mathcal{O}^{(1)}[\phi] \quad (106)$$

where $\mathcal{O}^{(k)}$ is the channel associated to the causal flow procedure $V_{k+1} \rightarrow V_k$. Then by proposition 13, we can perform an SPT for each $\mathcal{O}^{(k)}$, and

$$\lim_{\eta \rightarrow \infty} \mathcal{E}_\eta(\vec{\alpha}, \vec{\beta}, \vec{\gamma}) = \prod_{k=1}^n \mathsf{T}^{(k)} \mathsf{U}_{SPT}^{(k)}(\vec{\alpha}, \vec{\beta}, \vec{\gamma}), \quad (107)$$

by continuity. \square

B A polynomial time algorithm for finding CV-flows

The following pseudocode algorithm finds a CV-flow for an open graph if it has one (we interpret the return value \emptyset as the graph not having a flow). Our algorithm is based on [MP08], which contains an almost identical algorithm for the qubit case.

```

1: input: A CV open graph
2: output: A CV-flow

3: procedure CV-FLOW( $G, I, O$ )
4:   for all  $v \in O$  do
5:     layer( $v$ ) := 0
6:   end for
7:   return CV-FLOW-AUX( $G, I, O$ , layer, flow, 1)
8: end procedure

9: procedure CV-FLOW-AUX( $G$ , In, Out, layer,  $k$ )
10:   $O' := O \setminus I$                                 ▷ Nodes onto which we can correct
11:   $C := \emptyset$                                     ▷ Nodes which we are correcting in this layer
12:  for all  $v \in G \setminus O$  do
13:    solve in  $\mathbb{R}$ :  $A_C \vec{c} = 1_{\{v\}}$  assuming  $v \prec o$  for all  $v \in O^c, o \in O$     ▷  $A_C$  is the
    correction matrix of  $C$ 
14:    if there is a solution  $\vec{c}$  then
15:       $C := C \cup \{v\}$ 
16:      layer( $v$ ) :=  $k$                                 ▷ Assign  $v$  to layer  $k$ 
17:      flow( $k$ ) =  $\vec{c}$                                 ▷ The corrections for layer  $k$ 
18:    end if
19:  end for
20:  if  $C = \emptyset$  then                                ▷ If we can no longer correct for additional nodes, either:
21:    if  $O = G$  then
22:      return (flow, layer) ▷ we have found a CV-flow for the whole open graph; or,
23:    else
24:      return  $\emptyset$                                 ▷ there is no CV-flow.
25:    end if
26:  else
27:    return CV-FLOW-AUX( $G, I, O \cup C$ , layer, flow,  $k + 1$ )
28:  end if
29: end procedure

```

The return value is a pair of functions, layer : $G \rightarrow \mathbb{N}$ which assigns each node to a layer, and flow : $\mathbb{N} \rightarrow \mathbb{R}^N$ which returns the correction coefficients for each layer. The ordering for the CV-flow is implicitly given by the layers: all nodes within layers are unordered with respecting to each other and nodes in layer $k + 1$ are less than nodes in layer k .

For a proof of the running time of this algorithm, we refer the reader to [MP08]. The only real difference between that algorithm and ours are the lines 13 to 18: the correction equations are solved over \mathbb{R} instead of \mathbb{Z}_2 , and the type of the solution is subtly different.

C Comparing g-flow and CV-flow

Definition 24. An open graph (G, I, O) has a **generalised flow**, or gflow, if there exists a map $g : I^c \rightarrow \mathcal{P}(O^c)$ and a partial order \prec over G such that for all $i \in I^c$:

- if $j \in g(i)$ and $i \neq j$ then $i \prec j$;
- if $j \prec i$ then $j \notin \text{Odd}(g(i))$. ┘

It is not immediately clear if gflow and CV-flow are equivalent properties or not, or even if one is strictly stronger than the other. We construct counterexamples to either implication, showing that these are indeed entirely independent properties. Thus, a graph can have both (as in the case of flow), either or neither.

Proposition 25. *The open graph*

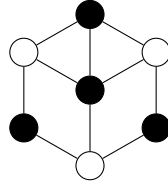

has a gflow but no CV-flow.

Proof. The graph has a gflow, given (for example) by the measurement order

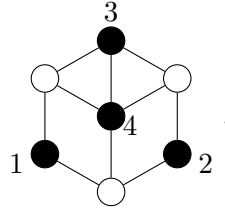

where we correct each of the first three nodes onto an unmeasured neighbour, and the fourth node is corrected on all three outputs. The modularity ensures that this last correction has no backaction on nodes 1 to 3.

Now, we show that the graph does not have CV-flow, by showing that no node in the graph can be measured last. There are two cases: either we measure the central node last (case 1), or we measure one of the outer nodes last (case 2) (by symmetry, these are all equivalent).

Case 1: The maximal correction subgraph, where we are correcting a measurement on the blue node and the black nodes have already been measured, is given by

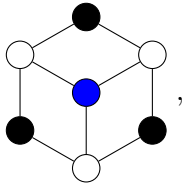

for which the correction equation has superior matrix

$$\left(\begin{array}{ccc|c} 1 & 1 & 1 & 1 \\ 1 & 1 & 0 & 0 \\ 1 & 0 & 1 & 0 \\ 0 & 1 & 1 & 0 \end{array} \right).$$

Case 2: The maximal correction subgraph is given by

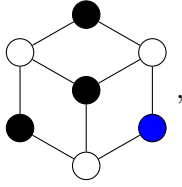

, for which the correction equation has superior matrix

$$\left(\begin{array}{ccc|c} 1 & 1 & 1 & 0 \\ 1 & 1 & 0 & 1 \\ 1 & 0 & 1 & 0 \\ 0 & 1 & 1 & 0 \end{array} \right).$$

Since both of these superior matrices have reduced row echelon form

$$\left(\begin{array}{ccc|c} 1 & 0 & 0 & 0 \\ 0 & 1 & 0 & 0 \\ 0 & 0 & 1 & 0 \\ 0 & 0 & 0 & 1 \end{array} \right),$$

equation the correction equation has no solution in either case. For any CV-flow to exist, we must be able to measure and correct some node of the graph last (every partial order extends consistently to a total order), so we have constructed a graph that has a gflow but no CV-flow. \square

Proposition 26. *The open graph*

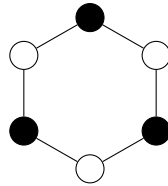

has a CV-flow but no gflow.

Proof. Any measurement order on the nodes is equivalent by symmetry, so the graph has a unique CV-flow (up to rotations) given by:

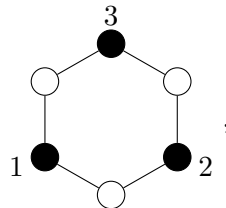

where we correct the first two measurement onto a neighbouring output (as per flow), and the last measurement outcome m as:

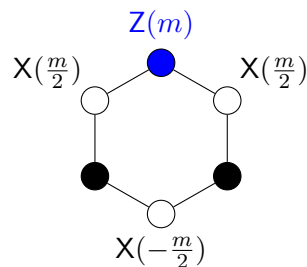

By definition 24, this last correction is not possible in DV, as every possible subset of the unmeasured nodes (in white) that connects oddly to the measured node (in blue) also connects oddly to one of the previously corrected nodes (in black). \square

D Depth complexity advantage in CV-MBQC

One of the main reasons for interest in measurement-based quantum computation originally came from the reduction in depth of certain quantum computations when the corresponding quantum circuit is reformulated as an MBQC [BK09; MHM15]. This improvement does not come for free: to obtain an MBQC that implements the same computation typically requires one to increase the number of quantum systems involved in the computation. We show that these results straightforwardly transfer to the CV setting, by constructing a computation which takes at least logarithmic depth as a quantum circuit, but can be implemented in constant depth as an MBQC.

This result was originally obtained in the qubit case in [BK09], by considering a simple arithmetic problem. The problem asks one to sum N binary digits, and a simple argument shows that accessing all the binary digits requires at least a logarithmic number of sequential binary gates. We reformulate this problem in CV. In order to avoid the questions of precision when encoding arbitrary real numbers, we instead consider the analogous problem for integers.

Each integer in the input (to be summed) is encoded in the position observable of a qumode, use the following state: for any $k \in \mathbb{Z}$, let $f_k \in L^2(\mathbb{R})$ be given by

$$f_k(x) := \begin{cases} 1 & \text{if } x \in [k, k+1); \\ 0 & \text{otherwise.} \end{cases} \quad (108)$$

The point is that, given two such states f_m and f_n (where $m, n \in \mathbb{Z}$), we can use a CZ gate to obtain the sum of m and n , itself encoded in a state of the form f_{m+n} :

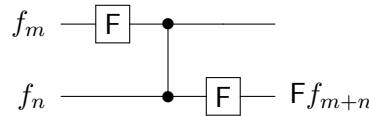

We ignore the first output of the circuit.

Now, let $(k_j)_{j=1}^N \in \mathbb{Z}^N$ be a set of integers corresponding to the input of the problem, and consider the CV-MBQC given by the open graph

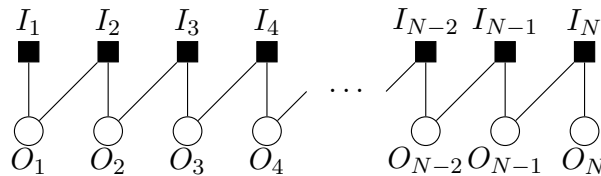

where the input I_n is prepared in the state f_{k_n} . This open graph has a 1-step CV-flow

where all the inputs are in the layer $I \prec O$. The correction equation is given by

$$\begin{pmatrix} 1 & 0 & 0 & 0 & 0 & \cdots & 0 & 0 \\ 1 & 1 & 0 & 0 & 0 & \cdots & 0 & 0 \\ 0 & 1 & 1 & 0 & 0 & \cdots & 0 & 0 \\ 0 & 0 & 1 & 1 & 0 & \cdots & 0 & 0 \\ 0 & 0 & 0 & 1 & 1 & \cdots & 0 & 0 \\ \vdots & \vdots & \vdots & \vdots & \vdots & \ddots & \vdots & \vdots \\ 0 & 0 & 0 & 0 & 0 & \cdots & 1 & 0 \\ 0 & 0 & 0 & 0 & 0 & \cdots & 1 & 1 \end{pmatrix} \vec{c} = \begin{pmatrix} m_1 \\ m_2 \\ m_3 \\ m_4 \\ m_5 \\ \vdots \\ m_{N-1} \\ m_N \end{pmatrix}, \quad (109)$$

which has a solution $\vec{c} \in \mathbb{R}^N$ whose n -th element is $c_n = \sum_{j=1}^n m_j$. Performing the circuit extraction as described in section 3 and taking $\alpha = \beta = \gamma = 0$ at each measured node (that is, we just measure P), we see that the MBQC is equivalent in the infinite-squeezing limit to the circuit

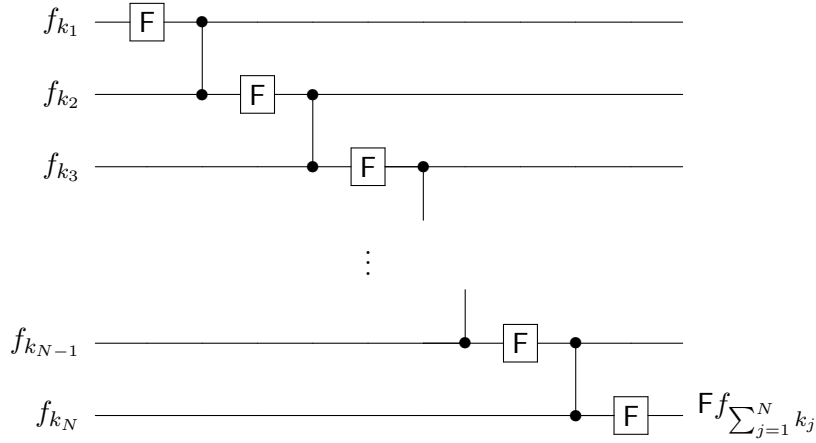

where we only care about the last output. Since the graph state can be generated in two steps provided access to the input states (generating the auxiliary squeezed states then performing the entangling unitaries), the CV-MBQC yields a quantum circuit for generating the output state $F f_{\sum_{j=1}^N k_j}$ in constant depth and with using $2N$ qumodes. In particular, this allows us to determine $\sum_{j=1}^N k_j$ for any input $(k_j)_{j=1}^N \in \mathbb{Z}^N$, since performing a momentum measurement on the output state $F f_{\sum_{j=1}^N k_j}$ is guaranteed to return a value in $[\sum_{j=1}^N k_j, \sum_{j=1}^N k_j + 1)$.

Now, from [BK09] we have:

Proposition 27. *Let S a unitary operator on \mathcal{H} that restricts to the map*

$$S\left(\bigotimes_{j=1}^N f_{k_j}\right) = \bigotimes_{j=1}^{N-1} f_{k_j} \otimes \left(f_{\sum_{j=1}^N k_j}\right) \quad (110)$$

on the subspace of \mathcal{H} generated by the f_k for $k \in \mathbb{Z}$. Then any circuit of 1 and 2-qumode gates that implements S has depth in $\Omega(\log_2(N))$.

This result follows from an argument on the ‘‘backwards light-cone’’ of the outputs. In general, the output of a k -ary gate can depend only on the k inputs, so that composing

n times, the output can depend on at most k^n inputs. As a result, the number of gates needed to treat N inputs is at least $\log_k(N)$.

Thus, this example demonstrates a clear depth advantage for CV-MBQC: at the cost of doubling the width of the circuit, the unitary \mathbf{S} is implemented in constant rather than logarithmic depth.