

Intersection models and forbidden pattern characterizations for 2-thin and proper 2-thin graphs*

Flavia Bonomo-Braberman^{a,b}, Gastón Abel Brito^a

^a*Universidad de Buenos Aires. Facultad de Ciencias Exactas y Naturales. Departamento de Computación. Buenos Aires, Argentina.*

^b*CONICET-Universidad de Buenos Aires. Instituto de Investigación en Ciencias de la Computación (ICC). Buenos Aires, Argentina.*

Abstract

The thinness of a graph is a width parameter that generalizes some properties of interval graphs, which are exactly the graphs of thinness one. Graphs with thinness at most two include, for example, bipartite convex graphs. Many NP-complete problems can be solved in polynomial time for graphs with bounded thinness, given a suitable representation of the graph. Proper thinness is defined analogously, generalizing proper interval graphs, and a larger family of NP-complete problems are known to be polynomially solvable for graphs with bounded proper thinness. It is known that the thinness of a graph is at most its pathwidth plus one. In this work, we prove that the proper thinness of a graph is at most its bandwidth, for graphs with at least one edge. It is also known that boxicity is a lower bound for the thinness. The main results of this work are characterizations of 2-thin and 2-proper thin graphs as intersection graphs of rectangles in the plane with sides parallel to the Cartesian axes and other specific conditions. We also bound the bend number of graphs with low thinness as vertex intersection graphs of paths on a grid (B_k -VPG graphs are the graphs that have a representation in which each path has at most k bends). We show that 2-thin graphs are a subclass of B_1 -VPG graphs and, moreover, of monotone L-graphs (that is, B_1 -VPG graphs admitting a representation that uses only one of the four possible shapes L, J, Γ , $\bar{\Gamma}$, with an extra condition), and that 3-thin graphs are a subclass of B_3 -VPG graphs. We also show that B_0 -VPG graphs may have arbitrarily large thinness, and that not every 4-thin graph is a VPG graph. Finally, we characterize 2-thin graphs by a set of forbidden patterns for a vertex order.

Keywords: bandwidth, forbidden patterns, intersection graphs of rectangles, thinness, VPG graphs

1. Introduction

A large family of graph width parameters has been studied since the introduction of treewidth in the 80's [39], some of them very recently defined, like twin-width [4] in 2020. For each width parameter, a growing family of NP-complete problems are known to be polynomial time solvable on graph classes of bounded width. Thus, it is interesting to find structural properties of a graph class that ensure bounded width. In this work we will focus on a width parameter called the thinness of a graph.

A graph $G = (V, E)$ is k -thin if there exist an ordering v_1, \dots, v_n of V and a partition of V into k classes (V^1, \dots, V^k) such that, for each triple (r, s, t) with $r < s < t$, if v_r, v_s belong to the same class and $v_t v_r \in E$, then $v_t v_s \in E$. Such an ordering and partition are called *consistent*. The minimum k such that G is k -thin is called the *thinness* of G and is denoted by $\text{thin}(G)$. The thinness is unbounded on the class of all graphs, and graphs with bounded thinness were introduced by Mannino, Oriolo, Ricci and Chandran in [30] as a generalization of *interval graphs* (intersection graphs of intervals of the real line), which are exactly the 1-thin graphs [34]. Graphs of thinness at most two include, for example, convex bipartite graphs [7].

In [5], the concept of *proper thinness* is defined in order to obtain an analogous generalization of *proper interval graphs* (intersection graphs of intervals of the real line such that no interval properly contains another). A graph $G = (V, E)$ is *proper k -thin* if there exist an ordering and a partition of V into k classes such that both the ordering and its reverse are consistent with the partition. Such an ordering and partition are called *strongly consistent*. The minimum k such that G is proper k -thin is called the *proper thinness* of G and is denoted by $\text{pthin}(G)$. Proper interval graphs are exactly the proper 1-thin graphs [36], and in [5] it is proved that the proper thinness is unbounded on the class of interval graphs. Examples of thin representations of graphs are shown in Figure 1.

*An extended abstract of this work, entitled "Intersection models for 2-thin and proper 2-thin graphs", was accepted for LAGOS 2021 and will appear in ENTCS.

Email address: fbonomo@dc.uba.ar (Flavia Bonomo-Braberman)

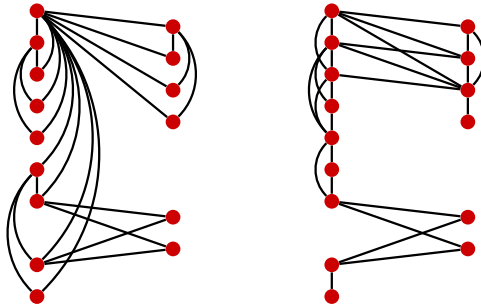

Figure 1: A 2-thin graph (whose proper thinness is 3) and a proper 2-thin graph. The vertices are ordered increasingly by their y -coordinate, and the classes correspond to the vertical lines.

In [8], the concept of (*proper*) *independent thinness* was introduced in order to bound the (proper) thinness of the lexicographical and direct products of two graphs. In this case it is required, additionally, the classes of the partition to be independent sets. These concepts are denoted by $\text{thin}_{\text{ind}}(G)$ and $\text{pthin}_{\text{ind}}(G)$, respectively.

The relation between thinness and other well known width parameters is surveyed in [5]. The *pathwidth* (resp. *bandwidth*) of a graph G can be defined as one less than the maximum clique size of an interval (resp. *proper* interval) supergraph of G , chosen to minimize its maximum clique size [27, 32]. In [30] it is proved that the thinness of a graph is at most its pathwidth plus one but, indeed, the proof shows that the *independent* thinness of a graph is at most its pathwidth plus one. Combining the ideas behind that proof and a characterization of the bandwidth of a graph as a *proper pathwidth*, due to Kaplan and Shamir [27], it can be proved that the proper independent thinness of a graph is at most its bandwidth plus one. We will furthermore prove that the proper thinness of a graph with at least one edge is at most its bandwidth.

Several graph classes are defined by means of a geometrical intersection model, being the most prominent of such classes the class of interval graphs, introduced by Hajós in 1957 [21]. Moreover, many of these classes are generalizations of interval graphs, like circular-arc graphs [18], vertex and edge intersection graphs of paths on a grid [2, 20], and graphs with bounded boxicity. The *boxicity* of a graph, introduced by Roberts in 1969 [37], is the minimum dimension in which a given graph can be represented as an inter-

section graph of axis-parallel boxes. Chandran, Mannino, and Oriolo in [11] proved that the thinness of a graph is at least its boxicity, so 2-thin graphs are a subclass of boxicity 2 graphs, i.e., intersection graphs of axis-parallel rectangles in the plane. Their proof is constructive, and in their boxicity 2 model for 2-thin graphs, the upper-right corners of the rectangles lie in two diagonals, according to the class the corresponding vertex belongs to. They furthermore proved that boxicity 2 graphs have unbounded thinness. Indeed, while the independent set problem is NP-complete on boxicity 2 graphs, even if the rectangle model is given [17, 25], that and a wide family of NP-complete problems are polynomial-time solvable on graphs of bounded thinness, when the representation is given, and the family of problems can be enlarged for proper thinness [5, 6, 30]. So, it is of interest to study which boxicity 2 graphs have bounded (proper) thinness. We will do in Section 4 a slight modification to their model for 2-thin graphs, needed to obtain, together with the diagonals property, a full characterization in Theorem 8. Namely, we modify it to satisfy a further property that we call *blocking*, needed to prove the equivalence in the theorem. Notice that when restricting the upper-right corners of the rectangles to lie in one diagonal, we obtain the class of interval graphs, i.e., 1-thin graphs. The definition of *p-box graphs* [41] is similar, since they are the intersection graphs of rectangles such that the lower-right corners lie in a diagonal.

The models with this kind of restrictions, like endpoints, corners or sides of the geometrical objects lying on a line, are known in the literature as *grounded models* (see Figure 2). A graph is B_k -VPG if it is the vertex intersection graph of paths with at most k bends in a grid [2]. VPG graphs, without bounds in the number of bends, are also known as *string graphs*. A subclass of B_1 -VPG graphs is the class of L-graphs, in which all the paths have the shape L. Many classes can be characterized by different grounded L-models. For instance, circle graphs are exactly the doubly grounded L-graphs where both endpoints of the paths belong to an inverted diagonal [2], and p-box graphs are also characterized as *monotone* L-graphs [1]. A very nice survey on this kind of models can be found in [26]. We present here another grounded rectangle model for 2-thin graphs that gives rise to a grounded L-model for them and a grounded B_0 -VPG model for independent 2-thin graphs. Based on these models, we can also obtain a B_3 -VPG representation for 3-thin graphs and a B_1 -VPG representation for independent 3-thin graphs. We furthermore show that B_0 -VPG graphs have unbounded thinness, and that not every 4-thin graph is a VPG graph. The L-model can be

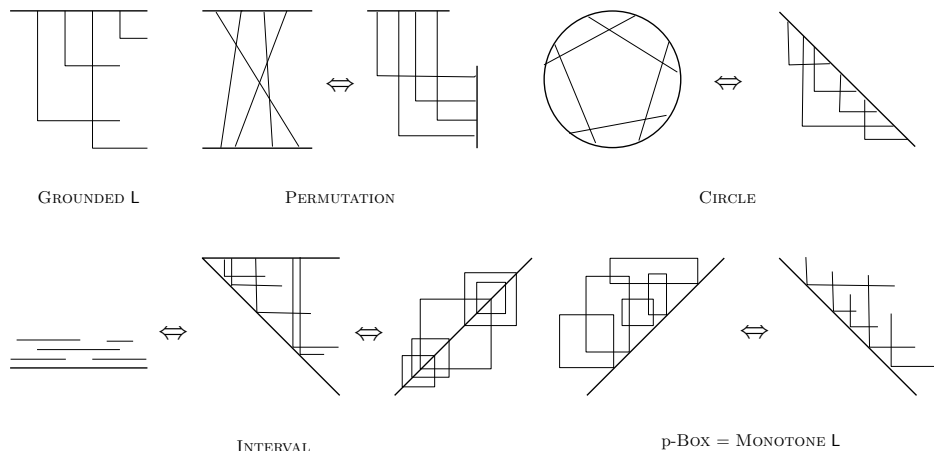

Figure 2: Other graph classes defined or characterized by grounded box models or grounded L-models.

modified to prove that 2-thin graphs are monotone L-graphs. Notice that the class of monotone L-graphs or p-box graphs contains all trees [41], which have unbounded thinness [5], and that the octahedron $\overline{3K_2}$ is an example of a graph of thinness 3 which is not p-box since it has boxicity 3 [37].

As a last result, we obtain forbidden ordered pattern characterizations for 2-thin graphs, independent 2-thin graphs, and proper independent 2-thin graphs.

1.1. Basic definitions

All graphs in this work are finite, have no loops or multiple edges, and are undirected unless we say explicitly *digraphs*. For a graph G , denote by $V(G)$ its vertex set and by $E(G)$ its edge set. For a subsets A of $V(G)$, denote by $G[A]$ the subgraph of G induced by A .

A *digraph* is a graph $D = (V, A)$ such that A consists of ordered pairs of V , called *arcs*. A *cycle* of a digraph D is a sequence $v_1, v_2, \dots, v_i, 1 \leq i \leq n$, of vertices of $V(D)$ such that $v_1 = v_i$ and, for all $1 \leq j < i$, $v_j v_{j+1} \in A(D)$. A digraph is *acyclic* if it has no directed cycles. A *topological ordering* of a digraph D is an ordering $<$ of its vertices such that for each arc $vw \in A(D)$, $v < w$. A digraph admits a topological ordering if and only if it is acyclic, and such an ordering can be computed in $O(|V| + |A|)$ time [28].

Denote the size of a set S by $|S|$. A *clique* or *complete set* (resp. *independent set*) is a set of pairwise adjacent (resp. nonadjacent) vertices. The

clique number of a graph is the size of a maximum clique. Let $X, Y \subseteq V(G)$. We say that X is *complete to* Y if every vertex in X is adjacent to every vertex in Y , and that X is *anticomplete to* Y if no vertex of X is adjacent to a vertex of Y . A graph is *complete* if its vertex set is a complete set. A graph is *bipartite* if its vertex set can be partitioned into two independent sets, and *complete bipartite* if those sets are complete to each other.

Given a graph G and two disjoint subsets A, B of $V(G)$, the bipartite graph $G[A, B]$ is defined as the subgraph of G formed by the vertices $A \cup B$ and the edges of G that have one endpoint in A and one in B . Notice that $G[A, B]$ is not necessarily an induced subgraph of G .

A t -*coloring* of a graph is a partition of its vertices into t independent sets. The smallest t such that G admits a t -coloring is called the *chromatic number* of G . A graph is *perfect* if for every induced subgraph of it, the chromatic number equals the clique number.

A graph $G(V, E)$ is a *comparability graph* if there exists an ordering v_1, \dots, v_n of V such that, for each triple (r, s, t) with $r < s < t$, if $v_r v_s$ and $v_s v_t$ are edges of G , then so is $v_r v_t$. Such an ordering is a *comparability ordering*. A graph is a *co-comparability graph* if its complement is a comparability graph. A graph is a *permutation graph* if it is both a comparability and a co-comparability graph, and a *bipartite permutation graph* if it is, moreover, bipartite.

A bipartite graph with bipartition (X, Y) is an *interval bigraph* if every vertex can be assigned an interval on the real line such that for all $x \in X$ and $y \in Y$, x is adjacent to y if and only if the corresponding intervals intersect. A *proper interval bigraph* is an interval bigraph admitting a representation in which the family of intervals of each of X, Y is inclusion-free. Proper interval bigraphs are equivalent to bipartite permutation graphs [22].

2. Algorithmic aspects of thinness

The recognition problem for k -thin and proper k -thin graphs is open, even for fixed $k \geq 2$. Some related algorithmic problems were also studied: partition into a minimum number of classes (strongly) consistent with a given vertex ordering [5, 6], existence of a vertex ordering (strongly) consistent with a given vertex partition [5], existence of a vertex ordering (strongly) consistent with a given vertex partition requiring additionally that the vertices on each class are consecutive in the order [9, 35]. In this work, in order to prove the intersection model characterizations, we will deal with the problem of

the existence of a vertex ordering (strongly) consistent with a given vertex partition and that extends a partial order of the vertices that is a total order when restricted to each of the parts.

The problem of finding a partition into a minimum number of classes (strongly) consistent with a given vertex ordering can be solved by coloring a conflict graph, that is shown to belong to a class in which the coloring problem is polynomial time solvable. Namely, let G be a graph and $<$ an ordering of its vertices. In [6], it was defined the graph $G_{<}$ having $V(G)$ as vertex set, and $E(G_{<})$ is such that for $v < w$, $vw \in E(G_{<})$ if and only if there is a vertex z in G such that $w < z$, $zv \in E(G)$ and $zw \notin E(G)$. Similarly, in [5], it was introduced the graph $\tilde{G}_{<}$, which has $V(G)$ as vertex set, and $E(\tilde{G}_{<})$ is such that for $v < w$, $vw \in E(\tilde{G}_{<})$ if and only if either $vw \in E(G_{<})$ or there is a vertex x in G such that $x < v$, $xw \in E(G)$ and $xv \notin E(G)$. An edge of $G_{<}$ (respectively $\tilde{G}_{<}$) represents that its endpoints cannot belong to the same class in a vertex partition that is consistent (respectively strongly consistent) with the ordering $<$, and, as it was observed in the respective works, such a partition is a coloring of the corresponding graph.

In those works it was proved that $G_{<}$ and $\tilde{G}_{<}$ are co-comparability graphs, thus perfect [31]. This has two main implications. The first one is that the optimum coloring can be computed in polynomial time [19], and thus the problem of finding a partition into a minimum number of classes (strongly) consistent with a given vertex ordering can be solved in polynomial time. The other one is that the chromatic number equals the clique number, and the following corollary was used to prove upper and lower bounds for the thinness and proper thinness of a graph.

Corollary 1. [8] *Let G be a graph, and k a positive integer. Then $\text{thin}(G) \geq k$ (resp. $\text{pthin}(G) \geq k$) if and only if, for every ordering $<$ of $V(G)$, the graph $G_{<}$ (resp. $\tilde{G}_{<}$) has a clique of size k .*

The problem about the existence of a vertex ordering (strongly) consistent with a given vertex partition was shown to be NP-complete [5], but the complexity remains open when the number of parts is fixed. The problem about the existence of a vertex ordering consistent with a given vertex partition requiring additionally that the vertices on each class are consecutive in the order was shown to be polynomial time solvable [9]. The same problem for strong consistency was shown NP-complete when the number of parts is arbitrary [9], and polynomial time solvable when the number of parts is

fixed [35]. Under the same additional constraints, the problem of finding a minimum size partition for a given ordering is polynomial time solvable, and the complexity of the problem of finding an ordering that minimizes the size of a minimum size partition is unknown.

Let us solve now the following problem.

(STRONGLY) CONSISTENT EXTENDING ORDER – (S)CEO

Instance: A graph G , a partition $\Pi = \{V^1, \dots, V^k\}$ and a partial order $<$ of $V(G)$ that is total and (strongly) consistent restricted to each V^j , $1 \leq j \leq k$.

Question: Does there exist a total ordering of $V(G)$ extending $<$ and (strongly) consistent with Π ?

Given the input of the (S)CEO problem, we define a digraph $D(G, \Pi, <)$ (resp. $\tilde{D}(G, \Pi, <)$) having $V(G)$ as vertex set and such that an ordering of $V(G)$ is a solution to (S)CEO if and only if it is a topological ordering of $D(G, \Pi, <)$ (resp. $\tilde{D}(G, \Pi, <)$). The problem then reduces to the existence of a topological order of a digraph, which is polynomial time solvable [28]. Given two vertices $v_i \in V^i$, $v_j \in V^j$, $i \neq j$, we create the arc $v_i v_j$ in $D(G, \Pi, <)$ if and only if $v_i v_j \notin E(G)$ and there exists $v'_j \in V^j$ with $v'_j < v_j$ and $v_i v'_j \in E(G)$, and in $\tilde{D}(G, \Pi, <)$ if and only if $v_i v_j \notin E(G)$ and either there exists $v'_j \in V^j$ with $v'_j < v_j$ and $v_i v'_j \in E(G)$, or there exists $v'_i \in V^i$ with $v'_i > v_i$ and $v'_i v_j \in E(G)$. Additionally, in order to ensure that a topological ordering of the digraph extends $<$, we create in both cases the arc vv' for every pair of vertices $v < v'$.

Lemma 2. *Let G be a graph, $\Pi = \{V^1, \dots, V^k\}$ a partition and $<$ a partial order of $V(G)$ that is total and consistent restricted to each V^j , $1 \leq j \leq k$. An ordering of $V(G)$ is consistent with the partition Π and extends the partial order $<$ if and only if it is a topological ordering of $D(G, \Pi, <)$.*

Proof. Suppose first \prec is a total ordering of $V(G)$ consistent with the partition Π and that extends the partial order $<$. Let vv' be an arc such that $v < v'$. Then $v \prec v'$, since \prec extends $<$. Let $v_i v_j$ be an arc with $v_i \in V^i$, $v_j \in V^j$, $i \neq j$, such that $v_i v_j \notin E(G)$ and there exists $v'_j \in V^j$ with $v'_j < v_j$ and $v_i v'_j \in E(G)$. Suppose that $v_j \prec v_i$. Since \prec extends $<$, $v'_j \prec v_j \prec v_i$, and $v_i v'_j \in E(G)$ but $v_i v_j \notin E(G)$, a contradiction because \prec is consistent with the partition Π . Thus $v_i \prec v_j$ for every such arc, and \prec is a topological ordering for $D(G, \Pi, <)$.

Conversely, suppose \prec is a topological ordering for $D(G, \Pi, <)$. Let $v'_j \prec v_j \prec v_i$ such that $v_i \in V^i$, $v_j, v'_j \in V^j$, $v'_j v_i \in E(G)$. If $i = j$, then $v'_j \prec v_j \prec v_i$ because $<$ is total restricted to V^i and \prec extends $<$, so $v_j v_i \in E(G)$ because $<$ is consistent restricted to V^i . If $i \neq j$, then $v'_j \prec v_j$ because $<$ is total restricted to V^j and \prec extends $<$. Since \prec is a topological ordering for $D(G, \Pi, <)$, $v_i v_j$ is not an arc of $D(G, \Pi, <)$, thus $v_i v_j \in E(G)$. \square

Lemma 3. *Let G be a graph, $\Pi = \{V^1, \dots, V^k\}$ a partition and $<$ a partial order of $V(G)$ that is total and strongly consistent restricted to each V^j , $1 \leq j \leq k$. An ordering of $V(G)$ is strongly consistent with the partition Π and extends the partial order $<$ if and only if it is a topological ordering of $\tilde{D}(G, \Pi, <)$.*

Proof. Suppose first \prec is a total ordering of $V(G)$ strongly consistent with the partition Π and that extends the partial order $<$. Let vv' be an arc such that $v < v'$. Then $v \prec v'$, since \prec extends $<$. Let $v_i v_j$ be an arc with $v_i \in V^i$, $v_j \in V^j$, $i \neq j$, such that $v_i v_j \notin E(G)$ and there exists $v'_j \in V^j$ with $v'_j \prec v_j$ and $v_i v'_j \in E(G)$. Suppose that $v_j \prec v_i$. Since \prec extends $<$, $v'_j \prec v_j \prec v_i$, and $v_i v'_j \in E(G)$ but $v_i v_j \notin E(G)$, a contradiction because \prec is strongly consistent with the partition Π . Thus $v_i \prec v_j$ for every such arc. Analogously, let $v_i v_j$ be an arc with $v_i \in V^i$, $v_j \in V^j$, $i \neq j$, such that $v_i v_j \notin E(G)$ and there exists $v'_i \in V^i$ with $v'_i > v_i$ and $v'_i v_j \in E(G)$. Suppose that $v_j \prec v_i$. Since \prec extends $<$, $v_j \prec v_i \prec v'_i$, and $v'_i v_j \in E(G)$ but $v_i v_j \notin E(G)$, a contradiction because \prec is strongly consistent with the partition Π . Thus $v_i \prec v_j$ for every such arc. Therefore, \prec is a topological ordering for $\tilde{D}(G, \Pi, <)$.

Conversely, suppose \prec is a topological ordering for $\tilde{D}(G, \Pi, <)$. Let $v_i \prec v'_i \prec v''_i$ in V^i , such that $v_i v''_i \in E(G)$. Then $v_i < v'_i < v''_i$ because $<$ is total restricted to V^i and \prec extends $<$, so $v_i v'_i, v'_i v''_i \in E(G)$ because $<$ is strongly consistent restricted to V^i . Let $v'_j \prec v_j \prec v_i$ such that $v_i \in V^i$, $v_j, v'_j \in V^j$, $i \neq j$, and $v'_j v_i \in E(G)$. Then $v'_j \prec v_j$ because $<$ is total restricted to V^j and \prec extends $<$. Since \prec is a topological ordering for $\tilde{D}(G, \Pi, <)$, $v_i v_j$ is not an arc of $\tilde{D}(G, \Pi, <)$, thus $v_i v_j \in E(G)$. Analogously, let $v_j \prec v_i \prec v'_i$ such that $v_i, v'_i \in V^i$, $v_j \in V^j$, $i \neq j$, and $v_j v'_i \in E(G)$. Then $v_i < v'_i$ because $<$ is total restricted to V^i and \prec extends $<$. Since \prec is a topological ordering for $\tilde{D}(G, \Pi, <)$, $v_i v_j$ is not an arc of $\tilde{D}(G, \Pi, <)$, thus

$v_i v_j \in E(G)$. □

3. Thinness and other width parameters

Given a graph G , the *pathwidth* $\text{pw}(G)$ (resp. *bandwidth* $\text{bw}(G)$) may be defined as one less than the maximum clique size in an interval (resp. *proper* interval) supergraph of G , chosen to minimize its clique size [27]. It was implicitly proved in [30] that $\text{thin}_{\text{ind}}(G) \leq \text{pw}(G) + 1$. We will reproduce here the proof, emphasizing the independence of the classes defined. A characterization in [27] of the bandwidth as a *proper pathwidth* allows to mimic the proof in [30] and prove that $\text{pthin}_{\text{ind}}(G) \leq \text{bw}(G) + 1$. This bound can be improved for non-empty graphs. We use a third equivalent definition of bandwidth, namely $\text{bw}(G) = \min_f \max\{|f(v_i) - f(v_j)| : v_i v_j \in E\}$, for $f : V(G) \rightarrow \mathbb{Z}$ an injective labeling, and Corollary 1 to prove the following.

Theorem 4. *Let G be a graph with at least one edge. Then $\text{pthin}(G) \leq \text{bw}(G)$.*

Proof. Suppose on the contrary that $\text{pthin}(G) > \text{bw}(G)$. By Corollary 1, for every vertex order $<$ of G , there is a clique of size $\text{bw}(G) + 1$ in $\tilde{G}_{<}$. Let f be a labeling of $V(G)$ realizing the bandwidth and $<$ be the order induced by f . Suppose $v_1 < v_2 < \dots < v_b < v_{b+1}$ is a clique of $\tilde{G}_{<}$, where $b = \text{bw}(G)$. As $v_1 v_{b+1} \in E(\tilde{G}_{<})$, there exists either v_0 such that $v_0 < v_1$, $v_0 v_{b+1} \in E(G)$, and $v_0 v_1 \notin E(G)$, or v_{b+2} such that $v_{b+2} > v_{b+1}$, $v_1 v_{b+2} \in E(G)$, and $v_{b+1} v_{b+2} \notin E(G)$. In the first case, $|f(v_{b+1}) - f(v_0)| = f(v_{b+1}) - f(v_0) \geq b + 1$ and, in the second case, $|f(v_{b+2}) - f(v_1)| = f(v_{b+2}) - f(v_1) \geq b + 2 - 1 = b + 1$. In either case, it is a contradiction with the fact that f realizes the bandwidth b . So, $\text{pthin}(G) \leq \text{bw}(G)$. □

This bound can be arbitrarily bad, for example, for the complete bipartite graphs $K_{n,n}$, that are proper 2-thin and have unbounded bandwidth. However, it is tight (up to a constant factor) for grids [11, 14].

A *path decomposition* [38] of a graph $G = (V, E)$ is a sequence of subsets of vertices (X_1, X_2, \dots, X_r) such that

$$(1.) \quad X_1 \cup \dots \cup X_r = V.$$

- (2.) For each edge $vw \in E$, there exists an $i \in \{1, \dots, r\}$, so that both v and w belong to X_i .
- (3.) For each $v \in V$ there exist some $s(v), e(v) \in \{1, \dots, r\}$, so that $s(v) \leq e(v)$ and $v \in X_j$ if and only if $j \in \{s(v), s(v) + 1, \dots, e(v)\}$.

The width of a path decomposition (X_1, X_2, \dots, X_r) is defined as $\max_i |X_i| - 1$. The *pathwidth* of a graph G is the minimum possible width over all possible path decompositions of G .

A *proper path decomposition* [27] of a graph $G = (V, E)$ is a path decomposition that additionally satisfies

- (4.) For every $u, v \in V$, $\{s(u), s(u)+1, \dots, e(u)\} \not\subset \{s(v), s(v)+1, \dots, e(v)\}$.

The *proper pathwidth* of a graph G is the minimum possible width over all possible proper path decompositions of G . Kaplan and Shamir [27] proved that the proper pathwidth of a graph equals its bandwidth.

Theorem 5. *For a graph G , $\text{thin}_{\text{ind}}(G) \leq \text{pw}(G) + 1$ and $\text{pthin}_{\text{ind}}(G) \leq \text{bw}(G) + 1$.*

Proof. (slight modification of the one in [30]) Consider an optimal (proper) path decomposition (X_1, X_2, \dots, X_r) of width q . Let $k = q + 1$ be the cardinality of the biggest set. We demonstrate that the graph is (proper) independent k -thin. We first describe an ordering and then give a description of how we can assign the vertices to k classes, in order to get a partition into k independent sets which is (strongly) consistent with the ordering.

We order the vertices v according to $s(v)$, and breaking ties arbitrarily. Notice that, in the proper case, by (4.), if $s(v) = s(w)$ then also $e(v) = e(w)$, and if $s(v) < s(w)$ then also $e(v) < e(w)$.

We assign the vertices in each X_i to pairwise distinct classes, for $1 \leq i \leq r$. We can do it for $i = 1$, since $|X_1| \leq k$. On each step, for $i > 1$, we assign the vertices of $X_i \setminus X_{i-1}$ to pairwise distinct classes that are not used by the vertices in $X_i \cap X_{i-1}$. This can be done because $|X_i| \leq k$.

No vertex is assigned to more than one class because of condition (3.). The classes are independent sets because of condition (2.).

Let $v \in V(G)$, with $s(v) = i$. Then all neighbors u of v smaller than v are also present in X_i , i.e., $e(u) \geq i$. Suppose $u < z < v$, $uv \in E(G)$, u, z in

the same class. Note that if z and u are in the same class, there is no subset X_k such that z, u are both in X_k . Thus $u < z$ tells us that $s(u) < s(z)$. Also, $z < v$ tells us that $s(z) \leq s(v)$. But by the claim above, $e(u) \geq s(v)$, since u is a neighbor of v smaller than v . Thus, by (3.), $u \in X_{s(z)}$, a contradiction with the fact that no set contains two vertices of the same class. Thus, the partition and the ordering of $V(G)$ we obtained are consistent. It follows that $\text{thin}_{\text{ind}}(G) \leq \text{pw}(G) + 1$.

For a (proper) path decomposition, the reverse of the order defined is a decreasing order by $e(v)$. So the same argument proves that, in that case, the partition and the ordering of $V(G)$ we obtained are strongly consistent. It follows that $\text{pthin}_{\text{ind}}(G) \leq \text{bw}(G) + 1$. \square

This bounds are tight, respectively, for interval and proper graphs, where both the (proper) independent thinness and the (proper) pathwidth plus one equal the clique number of the graph, but can be arbitrarily bad, for example, for complete bipartite graphs, that are proper independent 2-thin but have unbounded pathwidth.

Notice that Theorem 4 improves that bound for proper thinness of graphs with at least one edge. As a consequence of Theorem 4, we have the following.

Corollary 6. *Let G be a connected graph. Then $\text{pthin}(G) \leq |V(G)| - \text{diam}(G)$, where $\text{diam}(G)$ denotes the diameter of G .*

Proof. In [12], it was proved that for a connected graph, $\text{bw}(G) \leq |V(G)| - \text{diam}(G)$. \square

4. Rectangle intersection models for 2-thin and proper 2-thin graphs

We call *box* a rectangle that is aligned with the Cartesian axes in \mathbb{R}^2 , i.e., the Cartesian product of two segments $[x_1, x_2] \times [y_1, y_2]$. We say that the box b is defined by x_1, x_2, y_1, y_2 , which will be denoted by $X_1(b), X_2(b), Y_1(b)$, and $Y_2(b)$, respectively. The *upper-right corner* of b is the point (x_2, y_2) . The *vertical* (resp. *horizontal*) *prolongation* is the Cartesian product $P_Y(b) = [x_1, x_2] \times \mathbb{R}$ (resp. $P_X(b) = \mathbb{R} \times [y_1, y_2]$).

A set of boxes is *2-diagonal* if their upper-right corners are pairwise distinct and each of them lies, for some constant values $d_1 < 0 < d_2$, either

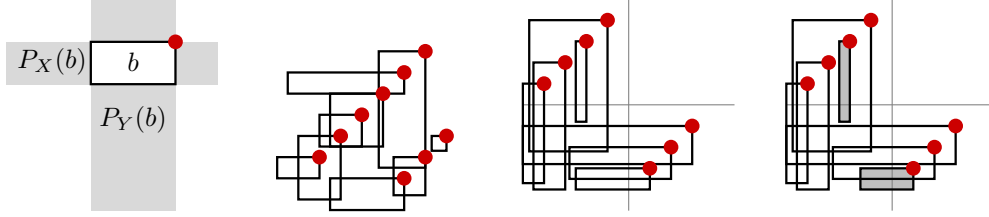

Figure 3: Upper-right corner, vertical and horizontal prolongations (first), a weakly 2-diagonal model (second), a blocking 2-diagonal model (third), a 2-diagonal model that is not blocking, where the gray boxes do not satisfy the required property (fourth).

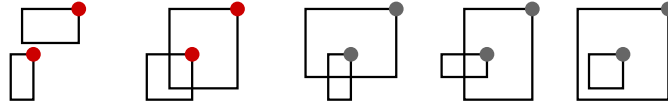

Figure 4: The first two situations are bi-semi-proper, the last three are not.

in the intersection of the diagonal $y = x + d_1$ and the 4th quadrant of the Cartesian plane, or in the intersection of the diagonal $y = x + d_2$ and the 2nd quadrant of the Cartesian plane. A set of boxes is *weakly 2-diagonal* if their upper-right corners are pairwise distinct and each of them lies, for some constant values $d_1 < d_2$, either in the diagonal $y = x + d_1$ or in the diagonal $y = x + d_2$. We will call $y = x + d_1$ the *lower diagonal* and $y = x + d_2$ the *upper diagonal*.

A 2-diagonal model is *blocking* if for every two non-intersecting boxes b_1 , b_2 in the upper and lower diagonal, resp., either the vertical prolongation of b_1 intersects b_2 or the horizontal prolongation of b_2 intersects b_1 (see Figure 3). A 2-diagonal model is *bi-semi-proper* if for any two boxes b , b' , defined by x_1, x_2, y_1, y_2 and x'_1, x'_2, y'_1, y'_2 and such that $y_2 - x_2 = y'_2 - x'_2$ and $x_2 < x'_2$, it holds $x_1 \leq x'_1$ and $y_1 \leq y'_1$ (see Figure 4).

Let $G = (V, E)$ be a 2-thin graph, with partition V^1, V^2 consistent with an order $<$. Let $V^1 = v_1 < \dots < v_{n_1}$, $V^2 = w_1 < \dots < w_{n_2}$. Let $U(1, v_i) = i$ if v_i has no neighbors smaller than itself in V^1 , or $\min\{j : v_j < v_i, v_j v_i \in E(G)\}$, otherwise. Let $U(2, w_i) = i$ if w_i has no neighbors smaller than itself in V^2 , or $\min\{j : w_j < w_i, w_j w_i \in E(G)\}$, otherwise. Let $U(2, v_i) = 0$ if v_i is adjacent to all the vertices of V^2 which are smaller than itself, or $\max\{j : w_j < v_i, w_j v_i \notin E(G)\}$, otherwise. Let $U(1, w_i) = 0$ if w_i is adjacent to all the vertices of V^1 which are smaller than itself, or $\max\{j : v_j < w_i, v_j w_i \notin E(G)\}$, otherwise.

We define the following model of G as intersection of boxes in the plane (slight modification of the model in [11]), which we will denote by $\mathcal{M}_1(G)$: the upper-right corner of v_i is $(i + n_2, i)$, for $1 \leq i \leq n_1$, and the upper-right corner of w_i is $(i, i + n_1)$, for $1 \leq i \leq n_2$; the lower-left corner of v_i is $(U(2, v_i) + 0.5, U(1, v_i) - 0.5)$, for $1 \leq i \leq n_1$, and the lower-left corner of w_i is $(U(2, w_i) - 0.5, U(1, w_i) + 0.5)$, for $1 \leq i \leq n_2$. Intuitively, the boxes having the upper right corner in the higher (resp. lower) diagonal “go down” (resp. left) and stop just to avoid the greatest non-neighbor smaller than themselves in the other class (if any), and “go left” (resp. down) enough to catch all the neighbors smaller than themselves in their own class (if any, and without intersecting a non-neighbor). An example is depicted in Figure 5.

Lemma 7. *Let $G = (V, E)$ be a 2-thin graph, with partition V^1, V^2 consistent with an order $<$. Then $\mathcal{M}_1(G)$ is a blocking 2-diagonal intersection model for G that respects the relative order on each class. Moreover, if the order and the partition are strongly consistent, the model is bi-semi-proper.*

Proof. It is straightforward that the model is 2-diagonal (after a translation of (n_2, n_1) to the origin) and respects the relative order on each class. Let us prove that $\mathcal{M}_1(G)$ is an intersection model for G and that it is blocking.

- Let $v_i < v_j$ adjacent. Then $U(1, v_j) \leq i$ and $U(2, v_j) \leq n_2$, so the boxes of v_i and v_j intersect.
- Let $v_i < v_j$ not adjacent. Because of the consistency between order and partition, $U(1, v_j) > i$, thus the boxes of v_i and v_j do not intersect.
- Let $w_i < w_j$ adjacent. Then $U(2, w_j) \leq i$ and $U(1, w_j) \leq n_1$, so the boxes of w_i and w_j intersect.
- Let $w_i < w_j$ not adjacent. Because of the consistency between order and partition, $U(2, w_j) > i$, thus the boxes of w_i and w_j do not intersect.
- Let $v_i < w_j$. Then $U(2, v_i) < j$. If they are adjacent, by the consistency between order and partition, $U(1, w_j) < i$ and the boxes of v_i and w_j intersect. If they are not adjacent, $U(1, w_j) \geq i$ and the boxes of v_i and w_j do not intersect. In this case, $P_Y(w_j) \cap v_i \neq \emptyset$.
- Let $w_i < v_j$. Then $U(1, w_i) < j$. If they are adjacent, by the consistency between order and partition, $U(2, v_j) < i$ and the boxes of v_i and w_j

intersect. If they are not adjacent, $U(2, v_j) \geq i$ and the boxes of v_i and w_j do not intersect. In this case, $P_X(v_j) \cap w_i \neq \emptyset$.

It remains to observe that if the order and the partition are strongly consistent and $x_i < x_j$ are in the same class, then $U(1, x_i) \leq U(1, x_j)$ and $U(2, x_i) \leq U(2, x_j)$, so the model is bi-semi-proper. \square

Theorem 8. *A graph is 2-thin if and only if it has a blocking 2-diagonal model. Moreover, if a graph G is 2-thin and the partition V^1, V^2 of its vertices is consistent with an order $<$, then there exists a blocking 2-diagonal model such that on each of the diagonals lie, respectively, the upper-right corners of the vertices of V^1 and V^2 , in such a way that their order corresponds to $<$ restricted to the respective part. Conversely, if a graph G admits a blocking 2-diagonal model, then there exists an order of the vertices of G that is consistent with the partition given by the diagonals where the upper-right corners lie, and extends their order on the respective diagonals.*

Proof.

\Rightarrow) It follows from Lemma 7.

\Leftarrow) Let us consider a blocking 2-diagonal model of G , and let V^1 and V^2 be the vertices corresponding to boxes whose upper-right corners lie in the lower and upper diagonal, respectively. We will slightly abuse notation and use it indistinctly for a vertex and the box representing it.

Let $\Pi = \{V^1, V^2\}$, $<$ be the order of V^1 and V^2 defined by the X_2 coordinates on each of the sets, and where a vertex of V^1 and a vertex of V^2 are not comparable.

Let us first prove that $<$ is consistent restricted to V^i , $i = 1, 2$. Let $x < y < z$ in V^1 with $xz \in E(G)$ (the definitions are symmetric with respect to both classes). Then $X_2(x) < X_2(y) < X_2(z)$ and since $xz \in E(G)$, it holds $X_1(z) < X_2(x) < X_2(y)$ and $Y_1(z) < Y_2(x) = X_2(x) + d_1 < X_2(y) + d_1 = Y_2(y)$. Therefore, $yz \in E(G)$.

Let $D = D(G, \Pi, <)$. By the blocking property, given two vertices $v_i \in V^i$, $v_{3-i} \in V^{3-i}$, if $v_i v_{3-i} \in A(D)$, then the appropriate prolongation of v_{3-i} intersects v_i . As observed above, an ordering of $V(G)$ is consistent with the partition V^1, V^2 and extends the partial order $<$ if and only if it is a topological ordering of D .

Let us prove now that D is acyclic, thus it admits a topological ordering. Suppose it is not, and let us consider a shortest oriented cycle of D . Moreover, since the subdigraph induced by each class is complete and acyclic, the cycle has at most two vertices of each class, and necessarily an arc from V^1 to V^2 and another from V^2 to V^1 .

Case 1: The cycle consists of two vertices, $v_1 \in V^1$ and $v_2 \in V^2$.

In this case, v_1 and v_2 do not intersect but the horizontal prolongation of v_1 intersects v_2 and the vertical prolongation of v_2 intersects v_1 , which is not possible.

Case 2: The cycle is $v_1w_1v_2$ such that $v_1, w_1 \in V^1$ and $v_2 \in V^2$.

Since $v_1w_1 \in D$, we have $X_2(v_1) < X_2(w_1)$ and therefore $Y_2(v_1) < Y_2(w_1)$. The horizontal prolongation of v_1 intersects v_2 , therefore $Y_1(v_2) < Y_2(v_1) < Y_2(w_1)$, and the vertical prolongation of v_2 intersects w_1 , therefore $X_1(w_1) < X_2(v_2)$, contradicting that v_2 and w_1 do not intersect because they are not adjacent.

Case 3: The cycle is $v_2w_2v_1$ such that $v_1 \in V^1$ and $v_2, w_2 \in V^2$.

Since $v_2w_2 \in D$, we have $X_2(v_2) < X_2(w_2)$. The vertical prolongation of v_2 intersects v_1 , therefore $X_1(v_1) < X_2(v_2) < X_2(w_2)$, and the horizontal prolongation of v_1 intersects w_2 , therefore $Y_1(w_2) < Y_2(v_1)$, contradicting that v_1 and w_2 do not intersect because they are not adjacent.

Case 4: The cycle is $v_1w_1v_2w_2$ such that $v_1, w_1 \in V^1$ and $v_2, w_2 \in V^2$.

Since $v_iw_i \in D$, for $i = 1, 2$, we have $X_2(v_i) < X_2(w_i)$ and therefore $Y_2(v_i) < Y_2(w_i)$.

The vertical prolongation of v_2 intersects w_1 and v_2 does not intersect w_1 , therefore $Y_2(v_1) < Y_2(w_1) < Y_1(v_2)$. The horizontal prolongation of v_1 intersects w_2 and v_1 does not intersect w_2 , therefore $X_2(v_2) < X_2(w_2) < X_1(v_1)$. This contradicts for v_1 and v_2 the fact that the model is blocking. \square

Propositions 9 and 12 show that the blocking property is necessary for Theorem 8, since there are graphs having a 2-diagonal model which are not 2-thin.

Let G be the graph defined in the following way: $V(G) = A \cup B$, where $A = a_1, \dots, a_{36}$, $B = b_1, \dots, b_{36}$, and $A = A_0 \cup A_1 \cup \dots \cup A_5$, $B = B_0 \cup B_1 \cup \dots \cup B_5$, where $A_5 = \{a_{33}, a_{34}, a_{35}, a_{36}\}$, $A_0 = \{a_i : 1 \leq i \leq 32, i \text{ is odd}\}$, and, for $1 \leq k \leq 4$, $A_k = \{a_i : 8(k-1) < i \leq 8k \text{ and } i \text{ is even}\}$; $B_j = \{b_i : a_i \in A_j\}$, for $0 \leq j \leq 5$. The edges joining A and B are such that: for $1 \leq j \leq 4$, A_j is complete to B_j and B_5 , and anticomplete to B_0 and B_i , $1 \leq i \leq 4$, $i \neq j$; A_5 is anticomplete to B_0 and complete to $B \setminus B_0$. Besides, $a_{2k-1}a_{2k} \in E(G)$

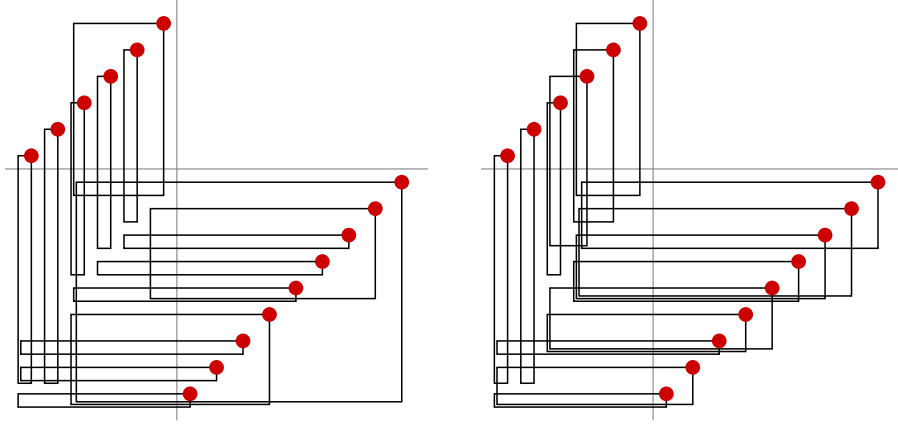

Figure 5: The model \mathcal{M}_1 for the graphs in Figure 1.

and $b_{2k-1}b_{2k} \in E(G)$, for $1 \leq k \leq 16$, and these are the only internal edges of A and B .

Proposition 9. *The graph G has a representation as intersection of boxes having the 2-diagonal property.*

Proof. The representation is as follows: the upper right corner of a_i is $(i, i + 36)$ for $1 \leq i \leq 36$; the lower left corners are, for a_i in A_0 , $(i - 0.5, i + 35.5)$, for a_i in A_1 , $(i - 1.5, 0)$, for a_i in A_2 , $(i - 1.5, 8.5)$, for a_i in A_3 , $(i - 1.5, 16.5)$, for a_i in A_4 , $(i - 1.5, 24.5)$, for a_i in A_5 , $(i - 0.5, 0)$. If the lower left and upper right corners of a_i are (x, y) and (w, z) , respectively, then the lower left and upper right corners of b_i are (y, x) and (z, w) , respectively. It is not hard to check that this is a representation of G . It is drawn in Figure A.15. \square

Lemma 10. *Let H be a complete bipartite graph with bipartition (A, B) . In every 2-thin representation of H , except perhaps for the greatest vertex of A and the greatest vertex of B (according to the order associated with the representation), every vertex of A is in one class and every vertex of B is in the other class.*

Proof. Let $<$ be the order associated with a 2-thin representation of H . Let a_M (resp. b_M) be the greatest vertex of A (resp. B) according to $<$. By

symmetry of the graph (since the sizes of A and B are not specified in the statement), we may assume without loss of generality $a_M > b_M$.

Claim 11. $A \setminus \{a_M\}$ is complete to $B \setminus \{b_M\}$ in $G_<$.

Let $a \in A \setminus \{a_M\}$, $b \in B$ such that $b < a$. Then, $b < a < a_M$, $a_M b \in E(G)$ and $a_M a \notin E(G)$, therefore $ab \in E(G_<)$. Now, let $b \in B \setminus \{b_M\}$, $a \in A$ such that $a < b$. Then, $a < b < b_M$, $b_M a \in E(G)$ and $b_M b \notin E(G)$, thus $ab \in E(G_<)$. Hence, $A \setminus \{a_M\}$ is complete to $B \setminus \{b_M\}$ in $G_<$. \diamond

By the claim above, $A \setminus \{a_M\}$ and $B \setminus \{b_M\}$ are in different sets of the partition, and since there are only two sets in the partition, the statement holds. \square

Proposition 12. *The graph G has thinness 3.*

Proof. Let $V^1 = A \setminus A_0$, $V^2 = B \setminus B_0$, $V^3 = A_0 \cup B_0$ and the order given by $a_1, a_2, b_1, b_2, a_3, a_4, b_3, b_4, \dots, a_{35}, a_{36}, b_{35}, b_{36}$. It is not difficult to see that the order and the partition are consistent.

Now, suppose that G admits a 2-thin representation $(<, V^1, V^2)$. Notice that $(A_j \cup A_5, B_j \cup B_5)$ induce a complete bipartite graph, for $j = 1, \dots, 4$. So, by Lemma 10 and transitivity, except perhaps for a few vertices, the vertices of $A \setminus A_0$ are in one of the sets of the partition, say V^1 , and the vertices of $B \setminus B_0$ are in the other, say V^2 . Let us call A' the vertices of $A \setminus A_0$ that are in V^2 and B' the vertices of $B \setminus B_0$ that are in V^1 . For $j = 1, \dots, 5$, let $A'_j = A_j \setminus A'$ and $B'_j = B_j \setminus B'$.

For $1 \leq j \leq 5$, let a_M^j, a_S^j and b_S^j, b_M^j be the greatest and smallest vertices of A'_j and B'_j , respectively.

Let $\{i, j, k, \ell\} = \{1, 2, 3, 4\}$. Then, for every vertex $a \in A'_j \cup A'_k \cup A'_\ell$, either $a > b_M^i$ or $a < a'$ for every $a' \in A'_i$, and, analogously, for every vertex $b \in B'_j \cup B'_k \cup B'_\ell$, either $b > a_M^i$ or $b < b'$ for every $b' \in B'_i$.

By symmetry of the graph G , we may assume $a_M^1 < a_M^2 < a_M^3 < a_M^4$ and $a_M^4 > \max\{b_M^1, b_M^2, b_M^3, b_M^4\}$. By the observation above, for every $b \in B'_3 \cup B'_2 \cup B'_1$ and $b' \in B'_4$, it holds $b < b'$. In particular, $b_M^4 > b_S^4 > \max\{b_M^3, b_M^2, b_M^1\}$. Suppose $a_M^3 > b_S^4$. Then $a_M^3 > b_S^4 > b_M^3$, $a_M^3 b_M^3 \in E(G)$ and $a_M^3 b_S^4 \notin E(G)$, a contradiction. Then $a_M^3 < b_S^4 < b_M^4$, and hence, for every $a \in A'_3 \cup A'_2 \cup A'_1$ and $a' \in A'_4$, it holds $a < a'$, i.e., $a_S^4 > a_M^3$.

Suppose $b_M^3 > a_S^4$. Then $b_M^3 > a_S^4 > a_M^3$, $a_M^3 b_M^3 \in E(G)$ and $b_M^3 a_S^4 \notin E(G)$, a contradiction. Then $b_M^3 < a_S^4$. Suppose now $b_M^2 > a_M^3$. Then

$b_M^2 > a_M^3 > a_M^2$, $b_M^2 a_M^2 \in E(G)$ and $b_M^2 a_M^3 \notin E(G)$, a contradiction. Then $b_M^2 < a_M^3$, and hence, for every $b \in B'_2 \cup B'_1$ and $b' \in B'_3$, it holds $b < b'$, i.e., $b_S^3 > \max\{b_M^2, b_M^1\}$.

Next, suppose $a_M^2 > b_S^3$. Then $a_M^2 > b_S^3 > b_M^2$, $a_M^2 b_M^2 \in E(G)$ and $a_M^2 b_S^3 \notin E(G)$, a contradiction. Then $a_M^2 < b_S^3 < b_M^3$, and hence, for every $a \in A'_2 \cup A'_1$ and $a' \in A'_3$, it holds $a < a'$, i.e., $a_M^2 < a_S^3$. Suppose now $b_M^2 > a_S^3$. Then $b_M^2 > a_S^3 > a_M^2$, $a_M^2 b_M^2 \in E(G)$ and $b_M^2 a_S^3 \notin E(G)$, a contradiction. Then $b_M^2 < a_S^3$.

Suppose $b_M^1 > a_M^2$. Then $b_M^1 > a_M^2 > a_M^1$, $b_M^1 a_M^1 \in E(G)$ and $b_M^1 a_M^2 \notin E(G)$, a contradiction. Then $b_M^1 < a_M^2$, and hence, for every $b \in B'_1$ and $b' \in B'_2$, it holds $b < b'$, i.e., $b_S^2 > b_M^1$. Suppose $b_M^1 > a_S^2$. Then $b_M^1 > a_S^2 > a_M^1$, $a_M^1 b_M^1 \in E(G)$ and $b_M^1 a_S^2 \notin E(G)$, a contradiction. Then $b_M^1 < a_S^2$.

Finally, suppose $a_M^1 > b_S^2$. Then $a_M^1 > b_S^2 > b_M^1$, $a_M^1 b_M^1 \in E(G)$ and $a_M^1 b_S^2 \notin E(G)$, a contradiction. Then $a_M^1 < b_S^2 < b_M^2$, and hence, for every $a \in A'_1$ and $a' \in A'_2$, it holds $a < a'$, i.e., $a_M^1 < a_S^2$. Suppose now $b_M^1 > a_S^2$. Then $b_M^1 > a_S^2 > a_M^1$, $a_M^1 b_M^1 \in E(G)$ and $b_M^1 a_S^2 \notin E(G)$, a contradiction. Then $b_M^1 < a_S^2$.

So, $A'_1 < A'_2 < A'_3 < A'_4$, $B'_1 < B'_2 < B'_3 < B'_4$, and $\max\{a_M^1, b_M^1\} < \min\{a_S^2, b_S^2\} < \max\{a_M^2, b_M^2\} < \min\{a_S^3, b_S^3\} < \max\{a_M^3, b_M^3\} < \min\{a_S^4, b_S^4\} < b_M^4 < a_M^4$.

The vertices in B'_5 have to be greater than b_M^3 , which is a non-neighbor of a_M^4 and smaller than it. Similarly, the vertices in A'_5 have to be greater than a_M^3 .

Let a_2^2, a_3^2 be the second and third greatest vertices of A'_2 , respectively. Let a_0 be the neighbor of a_2^2 in A_0 .

Suppose first $a_0 \in V^1$. If $a_0 > a_2^2$, then $a_0 < a_M^2$, because $a_0 a_M^2 \notin E(G)$. If $a_0 < a_2^2$, then $a_0 > a_3^2$, because $a_2^2 a_3^2 \notin E(G)$. Let $b^5 \in B'_5$. Then $b^5 > b_M^3 > a_M^2 > a_0 > a_S^2$, but $b^5 a_S^2 \in E(G)$ and $b^5 a^0 \notin E(G)$, a contradiction.

Suppose now $a^0 \in V^2$. If $a^0 > a_2^2$, then $a^0 < a_M^2$, because $a^0 a_M^2 \notin E(G)$. If $a^0 < a_2^2$, then $a^0 > b_M^1$, because $a_2^2 > b_M^1$ and $a_2^2 b_M^1 \notin E(G)$. Let $a^5 \in A'_5$. Then $a^5 > a_M^3 > a_2^2 > a^0 > b_M^1$, but $a^5 b_M^1 \in E(G)$ and $a^5 a^0 \notin E(G)$, a contradiction. \square

For proper 2-thin graphs, we can relax the 2-diagonal property and do not require the blocking property, by requiring the model to be bi-semi proper.

Theorem 13. *Let G be a graph. The following statements are equivalent:*

- (i) G is a proper 2-thin graph.

(ii) G has a bi-semi-proper blocking 2-diagonal model.

(iii) G has a bi-semi-proper weakly 2-diagonal model.

Moreover, if G is proper 2-thin and the partition V^1, V^2 of its vertices is strongly consistent with an order $<$, then there exists a bi-semi-proper blocking 2-diagonal model such that on each of the diagonals lie, respectively, the upper-right corners of the vertices of V^1 and V^2 , in such a way that their order corresponds to $<$ restricted to the respective part. Furthermore, if G admits a bi-semi-proper weakly 2-diagonal model, then there exists an order of the vertices of G that is consistent with the partition given by the diagonals where the upper-right corners lie, and extends their order on the respective diagonals.

Proof. (i) \Rightarrow (ii) It follows from Lemma 7.

(ii) \Rightarrow (iii) This is straightforward.

(iii) \Rightarrow (i) Let us consider a bi-semi-proper weakly 2-diagonal model of G . We will slightly abuse notation and use it indistinctly for a vertex and the box representing it. Let V^i be the set of vertices v such that $Y_2(v) - X_2(v) = d_i$, for $i = 1, 2$. We may assume without loss of generality that $d_1 < d_2$.

Let $\Pi = \{V^1, V^2\}$, $<$ be the order of $V^1 \cup V^2$ defined by the X_2 coordinates on each of the sets, and where a vertex of V^1 and a vertex of V^2 are not comparable.

Let us first prove that $<$ is strongly consistent restricted to V^i , $i = 1, 2$. Let $x < y < z$ in V^1 with $xz \in E(G)$ (the definitions are symmetric with respect to both classes). Then $X_2(x) < X_2(y) < X_2(z)$ and since $xz \in E(G)$, it holds $X_1(z) < X_2(x) < X_2(y)$ and $Y_1(z) < Y_2(x) = X_2(x) + d_1 < X_2(y) + d_1 = Y_2(y)$. Therefore, $yz \in E(G)$. By the bi-semi-proper property, $X_1(y) \leq X_1(z) < X_2(x)$ and $Y_1(y) \leq Y_1(z) < Y_2(x)$, and therefore $xy \in E(G)$.

Let $D = \tilde{D}(G, \Pi, <)$. By Lemma 3, an ordering of $V(G)$ is strongly consistent with the partition V^1, V^2 and extends the partial order $<$ if and only if it is a topological ordering of D , thus let us prove that D is acyclic, Suppose it is not, and consider a shortest oriented cycle of D . Moreover, since the subdigraph induced by each class is complete and acyclic, the cycle has at most two vertices of each class, and necessarily an arc from V^1 to V^2 and another from V^2 to V^1 .

The possible types of arcs joining $v_1 \in V^1$ and $v_2 \in V^2$ are the following:

- Type a if $X_2(v_1) > X_2(v_2)$ and $Y_2(v_1) < Y_2(v_2)$;
- Type b if $X_2(v_1) < X_2(v_2)$ and $Y_2(v_1) < Y_2(v_2)$;
- Type c if $X_2(v_1) > X_2(v_2)$ and $Y_2(v_1) > Y_2(v_2)$;
- Type d if $X_2(v_1) = X_2(v_2)$ and $Y_2(v_1) < Y_2(v_2)$;
- Type e if $X_2(v_1) > X_2(v_2)$ and $Y_2(v_1) = Y_2(v_2)$,

and we use the subindex ij if the orientation of the arc is from V^i to V^j .

The following properties hold because the model is bi-semi-proper.

- Type a_{12} : $Y_1(v_2) > Y_2(v_1)$ and $X_1(v_1) < X_2(v_2)$;
- Type a_{21} : $Y_1(v_2) < Y_2(v_1)$ and $X_1(v_1) > X_2(v_2)$;
- Type b_{12} : $Y_1(v_2) > Y_2(v_1)$ or $X_1(v_2) > X_2(v_1)$;
- Types b_{21} and c_{12} : cannot exist;
- Type c_{21} : $Y_1(v_1) > Y_2(v_2)$ or $X_1(v_1) > X_2(v_2)$;
- Type d_{12} : $Y_1(v_2) > Y_2(v_1)$;
- Types d_{21} and e_{12} : cannot exist;
- Type e_{21} : $X_1(v_1) > X_2(v_2)$.

Let us see the possible cycles.

Case 1: The cycle consists of two vertices, $v_1 \in V^1$ and $v_2 \in V^2$.

It cannot happen, since for every $t \in \{b, c, d, e\}$, one of t_{12} or t_{21} cannot exist, and a_{12} and a_{21} cannot occur simultaneously.

Case 2: The cycle is $v_1 w_1 v_2$ such that $v_1, w_1 \in V^1$ and $v_2 \in V^2$.

Since $v_1 w_1 \in D$, we have $X_2(v_1) < X_2(w_1)$ and therefore $Y_2(v_1) < Y_2(w_1)$. As the model is bi-semi-proper, $X_1(v_1) \leq X_1(w_1)$ and $Y_1(v_1) \leq Y_1(w_1)$.

The arc $w_1 v_2$, as seen before, may be of type a_{12} , thus $Y_1(v_2) > Y_2(w_1)$ and $X_1(w_1) < X_2(v_2)$; or type b_{12} , thus $Y_1(v_2) > Y_2(w_1)$ or $X_1(v_2) > X_2(w_1)$; or type d_{12} , and in that case $Y_1(v_2) > Y_2(w_1)$.

Also, the arc $v_2 v_1$, as seen before, can be type a_{21} , thus $Y_1(v_2) < Y_2(v_1)$ and $X_1(v_1) > X_2(v_2)$; or type c_{21} , thus $Y_1(v_1) > Y_2(v_2)$ or $X_1(v_1) > X_2(v_2)$; or type e_{21} , and in that case $X_1(v_1) > X_2(v_2)$.

The options a_{12} and a_{21} imply $Y_2(w_1) < Y_1(v_2) < Y_2(v_1)$, but we know that $Y_2(v_1) < Y_2(w_1)$.

The options a_{12} and c_{21} imply either $Y_2(v_1) > Y_1(v_1) > Y_2(v_2) > Y_1(v_2) > Y_2(w_1)$, which contradicts $Y_2(v_1) < Y_2(w_1)$, or $X_1(v_1) > X_2(v_2) > X_1(w_1)$, which contradicts $X_1(v_1) \leq X_1(w_1)$.

The options a_{12} and e_{21} imply $X_1(v_1) > X_2(v_2) > X_1(w_1)$, which contradicts $X_1(v_1) \leq X_1(w_1)$.

The options b_{12} and a_{21} are incompatible because they imply either $Y_2(v_1) > Y_1(v_2) > Y_2(w_1)$, that contradicts $Y_2(v_1) < Y_2(w_1)$, or $X_2(v_1) > X_1(v_1) > X_2(v_2) > X_1(w_1)$, that contradicts $X_2(v_1) < X_2(w_1)$.

The options b_{12} and c_{21} are incompatible because $Y_2(v_1) > Y_1(v_1) > Y_2(v_2) > Y_2(w_1)$ contradicts $Y_2(v_1) < Y_2(w_1)$; $X_2(v_1) > X_1(v_1) > X_2(v_2) > X_2(w_1)$ contradicts $X_2(v_1) < X_2(w_1)$; $X_1(v_2) > X_2(w_1)$ and $Y_1(v_1) > Y_2(v_2)$ implies $Y_2(v_2) = X_2(v_2) + d_2 > X_1(v_2) + d_2 > X_2(w_1) + d_2 > X_2(v_1) + d_2 = Y_2(v_1) + d_2 - d_1 > Y_1(v_1) + d_2 - d_1 > Y_2(v_2) + d_2 - d_1 > Y_2(v_2)$, a contradiction. Finally, suppose that $Y_1(v_2) > Y_2(w_1)$ and $X_1(w_1) \geq X_1(v_1) > X_2(v_2)$. The existence of the arc w_1v_2 implies that either there exists $v'_2 \in V^2$ with $X_2(v'_2) < X_2(v_2)$ and $w_1v'_2 \in E(G)$, or there exists $v'_1 \in V^1$ with $X_2(v'_1) > X_2(w_1)$ and $v'_1v_2 \in E(G)$. But $X_2(v'_2) < X_2(v_2) < X_1(w_1)$ contradicts $w_1v'_2 \in E(G)$ and $X_2(v'_1) > X_2(w_1)$ implies $X_1(v'_1) \geq X_1(w_1) > X_2(v_2)$ which contradicts $v'_1v_2 \in E(G)$.

The options b_{12} and e_{21} are incompatible because they imply either $Y_2(v_1) = Y_1(v_2) > Y_2(w_1)$, a contradiction, or $X_1(v_1) > X_2(v_2) > X_1(v_2) > X_2(w_1)$, a contradiction too.

The options d_{12} and a_{21} imply $Y_2(v_1) > Y_1(v_2) > Y_2(w_1)$, a contradiction.

The options d_{12} and c_{21} imply either $Y_2(v_1) > Y_1(v_1) > Y_2(v_2) > Y_2(w_1)$, a contradiction, or $X_2(v_1) > X_1(v_1) > X_2(v_2) = X_2(w_1)$, a contradiction too.

The options d_{12} and e_{21} imply $Y_2(v_1) = Y_2(v_2) > Y_1(v_2) > Y_2(w_1)$, a contradiction.

Case 3: The cycle is $v_2w_2v_1$ such that $v_1 \in V^1$ and $v_2, w_2 \in V^2$.

Since $v_2w_2 \in D$, we have $X_2(v_2) < X_2(w_2)$ and therefore $Y_2(v_2) < Y_2(w_2)$. As the model is bi-semi-proper, $X_1(v_2) \leq X_1(w_2)$ and $Y_1(v_2) \leq Y_1(w_2)$.

The arc v_1v_2 , as seen before, can be type a_{12} , thus $Y_1(v_2) > Y_2(v_1)$ and $X_1(v_1) < X_2(v_2)$; or type b_{12} , thus $Y_1(v_2) > Y_2(v_1)$ or $X_1(v_2) > X_2(v_1)$; or type d_{12} , and in that case $Y_1(v_2) > Y_2(v_1)$.

Also, the arc w_2v_1 , as seen before, can be type a_{21} , thus $Y_1(w_2) < Y_2(v_1)$ and $X_1(v_1) > X_2(w_2)$; or type c_{21} , thus $Y_1(v_1) > Y_2(w_2)$ or $X_1(v_1) > X_2(w_2)$; or type e_{21} , and in that case $X_1(v_1) > X_2(w_2)$.

The options a_{12} and a_{21} imply $Y_1(v_2) > Y_2(v_1) > Y_1(w_2)$, a contradiction.

The options a_{12} and c_{21} imply either $Y_2(v_2) > Y_1(v_2) > Y_2(v_1) > Y_1(v_1) > Y_2(w_2)$, a contradiction, or $X_2(w_2) < X_1(v_1) < X_2(v_2)$, a contradiction.

The options a_{12} and e_{21} imply $X_2(w_2) < X_1(v_1) < X_2(v_2)$, a contradiction.

The options b_{12} and a_{21} imply either $Y_1(v_2) > Y_2(v_1) > Y_1(w_2)$, a contradiction, or $X_2(v_2) > X_1(v_2) > X_2(v_1) > X_1(v_1) > X_2(w_2)$, a contradiction.

The options b_{12} and c_{21} are incompatible because $Y_2(v_2) > Y_1(v_2) > Y_2(v_1) > Y_2(w_2)$ contradicts $Y_2(v_2) < Y_2(w_2)$; $X_1(v_2) > X_2(v_1) > X_2(v_2)$ contradicts $X_1(v_2) < X_2(v_2)$; $X_1(v_2) > X_2(v_1)$ and $Y_1(v_1) > Y_2(w_2)$ implies $Y_2(v_2) = X_2(v_2) + d_2 > X_1(v_2) + d_2 > X_2(v_1) + d_2 = Y_2(v_1) + d_2 - d_1 > Y_1(v_1) + d_2 - d_1 > Y_2(w_2) + d_2 - d_1 > Y_2(w_2)$, a contradiction. Finally, suppose that $Y_1(v_2) > Y_2(v_1)$ and $X_1(v_1) > X_2(w_2)$. The existence of the arc v_1v_2 implies that either there exists $v'_2 \in V^2$ with $X_2(v'_2) < X_2(v_2)$ and $v_1v'_2 \in E(G)$, or there exists $v'_1 \in V^1$ with $X_2(v'_1) > X_2(v_1)$ and $v'_1v_2 \in E(G)$. But $X_2(v'_2) < X_2(v_2) < X_2(w_2) < X_1(v_1)$ contradicts $v_1v'_2 \in E(G)$ and $X_2(v'_1) > X_2(v_1)$ implies $X_1(v'_1) \geq X_1(v_1) > X_2(w_2) > X_2(v_2)$ which contradicts $v'_1v_2 \in E(G)$.

The options b_{12} and e_{21} imply $Y_2(v_2) > Y_1(v_2) > Y_2(v_1) = Y_2(w_2)$, a contradiction.

The options d_{12} and a_{21} imply $Y_1(v_2) > Y_2(v_1) > Y_1(w_2)$, a contradiction.

The options d_{12} and c_{21} imply either $Y_2(v_2) > Y_1(v_2) > Y_2(v_1) > Y_1(v_1) > Y_2(w_2)$, a contradiction, or $X_2(v_2) = X_2(v_1) > X_1(v_1) > X_2(w_2)$, a contradiction.

The options d_{12} and e_{21} imply $Y_2(v_2) > Y_1(v_2) > Y_2(v_1) = Y_2(w_2)$, a contradiction.

Case 4: The cycle is $v_1w_1v_2w_2$ such that $v_1, w_1 \in V^1$ and $v_2, w_2 \in V^2$.

Since $v_iw_i \in D$, for $i = 1, 2$, we have $X_2(v_i) < X_2(w_i)$ therefore $Y_2(v_i) < Y_2(w_i)$. As the model is bi-semi-proper, $X_1(v_i) \leq X_1(w_i)$ and $Y_1(v_i) \leq Y_1(w_i)$.

The arc w_1v_2 , as seen before, can be type a_{12} , thus $Y_1(v_2) > Y_2(w_1)$ and $X_1(w_1) < X_2(v_2)$; or type b_{12} , thus $Y_1(v_2) > Y_2(w_1)$ or $X_1(v_2) > X_2(w_1)$; or type d_{12} , and in that case $Y_1(v_2) > Y_2(w_1)$.

Also, the arc w_2v_1 , as seen before, can be type a_{21} , thus $Y_1(w_2) < Y_2(v_1)$ and $X_1(v_1) > X_2(w_2)$; or type c_{21} , thus $Y_1(v_1) > Y_2(w_2)$ or $X_1(v_1) > X_2(w_2)$; or type e_{21} , and in that case $X_1(v_1) > X_2(w_2)$.

The options a_{12} and a_{21} imply $Y_2(v_1) > Y_1(w_2) \geq Y_1(v_2) > Y_2(w_1)$, a contradiction.

The options a_{12} and c_{21} imply $Y_2(v_2) > Y_1(v_2) > Y_2(w_1) > Y_2(v_1) > Y_1(v_1) > Y_2(w_2)$, a contradiction.

The options a_{12} and e_{21} imply $X_1(w_1) < X_2(v_2) < X_2(w_2) < X_1(v_1)$, a contradiction.

The options b_{12} and a_{21} imply either $Y_2(v_1) > Y_1(w_2) \geq Y_1(v_2) > Y_2(w_1)$, a contradiction, or $X_2(v_2) > X_1(v_2) > X_2(w_1) > X_2(v_1) > X_1(v_1) > X_2(w_2)$, a contradiction.

The options b_{12} and c_{21} are incompatible because $Y_2(v_2) > Y_1(v_2) > Y_2(w_1) > Y_2(v_1) > Y_2(w_2)$ contradicts $Y_2(v_2) < Y_2(w_2)$; $X_2(v_2) > X_1(v_2) > X_2(w_1) > X_2(v_1) > X_2(w_2)$, contradicts $X_2(v_2) < X_2(w_2)$; $X_1(v_2) > X_2(w_1)$ and $Y_1(v_1) > Y_2(w_2)$ implies $Y_2(v_2) = X_2(v_2) + d_2 > X_1(v_2) + d_2 > X_2(w_1) + d_2 > X_2(v_1) + d_2 = Y_2(v_1) + d_2 - d_1 > Y_1(v_1) + d_2 - d_1 > Y_2(w_2) + d_2 - d_1 > Y_2(w_2)$, a contradiction. Finally, suppose that $Y_1(v_2) > Y_2(w_1)$ and $X_1(v_1) > X_2(w_2)$. The existence of the arc w_1v_2 implies that either there exists $v'_2 \in V^2$ with $X_2(v'_2) < X_2(v_2)$ and $w_1v'_2 \in E(G)$, or there exists $v'_1 \in V^1$ with $X_2(v'_1) > X_2(w_1)$ and $v'_1v_2 \in E(G)$. But $X_2(v'_2) < X_2(v_2) < X_2(w_2) < X_1(v_1) \leq X_1(w_1)$ contradicts $w_1v'_2 \in E(G)$, and $X_2(v'_1) > X_2(w_1)$ implies $X_1(v'_1) \geq X_1(w_1) \geq X_1(v_1) > X_2(w_2) > X_2(v_2)$ which contradicts $v'_1v_2 \in E(G)$.

The options b_{12} and e_{21} imply $X_1(v_1) > X_2(w_2) > X_2(v_2) > X_2(w_1)$, a contradiction.

The options d_{12} and a_{21} imply $Y_1(v_2) > Y_2(w_1) > Y_2(v_1) > Y_1(w_2)$, a contradiction.

The options d_{12} and c_{21} imply $Y_2(v_2) > Y_1(v_2) > Y_2(w_1) > Y_2(v_1) > Y_1(v_1) > Y_2(w_2)$, a contradiction.

The options d_{12} and e_{21} imply $Y_2(v_2) > Y_1(v_2) > Y_2(w_1) > Y_2(v_1) = Y_2(w_2)$, a contradiction.

□

The bi-semi-proper requirement is necessary, otherwise we can represent any interval graph (we place the intervals on a diagonal line and make each of them the diagonal of a square box, see Figure 2), and interval graphs may have arbitrarily large proper thinness [5].

The model \mathcal{M}_1 can be transformed into a model where the rectangles lie within the 3rd quadrant of the Cartesian plane, and each of the rectangles has either its top side or its right side on a Cartesian axe. We call such a model *2-grounded*. Since every pair of intersecting rectangles has nonempty intersection within the third quadrant, it is enough to define the model \mathcal{M}_2

as the intersection of \mathcal{M}_1 and the 3rd quadrant of the Cartesian plane (see Figure 8). By adjusting the definitions of blocking and bi-semi-proper for 2-grounded models, we can prove characterizations analogous to those in Theorems 8 and 13 for (proper) 2-thin graphs.

5. Thin graphs as VPG graphs

We will first prove that B_0 -VPG graphs have unbounded thinness, and that not every 4-thin graph is a VPG graph. Then, we will prove that graphs with thinness at most three have bounded bend number as VPG graphs.

Let G be a graph. Let $\Delta(G)$ be the maximum degree of a vertex in G . A subgraph H (not necessarily induced) of G is a *spanning subgraph* if $V(H) = V(G)$. If $X \subseteq V(G)$, denote by $N(X)$ the set of vertices of G having at least one neighbor in X . The *vertex isoperimetric peak* of a graph G , denoted as $b_v(G)$, is defined as $b_v(G) = \max_s \min_{X \subseteq V, |X|=s} |N(X) \cap (V(G) \setminus X)|$, i.e., the maximum over s of the lower bounds for the number of boundary vertices (vertices outside the set with a neighbor in the set) in sets of size s .

Theorem 14. [11] *For every graph G with at least one edge, $\text{thin}(G) \geq b_v(G)/\Delta(G)$.*

The following corollary is also useful.

Corollary 15. *Let G be a graph such that $\Delta(G) \leq d$, and H be a (not necessarily induced) subgraph of G with at least one edge and such that $b_v(H) \geq b$. Then $\text{thin}(G) \geq b/d$.*

Proof. Let G' be the subgraph of G induced by $V(H)$. Then $\Delta(G') \leq \Delta(G)$. Since H is a spanning subgraph of G' , then $b_v(G') \geq b_v(H)$, and since G' is an induced subgraph of G , then $\text{thin}(G') \geq \text{thin}(G)$. So, by Theorem 14, $\text{thin}(G) \geq \text{thin}(G') \geq b_v(G')/\Delta(G') \geq b_v(H)/\Delta(G) \geq b/d$. \square

For a positive integer r , the $(r \times r)$ -grid GR_r is the graph whose vertex set is $\{(i, j) : 1 \leq i, j \leq r\}$ and whose edge set is $\{(i, j)(k, l) : |i - k| + |j - l| = 1, \text{ where } 1 \leq i, j, k, l \leq r\}$.

The thinness of the two dimensional $r \times r$ grid GR_r was lower bounded by $r/4$, by using Theorem 14 and the following lemma.

Lemma 16. [14] *For every $r \geq 2$, $b_v(GR_r) \geq r$.*

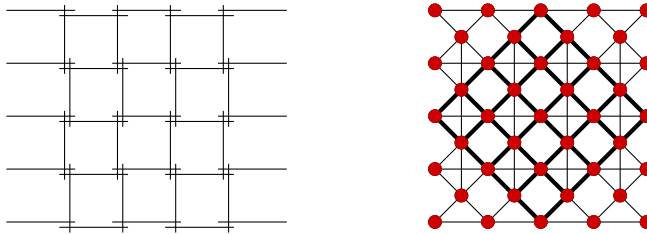

Figure 6: The $r \times r$ grid is a subgraph of this bounded degree B_0 -VPG graph.

We use these results to prove the unboundedness of the thinness of B_0 -VPG graphs.

Proposition 17. *The class of B_0 -VPG graphs has unbounded thinness.*

Proof. Let $r \geq 2$ and let G_r be the intersection graph of the following paths on a grid: $\{(i-0.1, j)-(i+1.1, j)_{0 \leq i, j \leq r}\} \cup \{(i, j-1.1)-(i, j+0.1)_{1 \leq i, j \leq r}\}$. The grid GR_r is a subgraph of G_r , and $\Delta(G_r) = 6$ (see Figure 6). So, by Lemma 16 and Corollary 15, $\text{thin}(G) \geq r/6$. \square

Proposition 18. *Not every 4-thin graph is a VPG graph.*

Proof. The edge subdivision of the complete graph K_5 is 4-thin (see Figure 7 for a representation). Nevertheless, it is not a string graph [40], and string graphs are equivalent to VPG graphs [2]. \square

To prove that graphs with thinness at most three have bounded bend number, we start by defining an intersection model obtained from \mathcal{M}_2 by keeping from each rectangle the path formed by the top and right sides (all the paths have the shape \lrcorner and it can be proved that both intersection models produce the same graph). We can then reflect vertically and horizontally the model in order to obtain the L-model \mathcal{M}_3 (see Figure 8). In this way, we prove that 2-thin graphs are L-graphs, thus B_1 -VPG. When the graph is independent 2-thin it is enough to keep the horizontal part for the paths that are grounded to the y -axis and the vertical part for the paths that are grounded to the x -axis, so independent 2-thin graphs are B_0 -VPG. Again, by adjusting the definitions of blocking, bi-semi-proper to these 2-grounded

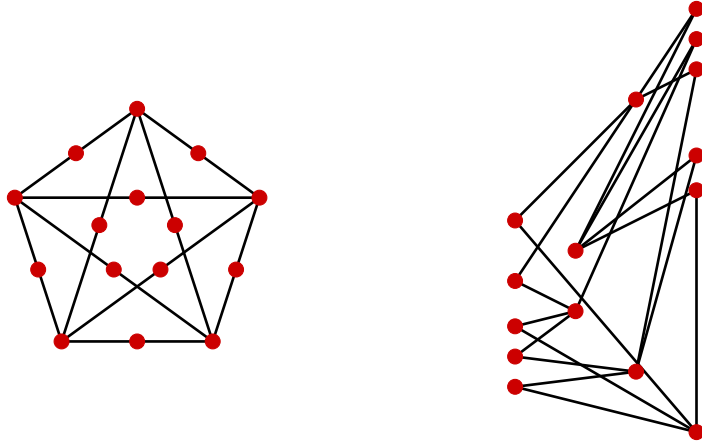

Figure 7: A 4-thin representation of the edge subdivision of K_5 .

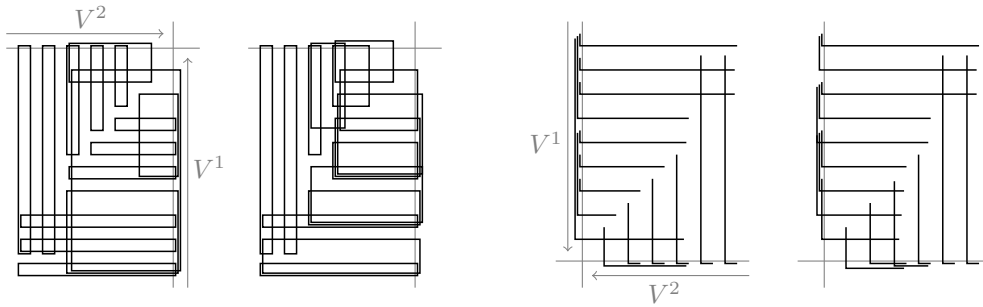

Figure 8: The model \mathcal{M}_2 as intersection of grounded rectangles (left) and the L-model \mathcal{M}_3 (right) for the graphs in Figure 1.

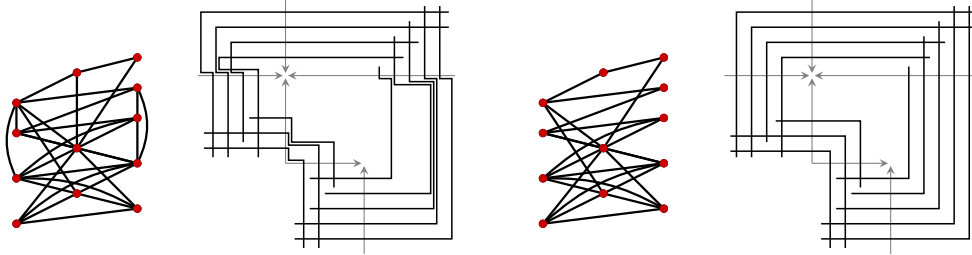

Figure 9: A B_3 -VPG representation of a 3-thin graph (left) and a B_1 -VPG representation of an independent 3-thin graph (right).

models, we can prove characterizations analogous to those in Theorems 8 and 13 for (independent) (proper) 2-thin graphs.

For 3-thin graphs, we use the previous ideas for the intersections within each class and between each pair of classes. A sketch of a B_3 -VPG model for 3-thin graphs and a B_1 -VPG model for independent 3-thin graphs can be found in Figure 9.

The 4-wheel W_4 (obtained from a 4-cycle by adding a universal vertex) is 2-thin and proper independent 3-thin but not B_0 -VPG (in a B_0 -VPG graph, $N[v]$ is interval for every v [2]), so the bound of the bend number in those cases is tight. We conjecture that also the 3 bends bound is tight for 3-thin graphs, but we are missing an example.

The bend number of 2-thin graphs as *edge* intersection graphs of paths on a grid (EPG graphs) is unbounded, since already proper independent 2-thin graphs contain the class of complete bipartite graphs, that has unbounded EPG bend number [3].

Further modifying the model \mathcal{M}_3 by translating vertically the paths that are grounded to the x -axe and horizontally the paths that are grounded to the y -axe in order to have the bends lying in the diagonal $y = -x$, we can obtain a monotone L-model \mathcal{M}_4 for every 2-thin graph. Moreover, we will prove in the next section that 2-thin graphs are exactly the blocking monotone L-graphs. An L-model is *blocking* if for every two non-intersecting L's, either the vertical or the horizontal prolongation of one of them intersects the other.

6. Characterization by forbidden patterns

A *trigraph* T is a 4-tuple $(V(T), E(T), N(T), U(T))$ where $V(T)$ is the vertex set and every unordered pair of vertices belongs to one of the three disjoint sets $E(T)$, $N(T)$, and $U(T)$ called respectively *edges*, *non-edges*, and

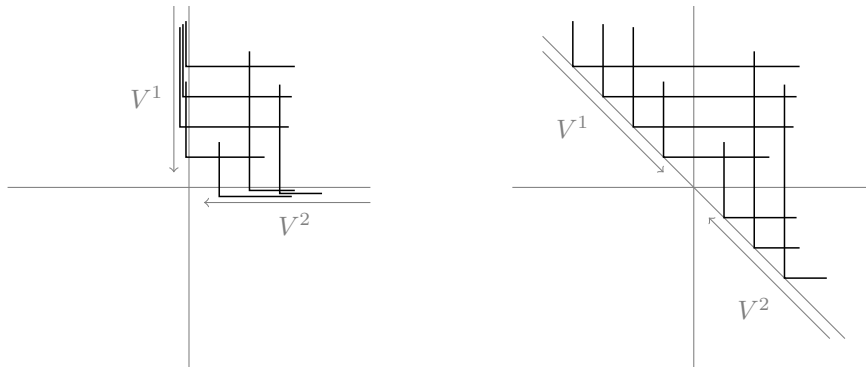

Figure 10: The L-model \mathcal{M}_3 (left) and the monotone L-model \mathcal{M}_4 (right) for the same graph.

undecided edges. A graph $G = (V(G), E(G))$ is a *realization* of a trigraph T if $V(G) = V(T)$ and $E(G) = E(T) \cup U'$, where $U' \subseteq U(T)$. When representing a trigraph, we will draw solid lines for edges, dotted lines for non edges, and nothing for undecided edges. As $(E(T), N(T), U(T))$ is a partition of the unordered pairs, it is enough to give any two of these sets to define the trigraph, and we will often define a trigraph by giving only E and N .

An *ordered graph* is a graph given with a linear ordering of its vertices. We define the same for a trigraph, and call it a *pattern*. We say that an ordered graph is a *realization* of a pattern if they share the same set of vertices and linear ordering and the graph is a realization of the trigraph. When, in an ordered graph, no ordered subgraph is the realization of given pattern, we say that the ordered graph *avoids* the pattern. The *mirror* or *reverse* of a pattern is the same pattern, except the ordering, which is reversed.

Given a family of patterns \mathcal{F} , the class $\text{ORD}(\mathcal{F})$ is the set of graphs that have the following property: there exists an ordering of the nodes, such that none of the ordered subgraphs is a realization of a pattern in \mathcal{F} , i.e., the ordered graph avoids all the patterns in \mathcal{F} .

Many natural graph classes can be described as $\text{ORD}(\mathcal{F})$ for sets \mathcal{F} of small patterns [13, 10, 15, 16, 24]. For instance, for $P_1 = (\{1, 2, 3\}, \{13\}, \{23\})$ and its mirror $P_2 = (\{1, 2, 3\}, \{13\}, \{12\})$, the class of interval graphs is $\text{ORD}(\{P_1\})$ [34] and the class of proper interval graphs is $\text{ORD}(\{P_1, P_2\})$ [36], and for $P_3 = (\{1, 2, 3\}, \{13\}, \{12, 23\})$ and $P_4 = (\{1, 2, 3\}, \{12, 13, 23\}, \emptyset)$, the class of bipartite permutation graphs is $\text{ORD}(\{P_3, P_4\})$ [16]. For $P_6 = (\{1, 2, 3, 4\}, \{13, 24\}, \{23\})$, the class of mono-

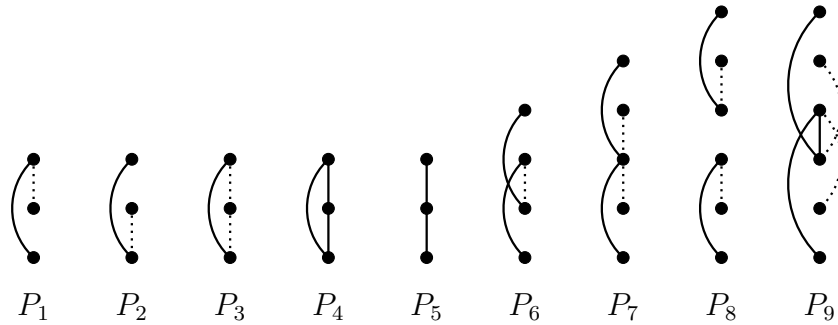

Figure 11: The patterns used in the characterizations of this section. The solid lines denote compulsory edges and the dotted lines are compulsory non-edges in the pattern.

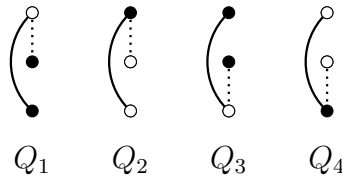

Figure 12: Examples of bicolored patterns.

tone L-graphs is $\text{ORD}(\{P_6\})$ [10]. See Figure 11 for a graphical representation of the aforementioned patterns.

The class of bipartite graphs can be characterized as $\text{ORD}(\{P_5\})$, where $P_5 = (\{1, 2, 3\}, \{12, 23\}, \emptyset)$ [16]. In the literature, there are two ways of defining patterns for subclasses of bipartite graphs. The first one [23] involves a total order of the vertices, that are colored black or white, a set of compulsory edges, and a set of compulsory non-edges. We will call such a structure a *bicolored pattern*, and we will describe it as a 4-tuple containing a set of ordered vertices, the subset of white vertices, the set of edges and the set of non-edges. For instance, the paths in Figure 12 are described as $Q_1 = (\{1, 2, 3\}, \{3\}, \{13\}, \{23\})$, $Q_2 = (\{1, 2, 3\}, \{1, 2\}, \{13\}, \{23\})$, $Q_3 = (\{1, 2, 3\}, \{1\}, \{13\}, \{12\})$, $Q_4 = (\{1, 2, 3\}, \{2, 3\}, \{13\}, \{12\})$.

We say that a bipartite graph H belongs to $\text{BICOLOR}(\mathcal{F})$, for a fixed family of bicolored patterns \mathcal{F} , if H admits a bipartition $V(H) = A \cup B$ and an ordering of $A \cup B$ that avoids the patterns from \mathcal{F} . It was proved in [23] that interval bigraphs are exactly $\text{BICOLOR}(\{Q_1, Q_2\})$.

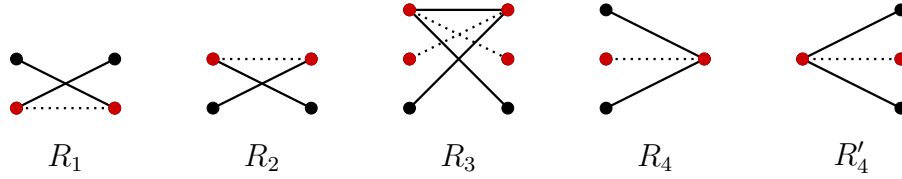

Figure 13: The bipartite patterns in the characterizations of Lemma 19. The solid lines denote compulsory edges and the dotted lines are compulsory non-edges in the pattern. Red vertices form a directed cycle in $\tilde{D}(G, \Pi, <)$ or $D(G, \Pi, <)$, respectively, and black vertices are the witnesses.

The other (slightly different) way [24] is the following. A *bipartite pattern* is a bipartite trigraph whose vertices in each part of the bipartition are linearly ordered. We will denote such pattern as a 4-tuple containing two disjoint sets of ordered vertices, the set of edges and the set of non-edges. For instance, the paths in Figure 13 are described as $R_1 = (\{1, 2\}, \{1', 2'\}, \{12', 21'\}, \{11'\})$, $R_2 = (\{1, 2\}, \{1', 2'\}, \{12', 21'\}, \{22'\})$, $R_3 = (\{1, 2, 3\}, \{1', 2', 3'\}, \{13', 31', 33'\}, \{23', 32'\})$, $R_4 = (\{1, 2, 3\}, \{1'\}, \{11', 31'\}, \{21'\})$, $R'_4 = (\{1\}, \{1', 2', 3'\}, \{11', 13'\}, \{12'\})$.

We say that a bipartite graph H belongs to $\text{BIORD}(\mathcal{F})$, for a fixed family of bipartite patterns \mathcal{F} , if H admits a bipartition $V(H) = A \cup B$ and an ordering of A and of B so that no pattern from \mathcal{F} occurs. Several known bipartite graph classes can be characterized as $\text{BIORD}(\mathcal{F})$. For instance, bipartite convex graphs are $\text{BIORD}(\{R_4\})$, and proper interval bigraphs are $\text{BIORD}(\{R_1, R_2\})$ [24].

We will state now a lemma that is necessary to prove the forbidden pattern characterizations of 2-thin graphs and (proper) independent 2-thin graphs.

Lemma 19. *Let G be a graph, $\{V^1, V^2\}$ a partition of $V(G)$, and $<$ a partial order of $V(G)$ that is total when restricted to each of V^1, V^2 . Then $D(G, \{V^1, V^2\}, <)$ is acyclic if and only if $G[V^1, V^2]$ ordered according to $<$ avoids the bipartite patterns R_2 and R_3 , and $\tilde{D}(G, \{V^1, V^2\}, <)$ is acyclic if and only if $G[V^1, V^2]$ ordered according to $<$ avoids the bipartite patterns R_1, R_2, R_4 and R'_4 . Furthermore, if $G[V^1, V^2]$ has no isolated vertices, then $\tilde{D}(G, \{V^1, V^2\}, <)$ is acyclic if and only if $G[V^1, V^2]$ ordered according to $<$ avoids the bipartite patterns R_1 and R_2 .*

Proof. If the pattern R_2 occurs, then the vertices $2, 2'$ form a directed cycle both in $D(G, \{V^1, V^2\}, <)$ and $\tilde{D}(G, \{V^1, V^2\}, <)$. If the pattern R_1

occurs, then the vertices $1, 1'$ form a directed cycle in $\tilde{D}(G, \{V^1, V^2\}, <)$. If the pattern R_3 occurs, then the vertices $2, 3, 2', 3'$ form a directed cycle in $D(G, \{V^1, V^2\}, <)$. If the pattern R_4 (resp. R'_4) occurs, then the vertices $2, 1'$ (resp. $1, 2'$) form a directed cycle in $\tilde{D}(G, \{V^1, V^2\}, <)$.

In order to prove the converse, suppose that there is a directed cycle in $D(G, \{V^1, V^2\}, <)$. As in the proof of Theorem 8, we can reduce up to symmetry (since the definition of the digraph and the patterns are symmetric) to the following three cases.

Case 1: The cycle consists of two vertices, $v_1 \in V^1$ and $v_2 \in V^2$.

In this case, v_1 and v_2 are not adjacent and, by definition of the digraph, there exist $v'_1 \in V^1, v'_2 \in V^2$ such that $v'_1 < v_1, v'_2 < v_2$, and $v'_1 v_2, v_1 v'_2 \in E(G)$. So, the pattern R_2 occurs in $G[V^1, V^2]$ ordered according to $<$.

Case 2: The cycle is $v_1 w_1 v_2$ such that $v_1, w_1 \in V^1$ and $v_2 \in V^2$.

By definition of the digraph, we have $v_1 < w_1, v_1 v_2, w_1 v_2 \notin E(G)$, there exists in V^2 a vertex $v'_2 < v_2$ such that $w_1 v'_2 \in E(G)$, and there exists in V^1 a vertex $v'_1 < v_1$ such that $v'_1 v_2 \in E(G)$. So, $\{v'_1, w_1, v'_2, v_2\}$ form the pattern R_2 in $G[V^1, V^2]$ ordered according to $<$.

Case 3: The cycle is $v_1 w_1 v_2 w_2$ such that $v_1, w_1 \in V^1$ and $v_2, w_2 \in V^2$.

By definition of the digraph, we have $v_1 < w_1, v_2 < w_2, w_1 v_2, v_1 w_2 \notin E(G)$, there exists in V^2 a vertex $v'_2 < v_2$ such that $w_1 v'_2 \in E(G)$, and there exists in V^1 a vertex $v'_1 < v_1$ such that $v'_1 w_2 \in E(G)$. If $w_1 w_2 \notin E(G)$, then $\{v'_1, w_1, v'_2, w_2\}$ form the pattern R_2 in $G[V^1, V^2]$ ordered according to $<$. If, otherwise, $w_1 w_2 \in E(G)$, then $\{v'_1, v_1, w_1, v'_2, v_2, w_2\}$ form the pattern R_3 in $G[V^1, V^2]$ ordered according to $<$.

Suppose now that there is a directed cycle in $\tilde{D}(G, \{V^1, V^2\}, <)$. As in the proof of Theorem 13, we can reduce up to symmetry (since the definition of the digraph and the patterns are symmetric) to the following three cases.

Case 1: The cycle consists of two vertices, $v_1 \in V^1$ and $v_2 \in V^2$.

In this case, by definition of the digraph, v_1 and v_2 are not adjacent and, on the one hand, either there exists in V^2 a vertex $v'_2 < v_2$ with $v_1 v'_2 \in E(G)$ or there exists in V^1 a vertex $v''_1 > v_1$ with $v''_1 v_2 \in E(G)$ and, on the other hand, either there exists in V^1 a vertex $v'_1 < v_1$ with $v'_1 v_2 \in E(G)$ or there exists in V^2 a vertex $v''_2 > v_2$ with $v_1 v''_2 \in E(G)$.

If the existent vertices are v'_1 and v'_2 , then $\{v'_1, v_1, v'_2, v_2\}$ form the pattern R_2 in $G[V^1, V^2]$ ordered according to $<$. If this is the case for v''_1 and v''_2 , then the pattern R_1 is formed by $\{v_1, v''_1, v_2, v''_2\}$. If the existent vertices are v'_1 and v''_1 , then $\{v'_1, v_1, v''_1, v_2\}$ form the pattern R_4 .

Case 2: The cycle is $v_1 w_1 v_2$ such that $v_1, w_1 \in V^1$ and $v_2 \in V^2$.

By definition of the digraph, we have $v_1 < w_1$, v_1v_2 , $w_1v_2 \notin E(G)$, and, on the one hand, either there exists in V^2 a vertex $v'_2 < v_2$ with $w_1v'_2 \in E(G)$ or there exists in V^1 a vertex $w''_1 > w_1$ with $w''_1v_2 \in E(G)$ and, on the other hand, either there exists in V^1 a vertex $v'_1 < v_1$ with $v'_1v_2 \in E(G)$ or there exists in V^2 a vertex $v''_2 > v_2$ with $v_1v''_2 \in E(G)$.

If the existent vertices are v'_1 and v'_2 , then $\{v'_1, w_1, v'_2, v_2\}$ form the pattern R_2 in $G[V^1, V^2]$ ordered according to $<$. If this is the case for w''_1 and v''_2 , then the pattern R_1 is formed by $\{v_1, w''_1, v_2, v''_2\}$. In the case of v'_2 and v''_2 , if at least one of $v_1v'_2, w_1v''_2$ is not an edge, then either R_1 or R_2 is formed by $\{v_1, w_1, v'_2, v''_2\}$. If $v_1v'_2$ and $w_1v''_2$ are edges, then $\{v_1, v'_2, v_2, v''_2\}$ form R'_4 . In the case of v'_1 and w''_1 , the vertices $\{v'_1, v_1, w''_1, v_2\}$ form R_4 .

Case 3: The cycle is $v_1w_1v_2w_2$ such that $v_1, w_1 \in V^1$ and $v_2, w_2 \in V^2$.

By definition of the digraph, we have $v_1 < w_1$, $v_2 < w_2$, w_1v_2 , $v_1w_2 \notin E(G)$, and, on the one hand, either there exists in V^2 a vertex $v'_2 < v_2$ with $w_1v'_2 \in E(G)$ or there exists in V^1 a vertex $w''_1 > w_1$ with $w''_1v_2 \in E(G)$ and, on the other hand, either there exists in V^1 a vertex $v'_1 < v_1$ with $v'_1w_2 \in E(G)$ or there exists in V^2 a vertex $w''_2 > w_2$ with $v_1w''_2 \in E(G)$.

Suppose the existent vertices are v'_1 and v'_2 . If $w_1w_2 \notin E(G)$, then R_2 is formed by $\{v'_1, w_1, v'_2, w_2\}$, otherwise, R_4 is formed by $\{v'_1, v_1, w_1, w_2\}$. Similarly, suppose that the existent vertices are w''_1 and w''_2 . If $v_1v_2 \notin E(G)$, then R_1 is formed by $\{v_1, w''_1, v_2, w''_2\}$, otherwise, R_4 is formed by $\{v_1, w_1, w''_1, v_2\}$. In the case of v'_2 and w''_2 , if $w_1w''_2 \notin E(G)$, then R_2 is formed by $\{v_1, w_1, v'_2, w''_2\}$, otherwise, R'_4 is formed by $\{w_1, v'_2, v_2, w''_2\}$. The last case is symmetric.

To conclude, notice that, in a bipartite graph with no isolated vertices, the patterns R_4 or R'_4 imply either R_1 or R_2 . Indeed, in the case of $R_4 = (\{v_1, v_2, v_3, v'_1\}, \{v_1v'_1, v_3v'_1\}, \{v_2v'_1\})$, since v_2 is not an isolated vertex, there is a vertex v' with $v_2v' \in E(G)$, and either R_1 or R_2 occurs, when $v' > v'_1$ or $v' < v'_1$, respectively. The case of R'_4 is symmetric. \square

While a characterization of k -thin and proper k -thin graphs by forbidden induced subgraphs is open for $k \geq 2$, they may be defined by means of forbidden patterns, due to Corollary 1, i.e., we forbid the patterns for an order $<$ that produce a clique of size $k + 1$ in $G_<$ (resp. $\tilde{G}_<$). This approach leads to a high number of forbidden patterns (see Figures A.16 and A.17 for the patterns corresponding to 2-thin and proper 2-thin graphs, respectively).

However, the model of 2-thin graphs as monotone L-graphs leads to the following forbidden pattern characterization for the class, with only four

symmetric patterns.

Recall that an L-model is *blocking* if for every two non-intersecting L's, either the vertical or the horizontal prolongation of one of them intersects the other.

Theorem 20. *Let us define the patterns $P_6 = (\{1, 2, 3, 4\}, \{13, 24\}, \{23\})$, $P_7 = (\{1, 2, 3, 4, 5\}, \{13, 35\}, \{23, 34\})$, $P_8 = (\{1, 2, 3, 4, 5, 6\}, \{13, 46\}, \{23, 45\})$, and $P_9 = (\{1, 2, 3, 4, 5, 6\}, \{14, 34, 36\}, \{24, 35\})$ (see Figure 11). Let G be a graph. The following statements are equivalent:*

- (i) G is a 2-thin graph.
- (ii) G has a blocking monotone L-model.
- (iii) $G \in \text{ORD}(\{P_6, P_7, P_8, P_9\})$.

Proof. (i) \Rightarrow (ii) Let G be a 2-thin graph with partition V^1, V^2 and a consistent ordering $<$. Consider the model $\mathcal{M}_4(G)$. It is easy to see that it is an intersection model for G , given that $\mathcal{M}_1(G)$ is. We will see that it is blocking. Let us consider two non-adjacent vertices v_1, v_2 . If $v_1 \in V^1$ and $v_2 \in V^2$, then either the horizontal prolongation of v_1 intersects v_2 or the vertical prolongation of v_2 intersects v_1 , because the model $\mathcal{M}_1(G)$ is blocking (Lemma 7). If $v_1 < v_2$ and both belong to V^1 (resp. V^2), then the vertical (resp. horizontal) prolongation of v_2 intersects v_1 (see Figure 10).

(ii) \Rightarrow (iii) Let G be a graph admitting a blocking monotone L-model and consider the ordering of the vertices according to the Lcorners along the diagonal. It is known that the pattern P_6 is not possible in an L-model for that vertex ordering [10]. Let us see that the other patterns are not possible when the model is blocking. Figure 14 shows schematic representations of patterns P_7, P_8 , and P_9 . The light parts are optional, according to the undecided edges of the trigraph. In each of the cases, vertices labeled as x and y violate the blocking property.

(iii) \Rightarrow (i) Let $G \in \text{ORD}(\{P_6, P_7, P_8, P_9\})$ and let v_1, \dots, v_n be an ordering of the vertices avoiding the patterns P_6, P_7, P_8 , and P_9 . If the order avoids P_1 , then G is an interval graph, in particular 2-thin. Otherwise, let n_1 be such that v_1, \dots, v_{n_1} avoids P_1 but there exist $1 \leq i < j < n_1 + 1$ such that $v_i v_{n_1+1} \in E(G)$ and $v_j v_{n_1+1} \notin E(G)$. Let $V^1 = \{v_1, \dots, v_{n_1}\}$ and

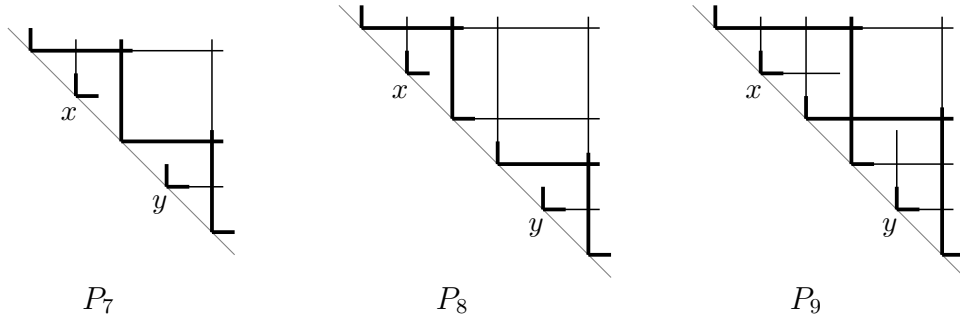

Figure 14: Schematic L-models of patterns P_7 , P_8 , and P_9 . The light parts are optional, according to the undecided edges of the trigraph. In each of the cases, vertices labeled as x and y violate the blocking property.

$V^2 = \{v_{n_1+1}, \dots, v_n\}$. Consider the ordering $<$ such that V^1 is ordered increasingly according to the vertex indices and V^2 is ordered decreasingly according to the vertex indices. The graph $G[V^2]$ ordered by $<$ avoids P_1 , since otherwise either P_7 or P_8 occurs in the original ordering. It remains to prove that $D(G, \{V^1, V^2\}, <)$ is acyclic. By Lemma 19, this is so if and only if $G[V^1, V^2]$ with the sets ordered according to $<$ avoids the bipartite patterns R_2 and R_3 . But this holds because the original ordering avoids P_6 and P_9 , respectively. \square

Notice that the blocking property is crucial, since every tree is a monotone L-graphs [41] and trees may have arbitrarily large thinness [5].

By combining results from [16, 22, 24], we have the following two characterization theorems. They show, among other equivalences, that (proper) independent 2-thin graphs are equivalent to (proper) interval bigraphs, respectively.

Theorem 21. *Let G be a graph. The following statements are equivalent:*

- (i) G is an independent 2-thin graph.
- (ii) G is an interval bigraph.
- (iii) G is bipartite and $G \in \text{BICOLORD}(\{Q_1, Q_2\})$.
- (iv) G is bipartite and $G \in \text{BIORD}(\{R_2, R_3\})$.
- (v) $G \in \text{ORD}(\{P_5, P_6, P_9\})$.

Proof. (i) \Leftrightarrow (iii) It is straightforward from the definition of independent thinness.

(ii) \Leftrightarrow (iii) It is proved in [22].

(i) \Rightarrow (iv) Let $\{V^1, V^2\}$ be a partition of $V(G)$ into independent sets and $<$ an ordering of $V(G)$ that is consistent with the partition $\{V^1, V^2\}$. By Lemma 2, $D(G, \{V^1, V^2\}, <)$ is acyclic. By Lemma 19, $<$ avoids R_2 and R_3 , so $G \in \text{BIORD}(\{R_2, R_3\})$.

(iv) \Rightarrow (i) Let $\{V^1, V^2\}$ be a bipartition of $V(G)$ and let $<$ be an order of V^1 and of V^2 that avoids R_2 and R_3 . By Lemma 19, $D(G, \{V^1, V^2\}, <)$ is acyclic. By Lemma 2, there is an ordering of $V(G)$ that is consistent with the partition $\{V^1, V^2\}$, so G is independent 2-thin.

(iv) \Rightarrow (v) Let $\{V^1, V^2\}$ be a bipartition of G and $<$ an ordering of V^1 and of V^2 that avoids R_2 and R_3 . Consider the order of $V(G)$ such that every vertex of V^1 precedes every vertex of V^2 , V^1 is ordered according to $<$ and V^2 is ordered according to the reverse of $<$. This order avoids P_5 because every edge has an endpoint in V^1 and the other in V^2 . It also avoids P_6 and P_9 , because otherwise, by the way of defining the ordering of $V(G)$ and by the edges in the patterns, the first two (resp. three) vertices of P_6 (resp. P_9) belong to V^1 , and the last two (resp. three) to V^2 . Thus, with the order $<$ of V^1 and of V^2 the the pattern R_2 (resp. R_3) occurs, which is a contradiction.

(v) \Rightarrow (i) Since a graph is independent 2-thin if and only if each of its connected components is (see, for example, [8]), we may assume G is connected and non-trivial. Let $\{V^1, V^2\}$ be the bipartition of $V(G)$ and let $<$ be an order of $V^1 \cup V^2$ that avoids P_5 , P_6 , and P_9 . Since the graph is connected and the order avoids P_5 , either every vertex of V^1 precedes every vertex of V^2 , or every vertex of V^2 precedes every vertex of V^1 . We may assume the first case. Consider V^1 ordered according to $<$ and V^2 ordered according to the reverse of $<$. We will call this partial order $<'$. Since $<$ avoids P_6 and P_9 , G ordered according to $<'$ avoids R_2 and R_3 . By Lemma 19, $D(G, \{V^1, V^2\}, <')$ is acyclic. By Lemma 2, there is an ordering of $V(G)$ that is consistent with the partition $\{V^1, V^2\}$, so G is independent 2-thin. \square

In particular, independent 2-thin graphs can be recognized in polynomial time [33]. Even cycles of length at least 6 are bipartite and 2-thin but not

interval bigraphs [33], so not independent 2-thin graphs.

Theorem 22. *Let G be a graph. The following statements are equivalent:*

- (i) G is a proper independent 2-thin graph.
- (ii) G is a proper interval bigraph.
- (iii) G is a bipartite permutation graph.
- (iv) G is bipartite and $G \in \text{BICOLORD}(\{Q_1, Q_2, Q_3, Q_4\})$.
- (v) G is bipartite and $G \in \text{BIORD}(\{R_1, R_2\})$.
- (vi) $G \in \text{ORD}(\{P_3, P_4\})$.

Proof. (i) \Leftrightarrow (iv)) It is straightforward from the definition of proper independent thinness.

(ii) \Leftrightarrow (iii)) It is proved in [22].

(ii) \Leftrightarrow (v)) It is proved in [24].

(iii) \Leftrightarrow (vi)) It is proved in [16].

(i) \Rightarrow (v)) Let $\{V^1, V^2\}$ be a partition of $V(G)$ into independent sets and $<$ an ordering of $V(G)$ that is strongly consistent with the partition $\{V^1, V^2\}$. By Lemma 3, $\tilde{D}(G, \{V^1, V^2\}, <)$ is acyclic. By Lemma 19, $<$ avoids R_1 and R_2 , so $G \in \text{BIORD}(\{R_1, R_2\})$.

(v) \Rightarrow (i)) Since a graph is proper independent 2-thin if and only if each of its connected components is (see, for example, [8]), we may assume G is connected and non-trivial. Let $\{V^1, V^2\}$ be the bipartition of $V(G)$ and let $<$ be an order of V^1 and of V^2 that avoids R_1 and R_2 . By Lemma 19, $\tilde{D}(G, \{V^1, V^2\}, <)$ is acyclic. By Lemma 3, there is an ordering of $V(G)$ that is strongly consistent with the partition $\{V^1, V^2\}$, so G is proper independent 2-thin. \square

In particular, proper independent 2-thin graphs can be recognized in linear time [23, 42]. The bipartite claw (the subdivision of $K_{1,3}$) is bipartite and

proper 2-thin but not bipartite permutation [29], so not proper independent 2-thin.

The results above show that, for a (proper) k -thin graph with a partition V^1, \dots, V^k consistent with some ordering, not only $G[V^i]$ is a (proper) interval graph for every $1 \leq i \leq k$, but also $G[V^i, V^j]$ is a (proper) interval bigraph for every $1 \leq i, j \leq k$.

References

- [1] A. R. Ahmed, F. De Luca, S. Devkota, A. Efrat, M. I. Hossain, S. Kobourov, J. Li, S. A. Salma, and E. Welch. L-graphs and monotone L-graphs. arXiv:1703.01544v1 [cs.CG], March 2017.
- [2] A. Asinowski, E. Cohen, M. Golumbic, V. Limouzy, M. Lipshteyn, and M. Stern. Vertex intersection graphs of paths on a grid. *Journal of Graph Algorithms and Applications*, 16(2):129–150, 2012.
- [3] A. Asinowski and A. Suk. Edge intersection graphs of systems of paths on a grid with a bounded number of bends. *Discrete Applied Mathematics*, 157:3174–3180, 2009.
- [4] É. Bonnet, E. J. Kim, S. Thomassé, and R. Watrigant. Twin-width I: tractable FO model checking. arXiv: 2004.14789 [cs.DS], 2020.
- [5] F. Bonomo and D. De Estrada. On the thinness and proper thinness of a graph. *Discrete Applied Mathematics*, 261:78–92, 2019.
- [6] F. Bonomo, S. Mattia, and G. Oriolo. Bounded coloring of co-comparability graphs and the pickup and delivery tour combination problem. *Theoretical Computer Science*, 412(45):6261–6268, 2011.
- [7] F. Bonomo-Braberman, N. Brettell, A. Munaro, and D. Paulusma. Solving problems on generalized convex graphs via mim-width. Manuscript.
- [8] F. Bonomo-Braberman, C. Gonzalez, F. S. Oliveira, M. S. Sampaio, and J. Szwarcfiter. Thinness of product graphs. arXiv: 2006.16887.
- [9] F. Bonomo-Braberman, F. S. Oliveira, M. S. Sampaio, and J. Szwarcfiter. Precedence thinness in graphs. arXiv: 2006.16991.

- [10] D. Catanzaro, S. Chaplick, S. Felsner, B. V. Halldórsson, M. M. Halldórsson, T. Hixon, and J. Stacho. Max point-tolerance graphs. *Discrete Applied Mathematics*, 216:84–97, 2017.
- [11] S. Chandran, C. Mannino, and G. Oriolo. The independent set problem and the thinness of a graph. Manuscript, 2007.
- [12] P. Chinn, J. Chvátalová, A. Dewdney, and N. Gibbs. The bandwidth problem for graphs and matrices – a survey. *Journal of Graph Theory*, 6:223–254, 1982.
- [13] V. Chvátal. Perfectly ordered graphs. *Annals of Discrete Mathematics*, 21:63–65, 1984.
- [14] J. Chvátalová. Optimal labelling of a product of two paths. *Discrete Mathematics*, 11(3):249–253, 1975.
- [15] P. Damaschke. Forbidden ordered subgraphs. In R. Bodendiek and R. Henn, editors, *Topics in Combinatorics and Graph Theory*, pages 219–229. Physica-Verlag HD, 1990.
- [16] L. Feuilloley and M. Habib. Graph classes and forbidden patterns on three vertices. 1812.05913v2 [cs.DS], July 2019.
- [17] R. Fowler, M. Paterson, and S. Tanimoto. Optimal packing and covering in the plane are NP-complete. *Information Processing Letters*, 12(3):139–137, 1981.
- [18] F. Gavril. Algorithms on circular-arc graphs. *Networks*, 4:357–369, 1974.
- [19] M. Golumbic. Comparability graphs and a new matroid. *Journal of Combinatorial Theory. Series B*, 22:68–90, 1977.
- [20] M. Golumbic, M. Lipshteyn, and M. Stern. Edge intersection graphs of single bend paths on a grid. *Networks*, 54:130–138, 2009.
- [21] G. Hajós. Über eine Art von Graphen. *Internationale Mathematische Nachrichten*, 11:Problem 65, 1957.
- [22] P. Hell and J. Huang. Interval bigraphs and circular arc graphs. *Journal of Graph Theory*, 46(4):313–327, 2004.

- [23] P. Hell and J. Huang. Certifying LexBFS recognition algorithms for proper interval graphs and proper interval bigraphs. *SIAM Journal on Discrete Mathematics*, 18(3):554–570, 2006.
- [24] P. Hell, B. Mohar, and A. Rafiey. Ordering without forbidden patterns. In A. Schulz and D. Wagner, editors, *Proceedings of the European Symposium on Algorithms - ESA 2014*, volume 8737 of *Lecture Notes in Computer Science*, pages 554–565, 2014.
- [25] H. Imai and T. Asano. Finding the connected component and a maximum clique of an intersection graph of rectangles in the plane. *Journal of Algorithms*, 4:310–323, 1983.
- [26] V. Jelínek and M. Töpfer. On grounded L-graphs and their relatives. *The Electronic Journal of Combinatorics*, 26(3):#P3.17, 2019.
- [27] H. Kaplan and R. Shamir. Pathwidth, bandwidth, and completion problems to proper interval graphs with small cliques. *SIAM Journal on Computing*, 25(3):540–561, 1996.
- [28] D. Knuth. *The Art of Computer Programming*, volume 1. Addison-Wesley, Reading, MA, 1968.
- [29] E. Koehler. *Graphs without asteroidal triples*. PhD thesis, TU Berlin, 1999.
- [30] C. Mannino, G. Oriolo, F. Ricci, and S. Chandran. The stable set problem and the thinness of a graph. *Operations Research Letters*, 35:1–9, 2007.
- [31] H. Meyniel. A new property of critical imperfect graphs and some consequences. *European Journal of Combinatorics*, 8:313–316, 1987.
- [32] R. Möhring. Graph problems related to gate matrix layout and PLA folding. In G. Tinhofer, E. M. E., H. Noltemeier, and M. Syslo, editors, *Computational Graph Theory*, volume 7 of *Computing Supplementum*, pages 17–51. Springer, Vienna, 1990.
- [33] H. Müller. Recognizing interval digraphs and interval bigraphs in polynomial time. *Discrete Applied Mathematics*, 78(1):189–205, 1997.

- [34] S. Olariu. An optimal greedy heuristic to color interval graphs. *Information Processing Letters*, 37:21–25, 1991.
- [35] F. S. Oliveira, M. S. S. Jr., and J. L. Szwarcfiter. Sobre finura própria de grafos. *III ETC – Encontro de Teoria da Computação*, pages 29–32, 2018.
- [36] F. Roberts. Indifference graphs. In F. Harary, editor, *Proof Techniques in Graph Theory*, pages 139–146. Academic Press, 1969.
- [37] F. Roberts. On the boxicity and cubicity of a graph. In W. Tutte, editor, *Recent Progress in Combinatorics*, pages 301–310. Academic Press, 1969.
- [38] N. Robertson and P. Seymour. Graph minors. I. Excluding a forest. *Journal of Combinatorial Theory. Series B*, 35(1):39–61, 1983.
- [39] N. Robertson and P. Seymour. Graph minors. III. Planar tree-width. *Journal of Combinatorial Theory. Series B*, 36(1):49–64, 1984.
- [40] F. Sinden. Topology of thin film RC-circuits. *Bell System Technical Journal*, 45(9):1639–1662, 1966.
- [41] M. Soto and C. Thraves Caro. p-box: a new graph model. *Discrete Mathematics & Theoretical Computer Science*, 17(1):169–186, 2015.
- [42] J. Spinrad and A. B. and L.K. Stewart. Bipartite permutation graphs. *Discrete Applied Mathematics*, 18:279–292, 1987.

Appendix A. Omitted figures

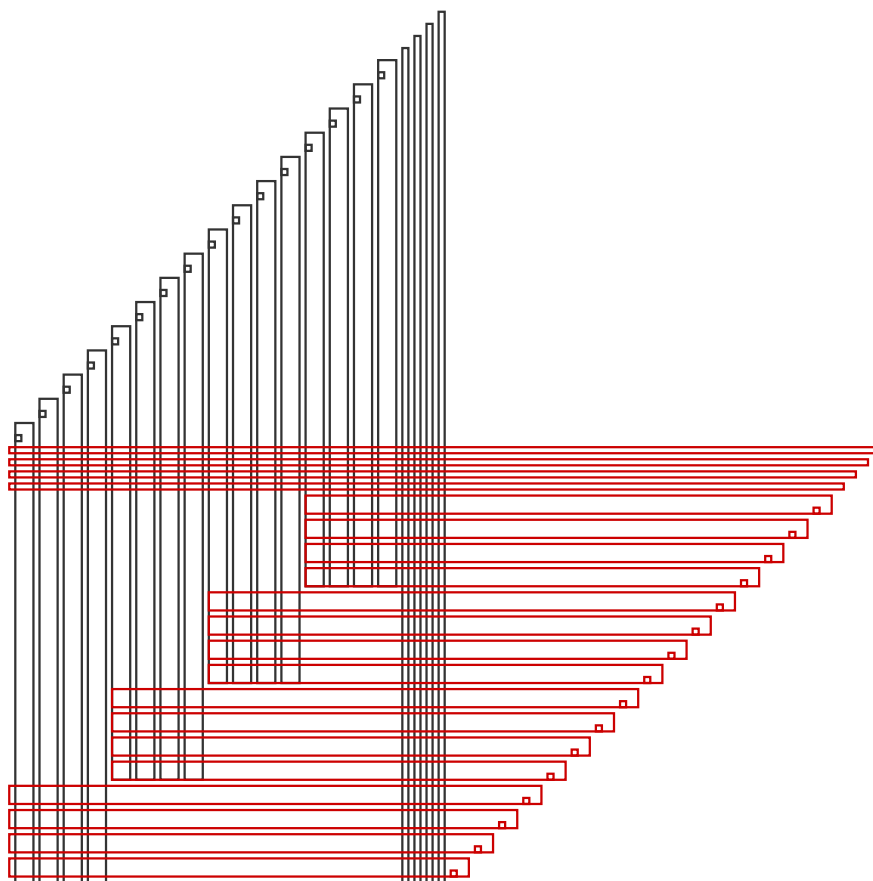

Figure A.15: The graph G used to prove that the blocking property is necessary for the characterization of 2-thin graphs as boxicity 2 graphs (Proposition 9).

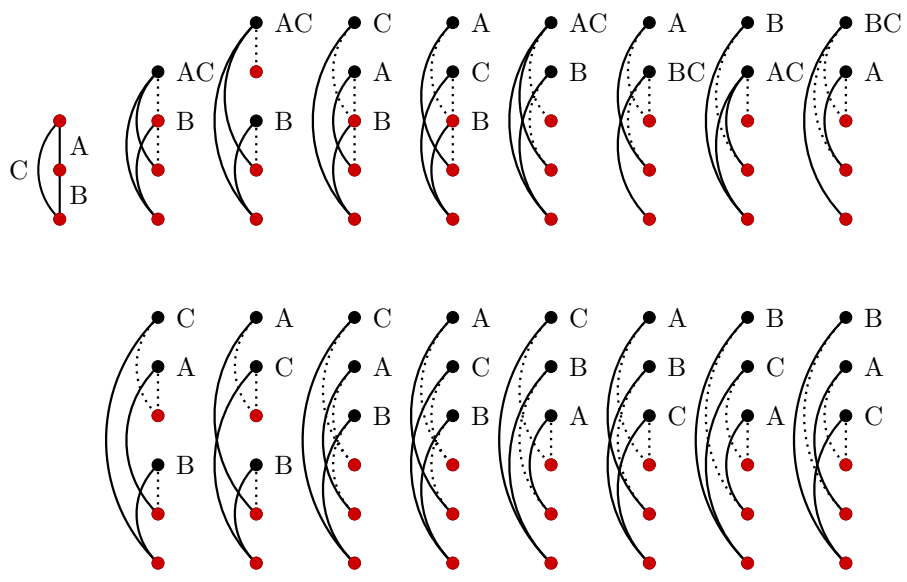

Figure A.16: Reference triangle (left) and forbidden patterns for thinness at most 2. Red vertices form a clique in $G_{<}$, and labeled vertices are the witnesses for the respective edges of the clique, according to the labeling of the first triangle.

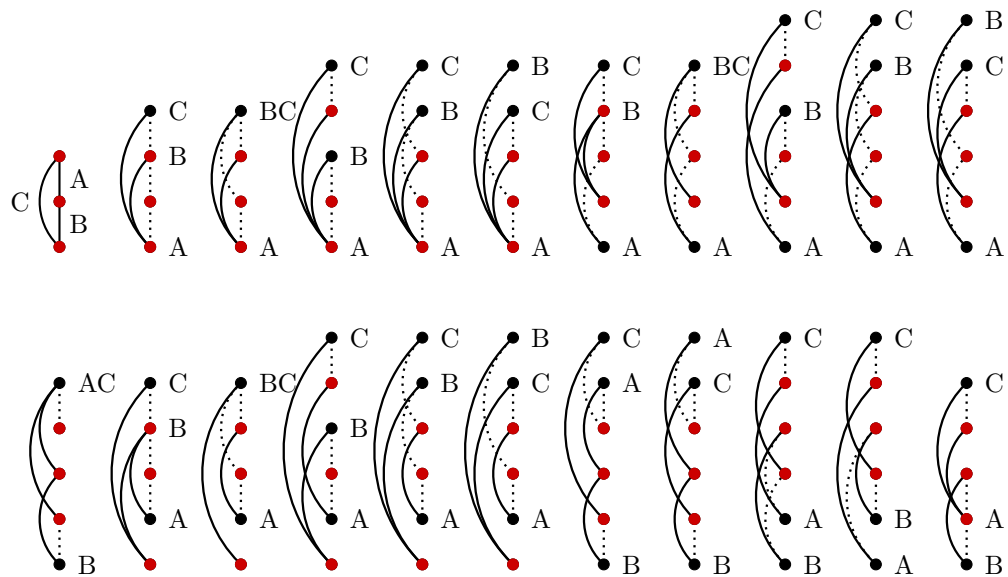

Figure A.17: Reference triangle (top-left) and forbidden patterns for proper thinness at most 2, other than those in Figure A.16 and their reverses. Red vertices form a clique in $\tilde{G}_<$, and labeled vertices are the witnesses for the respective edges of the clique, according to the labeling of the first triangle. We draw only those in which the witness of C is greater than the orange vertices. The complete set is obtained by the patterns in Figure A.16, those in the present figure, and their reverses.