

PROPERTY A AND DUALITY IN LINEAR PROGRAMMING

G. C. BELL AND A. NAGÓRKO

ABSTRACT. Property A is a form of weak amenability for groups and metric spaces introduced as an approach to the famous Novikov higher signature conjecture, one of the most important unsolved problems in topology.

We show that property A can be reduced to a sequence of linear programming optimization problems on finite graphs. We explore the dual problems, which turn out to have interesting interpretations as combinatorial problems concerning the maximum total supply of flows on a network.

Using isoperimetric inequalities, we relate the dual problems to the Cheeger constant of the graph and explore the role played by symmetry of a graph to obtain a striking characterization of the difference between an expander and a graph without property A. Property A turns out to be a new measure of connectivity of a graph that is relevant to graph theory.

The dual linear problems can be solved using a variety of methods, which we demonstrate on several enlightening examples. As a demonstration of the power of this linear programming approach we give elegant proofs of theorems of Nowak and Willett about graphs without property A.

1. INTRODUCTION

Property A is a form of weak amenability for groups and metric spaces introduced by G. Yu [15] at the turn of the century as an approach to the famous Novikov higher signature conjecture. First stated over fifty years ago, the Novikov conjecture asserts that the so-called higher signatures determined by a discrete group Γ are homotopy invariant and remains one of the most important unsolved problems in topology [5].

Yu proved that a discrete metric space X with property A admits a coarsely uniform embedding into Hilbert space and that this implies the coarse Baum-Connes conjecture. In the case that X is the Cayley graph of a finitely generated group Γ , this implies the Novikov conjecture for Γ .

A great deal of attention has been devoted to the study of property A because of the number of large classes of spaces known to have property A and the robust collection of operations on groups and spaces under which property A is closed. Among the properties of metric space that imply property A are finite asymptotic dimension [9], finite decomposition complexity [8], asymptotic property C [3], and polynomial dimension growth [4]. Moreover property A is known to satisfy more so-called permanence properties than, for example, finite asymptotic dimension, the rate of dimension growth, or uniform embeddability in Hilbert space [7].

While property A is defined for metric spaces, the most important use case is that of Cayley graphs of countable groups. For a graph G and a nonnegative number $S \geq 0$ called the scale, we define $\varepsilon_{G,S}$ to be the minimal variation of probability measures on G that are supported at scale S (see Optimization Problem I). The

Date: September 13, 2021.

2020 Mathematics Subject Classification. Primary: 90C05; Secondary: 90C46; 20F69; 05C48.

Key words and phrases. Property A; linear programming; strong duality; Cheeger constant; expanders.

graph G has property A if and only if $\lim_{S \rightarrow \infty} \varepsilon_{G,S} = 0$, i.e. if the minimal variation of probability measures tends to zero when the scale goes to infinity.

This paper stems from the observation that $\varepsilon_{G,S}$ can be computed with linear programming. We use a standard trick (Theorem 2.4) to reduce our considerations to finite graphs so we can apply linear optimization to the study of property A.

Beginning with the linear problem corresponding to the minimal variation of probability measures ε , we construct its dual problem. This dual problem has an interesting interpretation as a combinatorial problem concerning the maximum supply $\sum_i \eta_i$ of flows on a network. By strong duality, we have $\varepsilon = \sum_i \eta_i$.

There are many positive results about property A such as the permanence properties alluded to above. This has to do with the fact that to prove that $\varepsilon_{G,S} \rightarrow 0$ it is enough to find sufficiently nice upper bounds on $\varepsilon_{G,S}$. Computing $\varepsilon_{G,S}$ is a minimization problem so upper bounds are easy to get (e.g. any admissible solution of the problem provides an upper bound). On the other hand, constructions of graphs that fail to have property A are scarce and either rely on something stronger (such as failure of the space to embed in Hilbert space) or rely on ad hoc methods. Indeed, to show that $\lim \varepsilon_{G,S} > 0$ we need information about the optimal value of $\varepsilon_{G,S}$, which is much harder to determine. But, when we pass to the dual problem, which concerns maximizing $\sum_i \eta_i$, lower bounds are easy to get. The open status of the Novikov conjecture means that negative results concerning property A are particularly enticing. Using the dual problem, we characterize the gap between the Cheeger constant and variation of probability measures to show the exact place where such negative examples may be found.

As an application of the dual problem, we compute the values of ε (minimal variation of probability measures) for n -dimensional cube graphs and for graphs with large girth. These computations are effortless and as corollaries we obtain a theorem of Nowak [12] that a disjoint union of n -cubes does not have property A and a theorem of Willett [14] that a disjoint union of regular graphs with increasing girth does not have property A.

We refer to Figure 1 as we describe the flow and contents of the present paper. Examining the explicit computations in the dual problem (Pseudo Flows (II)) leads us to a natural relaxation in terms of Isoperimetric Inequalities (III). We pass to the dual problem to Isoperimetric Inequalities (III), which is again on the side of primal/minimization problems, and show that it is equivalent to a well-known reformulation of property A in the language of partitions of unity (see Partitions of Unity (IV)). We show more: the relaxation (III) is in fact the projection of the dual problem (II) into a lower dimensional space. In other words, on the dual side, the “probability measures” formulation is a lift of the “partitions of unity” formulation of property A. Both dual problems are interesting on their own: the dual to “probability measures” has more variables (but is polynomial in size with respect to the size of the graph), while the projection—the dual to “partitions of unity”—has fewer variables, but an exponential number of constraints.

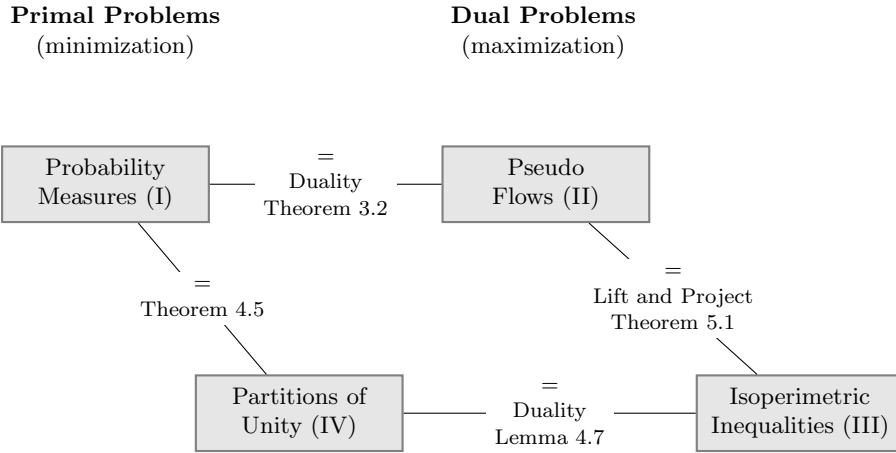

FIGURE 1. Exploring four problems in the primal and dual realms.

The set of optimal solutions to a linear problem is a convex polyhedron. An action on the graph G by isometries gives rise to an action on the vertices of this polyhedron and to additional symmetry constraints that are satisfied by the solution that is in its center of mass. If the action is transitive on both edges and vertices, then for the Isoperimetric Inequalities problem these symmetry constraints reduce the problem to a single variable η and it follows directly from the problem definition that its optimal solution is equal to $\frac{|V|}{|E|}\gamma(G, S)$, where $\gamma(G, S)$ is the Cheeger constant of G at scale S (cf. Definition 7.1).

This shows two things. If the graph is symmetric enough, then there is no difference between the expanding property (Cheeger constant $\geq \delta$ at all scales, for some $\delta > 0$) and lack of property A. Note that the symmetry must be present in finite convex subgraphs of the graph: infinite trees have large Cheeger constants at a fixed scale, yet they satisfy property A. This agrees with approaches currently known in the literature, where groups without property A (Gromov monster groups [6]) are constructed by showing that they contain expanders in their Cayley graphs.

If the graph is not symmetric, then we can still put symmetry constraints into the linear programming formulation to compute the Cheeger constant at scale S for the graph, see Figure 2. We study this problem, which we call the Uniform Flows problem (VI). Since it is a constrained dual (maximization) problem, the Cheeger constant will be smaller than the variation of probability measures ε . To understand the difference between these two, we constructed the dual problem to the Cheeger constant problem to express it in the language of probability measures. It turns out that it is equivalent to a problem, which we call Mean Property A (IX), in which the functionals are probability measures only on average and their variation is bounded by ε only on average. Hence the expanding property of a graph contradicts not only property A, but also this much weaker mean property A (see Theorem 7.6), leaving plenty of room for negative examples that are not expanders.

In the paper we provide the details of many examples, computed with different techniques. With the exception of the experimental results (which are not the topic of this paper), none of these are computed with the simplex method.

There is a notable difference between the Cheeger constant at scale S and the regular Cheeger constant of the graph. Using a lift of the linear formulation of the Cheeger constant at scale S problem to the problem about pseudo flows we get a polynomial time algorithm for its computation, while computation of the Cheeger constant is NP-hard [11].

This paper opens new areas of research. The first area is in geometric group theory, where some of the main interest in property A lies. One could ask, for example: How big is the gap between the expanding property of a graph (i.e. the Cheeger constant) and property A? How can this gap be exploited to construct new examples of graphs without property A? This question can be approached from both the theoretical and the experimental angle. For example, for small values of n and S , computations indicate that there is a large discrepancy between the expected value of the Cheeger constant and of the expected value of the variation of probability measures for random graphs on n vertices with edge density d at scale S .

The second area is in graph theory. Variation of probability measures estimates graph connectivity in a manner similar to the Cheeger constant, but is more resilient to local defects of the graph, e.g. it is not ruined by a single isolated vertex (which immediately makes the Cheeger constant zero). How is this new connectivity measure relevant to graph theory? Also in the opposite direction, in what ways can the wealth of knowledge about the Cheeger constant be transferred into geometric group theory?

2. PROPERTY A AS A LINEAR PROBLEM

Our first step is to reduce property A to a linear programming optimization problem. While property A is defined for metric spaces, the most important use case is that of countably infinite graphs with a path-length metric, and we define it in this setting.

We will always assume that our graphs $G = (V, E)$ are oriented ($E \subset V \times V$) with no self-loops. If $ij \in E$ is used to denote an edge, then i and j are used to denote the initial and terminal vertex of ij , respectively. The distance between vertices i and j in the path-length metric is the length of a shortest undirected path between i and j , which is measured by the number of edges. We allow infinite distance.

Definition 2.1. *A scale on a graph $G = (V, E)$ is a family*

$$\mathcal{S} = \{S_i : S_i \subset V\}_{i \in V}$$

of subsets of V , one set per vertex, or an integer $S \geq 0$ with the associated family

$$\{S_i = B(i, S)\}_{i \in V},$$

of (closed) balls of radius S , centered at the vertices of G .

Optimization Problem I. Minimal variation of probability measures at scale S .

Let $G = (V, E)$ be a graph and let $\mathcal{S} = \{S_i\}_{i \in V}$ be a scale on G . Find the minimal $\varepsilon = \varepsilon_{\mathcal{S}, G}$ (variation) and a family $\{\xi_i : V \rightarrow \mathbb{R}\}_{i \in V}$ of functionals (probability measures) such that

- (1) each ξ_i is a probability measure, i.e.

$$\|\xi_i\|_1 = 1 \text{ and } \xi_i \geq 0 \text{ for each } i \in V,$$

- (2) the variation on each edge ij does not exceed ε , i.e.

$$\|\xi_i - \xi_j\|_1 \leq \varepsilon \text{ for each } ij \in E,$$

- (3) each ξ_i is supported in S_i , i.e.

$$\text{supp } \xi_i = \{j \in V : \xi_i(j) > 0\} \subset S_i \text{ for each } i \in V.$$

Generally the graph G in Optimization Problem I is infinite.

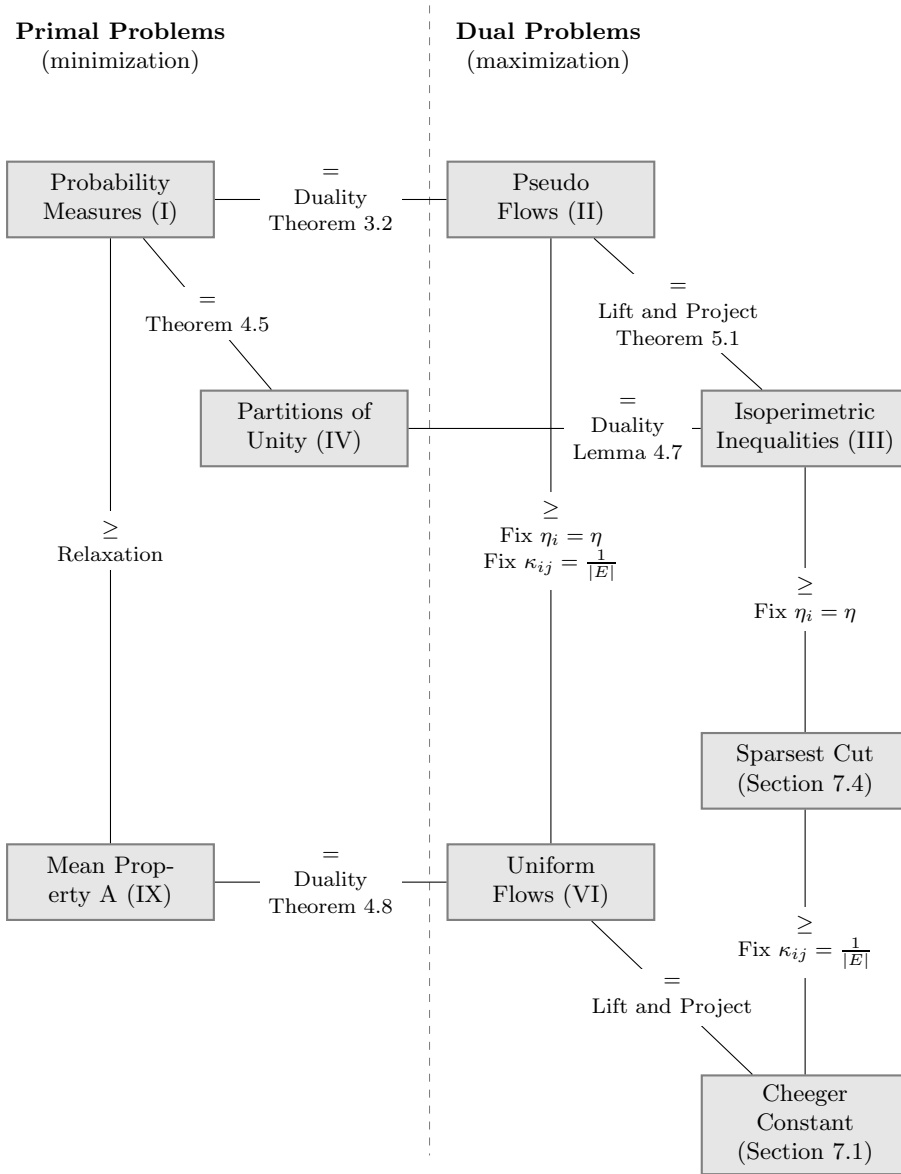

FIGURE 2. The road map of the paper: relationships between most important linear problems and optimization problems.

Definition 2.2. Let G be a graph and for each $S \geq 0$ let $\varepsilon_{S,G}$ be the minimal variation of probability measures on G at scale S , i.e. the solution of Optimization Problem I at scale S . We say that G has **property A** iff

$$\lim_{S \rightarrow \infty} \varepsilon_{S,G} = 0.$$

If $S \geq \text{diam } G$, then $\varepsilon_{S,G} = 0$. Therefore property A is trivial for finite graphs. However, solving Optimization Problem I for finite subgraphs of an infinite graph G allows us to determine whether or not G has property A.

Definition 2.3. A graph G is **locally finite** if the degree of each vertex of G is finite. A subgraph H of a graph G is **convex** if for each $i, j \in H$ that lie in a single

connected component of G there exists γ that is a geodesic from i to j in G such that $\gamma \subset H$.

For a graph G in the path-length metric, local finiteness is equivalent to the condition that balls are finite while the condition that $H \subset G$ is convex is equivalent to equality of the path-length metrics on H and G .

Theorem 2.4. *Let G be a countably infinite locally finite graph endowed with the path-length metric. Let $G_1 \subset G_2 \subset G_3 \subset \dots$ be an ascending sequence of finite convex subgraphs of G such that $G = \bigcup_{n \in \mathbb{N}} G_n$. Let ε_{S, G_n} be the minimal variation of probability measures at scale S for graph G_n , i.e. the optimal solution of Optimization Problem I for G_n at scale S . The graph G has property A iff*

$$\lim_{S \rightarrow \infty} \limsup_{n \rightarrow \infty} \varepsilon_{S, G_n} = 0.$$

Statements similar to Theorem 2.4 were proven by several authors (cf. [2, 13]) although the usual paradigm is to work with infinite graphs. Since it is not germane to the rest of our work, we postpone the proof to the last section.

Presently, we shift focus to finite graphs so we can recast Optimization Problem I as an equivalent linear problem (Linear Problem I). This allows us to use duality theory in linear programming to study property A.

Linear Problem I. Minimal variation of probability measures at scale S .

$$\begin{aligned} & \text{minimize} && e \\ & \text{subject to} && \sum_{j \in V} x_{i,j} = 1 \text{ for each } i \in V, \\ & && x_{i,j} = 0 \text{ for each } i \in V, j \in V \setminus S_i, \\ & && x_{j,k} - x_{i,k} \leq e_{ij,k} \text{ for each } ij \in E, k \in V, \\ & && x_{i,k} - x_{j,k} \leq e_{ij,k} \text{ for each } ij \in E, k \in V, \\ & && \sum_{k \in V} e_{ij,k} \leq e \text{ for each } ij \in E, \\ & && x_{i,j}, e_{ij,k}, e \geq 0 \end{aligned}$$

The graph $G = (V, E)$ in Linear Problem I is assumed to be finite.

Proposition 2.5. *Optimization Problem I and Linear Problem I are equivalent. We can pair admissible solutions of both problems by setting*

$$\xi_i(j) = x_{i,j} \text{ and } \varepsilon = e.$$

Proof. We have

$$\|\xi_i - \xi_j\|_1 = \sum_{k \in V} |\xi_i(k) - \xi_j(k)| = \sum_{k \in V} |x_{i,k} - x_{j,k}| \leq \sum_{k \in V} e_{ij,k} \leq e = \varepsilon.$$

The other conditions are trivial. Given an admissible solution of Optimization Problem I, we set $e_{ij,k} = |\xi_i(k) - \xi_j(k)|$ to get a full solution of Linear Problem I. \square

3. THE DUAL PROBLEM

In this section we construct the dual problem to Linear Problem I. The dual problem is supported by the dual scale.

Definition 3.1. Let $\mathcal{S} = \{S_i\}_{i \in V}$ be a scale on a graph $G = (V, E)$. We let

$$\bar{\mathcal{S}} = \{\bar{S}_i\}_{i \in V} \text{ with } \bar{S}_i = \{j \in V : i \in S_j\}$$

and call $\bar{\mathcal{S}}$ the **dual scale** to \mathcal{S} . If $\mathcal{S} = \bar{\mathcal{S}}$ (i.e. $i \in S_j$ iff $j \in S_i$ for each $i, j \in V$), then we call \mathcal{S} **symmetric**.

Note that a scale constructed from balls of radius S is symmetric. Moreover, $i \in \bar{S}_j$ if and only if $j \in S_i$ so the statements below can be rewritten without using the dual scale. We prefer to use it because it provides extra insight.

Linear Problem II at scale $\bar{\mathcal{S}}$ is dual to Linear Problem I at scale \mathcal{S} (Theorem 3.2).

Linear Problem II. Maximal net supply of pseudo-flows at dual scale $\bar{\mathcal{S}}$.

$$\begin{aligned} & \text{maximize} && \sum_{i \in V} \eta_i \\ & \text{subject to} && \\ & && \sum_{ij \in E} \kappa_{ij} \leq 1, \\ & && \varphi_{k,ij} \leq \kappa_{ij} \text{ for each } ij \in E, k \in V, \\ & && -\varphi_{k,ij} \leq \kappa_{ij} \text{ for each } ij \in E, k \in V, \\ & \sum_{mi \in E, m \in V} \varphi_{k,mi} - \sum_{im \in E, m \in V} \varphi_{k,im} \geq \eta_i && \text{ for each } k \in V, i \in \bar{S}_k, \\ & && \eta_i, \varphi_{k,ij} \in \mathbb{R}, \quad \kappa_{ij} \geq 0 \end{aligned}$$

Linear Problem II has a natural combinatorial interpretation in terms of pseudo-flows on a network. The network itself is the directed graph G along with a function κ that assigns to each edge $ij \in E$ a non-negative real number, κ_{ij} , called its **capacity**. The total capacity of the network does not exceed 1:

$$\sum_{ij \in E} \kappa_{ij} \leq 1.$$

For each vertex $k \in V$ there exists a **pseudo-flow** φ_k on E such that the magnitude of the flow across the edge ij is bounded by the capacity of that edge:

$$|\varphi_{k,ij}| \leq \kappa_{ij}.$$

The quantity

$$\sigma_{k,i} = \sum_{mi \in E, m \in V} \varphi_{k,mi} - \sum_{im \in E, m \in V} \varphi_{k,im}$$

is the **net supply** of the flow φ_k at the vertex i . If $im \in E$ and $\varphi_{k,im} = v$, then the flow φ_k adds the amount v (which may be negative) to $\sigma_{k,m}$ and subtracts v from $\sigma_{k,i}$.

The variable η_i is the **demand** at node $i \in V$ (which may be negative). The **demand constraint**

$$\sigma_{k,i} = \sum_{mi \in E, m \in V} \varphi_{k,mi} - \sum_{im \in E, m \in V} \varphi_{k,im} \geq \eta_i$$

states that the supply of the flow φ_k at node i has to meet the demand. It is important to note that the flow φ_k has to satisfy these demand constraints *only* for $i \in \bar{S}_k$.

The goal is to maximize the total demand $\sum_{i \in V} \eta_i$ that can be satisfied simultaneously by the pseudo-flows φ_k on the subsets \bar{S}_k of the graph.

Let $S, T \subset V$. We let $E[S, T] = (S \times T \cup T \times S) \cap E$ denote the set of all edges connecting S with T (without regard to orientation).

Optimization Problem II. Maximal net supply of pseudo-flows at dual scale $\bar{\mathcal{S}}$.

Let $G = (V, E)$ be a graph and let $\bar{\mathcal{S}} = \{\bar{S}_i\}_{i \in V}$ be a dual scale on G . Find the maximal sum $\sum_{i \in V} \eta_i$ of values of a (demand) functional $\eta: V \rightarrow \mathbb{R}$ such that there exists a (capacity) functional $\kappa: E \rightarrow \mathbb{R}$ and a family $\{\varphi_k: E[\bar{S}_k, V] \rightarrow \mathbb{R}\}_{k \in V}$ of functionals (pseudo-flows) such that

- (1) the capacity is non-negative and the total capacity does not exceed 1, i.e.

$$\sum_{ij \in E} \kappa_{ij} \leq 1 \text{ and } \kappa_{ij} \geq 0 \text{ for each } ij \in E,$$

- (2) each flow φ_k is bounded by the capacity κ , i.e.

$$-\kappa_{ij} \leq \varphi_{k,ij} \leq \kappa_{ij} \text{ for each } ij \in E \text{ and } k \in V,$$

- (3) the net supply of a flow φ_k at node $i \in \bar{S}_k$ satisfies the demand η_i , i.e.

$$\sum_{mi \in E, m \in V} \varphi_{k,mi} - \sum_{im \in E, m \in V} \varphi_{k,im} \geq \eta_i \text{ for each } k \in V, i \in \bar{S}_k.$$

Theorem 3.2. *Linear Problem II at scale $\bar{\mathcal{S}}$ is dual to Linear Problem I at scale \mathcal{S} . In particular, for each admissible solution of each problem, we have*

$$\sum_{i \in V} \eta_i \leq e$$

and the optimal solutions are equal.

Proof. We start with a direct argument (which does not use duality theory) to show the weak duality part of the theorem, i.e. to show the inequality $\sum_{i \in V} \eta_i \leq e$. The inequalities in the primal Linear Problem I imply that

$$e \geq \sum_{k \in V} |x_{j,k} - x_{i,k}|.$$

Since $\kappa_{ij} \geq |\varphi_{k,ij}|$, for each edge ij , we have

$$\kappa_{ij} \cdot e \geq \sum_{k \in V} \varphi_{k,ij} (x_{j,k} - x_{i,k}).$$

The condition $\sum_{ij \in E} \kappa_{ij} \leq 1$ implies that,

$$\begin{aligned} e &\geq \sum_{ij \in E} \sum_{k \in V} \varphi_{k,ij} (x_{j,k} - x_{i,k}) = \sum_{i \in V} \sum_{k \in V} x_{i,k} \left(\sum_{mi \in E} \varphi_{k,mi} - \sum_{im \in E} \varphi_{k,im} \right) \geq \\ &\geq \sum_{i \in V} \sum_{k \in V} x_{i,k} \eta_i = \sum_{i \in V} \eta_i \sum_{k \in V} x_{i,k} = \sum_{i \in V} \eta_i. \end{aligned}$$

This proves the weak duality part of the theorem. Note that because $x_{i,k} = 0$ for $i \notin \bar{S}_k$, the condition $\sigma_{k,i} \geq \eta_i$ only has to be enforced on nodes $i \in \bar{S}_k$. Thus a flow φ_k can freely draw from nodes that are outside of \bar{S}_k and the demand constraints are only defined for those $i \in \bar{S}_k$.

To show strong duality we will construct a dual problem to Linear Problem I using the method described in [10] (with some shortcuts). Here δ denotes the

Kronecker delta.

$$\begin{aligned}
e &\geq e - \sum_{i \in V} \eta_i (-1 + \sum_{j \in V} x_{i,j}) + \sum_{i \in V} \sum_{j \in V \setminus S_i} \tau_{i,j} x_{i,j} - \sum_{ij \in E} \sum_{k \in V} \varphi_{k,ij}^+ (e_{ij,k} - x_{j,k} + x_{i,k}) \\
&\quad - \sum_{ij \in E} \sum_{k \in V} \varphi_{k,ij}^- (e_{ij,k} - x_{i,k} + x_{j,k}) - \sum_{ij \in E} \kappa_{ij} (e - \sum_{k \in V} e_{ij,k}) = \\
&= \sum_{i \in V} \eta_i + e(1 - \sum_{ij \in E} \kappa_{ij}) + \sum_{ij \in E, k \in V} e_{ij,k} (-\varphi_{k,ij}^+ - \varphi_{k,ij}^- + \kappa_{ij}) \\
&\quad + \sum_{i,j \in V} x_{i,j} \left(- \sum_{k \in V, ik \in E} \varphi_{j,ik}^+ + \sum_{k \in V, ki \in E} \varphi_{j,ki}^+ - \sum_{k \in V, ki \in E} \varphi_{j,ki}^- \right. \\
&\quad \left. + \sum_{k \in V, ik \in E} \varphi_{j,ik}^- + \delta_{j \in V \setminus S_i} \tau_{i,j} - \eta_i \right) \geq \sum_{i \in V} \eta_i.
\end{aligned}$$

This gives the dual problem.

$$\text{maximize } \sum_{i \in V} \eta_i$$

subject to

$$\begin{aligned}
&\sum_{ij \in E} \kappa_{ij} \leq 1, \\
&\varphi_{k,ij}^+ + \varphi_{k,ij}^- \leq \kappa_{ij} \text{ for each } ij \in E, k \in V, \\
&\sum_{k \in V, ik \in E} (\varphi_{j,ik}^- - \varphi_{j,ik}^+) + \sum_{k \in V, ki \in E} (\varphi_{j,ki}^+ - \varphi_{j,ki}^-) + \delta_{j \in V \setminus S_i} \tau_{i,j} \geq \eta_i \text{ for each } i, j \in V, \\
&\eta_i, \tau_{ij} \in \mathbb{R}, \quad \varphi_{k,ij}^+, \varphi_{k,ij}^-, \kappa_{ij} \geq 0
\end{aligned}$$

Observe that given an admissible solution we can always replace each pair $\varphi_{k,ij}^+, \varphi_{k,ij}^-$ in such a way that either $\varphi_{k,ij}^+ = 0$ or $\varphi_{k,ij}^- = 0$. Then we can substitute $\varphi_{k,ij} = \varphi_{k,ij}^+ - \varphi_{k,ij}^-$ and we have $\varphi_{k,ij}^+ + \varphi_{k,ij}^- = |\varphi_{k,ij}|$. Also, the constraints where $\delta_{j \in V \setminus S_i} = 1$ are trivially satisfiable by setting the value of $\tau_{i,j}$ high enough. After these substitutions we obtain Linear Problem II. \square

3.1. Dual problem interpretation. We will now delve into an example to give a more detailed explanation of the dual problem. Consider the following connected chordal graph on 10 vertices.

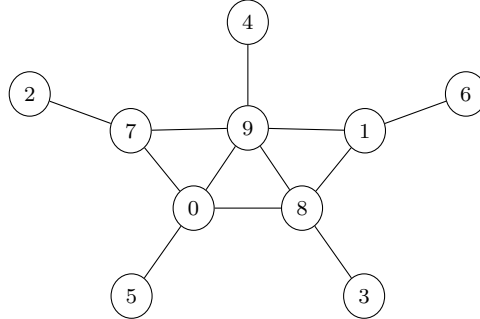

This graph was chosen from a set of 109539 connected chordal graphs on 10 vertices (all graphs of this type up to isomorphism). Our interest in chordal graphs will become apparent in Section 9. Among all such graphs, this one has maximal ε at scale $S = 1$; i.e. the minimal variation of probability measures at scale $S = 1$

is maximal for this graph. This value of ε is $\frac{16}{17}$, which we will demonstrate by exhibiting solutions of the primal and dual linear problems with $\varepsilon = \sum_{i \in V} \eta_i = \frac{16}{17}$.

The following table shows a solution of Linear Problem I. The entry in the i th column and j th row of the table is the value of $x_{i,j}$. Empty cells denote arguments outside of the scale, i.e. such that $j \notin S_i$ (implying that $x_{i,j} = 0$). Values of $e_{ij,k}$ and e are implicit. We can set $e_{ij,k} = |x_{j,k} - x_{i,k}|$ and $e = \max_{ij \in E} (\sum_{k \in V} e_{ij,k})$ to get an admissible solution of Linear Problem I with minimal value e for specified values of x .

	ξ_0	ξ_1	ξ_2	ξ_3	ξ_4	ξ_5	ξ_6	ξ_7	ξ_8	ξ_9
0	$\frac{9}{17}$					1		$\frac{3}{17}$	$\frac{2}{17}$	$\frac{1}{17}$
1		$\frac{1}{17}$					$\frac{9}{17}$		$\frac{1}{17}$	$\frac{1}{17}$
2			$\frac{14}{17}$					$\frac{6}{17}$		
3				$\frac{6}{17}$					$\frac{6}{17}$	
4					$\frac{12}{17}$					$\frac{4}{17}$
5	0					0				
6		$\frac{8}{17}$					$\frac{8}{17}$			
7	$\frac{1}{17}$		$\frac{3}{17}$					$\frac{3}{17}$		$\frac{3}{17}$
8	$\frac{2}{17}$	$\frac{3}{17}$		$\frac{11}{17}$					$\frac{3}{17}$	$\frac{3}{17}$
9	$\frac{5}{17}$	$\frac{5}{17}$			$\frac{5}{17}$			$\frac{5}{17}$	$\frac{5}{17}$	$\frac{5}{17}$

As before we let $\xi_i(j) = x_{i,j}$, so that each column describes a functional $\xi_i: S_i \rightarrow \mathbb{R}$ from Optimization Problem I. Clearly, $\xi_i \geq 0$, $\|\xi_i\|_1 = 1$ (condition (1)), and $\text{supp } \xi_i \subset B(i, 1)$ (condition (3)). To check condition (2) let

$$e_{ij} = \sum_{k \in V} e_{ij,k} = \|\xi_i - \xi_j\|_1$$

be an auxiliary variable that denotes the variation on the edge ij . For the solution given in the table above the values of e_{ij} are shown on the following graph.

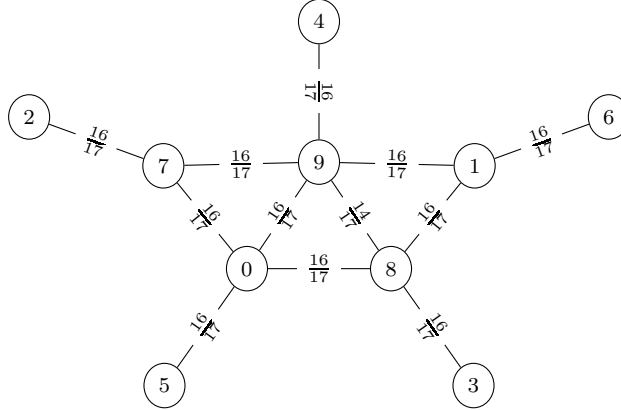

We see that $e = \frac{16}{17}$ is realized on all edges except the edge between nodes 8 and 9. The solution is admissible in the sense that it satisfies all constraints. It was found using the simplex method and it is one out of many basic optimal solutions of the problem (we did not show optimality yet).

To show that this solution is optimal we will provide a solution of the dual Linear Problem II with the same value of the objective function. The values of the variables κ_{ij} and η_i of the solution are shown on the following graph. The values of κ are shown as edge labels and the values of η are shown as node labels.

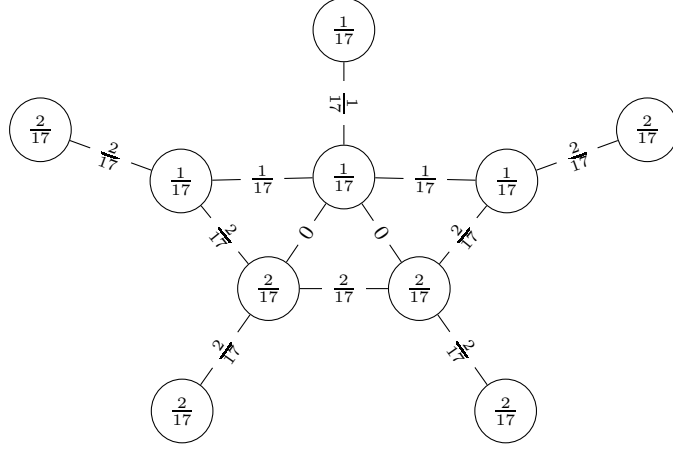

We interpret the edge labels κ_{ij} as a capacity function $\kappa: E \rightarrow [0, \infty)$ and the node labels η_i as a demand function $\eta: V \rightarrow \mathbb{R}$. We have $\sum_{ij \in E} \kappa_{ij} = 1$ (total capacity) and $\sum_{i \in V} \eta_i = \frac{16}{17}$ (total demand). To complete the solution of Linear Problem II we only need to specify the values of $\varphi_{k,ij}$. The main point is that once we set κ and η this task can be done separately for each k . For fixed κ, η and k we describe the process as a pseudo-flow optimization problem, as follows.

Fix $k = 0$. The following graph shows the values of $\varphi_{k,ij}$ for each $ij \in E[\bar{S}_k, V]$. So far we have ignored the orientation of the graph; now we fix it to show the direction of the flow (where a negative value means flow in the direction opposite to the edge's orientation) and the flow amount is shown on each edge.

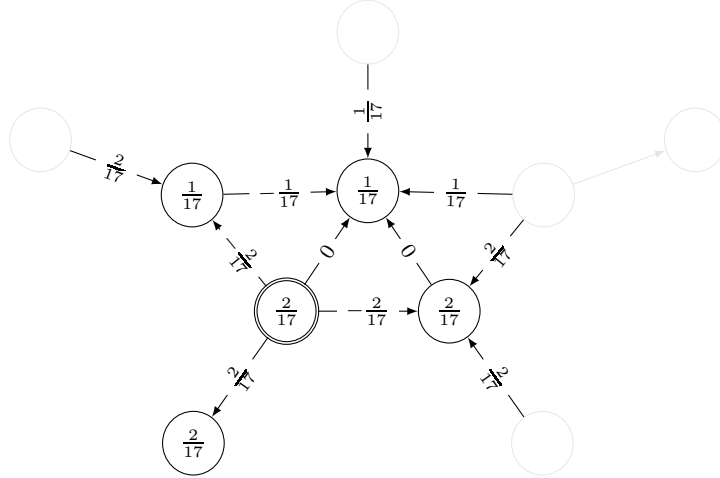

The fixed node $k = 0$ is marked with a double boundary. The values of $\varphi_{k,ij}$ (for $k = 0$) are indicated on the edges. One can see that the flow $\varphi_{k,ij}$ does not exceed the capacity κ_{ij} by directly comparing the values in the graphs. We interpret the values of $\varphi_{k,ij}$ as a function $\varphi_k: E[\bar{S}_k, V] \rightarrow \mathbb{R}$ —a pseudo-flow—with supply

$$\sigma_{k,i} = \sum_{mi \in E, m \in V} \varphi_{k,mi} - \sum_{im \in E, m \in V} \varphi_{k,im}$$

at node $i \in \bar{S}_k$. Condition (3) of Linear Problem II states that $\sigma_{k,i} \geq \eta_i$, i.e. that the supply $\sigma_{k,i}$ at node $i \in \bar{S}_k$ of the flow φ_k meets the demand η_i . To verify this, we mark the values of $\sigma_{k,i}$ as node labels in the graph and compare the values on both graphs directly. We see that the demand is satisfied by the supply at each node.

For $k = 6$ the pseudo-flow is the following.

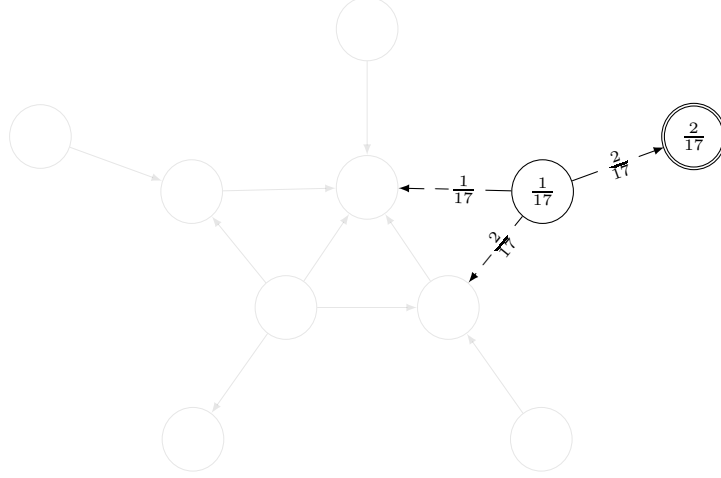

Again, the flow does not exceed the capacity κ and the demand η is satisfied by the flow. Pseudo-flows for the other vertices of the graph can be constructed as well. For brevity, we skip the details.

The following table shows the supply of each flow at each node. Note that we construct separate flows for each column, but the demand that can be satisfied is determined in each row, which makes interactions between φ and η subtle.

i	$\sigma_{0,i}$	$\sigma_{1,i}$	$\sigma_{2,i}$	$\sigma_{3,i}$	$\sigma_{4,i}$	$\sigma_{5,i}$	$\sigma_{6,i}$	$\sigma_{7,i}$	$\sigma_{8,i}$	$\sigma_{9,i}$	$\min_k \sigma_{k,i}$
0	$\frac{2}{17}$					$\frac{2}{17}$		$\frac{2}{17}$	$\frac{2}{17}$	$\frac{2}{17}$	$\eta_0 = \frac{2}{17}$
1		$\frac{1}{17}$					$\frac{1}{17}$		$\frac{1}{17}$	$\frac{1}{17}$	$\eta_1 = \frac{1}{17}$
2			$\frac{2}{17}$					$\frac{2}{17}$			$\eta_2 = \frac{2}{17}$
3				$\frac{2}{17}$					$\frac{2}{17}$		$\eta_3 = \frac{2}{17}$
4					$\frac{1}{17}$					$\frac{1}{17}$	$\eta_4 = \frac{1}{17}$
5	$\frac{2}{17}$					$\frac{2}{17}$					$\eta_5 = \frac{2}{17}$
6		$\frac{2}{17}$					$\frac{2}{17}$				$\eta_6 = \frac{2}{17}$
7	$\frac{1}{17}$		$\frac{1}{17}$					$\frac{1}{17}$		$\frac{1}{17}$	$\eta_7 = \frac{1}{17}$
8	$\frac{2}{17}$	$\frac{2}{17}$		$\frac{2}{17}$					$\frac{2}{17}$	$\frac{2}{17}$	$\eta_8 = \frac{2}{17}$
9	$\frac{1}{17}$	$\frac{1}{17}$			$\frac{1}{17}$			$\frac{1}{17}$	$\frac{1}{17}$	$\frac{1}{17}$	$\eta_9 = \frac{1}{17}$
											$\sum = \frac{16}{17}$

We specified a solution of Linear Problem II such that the value of objective function for this flow is $\sum_{i \in V} \eta_i = \frac{16}{17}$. By Theorem 3.2 this solution is optimal.

3.2. The square graph $\mathbb{Z}_2 \times \mathbb{Z}_2$. We will show what each pseudo-flow φ_k is transferring on a minimal non-trivial example. Consider the following graph.

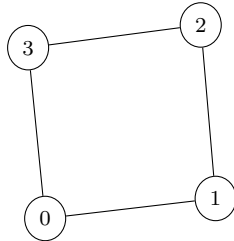

It is not difficult to find a good candidate for the optimal solution to Optimization Problem I at scale $S = 1$, by setting $\xi_i(j) = \frac{1}{3}$ when $j \in S_i = B(i, 1)$ and 0 otherwise. This yields the value $\varepsilon = \frac{2}{3}$.

For the dual problem, we set each capacity $\kappa_{ij} = \frac{1}{4}$ and construct flows that satisfy the demand $\eta_i = \frac{1}{6}$ at each node.

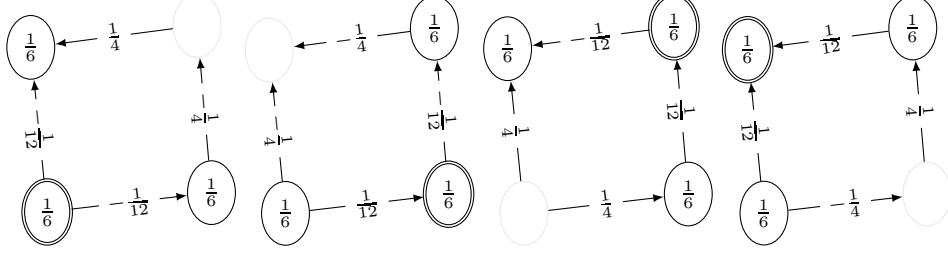

The diagram above indicates the values of the pseudo-flows $\varphi_0, \varphi_1, \varphi_2, \varphi_3$, from left to right, with the node i of the flow φ_i indicated by a double boundary. The values on the edges are the pseudo-flow values. The labels on each vertex indicate the supplies of the flow; we note that these are marked only in nodes from the dual scale, since the demand constraints are not defined outside the dual scale.

We will show how the dual solution proves the optimality of the primal solution. The following inequality describes the variation of the probability measures on edge 01.

$$\|\xi_0 - \xi_1\|_1 = |x_{1,0} - x_{0,0}| + |x_{1,1} - x_{0,1}| + |x_{1,2} - x_{0,2}| + |x_{1,3} - x_{0,3}| \leq \varepsilon$$

Those values that are not in the support, and are therefore forced to be 0 by the problem specification, are grayed out. This implies that

$$-\frac{1}{3} \cdot (x_{1,0} - x_{0,0}) + \frac{1}{3} \cdot (x_{1,1} - x_{0,1}) + 1 \cdot ((x_{1,2} - x_{0,2}) + (-1) \cdot (x_{1,3} - x_{0,3})) \leq \varepsilon.$$

This inequality remains valid if we replace the coefficients with any coefficients from the interval $[-1, 1]$; the reason for our choice of coefficients will be apparent below: we use rescaled values of the first flow shown above. We can write similar inequalities using all flows to obtain the following system of inequalities; here we have multiplied each inequality by $\frac{1}{4}$ so that the right-hand side sums to ε .

$$\begin{aligned} -\frac{1}{12}(x_{1,0} - x_{0,0}) + \frac{1}{12}(x_{1,1} - x_{0,1}) + \frac{1}{4}(x_{1,2} - x_{0,2}) + \left(-\frac{1}{4}\right)(x_{1,3} - x_{0,3}) &\leq \frac{1}{4}\varepsilon \\ -\frac{1}{12}(x_{3,0} - x_{0,0}) + \left(-\frac{1}{4}\right)(x_{3,1} - x_{0,1}) + \frac{1}{4}(x_{3,2} - x_{0,2}) + \frac{1}{12}(x_{3,3} - x_{0,3}) &\leq \frac{1}{4}\varepsilon \\ -\frac{1}{4}(x_{2,0} - x_{1,0}) + \left(-\frac{1}{12}\right)(x_{2,1} - x_{1,1}) + \frac{1}{12}(x_{2,2} - x_{1,2}) + \frac{1}{4}(x_{2,3} - x_{1,3}) &\leq \frac{1}{4}\varepsilon \\ \frac{1}{4}(x_{3,0} - x_{2,0}) + \left(-\frac{1}{4}\right)(x_{3,1} - x_{2,1}) + \left(-\frac{1}{12}\right)(x_{3,2} - x_{2,2}) + \frac{1}{12}(x_{3,3} - x_{2,3}) &\leq \frac{1}{4}\varepsilon \end{aligned}$$

The coefficients of this system of linear equations in matrix notation are

$$\begin{bmatrix} -\frac{1}{12} & \frac{1}{12} & \frac{1}{4} & -\frac{1}{4} & \left| \frac{1}{4} \right. \\ -\frac{1}{12} & -\frac{1}{4} & \frac{1}{4} & \frac{1}{12} & \left| \frac{1}{4} \right. \\ -\frac{1}{4} & -\frac{1}{12} & \frac{1}{12} & \frac{1}{4} & \left| \frac{1}{4} \right. \\ \frac{1}{4} & -\frac{1}{4} & -\frac{1}{12} & \frac{1}{12} & \left| \frac{1}{4} \right. \end{bmatrix}.$$

The coefficient matrix has 5 columns and 4 rows. Each row corresponds to an edge of the graph: 01, 03, 12, 23 respectively. For the row corresponding to edge $ij \in E$, the coefficient on the right-hand side is κ_{ij} . Each column on the left-hand

side corresponds to one vertex of the graph: 0, 1, 2, 3 respectively. For the column corresponding to vertex $k \in V$, the coefficients are the values of the flow φ_k .

We add everything together and group by x 's.

$$\begin{aligned} & x_{0,0}(-(-\frac{1}{12}) - (-\frac{1}{12})) + x_{0,1}(-\frac{1}{12} - (-\frac{1}{4})) + x_{0,2}(-\frac{1}{4} - \frac{1}{4}) + x_{0,3}(-(-\frac{1}{4}) - \frac{1}{12}) + \\ & x_{1,0}(-\frac{1}{12} - (-\frac{1}{4})) + x_{1,1}(\frac{1}{12} - (-\frac{1}{12})) + x_{1,2}(\frac{1}{4} - \frac{1}{12}) + x_{1,3}(-\frac{1}{4} - \frac{1}{4}) \\ & x_{2,0}(-\frac{1}{4} - \frac{1}{4}) + x_{2,1}(-\frac{1}{12} - (-\frac{1}{4})) + x_{2,2}(\frac{1}{12} - (-\frac{1}{12})) + x_{2,3}(\frac{1}{4} - \frac{1}{12}) \\ & x_{3,0}(-\frac{1}{12} + \frac{1}{4}) + x_{3,1}(-\frac{1}{4} + -\frac{1}{4}) + x_{3,2}(\frac{1}{4} + -\frac{1}{12}) + x_{3,3}(\frac{1}{12} + \frac{1}{12}) \leq \varepsilon \end{aligned}$$

After regrouping we get a new coefficient matrix:

$$\begin{bmatrix} -(-\frac{1}{12}) - (-\frac{1}{12}) & -\frac{1}{12} - (-\frac{1}{4}) & & -(-\frac{1}{4}) - \frac{1}{12} \\ -\frac{1}{12} - (-\frac{1}{4}) & \frac{1}{12} - (-\frac{1}{12}) & \frac{1}{4} - \frac{1}{12} & \\ & -\frac{1}{12} - (-\frac{1}{4}) & \frac{1}{12} - (-\frac{1}{12}) & \frac{1}{4} - \frac{1}{12} \\ -\frac{1}{12} + \frac{1}{4} & & \frac{1}{4} + -\frac{1}{12} & \frac{1}{12} + \frac{1}{12} \end{bmatrix}.$$

The coefficients in the first row are $\sigma_{0,0}, \sigma_{1,0}, \sigma_{3,0}$: the supplies of the flows $\varphi_0, \varphi_1, \varphi_3$ at node 0. (The value $\sigma_{2,0}$ is ignored since 2 is not in the support of ξ_0 and $x_{0,2} = 0$.) By the demand constraints we have $\sigma_{0,0}, \sigma_{1,0}, \sigma_{3,0} \geq \eta_0 = \frac{1}{6}$ and by the probability measure constraint we have $x_{0,0} + x_{0,1} + x_{0,3} = 1$ (again, $x_{0,2} = 0$). Therefore,

$$\sigma_{0,0}x_{0,0} + \sigma_{1,0}x_{0,1} + \sigma_{3,0}x_{0,3} \geq \eta_0(x_{0,0} + x_{0,1} + x_{0,3}) = \frac{1}{6} \cdot 1.$$

A similar argument for subsequent rows gives a lower bound of $4 \cdot \frac{1}{6}$ on ε , which proves that the primal solution $\varepsilon = \frac{2}{3}$ was optimal.

The game is to maximize the minimum value η_i in each row of the coefficient matrix in such a way that $\sum_{i \in V} \eta_i$ is maximal. A change in a single flow value $\varphi_{k,ij}$ by v increases the value of $\sigma_{k,j}$ by v (in the j th row, k th column) and decreases the value of $\sigma_{k,i}$ by v . The flow φ_k along the edge ij transfers coefficient from k th column, i th row to k th column, j th row. The values that are not in the scale are ignored, which allows us to obtain a positive net value.

The relationship between supplies and demands in the coefficient matrix is rather subtle: a flow φ_k determines the supplies in the k th column, while a demand η_i is computed from the i th row. A natural simplification when constructing a flow φ_k is to maximize its minimal supply (i.e. maximize the minimal coefficient in k th column), which splits the problem into several easier sub-problems. Later, we will achieve this by replacing the possibly distinct demands η_i by a single global demand η . The resulting problem is easier, but not equivalent. We will study this in detail in Section 7.4.

4. THE DUAL PROBLEM WITHOUT FLOWS

In this section we give a reformulation of the dual problem that does not use the flow variables $\varphi_{k,ij}$. We show that its dual (which is again a minimization problem) is a well-known reformulation of property A in the language of partitions of unity.

4.1. The cube graph $\mathbb{Z}_2 \times \mathbb{Z}_2 \times \mathbb{Z}_2$. To motivate what follows, we solve the primal and dual problems for the three-dimensional cube graph Q_3 at scale $S = 2$, see Figure 3.

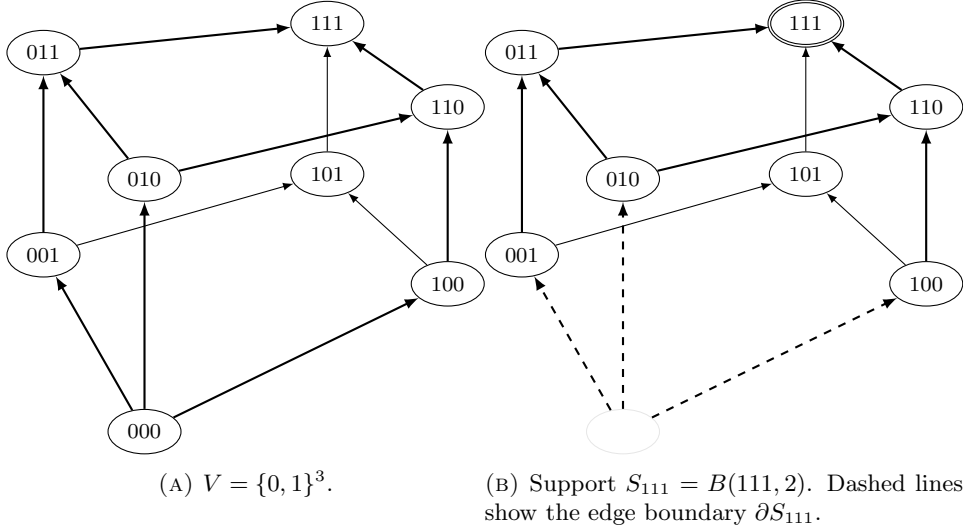
FIGURE 3. The cube graph Q_3 at scale $S = 2$.

For $S = 2$ the scale is $\mathcal{S} = \{S_i = B(i, 2) : i \in V\}$. It is not difficult to achieve a value of $e = \frac{2}{7}$ for the primal problem by setting $x_{i,j} = \frac{1}{7}$ for each $i \in V$ when $j \in S_i$ and 0 otherwise.

To solve the dual problem, we set the capacity of each edge to be $\kappa_{ij} = \frac{1}{|E|} = \frac{1}{12}$. Because of the symmetry of the graph, it is reasonable to maximize the minimal supply $\eta = \min_{i \in V} \eta_i$ over all nodes (cf. Theorem 6.1). Our task is to find, for each k , a pseudo-flow on $E[S_k, V]$ that maximizes η . The edge set $E[S_k, V]$ for $k = 111$ is shown on Figure 3b. The dashed lines are edges at the boundary ∂S_k . Observe that the flow on the edges connecting vertices of S_k with vertices of S_k does not change the total supply $\sum_{i \in S_k} \sigma_{k,i}$ of the flow φ_k on S_k . The total supply is equal to the amount of flow on ∂S_k , which is bounded by $|\partial S_k| \cdot \frac{1}{|E|} = \frac{3}{12}$. Clearly, the minimal supply η at a node is not greater than the total supply divided by the number of nodes in S_k :

$$\eta \leq \frac{|\partial S_k|}{|S_k| \cdot |E|} = \frac{3}{12 \cdot 7}.$$

Here it is easy to find a flow that spreads the supply evenly across the nodes of S_k and obtain $\eta_i = \frac{1}{28}$ for each i . For $k = 111$, we flow the maximal value of $\frac{1}{12}$ along the edges from 000 to each of 001, 010, and 100. Next, we flow $\frac{1}{42}$ from each of these three vertices to the pair of vertices above them (whose descriptions contain exactly two 1s). Finally, we flow $\frac{1}{84}$ from each vertex containing exactly two 1s to the vertex 111. This yields a difference σ of $\frac{3}{84} = \frac{1}{28}$ at each vertex.

By symmetry, we can obtain the same value for each starting vertex; thus $\eta_i = \frac{1}{28}$ and $\sum_{i \in V} \eta_i = 8 \cdot \frac{1}{28} = \frac{2}{7}$. By Theorem 3.2, we have

$$\frac{2}{7} \leq \sum_{i \in V} \eta_i \leq e \leq \frac{2}{7}.$$

Unsurprisingly, this manual solution is only one of the possible pseudo-flows that achieve this optimal value of $\sum \eta_i$. A basic solution found by the simplex method lacks the symmetry and is described in Figure 5, which is part of a solution with $\sum \eta_i = \frac{2}{7}$; however, the manual solution yields insight that leads to a general statement, see Theorem 8.1.

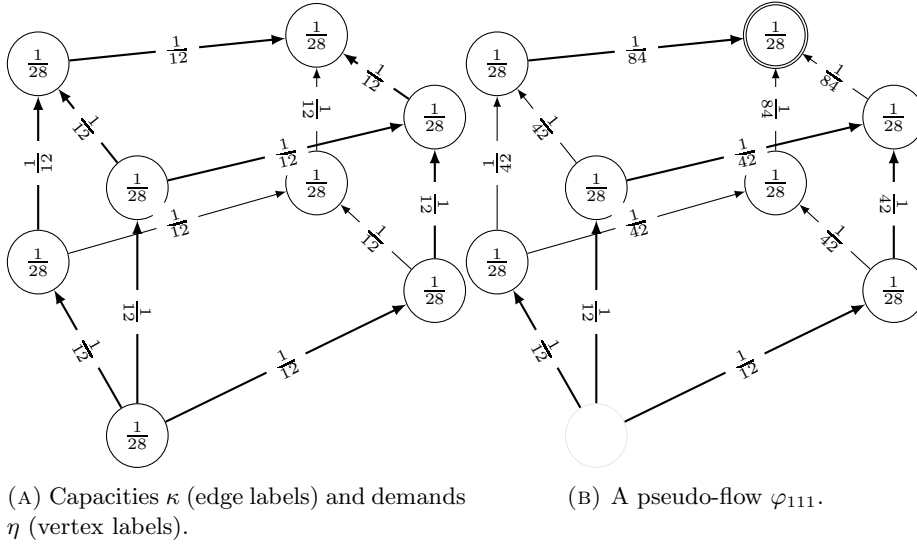

FIGURE 4. A symmetric solution of Optimization Problem II for Q_3 at scale $S = 2$.

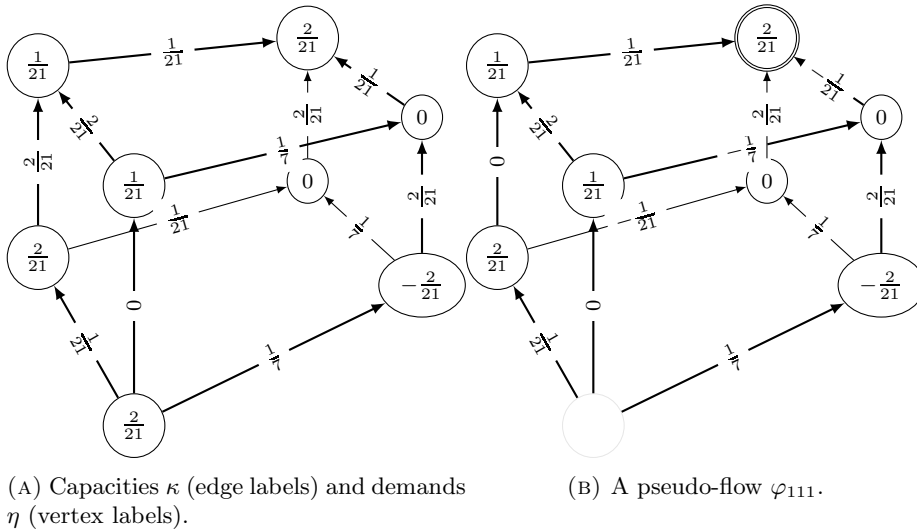
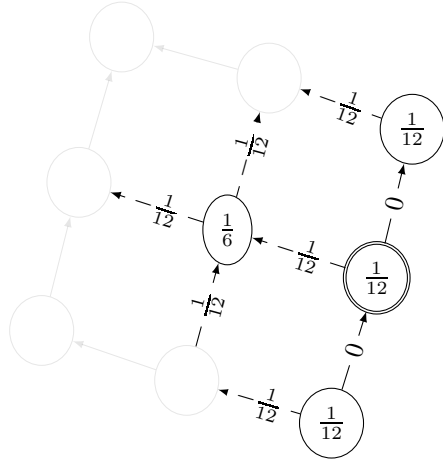

FIGURE 5. A basic solution (one of many) of Optimization Problem II for Q_3 at scale $S = 2$ found with the simplex method. Note negative value $\eta_{100} = -\frac{2}{21}$.

4.2. **The 3×3 grid.** The optimal solutions to the primal and dual problems in the previous example could be found by hand by exploiting the cube's inherent symmetry. Next, we consider a 3×3 grid.

Fix $S = 1$. Attempting to find a solution to the dual problem with equal edge capacities of $\kappa = \frac{1}{|E|} = \frac{1}{12}$ using the technique that we employed above results in a "bottleneck" along an edge incident to the center vertex as indicated below.



This solution results in $\sum \eta_i = \frac{41}{45}$. On the other hand, by allowing variable capacities, one can find the optimal value $\sum_i \eta_i = \frac{12}{13}$, see Figure 6.

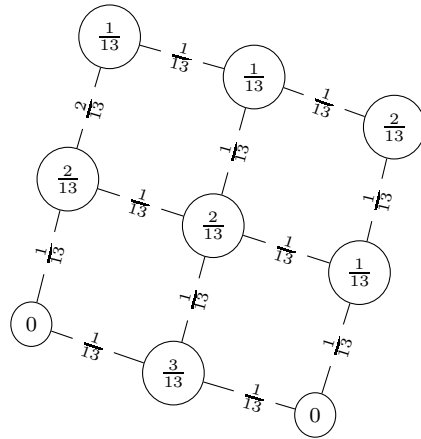

FIGURE 6. By allowing variable capacities, we are able to achieve $\sum_i \eta_i = e$.

The conclusion is that in the absence of symmetry, one cannot expect optimal solutions with equal capacities.

4.3. Weighted isoperimetric inequality. Let $G = (V, E)$ be a graph. For each $T \subset V$ we let

$$\partial T = E[T, V \setminus T]$$

be the **edge boundary** of T . As before, $E[T, V \setminus T] = (T \times (V \setminus T) \cup (V \setminus T) \times T) \cap E$. The main insight in the solution of the dual problem for the cube graph Q_3 was the following inequality.

$$\sum_{i \in T} \sigma_{k,i} \leq \sum_{ij \in \partial T} \kappa_{ij}.$$

Clearly, if $ij \in E[T, T]$, then $\varphi_{k,ij}$ appears with a positive sign in $\sigma_{k,j}$ and with a negative sign in $\sigma_{k,i}$, hence the flow on the edges inside T cancels out.

$$\sum_{i \in T} \sigma_{k,i} = \sum_{i \in T} \left(\sum_{mi \in E, m \in V} \varphi_{k,mi} - \sum_{im \in E, m \in V} \varphi_{k,im} \right) =$$

$$= \sum_{ij \in E[V \setminus T, T]} \varphi_{k,ij} - \sum_{ij \in E[T, V \setminus T]} \varphi_{k,ij} \leq \sum_{ij \in \partial T} \kappa_{ij}.$$

In other words, the inequality states that the total supply in T is bounded by the total capacity at the boundary of T .

Let $\mathcal{S} = \{S_i\}_{i \in V}$ be a scale on G . For each $k \in V$ and each $T \subset \overline{S}_k$ the flow φ_k satisfies the inequality

$$\sum_{i \in T} \eta_i \leq \sum_{i \in T} \sigma_{k,i}.$$

Hence for each flow φ_k , $k \in V$ and each $T \subset \overline{S}_k$ we have

$$\sum_{i \in T} \eta_i \leq \sum_{ij \in \partial T} \kappa_{ij}.$$

This is a **weighted isoperimetric inequality**: the volume of T with respect to η is bounded by the volume of ∂T with respect to κ . We have just proven the following theorem.

Theorem 4.1. *Each admissible solution of the dual problem satisfies a weighted isoperimetric inequality for all subsets of elements of the dual scale.*

More precisely, if $(\eta_i, \kappa_{ij}, \varphi_{k,ij})$ is an admissible solution of Linear Problem II, then

$$\sum_{i \in T} \eta_i \leq \sum_{ij \in \partial T} \kappa_{ij}$$

for each $T \subset \overline{S} \in \overline{\mathcal{S}}$.

Therefore the following problem is a relaxation of the pseudo-flows problem.

Linear Problem III. Weighted isoperimetric inequalities at scale $\overline{\mathcal{S}}$.

$$\begin{aligned} & \text{maximize} && \sum_{i \in V} \eta_i \\ & \text{subject to} && \\ & && \sum_{ij \in E} \kappa_{ij} \leq 1, \\ & && \sum_{i \in T} \eta_i \leq \sum_{ij \in \partial T} \kappa_{ij} \quad \text{for each } T \subset \overline{S} \in \overline{\mathcal{S}}, \\ & && \kappa_{ij} \geq 0, \eta_i \in \mathbb{R} \end{aligned}$$

Our goal in this section is to show that both problems are equivalent.

4.4. Partitions of unity supported by \mathcal{S} . Consider the following optimization problem.

Optimization Problem III. Partition of unity supported by \mathcal{S} .

Minimize $\varepsilon \geq 0$ such that there exists a partition of unity $\{\phi_i\}_{i \in V}$ for G at scale \mathcal{S} with ε -variation, i.e.

(1) the ϕ_i 's are non-negative, i.e.

$$\phi_i(j) \geq 0 \text{ for each } i, j \in V,$$

(2) the sum of the ϕ_i 's is a constant unit function, i.e.

$$\sum_{i \in V} \phi_i(j) = 1 \text{ for each } j \in V,$$

- (3) the sum of the variations of the ϕ_i 's on the edge $kj \in E$ does not exceed ε , i.e.

$$\sum_{i \in V} |\phi_i(k) - \phi_i(j)| \leq \varepsilon \text{ for each } kj \in E, \text{ and}$$

- (4) each ϕ_i is supported by \mathcal{S} , i.e.

$$\text{supp } \phi_i \subset S_i \text{ for each } i \in V.$$

Optimization Problem III has the following linear programming formulation.

Linear Problem IV. Partition of unity supported by \mathcal{S} .

minimize e

subject to

$$\sum_{j \in V} f_{j,i} = 1 \quad \text{for each } i \in V,$$

$$f_{k,i} - f_{k,j} \leq e_{i,kj} \text{ for each } ij \in E, k \in V,$$

$$f_{k,j} - f_{k,i} \leq e_{i,kj} \text{ for each } ij \in E, k \in V,$$

$$\sum_{i \in V} e_{i,kj} \leq e \quad \text{for each } kj \in E,$$

$$f_{i,j} = 0 \quad \text{for each } i \in V, j \in V \setminus S_i,$$

$$f_{i,j}, e_{i,kl} \geq 0, e \in \mathbb{R} \quad \text{for each } i, j \in V, kl \in E$$

Proposition 4.2. *Linear Problem I at scale \mathcal{S} is equivalent to Linear Problem IV at scale $\bar{\mathcal{S}}$, i.e. we can pair admissible solutions of both problems by setting*

$$x_{i,j} = f_{j,i}.$$

To see the equivalence on an example, consider the table in Section 3.1 with values of ξ . In the i th column, values of the probability measure ξ_i supported by S_i are listed. The rows of the table form a partition of unity and are supported by the dual scale.

4.5. Partitions of unity subordinated to \mathcal{S} . In the last section, the elements ϕ_i of a partition of unity were in one-to-one correspondence with the elements S_i of the cover \mathcal{S} . Usually this is not required. For our application we consider an equivalent problem without the one-to-one correspondence and with a non-standard requirement that functions that form the partition of unity are flat, i.e. constant on their support.

Optimization Problem IV. Flat partition of unity.

Minimize $\epsilon \geq 0$ such that there exists a finite partition of unity $\{\psi_\alpha\}$ for G subordinated to scale \mathcal{S} with ϵ -variation and flat elements, i.e.

- (1) each ψ_α is non-negative, i.e. for each α

$$\psi_\alpha(i) \geq 0 \text{ for each } i \in V,$$

- (2) the elements of the partition are constant on their support, i.e.

$$\psi_\alpha(j) = \psi_\alpha(k)$$

for each α and each $j, k \in V$ such that $\psi(j), \psi(k) > 0$,

(3) the sum of the ψ 's is a constant unit function, i.e.

$$\sum_{\alpha} \psi_{\alpha}(i) = 1 \text{ for each } i \in V,$$

(4) the sum of the variations of the ψ 's on each edge $kj \in E$ does not exceed ϵ , i.e.

$$\sum_{\alpha} |\psi_{\alpha}(k) - \psi_{\alpha}(j)| \leq \epsilon \text{ for each } kj \in E, \text{ and}$$

(5) each ψ is supported by \mathcal{S} , i.e.

$$\text{supp } \psi_{\alpha} \subset S \text{ for each } \alpha \text{ and some } S \in \mathcal{S}.$$

Lemma 4.3. *We have*

$$\epsilon \leq \epsilon.$$

That is, for a graph G at scale \mathcal{S} the optimal solution of Optimization Problem III is bounded by the optimal solution of Optimization Problem IV.

Proof. Let $\{\psi_{\alpha}\}$ be a finite partition of unity subordinated to $\mathcal{S} = \{S_i\}_{i \in V}$ where the functions ψ_{α} only assume one nonzero value. For every $\alpha \in A$, we choose a vertex $i = i(\alpha)$ with the property that $\text{supp}(\psi_{\alpha}) \subseteq S_i$.

We put

$$\phi_i(j) = \sum_{\alpha: i=i(\alpha)} \psi_{\alpha}(j).$$

Then, if $j \in \text{supp}(\phi_i)$, then there is some α such that $i(\alpha) = i$ and so $j \in \text{supp}(\psi_{\alpha})$, which is to say $j \in S_i$. Next,

$$\sum_{i \in V} \phi_i(j) = \sum_{i \in V} \left(\sum_{\alpha: i=i(\alpha)} \psi_{\alpha}(j) \right) = \sum_{\alpha} \psi_{\alpha}(j) = 1.$$

Finally, if we fix an edge, jk , then

$$\begin{aligned} \sum_{i \in V} |\phi_i(j) - \phi_i(k)| &= \sum_{i \in V} \left| \sum_{\alpha: i=i(\alpha)} \psi_{\alpha}(j) - \sum_{\alpha: i=i(\alpha)} \psi_{\alpha}(k) \right| \\ &\leq \sum_{i \in V} \sum_{\alpha: i=i(\alpha)} |\psi_{\alpha}(j) - \psi_{\alpha}(k)| \leq \epsilon. \end{aligned}$$

□

Note that in the proof we do not use the assumption that the ψ_{α} 's are flat. We will need this variant of partitions of unity in the next section. We also have the reversed inequality.

Lemma 4.4. *We have*

$$\epsilon \geq \epsilon.$$

That is, for graph G at scale \mathcal{S} the optimal solution of Optimization Problem IV is bounded by the optimal solution of Optimization Problem III.

Proof. Let $\{\phi_i\}$ be a partition of unity with $\text{supp}(\phi_i) \subset S_i$ and $\sum_{i \in V} |\phi_i(j) - \phi_i(k)| \leq \epsilon$ whenever jk is an edge.

For each $i \in V$, the function ϕ_i takes on only finitely many (say n_i -many) values: $0 = y_0^i < y_1^i < \dots < y_{n_i}^i$. Put

$$\psi_{\alpha_r^i}(j) = \begin{cases} 0 & \text{if } \phi_i(j) \leq y_{r-1}^i; \\ y_r^i - y_{r-1}^i & \text{otherwise.} \end{cases}$$

We observe that for each i and each $r \in \{1, \dots, n_i\}$, the function $\phi_{\alpha_r^i}$ takes on exactly one nonzero value. Moreover, it is easy to see that $\text{supp}(\psi_{\alpha_r^i}) \subset S_i$ and that for every j , if we sum over all values of α , we obtain:

$$\sum_{\alpha} \psi_{\alpha}(j) = \sum_{i \in V} \sum_{r=1}^{n_i} \psi_{\alpha_r^i}(j) = \sum_{i \in V} \phi_i(j) = 1.$$

Finally, it is easy to verify that,

$$|\phi_i(j) - \phi_i(k)| = \sum_{r=1}^{n_i} |\psi_{\alpha_r^i}(j) - \psi_{\alpha_r^i}(k)|,$$

and so if jk is an edge, then

$$\sum_{\alpha} |\psi_{\alpha}(j) - \psi_{\alpha}(k)| = \sum_{i \in V} \sum_{r=1}^{n_i} |\psi_{\alpha_r^i}(j) - \psi_{\alpha_r^i}(k)| = \sum_{i \in V} |\phi_i(j) - \phi_i(k)| \leq \varepsilon.$$

□

As a corollary we obtain the following theorem.

Theorem 4.5. *Let $G = (V, E)$ be a finite graph, let $\varepsilon > 0$, and let $\mathcal{S} = \{S_i\}_{i \in V}$ be a scale. As before, for $S_i \in \mathcal{S}$, we let $\bar{S}_i = \{j \in V : j \in S_i\}$. The following are equivalent:*

- (1) *there exists a collection $\{\xi_i\}_{i \in V}$ of probability measures on G with ε variation at scale \mathcal{S} ;*
- (2) *there exists a partition of unity $\{\phi_i\}_{i \in V}$ on G with ε variation at scale $\bar{\mathcal{S}}$; and*
- (3) *there exists a flat partition of unity $\{\psi\}$ on G with ε variation subordinated to $\bar{\mathcal{S}}$.*

Proof. Equivalence (1) \Leftrightarrow (2) follows from Proposition 4.2. Equivalence (2) \Leftrightarrow (3) follows from Lemma 4.3 and Lemma 4.4 applied to the dual scale $\bar{\mathcal{S}}$. □

4.6. The dual problem to maximal weighted isoperimetric number. We are ready to construct a dual problem to Linear Problem III and to show how its optimal solution yields a feasible solution for Optimization Problem IV.

Linear Problem V. Weighted isoperimetric inequalities dual at scale $\bar{\mathcal{S}}$.

$$\begin{aligned} & \text{minimize} && a \\ & \text{subject to} && \\ & && \sum_{T: ij \in \partial T} z_T \leq a \text{ for each } ij \in E, \\ & && \sum_{T: i \in T} z_T = 1 \text{ for each } i \in V \end{aligned}$$

Lemma 4.6. *Linear Problem V is dual to Linear Problem III.*

Proof. This follows from the dual problem derivation:

$$\begin{aligned} \sum_{i \in V} \eta_i &\leq \sum_{i \in V} \eta_i + \sum_{T: T \subset \bar{\mathcal{S}} \in \bar{\mathcal{S}}} z_T \left(\sum_{ij \in \partial T} \kappa_{ij} - \sum_{i \in T} \eta_i \right) + a \left(1 - \sum_{ij \in E} \kappa_{ij} \right) = \\ &= a + \sum_{ij \in E} \kappa_{ij} (-a + \sum_{T: ij \in \partial T} z_T) + \sum_{i \in V} \eta_i \left(1 - \sum_{T: i \in T} z_T \right) \leq a. \end{aligned}$$

□

Lemma 4.7. *Let (\mathbf{z}, a) be an admissible solution of Linear Problem V. For each T let*

$$\psi_T(i) = \begin{cases} z_T & \text{if } i \in T, T \subset \bar{\mathcal{S}} \in \bar{\mathcal{S}} \\ 0 & \text{otherwise} \end{cases}$$

Then $\{\psi_T\}$ is a flat partition of unity subordinated to $\bar{\mathcal{S}}$ with a -variance.

Proof. Conditions (1), (2) and (5) of Optimization Problem IV follow directly from the definition of ψ_T .

Condition (3):

$$\sum_T \psi_T(i) = \sum_{T: i \in T} z_T = 1.$$

Condition (4):

$$\sum_T |\psi_T(i) - \psi_T(j)| = \sum_{T: ij \in \partial T} z_T \leq a.$$

□

Theorem 4.8. *The optimal solution of Linear Problem III is equal to the optimal solution of Linear Problem II.*

Proof. Linear Problem III is a relaxation of Linear Problem II, so we have the “ \geq ” inequality between optimal values.

Linear Problem II is dual to Linear Problem I, which is equivalent to Optimization Problem IV. By Lemma 4.7, the value of a in Linear Problem V bounds the optimal value of Optimization Problem IV from above. By Lemma 4.6, Linear Problem V is dual to Linear Problem III, which establishes the “ \leq ” inequality. □

4.7. Heawood graph. Linear Problem II has more variables than Linear Problem III but a lot fewer constraints. Usually it is easier to construct flows than to check exponentially many weighted isoperimetric inequalities. There are exceptions to this rule though.

The Heawood graph is the following 3-regular graph on 14 vertices with the property that the length of the shortest cycle (i.e. girth) is 6.

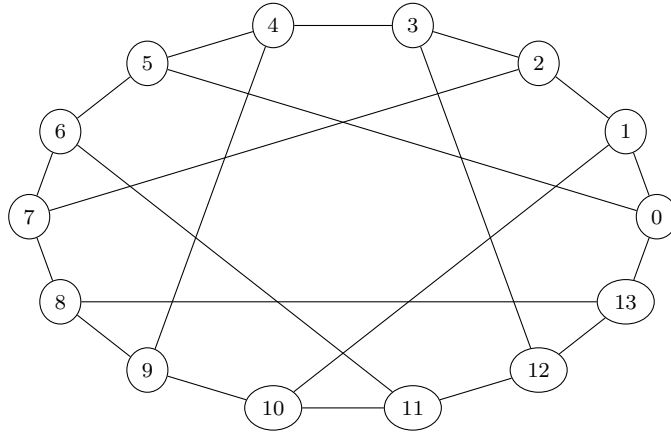

We will solve Linear Problem III for this graph at scale $S = 2$. Because of the symmetry of the graph it is reasonable to look for a solution with equal edge capacities and equal node demands (see Theorem 6.1). The graph has 21 edges and so we set $\kappa_{ij} = \frac{1}{21}$ for each $ij \in E$. Because the girth of the graph is 6 and the scale is 2, for each $T \subset S \subset \mathcal{S}$ the subgraph spanned by T is a disjoint union of trees. It is enough to check weighted isoperimetric inequalities for connected

subgraphs. A subtree with n vertices in a 3-regular graph has $n - 1$ inside edges and $3n - 2(n - 1) = n + 2$ edges on the boundary. Weighted isoperimetric inequalities are of the form

$$n \cdot \eta \leq (n + 2) \cdot \frac{1}{21}.$$

A 2-ball in the Heawood graph has 10 vertices so $n \leq 10$. Since $\eta \leq \frac{1}{21} + \frac{2}{21n}$, we have $\eta \leq \frac{1}{21} + \frac{2}{210} = \frac{2}{35}$. We get the following solution of Linear Problem III.

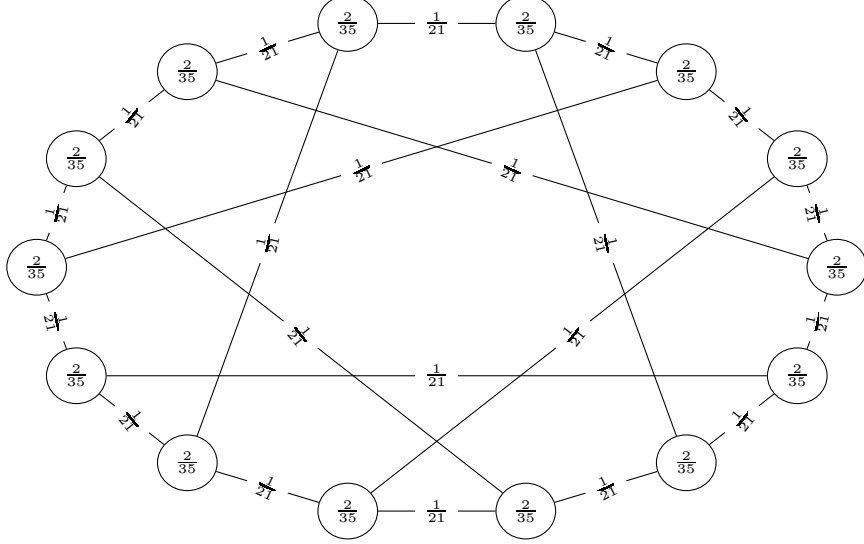

The optimal objective is $14 \cdot \frac{2}{35} = \frac{4}{5}$. The optimality of the solution may be verified by the observation that the solution of the primal problem with probability measures that are constant on their supports has $\varepsilon = \frac{4}{5}$.

5. LIFT AND PROJECT

We let F denote the set of admissible solutions of Linear Problem II for a graph $G = (V, E)$ at dual scale $\bar{\mathcal{S}}$, i.e. we let

$$F = \left\{ (\eta, \kappa, \varphi) \in \mathbb{R}^n \times \mathbb{R}^m \times \mathbb{R}^l : \begin{array}{l} \sum_{ij \in E} \kappa_{ij} \leq 1 \\ \forall_{ij \in E} \quad -\kappa_{ij} \leq \varphi_{k,ij} \leq \kappa_{ij} \\ \forall_{k \in V, i \in \bar{\mathcal{S}}_k} \quad \sigma_{k,i} \geq \eta_i \end{array} \right\}$$

where

$$\sigma_{k,i} = \sum_{m \in V: mi \in E} \varphi_{k,mi} - \sum_{m \in V: im \in E} \varphi_{k,im}$$

and $n = |V|$, $m = |E|$, $l = |V| \cdot |E|$. For $k \in V$ we let the flow $\varphi_k: E \rightarrow \mathbb{R}$ be defined on all of E even though only the values on $E[\bar{\mathcal{S}}_k, V]$ are relevant.

We let K denote the set of admissible solutions of Linear Problem III, i.e. we let

$$K = \left\{ (\eta, \kappa) \in \mathbb{R}^n \times \mathbb{R}^m : \begin{array}{l} \sum_{ij \in E} \kappa_{ij} \leq 1 \\ \forall_{T \subset \bar{\mathcal{S}}} \quad \sum_{i \in T} \eta_i \leq \sum_{ij \in \partial T} \kappa_{ij} \\ \forall_{ij \in E} \quad \kappa_{ij} \geq 0 \end{array} \right\}.$$

In the previous section we proved that the maximal value of $\sum_{i \in V} \eta_i$ is equal on K and F . In the present section we show that in fact F is a lift of K .

Theorem 5.1. *The projection*

$$\pi: \mathbb{R}^n \times \mathbb{R}^m \times \mathbb{R}^l \rightarrow \mathbb{R}^n \times \mathbb{R}^m$$

maps F onto K , i.e. for each η and κ that satisfy weighted isoperimetric inequalities there exists a family of flows φ_κ that satisfies demand η under capacity κ .

Proof. Let $(\eta, \kappa) \in K$. We will show that for each $k \in V$ there exists a flow $\varphi_k: E \rightarrow \mathbb{R}$ such that

$$\forall_{ij \in E} -\kappa_{ij} \leq \varphi_{k,ij} \leq \kappa_{ij}$$

and

$$\forall_{i \in \bar{S}_k} \sigma_{k,i} \geq \eta_i.$$

Consider

$$\Phi = \{\varphi: E \rightarrow \mathbb{R}: \forall_{ij \in E} -\kappa_{ij} \leq \varphi_{ij} \leq \kappa_{ij}\}.$$

Clearly, Φ is a compact subset of \mathbb{R}^m .

Fix $k \in V$. There exists $\varphi \in \Phi$ such that the value of

$$(*) \quad \sum_{i \in \bar{S}_k} \max \left\{ 0, \eta_i - \left(\sum_{m \in V: mi \in E} \varphi_{mi} - \sum_{m \in V: im \in E} \varphi_{im} \right) \right\}$$

is minimal. If the value of the sum (*) is 0, then we put $\varphi_k = \varphi$ and we are done. Assume therefore that the value of the sum (*) is positive.

For each $i \in V$ we let

$$\sigma_i = \sum_{m \in V: mi \in E} \varphi_{mi} - \sum_{m \in V: im \in E} \varphi_{im}$$

be the supply of the pseudo-flow φ at node i .

Let $T \subset V$ and let $i_0 \in T$. Let $j \in V$, $j \neq i_0$ (j may be outside of T). We say that the flow from j to i_0 is **not saturated** (in T) if there exists a sequence $i_0, i_1, i_2, \dots, i_k = j$, such that for each $0 \leq m < k$ we have $i_m \in T$ and either

$$i_m i_{m+1} \in E \text{ and } \varphi_{i_m i_{m+1}} > -\kappa_{i_m i_{m+1}}$$

or

$$i_{m+1} i_m \in E \text{ and } \varphi_{i_{m+1} i_m} < \kappa_{i_{m+1} i_m}.$$

Observe that if a flow from j to i_0 is not saturated, then there exist a $\delta > 0$ and a $\varphi' \in \Phi$ with supply $\sigma_{i_0} + \delta$ at i_0 , with supply $\sigma_j - \delta$ at j , and with all other supplies unchanged (we flow an additional δ along the path from j to i_0 and pick δ small enough such that the edge capacities are not exceeded).

Since the value of (*) is positive, there exists $i_0 \in \bar{S}_k$ such that $\sigma_{i_0} < \eta_{i_0}$. Let $T \subset \bar{S}_k$ be a set with maximal cardinality that satisfies the following conditions:

- (1) $i_0 \in T$ and
- (2) for each $j \in T$, $j \neq i_0$, the flow from j to i_0 is not saturated.

Let $j \in T$, $j \neq i_0$. If $\sigma_j > \eta_j$, then the flow φ' with supply $\sigma_{i_0} + \delta$ at i_0 and supply $\sigma_j - \delta$ at j (with other supplies unchanged) would have smaller value of (*) for small enough δ . Hence $\sigma_j \leq \eta_j$ for each $j \in T$. Therefore the total supply in T does not meet the total demand, i.e.

$$\sum_{i \in T} \sigma_i < \sum_{i \in T} \eta_i.$$

Since $T \subset \bar{S}_k \in \bar{\mathcal{S}}$, we have a weighted isoperimetric inequality for T , which combined with (1) and with the definition of σ_i gives

$$\sum_{ij \in E[V \setminus T, T]} \varphi_{ij} - \sum_{ij \in E[T, V \setminus T]} \varphi_{ij} = \sum_{i \in T} \sigma_i < \sum_{i \in T} \eta_i \leq \sum_{ij \in \partial T} \kappa_{ij}.$$

So there exists an edge $ij \in \partial T$ such that the flow along ij **into** T is not maximal.

Without any loss of generality we may assume that $i \in T$ and $j \notin T$. From the choice of ij , the flow from j to i_0 is not saturated in T . If $j \notin \bar{S}_k$, then we have no demand constraint for j and we may flow some $\delta > 0$ from j to i_0 , contradicting the

assumption that φ minimizes (*). If $j \in \bar{S}_k$, then the set $T \cup \{j\}$ satisfies conditions (1) and (2), contradicting the maximality of T . The contradiction shows that the value of (*) had to be 0. \square

6. AVERAGED SOLUTIONS

The set of optimal solutions of a linear problem is a convex polyhedron. Hence the center of mass of a set of optimal solutions is an optimal solution. In Linear Problem II, if we relabel the vertices of G using an automorphism, we get a new solution. If there is enough symmetry in the graph, this guarantees that we can find an optimal solution with equal edge capacities and/or equal node supplies.

In the following theorem, we do not require the automorphisms to preserve the orientation of G . Indeed, when $ij \in E$ then for the purposes of what follows, we may define κ_{ji} to be equal to κ_{ij} .

Theorem 6.1. *Let $G = (V, E)$ be a graph. Let Γ be a group that acts on G by automorphisms (here we allow orientation of edges to be reversed by an automorphism). Let $\{S_i \subset V : i \in V\}$ be a family of subsets of V that is invariant under the action of Γ , i.e.*

$$\gamma(S_i) = S_{\gamma(i)}$$

for each $\gamma \in \Gamma$ and $i \in V$.

If Γ acts transitively on the vertices of G , then there exists an optimal solution of Linear Problem III at scale \mathcal{S} such that $\eta_i = \eta_j$ for each $i, j \in V$.

If Γ acts transitively on the edges of G , then there exists an optimal solution of Linear Problem III at scale \mathcal{S} such that for each $ij \in E$, $\kappa_{ij} = \frac{1}{|E|}$.

If Γ acts transitively on both the edges and the vertices of G , then there exists an optimal solution such that $\eta_i = \eta_j$ for each $i, j \in V$ and $\kappa_{ij} = \frac{1}{|E|}$ for each $ij \in E$.

By Theorem 5.1, we can replace Linear Problem III by Linear Problem II in the statement of Theorem 6.1.

Proof. Let K be a set of admissible solutions of Linear Problem III (see Section 5). Let $(\eta, \kappa) \in K$ be an optimal solution. Without any loss of generality we may assume that $\sum_{ij \in E} \kappa_{ij} = 1$. For $\gamma \in \Gamma$, let

$$(\gamma.\eta, \gamma.\kappa) = (\eta \circ \gamma^{-1}, \kappa \circ (\gamma^{-1} \times \gamma^{-1}))$$

be a solution (η, γ) translated by the action of γ on G . Since $\gamma \times \gamma$ is a bijection on E , $\gamma.\kappa$ is well defined and

$$\sum_{ij \in E} (\gamma.\kappa)_{ij} = \sum_{ij \in E} \kappa_{\gamma^{-1}(i)\gamma^{-1}(j)} = \sum_{ij \in E} \kappa_{ij} = 1.$$

As we observed above, we do not require the orientation of the edges to be preserved. In the case that γ inverts the edge ij , we give κ_{ji} same value as κ_{ij} . Since γ is a bijection on V , we have

$$\sum_{i \in V} (\gamma.\eta)_i = \sum_{i \in V} \eta_{\gamma^{-1}(i)} = \sum_{i \in V} \eta_i.$$

Let $T \subset S_j \in \mathcal{S}$. Let $k = \gamma^{-1}(j)$. We have

$$\begin{aligned} \sum_{i \in T} (\gamma.\eta)_i &= \sum_{i \in T} \eta_{\gamma^{-1}(i)} = \sum_{i \in \gamma^{-1}(T)} \eta_i \leq \\ &\leq \sum_{im \in \partial \gamma^{-1}(T)} \kappa_{im} = \sum_{im \in \gamma^{-1}(\partial T)} \kappa_{im} = \sum_{im \in \partial T} \kappa_{\gamma^{-1}(im)} = \sum_{im \in \partial T} (\gamma.\kappa)_{im}. \end{aligned}$$

The inequality follows from the weighted isoperimetric inequality of the problem and the fact that $\gamma^{-1}(T) \subset \gamma^{-1}(S_j) = S_k$. Therefore $(\gamma.\eta, \gamma.\kappa) \in K$ and if (η, κ) is an optimal solution, then so is $(\gamma.\eta, \gamma.\kappa)$. Let

$$(\bar{\eta}, \bar{\kappa}) = \frac{1}{|\Gamma|} \sum_{\gamma \in \Gamma} (\gamma.\eta, \gamma.\kappa).$$

By the convexity of the set of optimal solutions, $(\bar{\eta}, \bar{\kappa})$ is an optimal solution.

Let $\Gamma.i$ denote the orbit of $i \in V$ under the action of Γ . If $j, k \in \Gamma.i$, then

$$\bar{\eta}_j = \frac{1}{|\Gamma.i|} \sum_{l \in \Gamma.i} \eta_l = \bar{\eta}_k,$$

because stabilizers of all vertices in $\Gamma.i$ under the action of Γ are of equal size. Hence $\bar{\eta}$ is constant on orbits of the action of Γ and if the action is transitive, then all values of $\bar{\eta}$ are equal.

Similarly, $\bar{\kappa}$ is constant on orbits of the action of Γ and if the action is transitive, then all values of $\bar{\kappa}$ are equal. Since $\sum_{i,j \in E} \bar{\kappa}_{ij} = 1$, in such case we have $\bar{\kappa}_{ij} = \frac{1}{|E|}$. \square

6.1. The circular ladder graph $\mathbb{Z}_2 \times \mathbb{Z}_7$. The symmetry of a graph can be exploited even if the action of the isometry group is not transitive. We will show this for the Cayley graph of the group $\mathbb{Z}_2 \times \mathbb{Z}_7$ with the standard generating set $\{(1, 0), (0, 1)\}$.

An optimal solution at scale $S = 1$ of Linear Problem III is shown below. The label on edge ij is its capacity κ_{ij} ; the label on vertex i is its demand η_i .

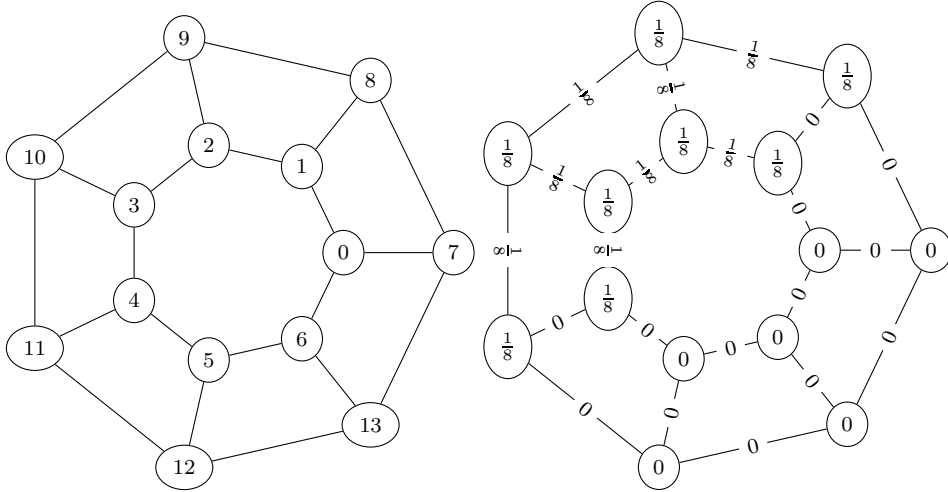

The objective value is $8 \cdot \frac{1}{8} = 1$, which is a basic solution found by the simplex method, i.e. a vertex of the polyhedron of optimal solutions. Hence it lacks symmetry. Using the symmetry of the graph we can find a simpler solution by hand.

The action of the isometry group is transitive on vertices, so we may put $\eta_i = \eta$ for each $i \in V$. The action of the isometry group on edges has two orbits. Hence we may find a solution of Linear Problem III with capacity (say) κ on edges corresponding to the $(1, 0)$ generator and capacity (say) λ on edges corresponding to the $(0, 1)$ generator.

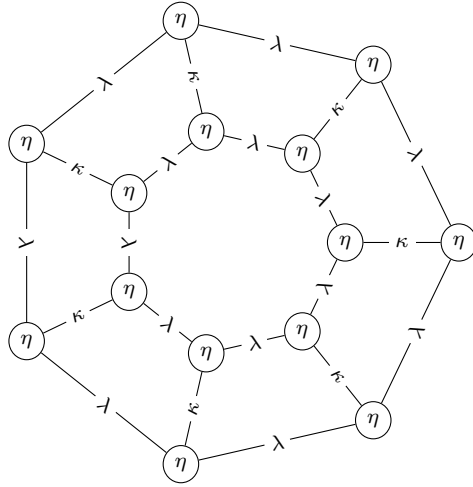

The capacity constraint is

$$14\lambda + 7\kappa \leq 1$$

and without any loss of generality we may put $\kappa = \frac{1}{7} - 2\lambda$. The weighted isoperimetric inequalities are

$$\begin{aligned} \eta &\leq 2\lambda + \kappa &= \frac{1}{7} \\ 2\eta &\leq 2\lambda + 2\kappa &= \frac{2}{7} - 2\lambda \\ 2\eta &\leq 4\lambda &= 4\lambda \\ 3\eta &\leq 4\lambda + \kappa &= \frac{1}{7} + 2\lambda \\ 4\eta &\leq 4\lambda + 2\kappa &= \frac{2}{7}. \end{aligned}$$

The inequalities correspond to different connected subsets of a ball of radius 1 in the graph and we omit duplicates. For $\lambda = \frac{2}{35}$ we have $\frac{1}{7} - \lambda = \frac{1}{21} + \frac{2}{3}\lambda \leq 2\lambda$. This gives an optimal bound $\eta = \frac{1}{14}$ and $\kappa = \frac{1}{35}$. The solution is the following.

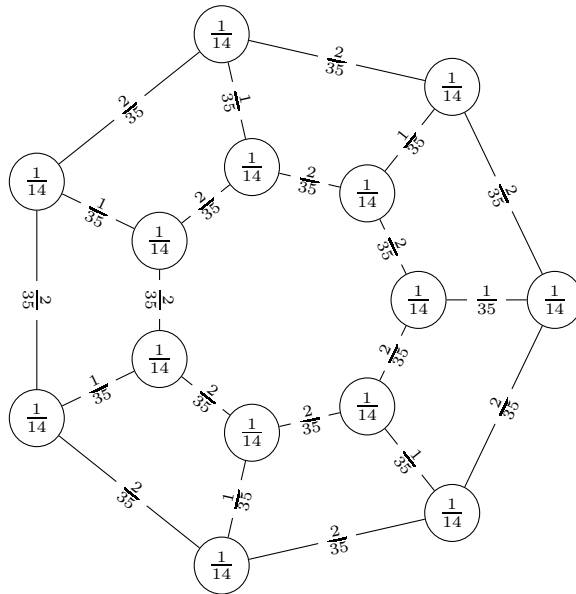

Again, the objective value is $14 \cdot \frac{1}{14} = 1$.

7. CHEEGER CONSTANT

The capacity κ and supply η are implicit in the solution of Optimization Problem II. If pseudo-flows φ_k are chosen, then the optimal values of κ and η can be easily determined. However a natural way to solve the problem is first to fix κ and η and then look for an optimal pseudo-flow family, as we did in many of the examples above. Choosing appropriate values for κ and η makes the problem hard to crack. To make it easier we can place additional constraints on Linear Problem II.

The main idea that is inspired by Theorem 6.1 is to set all capacities to $\kappa_{ij} = \frac{1}{|E|}$ and all supplies to $\eta_i = \eta$. We add these extra constraints to Linear Problem II to get Linear Problem VI.

Linear Problem VI. Uniform pseudo-flows at the dual scale $\bar{\mathcal{S}}$.

$$\begin{aligned}
& \text{maximize} && |V| \cdot \eta \\
& \text{subject to} && \\
& && \varphi_{ij,k} \leq \frac{1}{|E|} \text{ for each } ij \in E, k \in V, \\
& && -\varphi_{ij,k} \leq \frac{1}{|E|} \text{ for each } ij \in E, k \in V, \\
& && \sum_{j \in V, ji \in E} \varphi_{ji,k} - \sum_{j \in V, ij \in E} \varphi_{ij,k} \geq \eta \text{ for each } k \in V, i \in \bar{\mathcal{S}}_k, \\
& && \eta, \varphi_{ij,k} \in \mathbb{R}
\end{aligned}$$

The present section is devoted to the study of Linear Problem VI. We will show how it is related to the Cheeger constant of the graph. We also study the dual problem to Linear Problem VI, which is a relaxation of Linear Problem I. As a result, we find that the expanding property, which is used to show that a Cayley graph of a finitely generated group doesn't have property A, contradicts a property that is much weaker than property A.

7.1. Isoperimetric number and Cheeger constant. The Cheeger constant is a graph invariant defined as

$$\gamma(G) = \min \left\{ \frac{|\partial T|}{|T|} : T \subset V, T \neq \emptyset, |T| \leq \frac{|V|}{2} \right\}.$$

It is of great importance in many areas of mathematics [1]. Below we define its variant **at scale** \mathcal{S} , which is relevant to the contents of this paper.

Definition 7.1. Let \mathcal{S} be a scale on a graph G . We let

$$\gamma(G, \mathcal{S}) = \min \left\{ \frac{|\partial T|}{|T|} : T \subset S \in \mathcal{S}, T \neq \emptyset \right\}$$

be the **Cheeger constant of G at scale \mathcal{S}** . For $T \neq \emptyset, T \subset V$ we call

$$\varphi(T) = \frac{|\partial T|}{|T|}$$

the **isoperimetric number of T** .

Theorem 7.2. The optimal solution of Linear Problem VI at scale $\bar{\mathcal{S}}$ is equal to

$$\frac{|V|}{|E|} \gamma(G, \bar{\mathcal{S}}),$$

i.e. the Cheeger constant of G at scale \bar{S} multiplied by $\frac{|V|}{|E|}$.

Proof. By Theorem 5.1, we may project Linear Problem VI and replace the flows with weighted isoperimetric inequalities.

$$\begin{aligned} & \text{maximize} && |V| \cdot \eta \\ & \text{subject to} && \\ & && \sum_{i \in T} \eta \leq \sum_{ij \in \partial T} \frac{1}{|E|} \text{ for each } T \subset \bar{S} \in \bar{\mathcal{S}}, \\ & && \eta \in \mathbb{R} \end{aligned}$$

The optimal solutions of both problems are equal. The constraints of the projected problem are

$$\eta \leq \frac{|\partial T|}{|T||E|}$$

for each $T \subset \bar{S} \in \bar{\mathcal{S}}$. The maximal value of η is $\frac{\gamma(G, \bar{\mathcal{S}})}{|E|}$ so the maximal objective is indeed $\frac{|V|}{|E|} \gamma(G, \bar{\mathcal{S}})$. \square

The rest of the section is devoted to the study of Linear Problem VI in more depth. We will give an alternate proof of Theorem 7.2 as well as an interpretation of the dual problem to Linear Problem VI.

7.2. A single flow. To simplify, we rescale the flows by $|E|$ so that the capacity of each edge is 1 and we rescale the objective function by $\frac{1}{|V|}$ to η , instead of $|V| \cdot \eta$. The main reduction is to fix k and solve the problem for a single column, i.e. for a single set $S = S_k$. The reader is encouraged to use the supply table on page 12 as a reference. In the general case we compute the demand η_i to be the minimum of the supplies in the i th row of the table. Since we replaced each η_i with a single value η , our goal is to maximize the minimal supply in the entire table. Hence we may as well construct each flow φ_k in such a way that the minimal value of the supply in the k th column is maximal. This splits problem into independent problems that may be solved in each column separately.

Linear Problem VII. Minimal isoperimetric number over S .

$$\begin{aligned} & \text{maximize} && \eta \\ & \text{subject to} && \\ & && \varphi_{ij} \leq 1 \text{ for each } ij \in E, \\ & && -\varphi_{ij} \leq 1 \text{ for each } ij \in E, \\ & && \sum_{j \in V, ji \in E} \varphi_{ji} - \sum_{j \in V, ij \in E} \varphi_{ij} \geq \eta \text{ for each } i \in S, \\ & && \eta, \varphi_{ij} \in \mathbb{R} \end{aligned}$$

Once again, to understand the problem we pass to its dual.

Linear Problem VIII. The dual to minimal isoperimetric number over S .

$$\begin{aligned}
& \text{minimize} && \sum_{ij \in E} |a_i - a_j| \\
& \text{subject to} && \\
& && \sum_{i \in S} a_i = 1, \\
& && a_i = 0 \text{ for each } i \in V \setminus S, \\
& && a_i \geq 0 \text{ for each } i \in S
\end{aligned}$$

Theorem 7.3. *Linear Problem VIII is dual to Linear Problem VII.*

Proof. We derive the dual problem once again using the method from [10] (with some shortcuts).

$$\begin{aligned}
\eta &\leq \eta + \sum_{i \in S} a_i \left(\sum_{ji \in E} \varepsilon_{ji} - \sum_{ij \in E} \varepsilon_{ij} - \eta \right) + \sum_{ij \in E} b_{ij}^+ (1 - \varphi_{ij}) + \sum_{ij \in E} b_{ij}^- (1 + \varphi_{ij}) = \\
&\eta \left(1 - \sum_{i \in S} a_i \right) + \sum_{ij \in E} \varphi_{ij} (\delta_{j \in S} a_j - \delta_{i \in S} a_i - b_{ij}^+ + b_{ij}^-) + \sum_{ij \in E} b_{ij}^+ + b_{ij}^-
\end{aligned}$$

The inequality is true under the assumptions that

$$a_i \geq 0 \text{ and } b_{ij}^+, b_{ij}^- \geq 0.$$

Without any loss of generality we may assume that $b_{ij}^+ \cdot b_{ij}^- = 0$. Then we have

$$b_{ij} = b_{ij}^+ - b_{ij}^- \text{ and } |b_{ij}| = b_{ij}^+ + b_{ij}^-$$

and we have a bound on the right hand side

$$\eta \left(1 - \sum_{i \in S} a_i \right) + \sum_{ij \in E} \varphi_{ij} (\delta_{j \in S} a_j - \delta_{i \in S} a_i - b_{ij}) + \sum_{ij \in E} |b_{ij}| \leq \sum_{ij \in E} |b_{ij}|$$

under the constraints

$$\begin{aligned}
& \sum_{i \in S} a_i = 1 \\
& b_{ij} = \delta_{j \in S} a_j - \delta_{i \in S} a_i.
\end{aligned}$$

Therefore the dual problem may be rewritten as Linear Problem VIII. \square

To finish our argument we show that there always exists a simple optimal solution of Linear Problem VIII.

Theorem 7.4. *There exists an optimal solution of Linear Problem VIII with all non-zero values equal.*

Proof. Let

$$a = (a_i)_{i \in V} \in \mathbb{R}^V$$

be an admissible solution of linear problem VIII. We will show that if a is an optimal solution with maximal number of zeroes, then all non-zero values of a are equal.

Let

$$\max a = \max \{a_i : i \in S\}, \quad \min_{>0} a = \min \{a_i : i \in S, a_i > 0\}$$

and

$$U = \{i \in S : a_i = \max a\}, \quad L = \{i \in S : a_i = \min_{>0} a\}.$$

Both U and L are non-empty. If $\max a = \min_{>0} a$ (i.e. $U = L$), then we are done. Assume that $\max a > \min_{>0} a$.

Let $a'(\delta) \in \mathbb{R}^V$ be defined by the following formula.

$$a'_i(\delta) = \begin{cases} a_i + \frac{\delta}{|U|} & \text{for } i \in U \\ a_i - \frac{\delta}{|L|} & \text{for } i \in L \\ a_i & \text{otherwise} \end{cases}$$

Since S is finite, there exists $\Delta > 0$ such that the value of

$$\sum_{ij \in E} |a'_i - a'_j| - \sum_{ij \in E} |a_i - a_j|$$

is linear for $\delta \in [-\Delta, |L| \min_{>0} a]$. Since a is an optimal solution, the value has to be constant. But then, $a'(|L| \min_{>0} a)$ is an optimal solution with a larger number of zeroes.

Therefore if a is an optimal solution with maximal number of zeroes, then all non-zero values of a are equal to $\frac{1}{|\text{supp } a|}$. \square

Let a be an optimal solution of Linear Problem VIII with all non-zero values equal. Then $\sum_{ij \in E} |a_i - a_j|$ is equal to the isoperimetric number of $\text{supp } a \subset S$. Therefore

$$\text{optimal value} \geq \min_{T \subset S} \varphi(T).$$

On the other hand let $T \subset S$ with minimal $\varphi(T)$. Let

$$a_i = \frac{1}{|T|} \text{ for } i \in T \text{ and } a_i = 0 \text{ otherwise.}$$

We have

$$\text{optimal value} \leq \sum_{ij \in E} |a_i - a_j| = \frac{1}{|T|} \cdot |\partial T| = \varphi(T) = \min_{T \subset S} \varphi(T).$$

Therefore Linear Problem VIII is equivalent to Optimization Problem V.

Optimization Problem V. Minimal isoperimetric number over S .

Maximize η such that for each $T \subset S$ we have

$$\eta \leq \frac{|\partial T|}{|T|}.$$

The optimal solution of Linear Problem VI is equal to the minimum over S_k of the solutions of Linear Problems VII multiplied by $\frac{|V|}{|E|}$. Hence Linear Problem VI has optimal solution equal to $\frac{|V|}{|E|} \gamma(G, \mathcal{S})$, as we have already proven in Theorem 7.2.

7.3. Mean property A. It is very interesting to look at the dual problem to Linear Problem VI. Since Linear Problem VI is the dual problem to a linearization of property A with some extra added constraints, its dual will be a relaxation of a linearization of property A. We call this relaxation **mean property A**.

Linear Problem IX. Mean property A at scale S .

$$(1) \quad \begin{aligned} & \text{minimize} && \sum_{ij \in E, k \in V} c_{ij,k} \\ & \text{subject to} && \\ & && n_{i,j} = 0 \quad \text{for each } j \in V \setminus S_i, \\ & && \sum_{i \in V, j \in S_i} n_{i,j} = |V|, \\ & && n_{j,k} - n_{i,k} \leq c_{ij,k} \text{ for each } ij \in E, k \in V, \\ & && c_{ij,k}, n_{i,j} \geq 0 \end{aligned}$$

Lemma 7.5. *Linear Problem IX is dual to Linear Problem VI.*

Proof. We derive the dual problem once again using the method from [10] (with some shortcuts).

$$\begin{aligned}
|V| \cdot \eta &\leq |V| \cdot \eta + \sum_{ij \in E, k \in V} \left(\frac{1}{|E|} - \varphi_{ij,k} \right) c_{ij,k}^+ \sum_{ij \in E, k \in V} \left(\frac{1}{|E|} + \varphi_{ij,k} \right) c_{ij,k}^- + \\
&+ \sum_{i \in V, j \in S_i} \left(\sum_{k \in V, ki \in E} \varphi_{ki,j} - \sum_{k \in V, ik \in E} \varphi_{ik,j} - \eta \right) n_{i,j} = \frac{1}{|E|} \sum_{ij \in E, k \in V} (c_{ij,k}^+ + c_{ij,k}^-) + \\
&+ \eta \left(|V| - \sum_{i \in V, j \in S_i} n_{i,j} \right) + \sum_{ij \in E, k \in V} \varphi_{ij,k} (-c_{ij,k}^+ + c_{ij,k}^- + \delta_{k \in S_j} n_{j,k} - \delta_{k \in S_i} n_{i,k}) \leq \\
&\leq \frac{1}{|E|} \sum_{ij \in E, k \in V} (c_{ij,k}^+ + c_{ij,k}^-).
\end{aligned}$$

We substitute

$$\begin{aligned}
c_{ij,k} &= c_{ij,k}^+ - c_{ij,k}^-, \\
|c_{ij,k}| &= c_{ij,k}^+ + c_{ij,k}^-
\end{aligned}$$

and set

$$n_{i,k} = 0$$

for $k \in V \setminus S_i$.

This gives us a problem equivalent to the dual problem.

$$\begin{aligned}
&\text{minimize} && \sum_{ij \in E, k \in V} |c_{ij,k}| \\
&\text{subject to} && \\
(2) \quad &&& n_{i,j} = 0 \quad \text{for each } j \in V \setminus S_i, \\
&&& \sum_{i \in V, j \in S_i} n_{i,j} \geq |V|, \\
&&& n_{j,k} - n_{i,k} \leq c_{ij,k} \text{ for each } ij \in E, k \in V, \\
&&& c_{ij,k} \in \mathbb{R}, n_{i,j} \geq 0
\end{aligned}$$

Observe that we can always find an optimal solution with each $c_{ij,k} \geq 0$ and $\sum_{i,j \in V} n_{i,j} = |V|$. Therefore this problem is equivalent to Linear Problem IX. \square

Theorem 7.6. *Take a solution of Linear Problem IX and let*

$$\varphi_i(j) = n_{i,j}, \quad \varepsilon = \frac{1}{|E||V|} \sum_{ij \in E, k \in V} c_{ij,k}.$$

Then the following conditions are satisfied.

(1) $\{\varphi_i\}$ has norm 1 on average, i.e.

$$\frac{1}{|V|} \left\| \sum_{i \in V} \varphi_i \right\|_1 = 1.$$

(2) $\{\varphi_i\}$ has ε -variation on average, i.e.

$$\frac{1}{|E|} \sum_{ij \in E} \sum_{k \in V} |\varphi_i(k) - \varphi_j(k)| = \frac{1}{|E|} \sum_{ij \in E} \|\varphi_i - \varphi_j\|_1 \leq \varepsilon.$$

(3) $\text{supp } \varphi_i \subset S_i$ for each $i \in V$.

Note that if a graph has an isolated vertex i and $S_i = \{i\}$, then the optimal objective function value for this problem is clearly equal to 0. This shows that the invariant in general is not suitable for use in geometric group theory (at least as far as applications to the Novikov conjecture go).

The known examples of Cayley graphs of finitely generated groups that do not have property A contain expanding sequences of subgraphs with Cheeger constants bounded away from 0. Hence these are examples of graphs without mean property A. This shows that there is plenty of room for examples of graphs without property A that do not contain expanding subsequences.

7.4. Sparsest cut. Let $G = (V, E)$ be a graph with capacity function $\kappa: E \rightarrow \mathbb{R}$. The sparsity of a cut $(S, V \setminus S)$ in G equals

$$\phi(S) = \frac{\sum_{ij \in \partial S} \kappa_{ij}}{\min(|S|, |V \setminus S|)}.$$

The **sparsest cut** problem is to determine the value

$$\phi^*(\kappa) = \min \left\{ \frac{|\sum_{ij \in S} \kappa_{ij}|}{|S|} : S \subset V, S \neq \emptyset, |S| \leq \frac{|V|}{2} \right\}.$$

If $\kappa = \frac{1}{|E|}$, then $\phi^*(\kappa)$ is equal to the Cheeger constant.

Definition 7.7. Let $G = (V, E)$ be a graph with capacity function $\kappa: E \rightarrow \mathbb{R}$. Let \mathcal{S} be a scale on G . We let

$$\phi^*(\kappa, \mathcal{S}) = \min \left\{ \frac{|\sum_{ij \in T} \kappa_{ij}|}{|T|} : T \subset S \in \mathcal{S}, T \neq \emptyset \right\}$$

be the **sparsest cut** of G with capacity κ at scale \mathcal{S} .

Theorem 7.8. The optimal solution of Linear Problem II with uniform demands $\eta_i = \eta$ for each $i \in V$ is equal to

$$\frac{|V|}{|E|} \max \left\{ \phi^*(\kappa, \mathcal{S}) : \sum_{ij \in E} \kappa_{ij} \leq 1 \right\},$$

i.e. to the maximal sparsest cut value over all capacities with total capacity at most 1, rescaled by $\frac{|V|}{|E|}$.

The proof is very similar to the proof of Theorem 7.2 and is omitted.

7.5. Computational complexity. Computation of the Cheeger constant of a graph is NP-hard [11]. We observe that the Cheeger constant **at scale** \mathcal{S} is computable in polynomial time.

Theorem 7.9. Let G be a finite graph and let \mathcal{S} be a scale on G . The Cheeger constant of G at scale \mathcal{S} can be computed in polynomial time with respect to the size of G .

Proof. As shown in the proof of Theorem 7.2, the solution of the following linear problem

$$\begin{aligned} & \text{maximize} && |V| \cdot \eta \\ & \text{subject to} && \\ & && \sum_{i \in T} \eta \leq \sum_{ij \in \partial T} \frac{1}{|E|} \text{ for each } T \subset S \in \mathcal{S}, \\ & && \eta \in \mathbb{R} \end{aligned}$$

is equal to $\frac{|V|}{|E|}\gamma(G, \mathcal{S})$. This problem is equivalent to Linear Problem III with extra constraints

$$\begin{aligned}\eta_i &= \eta \text{ for each } i \in V, \\ \kappa_{ij} &= \frac{1}{|E|} \text{ for each } ij \in E.\end{aligned}$$

By Theorem 5.1, it this problem is equivalent to Linear Problem II with these extra constraints.

The size of Linear Problem II is polynomial in the size of G (regardless of the choice of \mathcal{S}) and so is the number of extra constraints. The size of the coefficients depends only on $|E|$. Therefore the problem can be solved in time that is polynomial with respect to the size of G . \square

A similar argument may be used to show that the other optimization problems at scale \mathcal{S} that are discussed in this paper (i.e. property A and sparsest cut) are also polynomial.

The polynomial complexity of the Cheeger constant at scale \mathcal{S} depends on the fact that we compute the minimum of $\frac{|\partial T|}{|T|}$ over a family of sets $\{T\}$ that has a polynomial set of maximal elements (with respect to inclusion \subset). This is not the case when we consider the family $\{T: |T| \leq \frac{|V|}{2}\}$ and we cannot compute the Cheeger constant of the graph in polynomial time this way.

8. THE CUBE GRAPH - $\mathbb{Z}_2 \times \mathbb{Z}_2 \times \cdots \times \mathbb{Z}_2$

Let Q_n be the graph with vertex set $\{0, 1\}^n$ and Hamming distance between vertices, i.e.

$$d(u, v) = |\{i: 1 \leq i \leq n, u_i \neq v_i\}|.$$

Two vertices are connected by an edge iff they differ at exactly one coordinate. We call Q_n the **n -dimensional hypercube** graph. It is a Cayley graph of

$$\underbrace{\mathbb{Z}_2 \times \mathbb{Z}_2 \times \cdots \times \mathbb{Z}_2}_{n \text{ times}}$$

taken with the standard generating set.

We have already computed $\varepsilon_{1, Q_2} = \frac{2}{3}$ and $\varepsilon_{2, Q_3} = \frac{2}{7}$. Presently we give the general solution.

Theorem 8.1. *Let Q_n be the n -dimensional hypercube graph. The minimal variation of probability measures for Q_n at scale $S \geq 0$ is*

$$\varepsilon_{S, Q_n} = \frac{2 \binom{n-1}{S}}{\sum_{k=0}^S \binom{n}{k}}.$$

As an application we prove the following theorem of P. Nowak.

Corollary 8.2 (P. Nowak, [12]). *The disjoint union*

$$\coprod_{n \in \mathbb{N}} \{0, 1\}^n$$

with ℓ_1 metric does not have property A.

Proof. The space $\coprod_{n \in \mathbb{N}} \{0, 1\}^n$ with ℓ_1 metric is isometric to the disjoint union $G = \coprod_{n \in \mathbb{N}} Q_n$ of hypercube graphs. We let

$$G_n = \coprod_{m=1}^n Q_m.$$

By Theorem 8.1, we have

$$\varepsilon_{S, G_n} = \max_{1 \leq m \leq n} \frac{2^{\binom{m-1}{S}}}{\sum_{k=0}^S \binom{m}{k}}.$$

For each $S \geq 0$ we have

$$\limsup_{n \rightarrow \infty} \varepsilon_{S, G_n} \geq \lim_{n \rightarrow \infty} \frac{2^{\binom{n-1}{S}}}{\sum_{k=0}^S \binom{n}{k}} = 2.$$

Each of the graphs G_n is a convex finite subset of G and G is locally finite. By Theorem 2.4, G does not have property A. \square

We prove Theorem 8.1 by providing solutions of Optimization Problem I (primal) and Optimization Problem II (dual) with equal objective values.

8.1. Primal solution. Let $Q_n = (V, E)$. We have $V = \{0, 1\}^n$ and E is a set of pairs of points of V with Hamming distance 1. The edges are oriented so that the vertex with smaller norm is connected to the vertex with larger norm. We have

$$|V| = 2^n, \quad |E| = n2^{n-1}.$$

Let

$$B(i, r) = \{j \in V : \|i - j\|_1 \leq r\}, \quad S(i, r) = \{j \in V : \|i - j\|_1 = r\}.$$

We have

$$|B(i, r)| = \sum_{k=0}^r \binom{n}{k}, \quad |S(i, r)| = \binom{n}{r}.$$

The scale on Q_n is

$$\mathcal{S} = \{S_i = S(i, S) : i \in V\}.$$

As a solution of Optimization Problem I, we let

$$\xi_i = \frac{\chi_{B(i, S)}}{\|\chi_{B(i, S)}\|_1} = \frac{1}{\sum_{k=0}^S \binom{n}{k}} \chi_{S_i},$$

where $\chi_A : V \rightarrow \mathbb{R}$ is a characteristic function of a set $A \subset V$. Then for $ij \in E$ we have

$$|(S_i \cup S_j) \setminus (S_i \cap S_j)| = 2^{\binom{n-1}{S}}.$$

Therefore

$$\|\xi_i - \xi_j\|_1 = \frac{2^{\binom{n-1}{S}}}{\sum_{k=0}^S \binom{n}{k}}$$

and

$$\varepsilon = \frac{2^{\binom{n-1}{S}}}{\sum_{k=0}^S \binom{n}{k}}.$$

8.2. Dual solution. The idea of the construction is very simple: we flow the maximum amount through the boundary ∂S_j of $S_j \in \mathcal{S}$ and then spread the amount evenly among all nodes of S_j . We have to verify that there is enough capacity to carry this out.

We set equal capacities on edges

$$\kappa_{ij} = \frac{1}{|E|} = \frac{1}{n2^{n-1}}, \quad \text{for each } ij \in E.$$

We will construct a pseudo-flow for $j \in V$ on S_j with supplies

$$\sigma_{j,i} = \frac{\binom{n}{S+1}(S+1)}{n2^{n-1} \sum_{l=0}^S \binom{n}{l}}.$$

These values do not depend on j as the construction is analogous at each vertex. To fix edge orientation we will describe it for $j = 000 \dots 0$.

Consider spheres of radius m and $m + 1$ centered at j .

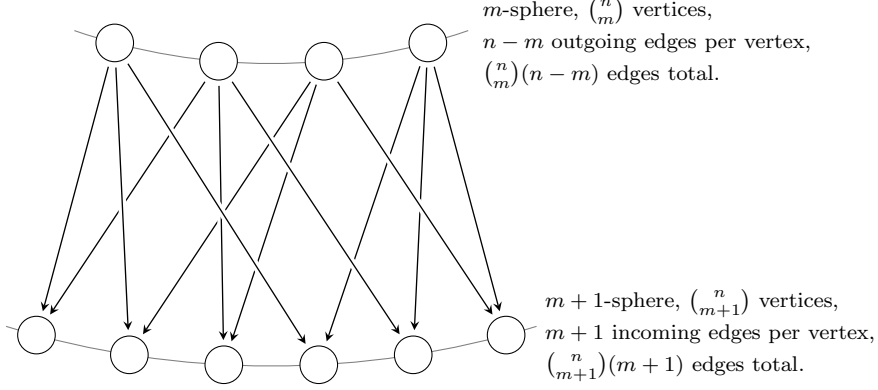

We have

$$\binom{n}{m}(n - m) = \binom{n}{m+1}(m + 1)$$

edges connecting vertices of the m -sphere to vertices of the $m + 1$ -sphere. We set the pseudo-flow on outgoing edges from the S -sphere to maximal capacity

$$\varphi_{j,ik} = -\frac{1}{|E|}, \text{ for each } i, k \in V, \|i - j\|_1 = S, \|k - j\|_1 = S + 1.$$

This transfers

$$\binom{n}{S+1}(S+1)\frac{1}{|E|} = \binom{n}{S+1}\frac{S+1}{n2^{n-1}}$$

total weight into S_j . The flows on the inside edges will transfer supply internally and will not change the total supply. Our goal is to redistribute supply equally among all vertices of S_j , giving the values of $\sigma_{j,i}$ specified above.

To distribute the supply equally we need to transfer

$$\frac{\binom{n}{S+1}(S+1)}{n2^{n-1} \sum_{l=0}^S \binom{n}{l}} \sum_{k=0}^m \binom{n}{k}$$

of supply into an m -ball centered at j . This has to be done using $\binom{n}{m+1}(m+1)$ edges connecting m -sphere to $m + 1$ -sphere. We cannot exceed edge capacity and it is possible if and only if

$$\frac{\frac{\binom{n}{S+1}(S+1)}{n2^{n-1} \sum_{l=0}^S \binom{n}{l}} \sum_{k=0}^m \binom{n}{k}}{\binom{n}{m+1}(m+1)} \leq \frac{1}{n2^{n-1}}.$$

We can cancel $n2^{n-1}$ and rewrite the inequality as

$$\frac{\binom{n}{S+1}(S+1)}{\sum_{k=0}^S \binom{n}{k}} \leq \frac{\binom{n}{m+1}(m+1)}{\sum_{k=0}^m \binom{n}{k}}.$$

We have to prove that it is satisfied for each $m \leq S < n$. Let

$$w_m = \frac{\binom{n}{m+1}(m+1)}{\sum_{k=0}^m \binom{n}{k}}.$$

It is enough to prove that

$$w_{m+1} \leq w_m$$

for each $m < n$.

After canceling numerators we get the inequality

$$\frac{\sum_{k=0}^m \binom{n}{k}}{\sum_{k=0}^{m+1} \binom{n}{k}} \leq \frac{m+1}{n-m-1}$$

which is equivalent to (for $m+1 \leq n-m-1$, otherwise the inequality is trivial)

$$\sum_{k=0}^m \binom{n}{k} \leq \frac{m+1}{n-2m-2} \binom{n}{m+1}.$$

We have

$$\begin{aligned} \frac{\binom{n}{m} + \binom{n}{m-1} + \cdots}{\binom{n}{m+1}} &= \frac{m+1}{n-m} + \frac{(m+1)m}{(n-m)(n-m+1)} + \cdots \leq \\ &\leq \frac{m+1}{n-m} + \left(\frac{m+1}{n-m}\right)^2 + \cdots \leq \frac{m+1}{n-m} \cdot \frac{1}{1 - \frac{m+1}{n-m}} = \\ &= \frac{m+1}{n-2m-1} < \frac{m+1}{n-2m-2}, \end{aligned}$$

which is the desired inequality.

Therefore we have

$$\sigma_{j,i} = \frac{\binom{n}{S+1}(S+1)}{n2^{n-1} \sum_{l=0}^S \binom{n}{l}}$$

and

$$\eta_i = \min_{j \in S_i} \eta_{j,i} = \frac{\binom{n}{S+1}(S+1)}{n2^{n-1} \sum_{l=0}^S \binom{n}{l}}.$$

This gives a total demand

$$\sum_{i \in V} \eta_i = 2^n \frac{\binom{n}{S+1}(S+1)}{n2^{n-1} \sum_{l=0}^S \binom{n}{l}} = \frac{2\binom{n}{S+1}(S+1)}{n \sum_{l=0}^S \binom{n}{l}}.$$

Finally, we have

$$\frac{2\binom{n}{S+1}(S+1)}{n \sum_{l=0}^S \binom{n}{l}} = \frac{2\binom{n-1}{S}}{\sum_{k=0}^S \binom{n}{k}},$$

because $\binom{n}{S+1} \frac{S+1}{n} = \binom{n-1}{S}$.

8.3. Example $n = 3$, $S = 1$. A primal problem solution is obtained by setting

$$\xi_i = \frac{1}{4} \chi_{S_i}.$$

Then for each $ik \in E$

$$\|\xi_i - \xi_k\|_1 = 1$$

and the value of the objective function is $\varepsilon = 1$.

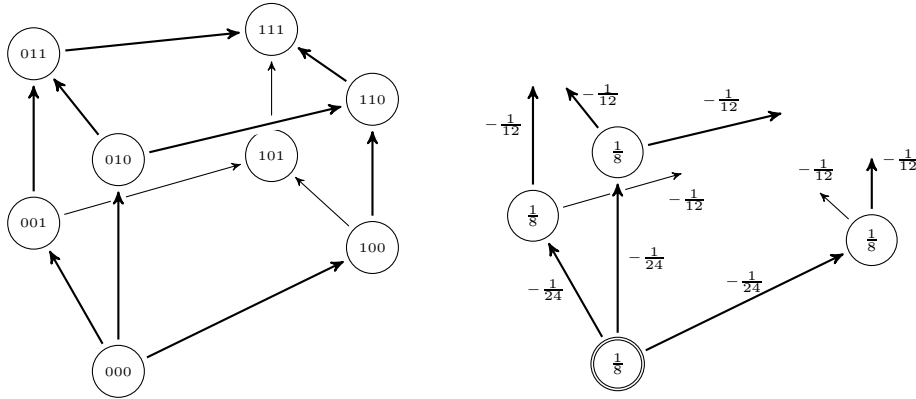

The pseudo-flow φ_{000} transfers equal amounts along the edges from the $(m+1)$ -sphere to the m -sphere with uniform supply.

$$\sigma_{000,000} = \sigma_{0001,001} = \sigma_{000,010} = \sigma_{000,001} = \frac{1}{8}.$$

By constructing analogous pseudo-flows at other vertices we show that $\eta_i = \frac{1}{8}$ for each i . This gives an objective value

$$\sum_{i \in V} \eta_i = 8 \cdot \frac{1}{8} = 1,$$

which proves that the primal solution found above is optimal.

9. REGULAR GRAPHS WITH LARGE GIRTH

There are 29503 connected simple graphs with 12 edges (up to isomorphism). For Linear Problem I at scale $S = 1$, the largest objective function value among these graphs is $\varepsilon = \frac{32}{29}$. This value is achieved by the following two graphs.

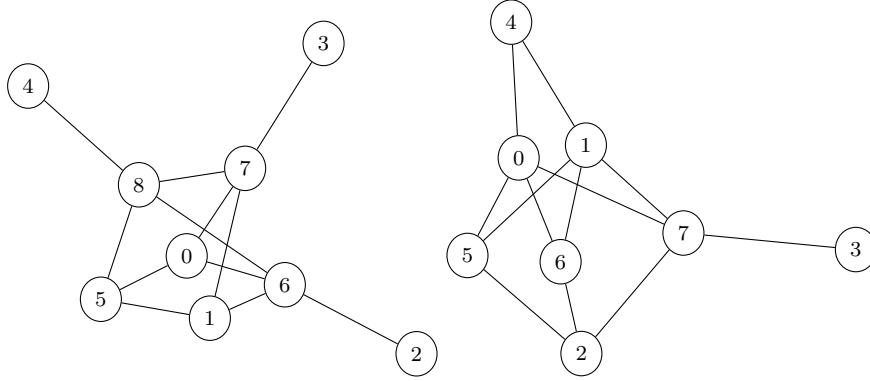

Note that both graphs have girth 4. We recall that the **girth** of a graph G is the length of a shortest cycle in G . The 1-balls in these graphs have no cycles. At scale $S = 2$, the largest objective function value is $\varepsilon = \frac{4}{7}$. There are several graphs with this value and two of these graphs are shown below.

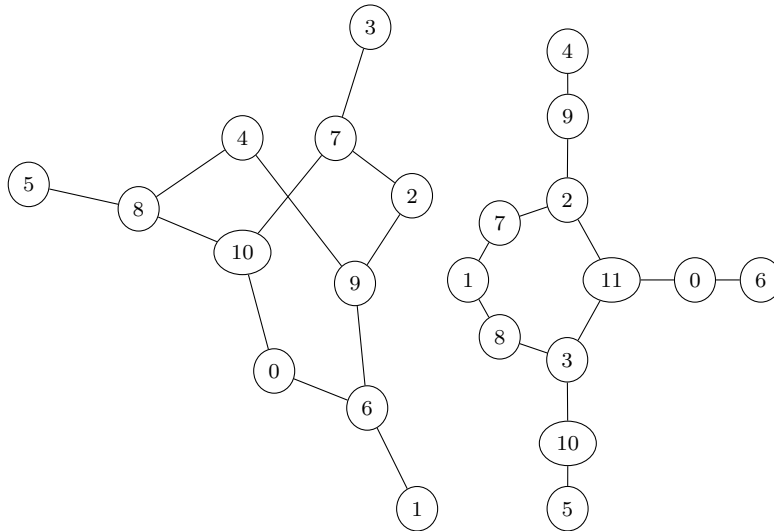

Other graphs with $\varepsilon = \frac{4}{7}$ are similar and all have girth 6. The 2-balls in these graphs have no cycles. It suggests that large girth implies large variation of probability measures and we show that it is indeed the case in the following theorem.

Theorem 9.1. *Let G be a d -regular graph with girth c . Let $S \geq 0$. If $d \geq 3$ and $2S + 1 < c$, then the minimal variation of probability measures for G at scale S is*

$$\varepsilon_{S,G} = \frac{2(d-1)^S(2-d)}{2-d(d-1)^S}.$$

Observe that the extremal graphs with 12 edges shown above are not d -regular. The Heawood graph is 3-regular with girth 6 and in Section 4.7 we computed $\varepsilon = \frac{4}{5}$ at scale $S = 2$ for this graph. It agrees with the value given in Theorem 9.1.

As an application we prove the following theorem of R. Willett (with slightly weaker assumptions in that we do not assume that sequence d_n is bounded).

Corollary 9.2 (R. Willett, [14]). *Suppose d_n is a sequence of integers with $d_n \geq 3$ and suppose c_n is a sequence of integers going to infinity. Let G_n be a d_n -regular graph with girth c_n . The disjoint union*

$$\coprod_{n \in \mathbb{N}} G_n$$

fails to have property A.

Proof. Fix $S \geq 0$. Let $N \in \mathbb{N}$ be such that for each $n \geq N$ we have $c_n > 2S + 1$. From Theorem 9.1, for each $n \geq N$, we have

$$\varepsilon_{S,G_n} = \frac{2(d_n-1)^S(2-d_n)}{2-d_n(d_n-1)^S}.$$

Graph $H_n = \coprod_{i=1}^n G_n$ is a finite convex subgraph of $\coprod_{n \in \mathbb{N}} G_n$. We have

$$\varepsilon_{S,H_n} \geq \max \left\{ \frac{2(d_i-1)^S(2-d_i)}{2-d_i(d_i-1)^S} : N \leq i \leq n \right\}.$$

If d_n is bounded, then there exists an increasing sequence i_1, i_2, i_3, \dots , with $i_n \geq N$, such that $d_{i_j} = d_{i_k}$ for each $j, k \in \mathbb{N}$. Then

$$\limsup_{n \rightarrow \infty} \varepsilon_{S,H_n} \geq \lim_{n \rightarrow \infty} \varepsilon_{S,H_{i_n}} \geq \frac{2(d-1)^S(2-d)}{2-d(d-1)^S},$$

for $d \geq 3$ that does not depend on S . Then

$$\lim_{S \rightarrow \infty} \limsup_{n \rightarrow \infty} \varepsilon_{S,H_n} \geq \lim_{S \rightarrow \infty} \frac{2(d-1)^S(2-d)}{2-d(d-1)^S} = 2 - \frac{4}{d} \geq 2 - \frac{4}{3} = \frac{2}{3}.$$

By Theorem 2.4, $\coprod_{n \in \mathbb{N}} G_n$ does not have property A.

If d_n is unbounded, then

$$\limsup_{n \rightarrow \infty} \varepsilon_{S,H_n} \geq \lim_{d \rightarrow \infty} \frac{2(d-1)^S(2-d)}{2-d(d-1)^S} = 2$$

and

$$\lim_{S \rightarrow \infty} \limsup_{n \rightarrow \infty} \varepsilon_{S,H_n} = 2.$$

By Theorem 2.4, $\coprod_{n \in \mathbb{N}} G_n$ does not have property A. \square

9.1. Cheeger constant of a regular graph with large girth. We will compute weighted isoperimetric inequalities for subsets of d -regular trees that do not contain leaves of the tree. This allows us to compute the Cheeger constant at scale S for the graph from Theorem 9.1 and obtain a lower bound on the value of $\varepsilon_{S,G}$.

Fix $d \geq 3$. Let $T = (V, E)$ be a d -regular tree of depth $S + 1$. Let r denote the root of T . Let $U \subset V$ such that $U \subset B(r, S)$ (U does not contain leaves of T). Let $n = |U|$. Assume that U has k connected components. Since T is d -regular, we have

$$|\partial U| = dn - 2(n - k)$$

Therefore

$$\varphi(U) = \frac{|\partial U|}{|U|} = \frac{(d-2)n + 2k}{n}.$$

We have

$$\min_U \varphi(U) = d - 2 + 2\frac{1}{n},$$

for $n = |B(r, S)| = \frac{2-d(d-1)^S}{2-d}$. Therefore

$$\min_{U \subset B(r, S)} \frac{|\partial U|}{|U|} = d - 2 + \frac{2(2-d)}{2-d(d-1)^S}$$

Let G be a d -regular graph with girth c and let $S \geq 0$ such that $2S + 1 < c$. Hence the Cheeger constant of G at scale S is equal to

$$\gamma(G, S) = d - 2 + \frac{2(2-d)}{2-d(d-1)^S} = (2-d)\left(\frac{2}{2-d(d-1)^S} - 1\right) = \frac{(2-d)d(d-1)^S}{2-d(d-1)^S}.$$

By Theorem 7.2, we have

$$\varepsilon_{S, G} \geq \frac{m}{\frac{dm}{2}} \frac{(2-d)d(d-1)^S}{2-d(d-1)^S} = \frac{2(2-d)(d-1)^S}{2-d(d-1)^S}.$$

9.2. The primal solution. Let $G = (V, E)$ be a d -regular graph with girth c . Let $|V| = n$. We have $|E| = \frac{nd}{2}$. For each $i \in V$ we have $S_i = B(i, S)$. Since G is d -regular and $2S + 1 < c$, we have

$$|S_i| = \frac{2-d(d-1)^S}{2-d} \text{ for each } i \in V$$

and

$$|(S_i \setminus S_j) \cup (S_j \setminus S_i)| = 2(d-1)^S \text{ for each } ij \in E.$$

To obtain the primal solution, set

$$\xi_i = \frac{\chi_{S_i}}{|S_i|}.$$

For each $ij \in E$ we have

$$\|\xi_i - \xi_j\|_1 = |(S_i \setminus S_j)| \frac{1}{|S_i|} + |(S_j \setminus S_i)| \frac{1}{|S_j|} = \frac{2(d-1)^S(2-d)}{2-d(d-1)^S}.$$

This shows that

$$\varepsilon_{S, G} \leq \frac{2(d-1)^S(2-d)}{2-d(d-1)^S},$$

which completes the proof of Theorem 9.1.

9.3. The curious case of infinite trees. At first glance, it appears that the argument above proves that infinite regular trees fail to have property A, which is false. We wish to explain why this argument does not prevent trees from having property A. We observe that in regular graphs with large girth, every vertex “looks like” the root of a regular tree and so for any ball B , one can estimate $|\partial B|/|B|$ as above. On the other hand, to apply our argument to an infinite tree, we have to restrict our attention to a finite portion of it, using Theorem 2.4. For a ball B around a vertex near the leaves of such a tree (see Figure 7), it is not possible to bound the ratio $|\partial B|/|B|$ away from 0.

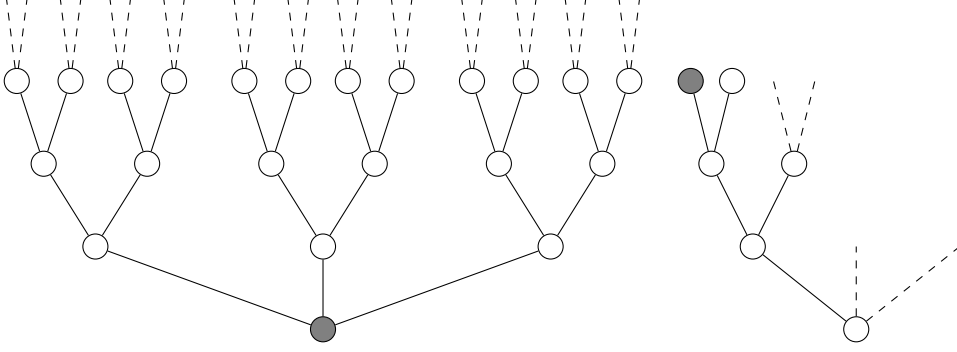

FIGURE 7. The ball of radius 3 based at the root of the subset S a tree (left) compared to a ball based at a leaf (right).

10. PROOF OF THEOREM 2.4

Lemma 10.1. *Let G be a (possibly infinite) graph. Let H be a convex finite subgraph of G . Let $S \geq 0$. We have*

$$\varepsilon_{2S,H} \leq \varepsilon_{S,G},$$

where $\varepsilon_{2S,H}$ and $\varepsilon_{S,G}$ are optimal solutions of Optimization Problem I for graphs H and G at scales $2S$ and S respectively.

Proof. First we observe that the weak duality part of Theorem 3.2 still holds even if the graph G is infinite since the sums in question are absolutely convergent.

Thus, if both $\varepsilon = \varepsilon_{S,G}$ and $\sum_{i \in V} \eta_i$ are optimal, then

$$\varepsilon_{S,G} \geq \sum_{i \in V} \eta_i.$$

Observe that the definition of Optimization Problem II may be extended so that the scale \mathcal{S} is an arbitrary family of subsets of the vertex set, not necessarily indexed by vertices of the underlying graph. (This is not the case for the primal problem, where we want to measure the variance of probability measures on adjacent vertices.)

Let $H = (V_H, E_H)$ and let $\mathcal{S}' = \{B_G(v, S) \cap V_H\}_{v \in V}$ be the scale S on G truncated to the subgraph H . Let $\eta': V_H \rightarrow \mathbb{R}, \kappa': E_H \rightarrow \mathbb{R}, \{\varphi'_i: E_H \rightarrow \mathbb{R}\}_{i \in V}$ be a solution of Optimization Problem II for the family \mathcal{S}' . We may extend η', κ', φ' to an admissible solution of Optimization Problem II for G at scale S , by setting all missing values to 0. This shows that

$$\sum_{i \in V} \eta_i \geq \sum_{i \in V} \eta'_i.$$

To finish the argument we appeal to the projection of Optimization Problem II to Linear Problem III (for the finite graph H). Clearly, Linear Problem III may be reformulated for an arbitrary family of subsets of V_H , not necessarily indexed by vertices of H . Optimization Problem II for H at scale \mathcal{S}' is equivalent to Linear Problem III for the family \mathcal{S}' . Clearly, if \mathcal{S}' refines \mathcal{S} , then the optimal solution of Linear Problem III for \mathcal{S}' will be greater than or equal to the solution of Optimization Problem II for \mathcal{S} (we have more constraints in the second case). If $\mathcal{S} = \{B_H(v, 2S)\}_{v \in V_H}$, then \mathcal{S}' refines \mathcal{S} (since H is a convex subgraph of G , the path-length metric on H is identical to the path-length metric restricted from G). Therefore

$$\sum_{i \in V} \eta'_i \geq \varepsilon_{2S,H}.$$

□

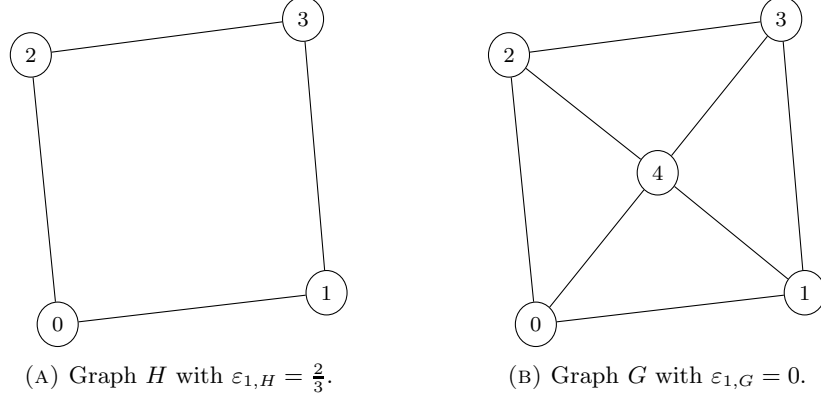

FIGURE 8. The increase of scale in subgraph H of graph G in Lemma 10.1 is necessary. Graph H is a convex subgraph of a graph G and it has larger ε value at scale $S = 1$. This is caused by the set $\{0, 1, 2, 3\}$ from the scale $S = 1$ on G restricted to H that is not in the scale $S = 1$ of H .

We are now ready to prove Theorem 2.4.

Theorem 2.4. *Let G be a countably infinite locally finite graph endowed with the path-length metric. Let $G_1 \subset G_2 \subset G_3 \subset \dots$ be an ascending sequence of convex finite subgraphs of G such that $G = \bigcup_{n \in \mathbb{N}} G_n$. Let ε_{S,G_n} be the minimal variation of probability measures at scale S for graph G_n , i.e. the optimal solution of Optimization Problem I for G_n at scale S . Graph G has property A iff*

$$\lim_{S \rightarrow \infty} \limsup_{n \rightarrow \infty} \varepsilon_{S,G_n} = 0.$$

Proof of Theorem 2.4. Let $G_n = (V_n, E_n)$. If G has property A, then

$$\lim_{S \rightarrow \infty} \varepsilon_{S,G} = 0$$

By Lemma 10.1, for each n we have

$$\varepsilon_{2S,G_n} \leq \varepsilon_{S,G}.$$

Hence

$$0 \leq \lim_{S \rightarrow \infty} \limsup_{n \rightarrow \infty} \varepsilon_{S,G_n} \leq \lim_{S \rightarrow \infty} \lim_{n \rightarrow \infty} \varepsilon_{S/2,G} = 0.$$

To prove the implication in the opposite direction, assume that

$$\lim_{S \rightarrow \infty} \limsup_{n \rightarrow \infty} \varepsilon_{S,G_n} = 0.$$

Let $\{\xi_i^n : V_n \rightarrow \mathbb{R}\}_{i \in V_n}$ be an optimal solution of Optimization Problem I for G_n at scale S . Using a standard diagonal argument we may pick a subsequence n_1, n_2, \dots such that for each $i, j \in V$ the limit

$$\xi_i(j) = \lim_{m \rightarrow \infty} \xi_i^{n_m}(j)$$

exists (the sequence may be undefined for small values of m).

- (1) $\xi_i(j) \geq 0$ since for large enough n (once $i, j \in V_n$) we have $\xi_i^n(j) \geq 0$.
- (2) $\text{supp } \xi_i \subset B(i, S)$ since for each $j \notin B(i, S)$ and large enough n we have $\xi_i^n(j) = 0$ (from convexity of G_n , we have $B_{G_n}(i, S) = B_G(i, S) \cap V_n$).

(3) Since $\text{supp } \xi_i$ is finite and $\text{supp } \xi_i^{n_m} \subset \text{supp } \xi_i$, we have

$$\|\xi_i\|_1 = \left\| \lim_{m \rightarrow \infty} \xi_i^{n_m} \right\|_1 = \lim_{m \rightarrow \infty} \|\xi_i^{n_m}\|_1 = 1,$$

for each $i \in V$.

(4) Similarly, for each $ij \in E$,

$$\|\xi_i - \xi_j\|_1 = \left\| \lim_{m \rightarrow \infty} \xi_i^{n_m} - \lim_{m \rightarrow \infty} \xi_j^{n_m} \right\|_1 = \lim_{m \rightarrow \infty} \|\xi_i^{n_m} - \xi_j^{n_m}\|_1 \leq \limsup_{m \rightarrow \infty} \varepsilon_{S, G_m}.$$

Therefore $\{\xi_i\}$ is a solution of Optimization Problem I for G at scale S with $\varepsilon_S = \limsup_{n \rightarrow \infty} \varepsilon_{S, G_n}$. By the assumption $\lim_{S \rightarrow \infty} \varepsilon_S = 0$, so G has property A. \square

REFERENCES

- [1] Sanjeev Arora, Satish Rao, and Umesh Vazirani. Expander flows, geometric embeddings and graph partitioning. *J. ACM*, 56(2):Art. 5, 37, 2009.
- [2] J. Brodzki, G. A. Niblo, and N. J. Wright. Property A, partial translation structures, and uniform embeddings in groups. *J. Lond. Math. Soc. (2)*, 76(2):479–497, 2007.
- [3] A. N. Dranishnikov. Asymptotic topology. *Uspekhi Mat. Nauk*, 55(6(336)):71–116, 2000.
- [4] A. N. Dranishnikov. Groups with a polynomial dimension growth. *Geom. Dedicata*, 119:1–15, 2006.
- [5] Steven C. Ferry, Andrew Ranicki, and Jonathan Rosenberg. A history and survey of the Novikov conjecture. In *Novikov conjectures, index theorems and rigidity, Vol. 1 (Oberwolfach, 1993)*, volume 226 of *London Math. Soc. Lecture Note Ser.*, pages 7–66. Cambridge Univ. Press, Cambridge, 1995.
- [6] M. Gromov. Random walk in random groups. *Geom. Funct. Anal.*, 13(1):73–146, 2003.
- [7] Erik Guentner. Permanence in coarse geometry. In *Recent progress in general topology. III*, pages 507–533. Atlantis Press, Paris, 2014.
- [8] Erik Guentner, Romain Tessera, and Guoliang Yu. A notion of geometric complexity and its application to topological rigidity. *Invent. Math.*, 189(2):315–357, 2012.
- [9] Nigel Higson and John Roe. Amenable group actions and the Novikov conjecture. *J. Reine Angew. Math.*, 519:143–153, 2000.
- [10] Sébastien Lahaie. How to take the dual of a linear program. <http://slahaie.net/docs/lpdual.pdf>. Accessed: 9 July 2021.
- [11] Tom Leighton and Satish Rao. Multicommodity max-flow min-cut theorems and their use in designing approximation algorithms. *J. ACM*, 46(6):787–832, 1999.
- [12] Piotr W. Nowak. Coarsely embeddable metric spaces without Property A. *J. Funct. Anal.*, 252(1):126–136, 2007.
- [13] Rufus Willett. Some notes on property A. In *Limits of graphs in group theory and computer science*, pages 191–281. EPFL Press, Lausanne, 2009.
- [14] Rufus Willett. Property A and graphs with large girth. *J. Topol. Anal.*, 3(3):377–384, 2011.
- [15] Guoliang Yu. The coarse Baum-Connes conjecture for spaces which admit a uniform embedding into Hilbert space. *Invent. Math.*, 139(1):201–240, 2000.

MATHEMATICS AND STATISTICS, UNC GREENSBORO, GREENSBORO, NC 27402 USA
Email address: gcbell@uncg.edu

DEPARTMENT OF MATHEMATICS, UNIVERSITY OF WARSAW, UL. STEFANA BANACHA 2, 02-097
 WARSZAWA, POLAND
Email address: amn@mimuw.edu.pl