

RIGIDITY AND SYMMETRY OF CYLINDRICAL HANDLEBODY-KNOTS

YI-SHENG WANG

ABSTRACT. A recent result of Funayoshi-Koda shows that a handlebody-knot of genus two has a finite symmetry group if and only if it is hyperbolic—the exterior admits a hyperbolic structure with totally geodesic boundary—or irreducible, atoroidal, cylindrical—the exterior contains no essential disks or tori but contains an essential annulus. Based on the Koda-Ozawa classification theorem, essential annuli in an irreducible, atoroidal handlebody-knots of genus two are classified into four classes: type 2, type 3-2, type 3-3 and type 4-1. We show that under mild conditions most genus two cylindrical handlebody-knot exteriors contain no essential disks or tori, and when a type 3-3 annulus exists, it is often unique up to isotopy; a classification result for symmetry groups of such cylindrical handlebody-knots is also obtained.

1. INTRODUCTION

By Thurston’s hyperbolization theorem, knots are classified into four categories: trivial, torus, satellite and hyperbolic knots, based on the existence of essential surfaces with non-negative Euler characteristics in knot exteriors. In particular, a torus knot is characterized by the existence of an essential annulus and absence of any essential disk or torus in its exterior. Furthermore, essential annuli in a torus knot exterior are all isotopic as shown in Tsau [31]. The uniqueness of essential annulus implies a classical result of Schreier [27] which states that torus knots are chiral and their symmetry groups are all isomorphic to \mathbb{Z}_2 as explained in Section 2.2.

A genus g handlebody-knot $(\mathbb{S}^3, \text{HK})$ is a genus g handlebody HK embedded in an oriented 3-sphere \mathbb{S}^3 ; the study of genus one handlebody-knots is equivalent to classical knot theory. The present work is concerned with genus two handlebody-knots, abbreviated to handlebody-knots hereafter, unless otherwise specified. As with the case of knots, by Thurston’s hyperbolization theorem, together with the equivariant torus theorem by Holzmann [12] and the fixed point theorem by Tollefson [30], handlebody-knots are classified into four classes:

- reducible
- irreducible, toroidal
- irreducible, atoroidal, cylindrical
- hyperbolic

A reducible handlebody-knot is a handlebody-knot whose exterior $E(\text{HK}) := \overline{\mathbb{S}^3 - \text{HK}}$ contains an essential disk—this should be contrasted with the trivial knot, whereas a cylindrical (resp. toroidal) handlebody-knot is characterized by the existence of an essential annulus (resp. torus) in its exterior. Particularly, irreducible, *toroidal* handlebody-knots correspond to satellite knots, and irreducible, atoroidal, *cylindrical* handlebody-knots to torus knots. A handlebody-knot is hyperbolic if its exterior admits a hyperbolic metric with totally geodesic boundary. In the present paper, we study *cylindrical* handlebody-knots and their symmetries.

Date: September 23, 2021.

2020 Mathematics Subject Classification. Primary 57K12; Secondary 57K30, 57M15, 57K10.

Key words and phrases. Symmetries, handlebody-knots, mapping class groups, essential surfaces.

The work was supported by National Center for Theoretical Sciences, Academia Sinica, and MOST (grant no. 110-2115-M-001-004-MY3), Taiwan.

Contrary to the case of knots, the existence of essential annulus (resp. essential torus) does not entail the non-existence of essential disks in a handlebody-knot exterior, and there are many reducible, cylindrical handlebody-knots (e.g. the handlebody-knot in Fig. 1.1). On the other hand, akin to the case of knots, irreducible, *toroidal*, *cylindrical* handlebody-knots, the analogue of cable knots, abound. This raises the following question.

Question 1.1. When is a cylindrical handlebody-knot $(\mathbb{S}^3, \text{HK})$ irreducible and atoroidal?

In contrast to a torus knot, an irreducible, atoroidal, cylindrical handlebody-knots may admit non-isotopic essential annuli in its exterior, for instance, handlebody-knots $4_1, 6_{10}$ in the Ishii-Kishimoto-Moriuchi-Suzuki handlebody-knot table [16], and handlebody-knots in Fig. 1.2 and Section 5.4; as we should see later, in some cases irreducible, atoroidal, cylindrical handlebody-knots behaves more like torus links. Nonetheless, the existence of an essential annulus does often impose strong constraints on the existence of other non-isotopic essential annuli as observed by Funayoshi-Koda [6]. This leads to the next question.

Question 1.2. When does an irreducible, atoroidal, cylindrical handlebody-knot $(\mathbb{S}^3, \text{HK})$ admit a unique essential annulus in its exterior, up to isotopy?

The uniqueness of essential annuli provides rigidity that allows us to compute the (positive) symmetry group of $(\mathbb{S}^3, \text{HK})$, and in many instances, it reduces the computation to studying spatial graph symmetries [29], [3], [21]. The symmetry group $\text{MCG}(\mathbb{S}^3, \text{HK})$ of $(\mathbb{S}^3, \text{HK})$ is defined as the group of components

$$\pi_0(\text{Homeo}(\mathbb{S}^3, \text{HK}))$$

of the topological group of self-homeomorphisms of \mathbb{S}^3 preserving HK setwise, whereas the positive symmetry group $\text{MCG}_+(\mathbb{S}^3, \text{HK})$ is the subgroup of $\text{MCG}(\mathbb{S}^3, \text{HK})$ given by the components of topological subgroup $\text{Homeo}_+(\mathbb{S}^3, \text{HK})$ of orientation-preserving homeomorphisms in $\text{Homeo}(\mathbb{S}^3, \text{HK})$. Note that when $(\mathbb{S}^3, \text{HK})$ is trivial—namely, $E(\text{HK})$ is a handlebody, $\text{MCG}(\mathbb{S}^3, \text{HK})$ is the genus two Goeritz group [7].

It follows from Funayoshi-Koda [6] that the symmetry group of a handlebody-knot is finite if and only if it is hyperbolic or irreducible, atoroidal, cylindrical (see also [32, Remark 2.1]). Some examples with a trivial symmetry group are computed by Koda [21] and the author [32], but apart from them, little is known about the structure of these finite groups, in contrast to finite symmetry groups of knots, which are cyclic or dihedral [19]. This leads to the following classification problem, which, together with Questions 1.1 and 1.2, is what the present study and its sequels seek to address.

Problem 1.1. Classify the structures of symmetry groups of irreducible, atoroidal, cylindrical handlebody-knots whose exterior contain a unique essential annulus, up to isotopy.

Based on the classification theorem by Koda-Ozawa [20], essential annuli in a handlebody-knot exterior are classified into seven types; as observed by Funayoshi-Koda [6, Lemma 3.2] only four types among the seven, that is, types 2, 3-2, 3-3 and 4-1, can exist in an irreducible, atoroidal handlebody-knot exterior. On the other hand, the existence of essential annuli of one of these four types does *not* imply the irreducibility and atoroidality in general.

These four types of essential annuli are characterized by their boundary in relation to the handlebody HK. A type 2 annulus A has exactly one component of ∂A bounds a disk in HK, while a type 3-2 (resp. type 3-3) annulus has parallel (resp. non-parallel) boundary components ∂A in ∂HK that bound no disk in HK, and there exists an essential disk $\mathcal{D} \subset \text{HK}$ disjoint from A . A type 4-1 annulus also has parallel ∂A in ∂HK , but no essential disk $\mathcal{D} \subset \text{HK}$ disjoint from A exists.

Let HK_A be the union of HK and a regular neighborhood $\mathfrak{N}(A)$ of A in $E(\text{HK})$. The case where HK_A is a handlebody is of particular interest, as the handlebody-knot $(\mathbb{S}^3, \text{HK}_A)$ is

often “simpler” than $(\mathbb{S}^3, \text{HK})$; in many cases, $(\mathbb{S}^3, \text{HK}_A)$ is in fact trivial, and we call A an *unknotting annulus*, following Koda [21], in such a situation.

Since the boundary components of a type 3-2 or type 4-1 annulus are parallel in ∂HK , HK_A is a handlebody only if A is of type 2 or type 3-3. Conversely, if A is of type 2, then HK_A is always a handlebody. The situation with type 3-3 annuli is slightly more involved. Given a handlebody-knot $(\mathbb{S}^3, \text{HK})$ and a type 3-3 annulus $A \subset E(\text{HK})$, by the definition, there exists an essential disk $\mathcal{D}_A \subset \text{HK}$ disjoint from A . The disk \mathcal{D}_A is necessarily separating and unique, up to isotopy, in HK (see Section 2.4). It separates HK into two solid tori W_1, W_2 ; each meets A at a component of ∂A . Let $l_i := \partial A \cap W_i$, $i = 1, 2$. Then we define the *slope pair* of A to be the unordered pair $\{r_1, r_2\}$ of rational numbers with r_i being the slope of $l_i \subset W_i$, $i = 1, 2$.

In Section 2, we show that the slope pair $\{r_1, r_2\}$ of A is either of the form $\{\frac{p}{q}, \frac{q}{p}\}$, $pq \neq 0$, or of the form $\{\frac{p}{q}, pq\}$, $q \neq 0$, where $p, q \in \mathbb{Z}$, and HK_A is a handlebody if and only if it is the latter. The present paper is concerned primarily with the case where A is of type 3-3 with a slope pair (p, p) , namely, $q = 1$, and $p \neq 0$. For the sake of simplicity, in this case we say A has a non-trivial boundary slope of p .

Question 1.1 is investigated in Section 4, where we deal with irreducibility and atoroidality separately, and consider general annuli as well as Möbius bands. To state the result, we note that $\mathfrak{R}(A) \cap \partial\text{HK}_A$ consists of two annuli A_+, A_- parallel to A in $E(\text{HK})$, and denote by l_+, l_- essential loops of A_+, A_- , respectively. Then as a corollary of Lemmas 4.3, 4.5, 4.7 and 4.8, we have the following application to type 3-3 annuli.

Theorem 1.1. *Let A be a type 3-3 annulus with a slope pair $\{\frac{p}{q}, pq\}$; if in addition $q = \pm 1$, we assume that $\partial A \subset \mathbb{S}^3$ is not a $(2m, 2n)$ -torus link with $|m|, n > 1$ and $mn = \pm p$. Suppose one of the following holds:*

- (1) $(\mathbb{S}^3, \text{HK}_A)$ is irreducible and atoroidal;
- (2) $(\mathbb{S}^3, \text{HK}_A)$ is trivial, $q = \pm 1$, and neither of l_+, l_- represents the $|p|$ -th power of some primitive element of $\pi_1(E(\text{HK}_A))$, up to conjugation.

Then $(\mathbb{S}^3, \text{HK})$ is irreducible and atoroidal.

We remark that the condition of ∂A being not a $(2m, 2n)$ -torus link, $|m|, n > 1$ is used to guarantee *atoroidality* when $(\mathbb{S}^3, \text{HK}_A)$ is irreducible, while it is there to ensure *irreducibility* when $(\mathbb{S}^3, \text{HK}_A)$ is trivial. The handlebody-knot $(\mathbb{S}^3, \text{HK})$ and type 3-3 annulus A in Fig. 1.1 is a reducible handlebody-knot with $(\mathbb{S}^3, \text{HK}_A)$ trivial. Note that $\partial A \subset \mathbb{S}^3$ is a $(6, 4)$ -torus link with $3 \cdot 2$ being the boundary slope of A . The handlebody-knot $(\mathbb{S}^3, \mathcal{T}_{\mu, \nu})$ in Fig. 4.2c with $\mu = \pm 1$ is another such example; in this case, one of l_+, l_- represents the $|p|$ -th power of some primitive element of $\pi_1(E(\text{HK}_A))$, up to conjugation, where p is the boundary slope of A .

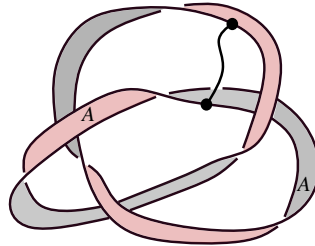

FIGURE 1.1. Reducible $(\mathbb{S}^3, \text{HK})$ with $(\mathbb{S}^3, \text{HK}_A)$ trivial.

In Section 4.2, we construct several families of handlebody-knots whose exterior admit a type 3-3 annulus, and use the criteria developed in Section 4.1 to examine their

irreducibility and atoroidality. Other methods for detecting irreducibility of a handlebody-knot are developed by Ishii-Kishimoto [15] using quandle invariant, and by Bellettini-Paolini-Wang [1] via homomorphisms on fundamental group, and by Okazaki [25] using Alexander polynomial.

The uniqueness problem (Question 1.2) is studied in Section 5 where attention is restricted to essential annuli with a non-trivial boundary slope of p . In general, it is not difficult to construct a handlebody-knot whose exterior contains two non-isotopic type 3-3 annuli. One way is to start with a $(2m, 2n)$ -torus link with $|m|, n > 1$ or a $(2m, 2n)$ -cable link with $n > 1$, and then choose an arc that connects the two components but does not intersect the two non-isotopic annuli in the link exterior. For instance, the exterior of each handlebody-knot in Fig. 1.2 contains two non-isotopic type 3-3 annuli. To verify the resulting handlebody-knot is irreducible and atoroidal, however, is often a harder undertaking. The irreducibility and atoroidality of the handlebody-knots in Fig. 1.2 are detected by a strengthening of Theorem 1.1 as explained in Section 4.2.3.

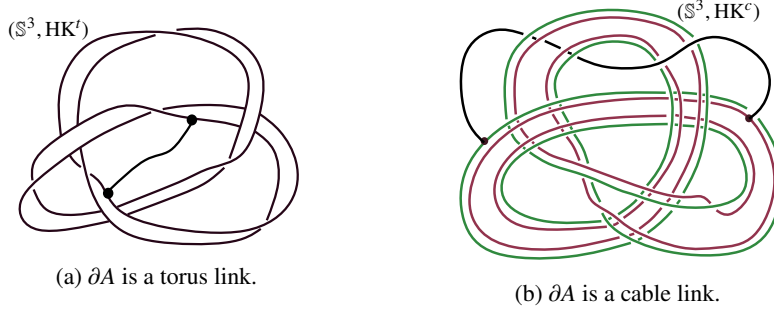

FIGURE 1.2. Handlebody-knot exteriors that admit non-isotopic type 3-3 annuli.

On the other hand, the condition of ∂A being not a $(2m, 2n)$ -torus link, $|m|, n > 1$, or a $(2m, 2n)$ -cable link, $n > 1$, with $mn = p$ turns out to suffice to entail the uniqueness of most type 3-3 essential annuli with a non-trivial boundary slope of p . Note that the condition is equivalent to saying that l_1, l_2 are not (m, n) -torus or (m, n) -cable knots in \mathbb{S}^3 with $mn = p$. Here by an (m, n) -torus knot, we understand a non-trivial torus knot, that is, with our convention, $|m|, n > 1$; similarly, an (m, n) -cable knot always means a non-trivial cabling, namely $n > 1$. We denote by $\dagger, \dagger\dagger$ the following conditions, respectively:

$$l_1, l_2 \text{ are not } (m, n)\text{-torus or } (m, n)\text{-cable knots in } \mathbb{S}^3 \text{ with } mn = p; \quad (\dagger)$$

$$l_1, l_2 \text{ are not } (m, n)\text{-torus knots in } \mathbb{S}^3 \text{ with } mn = p. \quad (\dagger\dagger)$$

As will be made clear in the proofs of Lemmas 3.13, 3.17, and 5.1, when A is unknotting, only the latter, weaker condition $(\dagger\dagger)$ is required owing to the classification of tunnel number one non-simple knots and links by Morimoto-Sakuma [23], Eudave-Muñoz-Uchida[5], respectively. Recall that a simple loop l in the boundary of a handlebody V is *primitive* if there exists a meridian disk $D \subset V$ such that $l \cap D$ is a point. The following summarizes Theorems 5.2 and 5.3.

Theorem 1.2. *Let $(\mathbb{S}^3, \text{HK})$ be an irreducible, atoroidal handlebody-knots and $A \subset E(\text{HK})$ a type 3-3 annulus with a non-trivial boundary slope of p . Suppose A satisfies the condition (\dagger) or the condition $(\dagger\dagger)$ if A is unknotting, and one of the following holds:*

- (1) $|p| = 1$;
- (2) $|p| > 1$, none of l_+, l_- represents the $|p|$ -th power of some element in $\pi_1(E(\text{HK}_A))$, up to conjugation, and if A is unknotting, at least one of $l_+, l_- \subset E(\text{HK}_A)$ is not primitive.

Then, up to isotopy, A is the unique type 3-3 annulus in $E(\text{HK})$.

Section 5.4 gives an irreducible, atoroidal handlebody-knot that fails the condition of l_+, l_- not representing the $|p|$ -th powers of some elements in $\pi_1(E(\text{HK}_A))$ and has two non-isotopic type 3-3 annuli in its exterior. On the other hand, the assumption that one of $l_+, l_- \subset E(\text{HK}_A)$ is not primitive can be dropped when $|p|$ is odd and greater than 1.

Theorem 1.3 (Theorem 5.6). *Let $(\mathbb{S}^3, \text{HK})$ be an irreducible, atoroidal handlebody-knot and $A \subset E(\text{HK})$ a type 3-3 annulus with a non-trivial boundary slope of $|p| > 1$ and p is odd. Suppose A is unknotting and satisfies the condition $(\dagger\dagger)$, and neither of l_+, l_- represents the $|p|$ -th multiple of some generator of $H_1(E(\text{HK}_A))$.*

Then, up to isotopy, A is the unique type 3-3 annulus in $E(\text{HK})$.

Lastly, Problem 1.1 is addressed in Section 6, where we obtain a classification theorem for symmetry groups of irreducible, atoroidal handlebody-knots whose exteriors contain a unique type 3-3 annulus A with a non-trivial boundary slope of p .

To state the classification result, we associate an order pair (p_1, p_2) to the annulus A , called the slope type of A . The pair (p_1, p_2) are characterized by the properties: $[l_+] = (p_1, p_2)$, $[l_-] = (p_1 - 1, p_2 + 1)$ in terms of a basis of $H_1(E(\text{HK}_A))$ induced by meridian disks of HK_A disjoint from \mathcal{D}_A , $p_1 > p_2$, and either $0 < p_1 \leq p$ or $p < p_1 \leq 0$, depending on the sign of p . We show in Section 3.1 the slope type is well-defined and depends only on A and $(\mathbb{S}^3, \text{HK})$.

Theorem 1.4. *Let $(\mathbb{S}^3, \text{HK})$ be an irreducible, atoroidal handlebody-knot whose exterior $E(\text{HK})$ contains a unique type 3-3 annulus A with a non-trivial slope of p . Then $\text{MCG}(\mathbb{S}^3, \text{HK}) = \text{MCG}_+(\mathbb{S}^3, \text{HK}) \leq \mathbb{Z}_2 \times \mathbb{Z}_2$. If in addition the slope type of A is not $(\frac{p+1}{2}, \frac{p-1}{2})$, then $\text{MCG}(\mathbb{S}^3, \text{HK}) = \text{MCG}_+(\mathbb{S}^3, \text{HK}) \leq \mathbb{Z}_2$.*

Sections 6.2 and 6.3 compute the symmetry groups of several families of handlebody-knots, showing that $\mathbb{Z}_2 \times \mathbb{Z}_2, \mathbb{Z}_2$ in Theorem 1.4 are optimal upper bounds, and the inequalities \leq 's there are in general not an isomorphism. As an application of Theorem 1.4, we obtain the symmetry group of $(\mathbb{S}^3, 5_2)$ and $(\mathbb{S}^3, 6_4)$ in the Ishii-Kishimoto-Moriuchi-Suzuki handlebody-knot table [16]:

$$\text{MCG}(\mathbb{S}^3, 5_2) \simeq \text{MCG}_+(\mathbb{S}^3, 5_2) \simeq \mathbb{Z}_2 \times \mathbb{Z}_2, \quad \text{MCG}(\mathbb{S}^3, 6_4) \simeq \text{MCG}_+(\mathbb{S}^3, 6_4) \simeq \mathbb{Z}_2.$$

Note that the symmetry groups of $(\mathbb{S}^3, 5_1)$ and $(\mathbb{S}^3, 6_1)$ are computed in Koda [21] using results from Motto [24], Lee-Lee [22], and they are $\text{MCG}(\mathbb{S}^3, 5_1) = \text{MCG}(\mathbb{S}^3, 6_1) = 1$. The symmetry groups of the rest handlebody-knots up to six crossings seem to remain unknown. In fact, there are still four handlebody-knots in the table whose chirality is yet to be determined as summarized in Ishii-Iwakiri-Jang-Oshiro [14, Table 2] (see also [24], [13], [22], [17]).

The paper is organized as follows: Section 2 fixes the notation and summarizes relevant known results. Section 3 discusses natural basis of $H_1(E(\text{HK}_A))$ and of $H_1(\partial E(\text{HK}_A))$ associated to a type 3-3 annulus A of a non-trivial slope, and examines the existence and non-existence of various types of disks in $E(\text{HK}_A)$ when A is unknotting. Results in Section 3 are crucial for our investigation on Questions 1.1 and 1.2 and Problem 1.1 in Sections 4, 5 and 6, respectively. We include many examples and counterexamples along the way, in hope that they can provide a more comprehensive picture of the topic and pave a way toward a complete classification for symmetry groups of irreducible, atoroidal, cylindrical handlebody-knots.

2. PRELIMINARIES

Throughout the paper we work in the piecewise linear category. Given a subpolyhedron X of M , $\overset{\circ}{X}$ denotes the interior of X , and $\mathfrak{R}(X)$ a regular neighborhood of X in M . The exterior $E(X)$ of X in M is the complement of $\overset{\circ}{\mathfrak{R}}(X; M)$ if X has codimension greater than

zero, and is the closure of $M - X$ otherwise. Submanifolds of a manifold M are proper and in general position except in some obvious cases where submanifolds are in ∂M . A surface in a three-manifold is essential if it is incompressible, ∂ -incompressible, and non-boundary parallel. We denote by (\mathbb{S}^3, X) an embedding of X in the oriented 3-sphere \mathbb{S}^3 . When X is a handlebody, an essential disk in X is called a *meridian* disk.

2.1. Mapping class group. Given subpolyhedra X_1, \dots, X_n of a manifold M , we denote by

$$\mathcal{H}omeo(M, X_1, \dots, X_n) \quad (2.1)$$

the space of self-homeomorphisms of M preserving $X_i, i = 1, \dots, n$, setwise, and by

$$\mathcal{M}CG(M, X_1, \dots, X_n) := \pi_0(\mathcal{H}omeo(M, X_1, \dots, X_n)) \quad (2.2)$$

the corresponding mapping class group. The “+” subscript is added when only orientation-preserving homeomorphisms are considered, for instance, the subspace

$$\mathcal{H}omeo_+(M, X_1, \dots, X_n)$$

of (2.1), and the subgroup $\mathcal{M}CG_+(M, X_1, \dots, X_n)$ of (2.2).

A meridian system \mathbf{D} of a handlebody H of genus 2 is a triplet $\{\mathcal{D}_1, \mathcal{D}_2, \mathcal{D}_3\}$ of disjoint, non-parallel, meridian disks in H . The exterior of $\cup \mathbf{D} := \cup_{i=1}^3 \mathcal{D}_i$ in H consists of two 3-balls, and \mathbf{D} determines a trivalent spine of H . In particular, given a handlebody-knot $(\mathbb{S}^3, \text{HK})$ and a meridian system \mathbf{D} of HK , then the induced spine is either a spatial θ -curve or handcuff graph. Given a spatial graph (\mathbb{S}^3, Γ) , $\text{TSG}(\mathbb{S}^3, \Gamma)$ denotes the topological symmetry group defined in [29], which is the image of $\mathcal{M}CG(\mathbb{S}^3, \Gamma)$ in $\mathcal{M}CG(\Gamma)$. For instance, if Γ is a handcuff graph, then $\text{TSG}(\mathbb{S}^3, \Gamma)$ is a subgroup of the dihedral group $D_4 \simeq \mathcal{M}CG(\Gamma)$.

The next two lemmas follow from the Alexander trick and [8], [9, Section 2], [10, Theorem 1] (see also [3, Section 2],[21, Section 2]).

Lemma 2.1. *Given a handlebody-knot $(\mathbb{S}^3, \text{HK})$, let \mathbf{D} be a meridian system of HK , and Γ the induced spatial graph. Then*

- *the natural homomorphisms*

$$\mathcal{M}CG(\mathbb{S}^3, \text{HK}, \cup \mathbf{D}) \rightarrow \mathcal{M}CG(\mathbb{S}^3, \text{HK}), \quad \mathcal{M}CG_+(\mathbb{S}^3, \text{HK}, \cup \mathbf{D}) \rightarrow \mathcal{M}CG_+(\mathbb{S}^3, \text{HK})$$

are injective;

- *the natural homomorphism given by the Alexander trick*

$$\mathcal{M}CG(\mathbb{S}^3, \text{HK}, \cup \mathbf{D}) \rightarrow \mathcal{M}CG(\mathbb{S}^3, \Gamma), \quad \mathcal{M}CG_+(\mathbb{S}^3, \text{HK}, \cup \mathbf{D}) \rightarrow \mathcal{M}CG_+(\mathbb{S}^3, \Gamma)$$

are isomorphisms.

Lemma 2.2. *Given a handlebody-knot $(\mathbb{S}^3, \text{HK})$ and an essential annulus A in $E(\text{HK})$, the natural homomorphisms*

$$\mathcal{M}CG(\mathbb{S}^3, \text{HK}, A) \rightarrow \mathcal{M}CG(\mathbb{S}^3, \text{HK}), \quad \mathcal{M}CG_+(\mathbb{S}^3, \text{HK}, A) \rightarrow \mathcal{M}CG_+(\mathbb{S}^3, \text{HK})$$

are injective.

As a direct consequence of [3, Theorems 2.5 and 3.2], we have the following Lemma.

Lemma 2.3. *If Γ is a handcuff spine of an irreducible atoroidal handlebody-knot, then $\mathcal{M}CG(\mathbb{S}^3, \Gamma) \simeq \text{TSG}(\mathbb{S}^3, \Gamma) < D_4$.*

2.2. Torus knot symmetry. We detour here to show that the symmetry group of a torus knot can be computed via the uniqueness of essential annuli in its exterior. The underlying idea reappears in the proof of Theorem 1.4; on the other hand, proving the uniqueness of essential annuli in a handlebody-knot exterior often requires more effort.

Let $(\mathbb{S}^3, \mathcal{K}_{p,q})$ be the torus knot given by $(\frac{1}{\sqrt{2}}e^{2\pi i p t}, \frac{1}{\sqrt{2}}e^{2\pi i q t}) \subset \mathbb{S}^3 \subset \mathbb{C}^2$, $t \in \mathbb{R}$, where the integers p, q are relatively prime with $|p|, q > 1$.

Theorem 2.4 ([27]). $MCG(\mathbb{S}^3, \mathcal{K}_{p,q}) \simeq MCG_+(\mathbb{S}^3, \mathcal{K}_{p,q}) \simeq \mathbb{Z}_2$.

Proof. Let A be an essential annulus in $E(\mathcal{K}_{p,q})$, and l an essential loop in A . A cuts $E(\mathcal{K}_{p,q})$ into two solid tori V, W . It may be assumed that l has a slope of $\frac{p}{q}$ (resp. $\frac{q}{p}$) in V (resp. W). Orient A, l and the cores l_v, l_w of V, W , respectively. By the uniqueness of the annulus A , we have the following isomorphisms:

$$MCG(\mathbb{S}^3, \mathcal{K}_{p,q}) \simeq MCG(\mathbb{S}^3, \mathfrak{N}(\mathcal{K}_{p,q}), A), \quad MCG_+(\mathbb{S}^3, \mathcal{K}_{p,q}) \simeq MCG_+(\mathbb{S}^3, \mathfrak{N}(\mathcal{K}_{p,q}), A).$$

Claim: no $f \in \text{Homeo}(\mathbb{S}^3, \mathfrak{N}(\mathcal{K}_{p,q}), A)$ swaps V, W .

If such an f exists, then $f(l)$ is isotopic to $\pm l$ in A and $f(l_v)$ isotopic to $\pm l_w$ in W . In particular, we have

$$p = \ell k(l, l_v) = \pm \ell k(l, l_w) = \pm q,$$

contradicting the assumption that p, q are coprime and not equal to ± 1 . In particular, the homomorphism

$$r : MCG_+(\mathbb{S}^3, \mathfrak{N}(\mathcal{K}_{p,q}), A) \rightarrow MCG(\mathring{A})$$

given by restriction has its image in $MCG_+(\mathring{A})$.

Claim: r is injective.

Suppose $f|_{\mathring{A}}$ is isotopic to the identity. Then f can be isotoped in $\text{Homeo}(\mathbb{S}^3, \mathfrak{N}(\mathcal{K}_{p,q}), A)$ so that it restricts to the identity on A . Let D be an oriented meridian disk of V , and observe that $f(D)$ is also a meridian disk of V since f does not swap V, W , and therefore $f(\partial D)$ has an infinite slope in V .

Let $B_v \subset V, B_w \subset W$ be the annuli cut off from $\partial \mathfrak{N}(\mathcal{K}_{p,q})$ by ∂A , and e_v, e_w two essential arcs in B_v, B_w , respectively. Suppose $f(e_v)$ is not isotopic to e_v in

$$\text{Homeo}_+(B_v, \text{rel } B_v).$$

Then $f|_{B_v}$ is isotopic in $\text{Homeo}_+(B_v, \text{rel } B_v)$ to the homeomorphism given by performing Dehn twist along an essential loop of B_v $k \neq 0$ times. This implies that $f(\partial D)$ has a slope of $\frac{kp+1}{kq} \in \mathbb{Q}$ in V , a contradiction. $f(e_v)$ being isotopic to e_v in B_v , relative to ∂B_v , implies that f can be isotoped in

$$\text{Homeo}_+(\mathbb{S}^3, \mathfrak{N}(\mathcal{K}_{p,q}), A)$$

so that $f|_{\partial V} = \text{id}$. Applying the same argument to e_w , we may assume $f|_{\partial W} = \text{id}$. Then, applying the Alexander trick twice, one can further isotope f in $\text{Homeo}_+(\mathbb{S}^3, \mathfrak{N}(\mathcal{K}_{p,q}), A)$ such that $f|_V = \text{id}, f|_W = \text{id}$, and hence f is isotopic to the identity in $\text{Homeo}_+(\mathbb{S}^3, \mathfrak{N}(\mathcal{K}_{p,q}), A)$. This proves the claim.

Now, consider the complex conjugation

$$\begin{aligned} J : \mathbb{C}^2 &\rightarrow \mathbb{C}^2 \\ (z_1, z_2) &\mapsto (\bar{z}_1, \bar{z}_2), \end{aligned}$$

and observe that J induces a non-trivial element g_J in $MCG(\mathbb{S}^3, \mathfrak{N}(\mathcal{K}_{p,q}), A)$ since g_J is sent to the generator of $MCG_+(\mathring{A})$, where the essential annulus A and the regular neighborhood $\mathfrak{N}(\mathcal{K}_{p,q})$ are identified with

$$A_\epsilon := \left\{ \left(\frac{1}{\sqrt{2}}e^{2\pi i p(t+s+\frac{1}{2q})}, \frac{1}{\sqrt{2}}e^{2\pi i q t} \right) \mid t \in \mathbb{R}, |s| \leq \epsilon \right\} \quad \text{and}$$

$$\mathfrak{N}_\epsilon^{\delta_0, \delta_1} := \left\{ \left(\sqrt{1-r}e^{2\pi i p(t+u)}, \sqrt{r}e^{2\pi i q t} \right) \mid t \in \mathbb{R}, |u| \leq \frac{1}{2pq} - \epsilon, \delta_0 \leq r \leq \delta_1 \right\}, \quad \text{respectively,}$$

for some $0 < \epsilon < \frac{1}{2pq}$ and $0 < \delta_0 < \frac{1}{2} < \delta_1 < 1$. This proves $MCG_+(\mathbb{S}^3, \mathcal{K}_{p,q}) \simeq \mathbb{Z}_2$.

Suppose $MCG(\mathbb{S}^3, \mathcal{K}_{p,q})$ is not isomorphic to $MCG_+(\mathbb{S}^3, \mathcal{K}_{p,q})$. Then there exists an orientation-reversing homeomorphism $f \in \text{Homeo}(\mathbb{S}^3, \mathfrak{R}(\mathcal{K}_{p,q}), A)$ such that $f|_A$ reverses the orientation of A but does not swap the two components of ∂A . This implies that $f(l)$ is isotopic to $-l$ in A , and since components of ∂A are not swapped, $f(\partial D)$ is isotopic to ∂D as an oriented loop, and therefore $f(l_v)$ is isotopic to $-l_v$. This implies

$$p = \ell k(l, l_v) = -\ell k(-l, -l_v) = -p$$

contradicting that $p \neq 0$. This completes the proof. \square

2.3. Annuli in a handlebody. We collect here some facts about annuli in a handlebody V of genus 2. Let A be an annulus in V , and note first the following lemma, a corollary of [2, Lemma 9], [11, Lemma 2.4].

Lemma 2.5. *If A is incompressible in V , then A is ∂ -compressible.*

Corollary 2.6. *If A is incompressible and separating, then A divides V into a solid torus W and a handlebody U of genus 2.*

Proof. Suppose A is boundary-parallel, and let W be the solid torus through which A is parallel to an annulus in ∂V . Then $U := V - \mathring{W}$, homeomorphic to V , is a handlebody of genus 2. Suppose A is non-boundary-parallel. Since A is incompressible, there exists a ∂ -compressing disk D of A by Lemma 2.5. The boundary of a regular neighborhood $\mathfrak{R}(D \cup A)$ of $D \cup A$ consists of a disk D' and an annulus A' parallel to A . As A is non-boundary-parallel and separating, D' is a separating essential disk in V , which cuts V into two solid tori V_1, V_2 , one of which, say V_1 , contains A . On the other hand, every incompressible annulus in a solid torus is boundary-parallel, so A cuts V_1 into two solid tori W, U_1 , through one of which, say U_1 , A is parallel to an annulus in ∂V_1 . A being non-boundary-parallel also implies $D' \subset \partial U_1 \cap \partial V_1$. Thus, the closures of the two components of $V - A$ are W and $U := V_2 \cup U_1$, respectively; the latter is a genus 2 handlebody. \square

The next two corollaries follow readily from the proof of Corollary 2.6.

Corollary 2.7. *If A is incompressible, separating, and non-boundary parallel, then there exists a separating essential disk disjoint from A .*

Corollary 2.8. *Suppose A is incompressible, separating and non-boundary-parallel, and $W \subset V$ is the solid torus cut off by A . Then the image of a generator of $\pi_1(W)$ under the homomorphism $\pi_1(W) \rightarrow \pi_1(V)$ induced by the inclusion is a primitive element, up to conjugation.*

2.4. Type 3-3 annulus. Given a handlebody-knot $(\mathbb{S}^3, \text{HK})$ and an annulus $A \subset E(\text{HK})$, we denote by l_1, l_2 the components of ∂A .

Definition 2.1. An annulus $A \subset E(\text{HK})$ is of type 3-3 if l_1, l_2 are not parallel in ∂HK , and do not bound disks in HK , and there exists a meridian disk $\mathcal{D} \subset \text{HK}$ disjoint from A .

Henceforth A denotes a type 3-3 annulus unless otherwise specified.

Lemma 2.9. *If $\mathcal{D} \subset \text{HK}$ is a meridian disk disjoint from $l_1 \cup l_2$, then \mathcal{D} is separating, and each component of $\text{HK} - \mathring{\mathfrak{R}}(\mathcal{D})$ meets A . Furthermore, any two such disks are isotopic in $\text{HK} - \partial A$.*

Proof. Suppose \mathcal{D} is non-separating. Then $W := \text{HK} - \mathring{\mathfrak{R}}(\mathcal{D})$ is a solid torus. Since l_1, l_2 do not bound disks in HK , l_1, l_2 are parallel, essential, non-meridional loops in W . $l_1 \cup l_2$ cuts ∂W into two annuli, each of which meets $\mathfrak{R}(\mathcal{D})$ since l_1, l_2 are not parallel in ∂HK . This, however, contradicts that $A \cap \text{HK} = \emptyset$ since A necessarily separates $E(W)$ into two components. Therefore $\text{HK} - \mathring{\mathfrak{R}}(\mathcal{D})$ consists of two solid tori, and both meet ∂A since l_1, l_2 are not parallel in ∂HK . The second assertion follows from [22, Lemma 2.3], given the properties of l_1, l_2 just proved. \square

Remark 2.1. By Lemma 2.9, it is not difficult to see that Definition 2.1 is equivalent to the definition in [20, Section 3] (see also [20, Theorem 3.3]).

Let $\mathcal{D}_A \subset \text{HK}$ be a meridian disk disjoint from A , and denote by W_1, W_2 the solid torus components of $\text{HK} - \mathfrak{R}(\mathcal{D}_A)$ with $l_i \subset W_i, i = 1, 2$, and by \mathcal{D}_i a meridian disk of $W_i, i = 1, 2$. By Lemma 2.9, the meridian system $\mathbf{D}_A := \{\mathcal{D}_A, \mathcal{D}_1, \mathcal{D}_2\}$ is determined, up to isotopy, by A , and \mathbf{D}_A induces a spatial handcuff graph Γ_A . If in addition A is unique, up to isotopy, then by Lemma 2.2,

$$\mathcal{MCG}_{(+)}(\mathbb{S}^3, \text{HK}, A) \rightarrow \mathcal{MCG}_{(+)}(\mathbb{S}^3, \text{HK})$$

is an isomorphism; moreover, since every $f \in \text{Homeo}(\mathbb{S}^3, \text{HK})$ can be isotoped to one that preserves $\cup \mathbf{D}_A$,

$$\mathcal{MCG}_{(+)}(\mathbb{S}^3, \text{HK}, \cup \mathbf{D}_A) \rightarrow \mathcal{MCG}_{(+)}(\mathbb{S}^3, \text{HK})$$

is also an isomorphism by Lemma 2.1. As a result, we have the following corollary of Lemma 2.3

Corollary 2.10. *If $(\mathbb{S}^3, \text{HK})$ is irreducible, atoroidal, and $A \subset E(\text{HK})$ is unique, up to isotopy, then*

$$\mathcal{MCG}_{(+)}(\mathbb{S}^3, \text{HK}, A) \simeq \mathcal{MCG}_{(+)}(\mathbb{S}^3, \text{HK}) \simeq \mathcal{MCG}_{(+)}(\mathbb{S}^3, \text{HK}, \cup \mathbf{D}_A) \leq D_4.$$

A finer upper bound than D_4 is given in Section 6.

Definition 2.2 (Slope Pair). The slope pair of A is an unordered pair $\{r_1, r_2\}$ with r_i the slope of $l_i \subset W_i, i = 1, 2$.

By Lemma 3.13, the slope pair of A is independent of the choice of \mathcal{D}_A .

Lemma 2.11. *If $\{r_1, r_2\}$ is the slope pair of A , then either $\{r_1, r_2\} = \{\frac{p}{q}, \frac{q}{p}\}$ with $pq \neq 0$, or $\{r_1, r_2\} = \{\frac{p}{q}, pq\}$ with $q \neq 0$, where $p, q \in \mathbb{Z}$.*

Proof. If both r_1, r_2 are not integers, then $M := W_1 \cup \mathfrak{R}(A) \cup W_2$ is a Seifert fiber space in \mathbb{S}^3 . In particular, M is the exterior of a (p, q) -torus knot, and $W_1 \cup W_2$ is a regular neighborhood of a Hopf link. Hence, we have $\{r_1, r_2\} = \{\frac{p}{q}, \frac{q}{p}\}$.

Suppose one of r_1, r_2 is integral, say r_2 , and let $r_1 = \frac{p}{q}$. Then $W_1 \cup \mathfrak{R}(A) \cup W_2$ is a solid torus, and l_2 has a slope of $\frac{p}{q}$ in the solid torus $W'_1 := W_1 \cup \mathfrak{R}(A)$. On the other hand, since $l_2 \subset W_2$ has an integral slope of r_2 , r_2 can be computed by the linking number of l_2 and any essential loop α in the annulus $\partial W_2 \cap \mathfrak{R}(A)$ disjoint from l_2 . Now, $\alpha \subset W'_1$ also has a slope of $\frac{p}{q}$, so $r_2 = pq$. \square

Let $\text{HK}_A := \mathfrak{R}(A) \cup \text{HK}$. Then the following can be derived from the preceding proof.

Corollary 2.12. *HK_A is a handlebody if and only if the slope pair of A is $\{\frac{p}{q}, pq\}$, $q \neq 0$, $p, q \in \mathbb{Z}$.*

Definition 2.3 (Boundary Slope). A is said to have a boundary slope of p if $q = 1$, namely, the slope pair being of the form (p, p) .

The paper focuses primarily on the case where A has a *non-trivial* boundary slope, that is, $q = 1, p \neq 0$.

3. DISKS

Throughout the section, $A \subset E(\text{HK})$ is a type 3-3 annulus with a non-trivial boundary slope of p . Unless otherwise specified, A is assumed to be oriented, and the components l_1, l_2 of ∂A are oriented so that $\partial A = l_1 \cup -l_2$. Let A_+, A_- be the components of $\mathfrak{R}(A) \cap \partial \text{HK}_A$ with the normal of A in $\mathfrak{R}(A)$ pointing toward A_+ ; A_\pm are annuli parallel to A in $E(\text{HK})$. Let l_\pm be essential loops in A_\pm , respectively, and orient l_\pm so that they represent the same homology class as l_1, l_2 in $H_1(\mathfrak{R}(A))$. Note that by the definition of type 3-3 annulus, l_\pm are non-separating, and hence essential, loops in ∂HK_A .

3.1. Intrinsic disks and basis. Recall that, by Lemma 2.9 there is a unique meridian disk $\mathcal{D}_A \subset \text{HK}$ separating l_1, l_2 ; \mathcal{D}_A induces a non-separating disk $D_A \subset \text{HK}_A$. Denote by W the complement $\text{HK}_A - \mathring{\mathfrak{R}}(D_A)$, and by $D_A^\pm \subset \partial W$ the disk components of $\partial W \cap \mathring{\mathfrak{R}}(D_A)$.

A meridian disk $D \subset \text{HK}_A$ associated to D_A is a non-separating disk disjoint from and non-parallel to D_A . Particularly, D can be viewed as a meridian disk of W . Orient D such that $\mathcal{I}([\partial D], [l_+]) = 1 = \mathcal{I}([\partial D], [l_-])$, where

$$\mathcal{I} : H_1(\partial \text{HK}_A) \times H_1(\partial \text{HK}_A) \rightarrow \mathbb{Z}$$

is the intersection form with the orientation of ∂HK_A given by the induced orientation of $\text{HK}_A \subset \mathbb{S}^3$. A disk system associated to D_A is a pair $\{D_1, D_2\}$ of disjoint, non-parallel meridian disks associated to D_A . We remark that, by the definition, D_1, D_2 separate D_A^\pm in ∂W , and induce a basis $\{[\partial D_1], [\partial D_2]\}$ of $H_1(E(\text{HK}_A))$.

Definition 3.1. A basis $\{a_1, a_2\}$ of $H_1(E(\text{HK}_A))$ is *meridional* if it is induced by a disk system associated to D_A .

The existence of a disk system is easy to check, It implies the existence of a meridional basis of $H_1(E(\text{HK}_A))$.

Lemma 3.1. Let $\{a_1, a_2\}$ be a meridional basis of $H_1(E(\text{HK}_A))$. Then $[l_+] - [l_-] \in H_1(E(\text{HK}_A))$ is $(1 - 1)$ or $(-1, 1)$ in terms of $\{a_1, a_2\}$. In addition, if $[l_+] = (q_1, q_2)$, then $q_1 + q_2 = p$.

Proof. Note first that l_\pm are parallel loops in ∂W with each component of $\partial W - (l_+ \cup l_-)$ containing one of D_A^+, D_A^- . In particular, one can orient D_A so that $[l_+] = [l_-] + [\partial D_A] \in H_1(E(\text{HK}_A))$. The first assertion then follows from the fact that $[\partial D_A]$ is either $a_1 - a_2$ or $a_2 - a_1$.

Now, consider the homomorphism

$$H_1(E(\text{HK}_A)) \rightarrow H_1(E(W)),$$

and observe that it sends both a_1, a_2 to a generator a of $H_1(E(W))$. Since A has a boundary slope of p , $[l_+] = pa \in H_1(E(W))$, and thus the second assertion. \square

For the next two lemmas, we fix a meridional basis $\{a_1, a_2\}$ of $H_1(E(\text{HK}_A))$ induced by a disk system $\{D_1, D_2\}$.

Lemma 3.2. If D is a meridian disk associated to D_A , then

$$[\partial D] = a_1 + n(a_2 - a_1), \quad \text{for some } n \in \mathbb{Z}.$$

Conversely, if $a'_1 = a_1 + n(a_2 - a_1)$, for some $n \in \mathbb{Z}$, then there exists a meridian disk D associated to D_A such that $a'_1 = [\partial D]$.

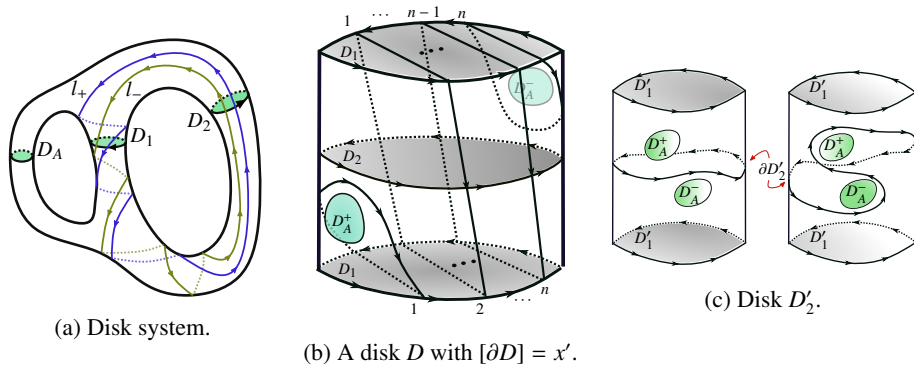

FIGURE 3.1. Disk system and meridional basis.

Proof. Isotope D in HK_A so that $m := \#D \cap (D_1 \cup D_2)$ is minimized. We prove by induction on m . If $m = 0$, then D is parallel to either D_1 or D_2 in HK_A , and thus $n = 0$ or 1 .

Suppose the statement holds for any meridian disk associated to D_A with $0 \leq m < k$, and D is a meridian disk associated to D_A with $m = k$. Let $D^\alpha \subset D$ be an outermost disk cut off by an outermost arc $\alpha \subset D \cap (D_1 \cup D_2)$ in D . It may be assumed that $\alpha \subset D_1$. α cuts off a disk D_1^α from D_1 such that $\tilde{D}^\alpha := D^\alpha \cup D_1^\alpha \subset W$ is inessential in W . By the minimality, $\partial \tilde{D}^\alpha$ bounds a disk $E^\alpha \subset \partial W$ that contains one or both of D_A^\pm . Orient D_A so that $[\partial D_A]$ is $a_2 - a_1$.

On the other hand, the union $(D - \tilde{D}^\alpha) \cup D_1^\alpha$ induces a disk D' with $\#D' \cap (D_1 \cup D_2) < k$. Therefore by induction, $[\partial D'] = a_1 + n'(a_2 - a_1)$, for some $n' \in \mathbb{Z}$. The assertion then follows by observing that $[\partial D] = [\partial D'] + t(a_2 - a_1)$, where $t = 0$ or ± 1 , depending on E^α contains both or only one of D_A^\pm , respectively.

To see the second assertion, note that, for $n = 0, 1$, one can take $D = D_1, D_2$, respectively. Suppose $n \geq 2$. Then the meridian disk D can be constructed as in Fig. 3.1b, where the boundary of D is depicted. It is not difficult to check that $[\partial D] = a'_1$. \square

Lemma 3.3. *If $\{D'_1, D'_2\}$ is a disk system associated to D_A , then*

$$\begin{aligned} [\partial D'_1] &= a_1 + n(a_2 - a_1) \\ [\partial D'_2] &= a_1 + (n \pm 1)(a_2 - a_1), \end{aligned}$$

for some $n \in \mathbb{Z}$. Conversely, if

$$\begin{aligned} a'_1 &= a_1 + n(a_2 - a_1) \\ a'_2 &= a_1 + (n \pm 1)(a_2 - a_1), \quad \text{for some } n \in \mathbb{Z}, \end{aligned}$$

then the basis $\{a'_1, a'_2\}$ is meridional.

Proof. By Lemma 3.2, $[\partial D'_1] = a_1 + n(a_2 - a_1)$ for some $n \in \mathbb{Z}$. Since $\partial D'_1, \partial D'_2$ cobound a cylinder containing exactly one of D_A^\pm . $[\partial D'_2] = [\partial D'_1] \pm (a_1 - a_2)$.

For the opposite direction, by Lemma 3.2, there is a meridian disk D'_1 associated to D_A with $[\partial D'_1] = a'_1$. Properly choosing a partition of $\partial W - \partial D'_1$ that separates $\{D_A^+, D_A^-\}$ as in Fig. 3.1c, we obtain another meridian disk D'_2 associated to D_A with $\{a'_1, a'_2\}$ induced by $\{D'_1, D'_2\}$. \square

Definition 3.2. A normalized basis $\{a_1, a_2\}$ of $H_1(E(\text{HK}_A))$ is a meridional basis in terms of which $[l_+] = (p_1, p_2)$ with either $0 < p_1 \leq p$ or $p < p_2 \leq 0$ and $[l_+] - [l_-] = (1, -1)$.

Lemma 3.4. *There exists a normalized basis $\{a_1, a_2\}$ of $H_1(E(\text{HK}_A))$. Furthermore, given two normalized basis $\{a_1, a_2\}, \{a'_1, a'_2\}$ of $H_1(E(\text{HK}_A))$, if $[l_+] = (p_1, p_2)$ and $[l_+] = (p'_1, p'_2)$ in terms of $\{a_1, a_2\}$ and $\{a'_1, a'_2\}$, respectively, then $p_i = p'_i, i = 1, 2$.*

Proof. Start with a meridional basis $\{a'_1, a'_2\}$ of $H_1(E(\text{HK}_A))$, in terms of which $[l_+] = (q_1, q_2)$ and $[l_-] = (q_1 - 1, q_2 + 1)$. There exists an $n \in \mathbb{Z}$ such that either $0 < np + q_1 \leq p$ or $p < np + q_1 \leq 0$ holds.

By the second assertion of Lemma 3.3, there exists a meridional basis $\{a_1, a_2\}$ such that

$$\{a_1, a_2\} = \{a'_1, a'_2\} \begin{bmatrix} 1 - n & -n \\ n & n + 1 \end{bmatrix},$$

In particular, if in terms of $\{a_1, a_2\}$, $[l_+] = (p_1, p_2)$, then $[l_-] = (p_1 - 1, p_2 + 1)$ and

$$\begin{aligned} p_1 &= np + q_1 \\ p_2 &= -np + q_2 \end{aligned} \tag{3.1}$$

because

$$\begin{bmatrix} p_1 \\ p_2 \end{bmatrix} = \begin{bmatrix} n + 1 & n \\ -n & 1 - n \end{bmatrix} \begin{bmatrix} q_1 \\ q_2 \end{bmatrix}.$$

Therefore either $0 < p_1 \leq p$ or $p < p_1 \leq 0$, and $\{a_1, a_2\}$ is a normalized basis.

For the second assertion, we note that, by the first statement of Lemma 3.3, either

$$\{a_1, a_2\} = \{a'_1, a'_2\} \begin{bmatrix} 1-n & -n \\ n & n+1 \end{bmatrix} \quad \text{or} \quad \{a_1, a_2\} = \{a'_1, a'_2\} \begin{bmatrix} 1-n & -n+2 \\ n & n-1 \end{bmatrix}. \quad (3.2)$$

The latter implies $a_1 - a_2 = a'_2 - a'_1$ contradicting the definition of a normalized basis. On the other hand, since $0 < p_1, p'_1 \leq p$ or $p < p_1, p'_1 \leq 0$, the only possible n in the first matrix of (3.2) is 0, and hence the assertion. \square

Corollary 3.5. $[l_+] \neq \pm[l_-] \in H_1(E(\text{HK}_A))$, and neither is trivial in $H_1(E(\text{HK}_A))$, and $[l_+], [l_-]$ form a basis of $H_1(E(\text{HK}_A))$ if and only if $|p| = 1$.

Proof. Let $[l_+] = (p_1, p_2)$, $[l_-] = (p_1 - 1, p_2 + 1)$ in terms of a meridional basis. Then the first and second assertions follow from the fact that p_1, p_2 are integers and $p_1 + p_2 = p \neq 0$, respectively. The fact that the determinant

$$\begin{vmatrix} p_1 & p_2 \\ p_1 - 1 & p_2 + 1 \end{vmatrix} = p$$

implies the third. \square

Since changing the orientation of l_+, l_- changes the orientation of a disk system, the uniqueness part of Lemma 3.4 gives us the following invariant of the triplet $(\mathbb{S}^3, \text{HK}, A)$.

Definition 3.3. The slope invariant of $(\mathbb{S}^3, \text{HK}, A)$ is the pair (p_1, p_2) of integers such that $[l_+] = (p_1, p_2)$ in terms of a normalized basis of $H_1(E(\text{HK}_A))$.

If the orientation of A is reversed, denoted by mA , then l_+, l_- are swapped and their orientation reversed. In particular, (a_1, a_2) is a normalized basis of $H_1(E(\text{HK}_A))$ if and only if $(-a_2, -a_1)$ is a normalized basis of $H_1(E(\text{HK}_{\text{mA}}))$; thus the slope invariant $(\mathbb{S}^3, \text{HK}, \text{mA})$ is $(p_2 + 1, p_1 - 1)$.

Corollary 3.6. Let f be a homeomorphism in $\mathcal{H}\text{omeo}(\mathbb{S}^3, \text{HK}, A)$ such that $f|_A$ is orientation-reversing. Then the slope invariant of $(\mathbb{S}^3, \text{HK}, A)$ is $(\frac{p+1}{2}, \frac{p-1}{2})$. In particular, no such homeomorphisms exist when p is even.

Proof. Observe first that if (a_1, a_2) is a normalized basis of $H_1(E(\text{HK}_A))$, then

$$(f_*(a_1), f_*(a_2))$$

is a normalized basis of $H_1(E(\text{HK}_{\text{mA}}))$. Secondly, if (p_1, p_2) is the slope invariant of $(\mathbb{S}^3, \text{HK}, A)$, then the slope invariant of $(\mathbb{S}^3, \text{HK}, \text{mA})$ is $(p_2 + 1, p_1 - 1)$. As a result, we have $(p_1, p_2) = (p_2 + 1, p_1 - 1)$, which together with $p_1 + p_2 = p$ implies $(p_1, p_2) = (\frac{p+1}{2}, \frac{p-1}{2})$. \square

Definition 3.4. An orientation of A is called a *preferred* orientation if the slope invariant $(\mathbb{S}^3, \text{HK}, A)$ is (p_1, p_2) with $p_1 > p_2$.

The existence of a preferred orientation can be easily verified since $p_1 > p_2$ if and only if $p_1 - 1 \geq p_2 + 1$ when $(p_1, p_2) \neq (\frac{p+1}{2}, \frac{p-1}{2})$. In the event $(p_1, p_2) = (\frac{p+1}{2}, \frac{p-1}{2})$, both A, mA are preferred orientations. The observation above allows us to define the slope type of an unoriented A .

Definition 3.5. The slope type of an unoriented $A \subset E(\text{HK})$ is the slope invariant of $(\mathbb{S}^3, \text{HK}, A)$ with A endowed with a preferred orientation.

The slope type gives a finer classification of type 3-3 annuli with a non-trivial slope, and is used to examine handlebody-knot families in Section 5.2.

Definition 3.6. A *good* basis of $H_1(\partial\text{HK}_A)$ is a basis $\{a_1, b_1, a_2, b_2\}$ such that $\{b_1, b_2\}$ generates the kernel of

$$j : H_1(\partial\text{HK}_A) \rightarrow H_1(E(\text{HK}_A)),$$

and $\{a_1, a_2\}$ viewed as elements of $H_1(E(\text{HK}_A))$ is a meridional basis, and the intersection form \mathcal{I} on $H_1(\partial\text{HK}_A)$ is realized by the matrix

$$\begin{bmatrix} 0 & 1 & 0 & 0 \\ -1 & 0 & 0 & 0 \\ 0 & 0 & 0 & 1 \\ 0 & 0 & -1 & 0 \end{bmatrix}, \quad (3.3)$$

in terms of $\{a_1, b_1, a_2, b_2\}$.

A good basis $\{a_1, b_1, a_2, b_2\}$ is excellent if $\{a_1, a_2\} \subset H_1(E(\text{HK}_A))$ is normalized.

Lemma 3.7. *Given a disk system $\{D_1, D_2\}$, there exists a good basis $\{a_1, b_1, a_2, b_2\}$ of $H_1(\partial\text{HK}_A)$ with $a_i = [\partial D_i]$, $i = 1, 2$.*

Proof. Let a_i , $i = 1, 2$, be elements in $H_1(\partial\text{HK}_A)$ represented by ∂D_i , and choose two disjoint oriented loops l_i , $i = 1, 2$, that satisfy the following properties: $D_i \cap l_j$ is a point when $i = j$ and empty otherwise, and $\mathcal{I}([\partial D_i], [l_i]) = 1$, $i = 1, 2$. Suppose $[l_i] = t_{i1}a_1 + t_{i2}a_2 \in H_1(E(\text{HK}_A))$. Then define $b_i := [l_i] - t_{i1}a_1 - t_{i2}a_2 \in H_1(\partial\text{HK}_A)$. In particular, $\{b_1, b_2\}$ form a basis of $\text{Ker}(j)$.

Since b_1, b_2 are in the image of $H_2(E(\text{HK}_A), \partial\text{HK}_A) \xrightarrow{\partial} H_1(\partial\text{HK}_A)$, $\mathcal{I}(b_1, b_2) = 0$. On the other hand, by the construction of l_i , $i = 1, 2$, we have $\mathcal{I}(a_i, b_j)$ is 1 when $i = j$ and 0 otherwise. These, together with $\mathcal{I}(a_1, a_2) = 0$, implies that the intersection form \mathcal{I} is realized by the matrix (3.3) in terms of the basis $\{a_1, b_1, a_2, b_2\}$. \square

As a result of Lemmas 3.1, 3.4 and 3.7, we have the following corollaries.

Corollary 3.8. *There exists an excellent basis of $H_1(\partial\text{HK}_A)$.*

Corollary 3.9. *Let $\{a_1, b_1, a_2, b_2\}$ be a good basis of $H_1(\partial\text{HK}_A)$. Then in terms of the basis, $[l_+] = (q_1, 1, q_2, 1) \in H_1(\partial\text{HK}_A)$ with $q_1 + q_2 = p$, and $[l_+] - [l_-] = (1, 0, -1, 0)$ or $(-1, 0, 1, 0)$.*

Proof. Since $\mathcal{I}([\partial D_i], [l_+]) = 1$ (resp. $\mathcal{I}([\partial D_i], [l_-]) = 1$), $i = 1, 2$, the coefficients of b_1, b_2 in $[l_+]$ (resp. $[l_-]$) are 1. The rest follows readily from Lemma 3.1. \square

3.2. Extrinsic disks. Through the subsection, we assume $(\mathbb{S}^3, \text{HK}_A)$ is trivial—namely, $E(\text{HK}_A)$ is a handlebody. Given an oriented disk $D \subset E(\text{HK}_A)$, denote by I_D the pair

$$(\mathcal{I}([l_+], [\partial D]), \mathcal{I}([l_-], [\partial D]))$$

of intersection numbers, where \mathcal{I} is the intersection form on $H_1(\partial\text{HK}_A)$.

Lemma 3.10. *$I_D = (0, 0)$ if and only if D is a separating disk.*

Proof. The “if” part is clear. For the “only if” part, observe that $[\partial D] = (0, d_1, 0, d_2)$, for some $d_1, d_2 \in \mathbb{Z}$, in terms of a good basis of $H_1(\partial\text{HK}_A)$. $I_D = (0, 0)$ then implies

$$\begin{cases} p_1 d_1 + p_2 d_2 = 0 \\ (p_1 - 1)d_1 + (p_2 + 1)d_2 = 0. \end{cases}$$

Since $p_1(p_2 + 1) - (p_1 - 1)p_2 = p_1 + p_2 = p \neq 0$, we have $d_1 = d_2 = 0$, and therefore $\partial D \subset \partial\text{HK}_A$ is separating. Thus, $D \subset E(\text{HK}_A)$ is a separating disk. \square

Corollary 3.11. *There exists no non-separating disk in $E(\text{HK}_A)$ disjoint from $l_+ \cup l_-$.*

Lemma 3.12. *Let D_1, D_2 be two disjoint oriented disks in $E(\text{HK}_A)$. Suppose $I_{D_1} = I_{D_2} = (1, -1)$ or $(-1, 1)$. Then D_1, D_2 are parallel.*

Proof. Since $I_{D_i} = (\pm 1, \mp 1)$, $i = 1, 2$, the disks D_1, D_2 are essential and non-separating. If they are not parallel, then $E(\text{HK}_A) - \mathring{\mathfrak{U}}(D_1 \cup D_2)$ is a 3-ball, and hence, there exist loops α_i , $i = 1, 2$, such that $\alpha_i \cap \partial D_j$ is a point when $i = j$ and empty otherwise, and $\mathcal{I}([\alpha_i], [\partial D_i]) = 1$.

The set $\{[\alpha_1], [\partial D_1], [\alpha_2], [\partial D_2]\}$ is a basis of $H_1(\partial \text{HK}_A)$ such that the images of $[\alpha_i]$, $i = 1, 2$, under $j : H_1(\partial \text{HK}_A) \rightarrow H_1(E(\text{HK}_A))$ generate $H_1(E(\text{HK}_A))$, and $[\partial D_i]$, $i = 1, 2$, form a basis of $\text{Ker}(j)$. In terms of the basis, $[L_+] = (\pm 1, c_+, \pm 1, d_+)$ and $[L_-] = (\mp 1, c_-, \mp 1, d_-)$, for some $c_{\pm}, d_{\pm} \in \mathbb{Z}$, since $I_{D_1} = I_{D_2} = (\pm 1, \mp 1)$. This implies that $[L_+] = -[L_-]$ in $H_1(E(\text{HK}_A))$, contradicting Corollary 3.5. \square

Denote by $\text{cl}(l_+)$, $\text{cl}(l_-)$ the conjugacy classes determined by l_+, l_- in $\pi_1(E(\text{HK}_A))$, respectively. We say l_+ (resp. l_-) represents the n -th power of a primitive element $x \in \pi_1(E(\text{HK}_A))$ if there exists $a \in \text{cl}(l_+)$ (resp. $b \in \text{cl}(l_-)$) such that $a = x^n$ (resp. $b = x^n$), and say $\{l_+, l_-\}$ represents a basis if there exist $a \in \text{cl}(l_+)$, $b \in \text{cl}(l_-)$ such that $\{a, b\}$ forms a basis of the free group $\pi_1(E(\text{HK}_A))$.

Lemma 3.13. *Suppose there exists an essential separating disk $D \subset E(\text{HK}_A)$ disjoint from $l_+ \cup l_-$. Then*

- (1) l_1, l_2 are either both (m, n) -torus knots with $mn = p$ or both trivial knots in \mathbb{S}^3 ;
- (2) there exists a basis $\{a, b\}$ of $\pi_1(E(\text{HK}_A))$ such that $a^{|m|} \in \text{cl}(l_+)$ and $b^n \in \text{cl}(l_-)$ when l_1, l_2 are (m, n) -torus knots in \mathbb{S}^3 , or a is in one of $\text{cl}(l_+)$, $\text{cl}(l_-)$ and $b^{|p|}$ in the other when l_1, l_2 are trivial knots in \mathbb{S}^3 .

Proof. If such a disk D exists, then it separates $E(\text{HK}_A)$ into two solid tori W_+, W_- . l_+, l_- are not in the same solid torus because $[L_+] \neq \pm[L_-] \in H_1(E(\text{HK}_A))$ by Corollary 3.5. It may be assumed that $l_+ \subset \partial W_+$ and $l_- \subset \partial W_-$. Suppose the slopes of l_+, l_- in W_+, W_- are $\frac{m}{n}, \frac{m'}{n'}$, $n, n' > 0$ respectively. Then $mn = m'n' = p$ since $\ell k(l_1, l_2) = p$.

Now, the longitudes of W_+, W_- induces a basis of $H_1(E(\text{HK}_A))$, in terms of which $[L_+] = (n, 0)$ and $[L_-] = (0, n')$. On the other hand, in terms of a normalized basis, $[L_+] = (p_1, p_2)$ and $[L_-] = (p_1 - 1, p_2 + 1)$, $p_1 + p_2 = p$. Therefore, we have

$$nm' = \begin{vmatrix} n & 0 \\ 0 & n' \end{vmatrix} = \pm \begin{vmatrix} p_1 & p_2 \\ p_1 - 1 & p_2 + 1 \end{vmatrix} = \pm p. \quad (3.4)$$

Especially, the slope of $l_- \subset W_-$ is $\frac{n}{m}$.

Let L_+, L_- be cores of W_+, W_- , respectively. Then $(\mathbb{S}^3, L_+ \cup L_-)$ is a non-simple link since there exists an essential annulus $A^\perp \subset \mathfrak{R}(A) \subset E(W_+ \cup W_-)$ bounded by $l_+ \cup l_-$. In addition, because $W_+ \cup W_- \cup \mathfrak{R}(D) = E(\text{HK}_A)$ is a handlebody, $(\mathbb{S}^3, L_+ \cup L_-)$ is a tunnel number one link.

Consider first the case $n = 1$, and hence $m = p$, by the classification of tunnel number one non-simple links in [5], (\mathbb{S}^3, L_-) is trivial, and L_+ is a $(1, p)$ -curve on a regular neighborhood of L_- . This implies l_+, l_- and hence l_1, l_2 are all trivial knots in \mathbb{S}^3 . Furthermore, there exists a basis $\{a, b\}$ of $\pi_1(E(\text{HK}_A))$ induced by the longitudes of W_+, W_- , respectively, such that $a \in \text{cl}(l_+)$ and $b^{|p|} \in \text{cl}(l_-)$. The same argument applies to the case where $n = |p|$ and $m = \pm 1$.

Suppose $n > 1, |m| > 1$. Again by the classification of tunnel number one non-simple links [5], $(\mathbb{S}^3, L_+ \cup L_-)$ is a Hopf link. Thus l_+, l_- and therefore l_1, l_2 are (m, n) -torus knots in \mathbb{S}^3 with $mn = p$. As in the previous case, there exists a basis $\{a, b\}$ of $\pi_1(E(\text{HK}_A))$ induced by the longitudes of W_+, W_- such that $a^n \in \text{cl}(l_+)$, $b^{|m|} \in \text{cl}(l_-)$. \square

Remark 3.1. Any separating essential disk in $E(\text{HK}_A)$ disjoint from $l_+ \cup l_-$ induces a non-separating disk in $E(\text{HK})$, and implies that $(\mathbb{S}^3, \text{HK})$ is reducible. Furthermore, since $E(\text{HK}_A) \cup \mathfrak{R}(A) = E(\text{HK})$ and $E(\text{HK}_A) \cap \mathfrak{R}(A) = A_+ \cup A_-$, the fundamental group $\pi_1(E(\text{HK}))$ is an HNN-extension of $\pi_1(E(\text{HK}_A))$. Thus by Lemma 3.13, if l_1, l_2 are trivial knots, then $\pi_1(E(\text{HK}))$ is free, and $(\mathbb{S}^3, \text{HK})$ is trivial.

Lemma 3.13 implies the following algebro-geometric obstruction to the existence of an essential, separating disk in $E(\text{HK}_A)$ disjoint from $l_+ \cup l_-$.

Corollary 3.14. *Suppose one of the following holds:*

- $|p| = 1$, and $\{l_+, l_-\}$ does not represent a basis of $\pi_1(E(\text{HK}_A))$.
- l_1, l_2 are not (m, n) -torus knot in \mathbb{S}^3 with $mn = p$, and neither of l_+, l_- represents the $|p|$ -th power of some primitive element of $\pi_1(E(\text{HK}_A))$.
- l_1, l_2 are (m, n) -torus knots in \mathbb{S}^3 with $mn = p$, and one of l_+, l_- does not represent the n -th or $|m|$ -th power of any primitive element in $\pi_1(E(\text{HK}_A))$.

Then there is no essential separating disk $D \subset E(\text{HK}_A)$ disjoint from $l_+ \cup l_-$.

Corollary 3.15. *Under the same conditions as in Corollary 3.14, there is no disk $D \subset E(\text{HK}_A)$ that intersects $l_+ \cup l_-$ at one point.*

Proof. Suppose such a disk D exists; it may be assumed that $D \cap l_+$ is a point. Then the boundary of a regular neighborhood of $D \cap l_+$ disjoint from l_- is an essential, separating disk disjoint from $l_+ \cup l_-$, contradicting Corollary 3.14. \square

Lemma 3.16. *Suppose p is odd, $|p| > 1$, and neither of $[l_+], [l_-]$ is the p -th multiple of some element in $H_1(E(\text{HK}_A))$. Then there exists no essential disk $D \subset E(\text{HK}_A)$ with $I_D = (\pm k, 0)$, $(0, \pm k)$, $(1, 1)$ or $(-1, -1)$, where $k = 1, 2$.*

Proof. In terms of an excellent basis of $H_1(\partial\text{HK}_A)$, we have $[l_+] = (p_1, 1, p_2, 1)$, $[l_-] = (p_1 - 1, 1, p_2 + 1, 1)$ and $[\partial D] = (0, d_1, 0, d_2)$ with either $0 < p_1 \leq p$ or $p < p_1 \leq 0$ and $d_1, d_2 \in \mathbb{Z}$. The condition that neither of $[l_+], [l_-]$ is the p -th multiple of some element in $H_1(E(\text{HK}_A))$ implies that $1 < p_1 < p$ and $0 < p_2 < p - 1$ (resp. $p + 1 < p_1 < 0$ and $p < p_2 < -1$) when $p > 0$ (resp. $p < 0$).

Suppose $I_D = (m, n)$. Then we have the system of equations

$$\begin{cases} p_1 d_1 + p_2 d_2 = m \\ (p_1 - 1)d_1 + (p_2 + 1)d_2 = n. \end{cases}$$

Consider first the case $(m, n) = (\pm k, 0)$. Then by (3.5),

$$(d_1, d_2) = \left(\pm \frac{k(p_2 + 1)}{p}, \pm \frac{k(p_1 - 1)}{p} \right). \quad (3.5)$$

The constraints $1 < p_1 < p$ and $0 < p_2 < p - 1$ (resp. $p + 1 < p_1 < 0$ and $p < p_2 < -1$), imply $|p_1 - 1|, |p_2 + 1|$ are not zero or $|p|$. Moreover, since p is odd and $p_1 - 1, p_2 + 1$ are of the same sign, one of $|p_1 - 1|, |p_2 + 1|$ is smaller than $\frac{|p|}{2}$. Therefore (3.5) is not an integral solution when $1 \leq k \leq 2$.

Similarly by (3.5), if $I_D = (0, k)$ or $(\pm 1, \pm 1)$, then $(d_1, d_2) = (\frac{kp_2}{p}, \frac{kp_1}{p})$ or $(\pm \frac{1}{p}, \pm \frac{1}{p})$, respectively, but none is an integral solution, given the constraints on p_1, p_2 and p . \square

Lemma 3.17. *Suppose $(\mathbb{S}^3, \text{HK})$ is irreducible, and there exists a separating essential disk D with $I_D = (0, 0)$ and $D \cap (l_+ \cup l_-)$ two points. Then $|p| > 1$, and either $l_+, l_- \subset E(\text{HK}_A)$ are primitive loops or l_1, l_2 are (m, n) -torus knots in \mathbb{S}^3 with $mn = p$ and one of l_+, l_- representing the n -th power of some primitive element of $\pi_1(E(\text{HK}_A))$.*

Proof. Note first that D is separating by Lemma 3.10; it may be assumed that $D \cap l_+ = \emptyset$ and $D \cap l_-$ are two points. Denote by W_1, W_2 the solid tori in $E(\text{HK}_A) - \mathring{\mathfrak{R}}(D)$ with $l_+ \subset W_1$, and by $\alpha_i \subset W_i, i = 1, 2$, the two subarcs of l_- cut off by $\mathring{\mathfrak{R}}(D)$. Note that α_i must be essential in $\partial W_i \cap \partial E(\text{HK}_A), i = 1, 2$, for otherwise D could be isotoped such that it is disjoint from $l_+ \cup l_-$, contradicting the irreducibility of $(\mathbb{S}^3, \text{HK})$ (Remark 3.1). Consider an arc β_i in the boundary of the disk $\mathring{\mathfrak{R}}(D) \cap W_i$ with $\partial\beta_i = \partial\alpha_i$, and denote by $\hat{\alpha}_i$ the loop $\alpha_i \cup \beta_i, i = 1, 2$.

Observe that by Corollary 3.5, l_+ and hence $\hat{\alpha}_1$ have a finite slope of $\frac{m}{n}$ in $W_1, n > 0$, since $[l_+]$ is not trivial in $H_1(E(\text{HK}_A))$, while $\hat{\alpha}_2 \subset W_2$ also has a finite slope of $\frac{m'}{n'}, n' > 0$ since $[l_+] \neq \pm[l_-]$ in $H_1(E(\text{HK}_A))$. There exists a basis of $H_1(E(\text{HK}_A))$ given by the longitudes of W_1, W_2 , in terms of which $[l_-] = (n, n'), [l_+] = (n, 0)$. As with (3.4), we have $nm' = \pm p$; on the other hand, $mn = p$ due to $\ell k(l_1, l_2) = p$, so $m = \pm n'$.

On the homotopy level, the longitudes of W_1, W_2 induce a basis $\{u_1, u_2\}$ such that l_+, l_- represent $u_1^n, u_1^n u_2^{n'}$; especially l_+ is the n -th power of some primitive element in

$\pi_1(E(\text{HK}_A))$. Since $\pi_1(E(\text{HK}))$ is an HNN-extension of $\pi_1(E(\text{HK}_A))$ relative to the isomorphism between $\pi_1(A_+), \pi_1(A_-)$ induced by $\mathfrak{R}(A)$, we have the following presentation

$$\pi_1(E(\text{HK})) = \{u_1, u_2, t \mid tu_1^{\pm n}t^{-1} = u_1^n u_2^{n'}\}.$$

Suppose $n = |p|$, and hence $m = \pm 1$. Then substitute u_2 with $w = u_1^{|p|}u_2$ gives us

$$\pi_1(E(\text{HK})) = \{u_1, w, t \mid tu_1^{\pm p}t^{-1} = w\},$$

which implies that $(\mathbb{S}^3, \text{HK})$ is trivial. In the same way, one can show that $(\mathbb{S}^3, \text{HK})$ is trivial if $p = \pm 1$ by replacing u_2 with $w = u_1u_2$. Since $(\mathbb{S}^3, \text{HK})$ is irreducible, we conclude that $|p| > 1$ and $n < |p|$ and hence $|m| > 1$.

Suppose $n = 1$. Then there exists a meridian disk of W_1 that meets l_+, l_- at one point each, and hence both are primitive loops of $E(\text{HK}_A)$. On the other hand, if one of $l_+, l_- \subset E(\text{HK}_A)$ is not primitive, then l_+ is an (m, n) -curve on the boundary of W_1 with $|m|, n > 1$. Since $(\mathbb{S}^3, \text{HK}_A)$ is trivial, the dual arc of D_A in $\mathfrak{R}(D_A)$ implies that (\mathbb{S}^3, l_+) is a tunnel number one knot. Let K be a core of W_1 . If (\mathbb{S}^3, K) is non-trivial, then (\mathbb{S}^3, l_+) is a tunnel number one (m, n) -cable knot, contradicting the classification of tunnel number one satellite knots in [23], for W_1 cannot be reembedded in \mathbb{S}^3 to make l_+ into an unknot in \mathbb{S}^3 . Thus (\mathbb{S}^3, K) is trivial, and l_+, l_- and therefore l_1, l_2 are (m, n) -torus knots in \mathbb{S}^3 . Since $A_+ \subset \partial W_1$, $mn = \ell k(l_1, l_2) = p$. \square

4. IRREDUCIBILITY AND ATOROIALITY

Throughout the section, $(\mathbb{S}^3, \text{HK})$ is a handlebody-knot, and $A \subset E(\text{HK})$ is an annulus whose boundary components l_1, l_2 are essential in ∂HK , for instance, a type 3-3 annulus¹. As before, HK_A denotes the union of HK and a regular neighborhood $\mathfrak{R}(A)$ of $A \subset E(\text{HK})$.

4.1. Criteria for irreducibility and atoroidality.

Lemma 4.1. *Suppose $(\mathbb{S}^3, \text{HK})$ is irreducible and atoroidal. Then A is incompressible and $E(\text{HK}_A)$ is atoroidal. If furthermore, l_1, l_2 are not parallel in ∂HK , then A is essential.*

Proof. If there exists a compressing disk D of A , then D induces a disk D' in $E(\text{HK})$ bounded by l_1 or l_2 ; D' is essential since l_1, l_2 are essential in ∂HK , contradicting the irreducibility of $(\mathbb{S}^3, \text{HK})$; hence A is incompressible. To see $E(\text{HK}_A)$ is atoroidal, we let T be a torus in $E(\text{HK}_A)$. By the assumption, it is compressible in $E(\text{HK})$, and there exists a compressing disk D of T in $E(\text{HK})$. Since $\partial D \subset T$ and A is incompressible, $D \cap A$ contains only circles inessential in A . Thus, one can isotope D away from A , so T is compressible in $E(\text{HK}_A)$.

Now suppose additionally that l_1, l_2 are non-parallel loops in ∂HK . If there exists a ∂ -compressing disk D of A , then the disk component of the boundary of a regular neighborhood of $A \cup D$ in $E(\text{HK})$ is an essential disk in $E(\text{HK})$, contradicting the irreducibility of $(\mathbb{S}^3, \text{HK})$. Therefore, A is essential. \square

Corollary 4.2. *Suppose A is a type 3-3 annulus with $\{\frac{p}{q}, pq\}$ its slope pair, and $(\mathbb{S}^3, \text{HK})$ is irreducible and atoroidal. Then A is essential, and $(\mathbb{S}^3, \text{HK}_A)$ is either irreducible or trivial.*

Proof. The first assertion follows directly from Lemma 4.1. To see the second assertion, note first that $(\mathbb{S}^3, \text{HK}_A)$ is atoroidal by Lemma 4.1. Now, if $(\mathbb{S}^3, \text{HK}_A)$ is reducible, then there exists an essential separating disk $D \subset E(\text{HK}_A)$. The boundary of a regular neighborhood of $D \cup \text{HK}_A$ in \mathbb{S}^3 consists of two tori T_1, T_2 . If $(\mathbb{S}^3, \text{HK}_A)$ is non-trivial, one of T_1, T_2 bounds a non-trivial knot exterior in $E(\text{HK}_A)$, and is therefore incompressible in $E(\text{HK}_A)$, contradicting the atoroidality of $(\mathbb{S}^3, \text{HK}_A)$. \square

¹The condition on l_1, l_2 holds for all types of annuli defined in [20, Section 3].

Conversely, the irreducibility and atoroidality of $(\mathbb{S}^3, \text{HK})$ can be inferred from topological properties of $(\mathbb{S}^3, \text{HK}_A)$.

Lemma 4.3. *Suppose $E(\text{HK}_A)$ is ∂ -irreducible. Then A is essential and $(\mathbb{S}^3, \text{HK})$ is irreducible.*

Proof. Observe first that every disk bounded by l_+ or l_- in ∂HK_A induces a disk bounded by l_1, l_2 in ∂HK , and therefore, the assumption of l_1, l_2 being essential in ∂HK implies that l_+, l_- are essential in ∂HK_A .

Suppose A is compressible, and D is a compressing disk; it may be assumed that $D \cap \mathfrak{R}(A)$ is a regular neighborhood of ∂D in D , and the disk $D' := D - \mathring{\mathfrak{R}}(A)$ in $E(\text{HK}_A)$ is bounded by either l_+ or l_- . By the irreducibility of $(\mathbb{S}^3, \text{HK}_A)$, $\partial D'$ bounds a disk D'' in ∂HK_A , contradicting that l_+, l_- are essential in ∂HK_A . Suppose A is ∂ -compressible, and D is a ∂ -compressing disk; it may be assumed that $D \cap \mathfrak{R}(A)$ is a regular neighborhood of $D \cap A$. Then the disk $D' := D - \mathring{\mathfrak{R}}(A)$ intersects $l_+ \cup l_-$ at one point, and hence is essential in $E(\text{HK}_A)$, contradicting the ∂ -irreducibility of $E(\text{HK}_A)$. Thus A is essential.

Suppose $(\mathbb{S}^3, \text{HK})$ is reducible, and D is an essential disk in $E(\text{HK})$. Isotope A such that $\#D \cap A$ is minimized. By the ∂ -irreducibility of $E(\text{HK}_A)$, $D \cap A \neq \emptyset$, and since A is essential and $E(\text{HK})$ is irreducible, $D \cap A$ contains only arcs that are inessential in A .

Let $\alpha \subset D \cap A$ be an outermost arc in D , and $D_\alpha \subset D$ be an outermost disk cut off by α . It may be assumed that $D_\alpha \cap \mathfrak{R}(A) \subsetneq D_\alpha$ and is a regular neighborhood of α in D_α . Thus, $D'_\alpha := D_\alpha - \mathring{\mathfrak{R}}(A)$ is a disk in $E(\text{HK}_A)$. Since $E(\text{HK}_A)$ is ∂ -irreducible, $\partial D'_\alpha$ bounds a disk D''_α in ∂HK_A . Isotoping A through the 3-ball bounded by $D'_\alpha \cup D''_\alpha$ removes α from $A \cap D$, contradicting the minimality. □

Corollary 4.4. *Suppose A is a type 3-3 annulus with $\{\frac{p}{q}, pq\}$ its slope pair, and $(\mathbb{S}^3, \text{HK}_A)$ is irreducible. Then A is essential and $(\mathbb{S}^3, \text{HK})$ is irreducible.*

Remark 4.1. Lemma 4.3 still holds with A replaced by a Möbius band $M \subset E(\text{HK})$ without conditions on ∂M since M is always incompressible in $E(\text{HK})$. Similarly, Corollary 4.4 remains valid if A is replaced with a type 1-2 Möbius band M [20, Section 4]; note that $(\mathbb{S}^3, \text{HK}_M)$ is also a handlebody-knot, where $\text{HK}_M = \text{HK} \cup \mathfrak{R}(M)$.

Lemma 4.5. *Suppose A is of type 3-3 with a non-trivial boundary slope of p , and $(\mathbb{S}^3, \text{HK}_A)$ is trivial. If one of the following holds:*

- $|p| = 1$, and $\{l_+, l_-\}$ does not represent a basis of $\pi_1(E(\text{HK}_A))$.
- A satisfies the condition $(\dagger\dagger)$, and neither of l_+, l_- represents the $|p|$ -th power of some primitive element of $\pi_1(E(\text{HK}_A))$.
- l_1, l_2 are (m, n) -torus knots in \mathbb{S}^3 with $mn = p$, namely, failing the condition $(\dagger\dagger)$, and one of l_+, l_- does not represent the n -th or $|m|$ -th power of any primitive element in $\pi_1(E(\text{HK}_A))$.

then A is essential and $(\mathbb{S}^3, \text{HK})$ is irreducible.

Proof. If there exists a compressing disk of A , then it induces a disk in $E(\text{HK}_A)$ bounded by either l_+ or l_- , contradicting that $[l_+], [l_-] \in H_1(E(\text{HK}_A))$ are not trivial by Corollary 3.5. If there exists a ∂ -compressing disk of A , then it induces a disk in $E(\text{HK}_A)$ that intersects $l_+ \cup l_-$ at one point, contradicting Corollary 3.15. Thus, A is essential.

Suppose $(\mathbb{S}^3, \text{HK})$ is reducible, and $D \subset E(\text{HK})$ is an essential disk. Isotope A such that $\#A \cap D$ is minimized. Since A is essential, $D \cap A$ contains only arcs that are inessential in A . Let $\alpha \subset A \cap D$ be an outermost arc in D and $D_\alpha \subset D$ an outermost disk cut off by α . It may be assumed that $D_\alpha \cap \mathfrak{R}(A) \subsetneq D_\alpha$ and is a regular neighborhood of α in D_α . Thus $D'_\alpha := D_\alpha - \mathring{\mathfrak{R}}(A)$ is a disk in $E(\text{HK}_A)$. Since α is inessential in A , it may be assumed that D'_α is disjoint from l_+, l_- . By the minimality, D'_α is essential in $E(\text{HK}_A)$, but this is not possible by Corollaries 3.11 or 3.14. □

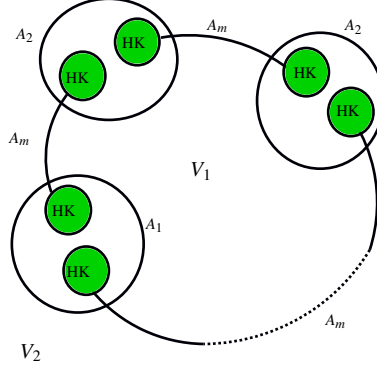
FIGURE 4.1. Schematic diagram of $A \cap T$.

In many cases, the homology version of Lemma 4.5 is sufficient to detect irreducibility.

Corollary 4.6. *Let A and $(\mathbb{S}^3, \text{HK}_A)$ be as in Lemma 4.5. Suppose $|p| > 1$, A satisfies the condition $(\dagger\dagger)$, and neither of $[L_+]$, $[L_-]$ is the $|p|$ -th multiple of some generator of $H_1(E(\text{HK}_A))$. Then A is essential, and $(\mathbb{S}^3, \text{HK})$ is irreducible.*

The following atoroidality criterion is a corollary of [32, Theorem 3.3].

Lemma 4.7. *Suppose A is a type 3-3 annulus with $\{\frac{p}{q}, pq\}$ its slope pair, and $(\mathbb{S}^3, \text{HK})$ is irreducible. If $(\mathbb{S}^3, \text{HK}_A)$ is trivial, then $(\mathbb{S}^3, \text{HK})$ is atoroidal.*

The proof of Lemma 4.7 implies the following result for general annuli. For the sake of completeness, we recall the argument in [32, Theorem 3.3] below.

Lemma 4.8. *Suppose $A \subset E(\text{HK})$ is incompressible and $E(\text{HK}_A)$ atoroidal. If $E(\text{HK})$ is toroidal, then ∂A is an $(2m, 2n)$ -torus link in \mathbb{S}^3 , $|m|, n > 1$. If furthermore A is of type 3-3, then A has a non-trivial boundary slope of $p = mn$.*

Proof. Let T be an incompressible torus in $E(\text{HK})$ that minimizes

$$\{\#T \cap A \mid T \subset E(\text{HK}) \text{ an incompressible torus}\}.$$

Denote by U the solid torus bounded by T ; note that $\text{HK} \subset U$. By the incompressibility of A, T , every circle in $A \cap T$ is essential in both A and T .

Case 1: $T \cap A \subset U$ is meridional. There exists an annulus $B \subset A$ with $B \cap T = \partial B$ and $B \not\subset U$. Let $B' \subset T$ be an annulus cut off by ∂B and $T_B := B \cup B'$. If V is the component of $\mathbb{S}^3 - T_B$ not containing HK , then V is a solid torus since T_B has less intersection with A than T does. On the other hand, because $T \cap A$ are meridional in ∂U , any essential loop of B' bounds a disk in U , and is therefore a longitude of V . In particular, one can isotope T through V to decrease $\#A \cap T$, a contradiction.

Case 2: $T \cap A \subset U$ is non-meridional. We first prove the following claim:

$$\#T \cap A \text{ is at most } 2.$$

Suppose $\#T \cap A > 2$. Then there is an annulus $B \subset A$ with $B \cap T = \partial B$ and $B \subset U$. Since $\partial B \subset U$ is not meridional, $B \subset U$ is incompressible, and divides U into two solid tori U_1, U_2 . Let U_1 be the solid torus containing HK . If $E(U_1)$ is not a solid torus, then ∂U_1 induces an incompressible torus having less intersection with A , contradicting the minimality. On the other hand, if $E(U_1)$ is a solid torus, then $E(U)$ is also a solid torus since $E(U)$ can be obtained by cutting $E(U_1)$ along the incompressible annulus $B' := E(U) \cap U_2 = \partial U_2 - \dot{B} \subset E(U_1)$, contradicting the incompressibility of T .

Therefore, $\#T \cap A = 2$, and $T \cap A$ are two parallel (resp. parallel non-meridional) essential loops in A (resp. in T). Especially, $T \cap A$ cuts T into two annuli A_1, A_2 . Denote by $A_m \subset A$ the annulus with $A_m \cap T = \partial A_m$. Note that A_m is necessarily in $E(U)$. By the

atoroidality of HK_A , the components V_i bounded by $A_m \cup A_i$, $i = 1, 2$, with $\text{HK} \not\subset V_i$ are solid tori (see Fig. 4.1).

Suppose one of $\pi_1(A_m) \rightarrow \pi_1(V_i)$, $i = 1, 2$, is an isomorphism. Then $V_1 \cup V_2 = E(U)$, is a solid torus, contradicting the incompressibility of $T = \partial U$. Now, because neither of $A_m \rightarrow V_i$, $i = 1, 2$, induces an isomorphism on π_1 , the core of U is an (m, n) -torus knot in \mathbb{S}^3 by the classification of Seifert fiber structure of \mathbb{S}^3 [28]. Since the link $\partial A = l_1 \cup l_2 \subset \mathbb{S}^3$ is isotopic to $\partial A_m \subset \mathbb{S}^3$, $l_1 \cup l_2$ is an $(2m, 2n)$ -torus link in \mathbb{S}^3 with $|m|, n > 1$.

Suppose A is of type 3-3 with $\{\frac{p}{q}, pq\}$ its slope pair, $q > 0$, and $\mathcal{D}_A \subset \text{HK}$ is a meridian disk disjoint from A . By Lemma 2.9, $\text{HK} - \mathfrak{N}(\mathcal{D}_A)$ are two solid tori W_1, W_2 with $l_i \subset W_i$, $i = 1, 2$. It may be assumed that the slope of $l_1 \subset W_1$ is $\frac{p}{q}$, and therefore $[l_1]$ is the q -th multiple of some generator of $H_1(W_1)$. On the other hand, its image under the homomorphism $H_1(W_1) \rightarrow H_1(U)$ induced by the inclusion is a generator of $H_1(U)$, so $q = 1$, and the slope pair of A is $\{p, p\}$ with $p = \ell k(l_1, l_2) = mn \neq 0$. \square

Corollary 4.9. *Given a Möbius band M in $E(\text{HK})$. Suppose $E(\text{HK}_M)$ is atoroidal, and $E(\text{HK})$ is toroidal. Then ∂M is an (m, n) -torus knot.*

Proof. The annulus $A := \mathfrak{N}(M) \cap \partial E(\text{HK}_M)$ is incompressible in $E(\text{HK})$. \square

4.2. Examples. Here we present a construction of irreducible, atoroidal handlebody-knots whose exteriors contain a type 3-3 annulus, and prove the irreducibility and atoroidality of handlebody-knots in Fig. 1.2, employing criteria developed in Section 4.1.

Recall that given a knot $K \subset \mathbb{S}^3$, a *tunnel* of K is an arc τ in \mathbb{S}^3 with $\tau \cap K = \partial\tau$; τ is called *unknotting* if $(\mathbb{S}^3, \mathfrak{N}(K \cup \tau))$ is a trivial handlebody-knot, where $\mathfrak{N}(K \cup \tau)$ is a regular neighborhood of $K \cup \tau$ in \mathbb{S}^3 .

A p -annulus \mathcal{A} associated to (K, τ) , $p \in \mathbb{Z}$, is an annulus in \mathbb{S}^3 that satisfies the following conditions:

- $\ell k(l_1, l_2) = p$, where l_1, l_2 are the components of $\partial\mathcal{A}$;
- $K \subset \mathring{\mathcal{A}}$ is an essential loop of \mathcal{A} ;
- $\mathcal{A} \cap \tau$ is a regular neighborhood of $\partial\tau$ in τ ;
- τ meets both l_1 and l_2 .

Given a p -annulus \mathcal{A} associated to (K, τ) , the handlebody-knot $(\mathbb{S}^3, \text{HK}^{\mathcal{A}, \tau})$ is given by a regular neighborhood

$$\text{HK}^{\mathcal{A}, \tau} := \mathfrak{N}((\tau - \mathring{\mathcal{A}}) \cup l_1 \cup l_2)$$

of $(\tau - \mathring{\mathcal{A}}) \cup l_1 \cup l_2$. It may be assumed that $\text{HK}^{\mathcal{A}, \tau} \cap \mathcal{A}$ is a regular neighborhood of $\partial\mathcal{A}$ in \mathcal{A} , and hence $A := \mathcal{A} - (\text{HK}^{\mathcal{A}, \tau} \cap \mathcal{A}) \subset E(\text{HK}^{\mathcal{A}, \tau})$ is a type 3-3 annulus with a boundary slope of p , and $(\mathbb{S}^3, \text{HK}_A^{\mathcal{A}, \tau}) = (\mathbb{S}^3, \mathfrak{N}(K \cup \tau))$.

4.2.1. Examples: $(\mathbb{S}^3, \text{HK}_A^{\mathcal{A}, \tau})$ is trivial. We construct here a family of irreducible, atoroidal handlebody-knots whose exteriors admit an unknotting type 3-3 annulus. Start with a trivial knot K and an unknotting tunnel τ as shown in Fig. 4.2a. Take a p -annulus associated to (K, τ) as in Fig. 4.2b, where μ, ν are odd integers and $\mu + \nu = 2p$. Denote by $\mathcal{T}_{\mu, \nu}$ the handlebody $\text{HK}^{\mathcal{A}, \tau}$ produced with the data (see Fig. 4.2c; a spine of $(\mathbb{S}^3, \mathcal{T}_{3,3})$ is illustrated in Fig. 4.2d).

Orient A as shown in Fig. 4.2b. Then

$$[L_+] = \left(\frac{\mu+1}{2}, \frac{\nu-1}{2}\right), \quad [L_-] = \left(\frac{\mu-1}{2}, \frac{\nu+1}{2}\right) \in H_1(E(\mathcal{T}_{\mu, \nu, A})),$$

in terms of the meridional basis of $H_1(E(\mathcal{T}_{\mu, \nu, A}))$ given by x_1, x_2 in Fig. 4.2a. Since L_+, L_- , being isotopic to K , are trivial knots, Corollary 4.6 and Lemma 4.7 imply the following.

Corollary 4.10. *If $\frac{\mu \pm 1}{2}, \frac{\nu \pm 1}{2}$ are not divisible by p , then the handlebody-knot $(\mathbb{S}^3, \mathcal{T}_{\mu, \nu})$ is irreducible and atoroidal.*

We remark that $(\mathbb{S}^3, \mathcal{T}_{\mu, \nu})$ is trivial when $\mu = \pm 1$ or $\nu = \pm 1$.

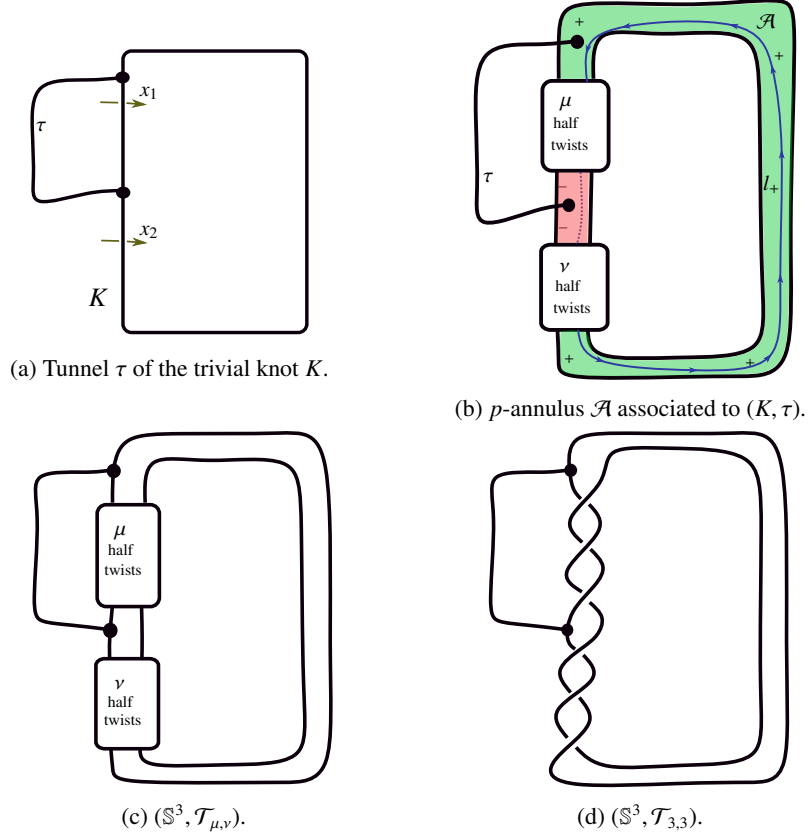

FIGURE 4.2. Construction of the handlebody-knot family $(\mathbb{S}^3, \mathcal{T}_{\mu, \nu})$.

4.2.2. *Examples: $(\mathbb{S}^3, \text{HK}_A^{\mathcal{A}, \tau})$ is irreducible.* Consider the handlebody-knot $(\mathbb{S}^3, 5_2)$ in the handlebody-knot table [16], whose spine Θ is depicted in Fig. 4.3a. Take K to be the constituent trefoil knot and τ the other arc in Θ . Choose a p -annulus A associated to (K, τ) as in Fig. 4.3c, where $p = \mu + \nu + 3$. Denote by $\mathcal{I}_{\mu, \nu}$ the resulting handlebody $\text{HK}_A^{\mathcal{A}, \tau}$.

Note that the irreducibility and atoroidality $(\mathbb{S}^3, 5_2)$ follow from the fact that its mirror image is equivalent to $(\mathbb{S}^3, \mathcal{T}_{3,3})$ as illustrated in Fig. 4.3b and Corollary 4.10 (see also [16, Table 3], [22, Figures 4c and 13], and [1, Table 2]). Thus we have the following corollary of Corollary 4.4 and Lemma 4.8.

Corollary 4.11. $(\mathbb{S}^3, \mathcal{I}_{\mu, \nu})$ is irreducible for every μ, ν , and is atoroidal if $\mu + \nu + 3 \neq 6$.

A spine of $(\mathbb{S}^3, \mathcal{I}_{\mu, \nu})$ with $\mu = \nu = 0$ is shown in Fig. 4.3d.

4.2.3. *Examples in Fig. 1.2.* In Section 1, two handlebody-knots are given in Fig. 1.2 to show how torus and cable links are used to construct irreducible, atoroidal handlebody-knots whose exteriors contain non-isotopic type 3-3 annuli. We now verify their irreducibility and atoroidality.

Corollary 4.12. $(\mathbb{S}^3, \text{HK}^t)$ in Fig. 1.2a is irreducible and atoroidal.

Proof. Let A be the oriented type 3-3 annulus in $E(\text{HK}^t)$ indicated in Fig. 4.4a. Then note that first $(\mathbb{S}^3, \text{HK}_A^t)$ is trivial, and secondly, in terms of the meridional basis of $H_1(E(\text{HK}_A^t))$ given by x_1, x_2 in Fig. 4.4a, $[L_+] = (5, 1)$ and $[L_-] = (4, 2)$.

Since ∂A is a $(3, 2)$ -torus link with $3 \cdot 2 = 6$ and $(5, 1) \in H_1(E(\text{HK}_A^t))$ is a generator, the third criterion of Lemma 4.5 implies that $(\mathbb{S}^3, \text{HK}^t)$ is irreducible. As A is unknotting, $(\mathbb{S}^3, \text{HK}^t)$ is atoroidal by Lemma 4.7. \square

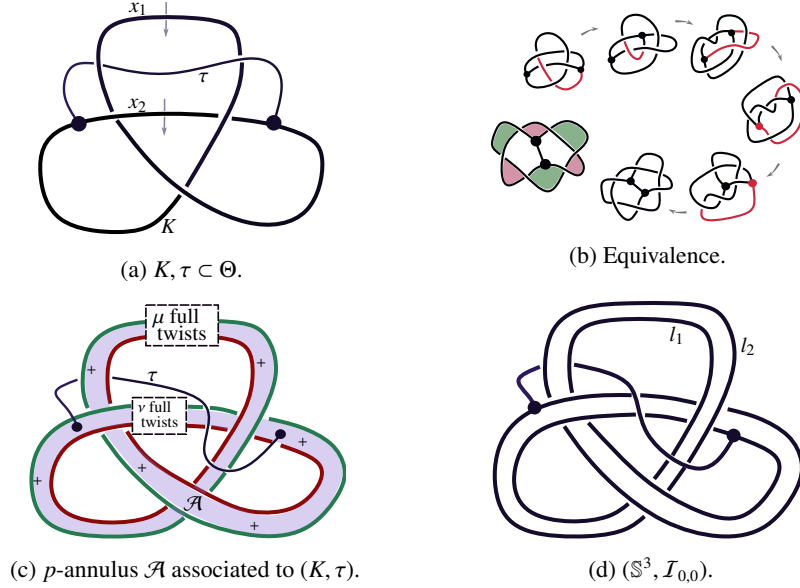

FIGURE 4.3. Construction of handlebody family $(\mathbb{S}^3, \mathcal{I}_{\mu,\nu})$.

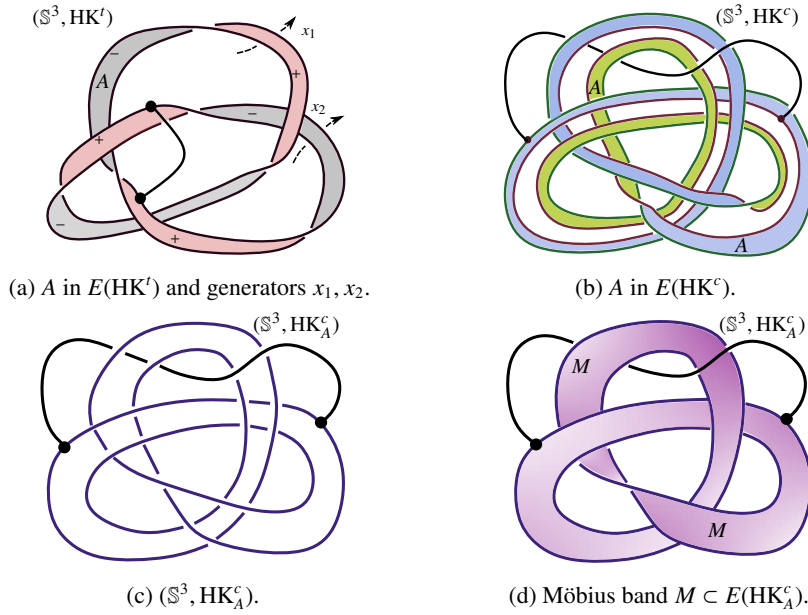

FIGURE 4.4. Annuli and Möbius band in handlebody-knot exteriors.

Corollary 4.13. $(\mathbb{S}^3, \text{HK}^c)$ in Fig. 1.2a is irreducible and atoroidal.

Proof. Let $A \subset E(\text{HK}^c)$ be the type 3-3 annulus in Fig. 4.4b, and observe that $(\mathbb{S}^3, \text{HK}_A^c)$ is the handlebody-knot given in Fig. 4.4c. There exists an essential Möbius band M in $E(\text{HK}_A^c)$ as shown in Fig. 4.4d. The Möbius band $M \subset E(\text{HK}_A^c)$ induces the handlebody-knot $(\mathbb{S}^3, \text{HK}_{A,M}^c)$, which is equivalent to $(\mathbb{S}^3, 5_2)$ in [16] and hence equivalent to the mirror image of $(\mathbb{S}^3, \mathcal{T}_{3,3})$ (see Fig. 4.3b). In particular, $(\mathbb{S}^3, \text{HK}_{A,M}^c)$ is irreducible and atoroidal by Corollary 4.10.

Now, by Remark 4.1, $(\mathbb{S}^3, \text{HK}_A^c)$ is irreducible, and since ∂M is a $(5, 2)$ -cable of a trefoil, $(\mathbb{S}^3, \text{HK}_A^c)$ is atoroidal by Corollary 4.9. Applying Corollary 4.4 and Lemma 4.8 to $(\mathbb{S}^3, \text{HK}^c)$ and A , we obtain that $(\mathbb{S}^3, \text{HK}^c)$ is irreducible and atoroidal as ∂A is a $(10, 4)$ -cable of a torus knot. \square

5. UNIQUENESS

Throughout the section, $(\mathbb{S}^3, \text{HK})$ is assumed to be irreducible, atoroidal, unless otherwise specified, and its exterior admits a type 3-3 annulus A with a non-trivial boundary slope of p . We fix an orientation of A , and let $l_1, l_2, l_+ \subset A_+, l_- \subset A_-$ be as in Section 3, and denote by l_1^+, l_2^+ (resp. l_1^-, l_2^-) the components of ∂A_+ (resp. ∂A_-).

Note that the intersection $\mathfrak{R}(A) \cap \partial \text{HK}$ is a regular neighborhood $\mathfrak{R}(l_1 \cup l_2)$ of $l_1 \cup l_2$ in ∂HK ; we denote by $\mathfrak{R}(l_i)$ the component of $\mathfrak{R}(l_1 \cup l_2)$ containing $l_i, i = 1, 2$. Recall from Section 2.4 that the annulus A determines a meridian-disk system $\mathbf{D}_A := \{\mathcal{D}_A, \mathcal{D}_1, \mathcal{D}_2\}$ of HK , where \mathcal{D}_A is a separating meridian disk disjoint from l_1, l_2 , and \mathcal{D}_i is a meridian disk of the solid torus in $\text{HK} - \mathfrak{R}(D_A)$ containing $l_i, i = 1, 2$. \mathbf{D}_A induces a handcuff spine Γ_A of HK .

5.1. Uniqueness criteria.

Lemma 5.1. *Let A' be another type 3-3 annulus in $E(\text{HK}_A)$ disjoint from A . Suppose one of the following holds:*

- $|p| = 1$;
- $|p| > 1$, A satisfies the condition (\dagger) , and neither of l_+, l_- represents the $|p|$ -th power of some element in $\pi_1(E(\text{HK}_A))$;
- $|p| > 1$, $(\mathbb{S}^3, \text{HK}_A)$ is trivial, A satisfies the condition $(\dagger\dagger)$, and neither of l_+, l_- represents the $|p|$ -th power of some primitive element in $\pi_1(E(\text{HK}_A))$

Then A, A' are parallel in $E(\text{HK})$.

Proof. Without loss of generality, it may be assumed that $A' \cap \mathfrak{R}(A) = \emptyset$. Denote by $l'_i, i = 1, 2$, the components of $\partial A'$. Then $l'_i, i = 1, 2$, are in the surface

$$S_{0,4} := \partial \text{HK} - \mathring{\mathfrak{R}}(l_1 \cup l_2).$$

$S_{0,4}$ is homeomorphic to a 2-sphere with 4 open disks removed and $\partial S_{0,4} = l_1^+ \cup l_1^- \cup l_2^+ \cup l_2^-$. Since l'_1 is not parallel to l'_2 in ∂HK , one of $l'_i, i = 1, 2$, is parallel to one of l_1^\pm, l_2^\pm in $S_{0,4}$. Without loss of generality, it may be assumed that l'_1 is parallel to l_1^+ , denoted by $l'_1 \parallel l_1^+$, and hence $l'_2 \# l_1^-$ in $S_{0,4}$.

Now, $\{\partial \mathcal{D}_1, \partial \mathcal{D}_2\}$ induces a basis $\{u_1, u_2\}$ of $H_1(E(\text{HK}))$ in terms of which $[l_i] = (p, p)$, $i = 1, 2$. Orient A', l'_1, l'_2 so that $\partial A' = l'_1 \cup -l'_2$. Suppose $l'_2 \# l_2^+$ or $l_2 \# l_2^-$ in $S_{0,4}$. Then $[l'_2] = (\pm 2p, \pm 2p)$ or $(0, 0)$ in $H_1(E(\text{HK}))$ in terms of the basis $\{u_1, u_2\}$, contradicting the fact $[l'_1] = [l'_2] \in H_1(E(\text{HK}))$. Suppose $l'_2 \parallel l_2^-$; isotope A' so that $l'_1 = l_1^+$ and $l'_2 = l_2^-$. Then the union $A_+ \cup A' \cup \mathfrak{R}(l_2)$ is a torus T separating the two loops of Γ_A but disjoint from Γ_A , contradicting the connectedness of Γ_A .

As a result, the only possible case is $l'_2 \parallel l_2^+$. Isotope A' so that $\partial A_+ = \partial A'$. Then the union $T := A_+ \cup A'$ is a torus in $E(\text{HK})$, which, by the atoroidality of $(\mathbb{S}^3, \text{HK})$, bounds a solid torus $W \subset E(\text{HK})$ disjoint from A . Since $\ell k(l_1, l_2) = p$, and $A_+ \subset \partial W \subset W$, if the slops of an essential loop l' of A' in W is $\frac{m}{n}$, then $mn = p$.

Suppose $|p| = 1$. Then $\pi_1(A') \rightarrow \pi_1(W)$ is an isomorphism, and thus A' is parallel through W to A_+ and hence parallel to A .

Suppose $|p| > 1$. Consider first the case where (\mathbb{S}^3, W) is trivial, namely $E(W)$ is a solid torus. By the condition (\dagger) or $(\dagger\dagger)$, $l_+ \subset \mathbb{S}^3$ is not an (m, n) -torus knot, and therefore the slope of l' is either p or $\frac{1}{p}$. The former implies A, A' are parallel through W . For the latter,

we consider the complement $U := E(\text{HK}_A) - \hat{W}$; note that $U \cap W = A'$. Since A' is incompressible in $E(\text{HK})$, it is incompressible in $E(\text{HK}_A)$. In particular, the homomorphisms

$$\pi_1(A') \rightarrow \pi_1(U) \quad \text{and} \quad \pi_1(A') \xrightarrow{\phi} \pi_1(W)$$

induced by inclusions are injective with ϕ sending the generator of $\pi_1(A')$ to the p -th power of a generator of $\pi_1(W)$. By the van Kampen theorem, the homomorphism

$$\pi_1(W) \xrightarrow{\psi} \pi_1(E(\text{HK}_A))$$

induced by $W \subset E(\text{HK}_A)$ is also an injection. This implies that l' and hence l_+ represent the $|p|$ -th power of some element in $\pi_1(E(\text{HK}_A))$, contradicting the assumption.

If $(\mathbb{S}^3, \text{HK}_A)$ is trivial, then A' is a incompressible, separating, non-boundary-parallel annulus in the handlebody $E(\text{HK}_A)$. By Corollary 2.8, the image of the generator of $\pi_1(W)$ under ψ is a primitive element of the free group $\pi_1(E(\text{HK}_A))$. Thus, l' and hence l_+ represent the $|p|$ -th power of some primitive element in $\pi_1(E(\text{HK}_A))$, contradicting the third criterion.

Consider now the case (\mathbb{S}^3, W) is non-trivial. The condition (\dagger) implies that the slope of l' can only be p ; thus A, A' are parallel. On the other hand, if $(\mathbb{S}^3, \text{HK}_A)$ is trivial, the cable knot condition in (\dagger) can be dropped. To see this, we note that, since $(\mathbb{S}^3, \text{HK}_A)$ is trivial, $l_+ \subset \mathbb{S}^3$ is a tunnel number one satellite knot. By the classification theorem of tunnel number one satellite knots in [23], the slope of l_+ and hence l' on W can only be p or $\frac{1}{p}$. The latter, as in the previous case, implies that l_+ represents the p -th power of some primitive element of $\pi_1(E(\text{HK}_A))$, contradicting the third criterion. Therefore the slope of l' can only be p , and hence A, A' are parallel. \square

Theorem 5.2. *Suppose $(\mathbb{S}^3, \text{HK}_A)$ is irreducible, and A satisfies the condition (\dagger) . If one of the following conditions holds:*

- $|p| = 1$;
- $|p| > 1$, and none of l_+, l_- represents the $|p|$ -th power of some element in $\pi_1(E(\text{HK}_A))$.

then, up to isotopy, A is the unique type 3-3 annulus in $E(\text{HK})$.

Proof. Suppose A' is another type 3-3 annulus in $E(\text{HK})$. Isotope A such that $\#A' \cap A$ is minimized. If $\#A' \cap A = \emptyset$, the assertion follows from Lemma 5.1, so we assume $\#A' \cap A \neq \emptyset$. By the essentiality of A, A' and (∂) -irreducibility of $E(\text{HK})$, any arc or circle in $A' \cap A$ is essential in both A and A' , and therefore $A \cap A'$ are either some circles or some arcs.

Suppose $A \cap A'$ are some circles. It may be assumed that $\partial A' \cap \mathfrak{R}(A) = \emptyset$, and as argued in the proof of Lemma 5.1, since the components l'_1, l'_2 of $\partial A'$ are not parallel in

$$S_{0,4} := \partial \text{HK} - \mathfrak{R}(l_1 \cup l_2),$$

and represent the same element in $H_1(E(\text{HK}))$, up to sign, l'_1, l'_2 are parallel to some components of $\partial S_{0,4}$. It may be assumed that l'_1 is parallel to l_1^+ , and hence l'_2 is parallel to either l_2^+ or l_2^- .

Let $\rho \subset A'$ be an outermost circle in A' and P' the outermost annulus cut off by ρ from A' . Without loss of generality, it may be assumed that $\partial P' = \rho \cup l'_1$. Let $P \subset A$ be the annular component cut off by ρ with $\partial P = \rho \cup l_2$. Then $P \cup P'$ induces a type 3-3 annulus A'' , which is disjoint from A , and therefore isotopic to A by Lemma 5.1. A'' however has less intersection with A' than A does, contradicting the minimality.

Suppose $A \cap A'$ are some arcs. It may be assumed that $A' \cap \mathfrak{R}(A)$ is a regular neighborhood of $A \cap A'$. Thus, $A' - \mathfrak{R}(A)$ consists of some disks in $E(\text{HK}_A)$, each of which meets $l_+ \cup l_-$ at two points. Let D be a disk in $A' - \mathfrak{R}(A)$. Then, by the irreducibility of $(\mathbb{S}^3, \text{HK}_A)$, $D \subset E(\text{HK}_A)$ is inessential and ∂D bounds a disk $E \subset \partial \text{HK}_A$, which cobounds a 3-ball B with D . Note that this implies that D meets either l_+ or l_- . Isotoping A through B decreases $\#A' \cap A$, and contradicts the minimality. Therefore $A \cap A' = \emptyset$.

□

Theorem 5.3. *Suppose $(\mathbb{S}^3, \text{HK}_A)$ is trivial, and A satisfies the condition $(\dagger\dagger)$. If one of the following holds:*

- (1) $|p| = 1$;
- (2) $|p| > 1$, *at least one of $l_+, l_- \subset E(\text{HK}_A)$ is not primitive, and neither of l_+, l_- represents the $|p|$ -th power of some primitive element in $\pi_1(E(\text{HK}_A))$,*

then, up to isotopy, A is the unique type 3-3 annulus in $E(\text{HK})$.

Proof. Let A' be another type 3-3 annulus in $E(\text{HK})$, and isotope A such that $\#A' \cap A$ is minimized. It suffices to show that $A' \cap A = \emptyset$ in view of Lemma 5.1.

Suppose $A' \cap A \neq \emptyset$. The same argument in the proof of Theorem 5.2 implies that $A' \cap A$ only contains arcs essential in both A' and A ; it may be assumed that $A' \cap \mathfrak{R}(A)$ is a regular neighborhood of $A' \cap A$ in A' ; thus by the minimality, $A' - \mathring{\mathfrak{R}}(A)$ consists of essential disks in $E(\text{HK}_A)$, each meeting $l_+ \cup l_-$ at two points. Let D be one of the disks. Properly orient D . Then I_D is one of the following:

$$(1, 1), (1, -1), (2, 0), (0, 2), (0, 0). \quad (5.1)$$

Any of the first four cases in (5.1) implies that D cuts $l_+ \cup l_-$ into two arcs α, β . The boundary D' of a regular neighborhood $\mathfrak{R}(D \cup \alpha)$ is an essential disk which meets either l_+ or l_- at two points with $I_{D'} = (0, 0)$, but this contradicts Lemma 3.17. Thus $I_D = (0, 0)$ with $D \subset E(\text{HK}_A)$ inessential in the only possibility, but in this case, one can isotope A via the 3-ball bounded by D and the disk in ∂HK_A bounded by ∂D to decrease $\#A' \cap A$, contradicting the minimality. □

The following simplified version of Theorems 5.2 and 5.3 is sufficient for many applications.

Corollary 5.4. *Suppose A satisfies the condition (\dagger) , and none of l_+, l_- represents the $|p|$ -th multiple of some element in $H_1(E(\text{HK}_A))$, and if $(\mathbb{S}^3, \text{HK}_A)$ is trivial, at least one of $l_+, l_- \subset E(\text{HK}_A)$ is not primitive. Then, up to isotopy, A is the unique type 3-3 annulus in $E(\text{HK})$.*

Note that Corollary 5.4 fails to include the case $|p| \leq 2$. On the other hand, when $p = \pm 1$, the condition (\dagger) is automatically satisfied, and the existence of such a type 3-3 annulus A turns out to impose strong constraints on $(\mathbb{S}^3, \text{HK})$ as well as on A itself. Theorems 5.2 and 5.3, along with Corollary 4.4 and Lemmas 4.5 and 4.8, imply the following.

Corollary 5.5. *Given a handbody-knot $(\mathbb{S}^3, \text{HK})$ and a type 3-3 annulus $A \subset E(\text{HK})$ with a boundary slope of ± 1 . Suppose $(\mathbb{S}^3, \text{HK}_A)$ is atoroidal, and if $(\mathbb{S}^3, \text{HK}_A)$ is trivial, $\{l_+, l_-\}$ does not represent a basis of $\pi_1(E(\text{HK}_A))$. Then $(\mathbb{S}^3, \text{HK})$ is irreducible, atoroidal, and A is the unique type 3-3 annulus in $E(\text{HK})$, up to isotopy.*

In view of Remark 3.1, Corollary 5.5 still holds if the condition of $\{l_+, l_-\}$ not representing a basis of $\pi_1(E(\text{HK}_A))$ is replaced with $(\mathbb{S}^3, \text{HK})$ being non-trivial. In the event that $p \neq \pm 1$ and both $l_+, l_- \subset E(\text{HK}_A)$ are primitive, the next criterion comes in handy.

Theorem 5.6. *Suppose $(\mathbb{S}^3, \text{HK}_A)$ is trivial and A satisfies the condition $(\dagger\dagger)$. If $|p| > 1$, p is odd, and neither of l_+, l_- represents the $|p|$ -th multiple of some generator of $H_1(E(\text{HK}_A))$, then, up to isotopy, A is the unique type 3-3 annulus in $E(\text{HK})$.*

Proof. Suppose A' is another type 3-3 annulus, and $\#A' \cap A$ is minimized in the isotopy classes of A, A' . By Lemma 5.1, it suffices to consider the case where $A' \cap A \neq \emptyset$. As before, we may assume $A' \cap \mathfrak{R}(A)$ is a regular neighborhood of $A' \cap A$ in A' . Then every disk component D of $A' - \mathring{\mathfrak{R}}(A)$ is essential in $E(\text{HK}_A)$ by the minimality, and I_D is one of five cases in (5.1).

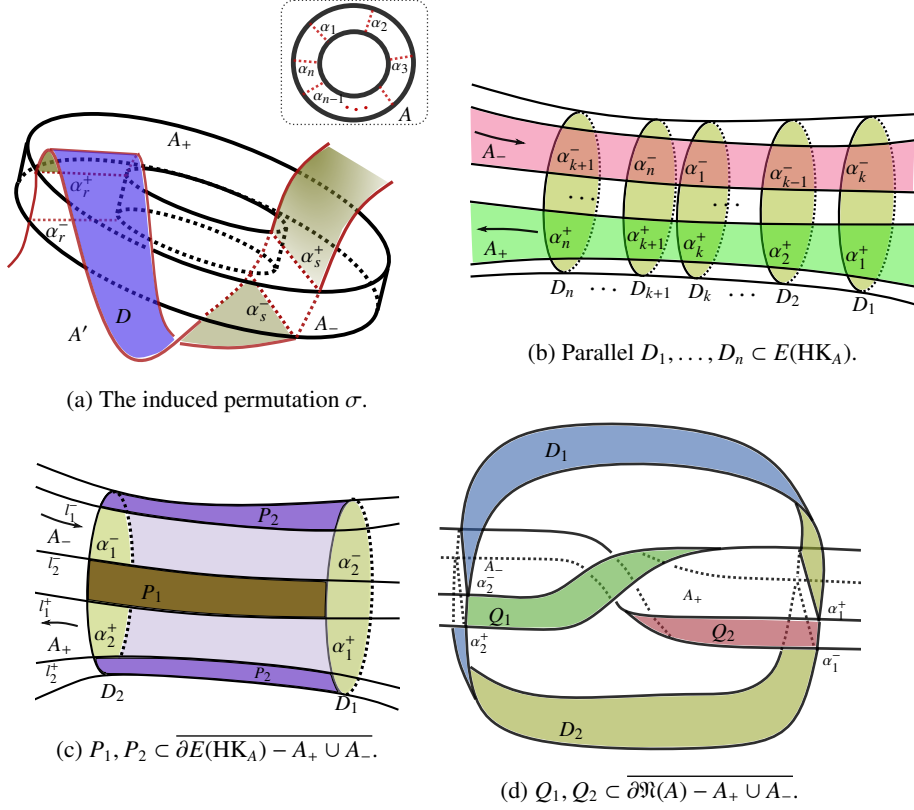
FIGURE 5.1. The case $I_D = (1, -1)$.

Apply Lemma 3.16 to rule out the first, third and fourth cases in (5.1). Then observe that, since $\#A_+ \cap A' = \#A_- \cap A'$, there exists a disk $D \subset A' - \mathfrak{R}(A)$ with $I_D = (0, 0)$ and $D \cap l_+ = \emptyset$ if and only if there exists a disk $D' \subset A' - \mathfrak{R}(A)$ with $I_{D'} = (0, 0)$, $D' \cap l_- = \emptyset$. By Lemma 3.10, D, D' are separating essential disks; since D, D' are disjoint, they are parallel. Thus, one can isotope D, D' away from $l_+ \cup l_-$, contradicting Corollary 3.14.

Consider now the remaining case: $I_D = (1, -1)$. Suppose $A' - \mathfrak{R}(A)$ consists of n disks D_1, \dots, D_n . Label the arcs in $A \cap A' \subset A$ consecutively from α_1 to α_n , that is, α_i, α_j cutting off a disk $E \subset A$ with $E \cap A' = \alpha_i \cup \alpha_j$ wherever $j \equiv i + 1 \pmod{n}$. Since $I_{D_i} = (1, -1)$, $i = 1, \dots, n$, the disks $D_i \subset A'$, $i = 1, \dots, n$, induce a permutation σ on $\{1, \dots, n\}$ defined as follows: $\sigma(r) = s$ if there exists a disk $D \in \{D_1, \dots, D_n\}$ with $\alpha_r^+ = D \cap A_+$ and $\alpha_s^- = D \cap A_-$, where $\alpha_i^\pm \subset A_\pm \cap A'$ are the arcs corresponding to α_i , namely, α_i^\pm parallel to α_i in $A' \cap \mathfrak{R}(A)$ (Fig. 5.1a). Because A' is connected, σ is of order n . On the other hand, by Lemma 3.12, $D_i, i = 1, \dots, n$, are parallel in $E(\text{HK}_A)$ (Fig. 5.1b), and therefore if $\sigma(1) = k$, then

$$\begin{aligned} \sigma(i) &= k - i + 1, & 1 \leq i \leq k \\ \sigma(i) &= n - i + k + 1, & k + 1 \leq i \leq n. \end{aligned}$$

Particularly, we have $\sigma^2 = \text{id}$, and hence $n = 2$.

Since D_1, D_2 are parallel, $\partial(D_1 \cup D_2)$ cuts off a cylinder C_0 from $\partial E(\text{HK}_A)$. The closure of $C_0 - (A_+ \cup A_-)$ consists of two disks P_1, P_2 (Fig. 5.1c). At the same time, $\partial A'$ cuts the annulus $\mathfrak{R}(l_1)$ (resp. $\mathfrak{R}(l_2)$) into two disks, one of which, denoted by Q_1 (resp. Q_2), meets each of P_1, P_2 at an arc—one in l_1^+ (resp. l_2^-) and the other in l_1^- (resp. l_2^+); see Fig. 5.1d for an illustration. The union $P_1 \cup Q_1 \cup P_2 \cup Q_2$ is a cylinder C in ∂HK with $\partial C = \partial A'$, contradicting that A' is of type 3-3. Therefore $A' \cap A = \emptyset$. \square

5.2. Examples. Consider first the handlebody-knot family $(\mathbb{S}^3, \mathcal{T}_{\mu,\nu})$ in Section 4.2, where μ, ν are odd integers; we assume $\frac{\mu+\nu}{2} \neq 0$. Let $A \subset E(\mathcal{T}_{\mu,\nu})$ be the canonical type 3-3 annulus with a boundary slope of $\frac{\mu+\nu}{2}$ given by the construction. Orient A as in Fig. 4.2b. Then, in terms of the meridional basis of $H_1(E(\mathcal{T}_{\mu,\nu,A}))$ induced by x_1, x_2 in Fig. 4.2a, $[l_+] = (\frac{\mu+1}{2}, \frac{\nu-1}{2})$, $[l_-] = (\frac{\mu-1}{2}, \frac{\nu+1}{2})$, and hence, Theorem 5.6 implies the following.

Corollary 5.7. *If $\frac{\mu+\nu}{2}$ is odd, and not equal to ± 1 , and $\frac{\mu\pm 1}{2}, \frac{\nu\pm 1}{2}$ are not divisible by p , then $A \subset E(\mathcal{T}_{\mu,\nu})$ is the unique type 3-3 annulus, up to isotopy.*

To produce examples with even boundary slope, we apply Corollary 5.4.

Corollary 5.8. *If at most one of $\frac{\mu+1}{2}, \frac{\mu-1}{2}, \frac{\nu+1}{2}, \frac{\nu-1}{2}$ equals to 1 or -1 , and none of them is divisible by p , then $A \subset E(\mathcal{T}_{\mu,\nu})$ is the unique type 3-3 annulus, up to isotopy.*

Proof. The first condition ensures that one of $l_+, l_- \subset E(\mathcal{T}_{\mu,\nu,A})$ is not a primitive loop by [33], [4], [26]. \square

Criterion in Corollary 5.8, though covers many cases, does fail to include some important small crossing handlebody-knots, such as $(\mathbb{S}^3, 5_3), (\mathbb{S}^3, 6_4)$ in the handlebody-knot table [16]. The former, being equivalent to the mirror image of $(\mathbb{S}^3, \mathcal{T}_{3,3})$ (Fig. 4.3b), is covered in Corollary 5.7, whereas the latter, equivalent to the mirror image of $(\mathbb{S}^3, \mathcal{T}_{-3,5})$ (Fig. 5.2a), is considered in Section 5.3.

Corollaries 5.7 and 5.8, together with the slope type of A , give us the following.

Corollary 5.9. *The family of handlebody-knots*

$$\{(\mathbb{S}^3, \mathcal{T}_{\mu,\nu}) \mid \mu, \nu \text{ odd integers}\} \quad (5.2)$$

contains infinitely many irreducible, atoroidal handlebody-knots whose exterior admit a unique type 3-3 annulus, which is unknotting.

Proof. Consider the subfamily of (5.2)

$$\mathcal{P}_T := \{(\mathbb{S}^3, \mathcal{T}_{\mu,\nu}) \mid \mu \geq \nu > 1 \text{ or } -1 > \mu \geq \nu\}.$$

The condition $\mu \geq \nu > 1$ or $-1 > \mu \geq \nu$ implies that the meridional basis of $H_1(E(\mathcal{HK}_A))$ induced by x_1, x_2 is normalized, and the orientation of A given in Fig. 4.2b is a preferred one. Thus, $(\frac{\mu+1}{2}, \frac{\nu-1}{2})$ is the slope type of A . On the other hand, given $(\mathbb{S}^3, \mathcal{T}_{\mu,\nu}) \in \mathcal{P}_T$, the uniqueness of $A \subset E(\mathcal{T}_{\mu,\nu})$ is guaranteed by Corollary 5.7 when $\mu = \nu = \pm 3$ and by Corollary 5.8 for the other cases. Hence, the slope type $(\frac{\mu+1}{2}, \frac{\nu-1}{2})$ depends only on the isotopy class of $(\mathbb{S}^3, \mathcal{T}_{\mu,\nu})$, so members in \mathcal{P}_T are all inequivalent. \square

Similarly, for the handlebody-knot family $(\mathbb{S}^3, \mathcal{I}_{\mu,\nu})$ in Section 4.2, we have the following by Corollary 5.4.

Corollary 5.10. *Suppose $\mu + \nu + 3 \neq 6$, and $\mu + 1, \mu + 2, \nu + 1, \nu + 2$ are not divisible by p . Then $A \subset E(\mathcal{I}_{\mu,\nu})$ is the unique type 3-3 annulus, up to isotopy.*

Proof. The first criterion is equivalent to saying $|p| = 1$, whereas the second implies that l_+, l_- do not represent the $|p|$ -th multiples of some elements in $H_1(E(\mathcal{I}_{\mu,\nu,A}))$, for

$$[l_+] = (\mu + 2, \nu + 1), \quad [l_-] = (\mu + 1, \nu + 2) \in H_1(E(\mathcal{I}_{\mu,\nu,A}))$$

in terms of the meridional basis of $H_1(E(\mathcal{I}_{\mu,\nu}))$ given by x_1, x_2 in Fig. 4.3a with A oriented as in Fig. 4.3c. \square

Corollary 5.11. *The handlebody-knot family*

$$\{(\mathbb{S}^3, \mathcal{I}_{\mu,\nu}) \mid \mu, \nu \in \mathbb{Z}\} \quad (5.3)$$

contains infinitely many irreducible, atoroidal handlebody-knots whose exteriors admit a unique type 3-3 annulus.

Proof. Consider the subfamily of (5.3)

$$\mathcal{P}_I := \{(\mathbb{S}^3, \mathcal{I}_{\mu,\nu}) \mid \mu \geq \nu > -1 \text{ or } -2 > \mu \geq \nu, \text{ and } \mu + \nu + 3 \neq 6\}.$$

The condition $\mu \geq \nu > -1$ or $-2 > \mu \geq \nu$ implies that the meridional basis of $H_1(E(\mathcal{I}_{\mu,\nu,A}))$ given in Fig. 4.3a is normalized and the orientation of A in Fig. 4.3c is a preferred one. Thus, $(\mu + 2, \nu + 1)$ is the slope type of A , and depends only on the isotopy class of $(\mathbb{S}^3, \mathcal{I}_{\mu,\nu})$ by the uniqueness of A following from Corollary 5.10. Members in \mathcal{P}_I are therefore mutually inequivalent. \square

5.3. When homology criteria fail. For handlebody-knots in Corollaries 4.10, 5.7, and 5.8, homology criteria in Corollaries 4.6 and 5.4 provide a simple way to detect their irreducibility and the uniqueness of A . In some cases though the homology criteria are not strong enough to “see” the irreducibility and uniqueness of A , and homotopy criteria in Lemma 4.5 and Theorem 5.2 are called for.

As an example, consider the handlebody-knots $(\mathbb{S}^3, \mathcal{T}_{\mu,\nu})$ with $(\mu, \nu) = (-2p + 1, 4p - 1)$, $|\frac{\mu+\nu}{2}| = |p| > 1$. In terms of the meridional basis given in Fig. 4.2a,

$$[l_+] = (-p + 1, 2p - 1), \quad [l_-] = (-p, 2p) \text{ in } H_1(E(\mathcal{T}_{\mu,\nu,A})).$$

As $[l_-]$ is the $|p|$ -th multiple of $(-1, 2)$, Corollary 4.6 is not applicable here.

On the other hand, l_+, l_- determine the conjugacy classes of the cyclically reduced words $x_1^{-p+1} x_2^{2p-1}, x_1^{-p} x_2^{2p}$, respectively; neither is the $|p|$ -th power of an element in $\pi_1(E(\mathcal{T}_{\mu,\nu,A}))$, so applying Lemmas 4.5 and 4.7 and Theorem 5.3, we obtain the following.

Corollary 5.12. $\{(\mathbb{S}^3, \mathcal{T}_{-2p+1,4p-1} \mid |p| > 1\}$ is an infinite family of irreducible, atoroidal handlebody-knots whose exteriors admit a unique type 3-3 annulus.

Proof. Members in the family are mutually inequivalent by the uniqueness of A . \square

It is worth noting that the homology criterion in Corollary 4.6 exclude the case $|p| < 3$; many small crossing handlebody-knots, however, fall into this category. To see their irreducibility and atoroidality, and the uniqueness of A , one can employ Lemma 4.5 and Corollary 5.5.

For instance, consider the handlebody-knot family

$$\{(\mathbb{S}^3, \mathcal{T}_{\mu,2-\mu}) \mid \mu < -1\}. \quad (5.4)$$

Note that because $(\mathbb{S}^3, \mathcal{T}_{\mu,2-\mu}) = (\mathbb{S}^3, \mathcal{T}_{2-\mu,\mu})$, we have

$$\{(\mathbb{S}^3, \mathcal{T}_{\mu,2-\mu}) \mid \mu < -1\} = \{(\mathbb{S}^3, \mathcal{T}_{\mu,2-\mu}) \mid \mu > 3\},$$

and when $\mu = \pm 1$ or 3, $(\mathbb{S}^3, \mathcal{T}_{\mu,2-\mu})$ is trivial; also, the canonical type 3-3 annulus $A \subset E(\mathcal{T}_{\mu,2-\mu})$ has a boundary slope of 1, for every $(\mathbb{S}^3, \mathcal{T}_{\mu,2-\mu})$. In terms of the basis x_1, x_2 of $\pi_1(E(\mathcal{T}_{\mu,2-\mu,A}))$ in Fig. 4.2a, l_+, l_- determine the conjugacy classes of the cyclically reduced words

$$x_1^{\frac{\mu+1}{2}} x_2^{\frac{1-\mu}{2}}, \quad x_1^{\frac{\mu-1}{2}} x_2^{\frac{3-\mu}{2}},$$

respectively. Since none of the exponents is 0, and exponents of x_1 (resp. x_2) are not ± 1 simultaneously, $\{l_+, l_-\}$ does not represent a basis of $\pi_1(E(\mathcal{T}_{\mu,2-\mu,A}))$ by [4], and therefore we have the following by Corollary 5.5.

Corollary 5.13. $\{(\mathbb{S}^3, \mathcal{T}_{\mu,2-\mu}) \mid \mu < -1\}$ is an infinite family of irreducible, atoroidal handlebody-knots whose exteriors admit a unique type 3-3 annulus.

Proof. The irreducibility, atoroidality, and the uniqueness of A follows from Corollary 5.5, so it suffices to show that members in the family are mutually inequivalent. Suppose f is an equivalence between $(\mathbb{S}^3, \mathcal{T}_{\mu,2-\mu})$ and $(\mathbb{S}^3, \mathcal{T}_{\mu',2-\mu'})$ with $\mu \neq \mu'$ and $\mu, \mu' < -1$. Let $A \subset E(\mathcal{T}_{\mu,2-\mu}), A' \subset E(\mathcal{T}_{\mu',2-\mu'})$ be the type 3-3 annuli given by the construction in Section 4.2. By the uniqueness of A, A' , we may assume $f(\mathfrak{R}(A)) = \mathfrak{R}(A')$.

Let l_{\pm} (resp. l'_{\pm}) be essential loops of the annular components of $\mathfrak{R}(A) \cap \partial\mathcal{T}_{\mu,2-\mu,A}$ (resp. $\mathfrak{R}(A') \cap \partial\mathcal{T}_{\mu',2-\mu',A'}$), respectively. Then it may be assumed that f sends l_{\pm} either to l'_{\pm} or to l'_{\mp} . Therefore, the induced homomorphism

$$f_* : \pi_1(E(\mathcal{T}_{\mu,2-\mu,A})) \rightarrow \pi_1(E(\mathcal{T}_{\mu',2-\mu',A'}))$$

sends the conjugacy class of $x_1^{\frac{\mu+1}{2}} x_2^{\frac{1-\mu}{2}}$ (resp. $x_1^{\frac{\mu-1}{2}} x_2^{\frac{3-\mu}{2}}$) to the conjugacy class of either $x_1^{\frac{\mu'+1}{2}} x_2^{\frac{1-\mu'}{2}}$ or $x_1^{\frac{\mu'-1}{2}} x_2^{\frac{3-\mu'}{2}}$.

Denote by X_{μ}^+ (resp. X_{μ}^-) the 3-manifold obtained by attaching a 2-handle to $E(\mathcal{T}_{\mu,2-\mu,A})$ along l_+ (resp. l_-). Observe that when $\mu < -3$, its fundamental group is isomorphic to the torus knot group $\pi_1(E(\mathcal{K}_{p,q}))$ with $(p, q) = (-\frac{1-\mu}{2}, \frac{1-\mu}{2})$ (resp. $(p, q) = (\frac{1-\mu}{2}, \frac{3-\mu}{2})$), whereas $\pi_1(X_{-3}^+) \simeq \mathbb{Z}$ and $\pi_1(X_{-3}^-) \simeq \pi_1(E(\mathcal{K}_{2,3}))$. Thus we may assume $\mu, \mu' < -3$.

Since torus knots are distinguished by their knot groups, up to mirror image. If $f(l_{\pm}) = l'_{\pm}$, then f_* implies that $(-\frac{1-\mu}{2}, \frac{1-\mu}{2})$ - and $(-\frac{1-\mu'}{2}, \frac{1-\mu'}{2})$ -torus knots (resp. $(\frac{1-\mu}{2}, \frac{3-\mu}{2})$ - and $(\frac{1-\mu'}{2}, \frac{3-\mu'}{2})$ -torus knots) are equivalent, up to mirror image; this happens only when $\mu = \mu'$, contradicting the assumption. Similarly, if $f(l_{\pm}) = l'_{\mp}$, then we have $(-\frac{1-\mu}{2}, \frac{1-\mu}{2})$ - and $(\frac{1-\mu'}{2}, \frac{3-\mu'}{2})$ -torus knots (resp. $(-\frac{1-\mu}{2}, \frac{3-\mu}{2})$ - and $(-\frac{1-\mu'}{2}, \frac{1-\mu'}{2})$ -torus knots) are equivalent, up to mirror image, but this too is an impossibility under the assumption $\mu, \mu' < -1$. \square

Remark 5.1. $(\mathbb{S}^3, \mathcal{T}_{3,3})$ and $(\mathbb{S}^3, \mathcal{T}_{-3,5})$ are equivalent to the mirror images of handlebody-knots $(\mathbb{S}^3, \mathcal{S}_2)$ and $(\mathbb{S}^3, 6_4)$ in [16, Table 1] as demonstrated in Figs. 4.3b and 5.2a, respectively. Hence we obtain an alternative proof of their irreducibility [16, Section 4] and A being the unique type 3-3 annulus in their exteriors (compare with [22, Lemmas 3.4 and 4.5]). Also, the type 3-3 annuli in $E(\mathcal{T}_{3,3}), E(\mathcal{T}_{-3,5})$ having different slope types is another way to see the inequivalence between $(\mathbb{S}^3, \mathcal{S}_2)$ and $(\mathbb{S}^3, 6_4)$ [16, Table 2].

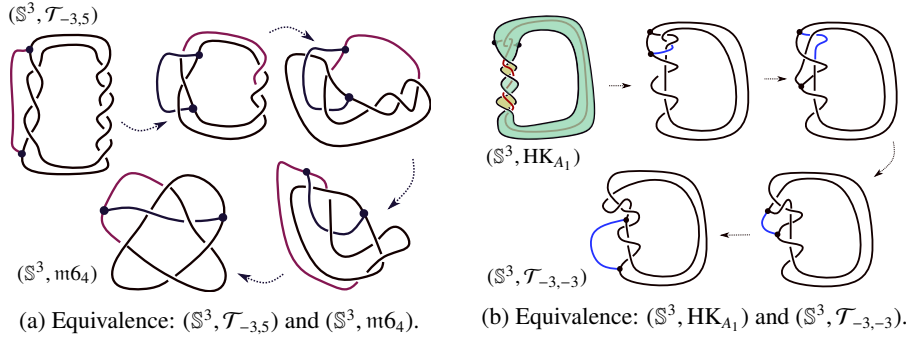

FIGURE 5.2. Equivalences between handlebody-knots.

5.4. Non-uniqueness. Let $(\mathbb{S}^3, \text{HK})$ be the handlebody-knot given by a regular neighborhood of the handcuff spatial graph in Fig. 5.3a. $E(\text{HK})$ contains two non-isotopic type 3-3 annuli A_1, A_2 with a boundary slope of 2 as shown in Figs. 5.3b and 5.3c, respectively.

The irreducibility and atoroidality of $(\mathbb{S}^3, \text{HK})$ follow from the fact that $(\mathbb{S}^3, \text{HK}_{A_1})$ is equivalent to $(\mathbb{S}^3, \mathcal{T}_{-3,-3})$ as shown in Fig. 5.2b and Corollary 4.4 and Lemma 4.8.

Let l_{\pm} be essential loops of the two annular components of $\mathfrak{R}(A_1) \cap \partial\text{HK}_{A_1}$, respectively. Then one of them represents the square of some element in $\pi_1(E(\text{HK}_{A_1}))$ —failing the criterion in Theorem 5.2. The same is true for A_2 , which is unknotting, so this example also shows that criteria in Lemma 4.5 are not a necessary condition for a handlebody-knot to be irreducible.

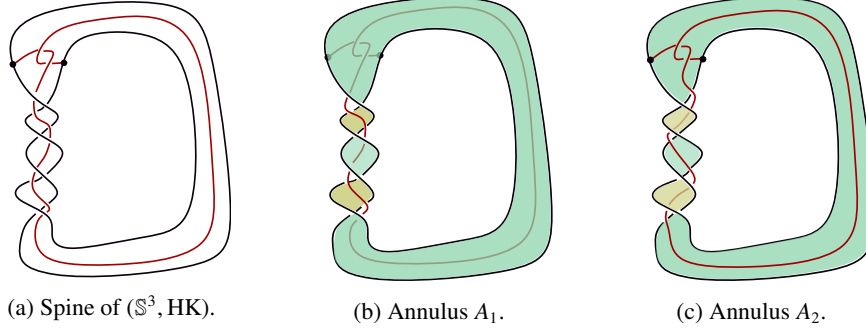

FIGURE 5.3. Irreducible, atoroidal $(\mathbb{S}^3, \text{HK})$ with non-isotopic type 3-3 annuli.

6. SYMMETRY

6.1. Symmetry group. Throughout the subsection $(\mathbb{S}^3, \text{HK})$ is an irreducible, atoroidal handlebody-knot whose exterior contains a unique type 3-3 annulus A with a non-trivial boundary slope of p , up to isotopy. Let (p_1, p_2) be the slope type of A . Orient A and its boundary components l_1, l_2 so that $l_1 \cup -l_2 = \partial A$. Let $\mathbf{D}_A = \{\mathcal{D}_1, \mathcal{D}_2, \mathcal{D}_A\}$ be the meridian system induced by A and Γ_A the associated spine of HK (see Section 2.4). We fix an orientation of $\mathcal{D}_i, i = 1, 2$.

Theorem 6.1. *The composition*

$$\text{MCG}_+(\mathbb{S}^3, \text{HK}) \simeq \text{MCG}_+(\mathbb{S}^3, \text{HK}, A) \xrightarrow{\pi} \text{MCG}(\mathring{A}) \simeq \mathbb{Z}_2 \times \mathbb{Z}_2 \quad (6.1)$$

is an injection.

Proof. Given $f \in \text{Homeo}_+(\mathbb{S}^3, \text{HK})$, suppose $f|_{\mathring{A}}$ is isotopic to the identity. Then $f(l_i) = l_i$ and $f|_{l_i}$ is orientation-preserving, $i = 1, 2$. By Corollary 2.10, we have the isomorphism

$$\text{MCG}_+(\mathbb{S}^3, \text{HK}, \cup \mathbf{D}_A) \rightarrow \text{MCG}_+(\mathbb{S}^3, \text{HK}),$$

and hence f can be isotoped in $\text{Homeo}_+(\mathbb{S}^3, \text{HK})$ to a homeomorphism f' with $f'(\mathcal{D}_A) = \mathcal{D}_A, f'(\mathcal{D}_i) = \mathcal{D}_i, i = 1, 2$, and $f'|_{\mathcal{D}_i}$ orientation-preserving. The homomorphism

$$\text{MCG}_+(\mathbb{S}^3, \text{HK}, \cup \mathbf{D}_A) \rightarrow \text{MCG}_+(\mathbb{S}^3, \Gamma_A) \quad (6.2)$$

in Lemma 2.1 given by the Alexander trick allows us to further isotope f' in

$$\text{Homeo}_+(\mathbb{S}^3, \text{HK}, \cup \mathbf{D}_A)$$

to a homeomorphism $f'' \in \text{Homeo}_+(\mathbb{S}^3, \text{HK}, \cup \mathbf{D}_A, \Gamma_A)$ that restricts to the identity on Γ_A . The injectivity of (6.1) then follows from Lemma 2.3 and (6.2) being an isomorphism by Lemma 2.1. \square

The next two corollaries follows readily from Theorem 6.1.

Corollary 6.2. $\text{MCG}(\mathbb{S}^3, \text{HK}) = \text{MCG}_+(\mathbb{S}^3, \text{HK}) \leq \mathbb{Z}_2 \times \mathbb{Z}_2$,

Proof. It suffices to show that $(\mathbb{S}^3, \text{HK})$ is chiral. Since A is unique, any $f \in \text{Homeo}(\mathbb{S}^3, \text{HK})$ can be isotoped so that $f(l_1 \cup l_2) = l_1 \cup l_2$ or $-l_1 \cup -l_2$. If f is orientation-reversing, then $\ell k(f(l_1), f(l_2)) = -p$, but at the same time, $\ell k(f(l_1), f(l_2)) = \ell k(l_1, l_2) = p$, contradicting $p \neq 0$. \square

Combining Corollary 6.2 with Lemma 3.6, we have the following.

Corollary 6.3. *If $(p_1, p_2) \neq (\frac{p+1}{2}, \frac{p-1}{2})$, then $\text{MCG}(\mathbb{S}^3, \text{HK}) = \text{MCG}_+(\mathbb{S}^3, \text{HK}) \leq \mathbb{Z}_2$.*

Proof. By Lemma 3.6, there exists no homeomorphism $f \in \mathcal{H}\text{omeo}(\mathbb{S}^3, \text{HK}, A)$ whose restriction $f|_A$ on A is orientation-reversing unless $(p_1, p_2) = (\frac{p+1}{2}, \frac{p-1}{2})$, so if $(p_1, p_2) \neq (\frac{p+1}{2}, \frac{p-1}{2})$, the homomorphism (6.1) is not surjective. \square

6.2. Examples: optimal upper bounds. Here we show that the group $\mathbb{Z}_2 \times \mathbb{Z}_2$ (resp. \mathbb{Z}_2) in Corollary 6.2 (resp. 6.3) is optimal, in the sense that there are handlebody-knots satisfying the given condition and having a symmetry group isomorphic to the group.

6.2.1. $\mathbb{Z}_2 \times \mathbb{Z}_2$. Consider the subfamily

$$\mathcal{V} := \{(\mathbb{S}^3, \mathcal{T}_{p,p}) \mid p \text{ odd}, |p| > 1\}$$

of the handlebody-knot family $\{(\mathbb{S}^3, \mathcal{T}_{\mu,\nu}) \mid \mu, \nu \text{ odd}\}$, and let A be the type 3-3 annulus given by the construction in Section 4.2. By Corollaries 4.10 and 5.7, every $(\mathbb{S}^3, \text{HK}) \in \mathcal{V}$ is irreducible and atoroidal, and $A \subset E(\text{HK})$ is unique type 3-3 annulus, up to isotopy.

Corollary 6.4. $MCG(\mathbb{S}^3, \text{HK}) = MCG_+(\mathbb{S}^3, \text{HK}) = \mathbb{Z}_2 \times \mathbb{Z}_2$, for any $(\mathbb{S}^3, \text{HK}) \in \mathcal{V}$.

Proof. Note first $MCG(\mathbb{S}^3, \text{HK}) = MCG_+(\mathbb{S}^3, \text{HK}) \leq \mathbb{Z}_2 \times \mathbb{Z}_2$ by Corollary 6.2. For the other direction, consider the homeomorphisms g_1, g_2 given by the isotopies in Figs. 6.1, 6.2, respectively. The isotopy in Fig. 6.1 is given by first rotating the diagram against a horizontal line and then moving the lower end of the arc τ up counterclockwise along the untwisted part of l_1 . In particular, $g_1|_A$ reverses the orientation of A , but does not swap l_1, l_2 . On the other hand, the isotopy in Fig. 6.2 is given by first swapping l_1, l_2 , and hence flipping A , then moving the upper end of τ down clockwise, and then shifting two ends of τ up simultaneously along the twisted part of ∂A . Especially, $g_2|_A$ reverses the orientation of A , and swaps l_1, l_2 .

Since the elements represented by g_1, g_2 have different non-trivial images under the homomorphism

$$MCG(\mathbb{S}^3, \text{HK}) \simeq MCG(\mathbb{S}^3, \text{HK}, A) \rightarrow MCG(A), \quad (6.3)$$

we see $MCG(\mathbb{S}^3, \text{HK}) \geq \mathbb{Z}_2 \times \mathbb{Z}_2$. \square

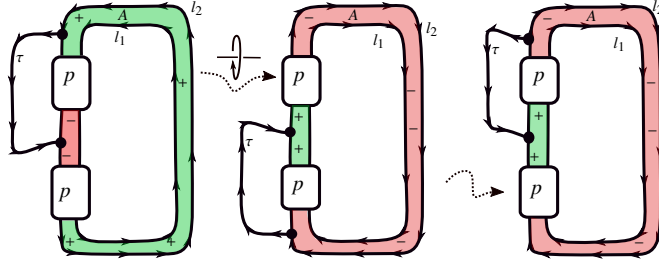

FIGURE 6.1. g_1 : flip A + reverse l_1, l_2 .

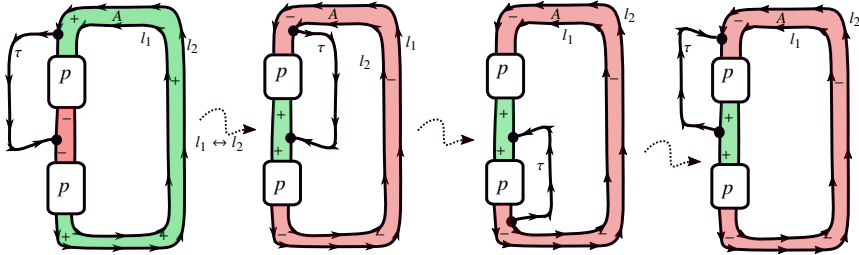

FIGURE 6.2. g_2 : flip A + swap l_1, l_2 .

6.2.2. \mathbb{Z}_2 . Denote by \mathcal{W} the subfamily

$$\{(\mathbb{S}^3, \mathcal{T}_{\mu, \nu}) \mid \mu, \nu > 1 \text{ or } \mu, \nu < -1, \mu \neq \nu, \text{ and } \mu, \nu \text{ odd}\}$$

of the handlebody-knot family $\{(\mathbb{S}^3, \mathcal{T}_{\mu, \nu}) \mid \mu, \nu \text{ odd}\}$. By Corollaries 4.10 and 5.8, every $(\mathbb{S}^3, \text{HK}) \in \mathcal{W}$ is irreducible and atoroidal, and the canonical annulus $A \subset E(\text{HK})$ is the unique type 3-3 annulus, up to isotopy.

Corollary 6.5. $MCG(\mathbb{S}^3, \text{HK}) = MCG_+(\mathbb{S}^3, \text{HK}) = \mathbb{Z}_2$, for any $(\mathbb{S}^3, \text{HK}) \in \mathcal{W}$.

Proof. The condition $\mu, \nu > 1$ or $\mu, \nu < -1$ implies the slope type of A is either $(\frac{\mu+1}{2}, \frac{\nu-1}{2})$ or $(\frac{\nu+1}{2}, \frac{\mu-1}{2})$, so $\mu = \nu$ if and only if the slope type is $(\frac{\mu+1}{2}, \frac{\mu-1}{2})$; by Corollary 6.3,

$$MCG(\mathbb{S}^3, \text{HK}) = MCG_+(\mathbb{S}^3, \text{HK}) \leq \mathbb{Z}_2.$$

To see $MCG_+(\mathbb{S}^3, \text{HK})$ is non-trivial, we observe that the homeomorphism g given by the isotopy in Fig. 6.3 represents a non-trivial element g in $MCG_+(\mathbb{S}^3, \text{HK})$. The isotopy starts with swapping l_1, l_2 , then rotates the diagram against a horizontal line by π , and then moves the arc τ up along the twisted part of ∂A by ν half crossings. In particular, the element represented by g has a non-trivial image under the homomorphism(6.3). \square

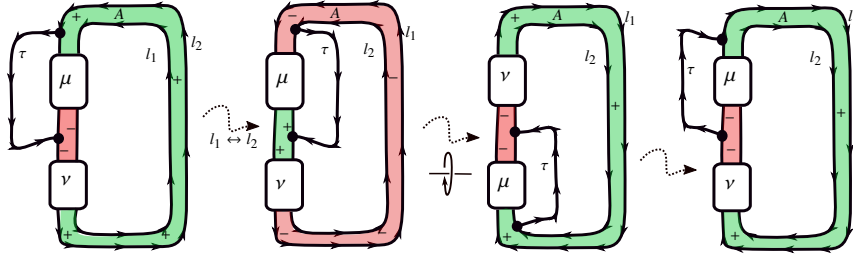

FIGURE 6.3. g : swap l_1, l_2 + reverse l_1, l_2 .

6.3. Examples: not an isomorphism. Here we show that the inequalities \leq 's in Corollaries 6.2 and 6.3 are in general not an isomorphism. Denote by \mathcal{V} the family

$$\{(\mathbb{S}^3, \mathcal{T}_{\mu, 2-\mu}) \mid \mu < -1\}$$

of handlebody-knots in Section 5.3. For any $(\mathbb{S}^3, \text{HK}) \in \mathcal{V}$, the slope type of the unique type 3-3 annulus $A \subset E(\text{HK})$ is $(1, 0)$, and so Corollary 6.3 does not apply.

Corollary 6.6. $MCG(\mathbb{S}^3, \text{HK}) \simeq MCG_+(\mathbb{S}^3, \text{HK}) \simeq \mathbb{Z}_2$, for any $(\mathbb{S}^3, \text{HK}) \in \mathcal{V}$.

Proof. Note first that, given $(\mathbb{S}^3, \mathcal{T}_{\mu, 2-\mu}) \in \mathcal{V}$, the isotopy in Fig. 6.4 represents a non-trivial element in $MCG(\mathbb{S}^3, \mathcal{T}_{\mu, 2-\mu})$. Secondly, recall that l_+, l_- determine the conjugacy

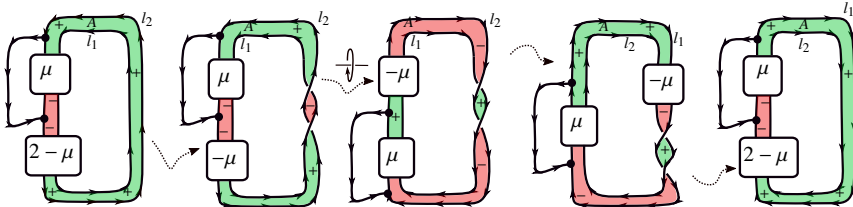

FIGURE 6.4. Swap and reverse l_1, l_2 .

classes represented by the cyclically reduced words $x_1^{\frac{\mu+1}{2}} x_2^{\frac{1-\mu}{2}}, x_1^{\frac{\mu-1}{2}} x_2^{\frac{3-\mu}{2}}$, respectively, where $x_1, x_2 \in \pi_1(E(\mathcal{T}_{\mu, 2-\mu, A}))$ are generators given in Fig. 4.2a.

Suppose the homomorphism (6.1) is surjective. Then there exists a homeomorphism $f \in \mathcal{H}omeo_+(\mathbb{S}^3, \mathcal{T}_{\mu, 2-\mu}, A)$ which swaps l_+, l_- . Let X_μ^\pm be the spaces obtained by attaching a 2-cell along l_\pm , respectively. Then the induced homomorphism f_* on $\pi_1(E(\mathcal{T}_{\mu, 2-\mu, A}))$ gives an isomorphism between $\pi_1(X_\mu^+)$ and $\pi_1(X_\mu^-)$; this contradicts the facts that $\pi_1(X_{-3}^+)$ is isomorphic to \mathbb{Z} and $\pi_1(X_{-3}^-)$ isomorphic to the torus knot group $\pi_1(E(\mathcal{K}_{2,3}))$ and that when $\mu < -3$, $(\frac{-1-\mu}{2}, \frac{1-\mu}{2})$ - and $(\frac{1-\mu}{2}, \frac{3-\mu}{2})$ -torus knots are never equivalent, up to mirror image. \square

Remark 6.1. Since $(\mathbb{S}^3, \mathcal{T}_{3,3}) \in \mathcal{V}$ and $(\mathbb{S}^3, \mathcal{T}_{-3,5}) \in \mathcal{V}'$ are equivalent to the mirror images of $(\mathbb{S}^3, 5_2)$ and $(\mathbb{S}^3, 6_4)$ in [16], respectively (Figs. 4.3b and 5.2a.), we obtain

$$MCG(\mathbb{S}^3, 5_2) \simeq MCG_+(\mathbb{S}^3, 5_2) \simeq \mathbb{Z}_2 \times \mathbb{Z}_2, \text{ and } MCG(\mathbb{S}^3, 6_4) \simeq MCG_+(\mathbb{S}^3, 6_4) \simeq \mathbb{Z}_2.$$

For our last example, we observe that the proof of Corollary 6.3, that is, Corollary 3.6 and Theorem 6.1, implies the following.

Corollary 6.7. *Suppose the slope type of A is not $(\frac{p+1}{2}, \frac{p-1}{2})$ and l_i , $i = 1, 2$, are non-invertible knots in \mathbb{S}^3 . Then $MCG(\mathbb{S}^3, \text{HK}) \simeq MCG_+(\mathbb{S}^3, \text{HK}) = 1$.*

Proof. Since the slope type of A is not $(\frac{p+1}{2}, \frac{p-1}{2})$, any non-trivial element in $MCG_+(\mathbb{S}^3, \text{HK})$ is represented by a homeomorphism $f \in \mathcal{H}omeo_+(\mathbb{S}^3, \text{HK}, A)$ whose restriction $f|_A$ on A reverses the orientation of l_1, l_2 . \square

For example, consider the knot 8_{16} in the Rolfsen knot table with a tunnel τ depicted in Fig. 6.5a. Let \mathcal{A} be the p -annulus associated to $(8_{16}, \tau)$ given in Fig. 6.5b where $\mu + \nu = p$. Denote by $(\mathbb{S}^3, \mathcal{U}_{\mu, \nu})$ and A the handlebody-kont $(\mathbb{S}^3, \text{HK}^{\mathcal{A}, \tau})$ and the type 3-3 annulus obtained by the construction in Section 4.2, respectively.

The isotopy in Fig. 6.5c shows that a regular neighborhood of $8_{16} \cup \tau$ in \mathbb{S}^3 is equivalent to the mirror image $(\mathbb{S}^3, m5_1)$ of $(\mathbb{S}^3, 5_1)$ in the handlebody-knot table [16]. Thus by Corollary 4.4 and Lemma 4.8, $(\mathbb{S}^3, \mathcal{U}_{\mu, \nu})$ is irreducible and atoroidal, for every $\mu, \nu \in \mathbb{Z}$.

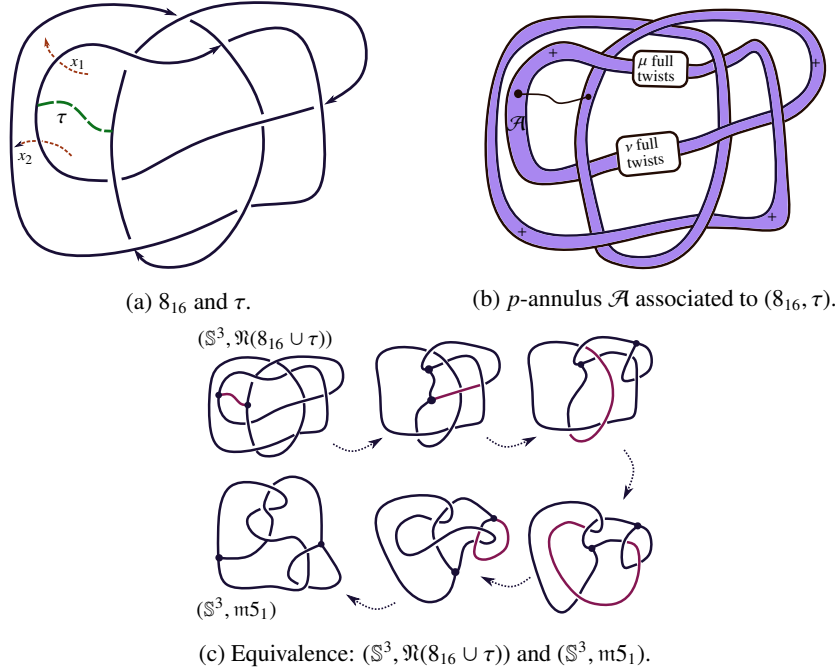

FIGURE 6.5. Construction of $(\mathbb{S}^3, \mathcal{U}_{\mu, \nu})$.

Now, in terms of the meridional basis of $H_1(E(\mathcal{U}_{\mu,\nu}))$ given by x_1, x_2 in Fig. 6.5a and with the orientation of A in Fig. 6.5b, we have $[L_+] = (\mu, \nu)$, $[L_-] = (\mu - 1, \nu + 1)$. Hence for every member $(\mathbb{S}^3, \text{HK})$ in the handlebody-knot family

$$\mathcal{U} := \{(\mathbb{S}^3, \mathcal{U}_{\mu,\nu}) \mid \mu > \nu + 1 > 1 \text{ or } 0 > \mu > \nu + 1\}.$$

the meridional basis is normalized, the slope type of A is not $(\frac{p+1}{2}, \frac{p-1}{2})$, and none of l_+, l_- represents the $|p|$ -th multiple of some generator of $H_1(E(\text{HK}_A))$. Thus up to isotopy, $A \subset E(\text{HK})$ is the unique type 3-3 annulus by Theorem 5.2, and $\text{MCG}(\mathbb{S}^3, \text{HK}) = 1$ by Corollary 6.7. In addition, \mathcal{U} is an infinite family.

REFERENCES

- [1] G. Bellettini, M. Paolini, Y.-S. Wang, *Numerical irreducibility criteria for handlebody links*, Topology Appl. **284** (2020), 107361.
- [2] F. Bonahon, J.-P. Otal, *Scindements de Heegaard des espaces lenticulaires*, Ann. Sci. Éc. Norm. Supér. **16** (1983), 451–466.
- [3] S. Cho, Y. Koda, *Topological symmetry groups and mapping class groups for spatial graphs*, Michigan Math. J. **62** (2013), 131–142.
- [4] M. Cohen, W. Metzler, A. Zimmermann, *What does a basis of $F(a, b)$ look like?* Math. Ann. **257** (1981), 435–445.
- [5] M. Eudave-Munoz, Y. Uchida, *Non-simple links with tunnel number one*, Proc. Am. Math. Soc. **124** (1996), 1567–1575.
- [6] K. Funayoshi, Y. Koda, *Extending automorphisms of the genus-2 surface over the 3-sphere*, Q. J. Math. **71** (2020), 175–196.
- [7] L. Goeritz, *Die Abbildungen der Berzelfläche und der Volbrezel vom Gesschlect 2* Abh. Math. Sem. Univ. Hamburg **9** (1933), 244–259.
- [8] M.-E. Hamstrom, *Homotopy groups of the space of homeomorphisms on a 2-manifold*, Illinois J. Math. **10** (1966), 563–573.
- [9] A. Hatcher, *Homeomorphisms of sufficiently large P^2 -irreducible 3-manifolds*, Topology **15** (1976) 343–347.
- [10] A. Hatcher, *Spaces of incompressible surfaces*, arXiv:math/9906074 [math.GT].
- [11] C. Hayashi, K. Shimokawa, *Thin position of a pair (3-manifold, 1-submanifold)*, Pacific J. Math. **197** (2001) 301–324.
- [12] W. H. Holzmann, *An equivariant torus theorem for involutions*, Trans. Amer. Math. Soc. **326** (1991), 887–906.
- [13] A. Ishii, M. Iwakiri, *Quandle cocycle invariants for spatial graphs and knotted handlebodies*, Canad. J. Math. **64** (2012), 102–122.
- [14] A. Ishii, M. Iwakiri, Y. Jang, K. Oshiro, *A G -family of quandles and handlebody-knots*, Illinois J. Math. **57** (2013), 817–838.
- [15] A. Ishii, K. Kishimoto: *The quandle coloring invariant of a reducible handlebody-knot*, Tsukuba J. Math. **35** (2011), 131–141.
- [16] A. Ishii, K. Kishimoto, H. Moriuchi, M. Suzuki, *A table of genus two handlebody-knots up to six crossings*, J. Knot Theory Ramifications **21**(4), (2012) 1250035.
- [17] A. Ishii, K. Kishimoto, M. Ozawa, *Knotted handle decomposing spheres for handlebody-knots*, J. Math. Soc. Japan **67** (2015), 407–417.
- [18] K. Johannson, *Topology and combinatorics of 3-manifolds*, Lecture Notes in Math. **1599**, Berlin: Springer-Verlag (1995).
- [19] A. Kawachi, *A Survey of Knot Theory*, Birkhäuser Basel (1996).
- [20] Y. Koda, M. Ozawa, with an appendix by C. Gordon, *Essential surfaces of non-negative Euler characteristic in genus two handlebody exteriors*, Trans. Amer. Math. Soc. **367** (2015), no. 4, 2875–2904.
- [21] Y. Koda, *Automorphisms of the 3-sphere that preserve spatial graphs and handlebody-knots*, Math. Proc. Cambridge Philos. Soc. **159** (2015), 1–22.
- [22] J. H. Lee, S. Lee, *Inequivalent handlebody-knots with homeomorphic complements*, Algebr. Geom. Topol. **12** (2012), 1059–1079.
- [23] K. Morimoto, M. Sakuma, *On unknotting tunnels for knots*, Math. Ann. **289** (1991), 143–167.
- [24] M. Motto, *Inequivalent genus two handlebodies in S^3 with homeomorphic complements*, Topology Appl. **36**, (1990), 283–290.
- [25] S. Okazaki, *An invariant derived from the Alexander polynomial for handlebody-knots*, Osaka J. Math. **57** 2020, 737–750.
- [26] R. P. Osborne, H. Zieschang, *Primitives in the free group on two generators*, Invent. math. **63** (1981), 17–24.
- [27] O. Schreier, *Über die Gruppen $A^a B^b = 1$* , Abh. Math. Sem: Univ. Hamburg **3** (1929), 167–169.
- [28] H. Seifert, *Topologie dreidimensionaler gefaserner Räume*, Acta Math. **60** (1933), 147–288.

- [29] J. Simon, *Topological chirality of certain molecules*, *Topology* **25** (1986), 229–235.
- [30] J. L. Tollefson, *Involutions of sufficiently large 3-manifolds*, *Topology* **20**, (1981), 323–352.
- [31] C. M. Tsau, *Incompressible surfaces in the knot manifolds of torus knots*, *Topology* **33** (1994), 197–201.
- [32] Y.-S. Wang, *Unknotting annuli and handlebody-knot symmetry*, arXiv:2104.04272 [math.GT].
- [33] H. Zieschang, *On simple systems of paths on complete pretzels*, *Amer. Math. Soc. Transl.*, **92** (1970), 127–137

INSTITUTE OF MATHEMATICS, ACADEMIA SINICA, TAIPEI CITY 106, TAIWAN
Email address: yisheng@gate.sinica.edu.tw