

BORDERED MANIFOLDS WITH TORUS BOUNDARY AND THE LINK SURGERY FORMULA

IAN ZEMKE

ABSTRACT. We prove a connected sum formula for Manolescu and Ozsváth’s link surgery formula. We interpret the connected sum formula as an A_∞ -tensor product over an associative algebra \mathcal{K} , which we introduce. More generally, we are able to interpret the link surgery formula as associating a type- D and type- A module to a bordered 3-manifold with torus boundary. Our connected sum formula gives a pairing theorem which computes the minus Heegaard Floer homology of the glued manifold. We apply our tools to give a combinatorial algorithm to compute the minus Heegaard Floer homology of 3-manifolds obtained by plumbing along a tree. We prove that for such 3-manifolds, Heegaard Floer homology is isomorphic to a deformation of lattice homology, and we give an algorithm to compute the deformation. Finally, if K_1 and K_2 are knots in S^3 , and Y is obtained by gluing the complements of K_1 and K_2 together using any orientation reversing diffeomorphism of their boundaries, then we give a formula which computes $CF^-(Y)$ from $CFK^\infty(K_1)$ and $CFK^\infty(K_2)$.

CONTENTS

1. Introduction	3
1.1. The knot surgery algebra	3
1.2. Surgery formulas as A_∞ -modules	3
1.3. A pairing theorem	4
1.4. Bordered manifolds with torus boundary	4
1.5. Splicing knot complements	5
1.6. Plumbed 3-manifolds	7
1.7. Acknowledgments	9
2. Hypercubes and Heegaard Floer homology	9
2.1. Background on Heegaard Floer homology	9
2.2. Hyperboxes of chain complexes	11
2.3. Compressing hyperboxes	11
2.4. Hypercubes of attaching curves	12
2.5. More hypercubes	13
3. Background on A_∞ -modules	15
3.1. Type- A and type- D modules	15
3.2. Bimodules	16
3.3. The Lipshitz–Ozsváth–Thurston box tensor product	16
3.4. Morphisms of modules and bimodules	17
3.5. Extension of scalars	19
3.6. Completions	22
4. The homological perturbation lemma and variations	25
4.1. A_∞ -modules	25

4.2.	DA -bimodules	26
4.3.	Hypercubes	27
4.4.	Hypercubes of DA -bimodules	28
5.	Background on the link surgery formula	29
5.1.	Statement of the link surgery formula	29
5.2.	Gradings and algebraic reduction maps	31
5.3.	On the algebra of the link surgery formula	33
6.	The knot surgery algebra	37
6.1.	The algebra \mathcal{K}	37
6.2.	The log-topology on \mathcal{K}	37
6.3.	The framing module	39
6.4.	The merge bimodule	40
6.5.	The knot surgery formula over \mathcal{K}	43
6.6.	A_∞ perspectives on the link surgery formula	45
7.	Basic systems of Heegaard diagrams	47
7.1.	Basic systems	47
7.2.	Tensor products of hypercubes of attaching curves	49
7.3.	Basic systems and connected sums of links	51
8.	Hypercubes and disconnected Heegaard surfaces	51
8.1.	Small translate theorems	52
8.2.	Disconnected Heegaard surfaces	53
9.	Connected sums and hypercubes	57
9.1.	Cylindrical boundary degenerations	58
9.2.	Warm up: Connected sums and Floer complexes	59
9.3.	Connected sums and hypercubes	65
10.	The pairing theorem	72
10.1.	The statement	72
10.2.	Unpacking the statement	72
10.3.	Proof of the pairing theorem	74
11.	On the link Floer homology of Hopf links	76
11.1.	The surgery complex of the Hopf link	77
11.2.	A_∞ perspectives on the Hopf link complex	83
11.3.	Minimal models for the Hopf link complex	85
12.	The Hopf link over \mathcal{K}	88
12.1.	The DA -bimodule of the Hopf link surgery complex	88
12.2.	Minimal models over \mathcal{K}	90
13.	The Heegaard Floer homology of plumbed 3-manifolds	94
13.1.	Elementary plumbing tangles	94
13.2.	Bimodules for elementary plumbing tangles	95
13.3.	Computing the Heegaard Floer homology of plumbed 3-manifolds	95
13.4.	Comparison with lattice homology	96
14.	Blow-ups and meridional Dehn twists	98
	Appendix A. Connected sums and splicing operations	102
A.1.	Splices and connected sums	102
A.2.	The Hopf link and changes of parametrization	103
	References	103

1. INTRODUCTION

In this paper, we define several algebraic objects associated to a compact, oriented 3-manifold with parametrized torus boundary, and prove a gluing formula. For the purposes of this paper, we use the following definition (compare [LOT18, Section 1.1]):

Definition 1.1. A *bordered manifold with torus boundary* consists of a compact, oriented and connected manifold M such that $\partial M \cong \mathbb{T}^2$, and M is equipped with a choice of oriented basis (μ, λ) of $H_1(\partial M)$.

If M_1 and M_2 are two bordered manifolds with torus boundaries, a natural gluing operation is to glue μ_1 to μ_2 and glue λ_1 to $-\lambda_2$. This is motivated by the following fact. Suppose that M_1 and M_2 are the complements of two oriented knots K_1 and K_2 in S^3 , which are given Morse framings λ_1 and λ_2 . Let $\phi: \partial M \rightarrow \partial N$ denote the orientation reversing diffeomorphism which sends μ_1 to μ_2 and λ_1 to $-\lambda_2$. Then there is a diffeomorphism

$$M \cup_{\phi} N \cong S^3_{\lambda_1 + \lambda_2}(K_1 \# K_2).$$

This basic topological fact is reviewed in Appendix A.

We define our algebraic objects using Lipshitz, Ozsváth and Thurston’s framework of type- A and type- D modules [LOT18]. The type- A and type- D modules we define are reformulations of Manolescu and Ozsváth’s link surgery formula [MO10]. Using the above topological observation about surgeries on connected sums, our gluing formula amounts to a formula for the behavior of the link surgery formula under connected sums.

1.1. The knot surgery algebra. We now describe our associative algebra \mathcal{K} , which is an algebra over the idempotent ring $\mathbf{I} = \mathbf{I}_0 \oplus \mathbf{I}_1$, where each \mathbf{I}_i is a copy of $\mathbb{F} = \mathbb{Z}/2\mathbb{Z}$. We define

$$\mathbf{I}_0 \cdot \mathcal{K} \cdot \mathbf{I}_0 = \mathbb{F}[\mathcal{U}, \mathcal{V}] \quad \text{and} \quad \mathbf{I}_1 \cdot \mathcal{K} \cdot \mathbf{I}_1 = \mathbb{F}[\mathcal{U}, \mathcal{V}, \mathcal{V}^{-1}],$$

where $\mathbb{F}[\mathcal{U}, \mathcal{V}]$ denotes a polynomial ring in two variables and $\mathbb{F}[\mathcal{U}, \mathcal{V}, \mathcal{V}^{-1}]$ is its localization at \mathcal{V} . We set $\mathbf{I}_0 \cdot \mathcal{K} \cdot \mathbf{I}_1 = 0$. We now describe $\mathbf{I}_1 \cdot \mathcal{K} \cdot \mathbf{I}_0$. There are two special algebra homomorphisms, $I, T: \mathbb{F}[\mathcal{U}, \mathcal{V}] \rightarrow \mathbb{F}[\mathcal{U}, \mathcal{V}, \mathcal{V}^{-1}]$. The map I is given by the canonical inclusion. The map T is determined by the relations

$$T(\mathcal{U}) = \mathcal{V}^{-1} \quad \text{and} \quad T(\mathcal{V}) = \mathcal{U}\mathcal{V}^2.$$

With the above notation in place, we now describe $\mathbf{I}_1 \cdot \mathcal{K} \cdot \mathbf{I}_0$. There are two special generators of $\mathbf{I}_1 \cdot \mathcal{K} \cdot \mathbf{I}_0$, which we denote by σ and τ . If $f \in \mathbf{I}_0 \cdot \mathcal{K} \cdot \mathbf{I}_0 = \mathbb{F}[\mathcal{U}, \mathcal{V}]$, then σ and τ satisfy the relations

$$\sigma \cdot f = I(f) \cdot \sigma \quad \text{and} \quad \tau \cdot f = T(f) \cdot \tau.$$

The algebra \mathcal{K} has vanishing μ_j for $j \neq 2$.

1.2. Surgery formulas as A_{∞} -modules. Ozsváth and Szabó [OS08b] proved that if $K \subseteq S^3$ is a knot, then the Heegaard Floer homology groups $HF^-(S^3_{\lambda}(K))$ could be computed from the knot Floer complex of K [OS04a] [Ras03]. If λ is a Morse framing on K , their construction produced a mapping cone complex $\mathbb{X}_{\lambda}(K)$, which satisfied

$$H_*(\mathbb{X}_{\lambda}(K)) \cong \mathbf{HF}^-(S^3_{\lambda}(K)).$$

See [OS08b]. (The bold font denotes coefficients in the power series ring $\mathbb{F}[[U]]$).

Manolescu and Ozsváth [MO10] extended this formula to links in S^3 . They proved that if $L \subseteq S^3$ is a link with integral framing Λ , then there is a complex $\mathbb{X}_\Lambda(L)$, defined using the link Floer homology of L [OS08a], such that

$$H_*(\mathbb{X}_\Lambda(L)) \cong \mathbf{HF}^-(S_\Lambda^3(L)).$$

In Section 6.5, we describe how to naturally interpret Ozsváth and Szabó's mapping cone complex $\mathbb{X}_\lambda(K)$ as both a right type- D module $\mathcal{X}_\lambda(K)^\mathcal{K}$ and a left type- A module ${}_\mathcal{K}\mathcal{X}_\lambda(K)$. In Section 6.6, we extend this interpretation to the link surgery formula. To an ℓ -component link $L \subseteq S^3$, we define a type- D module

$$\mathcal{X}_\Lambda(L)^{\otimes \ell \mathcal{K}}.$$

We may turn any number of right type- D factors into left type- A factors via a tensor product. Also, we may eliminate type- D tensor factors by tensoring with a *framing module* ${}_\mathcal{K}[\mathcal{F}_0]$, which one may think of as the invariant for a solid torus. See Section 6.6.

Remark 1.2. In approximate terms, the map v in Ozsváth and Szabó's mapping cone formula is encoded by the algebra element $\sigma \in \mathcal{K}$. The map h is encoded by the algebra element $\tau \in \mathcal{K}$.

1.3. A pairing theorem. One of the central results of our paper is a connected sum formula for the Manolescu–Ozsváth integer surgery formula. Suppose L_1 and L_2 are two links in S^3 , which have framings Λ_1 and Λ_2 , as well as distinguished components $K_1 \subseteq L_1$ and $K_2 \subseteq L_2$. In Section 6.6, we describe how to compute $\mathbb{X}_{\Lambda_1 + \Lambda_2}(L_1 \# L_2)$ in terms of $\mathbb{X}_{\Lambda_1}(L_1)$ and $\mathbb{X}_{\Lambda_2}(L_2)$. Here, $L_1 \# L_2$ denotes the connected sum of L_1 and L_2 along K_1 and K_2 , and $\Lambda_1 + \Lambda_2$ denotes the framing where we sum the framings on K_1 and K_2 and leave the others unchanged. We interpret this connected sum formula as an A_∞ tensor product over the algebra \mathcal{K} . We use the algebraic framework of Lipshitz, Ozsváth and Thurston extensively [LOT18] [LOT15] [LOT20]. Our formula is simplest to state when we are working with knots:

Theorem 1.3. *Suppose that (Y_1, K_1) and (Y_2, K_2) are two knots in integer homology 3-spheres with integral framings λ_1 and λ_2 . Then*

$$\mathbb{X}_{\lambda_1 + \lambda_2}(Y_1 \# Y_2, K_1 \# K_2) \simeq \mathcal{X}_{\lambda_1}(Y_1, K_1)^\mathcal{K} \hat{\boxtimes} {}_\mathcal{K}\mathcal{X}_{\lambda_2}(Y_2, K_2).$$

Here, $\hat{\boxtimes}$ denotes a completed version of Lipshitz, Ozsváth and Thurston's box tensor product [LOT18]. There is also a version of the above theorem for links:

Theorem 1.4. *Suppose that L_1 and L_2 are two links in S^3 with integral framings Λ_1 and Λ_2 , and that we have two distinguished components $K_1 \subseteq L_1$ and $K_2 \subseteq L_2$. Then*

$$\mathbb{X}_{\Lambda_1 + \Lambda_2}(L_1 \# L_2) \simeq \mathcal{X}_{\Lambda_1}(L_1)^\mathcal{K} \hat{\boxtimes} {}_\mathcal{K}\mathcal{X}_{\Lambda_2}(L_2).$$

We prove several stronger versions of the above statement, which involve A_∞ -bimodules. See Section 6.6 for additional details.

1.4. Bordered manifolds with torus boundary. In this section, we describe how to associate a type- D module $\mathcal{X}(M)^\mathcal{K}$ and a type- A module ${}_\mathcal{K}\mathcal{X}(M)$ to a bordered manifold M with torus boundary.

It is a basic topological fact that any bordered 3-manifold M is diffeomorphic to integral surgery on a link $L \subseteq S^3 \setminus N(U)$, where U is an unknot. Furthermore we may assume that the diffeomorphism respects the boundary parametrization, in the sense

that the meridian of U maps to μ , and the 0-framed longitude of U maps to λ . As described above, the link surgery formula for $L \cup U$ may be naturally viewed as a type- D module over $\mathcal{K}^{\otimes(\ell+1)}$, where $|L| = \ell$. However, there is a convenient way of reducing the number algebras in our setting, corresponding to taking the tensor product with *framing modules*. This leaves a type- D module $\mathcal{X}_\Lambda(L \cup U)^\mathcal{K}$, where the algebra \mathcal{K} is thought of as corresponding to the component U . We will also see how to view this as a type- A module ${}_\mathcal{K}\mathcal{X}_\Lambda(L \cup U)$. Hence, to a bordered 3-manifold M , we may associate the type- D module

$$\mathcal{X}(M)^\mathcal{K} := \mathcal{X}_\Lambda(S^3, L \cup U)^\mathcal{K}$$

as well as the type- A module ${}_\mathcal{K}\mathcal{X}(M) := {}_\mathcal{K}\mathcal{X}_\Lambda(L \cup U)$.

Remark 1.5. In a future work we hope to prove that the module $\mathcal{X}_\Lambda(L \cup U)^\mathcal{K}$ depends only on M , and not the link L . One strategy would be to show that $\mathcal{X}(M)^\mathcal{K}$ is invariant under Kirby calculus for manifolds with boundary. Most of the steps follow from computations in this paper. See Section 14 for several key computations. The one step that remains is invariance under handleslides amongst the components of L .

We recall that $S_{\lambda_1+\lambda_2}^3(K_1 \# K_2)$ is homeomorphic to the manifold obtained by gluing the complements of K_1 and K_2 together so that $\mu_1 \mapsto \mu_2$ and $\lambda_1 \mapsto -\lambda_2$. See Appendix A. A similar statement holds for taking the connected sum of links. Hence, Theorem 1.4 gives the following corollary:

Theorem 1.6. *Let M and N be bordered 3-manifolds, and let $\phi: \partial M \rightarrow \partial N$ be the orientation reversing diffeomorphism which sends μ_M to μ_N and sends λ_M to $-\lambda_N$. Then*

$$\mathcal{X}(M)^\mathcal{K} \hat{\boxtimes} {}_\mathcal{K}\mathcal{X}(N) \simeq \mathbf{CF}^-(M \cup_\phi N).$$

The above theorem is stated only on the level of vector spaces. On the other hand, there is a natural way to view $\mathcal{X}(N)$ also as a bimodule ${}_\mathcal{K}\mathcal{X}(N)_{\mathbb{F}[[U]]}$. The above theorem has a natural refinement:

$$\mathcal{X}(M)^\mathcal{K} \hat{\boxtimes} {}_\mathcal{K}\mathcal{X}(N)_{\mathbb{F}[[U]]} \simeq \mathbf{CF}^-(M \cup_\phi N)_{\mathbb{F}[[U]]}.$$

See Section 6.3.

The construction and pairing theorem naturally extend to manifolds with multiple toroidal boundary components, as long as we glue along only one boundary component at a time.

1.5. Splicing knot complements. Inspired by [LOT15], we may construct bimodules for changing the boundary parametrization. If $\phi: \mathbb{T}^2 \rightarrow \mathbb{T}^2$ is an orientation preserving diffeomorphism, then there is a bimodule ${}_\mathcal{K}[\phi]^\mathcal{K}$. This bimodule is the bordered invariant for $[0, 1] \times \mathbb{T}^2$ with basis $(\mu, -\lambda)$ on $\{0\} \times \mathbb{T}^2$ (where we write μ and λ for a standard basis of $H_1(\mathbb{T}^2)$), and $(\phi(\mu), \phi(\lambda))$ on $\{1\} \times \mathbb{T}^2$. Instead of considering the general case, it is helpful to consider two special cases, which are sufficient because they form a generating set of $\text{MCG}(\mathbb{T}^2)$:

- (1) $\phi(\mu) = \mu$ and $\phi(\lambda) = \lambda \pm \mu$.
- (2) $\phi(\mu) = \pm\lambda$ and $\phi(\lambda) = \mp\mu$.

In both of the above cases, the bimodule ${}_\mathcal{K}[\phi]^\mathcal{K}$ is obtained from the surgery complex for the Hopf link, viewed algebraically as a DA -bimodule over $(\mathcal{K}, \mathcal{K})$. Note that the Hopf link has complement $[0, 1] \times \mathbb{T}^2$. In this paper, we study the Hopf link complex

extensively. In Section 11 we compute Manolescu and Ozsváth’s link surgery hypercube for the negative Hopf link. In Section 12, we describe the Hopf link complex over \mathcal{K} , and also describe minimal models using the homological perturbation lemma.

For the diffeomorphism $\phi(\mu) = \mu$ and $\phi(\lambda) = \lambda \pm \mu$, we may think of tensoring the bimodule $\mathcal{K}[\phi]^{\mathcal{K}}$ as having the effect of changing the framing of a link component by ± 1 . Equivalently, this may be described by blowing up along a meridian of our original link. This bimodule has a very simple minimal model. See Section 14 for the computation.

For the diffeomorphism $\phi(\mu) = \pm\lambda$ and $\phi(\lambda) = \mp\mu$, the corresponding bimodule $\mathcal{K}[\phi]^{\mathcal{K}}$ is obtained from the Hopf link surgery complex, where the first component of the Hopf link is the type- A component, and the second component is the type- D component.

In Section 12, we compute the surgery complex of the negative Hopf link, and also compute a minimal model in Proposition 12.2. Using our conventions, the negative Hopf link corresponds to the diffeomorphism $\phi(\mu) = \lambda$ and $\phi(\lambda) = -\mu$.

We obtain an algorithm to compute \mathbf{CF}^- of the 3-manifold obtained by gluing knot complements together. Consider the bordered manifolds M_1 and M_2 , obtained by decorating $S^3 \setminus N(K_1)$ and $S^3 \setminus N(K_2)$ with Morse framings λ_1 and λ_2 , and suppose we have an arbitrary orientation reversing diffeomorphism

$$\psi: \partial(S^3 \setminus N(K_1)) \rightarrow \partial(S^3 \setminus N(K_2)).$$

We let $\phi: \partial(S^3 \setminus N(K_1)) \rightarrow \partial(S^3 \setminus N(K_1))$ be the diffeomorphism which sends μ_1 to $\psi^{-1}(\mu_2)$ and λ_1 to $-\psi^{-1}(\lambda_2)$.

Theorem 1.7. *Let K_1 and K_2 be knots in S^3 and let M_1 and M_2 be their complements, as above. Then*

$$\mathbf{CF}^-(M_1 \cup_{\psi} M_2)_{\mathbb{F}[[U]]} \simeq \mathcal{X}_{\lambda_1}(K_1)^{\mathcal{K}} \hat{\boxtimes} \mathcal{K}[\phi]^{\mathcal{K}} \hat{\boxtimes} \mathcal{K}\mathcal{X}_{\lambda_2}(K_2)_{\mathbb{F}[[U]]}.$$

In general, we do not yet have a closed formula for the bimodule $\mathcal{K}[\phi]^{\mathcal{K}}$ for an arbitrary diffeomorphism ϕ , and instead it must be computed by decomposing ϕ into a sequence of the generators of $\text{MCG}(\mathbb{T}^2)$ described above.

Remark 1.8. When K_1 and K_2 are knots in S^3 , the modules $\mathcal{X}_{\lambda_1}(K_1)^{\mathcal{K}}$ and $\mathcal{K}\mathcal{X}_{\lambda_2}(K_2)_{\mathbb{F}[[U]]}$ are determined by the full knot Floer complexes $CFK^{\infty}(K_1)$ and $CFK^{\infty}(K_2)$, up to homotopy equivalence.

Remark 1.9. The above description of a bimodule $\mathcal{K}[\phi]^{\mathcal{K}}$ gives a new interpretation of the Eftekhary–Hedden–Levine dual knot formula [Eft06] [HL19]. They computed the knot Floer complex of the dual knot $K^* \subseteq S^3_{\lambda}(K)$ in terms of the knot Floer homology $CFK^{\infty}(K)$. In our new framework, their formula computes part of our bordered invariant for $S^3 \setminus N(K)$ with a different boundary parametrization. (Note that Eftekhary’s statement and proof had some errors which were corrected by Hedden and Levine).

Indeed, if K is a knot in S^3 and $\mathcal{K}[\phi]^{\mathcal{K}}$ corresponds to a diffeomorphism satisfying $\phi(\mu) = \pm\lambda$ and $\phi(\lambda) = \mp\mu$, then the invariant $\mathcal{X}_{\lambda}(K)^{\mathcal{K}} \hat{\boxtimes} \mathcal{K}[\phi]^{\mathcal{K}}$ may be identified with the Eftekhary–Hedden–Levine formula, enhanced by the data necessary to do further surgeries (i.e. enhanced with the data of the map h from Ozsváth and Szabó’s surgery formula, also sometimes referred to as the *flip map*). Note that the techniques of Eftekhary and Hedden–Levine do not compute this enhancement.

The dual-knot formula is also explored in [HHSZ21a], where an extension is proven for Hendricks and Manolescu’s involutive knot Floer homology [HM17]. The fact that $\mathcal{X}_\lambda(K)^\mathcal{K} \hat{\boxtimes}_{\mathcal{K}}[\phi]^\mathcal{K}$ recovers the Eftekhary–Hedden–Levine formula is explained in more detail in [HHSZ21a].

Remark 1.10. The algebraic framework of this paper is largely inspired by the work of Lipshitz, Ozsváth and Thurston [LOT18]. Their original construction computes \widehat{CF} of the manifold obtained by gluing two bordered manifolds. A long standing goal of their program has been to construct a version which computes CF^- . Recently, they have described the algebra of their minus invariant in the case of torus boundary [LOT21]. The modules over their algebra are forthcoming. An inspiring problem is to relate our invariant with theirs.

1.6. Plumbed 3-manifolds. In our paper, we also consider manifolds obtained by plumbing disk bundles over spheres according to a plumbing tree. These manifolds may also be described as integral surgery on an iterated connected sum of Hopf links. Such a 3-manifold is usually encoded by a graph G , which we assume is a tree, equipped with an integer weight at each vertex. The graph G encodes a framed link $L_G \subseteq S^3$, which has one component for each vertex, and has one clasp for each edge of G . We write $Y(G)$ for the manifold obtained by surgering S^3 along L_G .

The Heegaard Floer homologies of such 3-manifolds are studied extensively. Ozsváth and Szabó [OS03] computed $CF^-(Y(G))$ in the case that G was negative definite and had at most one *bad vertex* (a bad vertex is one where the valence exceeds minus the framing). Their construction was generalized by Némethi [Ném05] [Ném08], who introduced *lattice homology* $\mathbb{H}\mathbb{F}_\Lambda(G)$, which formalized Ozsváth and Szabó’s computation. Némethi conjectured that lattice homology is always isomorphic to Heegaard Floer homology for plumbed 3-manifolds [Ném08, Section 5.2.4]. Extending the cases proved in [OS03], the conjecture was proven for a family of plumbed 3-manifolds obtained from *type-2* graphs by Ozsváth, Stipsicz and Szabó [OSS14], though in general the conjecture remains open.

By using an extension of Theorem 1.4 which involves a pairing theorem for bimodules, the problem of computing the Heegaard Floer homology of plumbed 3-manifolds reduces to the computation of the link surgery complex of the Hopf link. We do this in Sections 11 and 12.

To efficiently describe the surgery complex associated to a plumbing tree, we construct a framework of *elementary plumbing tangles* in Section 13.1. We define four types of elementary plumbing tangles, which we call *leaf*, *Hopf*, *merge* and *root* tangles. These are a restricted family of oriented tangles. If G is a plumbing tree, and L_G is the corresponding link, obtained by taking an iterated connected sum of Hopf links, we may decompose L_G into a sequence of elementary plumbing tangles. See Figure 1.1 for an example.

To each elementary plumbing tangle T with $2m$ points on its upper boundary, and $2n$ points along its lower boundary, we define a DA bimodule $\mathcal{K}^{\otimes m} \mathcal{W}(T)^{\mathcal{K}^{\otimes n}}$. The bimodule $\mathcal{W}(T)$ depends on the framing on L_G . We organize this dependency to only appear in the bimodules for Hopf and root tangles.

The bimodules for leaf, merge and root tangles are defined purely algebraically, though the bimodules for Hopf tangles are built from the surgery complex of the Hopf

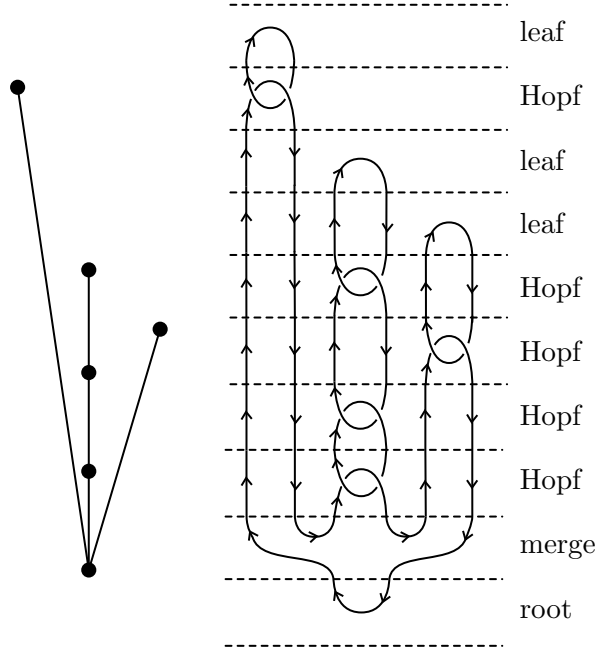

FIGURE 1.1. A plumbing tree G (left) and the link L_G (right), decomposed into elementary plumbing tangles.

link. We expect the bimodules for leaf, merge and root tangles to also have interpretations in terms of the bordered invariant for a solid torus or a trivial S^1 -bundle over a pair of pants, but we do not pursue this interpretation in our present work.

The Hopf bimodules are the most interesting. Write the Hopf link as $H = L_1 \cup L_2$. We may view the Hopf link surgery complex as a DA -bimodule over $(\mathcal{K}, \mathcal{K})$. Give the Hopf link a framing $\Lambda = (\lambda_1, 0)$, where λ_1 is the framing of L_1 , and 0 is the framing of L_2 . We obtain a DA -bimodule which we denote by

$$\kappa_1 \mathcal{H}_\Lambda^{\mathcal{K}_2}. \quad (1.1)$$

(Here \mathcal{K}_i denotes a copy of \mathcal{K} , thought of as being associated to L_i). There is a convenient minimal model, which we denote as

$$\kappa_1 \mathcal{Z}_\Lambda^{\mathcal{K}_2}. \quad (1.2)$$

In general, a Hopf tangle may have extra strands which are not involved in the clasp, and a formal algebraic operation can be used to extend the surgery bimodules in equations (1.1) and (1.2) over the remaining algebra factors. In constructing the bimodule ${}_{\mathcal{A}}\mathcal{W}(T)^{\mathcal{A}'}$ for a Hopf tangle, we may use either $\kappa_1 \mathcal{H}_\Lambda^{\mathcal{K}_2}$ or $\kappa_1 \mathcal{Z}_\Lambda^{\mathcal{K}_2}$, since they are homotopy equivalent. We note that the type- A module for the root tangle ${}_{\mathcal{K}}\mathcal{W}(T)$ may naturally be extended to a bimodule ${}_{\mathcal{K}}\mathcal{W}(T)_{\mathbb{F}[[U]]}$.

We prove the following:

Theorem 1.11. *Let G be a connected plumbing tree, and let L_G be the associated framed link, decomposed into a composition of elementary plumbing tangles T_1, \dots, T_n .*

Let \mathcal{A}_{j-1} and \mathcal{A}_j denote the algebras for T_j . Then

$$\mathbf{CF}^-(Y(G))_{\mathbb{F}[[U]]} \simeq \mathcal{W}(T_1)^{\mathcal{A}_1} \hat{\boxtimes}_{\mathcal{A}_1} \mathcal{W}(T_2)^{\mathcal{A}_2} \hat{\boxtimes} \cdots \hat{\boxtimes}_{\mathcal{A}_{n-1}} \mathcal{W}(T_n)_{\mathbb{F}[[U]]}$$

The statement holds regardless of whether we build the Hopf bimodules from $\kappa_1 \mathcal{H}_\Lambda^{\mathcal{K}_2}$ or its minimal model $\kappa_1 \mathcal{Z}_\Lambda^{\mathcal{K}_2}$.

The bimodule $\kappa_1 \mathcal{Z}_\Lambda^{\mathcal{K}_2}$ has only δ_j^1 terms for $j \in \{1, 2, 3\}$. If we omit the δ_3^1 term, we actually are left with a DA -bimodule for which we write $\kappa_1 \mathcal{Z}_\Lambda^{\mathcal{K}_2}$. Using the simpler bimodules $\kappa_1 \mathbb{Z}_\Lambda^{\mathcal{K}_2}$ instead of $\kappa_1 \mathcal{Z}_\Lambda^{\mathcal{K}_2}$, we may construct bimodules ${}_{\mathcal{A}_{i-1}} \mathbb{W}(T_i)^{\mathcal{A}_i}$, which differ from ${}_{\mathcal{A}_{i-1}} \mathcal{W}(T_i)^{\mathcal{A}_i}$ only for the Hopf tangles.

In contrast to Theorem 1.11, we have the following:

Theorem 1.12. *Let G be a connected plumbing tree, and let L_G be the associated framed link, decomposed into a composition of elementary plumbing tangles T_1, \dots, T_n . Let \mathcal{A}_{j-1} and \mathcal{A}_j denote the algebras for T_j . Then*

$$\mathbb{C}\mathbb{F}_\Lambda(G)_{\mathbb{F}[[U]]} \simeq \mathbb{W}(T_1)^{\mathcal{A}_1} \hat{\boxtimes}_{\mathcal{A}_1} \mathbb{W}(T_2)^{\mathcal{A}_2} \hat{\boxtimes} \cdots \hat{\boxtimes}_{\mathcal{A}_{n-1}} \mathbb{W}(T_n)_{\mathbb{F}[[U]]}.$$

Remark 1.13. The model we obtain for $\mathbf{CF}^-(Y(G))$ in Theorem 1.11 is a deformation of lattice homology. In fact, we may derive from the previous two theorems that $\mathbf{CF}^-(Y(G))$ is homotopy equivalent to $(\mathbb{C}\mathbb{F}_\Lambda(G), \partial+h)$ where $(\mathbb{C}\mathbb{F}_\Lambda(G), \partial)$ is the lattice complex, and the map h decreases the cube filtration by at least 3. The map h is explicitly computed by our algorithm, and is in general non-zero. However we do not give any examples in this paper where the two objects differ. In a future work [Zem21], we show that lattice homology and Heegaard Floer homology are isomorphic by extending the techniques of this paper.

Remark 1.14. If G is a plumbing tree, the group $\widehat{HF}(Y(G))$ is computed by Hanselman using bordered Heegaard Floer homology [Han16]. Hanselman's algorithm in fact applies more broadly to all graph manifolds. The missing ingredient in our program for arbitrary graph manifolds is a formula for gluing along two torus boundary components at the same time. We hope to investigate this form of gluing in a future work.

1.7. Acknowledgments. The author would like to thank Antonio Alfieri, Maciej Borodzik, Kristen Hendricks, Jennifer Hom, Robert Lipshitz, Beibei Liu, Ciprian Manolescu, Peter Ozsváth and Matt Stoffregen for helpful conversations.

2. HYPERCUBES AND HEEGAARD FLOER HOMOLOGY

2.1. Background on Heegaard Floer homology. We will assume that the reader is familiar with the basics of Heegaard Floer homology [OS04b], as well as its refinements for knots [OS04a] [Ras03] and links [OS08a]. We provide a brief review to establish notation.

Definition 2.1 ([OS08a, Definition 3.1]).

- (1) A *multi-pointed Heegaard diagram* consists of a tuple

$$(\Sigma, \boldsymbol{\alpha} = \{\alpha_1, \dots, \alpha_{g+n-1}\}, \boldsymbol{\beta} = \{\beta_1, \dots, \beta_{g+n-1}\}, \mathbf{w} = \{w_1, \dots, w_n\})$$

such that $n \geq 1$ and $\boldsymbol{\alpha}$ (resp. $\boldsymbol{\beta}$) are pairwise disjoint, simple closed curves on Σ which are linearly independent in $H_1(\Sigma \setminus \mathbf{w})$. In particular, $\Sigma \setminus \boldsymbol{\alpha}$ consists of

n components, each of which contains a single basepoint $w_i \in \mathbf{w}$, and similarly for $\Sigma \setminus \beta$.

(2) A *Heegaard link diagram with free basepoints* consists of a tuple

$$(\Sigma, \alpha = \{\alpha_1, \dots, \alpha_{g+n-1}\}, \beta = \{\beta_1, \dots, \beta_{g+n-1}\}, \mathbf{w} = \{w_1, \dots, w_m\}, \mathbf{z} = \{z_1, \dots, z_j\})$$

We assume that α and β each span a g -dimensional subspace of $H_1(\Sigma)$. Furthermore, each component of $\Sigma \setminus \alpha$ (resp. $\Sigma \setminus \beta$) contains either a single basepoint of $\mathbf{w} \cup \mathbf{z}$, or contains one basepoint from \mathbf{w} and one basepoint from \mathbf{z} . Furthermore, if p is the sole basepoint in a component of $\Sigma \setminus \alpha$, then p is also the sole basepoint of a component of $\Sigma \setminus \beta$, and vice versa. We call such a basepoint a *free basepoint*. We refer to the other basepoints as *link basepoints*.

Remark 2.2. Usually we assume the free basepoints are all in \mathbf{w} , for notational simplicity.

The curves $\alpha, \beta \subseteq \Sigma$ determine two handlebodies, U_α and U_β , with boundary Σ . A Heegaard link diagram (with free basepoints) determines a 3-manifold Y and an oriented link $L \subseteq Y$. In U_α we assume that the link L is a push-off of a collection of smoothly embedded, pairwise disjoint arcs in $\Sigma \setminus \alpha$ which connect the link-basepoints of \mathbf{w} to the link-basepoints of \mathbf{z} . In U_β , we assume L is a push off of a collection of smoothly embedded, pairwise disjoint arcs which connect the link-basepoints of \mathbf{z} to the link-basepoints of \mathbf{w} . We follow the orientation convention that L intersects Σ positively at \mathbf{z} and negatively at \mathbf{w} .

If $\mathcal{H} = (\Sigma, \alpha, \beta, \mathbf{w})$ is a multi-pointed Heegaard diagram for Y and $\mathfrak{s} \in \text{Spin}^c(Y)$, we define $CF^-(\mathcal{H}, \mathfrak{s})$ to be the free $\mathbb{F}[U_1, \dots, U_n]$ -module generated by intersection points \mathbf{x} of the Lagrangian tori

$$\mathbb{T}_\alpha = \alpha_1 \times \dots \times \alpha_{g+n-1} \quad \text{and} \quad \mathbb{T}_\beta = \beta_1 \times \dots \times \beta_{g+n-1}$$

in the symmetric product $\text{Sym}^{g+n-1}(\Sigma)$, such that $\mathfrak{s}_\mathbf{w}(\mathbf{x}) = \mathfrak{s}$. See [OS04b, Section 2.6] for the definition of the map $\mathfrak{s}_\mathbf{w}: \mathbb{T}_\alpha \cap \mathbb{T}_\beta \rightarrow \text{Spin}^c(Y)$.

The differential counts pseudo-holomorphic representatives of Maslov index 1 flow-lines in $\text{Sym}^{g+n-1}(\Sigma)$, via the formula

$$\partial(\mathbf{x}) = \sum_{\substack{\phi \in \pi_2(\mathbf{x}, \mathbf{y}) \\ \mu(\phi)=1}} \#(\mathcal{M}(\phi)/\mathbb{R}) U_1^{n_{w_1}(\phi)} \dots U_n^{n_{w_n}(\phi)} \cdot \mathbf{y}, \quad (2.1)$$

extended equivariantly over $\mathbb{F}[U_1, \dots, U_n]$.

We will frequently make use of Lipshitz's *cylindrical reformulation* of Heegaard Floer homology [Lip06]. In this formulation, the differential counts holomorphic curves of potentially higher genus in $\Sigma \times [0, 1] \times \mathbb{R}$. We refer the reader to [Lip06] for additional background.

Definition 2.3 ([OS04b]). A *periodic domain* on $\mathcal{H} = (\Sigma, \alpha, \beta, \mathbf{w})$ is a 2-chain P on Σ such that ∂P is an integral linear combination of α and β and $n_\mathbf{w}(P) = 0$. A diagram \mathcal{H} is *weakly admissible* if each non-trivial periodic domain has both positive and negative multiplicities. If $\mathcal{H} = (\Sigma, \alpha, \beta, \mathbf{w}, \mathbf{z})$ is a Heegaard link diagram, we say that \mathcal{H} is weakly admissible if $(\Sigma, \alpha, \beta, \mathbf{w})$ is weakly admissible.

Given a weakly admissible Heegaard diagram \mathcal{H} , we can define a completed version of Heegaard Floer homology $\mathbf{CF}^-(\mathcal{H})$, which is freely generated by $\mathbf{x} \in \mathbb{T}_\alpha \cap \mathbb{T}_\beta$ (with no restriction on Spin^c structures) over the ring $\mathbb{F}[[U_1, \dots, U_n]]$.

We now discuss link Floer homology. In this paper, we use a slightly different version of link Floer homology than appeared in [OS08a]. Instead, we use a version which is a free, finitely generated chain complex over the ring $\mathbb{F}[\mathcal{U}_1, \dots, \mathcal{U}_n, \mathcal{V}_1, \dots, \mathcal{V}_n]$. This version was considered in [Zem17] and [Zem19b]. We define $\mathcal{CFL}^-(\Sigma, \boldsymbol{\alpha}, \boldsymbol{\beta}, \mathbf{w}, \mathbf{z}, \mathfrak{s})$ to be generated over $\mathbb{F}[\mathcal{U}_1, \dots, \mathcal{U}_n, \mathcal{V}_1, \dots, \mathcal{V}_n]$ by intersection points $\mathbf{x} \in \mathbb{T}_\alpha \cap \mathbb{T}_\beta$ such that $\mathfrak{s}_{\mathbf{w}}(\mathbf{x}) = \mathfrak{s}$. The differential is similar to (2.1), except that we weight a holomorphic curve by the product of $\mathcal{U}_i^{n_{w_i}(\phi)} \mathcal{V}_i^{n_{z_i}(\phi)}$, for $i = 1, \dots, n$.

In the case of a doubly pointed Heegaard knot diagram, $\mathcal{H} = (\Sigma, \boldsymbol{\alpha}, \boldsymbol{\beta}, w, z)$, we write $\mathcal{CFK}^-(\mathcal{H}, \mathfrak{s})$ for the complex which is freely generated over $\mathbb{F}[\mathcal{U}, \mathcal{V}]$ by intersection points $\mathbf{x} \in \mathbb{T}_\alpha \cap \mathbb{T}_\beta$.

2.2. Hyperboxes of chain complexes. We now describe Manolescu and Ozsváth's algebraic formalism of hypercubes of chain complexes [MO10, Section 5]. Define

$$\mathbb{E}_n := \{0, 1\}^n \subseteq \mathbb{R}^n,$$

with the convention that $\mathbb{E}_0 = \{0\}$. If $\mathbf{d} = (d_1, \dots, d_n) \in \mathbb{Z}^{\geq 0}$, we define

$$\mathbb{E}(\mathbf{d}) := \{(i_1, \dots, i_n) \in \mathbb{Z}^n : 0 \leq i_j \leq d_j, \forall j\}.$$

If $\varepsilon, \varepsilon' \in \mathbb{E}(\mathbf{d})$, we write $\varepsilon \leq \varepsilon'$ if the inequality holds for each coordinate of ε and ε' . We write $\varepsilon < \varepsilon'$ if $\varepsilon \leq \varepsilon'$ and strict inequality holds at one or more coordinates.

Definition 2.4. An n -dimensional hypercube of chain complexes $(C_\varepsilon, D_{\varepsilon, \varepsilon'})_{\varepsilon \in \mathbb{E}_n}$ consists of the following:

- (1) A group C_ε for each $\varepsilon \in \mathbb{E}_n$.
- (2) For each pair of indices $\varepsilon, \varepsilon' \in \mathbb{E}_n$ such that $\varepsilon \leq \varepsilon'$, a linear map

$$D_{\varepsilon, \varepsilon'} : C_\varepsilon \rightarrow C_{\varepsilon'}.$$

Furthermore, we assume the following compatibility condition holds whenever $\varepsilon \leq \varepsilon''$:

$$\sum_{\substack{\varepsilon' \in \mathbb{E}_n \\ \varepsilon \leq \varepsilon' \leq \varepsilon''}} D_{\varepsilon', \varepsilon''} \circ D_{\varepsilon, \varepsilon'} = 0. \quad (2.2)$$

Definition 2.5. If $\mathbf{d} \in (\mathbb{Z}^{>0})^n$, a *hyperbox of chain complexes of size \mathbf{d}* consists of a collection of groups $(C_\varepsilon)_{\varepsilon \in \mathbb{E}(\mathbf{d})}$, together with a linear map $D_{\varepsilon, \varepsilon'}$ whenever $\varepsilon \leq \varepsilon'$ and $|\varepsilon' - \varepsilon|_{L^\infty} \leq 1$. Furthermore, we assume that the analog of (2.2) holds whenever $\varepsilon \leq \varepsilon''$ and $|\varepsilon'' - \varepsilon|_{L^\infty} \leq 1$.

2.3. Compressing hyperboxes. Manolescu and Ozsváth [MO10, Section 5] describe an operation called *compression* which takes a hyperbox $\mathcal{C} = (C_\varepsilon, D_{\varepsilon, \varepsilon'})_{\varepsilon \in \mathbb{E}(\mathbf{d})}$ of size $\mathbf{d} = (d_1, \dots, d_n)$ and returns an n -dimensional hypercube $\widehat{\mathcal{C}} = (\widehat{C}_\varepsilon, \widehat{D}_{\varepsilon, \varepsilon'})_{\varepsilon \in \mathbb{E}_n}$. The underlying complexes are given by the formula

$$\widehat{C}_{(\varepsilon_1, \dots, \varepsilon_n)} = C_{(d_1 \varepsilon_1, \dots, d_n \varepsilon_n)}.$$

The hypercube structure maps are more complicated. We illustrate the construction in the 1-dimensional case. Suppose \mathcal{C} is the 1-dimensional hyperbox of chain complexes

$$C_0 \xrightarrow{f_{0,1}} C_1 \xrightarrow{f_{1,2}} \cdots \xrightarrow{f_{n-1,n}} C_n.$$

The compression of the above hyperbox is the hypercube

$$C_0 \xrightarrow{f_{n-1,n} \circ \cdots \circ f_{0,1}} C_n.$$

The same description also works for hyperboxes of size $(1, \dots, 1, d)$. That is, we view \mathcal{C} as a 1-dimensional hyperbox where the complex at each point is a hypercube of dimension $n - 1$. Compression in this case is given by function composition.

For a hyperbox C of size (d_1, \dots, d_n) , the compression may be defined by inducting on the above definition, as long as we choose an ordering of the axis directions. As a first step, view C as a collection of $d_1 \cdots d_{n-1}$ hyperboxes of size $(1, \dots, 1, d_n)$. We compress each of these hyperboxes using the function-composition description above. Stacking these hyperboxes results in a hyperbox of size $(d_1, \dots, d_{n-1}, 1)$. We view this as a collection of $d_1 \cdots d_{n-2}$ hypercubes of size $(1, \dots, 1, d_{n-1}, 1)$, which we compress using the function-composition description. Stacking the resulting hyperboxes gives a hyperbox of size $(d_1, \dots, d_{n-2}, 1, 1)$. Repeating this procedure gives the compression of C . It is possible to relate this description to the description in terms of the algebra of songs in [MO10], cf. [Liu14, Section 4.1.2].

2.4. Hypercubes of attaching curves. The notion of a hypercube of chain complexes adapts to other categories. We now describe the appropriate notion of a hypercube in the Fukaya category. See [MO10, Section 8] and [LOT14, Section 3], where such objects are referred to as *hyperboxes of Heegaard diagrams*, and *chain complexes of attaching curves*, respectively.

Definition 2.6. A *hypercube of handleslide equivalent beta attaching curves* $\mathcal{L}_\beta = (\beta_\varepsilon, \Theta_{\varepsilon, \varepsilon'})_{\varepsilon \in \mathbb{E}_n}$ on (Σ, \mathbf{w}) consists of a collection of beta attaching curves β_ε , which are each pairwise related by a sequence of handleslides and isotopies, together with distinguished morphisms $\Theta_{\varepsilon, \varepsilon'} \in CF^-(\Sigma, \beta_\varepsilon, \beta_{\varepsilon'}, \mathbf{w})$ whenever $\varepsilon < \varepsilon'$. We assume furthermore that the Heegaard 2^n -tuple containing all beta curves is weakly admissible. Finally, we assume that for each pair $\varepsilon < \varepsilon' \in \mathbb{E}_n$, the following relation is satisfied:

$$\sum_{\varepsilon = \varepsilon_1 < \cdots < \varepsilon_n = \varepsilon'} f_{\varepsilon_1, \dots, \varepsilon_n}(\Theta_{\varepsilon_1, \varepsilon_2}, \dots, \Theta_{\varepsilon_{n-1}, \varepsilon_n}) = 0. \quad (2.3)$$

A hypercube of handleslide equivalent *alpha* attaching curves is similar: For each $\varepsilon < \varepsilon'$ we have a chain $\Theta_{\varepsilon', \varepsilon} \in CF^-(\Sigma, \alpha_{\varepsilon'}, \alpha_\varepsilon, \mathbf{w})$, and the compatibility condition in Equation (2.3) holds, as long as we write the indices in the opposite order.

If \mathcal{L}_α and \mathcal{L}_β are hypercubes of strongly equivalent attaching curves on (Σ, \mathbf{w}) , of dimension m and n respectively, then there is an $(n + m)$ -dimensional hypercube of chain complexes

$$(C_{(\varepsilon, \nu)}, D_{(\varepsilon, \nu), (\varepsilon', \nu')})_{(\varepsilon, \nu) \in \mathbb{E}_n \times \mathbb{E}_m} = \mathbf{CF}^-(\Sigma, \mathcal{L}_\alpha, \mathcal{L}_\beta, \mathbf{w}, \mathfrak{s}),$$

whenever the diagram containing all attaching curves is weakly admissible. For each $(\varepsilon, \nu) \in \mathbb{E}_{n+m}$, we set

$$C_{(\varepsilon, \nu)} = \mathbf{CF}^-(\Sigma, \alpha_\varepsilon, \beta_\nu, \mathbf{w}).$$

The structure maps are given by the following formula:

$$D_{(\varepsilon, \nu), (\varepsilon', \nu')}(\mathbf{x}) = \sum_{\substack{\varepsilon=\varepsilon_1 < \dots < \varepsilon_j = \varepsilon' \\ \nu=\nu_1 < \dots < \nu_j = \nu'}} f_{\varepsilon_i, \dots, \varepsilon_1, \nu_1, \dots, \nu_j}(\Theta_{\varepsilon_i, \varepsilon_{i-1}}, \dots, \Theta_{\varepsilon_2, \varepsilon_1}, \mathbf{x}, \Theta_{\nu_1, \nu_2}, \dots, \Theta_{\nu_{j-1}, \nu_j}). \quad (2.4)$$

It is straightforward to see that $\mathbf{CF}^-(\Sigma, \mathcal{L}_\alpha, \mathcal{L}_\beta, \mathbf{w}, \mathfrak{s})$ is a hypercube of chain complexes.

The case when there are both \mathbf{w} and \mathbf{z} basepoints is a straightforward modification of the above construction.

We need the following extension of Definition 2.6 which allows morphisms which move basepoints in the Heegaard diagram.

Definition 2.7. An n -dimensional hypercube of attaching curves with basepoint slides $\mathcal{L}_\beta^\lambda$ consists of the following:

- (1) A collection of pairs $(\beta_\varepsilon, \mathbf{w}_\varepsilon)_{\varepsilon \in \mathbb{E}_n}$ where \mathbf{w}_ε is a non-empty collection of basepoints on Σ and β_ε is a set of beta-attaching curves on $(\Sigma, \mathbf{w}_\varepsilon)$.
- (2) For each pair $\varepsilon < \varepsilon'$, there is a choice of morphism $\Theta_{\varepsilon, \varepsilon'}$ from $(\beta_\varepsilon, \mathbf{w}_\varepsilon)$ to $(\beta_{\varepsilon'}, \mathbf{w}_{\varepsilon'})$ consisting of one of the following:
 - (a) If $\mathbf{w}_\varepsilon = \mathbf{w}_{\varepsilon'}$, then $\Theta_{\varepsilon, \varepsilon'}$ is an element of the Floer complex $\mathbf{CF}^-(\Sigma, \beta_\varepsilon, \beta_{\varepsilon'}, \mathbf{w}_\varepsilon)$.
 - (b) If $\mathbf{w}_\varepsilon \neq \mathbf{w}_{\varepsilon'}$ and $|\varepsilon' - \varepsilon|_{L^1} > 1$, then we declare $\Theta_{\varepsilon, \varepsilon'}$ to be 0.
 - (c) If $\mathbf{w}_\varepsilon \neq \mathbf{w}_{\varepsilon'}$ and $|\varepsilon' - \varepsilon|_{L^1} = 1$, then $\mathbf{w}_{\varepsilon'}$ is the result of moving one basepoint of \mathbf{w}_ε along a distinguished arc $\lambda_{\varepsilon, \varepsilon'}$. Furthermore, $\beta_\varepsilon = \beta_{\varepsilon'}$. We declare $\Theta_{\varepsilon, \varepsilon'}$ (formally) to be the arc $\lambda_{\varepsilon, \varepsilon'}$. We assume furthermore that if $\lambda_{\varepsilon, \varepsilon'}$ is a length 1 slide arc morphism, and the length 1 arrow (ν, ν') is parallel to $(\varepsilon, \varepsilon')$, then $\Theta_{\nu, \nu'}$ is also a slide arc morphism and $\lambda_{\nu, \nu'} = \lambda_{\varepsilon, \varepsilon'}$. Furthermore, we assume that each slide arc $\lambda_{\varepsilon, \varepsilon'}$ is disjoint from β_ν for all $\nu \in \mathbb{E}_n$.

We assume the compatibility condition for hypercubes of attaching curves, Equation (2.3), also holds, as long as it is interpreted in the following way. If $\varepsilon < \varepsilon'$ are points in \mathbb{E}_n , then we sum the holomorphic polygon maps over all broken arrow paths in \mathbb{E}_n from ε to ε' (a *broken arrow path* is a sequence of arrows from ε to ε' such that each arrow has L^1 length at least 1). If λ is a slide-arc input, then we interpret the polygon maps in the strictly unital way: $\partial(\lambda) = 0$, $f_{\beta_{\varepsilon_1}, \beta_{\varepsilon_2}, \beta_{\varepsilon_3}}(\mathbf{x}, \lambda) = \mathbf{x}$ (and similarly for λ and \mathbf{x} in the opposite order), and any ℓ -gon map with $\ell > 3$ and λ as an input is 0.

Suppose that \mathcal{L}_α is a hypercube of alpha attaching curves, and $\mathcal{L}_\beta^\lambda$ is a hypercube of beta attaching curves with basepoint slides. Suppose furthermore that all of the slide-arcs are disjoint from the curves of \mathcal{L}_α . We may define the pairing $\mathbf{CF}^-(\Sigma, \mathcal{L}_\alpha, \mathcal{L}_\beta^\lambda)$, similarly to the case without basepoint slides. The formula for the hypercube structure maps is essentially the same as Equation (2.4), as long as one follows the strict-unality convention when λ_i as an input, as in Definition 2.7.

2.5. More hypercubes. We now collect several additional constructions and basic properties. Firstly, if $\mathcal{C} = (C_\varepsilon, D_{\varepsilon, \varepsilon'})_{\varepsilon \in \mathbb{E}_n}$ and $\mathcal{C}' = (C'_\nu, D'_{\nu, \nu'})_{\nu \in \mathbb{E}_m}$ are two hypercubes of chain complexes over a ring R , we may define their tensor product

$$\mathcal{E} := \mathcal{C} \otimes_R \mathcal{C}',$$

as follows. The hypercube $\mathcal{E} = (E_{(\varepsilon,\nu)}, \delta_{(\varepsilon,\nu),(\varepsilon',\nu')})_{(\varepsilon,\nu) \in \mathbb{E}_n \times \mathbb{E}_m}$ is the tensor product in the ordinary sense: As groups, we set

$$E_{(\varepsilon,\nu)} = C_\varepsilon \otimes_R C'_\nu$$

and the structure maps are given by

$$\delta_{(\varepsilon,\nu),(\varepsilon',\nu')} = \begin{cases} D_{\varepsilon,\varepsilon'} \otimes \text{id} & \text{if } \nu = \nu' \\ \text{id} \otimes D'_{\nu,\nu'} & \text{if } \varepsilon = \varepsilon' \\ 0 & \text{if } \varepsilon < \varepsilon' \text{ and } \nu < \nu'. \end{cases}$$

Additionally, if \mathcal{C} and \mathcal{C}' are two hyperboxes of size $\mathbf{d}_0 \times \{d\}$ and $\mathbf{d}_0 \times \{d'\}$, such that the restrictions $\mathcal{C}|_{\mathbb{E}(\mathbf{d}_0) \times \{d\}}$ and $\mathcal{C}'|_{\mathbb{E}(\mathbf{d}_0) \times \{0\}}$ coincide (in both underlying groups and structure morphisms), then we may stack \mathcal{C} and \mathcal{C}' to obtain a hyperbox of size $\mathbf{d}_0 \times \{d+d'\}$, which we denote $\text{St}(\mathcal{C}, \mathcal{C}')$. The following lemma records some interactions between stacking and tensoring.

Lemma 2.8.

- (1) *Stacking hyperboxes of attaching curves commutes with pairing: If \mathcal{L}_α , \mathcal{L}_β and $\mathcal{L}_{\beta'}$ are hyperboxes of attaching curves, and \mathcal{L}_β and $\mathcal{L}_{\beta'}$ may be stacked along a codimension 1 face, then*

$$\text{St}(CF^-(\mathcal{L}_\alpha, \mathcal{L}_\beta), CF^-(\mathcal{L}_\alpha, \mathcal{L}_{\beta'})) \cong CF^-(\mathcal{L}_\alpha, \text{St}(\mathcal{L}_\beta, \mathcal{L}_{\beta'})).$$

- (2) *Stacking hyperboxes of chain complexes commutes with tensoring hyperboxes: If \mathcal{C} and \mathcal{C}' are stackable hyperboxes of chain complexes, and \mathcal{D} is another hyperbox of chain complexes, then*

$$\text{St}(\mathcal{C}, \mathcal{C}') \otimes \mathcal{D} \cong \text{St}(\mathcal{C}, \mathcal{D}) \otimes \text{St}(\mathcal{C}', \mathcal{D}).$$

- (3) *Compressing hyperboxes of chain complexes commutes with tensor products of hyperboxes. If \mathcal{C} and \mathcal{D} are hyperboxes of chain complexes, and $\widehat{\mathcal{C}}$ denotes compression, then there is a choice of ordering of the axis directions used to compute the compression so that*

$$\widehat{\mathcal{C}} \otimes \widehat{\mathcal{D}} \cong \widehat{\mathcal{C} \otimes \mathcal{D}}.$$

Proof. Claim (1) is essentially the definition of the pairing between hyperboxes. Similarly (2) is clear. For claim (3), we use the inductive perspective on compression from Section 2.3. Compress the axis directions for \mathcal{C} first, and then compress the axis directions for \mathcal{D} . Write \mathbf{d}_1 for the size of \mathcal{C} and \mathbf{d}_2 for the size of \mathcal{D} . Consider the effect of compressing the last axis direction of \mathcal{D} . Write $\mathbf{d}_2 = (d_{2,1}, \dots, d_{2,n})$. Recall that we construct $\widehat{\mathcal{D}}$ by writing \mathcal{D} as the stacking of $d_{2,1} \cdots d_{2,n-1}$ hyperboxes of size $(1, 1, \dots, 1, d_{2,n})$, each of which we compress by function composition, and then restack to obtain a hyperbox \mathcal{D}_n of size $(d_{2,1}, d_{2,2}, \dots, d_{2,n-1}, 1)$. We then repeat this procedure n times. If \mathcal{D}^s was one of the constituent hyperboxes of size $(1, 1, \dots, d_{2,n})$, we wrote \mathcal{D}^s as 1-dimensional hyperbox

$$\mathcal{D}^s = \mathcal{D}_1^s \xrightarrow{f_{1,2}} \dots \xrightarrow{f_{d_{2,n-1}, d_{2,n}}} \mathcal{D}_{d_{2,n}}^s.$$

We then tensor with \mathcal{C} to obtain

$$\mathcal{C} \otimes \mathcal{D}^s = \mathcal{C} \otimes \mathcal{D}_1^s \xrightarrow{\text{id}_{\mathcal{C}} \otimes f_{1,2}} \dots \xrightarrow{\text{id}_{\mathcal{C}} \otimes f_{d_{2,n-1}, d_{2,n}}} \mathcal{C} \otimes \mathcal{D}_{d_{2,n}}^s.$$

The composition of the above maps is

$$(f_{d_{2,n-1}, d_{2,n}} \circ \cdots \circ f_{1,2}) \otimes \text{id}_{\mathcal{D}}$$

Hence, if \mathcal{D}_n denotes the hyperbox obtained from \mathcal{D} by compressing the last axis, then compressing the last axis of $\mathcal{C} \otimes \mathcal{D}$ gives

$$\mathcal{C} \otimes \mathcal{D}_n.$$

Performing the above procedure inductively to the remaining directions corresponding to \mathcal{D} , and then the directions corresponding to \mathcal{C} , we obtain that the compression of $\mathcal{C} \otimes \mathcal{D}$ is itself $\widehat{\mathcal{C}} \otimes \widehat{\mathcal{D}}$. \square

A more sophisticated extension of Lemma 2.8 concerns commuting a tensor product operation on attaching curves and the pairing operation on hypercubes of attaching curves. See Propositions 8.1 and 9.4.

3. BACKGROUND ON A_∞ -MODULES

In this section, we recall some background about A_∞ modules. We follow the notation of [LOT18] [LOT15]. See [Kel02] for further background and historical context.

3.1. Type- A and type- D modules. In this section and throughout the paper, we work in characteristic 2.

Definition 3.1. Suppose \mathcal{A} is an associative algebra. A *left A_∞ -module* ${}_{\mathcal{A}}M$ over \mathcal{A} is a left \mathbf{k} -module M equipped with \mathbf{k} -module map

$$m_{j+1}: \mathcal{A}^{\otimes j} \otimes_{\mathbf{k}} M \rightarrow M$$

for each $j \geq 0$, such that if $a_n, \dots, a_1 \in \mathcal{A}$ and $\mathbf{x} \in M$, then

$$\sum_{j=0}^n m_{n-j+1}(a_n, \dots, a_{j+1}, m_{j+1}(a_j, \dots, a_1, \mathbf{x})) + \sum_{k=1}^{n-1} m_n(a_n, \dots, a_{k+1}a_k, \dots, a_1, \mathbf{x}) = 0.$$

An A_∞ module ${}_{\mathcal{A}}M$ is *strictly unital* if $m_2(1, \mathbf{x}) = \mathbf{x}$ for all $\mathbf{x} \in M$, and such that $m_{j+1}(a_n, \dots, a_1, \mathbf{x}) = 0$ if $a_i \in \mathbf{k}$ for some i and $j > 1$.

Definition 3.2. If \mathcal{A} is an associative algebra over \mathbf{k} , a right type- D module $N^{\mathcal{A}}$ is right \mathbf{k} -module N , equipped with a \mathbf{k} -linear structure map

$$\delta^1: N \rightarrow N \otimes_{\mathbf{k}} \mathcal{A},$$

which satisfies

$$(\text{id}_N \otimes \mu_2) \circ (\delta^1 \otimes \text{id}_{\mathcal{A}}) \circ \delta^1 = 0.$$

Note in the above, we are only considering associative algebras, instead of dg -algebras or A_∞ -algebras. See [LOT15, Definition 2.2.23] for the general definition.

Remark 3.3. Some care must be taken in translating the results of [LOT18] and [LOT15] to our present situation. For example Lipshitz, Ozsváth and Thurston work exclusively with algebras which are *nilpotent* ([LOT15, Definition 2.19]), which our algebra \mathcal{K} is not. Most of their algebraic framework still holds, but some subtleties arise when considering DD bimodules, which do not appear extensively in our paper. See [LOT15, Remark 2.3.12].

3.2. Bimodules. We also need to consider A_∞ -bimodules. Our exposition and notation follows [LOT15], though we restrict to the case of associative algebras (as opposed to dg -algebras or A_∞ -algebras).

Definition 3.4. Suppose that \mathcal{A} and \mathcal{B} are algebras over \mathbf{j} and \mathbf{k} , respectively. A type DA bimodule, denoted ${}_{\mathcal{A}}M^{\mathcal{B}}$, consists of a (\mathbf{j}, \mathbf{k}) -module M , equipped with (\mathbf{j}, \mathbf{k}) -linear structure morphisms

$$\delta_{j+1}^1: \mathcal{A}^{\otimes j} \otimes_{\mathbf{j}} M \rightarrow M \otimes_{\mathbf{k}} \mathcal{B},$$

which satisfy the following structure relation:

$$\begin{aligned} & \sum_{j=0}^n ((\text{id}_M \otimes \mu_2) \circ (\delta_{n-j+1}^1 \otimes \text{id}_{\mathcal{B}}))(a_n, \dots, a_{j+1}, \delta_{j+1}^1(a_j, \dots, a_1, \mathbf{x})) \\ & + \sum_{k=1}^{n-1} \delta_n^1(a_n, \dots, a_{k+1}a_k, \dots, a_1, \mathbf{x}) = 0. \end{aligned}$$

3.3. The Lipshitz–Ozsváth–Thurston box tensor product. In this section, we recall the *box tensor product* of Lipshitz, Ozsváth and Thurston [LOT18, Section 2.4].

Suppose that \mathcal{A} is an associative algebra over \mathbf{k} . If $N^{\mathcal{A}}$ is a type- D module and ${}_{\mathcal{A}}M$ is a type- A module, then the *box tensor product* $N^{\mathcal{A}} \boxtimes {}_{\mathcal{A}}M$ is the chain complex $N \otimes_{\mathbf{k}} M$, with differential ∂^{\boxtimes} as follows. Following [LOT18], it is convenient to make the inductive notation that $\delta^j: N \rightarrow N \otimes \mathcal{A}^{\otimes j}$ is the map given inductively by $\delta^j = (\text{id}_{\mathcal{A}^{\otimes j-1}} \otimes \delta^1) \circ \delta^{j-1}$ and $\delta^0 = \text{id}$. Then the differential has the formula

$$\partial^{\boxtimes}(\mathbf{x} \otimes \mathbf{y}) = \sum_{j=0}^{\infty} (\text{id}_N \otimes m_{j+1})(\delta^j(\mathbf{x}), \mathbf{y}).$$

The differential is usually depicted via the following diagram:

$$\partial^{\boxtimes}(\mathbf{x} \otimes \mathbf{y}) = \begin{array}{ccc} & \mathbf{x} & \mathbf{y} \\ & \downarrow & \downarrow \\ & \delta & \\ & \searrow & \downarrow \\ & & m \\ & \downarrow & \downarrow \end{array} \quad (3.1)$$

According to [LOT18, Lemma 2.30], the map ∂^{\boxtimes} is a differential whenever one of M or N satisfies a *boundedness* assumption; see [LOT15, Definitions 2.2.18 and 2.2.29].

There are also versions for pairing DA bimodules. Below, we give the schematic for pairings of the form $AD \boxtimes AD$, $AD \boxtimes A$ and $D \boxtimes AD$:

$$\delta^{AD \boxtimes AD} = \begin{array}{ccc} \mathbf{a} & \mathbf{x} & \mathbf{y} \\ \searrow & \downarrow & \downarrow \\ & \delta & \\ & \searrow & \downarrow \\ & & \delta^1 \\ & \downarrow & \downarrow \end{array} \quad \delta^{AD \boxtimes A} = \begin{array}{ccc} \mathbf{a} & \mathbf{x} & \mathbf{y} \\ \searrow & \downarrow & \downarrow \\ & \delta & \\ & \searrow & \downarrow \\ & & m \\ & \downarrow & \downarrow \end{array} \quad \delta^{D \boxtimes AD} = \begin{array}{ccc} & \mathbf{x} & \mathbf{y} \\ & \downarrow & \downarrow \\ & \delta & \\ & \searrow & \downarrow \\ & & \delta^1 \\ & \downarrow & \downarrow \end{array} .$$

3.4. Morphisms of modules and bimodules. We now recall the definitions of morphisms of type- D , type- A and type- DA modules and bimodules from [LOT15]. We assume that all algebras are associative algebras with vanishing differential. We refer the reader to [LOT15] for the case of dg or A_∞ -algebras.

Suppose \mathcal{A} is an algebra over \mathbf{k} and $N^{\mathcal{A}}$ and $M^{\mathcal{A}}$ are two type- D modules. A morphism $f^1: N^{\mathcal{A}} \rightarrow M^{\mathcal{A}}$ is a \mathbf{k} -linear map

$$f^1: N \rightarrow M \otimes_{\mathbf{k}} \mathcal{A}.$$

There is a morphism differential, given by

$$\partial_{\text{Mor}}(f^1) = (\text{id}_M \otimes \mu_2) \circ (f^1 \otimes \text{id}_{\mathcal{A}}) \circ \delta^1 + (\text{id}_M \otimes \mu_2) \circ (\delta^1 \otimes \text{id}_{\mathcal{A}}) \circ f^1.$$

The map ∂_{Mor} squares to zero. A type- D *homomorphism* (or *cycle*) is a morphism which satisfies $\partial_{\text{Mor}}(f^1) = 0$.

A morphism f_* between two type- A modules ${}_{\mathcal{A}}M$ and ${}_{\mathcal{A}}N$ is a collection of \mathbf{k} -linear maps

$$f_{j+1}: \mathcal{A}^{\otimes j} \otimes_{\mathbf{k}} M \rightarrow N.$$

There is a morphism differential $\partial_{\text{Mor}}(f_*)$ given by

$$\begin{aligned} \partial_{\text{Mor}}(f_*)_{n+1}(a_n, \dots, a_1, \mathbf{x}) &= \sum_{j=0}^n f_{n-j+1}(a_n, \dots, a_{j+1}, f_{j+1}(a_j, \dots, a_1, \mathbf{x})) \\ &\quad + \sum_{i=1}^{n-1} f_n(a_n, \dots, a_{i+1}a_i, \dots, a_1, \mathbf{x}). \end{aligned}$$

Finally, if ${}_{\mathcal{A}}M^{\mathcal{B}}$ and ${}_{\mathcal{A}}N^{\mathcal{B}}$ are DA -bimodules, then a morphism is a collection of maps $f_*^1 = (f_{j+1}^1)_{j \geq 0}$ as follows:

$$f_{j+1}^1: \mathcal{A}^{\otimes j} \otimes M \rightarrow N \otimes \mathcal{B}.$$

The morphism differential is given by

$$\begin{aligned} &\partial_{\text{Mor}}(f_*^1)_{n+1}(a_n, \dots, a_1, \mathbf{x}) \\ &= \sum_{j=0}^n (\text{id}_N \otimes \mu_2)(f_{n-j+1}^1 \otimes \text{id}_{\mathcal{B}})(a_n, \dots, a_{j+1}, f_{j+1}^1(a_j, \dots, a_1, \mathbf{x})) \\ &\quad + \sum_{i=1}^{n-1} f_n^1(a_n, \dots, a_{i+1}a_i, \dots, a_1, \mathbf{x}). \end{aligned}$$

If $f_*^1: {}_{\mathcal{A}}M^{\mathcal{B}} \rightarrow {}_{\mathcal{A}}N^{\mathcal{B}}$ and $g_*^1: {}_{\mathcal{A}}P^{\mathcal{B}} \rightarrow {}_{\mathcal{A}}Q^{\mathcal{B}}$ are DA -bimodule morphisms, Lipshitz–Ozsváth–Thurston define the composition $f_*^1 \circ g_*^1$ via the following diagram:

$$\begin{array}{ccc}
 \mathbf{a} & & \mathbf{x} \\
 \Downarrow & & \downarrow \\
 \Delta & & \\
 \swarrow & \searrow & \downarrow \\
 & & f_*^1 \\
 & & \downarrow \\
 & & g_*^1 \\
 & & \downarrow \\
 & & \mu_2
 \end{array}
 \quad (3.2)$$

In Equation (3.2), Δ denotes the co-multiplication

$$\Delta: \mathcal{A}^{\otimes n} \rightarrow \bigoplus_{i=0}^n \mathcal{A}^{\otimes i} \otimes \mathcal{A}^{\otimes (n-i)}$$

given by

$$\Delta(a_1 | \dots | a_n) = \sum_{i=1}^n (a_1 | \dots | a_i) \otimes (a_{i+1} | \dots | a_n).$$

In the above, $|$ denotes tensor product.

We now discuss pairing morphisms of modules and bimodules. We focus on the case of DA -bimodule morphisms. The other types of pairings which are relevant to our paper are defined by forgetting about the input algebra or output algebra in the diagrams below. The natural algebraic operation is to pair a bimodule morphism with the identity (as opposed to pairing two morphisms together). Suppose that ${}_{\mathcal{A}}N^{\mathcal{B}}$ and ${}_{\mathcal{A}}M^{\mathcal{B}}$ and ${}_{\mathcal{B}}P^{\mathcal{C}}$ are DA -bimodules, and

$$f_*^1: {}_{\mathcal{A}}N^{\mathcal{B}} \rightarrow {}_{\mathcal{A}}M^{\mathcal{B}}$$

is a morphism of DA -bimodules. There is a morphism of DA -bimodules $f_*^1 \boxtimes \mathbb{I}: N \boxtimes P \rightarrow M \boxtimes P$, defined by the following diagram

$$\begin{array}{ccc}
 \mathbf{a} & \mathbf{x} & \mathbf{y} \\
 \Downarrow & \downarrow & \downarrow \\
 \Delta & & \\
 \swarrow & \searrow & \downarrow \\
 & \delta & \\
 & \downarrow & \\
 & f_*^1 & \\
 & \downarrow & \\
 & \delta & \\
 & \downarrow & \\
 & & \delta^1 \\
 & & \downarrow
 \end{array}
 \quad f_*^1 \boxtimes \mathbb{I} =$$

If instead $g_*^1: {}_{\mathcal{B}}P^{\mathcal{C}} \rightarrow {}_{\mathcal{B}}Q^{\mathcal{C}}$ is a morphism of type- DA modules, then $\mathbb{I} \boxtimes g_*^1$ is given by the diagram

$$\begin{array}{ccccc}
 & \mathbf{a} & & \mathbf{x} & & \mathbf{y} \\
 & \searrow & & \downarrow & & \downarrow \\
 & & & \delta & \searrow & \downarrow \\
 & & & \downarrow & & g_*^1 \\
 & & & \downarrow & & \downarrow \\
 & & & & & \searrow
 \end{array}$$

3.5. Extension of scalars. Suppose that \mathcal{A} , \mathcal{B} and \mathcal{C} are dg -algebras, which are algebras over \mathbf{i} , \mathbf{j} and \mathbf{k} , respectively. In this section, we describe a procedure for turning a bimodule ${}_{\mathcal{A}}N^{\mathcal{B}}$ into a bimodule ${}_{\mathcal{A} \otimes \mathcal{C}}\mathcal{E}(N; \mathcal{C})^{\mathcal{B} \otimes \mathcal{C}}$, which we call *extension of scalars*. The construction is inspired by some formalities related to type- DD bimodules in the work of Lipshitz, Ozsváth and Thurston [LOT18]. As an $(\mathbf{i} \otimes \mathbf{k}, \mathbf{j} \otimes \mathbf{k})$ -module, we declare $\mathcal{E}(N; \mathcal{C}) = N \otimes_{\mathbb{F}} \mathbf{k}$. If $k \in \mathbf{k}$, then we define

$$\delta_{j+1}^1(a_j|c_j, \dots, a_1|c_1, \mathbf{x}|k) = \delta_{j+1}^1(a_j, \dots, a_1, \mathbf{x}) \otimes k \otimes (c_j \cdots c_1). \quad (3.3)$$

Note that $\delta_1^1(\mathbf{x}|k) = \delta_1^1(\mathbf{x}) \otimes k \otimes 1_{\mathcal{C}}$. (Note we are implicitly reordering the k factor and the \mathcal{B} factor above).

The construction also works to promote a type- D module $N^{\mathcal{B}}$ to a type- DA module ${}_{\mathcal{C}}N^{\mathcal{C} \otimes \mathcal{B}}$.

Given a unital morphism of DA -bimodules $f_{k+1}^1: {}_{\mathcal{A}}N^{\mathcal{B}} \rightarrow {}_{\mathcal{A}}M^{\mathcal{B}}$, there is a morphism

$$\mathcal{E}(f)_{k+1}^1: {}_{\mathcal{A} \otimes \mathcal{C}}\mathcal{E}(N; \mathcal{C})^{\mathcal{B} \otimes \mathcal{C}} \rightarrow {}_{\mathcal{A} \otimes \mathcal{C}}\mathcal{E}(M; \mathcal{C})^{\mathcal{B} \otimes \mathcal{C}}$$

given by replacing δ_{k+1}^1 with f_{k+1}^1 in (3.3).

Lemma 3.5. *Suppose that \mathcal{A} , \mathcal{B} , and \mathcal{C} are dg -algebras and suppose that ${}_{\mathcal{A}}N^{\mathcal{B}}$ is a DA -bimodule.*

- (1) ${}_{\mathcal{A} \otimes \mathcal{C}}\mathcal{E}(N; \mathcal{C})^{\mathcal{B} \otimes \mathcal{C}}$ satisfies the DA -bimodule structure relations.
- (2) If f_*^1 is a morphism of DA -bimodules, then $\partial_{\text{Mor}}(\mathcal{E}(f_*^1)) = \mathcal{E}(\partial_{\text{Mor}}(f_*^1))$.
- (3) If ${}_{\mathcal{A}}M^{\mathcal{B}}$ and ${}_{\mathcal{B}}N^{\mathcal{D}}$ are bimodules, then there is a canonical isomorphism of DA -bimodules

$${}_{\mathcal{A} \otimes \mathcal{C}}\mathcal{E}({}_{\mathcal{A}}M^{\mathcal{B}} \boxtimes {}_{\mathcal{B}}N^{\mathcal{D}}; \mathcal{C})^{\mathcal{D} \otimes \mathcal{C}} \cong {}_{\mathcal{A} \otimes \mathcal{C}}\mathcal{E}(M; \mathcal{C})^{\mathcal{B} \otimes \mathcal{C}} \boxtimes {}_{\mathcal{B} \otimes \mathcal{C}}\mathcal{E}(N; \mathcal{C})^{\mathcal{D} \otimes \mathcal{C}}.$$

- (4) With respect to the above isomorphism, we also have

$$\mathcal{E}(f_*^1 \boxtimes \mathbb{I}) = \mathcal{E}(f_*^1) \boxtimes \mathbb{I} \quad \text{and} \quad \mathcal{E}(\mathbb{I} \boxtimes g_*^1) = \mathbb{I} \boxtimes \mathcal{E}(g_*^1),$$

if f_*^1 and g_*^1 are morphisms of DA -bimodules.

Proof. We consider the first claim. Consider the bimodule structure relation, applied to sequence $(b_n|c_n), \dots, (b_1|c_1), \mathbf{x}|1_{\mathbf{k}}$. There are two types of terms: those with μ_1 applied to some c_i on the incoming or outgoing algebra elements, and those without a μ_1 applied to an algebra element of \mathcal{C} . Separating these terms, the bimodule relations for $\mathcal{E}(\delta_*^1)$ follow from the bimodule relations for δ_*^1 , and the Leibniz rule for \mathcal{C} .

For the second claim, we note that each term of $\partial_{\text{Mor}}(\mathcal{E}(f_*^1))$, when evaluated on $(b_n|c_n), \dots, (b_1|c_1), \mathbf{x}|1_{\mathbf{k}}$, is either equal to a corresponding term of $\partial_{\text{Mor}}(f_*^1)$, evaluated on $b_n, \dots, b_1, \mathbf{x}$ and tensored with $c_1 \cdots c_n$, or involves a $\mu_1(c_i)$. It is easy to see that all of the terms cancel.

For the third claim, the map is $f_j^1(\mathbf{x} \otimes \mathbf{y}) = \mathbf{x} \otimes \mathbf{y} \otimes 1_{\mathcal{A} \otimes \mathcal{C}}$ if $j = 1$, and $f_j^1 = 0$ if $j > 1$. It is easy to see that this is an isomorphism of DA bimodules.

The final claim is verified in a similar manner. \square

We also have the following associativity relation for extension of scalars:

Lemma 3.6. *Suppose that ${}_{\mathcal{A}}M^{\mathcal{B}}$ and ${}_cN^{\mathcal{D}}$ are unital bimodules over dg -algebras.*

(1) *The box tensor product*

$${}_{\mathcal{A} \otimes \mathcal{C}}\mathcal{E}(M, \mathcal{C})^{\mathcal{B} \otimes \mathcal{C}} \boxtimes_{\mathcal{B} \otimes \mathcal{C}} \mathcal{E}(N, \mathcal{B})^{\mathcal{B} \otimes \mathcal{D}}$$

is well-defined (in particular, the structure map is a finite sum).

(2) *Suppose that M (or N) has the property that $\delta_j^1 = 0$ if $j > 2$. Then the map*

$${}_{\mathcal{A} \otimes \mathcal{C}}\mathcal{E}(M, \mathcal{C})^{\mathcal{B} \otimes \mathcal{C}} \boxtimes_{\mathcal{B} \otimes \mathcal{C}} \mathcal{E}(N, \mathcal{B})^{\mathcal{B} \otimes \mathcal{D}} \rightarrow {}_{\mathcal{A} \otimes \mathcal{C}}\mathcal{E}(N, \mathcal{A})^{\mathcal{A} \otimes \mathcal{D}} \boxtimes_{\mathcal{A} \otimes \mathcal{D}} \mathcal{E}(M, \mathcal{D})^{\mathcal{B} \otimes \mathcal{D}}$$

given by $f_1^1(\mathbf{x} \otimes \mathbf{y}) = \mathbf{y} \otimes \mathbf{x} \otimes 1$ (and $f_j^1 = 0$ if $j > 1$) is an isomorphism of DA -bimodules.

(3) *Suppose that N and M both have the property that $\delta_j^1 = 0$ if $j > 3$, then the two bimodules above are isomorphic as DA -bimodules, i.e. there exist homomorphisms of DA -bimodules f_*^1 and g_*^1 such that $f_*^1 \circ g_*^1 = \text{id}$ and $g_*^1 \circ f_*^1 = \text{id}$. Furthermore f_j^1 and g_j^1 vanish if $j > 3$.*

Proof. Finiteness in the sum defining δ_j^1 on the tensor product follows from unality of N . In general, one could have arbitrarily many δ_1^1 terms from M which contribute algebra inputs into $\mathcal{E}(N)$. These algebra inputs all have factors of $1 \in \mathcal{C}$, and hence make trivial contribution to the box tensor product.

For the second claim, the structure maps are identical. On the two tensor products, we have a correspondence between terms, as in the following diagram:

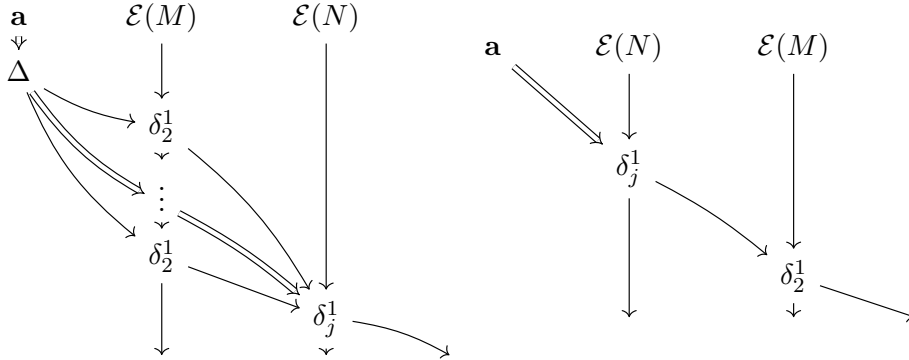

For the third claim, we construct the morphisms f_*^1 and g_*^1 which relate the two tensor products, as follows. The maps f_*^1 and g_*^1 are defined using essentially the same formula, so we focus on f_*^1 . We set $f_1^1(\mathbf{x} \otimes \mathbf{y}) = \mathbf{x} \otimes 1$. We set $f_2^1 = 0$. Finally, we set

$$f_3^1(a_2|c_2, a_1|c_1, \mathbf{x} \otimes \mathbf{y}) = \delta_3^1(a_2, a_1, \mathbf{x}) \otimes \delta_3^1(c_2, c_1, \mathbf{y}),$$

(with terms reordered in the obvious manner). We set $f_j^1 = 0$ for $j > 3$.

On the tensor product, $\delta_j^1 = 0$ if $j > 4$. We can think of the structure maps δ_j^1 as being determined by a sum of pairs of trees with j inputs. We illustrate these trees in Figure 3.1.

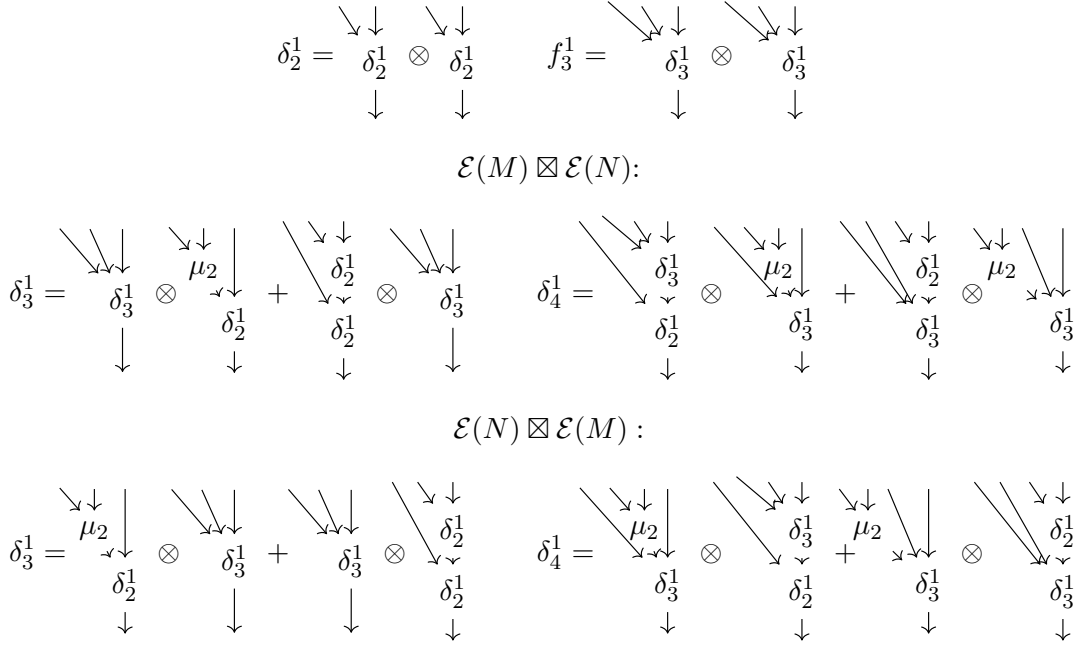

FIGURE 3.1. The structure relations on $\mathcal{E}(M) \boxtimes \mathcal{E}(N)$ and $\mathcal{E}(N) \boxtimes \mathcal{E}(M)$. In all figures, the left tree corresponds to M , while the right tree corresponds to N .

It is an easy exercise to check that f_*^1 and g_*^1 have the stated properties. \square

Remark 3.7. (1) The previous lemma also holds if ${}_{\mathcal{A}}M^{\mathcal{B}}$ is only homotopy equivalent to a bimodule ${}_{\mathcal{A}}\widetilde{M}^{\mathcal{B}}$ which has only δ_2^1 and δ_1^1 non-vanishing, by Lemma 3.5, as long as all morphisms and homotopies in the equivalence, as well as N , are suitably bounded so tensoring maps makes sense. In general, every DA -bimodule ${}_{\mathcal{A}}M^{\mathcal{B}}$ is homotopy equivalent to its bar resolution

$${}_{\mathcal{A}}\mathcal{A}_{\mathcal{A}} \boxtimes {}^{\mathcal{A}}\text{Bar}(\mathcal{A})^{\mathcal{A}} \boxtimes {}_{\mathcal{A}}M^{\mathcal{B}},$$

however some care must be taken since the morphisms involved in the equivalence are not unital, and have f_j^1 non-zero for all j . See [LOT15, Lemma 2.3.19] for details.

- (2) An alternate approach to proving the previous lemma in full generality would be to identify our extension of scalars operation as an external tensor product of the bimodules ${}_{\mathcal{A}}M^{\mathcal{B}}$ and ${}_c[\text{id}]^c$ over a diagonal of the associahedron. The techniques of [LOT20] could be applied. See, e.g. Section 3.6.3, therein.
- (3) Although we have not endeavored to prove Lemma 3.6 in full generality, the final statement is sufficient for our purposes. The bimodules obtained from the surgery formula are constructed from type- D modules, framing modules (which have vanishing m_j for $j > 2$) and the merge bimodule ${}_{\mathcal{K} \otimes \mathcal{K}}M_2^{\mathcal{K}}$, which has a δ_3^1 term, but no higher actions.

Remark 3.8. We will usually drop the \mathcal{E} symbol when performing extension of scalars, since it is cumbersome.

3.6. Completions. Manolescu and Ozsváth's link surgery formula requires the use of algebraic completions in the link surgery complex. This involves using power series rings and taking direct products over $\mathfrak{s} \in \mathbb{H}(L)$. In this section, we describe some basic facts related to completions which are necessary for our bordered version of the link surgery formula. See Atiyah and MacDonald [AM69, Section 10] for more background.

We now recall the basics. Suppose first that G is an abelian group equipped with a decreasing filtration $(G_i)_{i \in \mathbb{Z}}$ on G , i.e. a sequence of subgroups G_i such that $G_i \supseteq G_{i+1}$ for all $i \in \mathbb{Z}$. Given a filtered group, the *completion* is the inverse limit

$$\mathbf{G} = \varprojlim_{i \in \mathbb{Z}} G/G_i.$$

Note that \mathbf{G} is also a filtered group, with filtration $\mathbf{G}_i = \varprojlim_{j \in \mathbb{Z}} G_i/(G_i \cap G_j)$. Sometimes we denote the completed group also by \hat{G} .

Remark 3.9. Most filtrations in our paper will be induced by a *weight function* on generators, that is, our groups will be equipped with a generating set \mathfrak{G} over \mathbb{F} as well as a map $w: \mathfrak{G} \rightarrow \mathbb{R}$, and the filtration G_n is given by $\text{Span}_{\mathbb{F}}(x \in \mathfrak{G} : w(x) \geq n)$.

For example, on $G = \mathbb{F}[x, y]$ we may consider the weight function $w(x^i y^j) = i + j$, and set $G_n = \text{Span}_{\mathbb{F}}(x^i y^j : w(x^i y^j) \geq n)$. Then $\mathbf{G} \cong \mathbb{F}[[x, y]]$. In some examples (e.g. on the algebra \mathcal{K}), it will be important to give some generators negative weight.

A filtration $(G_i)_{i \in \mathbb{Z}}$ on an abelian group G naturally determines a topology on G , which has a basis of open sets consisting of $x + G_i$, where $x \in G$ and $i \in \mathbb{N}$. Furthermore, with respect to such a topology, the addition and inverse maps are continuous.

Note that conversely, it is not hard to show that if two filtrations on G determine the same topology, then the corresponding completions are canonically isomorphic.

If G and G' are filtered groups, as above, then a homomorphism $f: G \rightarrow G'$ determines a map from \mathbf{G} to \mathbf{G}' if f is continuous.

There are similar notions for rings. If R is a ring with filtration by subgroups $(R_i)_{i \in \mathbb{Z}}$, a common restriction is to assume that R_i is an ideal. In this case, multiplication is also continuous. An alternate assumption which also implies continuity is that multiplication sends $R_i \otimes R_j$ to R_{i+j} . See Lemma 6.2 for the case of our algebra \mathcal{K} .

If M is an R -module, and M has a filtration $(M_i)_{i \in \mathbb{N}}$ by R -submodules, then there is also an induced topology on M and an induced completion.

If M_R and ${}_R N$ are two \mathbb{Z} -filtered R -modules, with filtrations $(M_i)_{i \in \mathbb{Z}}$ and $(N_i)_{i \in \mathbb{Z}}$, we define a filtration on the tensor product via the formula

$$(M \otimes_R N)_n = \sum_{i+j=n} M_i \otimes_R N_j. \quad (3.4)$$

If the tensor product is taken over \mathbb{F} , and the filtrations on M and N are induced by weight functions w_1 and w_2 , respectively, then the above filtration is induced by the weight function

$$w(x \otimes y) = w_1(x) + w_2(y).$$

Example 3.10. Consider $\mathbb{F}[x]$ and $\mathbb{F}[y]$ with the I -adic topologies given by the ideals (x) and (y) . Then

$$\mathbb{F}[x] \hat{\otimes}_{\mathbb{F}} \mathbb{F}[y] \cong \mathbb{F}[[x, y]].$$

Note that the canonical map

$$\mathbb{F}[[x]] \otimes_{\mathbb{F}} \mathbb{F}[[y]] \rightarrow \mathbb{F}[[x, y]].$$

is not surjective. For example $\sum_{i=0}^{\infty} x^i y^i$ is not in the image.

Remark 3.11. In the literature, another common filtration on the tensor product is given by the formula

$$(M \otimes_R N)_n = M_n \otimes_R N \oplus M \otimes_R N_n. \quad (3.5)$$

This filtration depends only on the underlying topologies of M and N , and not the filtrations. This construction gives a topology which is too coarse for our purposes. For example, the topology has the property that if $\{x_n\}$ and $\{y_n\}$ are sequences in M and N , and $y_n \rightarrow 0$ then $x_n \otimes y_n \rightarrow 0$ (regardless of the behavior of x_n).

Remark 3.12. If M and N are filtered over \mathbb{N} and $N_0 = N$ and $M_0 = M$ (i.e. the filtrations are *bounded below* and *exhaustive*), then the filtrations in Equations (3.4) and (3.5) give equivalent topologies since

$$M \otimes N_{2n} \oplus M_{2n} \otimes N \subseteq M_0 \otimes N_{2n} \oplus \cdots \oplus M_{2n} \otimes N_0 \subseteq M \oplus N_n \oplus M_n \otimes N,$$

for all $n \geq 0$.

Remark 3.13. For general filtrations over \mathbb{Z} (e.g. ones which are not bounded from below) the topology in Equation (3.4) depends on the filtrations on M and N and not just their underlying topologies. For example, give $M = \mathbb{F}[x, x^{-1}]$ the filtration induced by the weight function $w(x^i) = i$. Consider the modules $N = N' = \mathbb{F}[y]$ with the weight functions $w_N(y^i) = i$ and $w_{N'}(y^i) = 2i$, respectively. The topologies induced by w_N and $w_{N'}$ are the same (they are the (y) -adic topologies). On the other hand, the tensor product $M \otimes_{\mathbb{F}} N$ has a different topology than the tensor product $M \otimes_{\mathbb{F}} N'$. To see this, note that the sequence $z_i = x^{-i} y^i$ converges to zero in the latter tensor product, but not the former.

We define the *completed tensor product* as the inverse limit

$$M \hat{\otimes}_R N := \varprojlim_{n \in \mathbb{Z}} (M \otimes_R N) / (M \otimes_R N)_n.$$

Remark 3.14. To avoid various pathologies, it is important to assume that our filtrations are *exhaustive*, i.e., $\bigcup_{i \in \mathbb{Z}} M_i = M$ (this is the case for any filtration induced by a weight function on generators). As a concrete example of a pathology, let $M = \mathbb{F}$ and say that $M_i = \{0\}$ for $i \in \mathbb{N}$, and let $N = \mathbb{F}[x]$, with $N_i = (x^i)$ for $i \in \mathbb{N}$. Note that the filtration on M is not exhaustive. Then $M \hat{\otimes}_{\mathbb{F}} N \cong \mathbb{F}[x]$ with trivial filtration (i.e. the subspace in filtration in level i is $\{0\}$ for all i). On the other hand $M \hat{\otimes} \hat{N}$ is $\mathbb{F}[[x]]$, also with trivial filtration. In particular $M \hat{\otimes}_{\mathbb{F}} N \neq M \hat{\otimes}_{\mathbb{F}} \hat{N}$. Extending this example further, we note that $M \hat{\otimes}_{\mathbb{F}} (N \hat{\otimes}_{\mathbb{F}} N) \cong \mathbb{F}[[x_1, x_2]]$, while $(M \hat{\otimes}_{\mathbb{F}} N) \hat{\otimes}_{\mathbb{F}} N \cong \mathbb{F}[x_1, x_2]$ so the completed tensor product is not associative in this example.

By using exhaustive filtrations (e.g. filtrations induced by a weight function), we may avoid the above pathologies:

Lemma 3.15. *Suppose that M , N and L are modules equipped with exhaustive filtrations over \mathbb{Z} . Then*

$$(1) \quad M \hat{\otimes} N \cong \hat{M} \hat{\otimes} N \cong M \hat{\otimes} \hat{N}.$$

(2) *The completed tensor product is associative* $(L \hat{\otimes} M) \hat{\otimes} N \cong L \hat{\otimes} (M \hat{\otimes} N)$.

Proof. The second claim is an easy consequence of the first claim, so we describe the proof of the first claim. We consider the first stated isomorphism $M \hat{\otimes} N \cong \hat{M} \hat{\otimes} N$. Recall that $M \hat{\otimes} N$ is the inverse limit over $n \in \mathbb{Z}$ of $(M \otimes N)/(\sum_{i+j=n} M_i \otimes N_j)$ and $\hat{M} \hat{\otimes} N$ is the inverse limit of $(\hat{M} \otimes N)/(\sum_{i+j=n} \hat{M}_i \otimes N_j)$. We claim that

$$(M \otimes N)/(\sum_{i+j=n} M_i \otimes N_j) \cong (\hat{M} \otimes N)/(\sum_{i+j=n} \hat{M}_i \otimes N_j), \quad (3.6)$$

which is clearly sufficient. There is a canonical map from the left-side to the right-side. A map in the opposite direction is given as follows. Let $\hat{\xi} \otimes y \in \hat{M} \otimes N$, and let j_0 sufficiently small that $y \in N_{j_0}$ (here, we use that N is exhaustive). Let $i_0 = n - j_0$. Recall from [AM69, Corollary 10.4] that the canonical map $M/M_{i_0} \rightarrow \hat{M}/\hat{M}_{i_0}$ is an isomorphism. We map $\hat{\xi} \otimes y$ to $\xi \otimes y \in M \otimes N$, where $\xi \in M$ is any lift of the image of $\hat{\xi}$ in M/M_{i_0} under the inverse of the above isomorphism. It is a straightforward exercise to verify that this induces a well-defined map from the right-hand side of Equation (3.6) to the left-hand side, and furthermore, this map is inverse to the canonical map from the left-hand to the right-hand side of the equation. \square

Definition 3.16. If $f: M \rightarrow N$ is an R -module homomorphism between \mathbb{Z} -filtered R -modules, we say that f is *weakly filtered* if there is a $C \in \mathbb{N}$ such that

$$M_{n+C} \subseteq f^{-1}(N_n)$$

for all $n \in \mathbb{Z}$. Note that weakly filtered maps are continuous.

Tensor products of merely continuous maps between \mathbb{Z} -filtered modules are not necessarily continuous, as the following example demonstrates:

Example 3.17. Let $M = \mathbb{F}[x]$ with $M_n = (x^{2n})$ for $n \geq 0$ and $M_n = \mathbb{F}[x]$ for $n \leq 0$. Let $N = \mathbb{F}[x]$ and define a filtration $(N_n)_{n \in \mathbb{Z}}$ by setting $N_n = (x^n)$ for $n \geq 0$, and $N_n = \mathbb{F}[x]$ for $n \leq 0$. Let $S = \mathbb{F}[y, y^{-1}]$ with $S_n = \text{Span}_{\mathbb{F}}(y^i : i \geq n)$. Firstly, the canonical isomorphism $f: M \rightarrow N$ is continuous, but not weakly filtered. On the other hand, the map $f \otimes \text{id}: M \otimes_{\mathbb{F}} S \rightarrow N \otimes_{\mathbb{F}} S$ is not continuous. This can be seen since $x^n y^{-n}$ approaches 0 in the domain, but not the codomain.

Example 3.18. If M, N and S are \mathbb{Z} -filtered and $f: M \rightarrow N$ is weakly filtered, then $f \otimes \text{id}: M \otimes S \rightarrow N \otimes S$ is also weakly filtered. The composition of weakly filtered maps is also weakly filtered.

We may also consider A_∞ -algebras, type- D modules and type- A modules in the topological setting, without substantial complication. The reader should compare the following to [LOT20, Section 9], which is similar.

Definition 3.19.

- (1) Suppose \mathcal{A} is a (\mathbf{k}, \mathbf{k}) -bimodule which has an exhaustive filtration over \mathbb{Z} by \mathbf{k} -submodules. We say \mathcal{A} is a *topological A_∞ -algebra* if it is equipped with a collection of weakly filtered maps

$$\mu_i: \mathcal{A} \hat{\otimes}_{\mathbf{k}} \cdots \hat{\otimes}_{\mathbf{k}} \mathcal{A} \rightarrow \mathcal{A},$$

satisfying the A_∞ associativity relations.

- (2) A *topological type- D module* consists of an ordinary type- D module $N^{\mathcal{A}} = (N, \delta^1)$ over an algebra \mathbf{k} such that N and \mathcal{A} are equipped with exhaustive filtrations of \mathbf{k} -submodules with respect to which the map

$$\delta^1: N \rightarrow N \hat{\otimes}_{\mathbf{k}} \mathcal{A}$$

is weakly filtered. A *topological A_{∞} -module* is analogous.

Note that we could naturally consider a restricted version of a type- D module where δ^1 has codomain $N \otimes_{\mathbf{k}} \mathcal{A}$ instead of $N \hat{\otimes}_{\mathbf{k}} \mathcal{A}$. In practice, working with completions is much more convenient. For example in Section 14, we consider natural morphisms of type- D modules which require completions (i.e. infinite sums) to define.

Note that if $M^{\mathcal{A}}$ and ${}_{\mathcal{A}}N$ are type- D and type- A modules, then we may form their *completed box tensor product* $M^{\mathcal{A}} \hat{\boxtimes} {}_{\mathcal{A}}N$, similarly to the ordinary box tensor product of [LOT18]. The underlying vector space is

$$M \hat{\otimes}_{\mathbf{k}} N,$$

and the differential is defined in the same manner as in Equation (3.1). The differential is well-defined as long as one of M or N is suitably bounded as a type- D or type- A module, in the sense of [LOT18, Section 2]. Under the assumption that one of M or N is suitably bounded, the differential on the box tensor product involves only finitely many terms. Furthermore each term involved in the differential is a composition of continuous maps (compare Example 3.18), and hence is continuous.

Remark 3.20. One could generalize the Lipshitz-Ozsváth-Thurston box tensor product to certain settings where neither M nor N satisfies Lipshitz, Ozsváth and Thurston's boundedness assumption. We could do this by assuming that the structure maps satisfy suitable filtration properties so that the infinite sum in the definition of the box tensor product converges. We will not pursue a general formalism in our present paper, though we note that such a situation arises in Lemmas 14.2 and 14.3. Therein, we verify convergence directly.

4. THE HOMOLOGICAL PERTURBATION LEMMA AND VARIATIONS

In this section, we describe several versions of the homological perturbation lemma.

4.1. A_{∞} -modules. The following is the homological perturbation lemma for A_{∞} -modules. Kadeishvili proved that A_{∞} -algebra structures could be transferred along homotopy equivalences of the underlying chain complex, when coefficients were in a field [Kad82]. A formula for the perturbed A_{∞} -module structure in terms of trees may be found in work of Kontsevich and Soibelman [KS01, Section 6.4]. See [Kel02, Section 3.3] or [Sei08, Remark 1.15] for more historical context and development of ideas.

Lemma 4.1. *Suppose that \mathcal{A} is an dg-algebra over \mathbf{k} , and ${}_{\mathcal{A}}M$ is an A_{∞} -module, (Z, m_1^Z) is a chain complex over \mathbf{k} , and that we have three maps of left \mathbf{k} -modules*

$$i: Z \rightarrow M, \quad \pi: M \rightarrow Z \quad \text{and} \quad h: M \rightarrow M$$

satisfying the following:

- (1) i and π are chain maps.
- (2) $\pi \circ i = \text{id}_Z$.
- (3) $i \circ \pi = \text{id}_M + \partial_{\text{Mor}}(h)$.

- (4) $h \circ i = 0$.
- (5) $\pi \circ h = 0$.
- (6) $h \circ h = 0$.

In the above, $\partial_{\text{Mor}}(h) = h \circ m_1^M + m_1^M \circ h$. Then there is an A_∞ -module structure on Z , extending m_1^Z , such that the maps π , i and h extend to A_∞ -module morphisms which satisfy all of the above relations as A_∞ -module maps.

One extremely useful aspect of the homological perturbation lemma is that all of the maps have a concrete description. The structure maps on Z are given by the diagrams shown in Figure 4.1. Therein $m_{>1}$ denotes the A_∞ structure maps of M , with m_1 excluded.

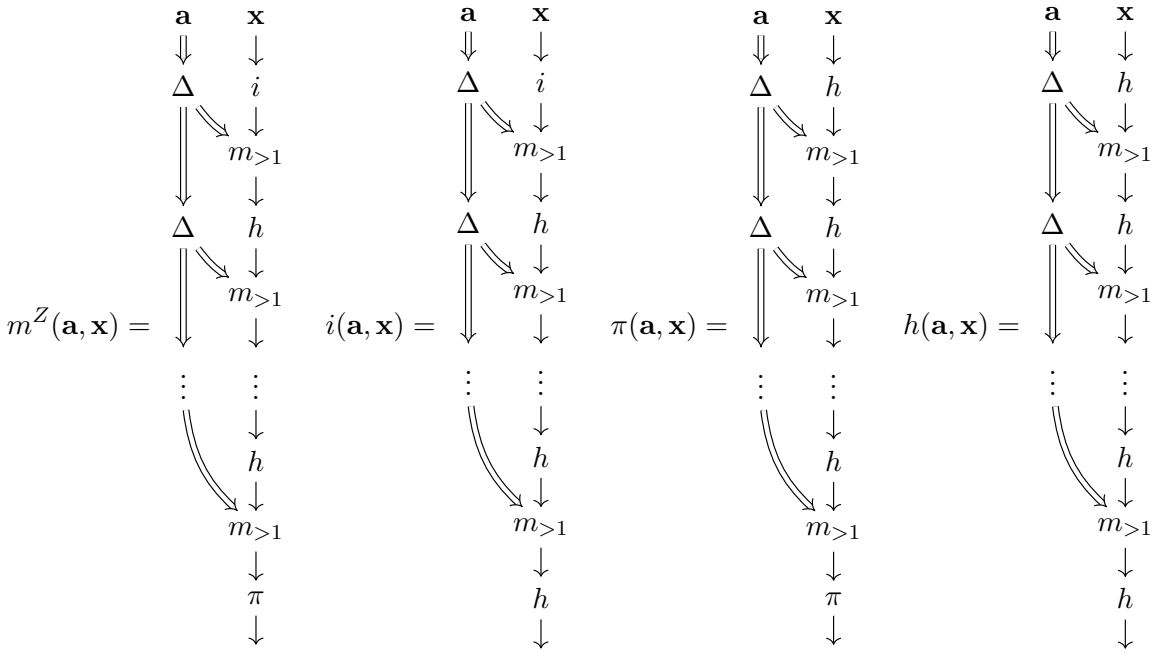

FIGURE 4.1. The maps appearing in the homological perturbation lemma for A_∞ -modules.

4.2. DA -bimodules. There is a homological perturbation lemma for DA -bimodules, which we will use extensively. The statement and proof are similar to the statement for A_∞ -modules. If $(\mathcal{A}M^{\mathcal{B}}, \delta_j^1)$ is a DA -bimodule, we will write $M^{\mathcal{B}}$ for the associated type- D module which has the same generators as $\mathcal{A}M^{\mathcal{B}}$, and whose structure map is given by the map δ_1^1 from $\mathcal{A}M^{\mathcal{B}}$.

Lemma 4.2. *Suppose that \mathcal{A} and \mathcal{B} are dg-algebras, and that $\mathcal{A}M^{\mathcal{B}}$ is a strictly unital type- DA bimodule, $Z^{\mathcal{B}}$ is a type- D module over \mathcal{B} , and that we have three morphisms of type- D modules*

$$i^1: Z^{\mathcal{B}} \rightarrow M^{\mathcal{B}}, \quad \pi^1: M^{\mathcal{B}} \rightarrow Z^{\mathcal{B}} \quad \text{and} \quad h^1: M^{\mathcal{B}} \rightarrow M^{\mathcal{B}}$$

satisfying the following:

$$\delta_{j+1}^1(\mathbf{a}, \mathbf{x}) = \begin{array}{c} \mathbf{a} \\ \Downarrow \\ \Delta \\ \Downarrow \\ \Delta \\ \Downarrow \\ \vdots \\ \Downarrow \\ \vdots \\ \Downarrow \\ h^1 \\ \Downarrow \\ \delta_{>1}^1 \\ \Downarrow \\ \pi^1 \\ \Downarrow \\ \mu_2 \end{array} \quad \begin{array}{c} \mathbf{x} \\ \downarrow \\ i^1 \\ \downarrow \\ \delta_{>1}^1 \\ \downarrow \\ h^1 \\ \downarrow \\ \delta_{>1}^1 \\ \downarrow \\ \vdots \\ \downarrow \\ h^1 \\ \downarrow \\ \delta_{>1}^1 \\ \downarrow \\ \pi^1 \\ \downarrow \\ \mu_2 \end{array} \quad (4.1)$$

FIGURE 4.2. The structure relation δ_{j+1}^1 from the homological perturbation lemma for DA -bimodules.

- (1) i^1 and π^1 are homomorphisms of type- D modules (i.e. cycles).
- (2) $\pi^1 \circ i^1 = \text{id}_Z$.
- (3) $i^1 \circ \pi^1 = \text{id}_M + \partial_{\text{Mor}}(h^1)$.
- (4) $h^1 \circ i^1 = 0$.
- (5) $\pi^1 \circ h^1 = 0$.
- (6) $h^1 \circ h^1 = 0$.

Then there is an induced DA -bimodule structure on ${}_{\mathcal{A}}Z^{\mathcal{B}}$, extending $Z^{\mathcal{B}}$, such that the maps π^1 , i^1 and h^1 extend to DA -bimodule morphisms which satisfy all of the above relations as DA -bimodule morphisms.

We refer the reader to [OS18, Lemma 2.12] for a proof. Note that the maps are similar to those appearing in Figure 4.1. The structure map δ_{j+1}^1 is indicated in Figure 4.2. The other maps i_j^1 , π_j^1 and h_j^1 are constructed by a similar modification of the other maps in Figure 4.1. Here, $\delta_{>1}^1$ denotes δ_j^1 for some $j > 1$. The final μ_2 map means to multiply all of the inputs using several applications of μ_2 .

4.3. Hypercubes. In this section, we review a version of the homological perturbation lemma for hypercubes. This version of the homological perturbation lemma is from [HHSZ21a], where a proof may be found. Lemma 4.3 is similar to other formulations

of the homological perturbation lemma in the context of filtered chain complexes. For example, see work of Huebschmann–Kadeishvili [HK91]. A similar, though slightly less explicit, construction for transferring hypercube structures along homotopy equivalences is described by Liu [Liu14, Section 5.6].

Lemma 4.3. *Suppose that $\mathcal{C} = (C_\varepsilon, D_{\varepsilon, \varepsilon'})_{\varepsilon \in \mathbb{E}_n}$ is a hypercube of chain complexes, and $(Z_\varepsilon)_{\varepsilon \in \mathbb{E}_n}$ is a collection of chain complexes, indexed by $\varepsilon \in \mathbb{E}_n$. Furthermore, suppose that for each $\varepsilon \in \mathbb{E}_n$, we have chosen maps*

$$\pi_\varepsilon: C_\varepsilon \rightarrow Z_\varepsilon \quad i_\varepsilon: Z_\varepsilon \rightarrow C_\varepsilon \quad h_\varepsilon: C_\varepsilon \rightarrow C_\varepsilon,$$

satisfying

$$\pi_\varepsilon \circ i_\varepsilon = \text{id}, \quad i_\varepsilon \circ \pi_\varepsilon = \text{id} + [\partial, h_\varepsilon], \quad h_\varepsilon \circ h_\varepsilon = 0, \quad \pi_\varepsilon \circ h_\varepsilon = 0 \quad \text{and} \quad h_\varepsilon \circ i_\varepsilon = 0$$

and such that π_ε and i_ε are chain maps. With the above data chosen, there are canonical hypercube structure maps $\delta_{\varepsilon, \varepsilon'}: Z_\varepsilon \rightarrow Z_{\varepsilon'}$ so that $\mathcal{Z} = (Z_\varepsilon, \delta_{\varepsilon, \varepsilon'})$ is a hypercube of chain complexes, and also there are morphisms of hypercubes

$$\Pi: \mathcal{C} \rightarrow \mathcal{Z}, \quad I: \mathcal{Z} \rightarrow \mathcal{C} \quad \text{and} \quad H: \mathcal{C} \rightarrow \mathcal{C}$$

such that I and Π are chain maps, and

$$\Pi \circ I = \text{id}_{\mathcal{Z}} \quad \text{and} \quad I \circ \Pi = \text{id}_{\mathcal{C}} + \partial_{\text{Mor}}(H).$$

It is important to understand that the structure maps $\delta_{\varepsilon, \varepsilon'}$ and the morphisms Π and I are determined completely by an explicit formula. We now describe $\delta_{\varepsilon, \varepsilon'}$. Suppose that $\varepsilon < \varepsilon'$ are points in \mathbb{E}_n . The hypercube structure maps $\delta_{\varepsilon, \varepsilon'}$ are given by the following sum:

$$\delta_{\varepsilon, \varepsilon'} := \sum_{\varepsilon = \varepsilon_1 < \dots < \varepsilon_j = \varepsilon'} \pi_{\varepsilon'} \circ D_{\varepsilon_{j-1}, \varepsilon_j} \circ h_{\varepsilon_{j-1}} \circ D_{\varepsilon_{j-2}, \varepsilon_{j-1}} \circ \dots \circ h_{\varepsilon_2} \circ D_{\varepsilon_1, \varepsilon_2} \circ i_\varepsilon.$$

The component of the map I sending coordinate ε to coordinate ε' is given via the formula

$$I_{\varepsilon, \varepsilon'} := \sum_{\varepsilon = \varepsilon_1 < \dots < \varepsilon_j = \varepsilon'} h_{\varepsilon_j} \circ D_{\varepsilon_{j-1}, \varepsilon_j} \circ \dots \circ h_{\varepsilon_2} \circ D_{\varepsilon_1, \varepsilon_2} \circ i_\varepsilon.$$

Similarly, Π is given by the formula

$$\Pi_{\varepsilon, \varepsilon'} := \sum_{\varepsilon = \varepsilon_1 < \dots < \varepsilon_j = \varepsilon'} \pi_{\varepsilon'} \circ D_{\varepsilon_{j-1}, \varepsilon_j} \circ h_{\varepsilon_{j-1}} \circ D_{\varepsilon_{j-2}, \varepsilon_{j-1}} \circ \dots \circ D_{\varepsilon_1, \varepsilon_2} \circ h_{\varepsilon_1}.$$

4.4. Hypercubes of DA -bimodules. There is a version of the homological perturbation lemma which naturally generalizes both the homological perturbation lemmas for DA -bimodules and hypercubes of chain complexes.

Definition 4.4. A *hypercube of DA -bimodules* consists of a DA -bimodule (C, δ_*^1) , such that C decomposes as $C = \bigoplus_{\varepsilon \in \mathbb{E}_n} C_\varepsilon$, where each C_ε is itself a (\mathbf{j}, \mathbf{k}) -module. Furthermore, the structure map δ_{j+1}^1 decomposes as a sum of maps

$$\delta_{j+1, \varepsilon, \varepsilon'}^1: \mathcal{A}^{\otimes j} \otimes C_\varepsilon \rightarrow C_{\varepsilon'} \otimes \mathcal{B}.$$

where $j \geq 0$, and $\varepsilon \leq \varepsilon'$.

The above definition is a special case of Lipshitz, Ozsváth and Thurston's notion of a *filtered DA -bimodule* [LOT14, Section 2.2].

Lemma 4.5. *Suppose that \mathcal{A} and \mathcal{B} are dg-algebras. Suppose also that ${}_{\mathcal{A}}\mathcal{C}^{\mathcal{B}} = ({}_{\mathcal{A}}C_{\varepsilon}^{\mathcal{B}}, D_{*,\varepsilon,\varepsilon'}^1)_{\varepsilon \in \mathbb{E}_n}$ is a hypercube of DA-bimodules, and suppose that we for each $\varepsilon \in \mathbb{E}_n$ we have chosen type-D modules $(Z_{\varepsilon}^{\mathcal{B}})_{\varepsilon \in \mathbb{E}_n}$, as well as morphisms of type-D modules*

$$\pi_{\varepsilon}^1: C_{\varepsilon}^{\mathcal{B}} \rightarrow Z_{\varepsilon}^{\mathcal{B}}, \quad i_{\varepsilon}^1: Z_{\varepsilon}^{\mathcal{B}} \rightarrow C_{\varepsilon}^{\mathcal{B}} \quad \text{and} \quad h_{\varepsilon}^1: C_{\varepsilon}^{\mathcal{B}} \rightarrow C_{\varepsilon}^{\mathcal{B}}$$

satisfying

$$\pi_{\varepsilon}^1 \circ i_{\varepsilon}^1 = \text{id}_{Z_{\varepsilon}^{\mathcal{B}}}, \quad i_{\varepsilon}^1 \circ \pi_{\varepsilon}^1 + \text{id}_{C_{\varepsilon}^{\mathcal{B}}} = \partial_{\text{Mor}}(h_{\varepsilon}^1), \quad h_{\varepsilon}^1 \circ h_{\varepsilon}^1 = 0, \quad h_{\varepsilon}^1 \circ i_{\varepsilon}^1 = 0, \quad \text{and} \quad \pi_{\varepsilon}^1 \circ h_{\varepsilon}^1 = 0,$$

and such that π_{ε}^1 and i_{ε}^1 are homomorphisms of DA-bimodules (i.e. cycles). Such data uniquely determines hypercube structure maps $\delta_{j+1,\varepsilon,\varepsilon'}^1: {}_{\mathcal{A}}^{\otimes j} \otimes Z_{\varepsilon}^{\mathcal{B}} \rightarrow Z_{\varepsilon'}^{\mathcal{B}} \otimes \mathcal{B}$, which make ${}_{\mathcal{A}}\mathcal{Z}^{\mathcal{B}} = ({}_{\mathcal{A}}Z_{\varepsilon}^{\mathcal{B}}, \delta_{*,\varepsilon,\varepsilon'}^1)$ a hypercube of DA-bimodules. Furthermore, there are morphisms of hypercubes of DA-bimodules

$$\Pi_*^1: {}_{\mathcal{A}}C^{\mathcal{B}} \rightarrow {}_{\mathcal{A}}\mathcal{Z}^{\mathcal{B}} \quad I_*^1: {}_{\mathcal{A}}\mathcal{Z}^{\mathcal{B}} \rightarrow {}_{\mathcal{A}}C^{\mathcal{B}} \quad \text{and} \quad H_*^1: {}_{\mathcal{A}}C^{\mathcal{B}} \rightarrow {}_{\mathcal{A}}C^{\mathcal{B}},$$

which satisfy analogous relations to i_{ε}^1 , π_{ε}^1 and h_{ε}^1 .

We now describe the maps δ_*^1 , Π_*^1 , I_*^1 and H_*^1 . We focus on the structure map $\delta_{j+1,\varepsilon,\varepsilon'}^1$. This map is defined by modifying Figure 4.2 as follows. In place of each $\delta_{>1}^1$ labeled therein, we are allowed one of two maps:

- (1) A hypercube map $D_{j+1,\varepsilon,\varepsilon'}^1$ for \mathcal{C} , such that $\varepsilon < \varepsilon'$. Furthermore, we assume only that $j \geq 0$ (so that we allow the case that there are no algebra inputs here).
- (2) An internal structure map $D_{>1,\varepsilon,\varepsilon}^1$ of some ${}_{\mathcal{A}}C_{\varepsilon}^{\mathcal{B}}$ (so in this case we do not allow instances of the internal $D_{1,\varepsilon,\varepsilon}^1$).

The maps Π_*^1 , I_*^1 and H_*^1 are defined by small modifications, similar to Figure 4.1. We leave the proof of the above lemma to the reader, as it is a straightforward variation of Lemma 4.2.

5. BACKGROUND ON THE LINK SURGERY FORMULA

In this section, we give some background on the link surgery formula of Manolescu and Ozsváth [MO10].

5.1. Statement of the link surgery formula. In this section, we state Manolescu and Ozsváth's link surgery formula, and recall a few basic properties. We state their theorem in the case that we use a *basic system of Heegaard diagrams*. In this case, many of the hypercube maps vanish. We will describe more detail about several aspects of the construction in Section 7.

Definition 5.1. A Heegaard link diagram $(\Sigma, \boldsymbol{\alpha}, \boldsymbol{\beta}, \mathbf{w}, \mathbf{z})$ for (Y, L) is *link minimal* if each link component of L has exactly two basepoints on it.

Let $\mathcal{H} = (\Sigma, \boldsymbol{\alpha}, \boldsymbol{\beta}, \mathbf{w}, \mathbf{z})$ be a link-minimal Heegaard diagram for an oriented link $L \subseteq S^3$. If $\vec{M} \subseteq L$ is an oriented sublink, write $\mathcal{H}^{L-\vec{M}}$ for the diagram obtained by removing some basepoints from \mathcal{H} , as follows. If $L_i \subseteq \vec{M}$ is a link component such that the orientation of L_i is consistent between \vec{M} and L , then we remove z_i . If the orientation of L_i is opposite between \vec{M} and L , we remove w_i . If we write \mathcal{H}^{L-M} without specifying an orientation on M , we mean to use the orientation from L (i.e. we remove z_i whenever $L_i \subseteq M$).

If L is a link, define the affine lattice over \mathbb{Z}^ℓ

$$\mathbb{H}(L) = \prod_{i=1}^{\ell} \mathbb{H}_i(L),$$

where $\mathbb{H}_i(L) = lk(L_i, L - L_i)/2 + \mathbb{Z}$. If $\mathbf{x} \in \mathbb{T}_\alpha \cap \mathbb{T}_\beta$, then the Alexander grading $A(\mathbf{x})$ is defined to take values in $\mathbb{H}(L)$.

If $\mathbf{s} \in \mathbb{H}(L)$, and \mathcal{H} is a link minimal Heegaard diagram for L such that all free-basepoints are in \mathbf{w} , then Manolescu and Ozsváth consider the free $\mathbb{F}[[U_1, \dots, U_n]]$ -module $\mathfrak{A}^-(\mathcal{H}^L, \mathbf{s})$ generated by monomials of the form

$$U_1^{i_1} \dots U_n^{i_n} \cdot \mathbf{x}$$

where $\mathbf{x} \in \mathbb{T}_\alpha \cap \mathbb{T}_\beta$, such that $i_j \geq 0$ for all j , and such that $A_j^L(\mathbf{x}) \leq s_j + i_j$ whenever w_j is a link basepoint. Here, $n = |\mathbf{w}|$. They equip $\mathfrak{A}^-(\mathcal{H}^L, \mathbf{s})$ with the differential which counts Maslov index 1 holomorphic disks, weighted by the product of $U_i^{n w_i(\phi)}$.

We will also occasionally write

$$A^-(\mathcal{H}^L, \mathbf{s})$$

for the free $\mathbb{F}[[U_1, \dots, U_n]]$ -module which has the same generators as $\mathfrak{A}^-(\mathcal{H}^L, \mathbf{s})$.

Whenever \vec{M} is an oriented sublink of L (possibly with orientation differing from L), Manolescu and Ozsváth define a reduction map

$$\psi^{\vec{M}}: \mathbb{H}(L) \rightarrow \mathbb{H}(L - M).$$

See [MO10, Section 3.7]. If we write just ψ^M , we mean $\psi^{\vec{M}}$ for the orientation on M inherited from L .

If Λ is a framing on L , then the link surgery complex is defined as

$$\mathbb{X}_\Lambda(L) = \bigoplus_{M \subseteq L} \prod_{\mathbf{s} \in \mathbb{H}(L)} \mathfrak{A}^-(\mathcal{H}^{L-M}, \psi^M(\mathbf{s})).$$

(Note Manolescu and Ozsváth write $\mathcal{C}^-(\mathcal{H}, \Lambda)$ for this complex).

The differential $\mathcal{D}: \mathbb{X}_\Lambda(L) \rightarrow \mathbb{X}_\Lambda(L)$ may be decomposed as

$$\mathcal{D} = \sum_{N \subseteq M} \sum_{\vec{N} \in \Omega(N)} \Phi^{\vec{N}},$$

where $\Omega(N)$ denotes the set of orientations on N .

If $M \subseteq L$ and $N \subseteq L - M$, and $\vec{N} \in \Omega(N)$, then $\Phi^{\vec{N}}$ maps $\{\mathbf{s}\} \times \mathfrak{A}^-(\mathcal{H}^{L-M}, \psi^M(\mathbf{s}))$ to $\{\mathbf{s} + \Lambda_{L, \vec{N}}\} \times \mathfrak{A}^-(\mathcal{H}^{L-M-N}, \psi^{M+\vec{N}}(\mathbf{s}))$. Here, $\Lambda_{L, \vec{N}} \in \mathbb{Z}^\ell$ is obtained by identifying $H_1(S^3 \setminus L) \cong \mathbb{Z}^\ell$, and then defining Λ_i to be the homology element determined by the sum of the framings of the components of \vec{N} which are oriented oppositely to L . If $M \subseteq L$ and $N \not\subseteq L - M$, then $\Phi^{\vec{N}}$ vanishes on $\{\mathbf{s}\} \times \mathfrak{A}^-(\mathcal{H}^{L-M}, \psi^M(\mathbf{s}))$.

If we want to consider the map $\Phi^{\vec{N}}$ restricted to a particular $\prod_{\mathbf{s} \in \mathbb{H}(L)} \mathfrak{A}^-(\mathcal{H}^{L-M}, \psi^M(\mathbf{s}))$, then we will write

$$\Phi_{L_0, L_1}^{\vec{N}},$$

where $L_0 = L - M$ and $L_1 = L - M - N$.

Remark 5.2. Manolescu and Ozsváth use slightly different notation for the map $\Phi^{\vec{N}}$. Instead, they write $\Phi_{\psi^M(\mathfrak{s})}^{\vec{N}}$ for the above map. For algebraic purposes, it is convenient for us to take the direct product over all \mathfrak{s} .

Remark 5.3. The only dependence on the framing Λ in the maps $\Phi_{\psi^M(\mathfrak{s})}^{\vec{N}}$ is via the shift of index $\mathfrak{s} \mapsto \mathfrak{s} + \Lambda_{L, \vec{N}}$.

We will review the construction of the hypercube maps $\Phi^{\vec{N}}$ in more detail in Section 7.

5.2. Gradings and algebraic reduction maps. In this section, we state several grading formulas which are useful when working with the link surgery formula.

Definition 5.4. Suppose that $\mathcal{H} = (\Sigma, \alpha, \beta, \mathbf{w}, \mathbf{z})$ is a link minimal Heegaard diagram. We call a subset $\mathbb{W} \subseteq \mathbf{w} \cup \mathbf{z}$ a *complete set of basepoints* on \mathcal{H} if \mathbb{W} contains each free basepoint on \mathcal{H} and \mathbb{W} contains exactly one basepoint from each link component.

Suppose \mathcal{H} is a diagram for a link L in Y , each of whose components is null-homologous, and $\mathfrak{s} \in \text{Spin}^c(Y)$ is torsion. Given a complete set of basepoints \mathbb{W} on \mathcal{H} , there is a well defined Maslov grading $\text{gr}_{\mathbb{W}}$ on $\mathcal{CFL}^-(\mathcal{H}, \mathfrak{s})$. The grading $\text{gr}_{\mathbb{W}}$ is induced from the absolute grading of $CF^-(Y, \mathbb{W}, \mathfrak{s})$, by declaring the natural quotient map $\mathcal{CFL}^-(\mathcal{H}, \mathfrak{s}) \rightarrow CF^-(Y, \mathbb{W}, \mathfrak{s})$ to be grading preserving. There is also an ℓ -component Alexander grading $A^{\mathbb{W}} = (A_1^{\mathbb{W}}, \dots, A_\ell^{\mathbb{W}})$. Note that a complete set of basepoints also determines an orientation on L , via the convention that L intersects the Heegaard surface Σ negatively at \mathbb{W} . In particular, we may equivalently specify the Alexander grading A^L by picking an orientation on L .

The variable \mathcal{U}_i has $\text{gr}_{\mathbb{W}}$ -grading -2 if $w_i \in \mathbb{W}$, and 0 if $w_i \notin \mathbb{W}$. Similarly \mathcal{V}_i has $\text{gr}_{\mathbb{W}}$ -grading -2 if $z_i \in \mathbb{W}$ and 0 otherwise.

Remark 5.5. There are two natural conventions for defining the absolute grading for multi-pointed 3-manifolds. We recall that adding a basepoint has the effect on \widehat{HF} of tensoring with a 2-dimensional vector space $V = \mathbb{F} \oplus \mathbb{F}$. See [OS08a, Section 6]. In this paper, we use the convention that the top degree element of V has absolute grading 0 . This is different than the TQFT convention of [Zem19a], where V is supported in gradings $1/2$ and $-1/2$.

The following is implicit in the work of Manolescu and Ozsváth [MO10] (see in particular [MO10, Section 12]). In particular, the results are not new to our paper, however the presentation is helpful.

Lemma 5.6. *Let $L = L_1 \cup \dots \cup L_\ell$ denote an ℓ -component link in a 3-manifold Y , such that each component is null-homologous, and suppose Y is equipped with a torsion Spin^c structure \mathfrak{s} . Let $\mathcal{H} = (\Sigma, \alpha, \beta, \mathbf{w}, \mathbf{z})$ be a link minimal Heegaard diagram. Let \mathcal{C} denote the full link Floer complex $\mathcal{CFL}^-(\mathcal{H}, \mathfrak{s})$ over $\mathbb{F}[\mathcal{U}_1, \dots, \mathcal{U}_n, \mathcal{V}_1, \dots, \mathcal{V}_\ell]$, where $n = |\mathbf{w}|$ and $\ell = |\mathbf{z}|$. (In particular, we assume that all free basepoints are in \mathbf{w} , to simplify the notation).*

(1) *If \mathbb{W} is complete collection of basepoints on \mathcal{H} , and $z_i \notin \mathbb{W}$, then the quotient map*

$$\mathcal{Q}_{\mathcal{V}_i}: \mathcal{C} \rightarrow \mathcal{C}/(\mathcal{V}_i - 1)$$

is grading preserving with respect to $\text{gr}_{\mathbb{W}}$. Similarly, the quotient map

$$\mathcal{Q}_{\mathcal{W}_i}: \mathcal{C} \rightarrow \mathcal{C}/(\mathcal{W}_i - 1),$$

is grading preserving if $w_i \notin \mathbb{W}$.

- (2) Suppose that L_j is a component of L , and let $\mathbb{W}_0 \cup \{w_j\}$ be a complete collection of basepoints, and write $\{w_j, z_j\} = L_j \cap (\mathbf{w} \cup \mathbf{z})$. Let L and L_j have orientations induced by $\mathbb{W}_0 \cup \{w_j\}$. Then

$$\text{gr}_{\mathbb{W}_0 \cup \{w_j\}} - \text{gr}_{\mathbb{W}_0 \cup \{z_j\}} = 2A_j^{\mathbb{W}_0 \cup \{w_j\}} - \text{lk}(L \setminus L_j, L_j).$$

- (3) Suppose that \mathbb{W} and \mathbb{W}' are two complete collections of basepoints which coincide at index j . Then

$$A_j^{\mathbb{W}} = A_j^{\mathbb{W}'}$$

- (4) Let $L_i \subseteq L$, and orient both using the basepoints $\mathbb{W} = \mathbf{w}$, and suppose $i \neq j$. Give \mathcal{C} and $\mathcal{C}/(\mathcal{W}_i - 1)$ the grading A_j induced by the basepoints $\mathbb{W} = \mathbf{w}$. For $j \neq i$,

$$A_j(\mathcal{Q}_{\mathcal{W}_i}) = -\frac{1}{2} \text{lk}(L_i, L_j).$$

- (5) Let $L_i \subseteq L$, and orient both using the basepoints $\mathbb{W} = \mathbf{w}$, and suppose $j \neq i$. Give \mathcal{C} and $\mathcal{C}/(\mathcal{W}_i - 1)$ the grading A_j induced by the basepoints \mathbb{W} and $(\mathbb{W} \setminus \{w_i\}) \cup \{z_i\}$, respectively. Then,

$$A_j(\mathcal{Q}_{\mathcal{W}_i}) = \frac{1}{2} \text{lk}(L_i, L_j).$$

Proof. Following [Zem19a], the Alexander and Maslov gradings may be defined by representing $Y \setminus N(L)$ as surgery on the complement of an ℓ -component unlink in S^3 . We pick a Heegaard triple $\mathcal{T} = (\Sigma, \boldsymbol{\alpha}, \boldsymbol{\beta}_0, \boldsymbol{\beta}, \mathbf{w}, \mathbf{z})$ which represents this 2-handle cobordism. We pick a triangle class $\psi \in \pi_2(\mathbf{x}, \mathbf{y}, \mathbf{z})$ on \mathcal{T} . Formulas for the Maslov and Alexander gradings of \mathbf{z} are described in [Zem19a, Section 5.5]. Note that since $(\Sigma, \boldsymbol{\alpha}, \boldsymbol{\beta}_0, \mathbf{w}, \mathbf{z})$ and $(\Sigma, \boldsymbol{\beta}_0, \boldsymbol{\beta}, \mathbf{w}, \mathbf{z})$ both represent an unlink in S^3 or in $\#^N(S^1 \times S^2)$, we may assume that $\text{gr}_{\mathbb{W}}(\mathbf{x}) = \text{gr}_{\mathbb{W}'}(\mathbf{x})$ and $A_j^{\mathbb{W}}(\mathbf{x}) = 0$ for any complete collection of basepoints \mathbb{W} , and similarly for \mathbf{y} .

With the above in place, claim (1) follows because the formula for $\text{gr}_{\mathbb{W}}$ does not change if we delete a basepoint which is not \mathbb{W} .

Consider now claim (2). Write $U_j \subseteq S^3$ for the unknot corresponding to $L_j \subseteq Y$ in our surgery presentation, and write S_j for the properly embedded surface $U_j \times [0, 1]$ in the 2-handle cobordism. We pick integral 2-chains F_j in Y such that $\partial F_j = -L_j$, and write \hat{S}_j for the closed surface obtained by capping S_j with F_j and Seifert disks for the unlink in S^3 . Let $[\hat{S}]$ denote the sum of the classes $[\hat{S}_i]$.

An identical argument to [Zem19a, Lemma 3.8] implies that if ψ is a homology class of triangles on the surgery diagram for the above cobordism, then

$$\mathfrak{s}_{\mathbb{W}_0 \cup \{w_j\}}(\psi) - \mathfrak{s}_{\mathbb{W}_0 \cup \{z_j\}}(\psi) = PD[S_j]. \quad (5.1)$$

Consider $\text{gr}_{\mathbb{W}_0 \cup \{w_j\}} - \text{gr}_{\mathbb{W}_0 \cup \{z_j\}}$. We may subtract the formulas in [Zem19a, Equation 5.22] and apply equation (5.1) to obtain

$$\begin{aligned} & \text{gr}_{\mathbb{W}_0 \cup \{w_j\}}(\mathbf{z}) - \text{gr}_{\mathbb{W}_0 \cup \{z_j\}}(\mathbf{z}) \\ &= \frac{c_1^2(\mathfrak{s}_{\mathbb{W}_0 \cup \{w_j\}}(\psi)) - \left(c_1(\mathfrak{s}_{\mathbb{W}_0 \cup \{w_j\}}(\psi)) - 2PD[S_j] \right)^2}{4} - 2(n_{z_j} - n_{w_j})(\psi). \end{aligned}$$

We may rearrange the above to see that

$$\begin{aligned} & \text{gr}_{\mathbb{W}_0 \cup \{w_j\}}(\mathbf{z}) - \text{gr}_{\mathbb{W}_0 \cup \{z_j\}}(\mathbf{z}) \\ &= \langle c_1(\mathfrak{s}_{\mathbb{W}_0 \cup \{w_j\}}(\psi)), \hat{S}_j \rangle - [\hat{S}_j] \cdot [\hat{S}_j] - 2(n_{z_j} - n_{w_j})(\psi) \\ &= \langle c_1(\mathfrak{s}_{\mathbb{W}_0 \cup \{w_j\}}(\psi)), \hat{S}_j \rangle - [\hat{S}] \cdot [\hat{S}_j] - 2(n_{z_j} - n_{w_j})(\psi) + [\hat{S} \setminus \hat{S}_j] \cdot [\hat{S}] \\ &= 2A_j^{\mathbb{W}_0 \cup \{w_j\}}(\mathbf{z}) + [\hat{S} \setminus \hat{S}_j] \cdot [\hat{S}_j] \\ &= 2A_j^{\mathbb{W}_0 \cup \{w_j\}}(\mathbf{z}) - lk(L - L_j, L_j). \end{aligned}$$

In the last line, we used the equality $[\hat{S} \setminus \hat{S}_j] \cdot [\hat{S}_j] = -lk(L - L_j, L_j)$, which follows since we capped with negative Seifert surfaces of L (and since we are using the outward normal first convention for boundary orientations).

We now consider claim (3). We consider the case when \mathbb{W} and \mathbb{W}' differ only at a single index $i \neq j$. Assume that \mathbb{W} contains w_i and that \mathbb{W}' contains z_i . Write L' for L with the orientation of L_i reversed. Computing directly from the definition, shows that

$$2(A_j^{\mathbb{W}} - A_j^{\mathbb{W}'}) = \langle c_1(\mathfrak{s}_{\mathbb{W}}(\psi)) - c_1(\mathfrak{s}_{\mathbb{W}'}(\psi)), \hat{S}_j \rangle - \hat{S} \cdot \hat{S}_j + \hat{S}' \cdot \hat{S}_j.$$

Here $\hat{S}' = \hat{S} - 2\hat{S}_i$. As before $\mathfrak{s}_{\mathbb{W}} - \mathfrak{s}_{\mathbb{W}'} = PD[S_i]$. Hence, the above equation gives

$$A_j^{\mathbb{W}} - A_j^{\mathbb{W}'} = 0$$

Consider claim (4) now. For this claim, we apply claim (2), with $\mathbb{W}_0 = \mathbb{W} \setminus \{w_j\}$. Since $z_i \notin \mathbb{W}_0 \cup \{w_j\}$ and $z_i \notin \mathbb{W}_0 \cup \{z_j\}$, by part (1) we know that $\mathcal{Q}_{\mathcal{V}_i}$ is homogeneously graded with respect to $\text{gr}_{\mathbb{W}_0 \cup \{w_j\}}$ and $\text{gr}_{\mathbb{W}_0 \cup \{z_j\}}$. Using claim (2), we obtain

$$2\Delta(A_j) = lk(L \setminus (L_i \cup L_j), L_j) - lk(L \setminus L_j, L_j) = -lk(L_i \setminus L_j, L_j).$$

We now consider claim (5). By claim (3), it is sufficient to compute the grading change of $A_j^{\mathbb{W}'}$ where $\mathbb{W}' = (\mathbf{w} \setminus \{w_i\}) \cup \{z_i\}$. We use part (4), but note that with respect to \mathbb{W}' , the orientation of L_i is reversed, while the orientation of L_j is unchanged. \square

5.3. On the algebra of the link surgery formula. In this section, we reformulate the algebra of the link surgery formula slightly. We begin with a convenient description of the underlying group:

Lemma 5.7. *Suppose that \mathcal{H} is a link minimal Heegaard diagram for a link L in S^3 , which has no free basepoints. Let M be a sublink of L . Write $S_M \subseteq \mathbb{F}[\mathcal{U}_1, \dots, \mathcal{U}_\ell, \mathcal{V}_1, \dots, \mathcal{V}_\ell]$ for the multiplicatively closed subset generated by \mathcal{V}_i for i such that $L_i \subseteq M$. Then there is an $\mathbb{F}[U_1, \dots, U_\ell]$ -equivariant chain isomorphism*

$$\bigoplus_{\mathbf{s} \in \mathbb{H}(L)} A^-(\mathcal{H}^{L-M}, \psi^M(\mathbf{s})) \cong S_M^{-1} \cdot \mathcal{CFL}^-(\mathcal{H}),$$

where we view U_i as acting by $\mathcal{U}_i \mathcal{V}_i$ on the right-hand side. Furthermore, if $\mathbf{s} \in \mathbb{H}(L)$, this isomorphism intertwines the summand $A^-(\mathcal{H}^{L-M}, \psi^M(\mathbf{s}))$ with the subspace of $S_M^{-1} \cdot \mathcal{CFL}^-(\mathcal{H})$ in Alexander multi-grading \mathbf{s} .

Proof. The module $S_M^{-1} \cdot \mathcal{CFL}^-(\mathcal{H})$ decomposes over Alexander gradings $\mathbf{s} \in \mathbb{H}(L)$. Hence, it is sufficient to identify the subspace in Alexander grading \mathbf{s} with

$$A^-(\mathcal{H}^{L-M}, \psi^M(\mathbf{s}))$$

in a way which commutes with the action of $\mathbb{F}[U_1, \dots, U_\ell]$. We recall that $A^-(\mathcal{H}^{L-M}, \psi^M(\mathbf{s}))$ is generated by monomials $U_1^{i_1} \cdots U_\ell^{i_\ell} \cdot \mathbf{x}$ such that $i_j \geq 0$ for all j , and

$$A_j^{L-M}(\mathbf{x}) - i_j \leq \psi_j^M(s_j)$$

for each j such that $L_j \notin M$. Here, we are writing $\mathbf{s} = (s_1, \dots, s_\ell)$. Note that by definition of $\psi_j^M(s_j)$ (see [MO10, Section 3.7]), we have

$$A_j^L(\mathbf{x}) - A_j^{L-M}(\mathbf{s}) = s_j - \psi_j^M(s_j).$$

Cf. Lemma 5.6. Hence we may think of $A^-(\mathcal{H}^{L-M}, \psi^M(\mathbf{s}))$ as being generated by monomials $U_1^{i_1} \cdots U_\ell^{i_\ell} \cdot \mathbf{x}$ such that $i_j \geq 0$ for all j and such that

$$A_j^L(\mathbf{x}) - i_j \leq s_j$$

whenever $L_j \notin M$. We may define a map

$$A^-(\mathcal{H}^{L-M}, \psi^M(\mathbf{s})) \rightarrow S_M^{-1} \cdot \mathcal{CFL}^-(\mathcal{H})$$

via the formula

$$U_1^{i_1} \cdots U_\ell^{i_\ell} \cdot \mathbf{x} \mapsto \mathcal{U}_1^{i_1} \cdots \mathcal{U}_\ell^{i_\ell} \mathcal{V}_1^{s_1 - A_1^L(\mathbf{x}) + i_1} \cdots \mathcal{V}_\ell^{s_\ell - A_\ell^L(\mathbf{x}) + i_\ell} \cdot \mathbf{x}.$$

The map is clearly a chain isomorphism onto the subspace in Alexander grading \mathbf{s} . \square

Remark 5.8. Manolescu and Ozsváth also define an inclusion map

$$\mathcal{I}_{\mathbf{s}}^{\vec{N}} : \mathfrak{A}^-(\mathcal{H}^{L-M}, \psi^M(\mathbf{s})) \rightarrow \mathfrak{A}^-(\mathcal{H}^{L-M-N}, p^{\vec{N}}(\psi^M(\mathbf{s}))),$$

whenever \vec{N} is an oriented sublink of $L - M$ (possibly with a different orientation than L). See [MO10, Section 3.8]. (For the definition of $p^{\vec{N}}$, see [MO10, Section 3.7]). It is straightforward to extend Lemma 5.7 to see there are isomorphisms

$$\bigoplus_{\mathbf{s} \in \mathbb{H}(L)} A^-(\mathcal{H}^{L-M}, p^{\vec{N}}(\psi^M(\mathbf{s}))) \cong S_{M \cup \vec{N}}^{-1} \cdot \mathcal{CFL}^-(\mathcal{H})$$

where $S_{M \cup \vec{N}}$ denotes the multiplicatively closed subset of $\mathbb{F}[\mathcal{U}_1, \dots, \mathcal{U}_\ell, \mathcal{V}_1, \dots, \mathcal{V}_\ell]$ generated by \mathcal{U}_i for $L_i \subseteq \vec{N}$ which is oriented oppositely to L , and \mathcal{V}_i for $L_i \subseteq M + \vec{N}$ which are oriented coherently with L . Furthermore, the Manolescu–Ozsváth inclusion maps $\mathcal{I}^{\vec{N}}$ are intertwined with the canonical maps from localization.

We now discuss some algebraic properties of the structure maps in the link surgery hypercube. Manolescu and Ozsváth prove that the hypercube maps in their surgery formula $\mathbb{X}_\Lambda(L)$ are $\mathbb{F}[U_1, \dots, U_\ell]$ -equivariant. By the previous lemma, there is a more refined action of $\mathbb{F}[\mathcal{U}_1, \dots, \mathcal{U}_\ell, \mathcal{V}_1, \dots, \mathcal{V}_\ell]$ on the complex $\mathbb{X}_\Lambda(L)$, though the differential does not commute with this action. We now describe how the hypercube maps interact with the action of this larger ring.

Firstly, we define a ring homomorphism

$$T: \mathbb{F}[\mathcal{U}, \mathcal{V}] \rightarrow \mathbb{F}[\mathcal{U}, \mathcal{V}, \mathcal{V}^{-1}]$$

via the formula

$$T(\mathcal{U}) = \mathcal{V}^{-1} \quad \text{and} \quad T(\mathcal{V}) = \mathcal{U}\mathcal{V}^2.$$

We write $I: \mathbb{F}[\mathcal{U}, \mathcal{V}] \rightarrow \mathbb{F}[\mathcal{U}, \mathcal{V}, \mathcal{V}^{-1}]$ for the canonical inclusion.

We view $S_M^{-1} \cdot \mathbb{F}[\mathcal{U}_1, \dots, \mathcal{U}_\ell, \mathcal{V}_1, \dots, \mathcal{V}_\ell]$ as the tensor product over \mathbb{F} of ℓ different rings, which are each isomorphic to $\mathbb{F}[\mathcal{U}, \mathcal{V}]$ or $\mathbb{F}[\mathcal{U}, \mathcal{V}, \mathcal{V}^{-1}]$.

If $N \subseteq L - M$, then we define the ring homomorphism

$$T^{\vec{N}}: S_M^{-1} \cdot \mathbb{F}[\mathcal{U}_1, \dots, \mathcal{U}_\ell, \mathcal{V}_1, \dots, \mathcal{V}_\ell] \rightarrow S_{M \cup N}^{-1} \cdot \mathbb{F}[\mathcal{U}_1, \dots, \mathcal{U}_\ell, \mathcal{V}_1, \dots, \mathcal{V}_\ell]$$

by tensoring the map T for each component $L_i \subseteq \vec{N}$ which is oriented oppositely to L , tensoring I for each component $L_i \subseteq \vec{N}$ which is oriented consistently with L , and tensoring the identity map for the remaining components of L .

Lemma 5.9. *Suppose that $N \subseteq M \subseteq L$, and let \vec{N} denote N with a choice of orientation. If $a \in S_M^{-1} \cdot \mathbb{F}[\mathcal{U}_1, \dots, \mathcal{U}_\ell, \mathcal{V}_1, \dots, \mathcal{V}_\ell]$, and $\mathbf{x} \in S_M^{-1} \cdot \mathcal{CFL}^-(\mathcal{H})$, then*

$$\Phi^{\vec{N}}(a \cdot \mathbf{x}) = T^{\vec{N}}(a) \cdot \Phi^{\vec{N}}(\mathbf{x}).$$

Proof. We focus on the length 1 maps in the surgery hypercube. The maps of higher length are analyzed using the same argument. In this case, write $N = L_i$, where L_i is a component of L . To simplify the notation further, we focus on the case that $M = \emptyset$. Let L_i , (resp. $-L_i$), denote L_i equipped with the orientation which coincides with (resp. is opposite to) the orientation from L . The map $\Phi_{L, L-L_i}^{L_i}$ is the canonical inclusion map

$$\mathcal{CFL}^-(\mathcal{H}) \hookrightarrow \mathcal{V}_i^{-1} \cdot \mathcal{CFL}^-(\mathcal{H}),$$

which is clearly $\mathbb{F}[\mathcal{U}_1, \dots, \mathcal{U}_\ell, \mathcal{V}_1, \dots, \mathcal{V}_\ell]$ -equivariant. Note that T^{L_i} is just the canonical inclusion of $\mathbb{F}[\mathcal{U}_1, \dots, \mathcal{U}_\ell, \mathcal{V}_1, \dots, \mathcal{V}_\ell]$ into $\mathcal{V}_i^{-1} \cdot \mathbb{F}[\mathcal{U}_1, \dots, \mathcal{U}_\ell, \mathcal{V}_1, \dots, \mathcal{V}_\ell]$.

The map $\Phi_{L, L-L_i}^{-L_i}$ is more complicated, as we now describe. Similarly to Lemma 5.7, there are canonical isomorphisms

$$\begin{aligned} \phi_i: \mathcal{U}_i^{-1} \cdot \mathcal{CFL}^-(\mathcal{H}) &\rightarrow \mathcal{CFL}^-(\mathcal{H})/(\mathcal{U}_i - 1) \otimes \mathbb{F}[\mathbb{H}_i(L)], \quad \text{and} \\ \psi_i: \mathcal{V}_i^{-1} \cdot \mathcal{CFL}^-(\mathcal{H}) &\rightarrow \mathcal{CFL}^-(\mathcal{H})/(\mathcal{V}_i - 1) \otimes \mathbb{F}[\mathbb{H}_i(L)]. \end{aligned}$$

Here $\mathbb{F}[\mathbb{H}_i(L)]$ denotes the $\mathbb{F}[t, t^{-1}]$ -module generated by t^α where $\alpha \in \mathbb{H}_i(L)$. Here, t is a formal variable.

The map ϕ_i is given as follows. Write

$$\mathcal{Q}_{\mathcal{U}_i}: \mathcal{U}_i^{-1} \mathcal{CFL}^-(\mathcal{H}) \rightarrow \mathcal{CFL}^-(\mathcal{H})/(\mathcal{U}_i - 1)$$

for the quotient map. Then ϕ_i is given by the formula

$$\phi_i(x) = \mathcal{Q}_{\mathcal{U}_i}(x) \otimes t^{A_i^t(x)}.$$

The map ψ_i is defined similarly.

Finally, write \mathcal{I}_i for the inclusion of $\mathcal{CFL}^-(\mathcal{H})$ into $\mathcal{U}_i^{-1} \cdot \mathcal{CFL}^-(\mathcal{H})$.

Moving the basepoint z_i to w_i along a subarc of L_i determines a homotopy equivalence

$$\Psi_{z_i \rightarrow w_i}: \mathcal{CFL}^-(\mathcal{H})/(\mathcal{U}_i - 1) \rightarrow \mathcal{CFL}^-(\mathcal{H})/(\mathcal{V}_i - 1)$$

which preserves $A_j^{L-L_i}$ for $j \neq i$. The map $\Psi_{z_i \rightarrow w_i}$ sends \mathcal{V}_i to \mathcal{U}_i , and is equivariant with respect to the other variables.

The map $\Phi_{L, L-L_i}^{-L_i}$ is defined as the composition

$$\Phi_{L, L-L_i}^{-L_i} := \psi_i^{-1} \circ (\Psi_{z_i \rightarrow w_i} \otimes t^{\lambda_i}) \circ \phi_i \circ \mathcal{I}_i.$$

We consider the interaction with \mathcal{U}_i and \mathcal{V}_i . The map \mathcal{I}_i commutes with \mathcal{U}_i and \mathcal{V}_i . The map ϕ_i has the property that

$$\phi_i(\mathcal{U}_i^n \cdot x) = t^{-n} \cdot \phi_i(x) \quad \text{and} \quad \phi_i(\mathcal{V}_i^n \cdot x) = \mathcal{V}_i^n t^n \cdot \phi_i(x).$$

Also

$$(\Psi_{z_i \rightarrow w_i} \otimes \text{id})(\mathcal{V}_i^n t^m \cdot x) = \mathcal{U}_i^n t^m \cdot (\Psi_{z_i \rightarrow w_i} \otimes \text{id})(x).$$

Similarly

$$\psi_i(\mathcal{U}_i^n \cdot x) = \mathcal{U}_i^n t^{-n} \cdot \psi_i(x) \quad \text{and} \quad \psi_i(\mathcal{V}_i^n \cdot x) = t^n \cdot \psi_i(x),$$

which implies that

$$\psi_i^{-1}(t^n \cdot x) = \mathcal{V}_i^n \cdot \psi_i^{-1}(x) \quad \text{and} \quad \psi_i^{-1}(\mathcal{U}_i^n \cdot x) = \mathcal{U}_i^n \mathcal{V}_i^n \cdot \psi_i^{-1}(x).$$

From these relations, it follows that

$$\Phi_{L, L-L_i}^{-L_i}(\mathcal{U}_i \cdot \mathbf{x}) = \mathcal{V}_i^{-1} \cdot \Phi_{L, L-L_i}^{-L_i}(\mathbf{x}) \quad \text{and} \quad \Phi_{L, L-L_i}^{-L_i}(\mathcal{V}_i \cdot \mathbf{x}) = \mathcal{U}_i \mathcal{V}_i^2 \cdot \Phi_{L, L-L_i}^{-L_i}(\mathbf{x}),$$

completing the proof. \square

Example 5.10. We now describe the surgery complex for the unknot O in our present notation, and compare it to the traditional notation of [OS08b]. The complex $\mathcal{CFK}^-(O)$ has one generator, 1, over $\mathbb{F}[\mathcal{U}, \mathcal{V}]$. In our notation, v sends $\mathcal{U}^i \mathcal{V}^j \in \mathcal{CFK}^-(O)$ to $\mathcal{U}^i \mathcal{V}^j \in \mathcal{V}^{-1} \mathcal{CFK}^-(O)$. Similarly h_λ sends $\mathcal{U}^i \mathcal{V}^j$ to $\mathcal{V}^\lambda T(\mathcal{U}^i \mathcal{V}^j) = \mathcal{U}^j \mathcal{V}^{2j-i+\lambda}$.

Traditionally, one works with the mapping cone formula over $\mathbb{F}[U]$. We identify both $A(O, s) \subseteq \mathcal{CFK}^-(O)$ and $B(O, s) \subseteq \mathcal{V}^{-1} \mathcal{CFK}^-(O)$ with $\mathbb{F}[U]$ (where U acts by $\mathcal{U}\mathcal{V}$). We identify $\mathcal{U}^i \mathcal{V}^j \in \mathcal{CFK}^-(O)$ with $U^{\min(i,j)} \in A(O, s)$, and we identify $\mathcal{U}^i \mathcal{V}^j \in \mathcal{V}^{-1} \mathcal{CFK}^-(O)$ with $U^i \in B(O, s)$. We can view the previous identification as giving two isomorphisms

$$\mathcal{CFK}^-(O) \cong \bigoplus_{s \in \mathbb{Z}} \mathbb{F}[U] \quad \text{and} \quad \mathcal{V}^{-1} \mathcal{CFK}^-(O) \cong \bigoplus_{s \in \mathbb{Z}} \mathbb{F}[U].$$

In the original notation of Ozsváth and Szabó

$$v(U^i) = \begin{cases} U^{i-s} & \text{if } s \leq 0, \\ U^i & \text{if } s \geq 0 \end{cases} \quad h_\lambda(U^i) = \begin{cases} U^i & \text{if } s \leq 0, \\ U^{i+s} & \text{if } s \geq 0. \end{cases}$$

The map h_λ sends $A(O, s)$ to $B(O, s + \lambda)$. It is straightforward to see that the above maps form a commutative diagram

$$\begin{array}{ccc} \mathcal{CFK}^-(O) & \xrightarrow{f} & \mathcal{V}^{-1} \mathcal{CFK}^-(O) \\ \downarrow \cong & & \downarrow \cong \\ \bigoplus_{s \in \mathbb{Z}} A(O, s) & \xrightarrow{f} & \bigoplus_{s \in \mathbb{Z}} B(O, s) \end{array}$$

whenever f is one of v or h_λ .

6. THE KNOT SURGERY ALGEBRA

In this section, we introduce our algebra \mathcal{K} , and reinterpret the Ozsváth–Szabó knot surgery complex and the Manolescu–Ozsváth link surgery complex in terms of \mathcal{K} . We also describe additional properties of \mathcal{K} .

6.1. The algebra \mathcal{K} . We recall the *knot surgery algebra* \mathcal{K} from the introduction. We define \mathcal{K} to be an algebra over the idempotent ring

$$\mathbf{I} = \mathbf{I}_0 \oplus \mathbf{I}_1,$$

where each of \mathbf{I}_i is rank 1 over \mathbb{F}_2 . We set

$$\mathbf{I}_0 \cdot \mathcal{K} \cdot \mathbf{I}_0 = \mathbb{F}[\mathcal{U}, \mathcal{V}] \quad \text{and} \quad \mathbf{I}_1 \cdot \mathcal{K} \cdot \mathbf{I}_1 \cong \mathbb{F}[\mathcal{U}, \mathcal{V}, \mathcal{V}^{-1}].$$

There are two special algebra elements, $\sigma, \tau \in \mathbf{I}_1 \cdot \mathcal{K} \cdot \mathbf{I}_0$. These algebra elements satisfy the relation

$$\sigma \cdot f = I(f) \cdot \sigma \quad \text{and} \quad \tau \cdot f = T(f) \cdot \tau,$$

for $f \in \mathbb{F}[\mathcal{U}, \mathcal{V}] = \mathbf{I}_0 \cdot \mathcal{K} \cdot \mathbf{I}_0$. Here $T: \mathbb{F}[\mathcal{U}, \mathcal{V}] \rightarrow \mathbb{F}[\mathcal{U}, \mathcal{V}, \mathcal{V}^{-1}]$ is the algebra homomorphism satisfying $T(\mathcal{U}) = \mathcal{V}^{-1}$ and $T(\mathcal{V}) = \mathcal{U}\mathcal{V}^2$, and $I: \mathbb{F}[\mathcal{U}, \mathcal{V}] \rightarrow \mathbb{F}[\mathcal{U}, \mathcal{V}, \mathcal{V}^{-1}]$ is the canonical inclusion. Also

$$\mathbf{I}_0 \cdot \mathcal{K} \cdot \mathbf{I}_1 = 0.$$

More formally, we may define \mathcal{K} as a quotient of another algebra $\tilde{\mathcal{K}}$, as follows. Firstly, we set

$$\mathbf{I}_i \cdot \tilde{\mathcal{K}} \cdot \mathbf{I}_i = \mathbf{I}_i \cdot \mathcal{K} \cdot \mathbf{I}_i,$$

for $i \in \{0, 1\}$, and

$$\mathbf{I}_1 \cdot \tilde{\mathcal{K}} \cdot \mathbf{I}_0 = \mathbb{F}[\mathcal{U}, \mathcal{V}, \mathcal{V}^{-1}] \otimes_{\mathbb{F}} \langle \sigma, \tau \rangle \otimes_{\mathbb{F}} \mathbb{F}[\mathcal{U}, \mathcal{V}].$$

We set $\mathbf{I}_0 \cdot \tilde{\mathcal{K}} \cdot \mathbf{I}_1 = 0$.

Multiplication on $\tilde{\mathcal{K}}$ is as follows. The product of $x \in \mathbf{I}_i \cdot \tilde{\mathcal{K}} \cdot \mathbf{I}_i$ and $y \in \mathbf{I}_j \cdot \tilde{\mathcal{K}} \cdot \mathbf{I}_j$ is polynomial multiplication if $i = j$, and is 0 if $i \neq j$. Similarly,

$$(f \otimes \tau \otimes g) \cdot g' = f \otimes \tau \otimes (gg')$$

if $g' \in \mathbf{I}_0 \cdot \tilde{\mathcal{K}} \cdot \mathbf{I}_0$ and similarly for multiplying elements on the left by elements in $\mathbf{I}_1 \cdot \tilde{\mathcal{K}} \cdot \mathbf{I}_1$.

We consider the 2-sided ideal $\mathcal{I} \subseteq \tilde{\mathcal{K}}$ generated by elements of the form

$$1 \otimes \sigma \otimes f + I(f) \otimes \sigma \otimes 1 \quad \text{or} \quad 1 \otimes \tau \otimes f + T(f) \otimes \tau \otimes 1$$

for $f \in \mathbb{F}[\mathcal{U}, \mathcal{V}]$. Then

$$\mathcal{K} \cong \tilde{\mathcal{K}}/\mathcal{I}.$$

6.2. The log-topology on \mathcal{K} . We now describe our filtration on \mathcal{K} . We call the induced topology the *log-topology*. The motivation for the topology is that it shares some useful properties of the U -adic topology (see Lemma 6.3), but still allows for a continuous action on the bordered module for the solid torus (see Lemma 6.4), which the U -adic topology does not.

Our topology on \mathcal{K} is given by a real valued weight function $w_{\mathcal{K}}$ on monomials, as follows. If $\mathcal{U}^i \mathcal{V}^j \in \mathbf{I}_0 \cdot \mathcal{K} \cdot \mathbf{I}_0$, we set

$$w_{\mathcal{K}}(\mathcal{U}^i \mathcal{V}^j) = \min(i, j) - \log(1 + |i - j|).$$

To an element $\mathcal{U}^i \mathcal{V}^j \in \mathbf{I}_1 \cdot \mathcal{K} \cdot \mathbf{I}_1$, we assign the weight

$$w_{\mathcal{K}}(\mathcal{U}^i \mathcal{V}^j) = i - \log(1 + |i - j|).$$

For elements of the form $\mathcal{U}^i \mathcal{V}^j \sigma$ and $\mathcal{U}^i \mathcal{V}^j \tau$, we also use weight $i - \log(1 + |i - j|)$.

We refer to the induced filtration $\mathcal{K}_n = \text{Span}_{\mathbb{F}}(x : w_{\mathcal{K}}(x) \geq n)$ as the *log-filtration*. Note that the log-filtration is not bounded from below.

Remark 6.1. The U -adic topology on \mathcal{K} is induced by the weight function obtained by removing the log terms from the definition of $w_{\mathcal{K}}$.

Lemma 6.2. *If a_1 and a_2 are monomials in \mathcal{K} , then*

$$w_{\mathcal{K}}(a_1) + w_{\mathcal{K}}(a_2) \leq w_{\mathcal{K}}(a_1 \cdot a_2).$$

In particular, the map $\mu_2: \mathcal{K} \otimes_{\mathbf{I}} \mathcal{K} \rightarrow \mathcal{K}$ is weakly filtered.

Proof. We use the inequality,

$$\log(1 + |\alpha + \beta|) \leq \log(1 + |\alpha|) + \log(1 + |\beta|), \quad (6.1)$$

which is straightforward to verify and holds for any real numbers.

Define a U -adic weight $w_U(a) = \max\{n \geq 0 : a \in U^n \cdot \mathcal{K}\}$, where $U = \mathcal{U}\mathcal{V}$. The algebra \mathcal{K} possesses an Alexander grading A , satisfying $A(\mathcal{U}) = -1$, $A(\mathcal{V}) = 1$, and $A(\sigma) = A(\tau) = 0$. The grading satisfies

$$A(a_1 \cdot a_2) = A(a_1) + A(a_2). \quad (6.2)$$

The weight function $w_{\mathcal{K}}$ has the alternate description

$$w_{\mathcal{K}}(a) = w_U(a) - \log(1 + |A(a)|). \quad (6.3)$$

Clearly, $w_U(a_1) + w_U(a_2) \leq w_U(a_1 \cdot a_2)$. Hence

$$\begin{aligned} w_{\mathcal{K}}(a_1 \cdot a_2) &= w_U(a_1 \cdot a_2) - \log(1 + |A(a_1 \cdot a_2)|) \\ &\geq w_U(a_1) + w_U(a_2) - \log(1 + |A(a_1) + A(a_2)|) \\ &\geq w_U(a_1) + w_U(a_2) - \log(1 + |A(a_1)|) - \log(1 + |A(a_2)|) \\ &= w_{\mathcal{K}}(a_1) + w_{\mathcal{K}}(a_2). \end{aligned}$$

□

Lemma 6.3. *Suppose that $a = 1 + Uf \in \mathbf{I}_i \cdot \mathcal{K} \cdot \mathbf{I}_i$, where $U = \mathcal{U}\mathcal{V}$, i.e. f is a (finite) polynomial in $\mathbb{F}[\mathcal{U}, \mathcal{V}]$ if $i = 0$ or $\mathbb{F}[\mathcal{U}, \mathcal{V}, \mathcal{V}^{-1}]$ if $i = 1$. Then a is a unit in the completion of \mathcal{K} with respect to the log-filtration.*

Proof. The inverse of a is the infinite series $a^{-1} = \sum_{i=0}^{\infty} (Uf)^i$. It suffices to show that this infinite series converges in the log-topology. The polynomial f is a sum of monomials $\mathcal{U}^i \mathcal{V}^j$ where $j - i \in [-b, b]$, for some b . In particular, $(Uf)^i = U^i f^i$ will be supported in Alexander gradings $[-bi, bi]$. Hence

$$w_{\mathcal{K}}(U^i f^i) \geq w_{\mathcal{K}}(U^i) + w_{\mathcal{K}}(f^i) \geq i - \log(1 + bi)$$

which increases without bound as $i \rightarrow \infty$. Hence the sum defining a^{-1} converges, and the proof is complete. □

6.3. The framing module. Suppose that λ is an integer. We now define a type- A module

$$\kappa\mathcal{F}_\lambda,$$

which we call the *framing module*. Conceptually, the module \mathcal{F}_λ is the type- A module for a solid torus. The vector space \mathcal{F}_λ is a module over the idempotent ring $\mathbf{I}_0 \oplus \mathbf{I}_1$. We set

$$\mathbf{I}_0 \cdot \mathcal{F}_\lambda = \mathbb{F}[\mathcal{U}, \mathcal{V}] \quad \text{and} \quad \mathbf{I}_1 \cdot \mathcal{F}_\lambda = \mathbb{F}[\mathcal{U}, \mathcal{V}, \mathcal{V}^{-1}].$$

We set $m_j = 0$ unless $j = 2$. We define m_2 on \mathcal{F}_λ as follows. If $f \in \mathbf{I}_i \cdot \mathcal{K} \cdot \mathbf{I}_i$ and $x \in \mathbf{I}_j \cdot \mathcal{F}_j$, then $m_2(f, x)$ is $f \cdot x$ (ordinary multiplication of polynomials) if $i = j$ and is 0 otherwise. The m_2 action of σ is given by

$$m_2(\sigma, x) = I(x)$$

for $x \in \mathbf{I}_0 \cdot \mathcal{F}_\lambda$. Similarly, if $x \in \mathbb{F}[\mathcal{U}, \mathcal{V}]$, then

$$m_2(\tau, x) = \mathcal{V}^\lambda \cdot T(x) \in \mathbb{F}[\mathcal{U}, \mathcal{V}, \mathcal{V}^{-1}]$$

where \cdot denotes ordinary multiplication of polynomials.

There is also a completed version, which we denote by $\kappa\mathcal{F}_\lambda$. As a vector space,

$$\mathbf{I}_0 \cdot \mathcal{F}_\lambda = \mathbb{F}[[\mathcal{U}, \mathcal{V}]], \quad \text{and} \quad \mathbf{I}_1 \cdot \mathcal{F}_\lambda = \mathbb{F}[[\mathcal{U}, \mathcal{V}, \mathcal{V}^{-1}]].$$

(Note that the latter object is defined only as a vector space, and not as a ring, since we are taking two-sided completions with respect to \mathcal{V}).

We give \mathcal{F}_λ the weight function $w_{\mathcal{F}}(\mathbf{I}_0 \cdot \mathcal{U}^i \mathcal{V}^j) = \min(i, j) + \log(1 + |i - j|)$ and $w_{\mathcal{F}}(\mathbf{I}_1 \cdot \mathcal{U}^i \mathcal{V}^j) = i + \log(1 + |i - j|)$. We refer to the induced filtration as the *log-filtration*. (Note that $w_{\mathcal{F}}$ is similar to $w_{\mathcal{K}}$ with the exception of the sign of the log term). Note that \mathcal{F}_λ is the completion of \mathcal{F}_λ with respect to the induced filtration.

Lemma 6.4. *Equip \mathcal{K} and \mathcal{F}_λ with the log-filtrations above. Then the map*

$$\mathcal{K} \otimes_{\mathbf{I}} \mathcal{F}_\lambda \rightarrow \mathcal{F}_\lambda$$

is weakly filtered.

Proof. We will show that

$$w_{\mathcal{K}}(a) + w_{\mathcal{F}}(x) \leq w_{\mathcal{F}}(a \cdot x) + \log(1 + |\lambda|),$$

which implies the statement. Similarly to \mathcal{K} , we may define a U -adic weight on the generators of \mathcal{F} , via the formula $w_U(x) = \max\{n \geq 0 : x \in U^n \cdot \mathcal{F}\}$. There is also an Alexander grading on \mathcal{F} , obtained by setting $A(\mathcal{U}^i \mathcal{V}^j) = j - i$, in both idempotents. Parallel to Equation (6.3), we may write

$$w_{\mathcal{F}}(x) = w_U(x) + \log(1 + |A(x)|).$$

If $a \in \mathcal{K}$ and $x \in \mathcal{F}$, we clearly have

$$w_U(a \cdot x) \geq w_U(a) + w_U(x).$$

In contrast to Equation (6.2), if $x \in \mathcal{F}$ and $a \in \mathcal{K}$, we have instead

$$|A(a \cdot x) - A(a) - A(x)| \leq |\lambda|.$$

(The left-hand side is non-zero when a is a multiple of τ). Parallel to Equation (6.1), there is also a reverse triangle inequality

$$\log(1 + |\alpha|) - \log(1 + |\beta|) \leq \log(1 + |\alpha + \beta|).$$

We may combine these observations via the following manipulation:

$$\begin{aligned}
& w_{\mathcal{F}}(a \cdot x) \\
&= w_U(a \cdot x) + \log(1 + |A(a \cdot x)|) \\
&\geq w_U(a) + w_U(x) + \log(1 + |A(x)|) - \log(1 + |A(a)|) \\
&\quad - \log(1 + |A(a \cdot x) - A(a) - A(x)|) \\
&= w_{\mathcal{K}}(a) + w_{\mathcal{F}}(x) - \log(1 + |A(a \cdot x) - A(a) - A(x)|) \\
&\geq w_{\mathcal{K}}(a) + w_{\mathcal{F}}(x) - \log(1 + |\lambda|).
\end{aligned}$$

The proof is complete. \square

The framing modules extend to type- AA bimodules:

$$\kappa[\mathcal{F}_\lambda]_{\mathbb{F}[U]} \quad \text{and} \quad \kappa[\mathcal{F}_\lambda]_{\mathbb{F}[[U]]}.$$

Here, we have U act on the right via polynomial multiplication with $\mathcal{U}\mathcal{V}$ (summed over both idempotents). Since $[\mathcal{U}\mathcal{V}, \tau] = 0$ and $[\mathcal{U}\mathcal{V}, \sigma] = 0$, the construction above defines an AA -bimodule structure on \mathcal{F}_λ . Note that only $m_{1,1,0}$ and $m_{0,1,1}$ are non-trivial.

6.4. The merge bimodule. In this section, we define a bimodule ${}_{\otimes^n \mathcal{K}} M_n^{\mathcal{K}}$, which we call the *merge bimodule*. We conjecture that ${}_{\otimes^n \mathcal{K}} M_n^{\mathcal{K}}$ is the DA -bimodule for a trivial S^1 -bundle over a punctured disk, for some choice of framing. The most important case for our paper is $n = 2$.

Whenever R is a commutative ring, there is a morphism of algebras $M_n: \otimes^n R \rightarrow R$, given by $M_n(a_1 | \cdots | a_n) = a_1 \cdots a_n$. Such a homomorphism determines a bimodule ${}_{\otimes^n R} [M_n]^R$. The algebra \mathcal{K} is not commutative, though there is a somewhat analogous bimodule ${}_{\otimes^n \mathcal{K}} [M_n]^{\mathcal{K}}$.

The definition of M_n is as follows. As a vector space, M_n is $\mathbf{I} = \mathbf{I}_0 \oplus \mathbf{I}_1$. There is a left action of $\otimes^n \mathbf{I}$, given by

$$(i_1 \otimes \cdots \otimes i_n) \cdot i = i_1 \cdots i_n \cdot i.$$

The right \mathbf{I} -action is the standard action.

There are two non-trivial structure maps on M_n , namely δ_2^1 and δ_{n+1}^1 . The map δ_2^1 is as follows. If $a_n | \cdots | a_1$ is an elementary tensor in either

$$\otimes^n \mathbf{I}_0 \cdot \otimes^n \mathcal{K} \cdot \otimes^n \mathbf{I}_0 \quad \text{or} \quad \otimes^n \mathbf{I}_1 \cdot \otimes^n \mathcal{K} \cdot \otimes^n \mathbf{I}_1,$$

then we set

$$\delta_2^1(a_n | \cdots | a_1 \otimes i) = i \otimes a_n \cdots a_1.$$

On any other elementary tensor, we set δ_2^1 to vanish.

The map δ_{n+1}^1 is as follows. Write

$$\hat{\sigma}_j = (i_0 | \cdots | i_0 | \sigma | i_1 | \cdots | i_1) \quad \text{and} \quad \hat{\tau}_j = (i_0 | \cdots | i_0 | \tau | i_1 | \cdots | i_1),$$

where σ and τ are in the j -th factors (indexed right to left).

We set

$$\delta_{n+1}^1(\hat{\sigma}_n, \dots, \hat{\sigma}_1, i_0) = i_1 \otimes \sigma \quad \text{and} \quad \delta_{n+1}^1(\hat{\tau}_n, \dots, \hat{\tau}_1, i_0) = i_1 \otimes \tau,$$

and define δ_{n+1}^1 to vanish on any other sequence of elementary tensors where each factor is either σ , τ or an idempotent.

More generally, if f_1, \dots, f_n are elements of $\mathcal{K}^{\otimes n}$ which are concentrated in a single idempotent, we define $\delta_{n+1}^1(f_n \hat{\tau}_1, \dots, f_1 \hat{\tau}_1, i_0)$ as follows. Firstly, we set

$$\delta_{n+1}^1(f_n \hat{\tau}_n, \hat{\tau}_{n-1}, \dots, \hat{\tau}_1, i_0) = (\delta_2^1 \otimes \mu_2)(f_n, \delta_{n+1}^1(\hat{\tau}_n, \dots, \hat{\tau}_1, i_0)).$$

Proceeding by induction, we define

$$\delta_{n+1}^1(f_n \hat{\tau}_n, \dots, f_{j+1} \hat{\tau}_{j+1}, f_j \hat{\tau}_j, \hat{\tau}_{j-1}, \dots, \hat{\tau}_1, i_0) = \delta_{n+1}^1(f_n \hat{\tau}_n, \dots, f_{j+1} f'_j \hat{\tau}_{j+1}, \hat{\tau}_j, \dots, \hat{\tau}_1, i_0).$$

where f'_j is the algebra element such that $\hat{\tau}_{j+1} f_j = f'_j \hat{\tau}_{j+1}$. We define $\delta_{n+1}^1(f_n \hat{\sigma}_n, \dots, f_1 \hat{\sigma}_1, i_0)$ similarly.

Lemma 6.5. $\otimes^n \mathcal{K}[M_n]^{\mathcal{K}}$ satisfies the *DA-bimodule structure relations*.

Proof. The *DA*-bimodule structure relations with 0 or 1 algebra inputs are clear.

Consider the structure relations for 2 algebra inputs. Note that since $\delta_1^1 = 0$ and $\mu_1 = 0$, there is no term in the structure relation for two algebra inputs which involves δ_3^1 . Hence the structure relation involves only two trees. In one tree, we apply μ_2 and then δ_2^1 . In the other tree, we apply δ_2^1 twice. If either of these trees induces a non-zero map, both algebra elements must preserve the idempotent. The structure relations in this case are easy consequences of the fact that each $\mathbf{I}_i \cdot \mathcal{K} \cdot \mathbf{I}_i$ is commutative.

We now consider the *DA*-bimodule structure relations for m algebra inputs, where $m > n$. There are only two cases to consider: $m = n + 1$ and $m = 2n$. The structure relations for $m = 2n$ only involve two compositions of δ_{n+1}^1 , followed by μ_2 applied to the outgoing algebra elements. The output of δ_{n+1}^1 lies in $\mathbf{I}_1 \cdot \mathcal{K} \cdot \mathbf{I}_0$, and the product of two such algebra elements is trivial, so the structure relations are satisfied for $m = 2n$.

It remains to consider the case where there are $m = n + 1$ algebra inputs in the relation. If $a_{n+1} \otimes \dots \otimes a_1 \otimes i_0$ is an elementary tensor with $n > 2$, such that there is a summand in the *DA*-bimodule structure relation which is non-vanishing on this term, then exactly one of the a_j must preserve idempotents. In this case, there are exactly two configurations appearing in the *DA*-bimodule structure relation which are non-zero on $a_{n+1} \otimes \dots \otimes a_1 \otimes i_0$. If $j = n + 1$, then the two configurations in the structure relation which are non-vanishing correspond to the terms $\delta_{n+1}^1(\mu_2(a_{n+1}, a_n), a_{n-1}, \dots, a_1, i_0)$ and $(\delta_2^1 \otimes \mu_2)(a_{n+1}, \delta_2^1(a_n, \dots, a_1, i_0))$. These two terms are equal because of our inductive definition of δ_{n+1}^1 . If $j = 1$, the argument is similar. For concreteness, consider the case that $a_i = \hat{\tau}_{i-1}$ for $i \in \{2, \dots, n + 1\}$. Write $a_1 = b_n | \dots | b_1$, and assume that $a_1 \in \otimes^n \mathbf{I}_0 \cdot \otimes^n \mathcal{K} \cdot \otimes^n \mathbf{I}_0$. Note that the effect of the inductive definition is that

$$\delta_{n+1}^1(\hat{\tau}_n, \dots, \hat{\tau}_1 \cdot a_1, i_0) = i_1 \otimes T(b_n) \cdots T(b_1) \tau.$$

On the other hand,

$$(\text{id} \otimes \mu_2)(\delta_{n+1}^1 \otimes \text{id})(\hat{\tau}_n, \dots, \hat{\tau}_1, \delta_2^1(a_1, i_0)) = i_1 \otimes \tau b_n \cdots b_1.$$

These two expressions are equal, so the structure relation holds in this case.

The remaining cases are that $1 < j < n + 1$. In these cases, the bimodule structure relations involve only two configurations, which correspond to $\mu_2(a_{j+1}, a_j)$ or $\mu_2(a_j, a_{j-1})$, followed by a δ_{n+1}^1 . In both cases, the structure relations are a consequence of our inductive definition of δ_{n+1}^1 on M_n . \square

There is an alternate model of the merge bimodule, for which we write $\mathcal{K} \otimes_{\mathcal{K}} N_2^{\mathcal{K}}$. The only difference is the map δ_3^1 . We illustrate the two natural choices of δ_3^1 on the merge

module:

$$\delta_3^1(i_1|\sigma, \sigma|i_0, i_0) = i_1 \otimes \sigma \quad \text{or} \quad \delta_3^1(\sigma|i_1, i_0|\sigma, i_0) = i_1 \otimes \sigma.$$

A similar choice may be made for the case when τ replaces σ . Our definition above of the M_2 used the right action, above. We define N_2 to use the left action instead.

These two choices give homotopic bimodules:

Lemma 6.6. *There is a homotopy equivalence of DA-bimodules*

$$\otimes^2 \mathcal{K} M_2^{\mathcal{K}} \simeq \otimes^2 \mathcal{K} N_2^{\mathcal{K}}.$$

Proof. We construct a map f_{j+1}^1 between the two bimodules. We set $f_1^1(\mathbf{x}) = \mathbf{x} \otimes 1$. The only other non-vanishing term is f_2^1 . This map is determined by the relation

$$f_2^1(\sigma|\sigma, i_0) = i_1 \otimes \sigma.$$

We similarly set $f_2^1(\tau|\tau, i_0) = i_1 \otimes \tau$. The DA-bimodule morphism structure relations for two algebra inputs which both change idempotent are given by the schematic

$$\begin{array}{c} a_2 \quad a_1 \quad \mathbf{x} \\ \searrow \quad \searrow \quad \downarrow \\ \quad \quad \quad f_1^1 \\ \quad \quad \quad \downarrow \\ \quad \quad \quad \delta_3^1 \\ \quad \quad \quad \downarrow \\ \quad \quad \quad \mu_2 \end{array} + \begin{array}{c} a_2 \quad a_1 \quad \mathbf{x} \\ \searrow \quad \searrow \quad \downarrow \\ \quad \quad \quad \delta_3^1 \\ \quad \quad \quad \downarrow \\ \quad \quad \quad f_1^1 \\ \quad \quad \quad \downarrow \\ \quad \quad \quad \mu_2 \end{array} + \begin{array}{c} a_2 \quad a_1 \quad \mathbf{x} \\ \searrow \quad \downarrow \quad \downarrow \\ \quad \quad \quad \mu_2 \\ \quad \quad \quad \downarrow \\ \quad \quad \quad f_2^1 \\ \quad \quad \quad \downarrow \\ \quad \quad \quad \mu_2 \end{array} = 0$$

which is easily verified. The structure relations for $n \neq 2$ algebra inputs are also easily verified. \square

More generally, we may view the merge bimodule M_n as being part of a family of bimodules, indexed by a choice of two permutations on n elements. If $p, q: \{1, \dots, n\} \rightarrow \{1, \dots, n\}$ are permutations, then we can define the $M_{n,p,q}$ as before, but so that the δ_{n+1}^1 term is non-trivially on elements of the form $\hat{\sigma}_{p(n)} \otimes \dots \otimes \hat{\sigma}_{p(1)} \otimes i_0$, (where $\hat{\sigma}_{p(i)}$ now denotes a tensor product of σ in the i -th coordinate, and idempotent generators in the other factors). Similarly the map δ_{n+1}^1 is chosen to be non-vanishing on an analogous tensor of $\hat{\tau}_{q(i)}$ terms. The argument in the case of $n = 2$, described in Lemma 6.6, generalizes easily to show that all of the bimodules $M_{n,p,q}$ are homotopy equivalent. Indeed, if p and p' differ by an elementary transposition, then one may define a homotopy equivalence of DA-bimodules f_*^1 from $M_{n,p,q}$ to $M_{n,p',q}$. The map f_*^1 has $f_1^1(i) = i \otimes 1$ for $i \in \mathbb{I}$. The only other non-vanishing term is f_n^1 , which satisfies

$$f_n^1(\hat{\sigma}_{i_n}, \hat{\sigma}_{i_{n-1}}, \dots, \hat{\sigma}_{i_{j+1}} \hat{\sigma}_{i_j}, \dots, \hat{\sigma}_1, i_0) = i_1 \otimes \sigma.$$

Next, we observe that the merge bimodule satisfies the following composition rule:

Lemma 6.7. *Write $\mathcal{K}^{\otimes n} M_n^{\mathcal{K}}$ and $\otimes^m \mathcal{K} M_m^{\mathcal{K}}$ for the merge bimodules. Then*

$$\mathcal{K}^{\otimes n} M_n^{\mathcal{K}} \boxtimes \otimes^m \mathcal{K} M_m^{\mathcal{K}} \cong \mathcal{K}^{\otimes m+n-1} M_{m+n-1}^{\mathcal{K}}.$$

In the above, we are implicitly using extension of scalars to extend $\mathcal{K}^{\otimes n} M_n^{\mathcal{K}}$ over the algebra $\mathcal{K}^{\otimes m-1}$. The statement holds regardless of which input of M_m we tensor over, if we interpret it as follows. Suppose that the \mathcal{K} output of M_n is input into the j -th tensor factor of M_m . Then we identify the algebra factors in indices $j, \dots, j+n-1$ with those from $\mathcal{K}^{\otimes n}$.

Proof. Both sides have no δ_j^1 unless $j = 2$ or $j = n + m$. The δ_1^1 and δ_2^1 terms of the tensor product are easy to analyze and see directly that they coincide. The remaining term to consider is δ_{n+m}^1 . There is just one structure diagram which makes non-trivial contribution. This is shown below in the case that $n = 2$ and $m = 3$, and M_n is merged into spot $j = 2$:

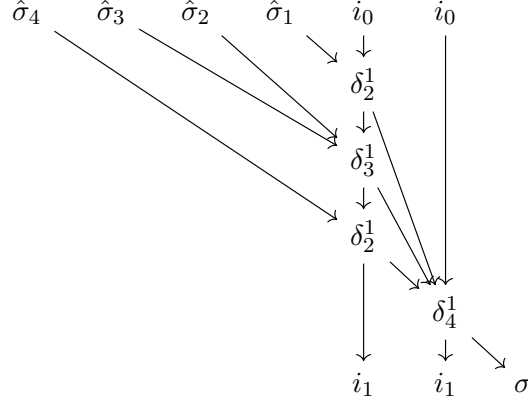

There is a similar diagram for the $\hat{\sigma}$ terms. The above tree clearly recovers δ_{n+m}^1 on $\otimes^{m+n-1} \mathcal{K} M_{m+n-1}^{\mathcal{K}}$. \square

6.5. The knot surgery formula over \mathcal{K} . We now describe how to view the mapping cone formula of Ozsváth and Szabó in terms of the algebra \mathcal{K} .

Recall that Ozsváth and Szabó's mapping cone formula [OS08b, Theorem 1.1] states that if λ is an integral framing on $K \subseteq S^3$, then

$$\mathcal{CF}^-(S_\lambda^3(K)) \cong \mathbb{X}_\lambda(K) = \text{Cone}(\mathbb{A}(K) \xrightarrow{v+h_\lambda} \mathbb{B}(K)).$$

Recall, as in Lemma 5.7, that $\mathbb{A}(K)$ may be identified with a completion of $\mathcal{CFK}(K)$ and $\mathbb{B}(K)$ may be identified with a completion of $\mathcal{V}^{-1}\mathcal{CFK}(K)$.

We will describe the following algebraic perspectives of the mapping cone formula:

- (1) A chain complex $\mathbb{X}_\lambda(K)$ over $\mathbb{F}[[U]]$.
- (2) A right type- D module $\mathcal{X}_\lambda(K)^{\mathcal{K}}$.
- (3) A left type- A module ${}_{\mathcal{K}}\mathcal{X}_\lambda(K)$.
- (4) A type- DA bimodule ${}_{\mathcal{K}}\mathcal{X}_\lambda(K)^{\mathcal{K}}$.

These will satisfy the following relations:

$$\mathbb{X}_{\lambda_1+\lambda_2}(K) \cong \mathcal{X}_{\lambda_1}(K)^{\mathcal{K}} \hat{\boxtimes} {}_{\mathcal{K}}[\mathcal{F}_{\lambda_2}] \quad \text{and} \quad {}_{\mathcal{K}}\mathcal{X}_{\lambda_1+\lambda_2}(K) \cong {}_{\mathcal{K}}\mathcal{X}_{\lambda_1}(K)^{\mathcal{K}} \hat{\boxtimes} {}_{\mathcal{K}}[\mathcal{F}_{\lambda_2}]$$

A further relation is described in Remark 6.9.

We begin with the description as a type- D module. Let $\mathbf{x}_1, \dots, \mathbf{x}_n$ be a free basis of $\mathcal{CFK}(K)$ over $\mathbb{F}[\mathcal{U}, \mathcal{V}]$. We declare the underlying \mathbf{I} -module of $\mathcal{X}_\lambda(K)^{\mathcal{K}}$ to be

$$\mathcal{X}_\lambda(K)^{\mathcal{K}} = \text{Span}_{\mathbb{F}}(\mathbf{x}_1, \dots, \mathbf{x}_n) \otimes_{\mathbb{F}} \mathbf{I}.$$

In particular, over \mathbb{F} each \mathbf{x}_i contributes one generator in each idempotent. We denote these generators by \mathbf{x}_i^0 and \mathbf{x}_i^1 .

The map δ^1 on $\mathcal{X}_\lambda(K)^{\mathcal{K}}$ is as follows. Firstly, there are internal δ^1 summands from the differential of $\mathcal{CFK}^-(K)$. If $\partial(\mathbf{x})$ contains a summand of $\mathbf{y} \cdot \mathcal{U}^n \mathcal{V}^m$, then $\delta^1(\mathbf{x}^i)$ contains a summand of $\mathbf{y}^i \otimes \mathcal{U}^n \mathcal{V}^m$, for $i \in \{0, 1\}$.

In Ozsváth and Szabó's mapping cone formula, v is the canonical inclusion of $\mathcal{CFK}^-(K)$ into $\mathcal{V}^{-1}\mathcal{CFK}^-(K)$. Correspondingly, $\delta^1(\mathbf{x}^0)$ contains a summand of the form $\mathbf{x}^1 \otimes \sigma$.

If $\mathbf{y} \cdot \mathcal{U}^i \mathcal{V}^j$ is a summand of $h_\lambda(\mathbf{x})$ then we define $\delta^1(\mathbf{x}^0)$ to have a summand of the form

$$\mathbf{y}^1 \otimes \mathcal{U}^i \mathcal{V}^j \tau.$$

Lemma 6.8. $\mathcal{X}_\lambda(K)^\mathcal{K}$ is a type- D module.

Proof. The proof is a formal consequence of the fact that $\partial^2 = 0$ on $\mathcal{CFK}^-(K)$, that v and h_λ are chain maps, and that v and h_λ satisfy the equivariance properties of Lemma 5.9.

In more detail, suppose that $\mathbf{x}_1, \dots, \mathbf{x}_n$ is a free basis of $\mathcal{CFK}^-(K)$, and consider

$$((\text{id}_\mathcal{X} \otimes \mu_2) \circ (\delta^1 \otimes \text{id}_\mathcal{K}) \circ \delta^1)(\mathbf{x}_i^\varepsilon) \quad (6.4)$$

For concreteness, consider the case when $\varepsilon = 0$. There are three sources of terms in the above expression: those arising from two applications of ∂ , those arising from one v and one ∂ , and those arising from one h_λ and one ∂ . Consider the terms with two ∂ terms. Write $\partial(\mathbf{x}_i) = \sum_{j=1}^n \mathbf{x}_j \cdot f_{j,i}$. The terms with two ∂ terms are simply

$$\sum_{k=1}^n \mathbf{x}_k^0 \otimes \left(\sum_{j=1}^n f_{k,j} f_{j,i} \right),$$

which is 0 since $\partial^2 = 0$. Similarly, the terms corresponding to one ∂ and one v are given by the formula

$$\sum_{j=1}^n \mathbf{x}_j^1 \otimes (\sigma f_{j,i} + f_{j,i} \sigma)$$

which clearly vanishes.

Finally, we consider the terms corresponding to one ∂ and one h_λ . Write $h_\lambda(\mathbf{x}_i) = \sum_{j=1}^n \mathbf{x}_j \cdot g_{j,i}$, where $g_{j,i} \in \mathbb{F}[\mathcal{U}, \mathcal{V}, \mathcal{V}^{-1}]$. The corresponding terms of Equation (6.4) are

$$\sum_{k=1}^n \mathbf{x}_k^1 \otimes \left(\sum_{j=1}^n g_{k,j} \tau f_{j,i} + f_{k,j} g_{j,i} \tau \right) = \sum_{k=1}^n \mathbf{x}_k^1 \otimes \left(\sum_{j=1}^n g_{k,j} T(f_{j,i}) + f_{k,j} g_{j,i} \right) \tau \quad (6.5)$$

However $\sum_{j=1}^n g_{k,j} T(f_{j,i}) + f_{k,j} g_{j,i}$ is the \mathbf{x}_k coefficient of $[\partial, h_\lambda](\mathbf{x}_i)$, since h_λ satisfies $h_\lambda(\mathbf{x} \cdot a) = h_\lambda(\mathbf{x}) \cdot T(a)$, by Lemma 5.9. In particular, Equation (6.5) vanishes. The case when $\varepsilon = 1$ is similar. \square

Having defined the type- D module $\mathcal{X}_\lambda(K)^\mathcal{K}$, we may now define type- A and type- DA modules

$$\mathcal{K} \mathcal{X}_\lambda(K) \quad \text{and} \quad \mathcal{K} \mathcal{X}_\lambda(K)^\mathcal{K}.$$

The simplest construction is to use the merge module $\mathcal{K} \otimes \mathcal{K} M_2^\mathcal{K}$, and define

$$\mathcal{K} \mathcal{X}_\lambda(K)^\mathcal{K} := \mathcal{X}_\lambda(K)^\mathcal{K} \hat{\boxtimes} \mathcal{K} \otimes \mathcal{K} M_2^\mathcal{K}.$$

It does not affect the definition which summand of $\mathcal{K} \otimes \mathcal{K}$ we tensor $\mathcal{X}_\lambda(K)^\mathcal{K}$ with. We define the type- A module

$$\mathcal{K} \mathcal{X}_\lambda(K) := \mathcal{X}_\lambda(K)^\mathcal{K} \hat{\boxtimes} \mathcal{K} \otimes \mathcal{K} M_2^\mathcal{K} \hat{\boxtimes} \mathcal{K}[\mathcal{F}_0].$$

We describe explicitly the DA -bimodule ${}_{\mathcal{K}}\mathcal{X}_\lambda(K)^{\mathcal{K}}$. We now have left and right actions of the idempotent ring $\mathbf{I} = \mathbf{I}_0 \oplus \mathbf{I}_1$. The bimodule ${}_{\mathcal{K}}\mathcal{X}_\lambda(K)^{\mathcal{K}}$ has the same generators over \mathbf{I} as $\mathcal{X}_\lambda(K)^{\mathcal{K}}$, namely

$$\text{Span}_{\mathbb{F}}(\mathbf{x}_1, \dots, \mathbf{x}_n) \otimes_{\mathbb{F}} \mathbf{I}.$$

The module \mathbf{I} acts on the generators of ${}_{\mathcal{K}}\mathcal{X}_\lambda(K)^{\mathcal{K}}$ via the right-most \mathbf{I} -factor.

The δ_1^1 action is the internal differential from $\mathcal{CFK}^-(K)$. The δ_2^1 action is as follows. If $i, j \in \{0, 1\}$ and

$$f \in \mathbf{I}_i \cdot \mathcal{K} \cdot \mathbf{I}_i$$

then

$$\delta_2^1(f, \mathbf{x}^j) = \mathbf{x}^j \otimes f.$$

Note that the tensor product is over the idempotent ring, so if $i \neq j$, then $\delta_2^1(f, \mathbf{x}^j) = 0$.

Similarly, we set

$$\delta_2^1(\sigma, \mathbf{x}^0) = \mathbf{x}^1 \otimes \sigma.$$

If \mathbf{x} is basis element of $\mathcal{CFK}^-(K)$, and $h_\lambda(\mathbf{x})$ contains a summand of $\mathcal{U}^i \mathcal{V}^j \mathbf{y}$, then $\delta_2^1(\tau, \mathbf{x}^0)$ contains a summand of $\mathbf{y}^1 \otimes \mathcal{U}^i \mathcal{V}^j \tau$. More generally, we recall that in Section 6.1 that \mathcal{K} as a quotient of an algebra $\tilde{\mathcal{K}}$. If $x \in \tilde{\mathcal{K}}$, write $[x]$ for its image in \mathcal{K} . If $[f \otimes \sigma \otimes g] \in \mathbf{I}_1 \cdot \tilde{\mathcal{K}} \cdot \mathbf{I}_0$, then we set

$$\delta_2^1([f \otimes \sigma \otimes g], \mathbf{x}^0) = \mathbf{x}^1 \otimes [f \otimes \sigma \otimes g].$$

If $h_\lambda(\mathbf{x}_i) = \sum_{j=1}^n \mathbf{x}_j \cdot g_{j,i}$, where $g_{j,i} \in \mathbb{F}[\mathcal{U}, \mathcal{V}, \mathcal{V}^{-1}]$, then

$$\delta_2^1([f \otimes \tau \otimes g], \mathbf{x}_i^0) = \sum_{j=1}^n \mathbf{x}_j^1 \otimes [f g_{ji} \otimes \tau \otimes g].$$

Remark 6.9. The type- D module $\mathcal{X}_\lambda(K)^{\mathcal{K}}$ and type- DA bimodule ${}_{\mathcal{K}}\mathcal{X}_\lambda(K)^{\mathcal{K}}$ are related by a box tensor product. There is a bimodule $\mathcal{D}^{\mathcal{K}}$, which has rank 1 over \mathbf{I} , with generators i_0 and i_1 , and has differential $\delta_1^1(i_0) = i_1 \otimes (\sigma + \tau)$. We have

$$\mathcal{D}^{\mathcal{K}} \hat{\boxtimes} {}_{\mathcal{K}}\mathcal{X}_\lambda(K)^{\mathcal{K}} \cong \mathcal{X}_\lambda(K)^{\mathcal{K}}. \quad (6.6)$$

In particular, the type- D module $\mathcal{X}_\lambda(K)^{\mathcal{K}}$ is *not* obtained by applying the forgetful functor to ${}_{\mathcal{K}}\mathcal{X}_\lambda(K)^{\mathcal{K}}$. We think of $\mathcal{D}^{\mathcal{K}}$ as the type- D module for a solid torus with a particular framing.

6.6. A_∞ perspectives on the link surgery formula. In this section, we describe several A_∞ -module perspectives on Manolescu and Ozsváth's link surgery theorem.

Define the algebra

$$\mathcal{L}(\ell) := \mathcal{K}_1 \otimes_{\mathbb{F}} \cdots \otimes_{\mathbb{F}} \mathcal{K}_\ell.$$

where each \mathcal{K}_i denotes a copy of \mathcal{K} . If L is an ℓ -component link in S^3 with integral framing Λ , we will describe a type- D module

$$\mathcal{X}_\Lambda(L)^{\mathcal{L}(\ell)}.$$

There is an obvious identification of $\mathcal{L}(\ell)$ -idempotents with points of the cube \mathbb{E}_ℓ . Write \mathbf{E}_ℓ for the ring of idempotents of $\mathcal{L}(\ell)$.

If $\mathbf{x}_1, \dots, \mathbf{x}_n$ is a free basis of $\mathcal{CFK}^-(L)$ over $\mathbb{F}[\mathcal{U}_1, \dots, \mathcal{U}_\ell, \mathcal{V}_1, \dots, \mathcal{V}_\ell]$, then we define the generators of $\mathcal{X}_\Lambda(L)^{\mathcal{L}(\ell)}$ to be

$$\text{Span}_{\mathbb{F}}(\mathbf{x}_1, \dots, \mathbf{x}_n) \otimes_{\mathbb{F}} \mathbf{E}_\ell$$

In particular, if \mathbf{x} is a basis element of $\mathcal{CFL}^-(L)$, we have a generator \mathbf{x}^ε for each $\varepsilon \in \mathbb{E}_\ell$.

If $M \subseteq L$, write $\varepsilon(M) \in \mathbb{E}_\ell$ for the coordinate such that $\varepsilon(M)_i = 0$ if $L_i \notin M$ and $\varepsilon(M)_i = 1$ if $L_i \in M$.

Suppose that \mathbf{x} is a basis element of $\mathcal{CFL}^-(L)$ and $M \subseteq L$. By Lemma 5.7, we may view $\mathbf{x}^{\varepsilon(M)}$ as an element of $\prod_{\mathbf{s} \in \mathbb{H}(L)} \mathfrak{A}^-(\mathcal{H}^{L-M}, \psi^M(\mathbf{s}))$. Suppose also that \vec{N} is an oriented sublink of $L - M$, and that $\Phi^{\vec{N}}(\mathbf{x}^{\varepsilon(M)})$ has a summand of $\mathbf{y}^{\varepsilon(M \cup N)} \cdot f$, where we view f as an element of the 2ℓ -variable polynomial ring, localized at the variables \mathcal{V}_i such that $L_i \subseteq N$. We may naturally view f as being an element of

$$\mathbf{E}_{\varepsilon(M \cup N)} \cdot \mathcal{L}(\ell) \cdot \mathbf{E}_{\varepsilon(M \cup N)}.$$

There is an algebra element $t_{\varepsilon(M), \varepsilon(M \cup N)}^{\vec{N}} \in \mathbf{E}_{\varepsilon(M \cup N)} \cdot \mathcal{L}(\ell) \cdot \mathbf{E}_{\varepsilon(M)}$ which is the tensor of σ_i for i such that $L_i \subseteq \vec{N}$ and L_i is oriented the same as L , τ_i for i such that $L_i \subseteq \vec{N}$ and L_i is oriented oppositely from L , and 1 for i such that $L_i \notin N$. With this notation, we declare $\delta^1(\mathbf{x}^\varepsilon)$ to have the summand

$$\mathbf{y}^{\varepsilon(M \cup N)} \otimes f \cdot t_{\varepsilon(M), \varepsilon(M \cup N)}^{\vec{N}}.$$

Lemma 6.10. $\mathcal{X}_\Lambda(L)^{\mathcal{L}(\ell)}$ is a type- D module.

Proof. The proof is similar to Lemma 6.8. If $\vec{N} \subseteq L$ is an oriented sublink, let us write $D^{\vec{N}}$ for the sum of the maps $\Phi^{\vec{J}}$ for all oriented sublinks $\vec{J} \subseteq \vec{N}$, as well as the internal differentials of $\mathcal{CFL}^-(L)$. By [MO10, Proposition 9.4], the map $D^{\vec{N}}$ squares to 0.

Let \mathbf{x} and \mathbf{y} be basis elements of $\mathcal{CFL}^-(L)$, and suppose that $\varepsilon \leq \varepsilon'$ are coordinates of \mathbb{E}_ℓ . We consider the $\mathbf{y}^{\varepsilon'}$ component of

$$\left((\text{id}_{\mathcal{X}} \otimes \mu_2) \circ (\delta^1 \otimes \text{id}_{\mathcal{L}(\ell)}) \circ \delta^1 \right) (\mathbf{x}^\varepsilon) \quad (6.7)$$

If $\varepsilon = \varepsilon'$, then the $\mathbf{y}^{\varepsilon'}$ component of Equation (6.7) vanishes since $\mathcal{CFL}^-(L)$ is a chain complex.

Suppose that $\varepsilon < \varepsilon'$. Let N be the sublink corresponding to $\varepsilon' - \varepsilon$, and let \vec{N} be a fixed orientation on N . We consider the sum of all terms of Equation (6.7) which are of the form $\mathbf{y}^{\varepsilon'} \otimes f \cdot t_{\varepsilon, \varepsilon'}^{\vec{N}}$, for some $f \in \mathbf{E}_{\varepsilon'} \cdot \mathcal{L}(\ell) \cdot \mathbf{E}_{\varepsilon}$. These are all contributed by the link surgery maps for oriented sublinks of \vec{N} . Lemma 5.9 can be used to show that this term is $\mathbf{y}^{\varepsilon'} \otimes f \cdot t_{\varepsilon, \varepsilon'}^{\vec{N}}$, where f is the coefficient of $\mathbf{y}^{\varepsilon'}$ in $(D^{\vec{N}} \circ D^{\vec{N}})(\mathbf{x}^\varepsilon)$. In particular, Equation (6.7) vanishes by [MO10, Proposition 9.4], completing the proof. \square

Given a collection of integers $\Lambda = (\lambda_1, \dots, \lambda_\ell)$, there is a type- A module

$$\mathcal{L}(\ell) \mathcal{F}_\Lambda$$

defined similarly to the case of knots. This can be defined by taking the box tensor product of many of the $\mathcal{K}[\mathcal{F}_{\lambda_i}]$, using the extension of scalars construction from Section 3.5. As with the case of knots, \mathcal{F}_Λ may be viewed as an AA -bimodule

$$\mathcal{L}(\ell) [\mathcal{F}_\Lambda]_{\mathbb{F}[U_1, \dots, U_\ell]}.$$

We can also form a completed version, which we denote by $\mathcal{L}(\ell) [\mathcal{F}(\Lambda)]_{\mathbb{F}[[U_1, \dots, U_\ell]]}$

The following is a restatement of Manolescu and Ozsváth's integer surgery formula:

Theorem 6.11 ([MO10]). *There is a quasi-isomorphism*

$$\mathcal{X}_\Lambda(L)^{\mathcal{L}^{(\ell)}} \hat{\boxtimes}_{\mathcal{L}^{(\ell)}} [\mathcal{F}_0]_{\mathbb{F}[[U]]} \cong \mathbf{CF}^-(S_\Lambda^3(L))_{\mathbb{F}[[U]]},$$

where U acts on the right side by one of the U_1, \dots, U_ℓ .

We will also need to consider type- A and type- DA versions of the link surgery formula. The most important case is when we have a distinguished component $K_i \subseteq L$, and we want to define a bimodule ${}_{\mathcal{K}}\mathcal{X}_\Lambda(L)^{\mathcal{L}^{(\ell)}}$, where the \mathcal{K} -input corresponds to K_i . In this case, we define

$${}_{\mathcal{K}}\mathcal{X}_\Lambda(L)^{\mathcal{L}^{(\ell)}} := \mathcal{X}_\Lambda(L)^{\mathcal{L}^{(\ell)}} \hat{\boxtimes}_{\mathcal{K} \otimes \mathcal{K}} M_2^{\mathcal{K}},$$

where all tensor products are taken along the algebra component corresponding to K_i .

Remark 6.12. It is also possible to define a type- A module ${}_{\mathcal{L}^{(\ell)}}\mathcal{X}_\Lambda(L)$ which also fully encodes the surgery formula. In general, the construction requires additional choices, such as an ordering of axis directions. The simplest construction is to repeatedly box in ${}_{\mathcal{K} \otimes \mathcal{K}}M_2^{\mathcal{K}} \hat{\boxtimes}_{\mathcal{K}} [\mathcal{F}_0]$.

7. BASIC SYSTEMS OF HEEGAARD DIAGRAMS

In this section, we recall the notion of a *basic system system of Heegaard diagrams* from [MO10]. We also describe how to construct a basic system for the connected sum of two links.

7.1. Basic systems. Let $(\Sigma, \boldsymbol{\alpha}, \boldsymbol{\beta}, \mathbf{w}, \mathbf{z})$ be a link minimal Heegaard diagram for (Y, \mathbb{L}) .

Definition 7.1. A set of *good trajectories* is a collection of maps $c_i: [0, 1] \rightarrow \Sigma$, for $i \in \{1, \dots, \ell\}$, of pairwise disjoint embedded arcs on Σ , such that for all i , we have $c_i([0, 1]) \cap \boldsymbol{\alpha} = \emptyset$, $c_i(0) = z_i$ and $c_i(1) = w_i$, where z_i and w_i are the basepoints of the link component $L_i \subseteq L$.

The following is a small modification of [MO10, Section 8.7]:

Definition 7.2. Suppose that $\mathcal{H} = (\Sigma, \boldsymbol{\alpha}, \boldsymbol{\beta}, \mathbf{w}, \mathbf{z})$ is a link minimal Heegaard link diagram for (Y, L) . A *basic system of Heegaard diagrams* over \mathcal{H} consists of a collection of hyperboxes of beta attaching curves with basepoint slides,

$$\mathcal{L}_\beta^M = (\boldsymbol{\beta}_\varepsilon, \mathbf{w}_{L-M}, \mathbf{z}_{L-M}, \mathbf{f}_\varepsilon, \Theta_{\varepsilon, \varepsilon'})_{\varepsilon \in \mathbb{E}(\mathbf{d})},$$

ranging over each sublink $M \subseteq L$. In the above, $\mathbf{d} = (d_1, \dots, d_m)$ is a tuple (depending on M), such that $m = |M|$. If $M_1 \subseteq M_2$, write $i_{M_1, M_2}: \{1, \dots, m_1\} \rightarrow \{1, \dots, m_2\}$ for the corresponding inclusion map of indices. We assume the following are satisfied:

- (1) $\mathbf{w}_{L-M} = \{w_i \in \mathbf{w} : L_i \not\subseteq M\}$ and $\mathbf{z}_{L-M} = \{z_i \in \mathbf{z} : L_i \not\subseteq M\}$. For each $\varepsilon \in \mathbb{E}(\mathbf{d})$, \mathbf{f}_ε is a collection of m free basepoints.
- (2) If $\varepsilon = (\nu_1 d_1, \dots, \nu_m d_m)$ for some $(\nu_1, \dots, \nu_m) \in \mathbb{E}_m$, then $w_{i_{M, L}(j)} \in \mathbf{f}_\varepsilon$ if and only if $\nu_j = 1$. Similarly $z_{i_{M, L}(j)} \in \mathbf{f}_\varepsilon$ if and only if $\nu_j = 0$.
- (3) If $\varepsilon = (\nu_1 d_1, \dots, \nu_m d_m)$ for some $(\nu_1, \dots, \nu_m) \in \mathbb{E}_m$, then $\boldsymbol{\beta}_\varepsilon = \boldsymbol{\beta}$.
- (4) On each subcube \mathcal{L} of \mathcal{L}_β^M which does not contain any basepoint slide arcs (so that in particular each tuple $(\boldsymbol{\beta}_\varepsilon, \mathbf{w}_\varepsilon, \mathbf{z}_\varepsilon, \mathbf{f}_\varepsilon)$ in \mathcal{L} share a single set of basepoints $\mathbf{w}_\mathcal{L} \cup \mathbf{z}_\mathcal{L} \cup \mathbf{f}_\mathcal{L}$), all of the beta-curves are handleslide equivalent in the complement of $\mathbf{w}_\mathcal{L} \cup \mathbf{z}_\mathcal{L} \cup \mathbf{f}_\mathcal{L}$. Furthermore, all of the length 1 morphisms represent the top degree generators of Floer homology.

- (5) If $\mathcal{L} = (\mathcal{L}_\beta, \mathbf{w}_\mathcal{L}, \mathbf{z}_\mathcal{L}, \mathbf{f}_\mathcal{L})$ is a subcube of \mathcal{L}_β^M containing no basepoint slide arcs, then $(\Sigma, \boldsymbol{\alpha}, \mathcal{L}_\beta, \mathbf{w}_\mathcal{L} \cup \mathbf{f}_\mathcal{L})$ is weakly admissible.
- (6) In the hyperbox \mathcal{L}_β^M , all of the slide arcs which point in the j -th axis direction are subarcs of $c_{i_{M,L}(j)}([0, 1])$. Each slide arc morphism has boundary equal to two free-basepoints. Furthermore, if $\lambda_1^j, \dots, \lambda_k^j$ are the slide arc morphisms pointing in the j -th axis direction of $\mathbb{E}(\mathbf{d})$, then the concatenation of $\lambda_1^j, \dots, \lambda_k^j$ is $c_{i_{M,L}(j)}([0, 1])$.
- (7) The hyperboxes \mathcal{L}_β^M are compatible with inclusions of sublinks in the following sense. Suppose that $M_1 \subseteq M_2 \subseteq L$. Write $\mathbf{d}_i = (d_{1,i}, \dots, d_{m_i,i})$ for the size of M_i , where $i = 1, 2$. Recall that there are $2^{m_2 - m_1}$ boundary faces of $\mathcal{L}_\beta^{M_2}$ which increment only the directions corresponding to M_1 . We can view these $m_2 - m_1$ faces as being indexed by points $\nu \in \mathbb{E}_{m_2 - m_1}$. If $\nu \in \mathbb{E}_{m_2 - m_1}$, then there is a face $F_\nu^{M_2}$ of $\mathcal{L}_\beta^{M_2}$ consisting of the points $\varepsilon \in \mathbb{E}(\mathbf{d}_2)$ which have $\varepsilon_{i_{M_1, M_2}(j)} = d_{i_{M_1, M_2}(j), 2} \cdot \nu_j$, for $j \in \{1, \dots, m_1\}$. We also assume the hyperbox $F_\nu^{M_2}$ is obtained by algebraically reducing $\mathcal{L}_\beta^{M_1}$, as follows. If $\nu_j = 0$, then we delete $w_{i_{M_1, L}(j)}$ and make $z_{i_{M_1, L}(j)}$ a free-basepoint. If $\nu_j = 1$, then we make $w_{i_{M_1, L}(j)}$ a free-basepoint and delete $z_{i_{M_1, L}(j)}$. We assume that the morphisms are correspondingly obtained by quotienting, for each $j \in \{1, \dots, m_1\}$, the element $\mathcal{U}_{i_{M_1, L}(j)} + 1$ (resp. $\mathcal{V}_{i_{M_1, L}(j)} + 1$) if $\nu_j = 0$ (resp. $\nu_j = 1$).

Remark 7.3. We warn the reader that there are several ways in which the above definition nominally differs from Manolescu and Ozsváth's notion of a basic system [MO10, Definition 8.30].

- (1) We allow the hyperboxes \mathcal{L}_β^M to be arbitrarily large, whereas Manolescu and Ozsváth only allow it to be of size $(2, \dots, 2)$. Note that their definition of a *complete system* allows for hyperboxes of arbitrary size [MO10, Section 8.6], and a basic system is a special case of a complete system.
- (2) Manolescu and Ozsváth's complete systems do not use the language of basepoint slides. Instead, they use surface isotopies along the arcs c_i as the last map in each axis of their hypercubes. These surface isotopies may also move the beta-curves, whereas our slide arcs are disjoint from the beta-curves. See [MO10, Figure 31]. Our notion produces isomorphic surgery hypercubes, as can be seen by breaking each surface isotopy into a sequence of basepoint slides along arcs which are disjoint from the attaching curves, and tautological diffeomorphism maps which change the beta curves but fix the basepoints. The extra flexibility of moving basepoints in the middle of the cube is useful in proving our connected sum formula.

The following definition plays an important role in our proof of the connected sum formula for surgery hypercubes:

Definition 7.4. Suppose that $\mathcal{L}_\beta = (\beta_\varepsilon, \mathbf{w}, \mathbf{z}, \mathbf{f})_{\varepsilon \in \mathbb{E}_n}$ is a weakly admissible hypercube of handleslide equivalent beta-attaching curves such that \mathbf{w} and \mathbf{z} contain no free-basepoints, and \mathbf{f} consists only of free-basepoints. We say \mathcal{L}_β is *algebraically rigid* if each $\mathbb{T}_{\beta_\varepsilon} \cap \mathbb{T}_{\beta_{\varepsilon'}}$ has $2^{g(\Sigma) + |\mathbf{w}| + |\mathbf{f}| - 1}$ intersection points (the minimal possible number). We say a hyperbox of beta attaching curves is algebraically rigid if each sub-hypercube

is algebraically rigid. We say that a basic system of Heegaard diagrams is algebraically rigid if each beta-hypercube which contains no basepoints slides is algebraically rigid.

Lemma 7.5. *Suppose L is an ℓ -component link in S^3 . There exists a link minimal, weakly admissible, algebraically rigid basic system of Heegaard diagrams for (S^3, L) .*

Proof. We focus on building the largest hyperbox of the basic system, when $M = -L$, since the other hyperboxes are determined from this one by the compatibility condition.

We begin with a link-minimal Heegaard diagram $\mathcal{H} = (\Sigma, \boldsymbol{\alpha}, \boldsymbol{\beta}, \mathbf{w}, \mathbf{z})$ such there are ℓ special beta curves $\beta_1^s, \dots, \beta_\ell^s$, such that there is an arc c_i connecting w_i and z_i , which intersects β_i^s in a single point, and intersects no other alpha or beta curves. We assume \mathcal{H} has no free-basepoints.

Note that $\Sigma \setminus \boldsymbol{\beta}$ contains ℓ components, each of which is planar and each of which contains the basepoints w_i and z_i from a link component L_i . Furthermore, each β_i^s is contained in the boundary of a unique component B_i . Closing B_i up along β_i^s yields a genus one surface with punctures. We perform a sequence of isotopies and handleslides which move β_i^s around this punctured torus, to the other side of z_i . Such a move may be accomplished via a sequence $\beta_i^1, \dots, \beta_i^n$, for some n , such that $|\beta_i^j \cap \beta_i^{j+1}| = 2$, and so that (after closing up the other boundary components with disks to obtain a toroidal diagram) the diagram $(\mathbb{T}^2, \beta_i^j, \beta_i^{j+1}, z_i)$ is admissible. See Figure 7.1.

We may do this procedure for each special beta curve. Furthermore, the toroidal regions containing different special beta curves are disjoint. Hence, this procedure may be performed simultaneously on all of the special beta curves to obtain a hyperbox of beta curves with basepoint slides. For the non-special beta curves, we adjoin suitably small Hamiltonian translates of the original beta curves.

Admissibility is verified as follows. We first verify admissibility for each subcube \mathcal{L} of \mathcal{L}_β^M which contains no slide-arc morphisms. It is easy to see that admissibility of \mathcal{L} is equivalent to admissibility of the diagram where we delete the tuples of curves which appear only as small translates of each other, and surger Σ along these curves as well. The resulting Heegaard diagram is a union of tori, and admissibility follows easily from our choice of β_i^j curves. See Figure 7.1.

If \mathcal{L} is a subcube of \mathcal{L}_β^M containing no slide-arc morphisms, then admissibility of $(\Sigma, \boldsymbol{\alpha}, \mathcal{L}, \mathbf{w}_\mathcal{L}, \mathbf{z}_\mathcal{L})$ is obtained by winding $\boldsymbol{\alpha}$ sufficiently, following the procedure described in [OS04b, Section 4.2.2] [OS08a, Section 3.4]. \square

7.2. Tensor products of hypercubes of attaching curves. If \mathcal{L}_β is a hypercube of attaching curves on $(\Sigma, \mathbf{w}, \mathbf{z})$, and $\mathcal{L}_{\beta'}$ is a hypercube of attaching curves on $(\Sigma', \mathbf{w}', \mathbf{z}')$, of dimensions n and m , respectively, we now define an $(n + m)$ -dimensional hypercube $\mathcal{L}_\beta \otimes \mathcal{L}_{\beta'}$ on $(\Sigma \sqcup \Sigma', \mathbf{w} \cup \mathbf{w}', \mathbf{z} \cup \mathbf{z}')$. We note that the construction of $\mathcal{L}_\beta \otimes \mathcal{L}_{\beta'}$ is essentially identical to Lipshitz, Ozsváth and Thurston's construction of a *connected sum of chain complexes of attaching circles* [LOT16, Definition 3.40].

We begin with the underlying attaching curves of $\mathcal{L}_\beta \otimes \mathcal{L}_{\beta'}$, which we denote by $(\boldsymbol{\delta}_{(\varepsilon, \nu)})_{(\varepsilon, \nu) \in \mathbb{E}_n \times \mathbb{E}_m}$, where $n = \dim(\mathcal{L}_\beta)$ and $m = \dim(\mathcal{L}_{\beta'})$. We set $\boldsymbol{\delta}_{(\varepsilon, \nu)}$ to be a small translation of $\boldsymbol{\beta}_\varepsilon \cup \boldsymbol{\beta}'_\nu$. We assume the small translations are chosen so that the copies of $\boldsymbol{\beta}_\varepsilon$ from $\boldsymbol{\delta}_{(\varepsilon, \nu)}$ and $\boldsymbol{\delta}_{(\varepsilon', \nu')}$ intersect in $2^{g(\Sigma) + |\mathbf{w}| - 1}$ points, and similarly for the translated curves on Σ' .

Before defining the morphisms of $\mathcal{L}_\beta \otimes \mathcal{L}_{\beta'}$ we begin with some helpful terminology:

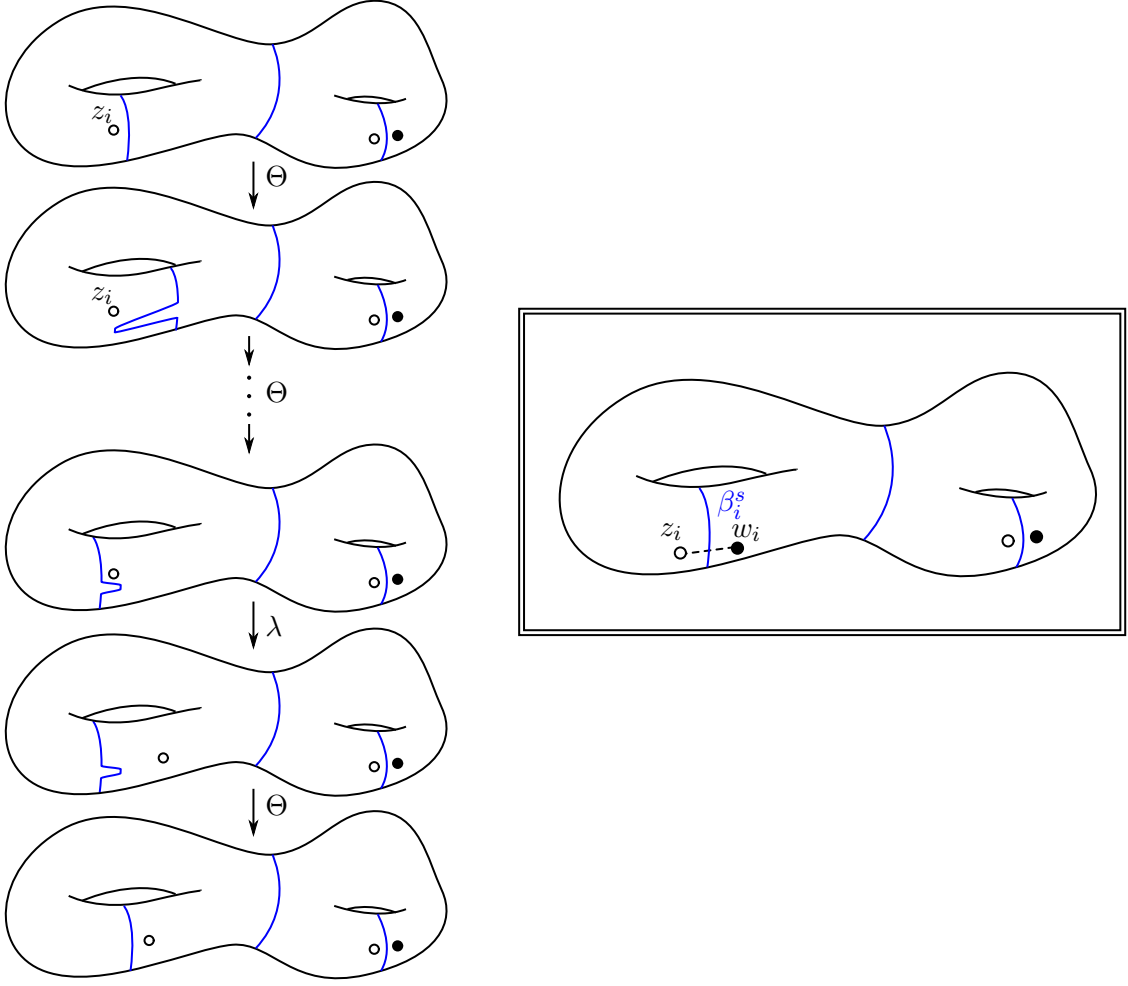

FIGURE 7.1. Some of the beta curves and a basepoint slide from Lemma 7.5. The arrows marked Θ correspond to elements of Floer complexes. The arrow marked λ is a slide arrow. The dashed arc on the right is c_i .

Definition 7.6. If $\varepsilon, \varepsilon' \in \mathbb{E}_n$, we say that there is an *arrow* from ε to ε' if $\varepsilon < \varepsilon'$.

- (1) We say that an arrow from $(\varepsilon, \nu) \in \mathbb{E}_n \times \mathbb{E}_m$ to (ε', ν') is *mixed* if $\varepsilon < \varepsilon'$ and $\nu < \nu'$.
- (2) We say that an arrow from (ε, ν) to (ε', ν') is *non-mixed* if $\varepsilon = \varepsilon'$ or $\nu = \nu'$.

We now describe the morphisms of $\mathcal{L}_\beta \otimes \mathcal{L}_{\beta'}$. We define the chains in $\mathcal{L}_\beta \otimes \mathcal{L}_{\beta'}$ for each mixed arrow to be zero. For the arrow from (ε, ν) to (ε, ν') , where $\nu < \nu'$, we use the chain

$$\Theta_{\varepsilon, \varepsilon}^+ \otimes \Theta_{\nu, \nu'},$$

where $\Theta_{\varepsilon, \varepsilon}^+$ denotes the top degree generator (recall that we have perturbed one copy of β_ε slightly in the definition), and $\Theta_{\nu, \nu'}$ denotes the chain from $\mathcal{L}_{\beta'}$. Similarly, for

the arrow from (ε, ν) to (ε', ν) , where $\varepsilon < \varepsilon'$, we use the chain

$$\Theta_{\varepsilon, \varepsilon'} \otimes \Theta_{\nu, \nu}^+$$

Remark 7.7. We will only use the above construction in the case that \mathcal{L}_β and $\mathcal{L}_{\beta'}$ are algebraically rigid. In this case, $\mathcal{L}_\beta \otimes \mathcal{L}_{\beta'}$ is also algebraically rigid, and the hypercube relations are automatic.

7.3. Basic systems and connected sums of links. In this section, we use the construction in Lemma 7.5 to construct an algebraically rigid basic system for connected sums of links.

Suppose that links L and L' are two links in S^3 , and that we have two distinguished components $K \subseteq L$ and $K' \subseteq L'$, along which we take the connected sum. Furthermore, write w, z, w' and z' for the basepoints on K and K' . Let \mathcal{L}_β and $\mathcal{L}_{\beta'}$ denote basic systems for \mathcal{H} and \mathcal{H}' , respectively, for some choice of good trajectories. We also assume that \mathcal{L}_β and $\mathcal{L}_{\beta'}$ are algebraically rigid, which is possible by Lemma 7.5. We now define a basic system for the connected sum $L\#L'$, built from \mathcal{L}_β and $\mathcal{L}_{\beta'}$. We focus on the largest hyperbox of the system, since the smaller hyperboxes are determined by the inclusion compatibility.

We take the connected sum of Σ and Σ' at w_1 and z'_1 , deleting those two basepoints, and leaving z_1 and w'_1 .

Write ν_1 denote the index of $\mathcal{L}_{\beta'}^0$ corresponding to $K' \subseteq L'$. Let $\mathcal{L}_{\beta'}^0$ denote the subface of $\mathcal{L}_{\beta'}$ which has $\nu_1 = 0$. We first construct the hyperbox-shaped diagram (i.e. a hyperbox where the compatibility condition may not be satisfied) of beta attaching curves with basepoints slides on $\Sigma\#\Sigma'$, which we denote $\mathcal{L}_\beta \otimes \mathcal{L}_{\beta'}^0$. This is a hyperbox-shaped diagram of dimension $(\ell + \ell' - 1)$, and is constructed via the same procedure from Section 7.2. Next, let \mathcal{L}_β^1 denote the subface of \mathcal{L}_β which has ε_1 maximal, where ε_1 is the component corresponding to $K \subseteq L$. We build a hyperbox-shaped diagram $\mathcal{L}_\beta^1 \otimes \mathcal{L}_{\beta'}^0$ of dimension $(\ell + \ell' - 1)$.

Both $\mathcal{L}_\beta \otimes \mathcal{L}_{\beta'}^0$ and $\mathcal{L}_\beta^1 \otimes \mathcal{L}_{\beta'}^0$ share $\mathcal{L}_\beta^1 \otimes \mathcal{L}_{\beta'}^0$ as a codimension 1 subface. In particular, we may stack $\mathcal{L}_\beta \otimes \mathcal{L}_{\beta'}^0$ and $\mathcal{L}_\beta^1 \otimes \mathcal{L}_{\beta'}^0$ to form hyperbox-shaped diagram. Hence, for the connected sum $L\#L'$, we may use the hyperbox

$$\text{St}(\mathcal{L}_\beta \otimes \mathcal{L}_{\beta'}^0, \mathcal{L}_\beta^1 \otimes \mathcal{L}_{\beta'}^0), \quad (7.1)$$

where St denotes stacking hyperboxes. This construction yields a basic system of hyperboxes for $L\#L'$, whose largest hyperbox is given by Equation (7.1).

Remark 7.8. If \mathcal{L}_β and $\mathcal{L}_{\beta'}$ are algebraically rigid, then the diagram in (7.1) is also automatically algebraically rigid, and hence satisfies the compatibility conditions for a hyperbox of beta attaching curves.

8. HYPERCUBES AND DISCONNECTED HEEGAARD SURFACES

In this section, we consider hypercubes of attaching curves on disconnected Heegaard surfaces. If \mathcal{L}_β is a hypercube of attaching curves on $(\Sigma, \mathbf{w}, \mathbf{z})$, and $\mathcal{L}_{\beta'}$ is a hypercube of attaching curves on $(\Sigma', \mathbf{w}', \mathbf{z}')$, of dimensions n and m , respectively, recall that in Section 7.2 we defined an $(n + m)$ -dimensional hypercube of attaching curves $\mathcal{L}_\beta \otimes \mathcal{L}_{\beta'}$ on $(\Sigma \sqcup \Sigma', \mathbf{w} \cup \mathbf{w}', \mathbf{z} \cup \mathbf{z}')$.

The goal of this section is to prove the following:

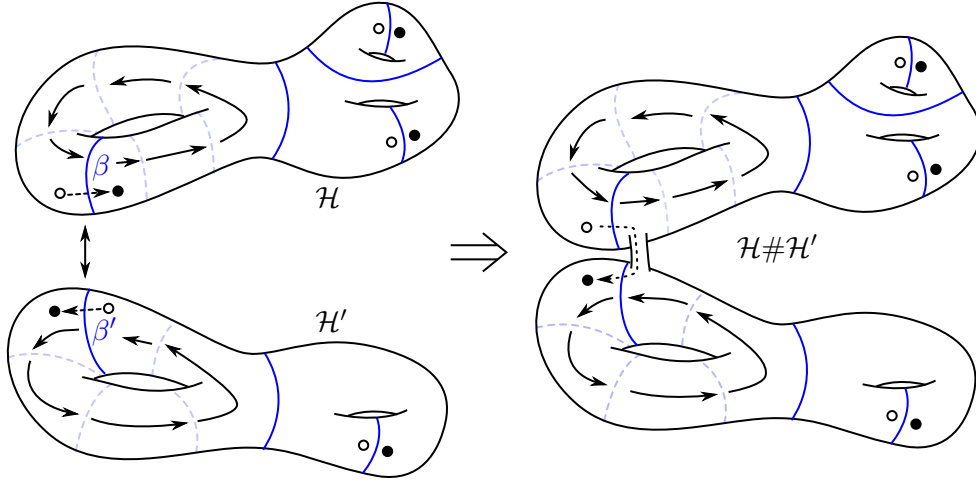

FIGURE 7.2. A schematic of a basic system for a connected sum which is used in the pairing theorem. The solid arrows indicate the sequences of special beta curves, β and β' . The dashed arrows denote the movement of the basepoint via the slide arc morphisms.

Proposition 8.1. *Suppose that \mathcal{L}_β and $\mathcal{L}_{\beta'}$ are admissible hypercubes of handleslide equivalent attaching curves on $(\Sigma, \mathbf{w}, \mathbf{z})$ and $(\Sigma', \mathbf{w}', \mathbf{z}')$, respectively.*

- (1) *If the small translates in the construction of $\mathcal{L}_\beta \otimes \mathcal{L}_{\beta'}$ are chosen suitably small, then $\mathcal{L}_\beta \otimes \mathcal{L}_{\beta'}$ is a hypercube of attaching curves.*
- (2) *If the translations used in the construction of $\mathcal{L}_\beta \otimes \mathcal{L}_{\beta'}$ are suitably small, then the canonical map*

$$CF^-(\Sigma \sqcup \Sigma', \alpha \cup \alpha', \mathcal{L}_\beta \otimes \mathcal{L}_{\beta'}, \mathbf{w} \cup \mathbf{w}', \mathbf{z} \cup \mathbf{z}') \cong CF^-(\Sigma, \alpha, \mathcal{L}_\beta, \mathbf{w}, \mathbf{z}) \otimes_{\mathbb{F}} CF^-(\Sigma', \alpha', \mathcal{L}_{\beta'}, \mathbf{w}', \mathbf{z}'),$$

is a chain isomorphism.

Our proof of Proposition 8.1 follows from the same line of reasoning as [LOT16, Section 3.5], though we present it for the benefit of the reader.

8.1. Small translate theorems. We now review a preliminary technical result concerning Heegaard diagrams with small translate curves. These are based on the results of [LOT16, Section 3] and [HHSZ20, Section 11].

Lemma 8.2. *Suppose $\mathcal{D} = (\Sigma, \alpha, \beta_1, \dots, \beta_k, \mathbf{w}, \mathbf{z})$ is a multi-pointed Heegaard link diagram, and that the curves β_1, \dots, β_k are pairwise handleslide-equivalent. Suppose \mathbf{z} contains no free-basepoints. Suppose furthermore that the diagram is strongly \mathfrak{s} admissible for some Spin^c -structure. For $j \in \{1, \dots, k\}$, pick attaching curves $\beta_j^1, \dots, \beta_j^{i_j}$ which are small translates of β_j , for $i_j \geq 1$. Suppose, furthermore the small translates are chosen so that $\mathcal{D}' = (\Sigma, \alpha, \beta_1^1, \dots, \beta_1^{i_1}, \dots, \beta_k^1, \dots, \beta_k^{i_k}, \mathbf{w}, \mathbf{z})$ is also admissible, and so that each $\mathbb{T}_{\beta_j^n} \cap \mathbb{T}_{\beta_j^m}$ contains exactly $2^{g(\Sigma) + |\mathbf{w}| - 1}$ points, for each j, n and m . Suppose that $(J_x)_{x \in K_{\ell-1}}$ is a generically chosen family of almost complex structures for counting holomorphic ℓ -gons. If the translations in the construction are chosen suitably small, then the following holds: If ψ is a class of ℓ -gons representing \mathfrak{s} such that the input*

of each $CF^-(\beta_j^i, \beta_j^{i+1}, \mathbf{w}, \mathbf{z})$ is the top degree generator and ψ has a J_x -holomorphic representative for some $x \in K_{\ell-1}$, then

$$\mu(\psi) \geq \min(0, 2 - k).$$

Remark 8.3. A convenient reformulation is that if $s := \sum_{j=1}^k (i_j - 1)$ denotes the number of special inputs from small translates and ℓ denotes the total number of attaching curves, then

$$\mu(\psi) \geq \min(0, 3 - \ell + s).$$

We now briefly sketch the proof of Lemma 8.2. Consider a class of ℓ -gons on \mathcal{D}' , such that for each i, j , the input from $\mathbb{T}_{\beta_j^i} \cap \mathbb{T}_{\beta_j^{i+1}}$ is the top degree generator. There is a well-defined approximating class ψ^{app} on \mathcal{D} , and $\mu(\psi) = \mu(\psi^{\text{app}})$ (at this step, one needs the special inputs to be the top degree generator; see [HHSZ20, Lemma 11.3], which generalizes easily from triangles to ℓ -gons). For each i and j , we pick a sequence $(\beta_{j,n}^i)_{n \in \mathbb{N}}$, such that as $n \rightarrow \infty$, the curves $\beta_{j,n}^i$ approach β_j^i . Write \mathcal{D}'_n for the diagram obtained by replacing each β_j^i with $\beta_{j,n}^i$. Given a sequence u_n of holomorphic representatives of ψ on \mathcal{D}'_n , we may extract a subsequence which converges to representative of ψ^{app} , which is a $(k+1)$ -gon. In particular, by applying transversality for $(k+1)$ -gons, one obtains that

$$\mu(\psi) \geq \min(0, 3 - (k+1)).$$

We refer the reader to [LOT16, Section 3] and [HHSZ20, Section 11] for additional details.

There is an additional refinement of the above lemma for the case when $\mathcal{D} = (\Sigma, \alpha, \beta, \mathbf{w})$ is an ordinary Heegaard diagram, and we have only one translate of the curves β' . In this case, if β' are chosen to be suitably small Hamiltonian translates of β . Then there is a canonical nearest point map

$$\Phi_{np}: \mathbb{T}_\alpha \cap \mathbb{T}_\beta \rightarrow \mathbb{T}_\alpha \cap \mathbb{T}_{\beta'}.$$

Extended linear over $\mathbb{F}[U]$, we obtain a map

$$\Phi_{np}: CF^-(\Sigma, \alpha, \beta, \mathbf{w}) \rightarrow CF^-(\Sigma, \alpha, \beta', \mathbf{w}).$$

Lemma 8.4. *If the curves β' are chosen to be suitably small translates of the curves β , then we have an equality of maps*

$$\Phi_{np}(-) = f_{\alpha, \beta, \beta'}(-, \Theta_{\beta, \beta'}^+).$$

The proof in the case of \widehat{CF} was proven by Lipshitz, Ozsváth and Thurston in [LOT16, Lemma 3.38]. This was extended to CF^- (mostly by adapting the notation of [LOT16]) in [HHSZ20, Proposition 11.1].

8.2. Disconnected Heegaard surfaces. Suppose that we have two sets of alpha attaching curves α and α' on pointed Heegaard diagrams (Σ, \mathbf{w}) and (Σ', \mathbf{w}') , respectively. Furthermore, suppose that \mathcal{L}_β and $\mathcal{L}_{\beta'}$ are hypercubes of handleslide equivalent attaching curves on (Σ, \mathbf{w}) and (Σ', \mathbf{w}') , of dimension n and m , respectively.

We now prove that for suitable choices of translates, the diagram $\mathcal{L}_\beta \otimes \mathcal{L}_{\beta'}$ is a hypercube of attaching curves (compare [LOT16, Proposition 3.52]):

Proof of Part (1) of Proposition 8.1. As a first step, we wish to understand the holomorphic curve counts associated to an increasing sequence $\kappa_1 < \dots < \kappa_\ell$ in \mathbb{E}_{n+m} . Write $\kappa_i = (\varepsilon_i, \nu_i)$.

We consider first the case that $\ell = 2$, since it is the simplest. By the definition of $\mathcal{L}_\beta \otimes \mathcal{L}_{\beta'}$, we must have $\varepsilon_1 = \varepsilon_2$ and $\nu_1 < \nu_2$, or $\varepsilon_1 < \varepsilon_2$ and $\nu_1 = \nu_2$. Assume the latter case. We wish to show

$$\partial(\Theta_{\varepsilon_1, \varepsilon_2} \otimes \Theta_{\nu_1, \nu_2}^+) = 0. \quad (8.1)$$

To see this, suppose that (ϕ, ϕ') is a class of disks, such that $\mu(\phi) + \mu(\phi') = 1$. If (ϕ, ϕ') has a representative, then $\mu(\phi)$ and $\mu(\phi')$ are both nonnegative. Hence, one must be 1, and the other 0. By transversality, the only pairs with representatives will have the property that one of ϕ or ϕ' is a constant class of disks, while the other is an index 1 class of disks. Hence the differential on Floer complex $CF^-(\Sigma \sqcup \Sigma', \beta_{\varepsilon_1} \cup \beta'_{\nu_1}, \beta_{\varepsilon_2} \cup \beta'_{\nu_2})$ is the ordinary tensor product differential, so (8.1) follows from the fact that $\Theta_{\varepsilon_1, \varepsilon_2}$ and Θ_{ν_1, ν_2}^+ are both cycles.

We now consider the case that $\ell \geq 3$. We enumerate the following two special cases:

- (s.c.-1) $\ell = 3$, $\varepsilon_2 = \varepsilon_3$, $\nu_1 = \nu_2$, and $\varepsilon_1 < \varepsilon_2$.
- (s.c.-2) $\ell = 3$, $\varepsilon_1 = \varepsilon_2$, $\nu_2 = \nu_3$, and $\nu_1 < \nu_2$.

We make the following claim:

$$\begin{aligned} & f_{\kappa_1, \dots, \kappa_\ell}(\Theta_{\kappa_1, \kappa_2}, \dots, \Theta_{\kappa_{\ell-1}, \kappa_\ell}) \\ &= \begin{cases} f_{\varepsilon_1, \dots, \varepsilon_\ell}(\Theta_{\varepsilon_1, \varepsilon_2}, \dots, \Theta_{\varepsilon_{\ell-1}, \varepsilon_\ell}) \otimes \Theta_{\nu_1, \nu_\ell}^+ & \text{if } \nu_1 = \nu_\ell \\ \Theta_{\varepsilon_1, \varepsilon_\ell}^+ \otimes f_{\nu_1, \dots, \nu_\ell}(\Theta_{\nu_1, \nu_2}, \dots, \Theta_{\nu_{\ell-1}, \nu_\ell}) & \text{if } \varepsilon_1 = \varepsilon_\ell \\ f_{\varepsilon_1, \varepsilon_2, \varepsilon_2}(\Theta_{\varepsilon_1, \varepsilon_2}, \Theta_{\varepsilon_2, \varepsilon_2}^+) \otimes f_{\nu_2, \nu_2, \nu_3}(\Theta_{\nu_2, \nu_2}^+, \Theta_{\nu_2, \nu_3}) & \text{if (s.c.-1)} \\ f_{\varepsilon_2, \varepsilon_2, \varepsilon_3}(\Theta_{\varepsilon_2, \varepsilon_2}^+, \Theta_{\varepsilon_2, \varepsilon_3}) \otimes f_{\nu_1, \nu_2, \nu_2}(\Theta_{\nu_1, \nu_2}, \Theta_{\nu_2, \nu_2}^+) & \text{if (s.c.-2)} \\ 0 & \text{otherwise.} \end{cases} \quad (8.2) \end{aligned}$$

We now describe the proof of Equation (8.2). The map $f_{\kappa_1, \dots, \kappa_\ell}$ counts holomorphic ℓ -gons of Maslov index $3 - \ell$. The holomorphic curves map into $(\Sigma \sqcup \Sigma') \times D_\ell$. To define the maps, we pick a family of almost complex structures $(\mathcal{J}_x)_{x \in K_{\ell-1}}$ on $(\Sigma \sqcup \Sigma') \times D_\ell$. Such a family of almost complex structures induces two families, $(J_x)_{x \in K_{\ell-1}}$ and $(J'_x)_{x \in K_{\ell-1}}$, on $\Sigma \times D_\ell$ and $\Sigma' \times D_\ell$, respectively.

The holomorphic polygon map $f_{\kappa_1, \dots, \kappa_\ell}$ on the disjoint union may be equivalently described by counting pairs (u, u') representing pairs of classes of ℓ -gons (ψ, ψ') satisfying $\mu(\psi) + \mu(\psi') = 3 - \ell$, which have the same almost complex structure parameter $x \in K_{\ell-1}$. In particular, we may naturally view the moduli spaces counted by $f_{\kappa_1, \dots, \kappa_\ell}$ as fibered products over the evaluation maps to $K_{\ell-1}$.

Consider the last three lines of (8.2). This equation concerns sequences $\kappa_1 < \dots < \kappa_\ell$ which increment both the \mathbb{E}_n -coordinates and the \mathbb{E}_m -coordinates. Consider a class of ℓ -gons (ψ, ψ') on $(\Sigma \sqcup \Sigma') \times D_\ell$, potentially counted by the ℓ -gon map $f_{\kappa_1, \dots, \kappa_\ell}$. Let k be the number of inputs of ψ which do not increment the \mathbb{E}_n coordinate. Let k' be the number of inputs of ψ' which do not increment the \mathbb{E}_m -coordinate. By Lemma 8.2, if (ψ, ψ') has a representative, we must have

$$\mu(\psi) \geq \min(3 - \ell + k, 0) \quad \text{and} \quad \mu(\psi') \geq \min(3 - \ell + k', 0), \quad (8.3)$$

because each input of ψ which does not increase the \mathbb{E}_n -coordinate contributes a top degree generator in a pair of translated curves as input. Since $\mu(\psi) + \mu(\psi') = 3 - \ell$, by

assumption, for a holomorphic representative to exist we must have

$$\min(3 - \ell + k, 0) + \min(3 - \ell + k', 0) \leq 3 - \ell.$$

Adding $2(\ell - 3)$ to both sides, we obtain

$$\min(k, \ell - 3) + \min(k', \ell - 3) \leq \ell - 3. \quad (8.4)$$

On the other hand, there are $\ell - 1$ total inputs to the map $f_{\kappa_1, \dots, \kappa_\ell}$, and each input increments either \mathbb{E}_n or \mathbb{E}_m , but not both (by definition of $\mathcal{L}_\beta \otimes \mathcal{L}_{\beta'}$). Hence $k + k' = \ell - 1$. In light of (8.4) it is not possible that both $k \leq \ell - 3$ and $k' \leq \ell - 3$. Hence, assume without loss of generality that $k \geq \ell - 3$. So the inequality becomes

$$\min(k', \ell - 3) \leq 0,$$

which implies that either $k' = 0$ or $\ell = 3$. The case that $\ell = 3$ correspond to the cases (s.c.-1) and (s.c.-2). The stated formulas are clearly the only possibilities.

The final line of (8.2) corresponds to the case that $k > 0$, $k' > 0$ and $\ell > 3$. The stated equality follows since no curves contribute, by the above index argument.

The first and second lines of (8.2) correspond to the cases that (k, k') is $(\ell - 1, 0)$ or $(0, \ell - 1)$ and $\ell > 3$. It remains to establish the formula. Consider the case that $k = 0$ and $k' = \ell - 1$. In this case, the holomorphic curve count occurs on the diagram

$$(\Sigma, \beta_{\varepsilon_1}, \dots, \beta_{\varepsilon_\ell}, \mathbf{w}, \mathbf{z}) \sqcup (\Sigma', \beta'_{\nu}, \dots, \beta'_{\nu}, \mathbf{w}', \mathbf{z}'),$$

(where the ℓ curves on the right-hand diagram are small translates). By (8.3), we are interested in representatives of a pair (ψ, ψ') with $\mu(\psi) = 3 - \ell$ and $\mu(\psi') = 0$.

If $\psi' \in \pi_2(\Theta_{\nu, \nu}^+, \dots, \Theta_{\nu, \nu}^+, \mathbf{z})$, the Maslov grading formula for the absolute grading implies that

$$\mu(\psi') = n_{\mathbf{w}'}(\psi') + \text{gr}_{\mathbf{w}'}(\Theta_{\nu, \nu}^+, \mathbf{z}).$$

Since $\mu(\psi') = 0$, we conclude that $n_{\mathbf{w}'}(\psi') = 0$ and $\mathbf{z} = \Theta_{\nu, \nu}^+$.

The parametrized moduli space

$$\bigcup_{x \in K_{\ell-1}} \mathcal{M}_{J_x}(\psi) \times \{x\}$$

has dimension 0, while $\bigcup_{x \in K_{\ell-1}} \mathcal{M}_{J_x}(\psi) \times \{x\}$ has the same dimension as $K_{\ell-1}$. As the moduli space on the disjoint union is the fibered product under the evaluation map to $K_{\ell-1}$, it suffices to show that the map

$$\text{ev}: \bigcup_{\substack{\psi \in \pi_2(\Theta_{\nu, \nu}^+, \dots, \Theta_{\nu, \nu}^+) \\ \mu(\psi) = 0 \\ x \in K_{\ell-1}}} \mathcal{M}_{J_x}(\psi) \rightarrow K_{\ell-1}$$

has odd degree. (Compare [LOT16, Lemma 3.50]) This is proven by considering the preimage of a path $\gamma: [0, 1] \rightarrow K_{\ell-1}$, such that $\gamma(0) = x$, $\gamma(t) \in \text{int } K_{\ell-1}$ for $t \in [0, 1)$ and $\gamma(1)$ is a point in $\partial K_{\ell-1}$ which realizes a degeneration of a holomorphic ℓ -gon into $\ell - 2$ triangles (i.e. a point in the lowest dimensional boundary strata of $K_{\ell-1}$). The codimension 1 degenerations along the image of $(0, 1)$ under γ consist of index 1 holomorphic disks breaking off. The holomorphic disks which break off in the input directions cancel in pairs, since each $\Theta_{\nu, \nu}^+$ is a cycle. There are no disks which bubble off in the output, since they would leave an index -1 ℓ -gon in $\pi_2(\Theta_{\nu, \nu}^+, \dots, \Theta_{\nu, \nu}^+, \mathbf{y})$, for some \mathbf{y} , as well as an index 1 disk $\phi \in \pi_2(\mathbf{y}, \Theta_{\nu, \nu}^+)$ with $n_{\mathbf{w}}(\phi) = 0$. The existence of

such a degeneration would imply that $gr(\gamma; \dagger) = 1$, which is impossible since there are no generators with grading higher than \dagger .

The cardinality of the limit at $t = 1$ corresponds to the component of \dagger in the $\ell - 2$ fold composition of maps of the form $\circ; \circ; \circ(\dagger; \dagger)$, applied to the element \dagger (e.g. by the grading preserving invariance of the Heegaard Floer complex of connected sums of $S^1 \times S^2$). Clearly this is 1, mod 2. This establishes the first line of (8.2). The second line follows from the same reasoning, establishing Equation (8.2), and completing the proof.

We are now able to prove Proposition 8.1:

Proof of part (2) Proposition 8.1. The proof is in the same spirit as part (1) of the proposition. If $(\dagger; \dagger) < (\dagger^0; \dagger^0)$ are points in E_{n+m} , then the hypercube map from $(\dagger; \dagger)$ to $(\dagger^0; \dagger^0)$ in

$$CF(\dagger; \dagger, [\dagger^0; \dagger^0; L \times L \dagger^0; w [w^0]) \tag{8.5}$$

is obtained by summing over all increasing sequences

$$(\dagger; \dagger) = (\dagger_1; \dagger_1) < \dots < (\dagger; \dagger) = (\dagger^0; \dagger^0)$$

the holomorphic $(\ell + 1)$ -gon map which has special inputs from $L \times L \dagger^0$. We say such a sequence is mixed if $\dagger < \dagger^0$ and $\dagger > \dagger^0$. We claim that in the pairing of the two hypercubes of attaching curves, mixed sequences make trivial contribution. This is an approximation argument similar to part (1) of the Proposition, as we now describe.

We recall that $L \times L \dagger^0$ has no mixed arrows which are assigned non-zero chain. Hence we may consider only broken arrow paths in E_{n+m} where each individual arrow increases exactly one of the E_n or E_m coordinates. For such a sequence of length $\ell - 1$, let k be the number of arrows which do not increase the E_n coordinate, and let k^0 be the number of arrows which do not increase the E_m coordinate. In our present situation, $k + k^0 = \ell - 1$. The contribution of this arrow path is a count of holomorphic $(\ell + 1)$ -gons, with $\ell - 1$ special inputs from the hypercube $L \times L \dagger^0$, and one input from $CF(\dagger; \dagger, [\dagger^0; \dagger^0])$. Suppose $(\dagger; \dagger)$ is a homology class which could potentially contribute. By construction, $(\dagger) + (\dagger^0) = 2 \dagger$. Equation (8.3) implies that

$$(\dagger) \leq \min(2 \dagger + k; 0) \text{ and } (\dagger^0) \leq \min(2 \dagger + k^0; 0);$$

so

$$\min(2 \dagger + k; 0) + \min(2 \dagger + k^0; 0) \leq 2 \dagger;$$

and hence

$$\min(k; \dagger - 2) + \min(k^0; \dagger - 2) \leq \dagger - 2;$$

Similar to the argument from part (1), the only allowable configurations are $(k; k^0) \in \{(\ell - 1; 0); (0; \ell - 1)\}$. This implies that there are no mixed arrows in the hypercube of (8.5).

It remains to verify that the non-mixed arrows of (8.5) coincide with the tensor product differential. Arguing similarly to the proof of part (1), it suffices to show that if $x \in T \setminus T^*$, then the map

$$ev: \int_{\substack{2 \times 2(x; \dagger_1, \dots, \dagger_\ell; y) \\ (\dagger) = 0 \\ x \in T^*}} M_{J_x}(\dagger) \rightarrow K^*$$

is odd degree if \mathbf{y} is the canonical nearest point to \mathbf{x} , $\mathbf{y} = \mathbf{x}_{np}$, and is even degree otherwise. Similarly to part (1), we consider the preimage of a path $\gamma: [0, 1] \rightarrow K_\ell$, which connects a generic $x \in \text{int } K_\ell$ to a point in ∂K_ℓ of maximal codimension. The only possible generic degenerations on the interior consist of an index 1 disk breaking off. Disks breaking off at the $\Theta_{\varepsilon, \varepsilon}^+$ inputs cancel in pairs. Index 1 disks breaking off at the \mathbf{x} input or the \mathbf{y} output are impossible, since they leave an index -1 $(\ell + 1)$ -gon which has $\ell - 1$ inputs equal to the top degree generator, whose existence would violate Lemma 8.2. Hence, we identify the preimage over x with the preimage of $\gamma(1)$. By the nearest point map argument of Lemma 8.4, the count is odd if and only if $\mathbf{y} = \mathbf{x}_{np}$, completing the proof. \square

9. CONNECTED SUMS AND HYPERCUBES

In this section, we prove a connected sum formula for hypercubes of attaching curves.

Definition 9.1. Suppose that $\mathcal{H} = (\Sigma, \boldsymbol{\alpha}, \boldsymbol{\beta}, \mathbf{w}, \mathbf{z})$ and $\mathcal{H}' = (\Sigma', \boldsymbol{\alpha}', \boldsymbol{\beta}', \mathbf{w}', \mathbf{z}')$ are two multi-pointed, link-minimal Heegaard diagrams for links in 3-manifolds. We require (for notation) that the free basepoints are in $\mathbf{w} \cup \mathbf{w}'$. We say a diagram $\mathcal{H} \# \mathcal{H}' = (\Sigma \# \Sigma', \boldsymbol{\alpha} \cup \boldsymbol{\alpha}', \boldsymbol{\beta} \cup \boldsymbol{\beta}', \mathbf{w}'', \mathbf{z}'')$ is an *admissible connected sum* of \mathcal{H} and \mathcal{H}' if it is formed via one of the following two procedures (possibly with the roles of \mathcal{H} and \mathcal{H}' reversed):

- (1) (Connected sum at a free-basepoint) The connected sum is taken at a free basepoint $w \in \mathbf{w}$, and at some point $p \in \Sigma' \setminus (\boldsymbol{\alpha}' \cup \boldsymbol{\beta}' \cup \mathbf{w}' \cup \mathbf{z}')$. The basepoints are $\mathbf{w}'' = \mathbf{w} \setminus \{w\} \cup \mathbf{w}'$ and $\mathbf{z}'' = \mathbf{z} \cup \mathbf{z}'$.
- (2) (Connected sum along link components) The connected sum is taken at two link basepoints $w \in \mathbf{w}$ and $z' \in \mathbf{z}'$. The basepoints are $\mathbf{w}'' = \mathbf{w} \setminus \{w\} \cup \mathbf{w}'$ and $\mathbf{z}'' = \mathbf{z} \cup \mathbf{z}' \setminus \{z'\}$.

Remark 9.2. In the above definition of an admissible connected sum, the alpha and beta curves only role is that they determine which basepoints are free-basepoints and which are link-basepoints. In particular, we may also define the admissible connected sum of two multi-pointed surfaces $(\Sigma, \mathbf{w}, \mathbf{z})$ and $(\Sigma', \mathbf{w}', \mathbf{z}')$, as long as we designate which basepoints are free and which ones are on a link component.

Suppose that \mathcal{L}_β and $\mathcal{L}_{\beta'}$ are hypercubes of handleslide equivalent attaching curves on the multi-pointed surfaces $(\Sigma, \mathbf{w}, \mathbf{z})$ and $(\Sigma', \mathbf{w}', \mathbf{z}')$, respectively. Write $n = \dim \mathcal{L}_\beta$ and $m = \dim \mathcal{L}_{\beta'}$. Suppose also that \mathcal{L}_β and $\mathcal{L}_{\beta'}$ are algebraically rigid (Definition 7.4). In this case, the length 1 chains of \mathcal{L}_β and $\mathcal{L}_{\beta'}$ are uniquely determined, and there can be no higher length chains.

Suppose that we form an admissible connected sum $(\Sigma \# \Sigma', \mathbf{w}'', \mathbf{z}'')$ from the pointed surfaces $(\Sigma, \mathbf{w}, \mathbf{z})$ and $(\Sigma', \mathbf{w}', \mathbf{z}')$. We may construct a hypercube-shaped diagram of attaching curves $\mathcal{L}_\beta \otimes \mathcal{L}_{\beta'}$ via the same procedure as on the disjoint union of the two diagrams in Section 7.2. (Note that we do not claim that the hypercube relations are satisfied).

Remark 9.3. If \mathcal{L}_β and $\mathcal{L}_{\beta'}$ are algebraically rigid, then the top degree chains coincide on disjoint unions of diagrams and admissible connected sums, justifying the use of the notation $\mathcal{L}_\beta \otimes \mathcal{L}_{\beta'}$ for both situations. Also, if \mathcal{L}_β and $\mathcal{L}_{\beta'}$ are algebraically rigid, then $\mathcal{L}_\beta \otimes \mathcal{L}_{\beta'}$ is automatically a hypercube of attaching curves.

The main result of this section is the following:

Proposition 9.4. *Suppose that \mathcal{L}_β and $\mathcal{L}_{\beta'}$ are algebraically rigid hypercubes of handleslide equivalent attaching curves on $(\Sigma, \mathbf{w}, \mathbf{z})$ and $(\Sigma', \mathbf{w}', \mathbf{z}')$, respectively. Suppose that $\mathcal{L}_\beta \otimes \mathcal{L}_{\beta'}$ is formed by an admissible connected sum of the two hypercubes. Then there is a natural homotopy equivalence of hypercubes*

$$CF^-(\Sigma \# \Sigma', \alpha \cup \alpha', \mathcal{L}_\beta \otimes \mathcal{L}_{\beta'}, \mathbf{w}'', \mathbf{z}'') \simeq CF^-(\Sigma, \alpha, \mathcal{L}_\beta, \mathbf{w}, \mathbf{z}) \otimes_R CF^-(\Sigma', \alpha', \mathcal{L}_{\beta'}, \mathbf{w}', \mathbf{z}').$$

In the above, $R = \mathbb{F}[\mathcal{U}]$ if the connected sum is along a free basepoint, and $R = \mathbb{F}[\mathcal{U}, \mathcal{V}]$ is the connected sum is along a link component.

Unlike in Section 8, the homotopy equivalence of Proposition 9.4 is not given by the identity map on the level of groups. Instead it involves counting holomorphic curves.

9.1. Cylindrical boundary degenerations. In this section, we recall some important facts about boundary degenerations.

Definition 9.5. Suppose β is a set of attaching curves on (Σ, \mathbf{w}) , and $\mathbf{x} \in \mathbb{T}_\beta$. A *cylindrical beta boundary degeneration* at \mathbf{x} consists of a tuple (u, S, j) such that (S, j) is a Riemann surface and

$$u: (S, \partial S) \rightarrow (\Sigma \times [0, \infty) \times \mathbb{R}, \beta \times \{0\} \times \mathbb{R})$$

is a map satisfying the following:

- (1) u is (j, J) -holomorphic.
- (2) u is proper.
- (3) For each $t \in \mathbb{R}$ and $i \in \{1, \dots, g(\Sigma) + |\mathbf{w}| - 1\}$, the set $u^{-1}(\beta_i \times \{0\} \times \{t\})$ consists of a single point.
- (4) u has finite energy.
- (5) $\pi_{\mathbb{H}} \circ u$ is non-constant on each component of S , where $\mathbb{H} = [0, \infty) \times \mathbb{R}$.
- (6) S has a collection of $n = g(\Sigma) + |\mathbf{w}| - 1$ boundary punctures p_1, \dots, p_n . If $\mathbf{x} = (x_1, \dots, x_n)$, where $x_i \in \beta_i$, then

$$\lim_{z \rightarrow p_i} (\pi_{\mathbb{H}} \circ u)(z) = \infty \quad \text{and} \quad \lim_{z \rightarrow p_i} (\pi_\Sigma \circ u)(z) = x_i.$$

Cylindrical alpha boundary degenerations are defined by analogy. Of fundamental importance is the mod 2 count of boundary degenerations.:

Proposition 9.6. *Suppose β is a set of attaching curves on (Σ, \mathbf{w}) , and B is a Maslov index 2 class of boundary degenerations. For an appropriate choice of almost complex structures on $\Sigma \times [0, \infty) \times \mathbb{R}$, the moduli space of boundary degenerations $\mathcal{N}(B, \mathbf{x})$ is transversely cut out. Furthermore, the parametrized moduli space*

$$\bigcup_{\mathbf{x} \in \mathbb{T}_\beta} \mathcal{N}(B, \mathbf{x}) \times \{\mathbf{x}\}$$

is also transversely cut out. Furthermore

$$\#\mathcal{N}(B, \mathbf{x}) / \text{Aut}(\mathbb{H}) \equiv 1.$$

The case when $|\mathbf{w}| > 1$ is proven by Ozsváth and Szabó [OS08a, Theorem 5.5]. Ozsváth and Szabó also proved that if $|\mathbf{w}| = 1$ there are generically no boundary degenerations for split almost complex structures on $\Sigma \times [0, \infty) \times \mathbb{R}$. However for their boundary degenerations, the parametrized moduli space $\bigcup_{\mathbf{x} \in \mathbb{T}_\beta} \mathcal{N}(B, \mathbf{x}) \times \{\mathbf{x}\}$ might in

general be non-empty, and there are always broken boundary degenerations at which transversality is not achieved (e.g. the union of a closed curve representing Σ and a constant disk at \mathbf{x}). This is sufficient for showing that $\partial^2 = 0$, but is not sufficient for our purposes. The $|\mathbf{w}| = 1$ case was revisited in [HHSZ20, Section 7.6], where it was shown that for appropriately generic choices of almost complex structure, the count of Proposition 9.6 holds.

9.2. Warm up: Connected sums and Floer complexes. In this section, we present the proof of Proposition 9.4 in the case that \mathcal{L}_β and $\mathcal{L}_{\beta'}$ are both 0-dimensional (i.e. we recover the standard connected sum formula of Ozsváth and Szabó [OS04c]). The analytic details we present here will be the basis of the higher dimensional cases of Proposition 9.4, which we consider in the subsequent section. Our argument is inspired by work of Ozsváth and Szabó in the bordered setting [OS19]. See also [HHSZ20, Section 19.4].

Suppose $\mathcal{H} = (\Sigma, \alpha, \beta, \mathbf{w}, \mathbf{z})$ and $\mathcal{H}' = (\Sigma', \alpha', \beta', \mathbf{w}', \mathbf{z}')$ are multi-pointed diagrams, and suppose that J and J' are almost complex structures on $\Sigma \times [0, 1] \times \mathbb{R}$ and $\Sigma' \times [0, 1] \times \mathbb{R}$, respectively. The notation $J \wedge J'$ means the data of the pair J and J' together with distinguished connected sum points, $p \in \Sigma$ and $p' \in \Sigma'$. We assume that the connected sum is admissible, in the sense of Definition 9.1.

For notational simplicity, we focus on the case where we have just one \mathcal{U} variable, and one \mathcal{V} variable. The first step is to do a neck-stretching degeneration along the connected sum tube. The result of this degeneration is a chain complex, freely generated over the ground ring $R = \mathbb{F}[\mathcal{U}, \mathcal{V}]$ by pairs $\mathbf{x} \times \mathbf{x}'$, where $\mathbf{x} \in \mathbb{T}_\alpha \cap \mathbb{T}_\beta$ and $\mathbf{x}' \in \mathbb{T}_{\alpha'} \cap \mathbb{T}_{\beta'}$. The differential is given by the formula

$$\partial_{J \wedge J'}(\mathbf{x} \times \mathbf{x}') = \sum_{\substack{\mathbf{y} \times \mathbf{y}' \in (\mathbb{T}_\alpha \cap \mathbb{T}_\beta) \times (\mathbb{T}_{\alpha'} \cap \mathbb{T}_{\beta'}) \\ \phi \in \pi_2(\mathbf{x}, \mathbf{y}) \\ \phi' \in \pi_2(\mathbf{x}', \mathbf{y}') \\ n_p(\phi) = n_{p'}(\phi') \\ \mu(\phi) + \mu(\phi') - 2n_p(\phi) = 1}} \#(\mathcal{M}\mathcal{M}(\phi, \phi')/\mathbb{R}) \cdot \mathcal{U}^{n_{\mathbf{w}''}(\phi + \phi')} \mathcal{V}^{n_{\mathbf{z}''}(\phi + \phi')} \cdot \mathbf{y} \times \mathbf{y}' \quad (9.1)$$

where $\mathcal{M}\mathcal{M}(\phi, \phi')$ is the *perfectly matched moduli space*, consisting of pairs (u, u') satisfying the following matching condition. In the following, we write $(S^{\mathbf{q}}, j)$ and $(T^{\mathbf{q}'}, j')$ for the sources curves of u and u' , where (S, j) and (T, j') are Riemann surfaces, and \mathbf{q} and \mathbf{q}' are ordered collections of $n_p(\phi) = n_{p'}(\phi)$ marked points, for which we write $\mathbf{q} = \{q_1, \dots, q_n\}$ and $\mathbf{q}' = \{q'_1, \dots, q'_n\}$. We define

$$\mathcal{M}\mathcal{M}_{J \wedge J'}(\phi, \phi') := \left\{ (u, u') \left| \begin{array}{l} u \text{ is } J\text{-holomorphic} \\ u' \text{ is } J'\text{-holomorphic} \\ (\pi_\Sigma \circ u)(q_i) = p, (\pi_{\Sigma'} \circ u')(q'_i) = p' \\ (\pi_{\mathbb{D}} \circ u)(q_i) = (\pi_{\mathbb{D}} \circ u')(q'_i) \end{array} \right. \right\}. \quad (9.2)$$

It is not hard to see that this gives a chain complex, which we denote by $CF_{J \wedge J'}^-(\mathcal{H}, \mathcal{H}')$. (Compare [HHSZ20, Section 19.4]). The construction is inspired by the matched moduli spaces which appear in [LOT18, Section 9.1].

If I is a (non-singular) almost complex structure on $\Sigma \# \Sigma' \times [0, 1] \times \mathbb{R}$, then one may define a chain homotopy equivalence

$$CF_I^-(\mathcal{H} \# \mathcal{H}') \simeq CF_{J \wedge J'}^-(\mathcal{H}, \mathcal{H}')$$

by counting index 0 curves for a non-cylindrical almost complex structure on $\Sigma \# \Sigma' \times [0, 1] \times \mathbb{R}$ which interpolates an ordinary cylindrical almost complex structure on $\Sigma \# \Sigma' \times [0, 1] \times (-\infty, t_1]$, and a degenerate almost complex structure (i.e. one with infinite neck length) on $\Sigma \wedge \Sigma' \times [0, 1] \times [t_2, \infty)$, for some $t_1 \ll 0$ and $t_2 \gg 0$. See [HHSZ20, Section 19.4] for more details.

We now describe a chain homotopy equivalence

$$\Phi: CF_{J \wedge J'}^-(\mathcal{H}, \mathcal{H}') \rightarrow CF_J^-(\mathcal{H}) \otimes_R CF_{J'}^-(\mathcal{H}').$$

If $t \in \mathbb{R}$, write

$$\lambda_t := [0, 1] \times \{t\} \subseteq [0, 1] \times \mathbb{R}.$$

Let us write

$$s: \Sigma \times [0, 1] \times \mathbb{R} \rightarrow [0, 1] \quad \text{and} \quad t: \Sigma \times [0, 1] \times \mathbb{R} \rightarrow \mathbb{R}$$

for the projection maps.

Definition 9.7. Suppose $t_0 \in \mathbb{R}$. A (Φ, t_0) -matched $J \wedge J'$ -holomorphic curve pair consists of a pair of marked $J \wedge J'$ holomorphic disks (u, u') , equipped with the following data:

- (1) A partition of the marked points of u (resp. u') into three sets, \mathbf{S} , \mathbf{C} and \mathbf{N} (resp. \mathbf{S}' , \mathbf{C}' and \mathbf{N}').
- (2) A bijection $\phi: \mathbf{S} \rightarrow \mathbf{S}'$.

We assume the following are satisfied:

- (1) If q_i is a marked point of u , then $(\pi_{\mathbb{D}} \circ u)(q_i) = p$, and similarly for all marked points of u'
- (2) If $q \in \mathbf{S}$ and $q' \in \mathbf{S}'$ and $\phi(q) = q'$, then

$$(t \circ u)(q) = (t \circ u')(q') < 0 \quad \text{and} \quad (s \circ u)(q) = (s \circ u')(q')$$

- (3) If $q \in \mathbf{N}$ then $(t \circ u)(q) > t_0$. The analogous statement holds for $q' \in \mathbf{N}'$.
- (4) $|\mathbf{C}| = |\mathbf{C}'|$. Furthermore, if $q \in \mathbf{C}$ then $(t \circ u)(q) = t_0$, and similarly for the marked points of \mathbf{C}' . The marked points of \mathbf{C} and \mathbf{C}' alternate between those of \mathbf{C} and those of \mathbf{C}' along λ_{t_0} . Finally, the left-most marked point along this line is contained in \mathbf{C} .

See Figure 9.1 for a schematic of a (Φ, t_0) -matched curve pair.

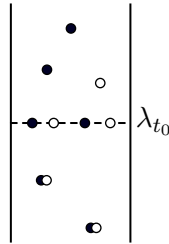

FIGURE 9.1. The projection to $[0, 1] \times \mathbb{R}$ of marked points of a (Φ, t_0) -matched holomorphic curve pair. Solid dots indicate the marked points of u , while open dots are the marked points of u' . The map Ψ counts similar configurations.

If (ϕ, ϕ') are a pair of homology classes, M is a collection of marked source curves for ϕ and ϕ' , and $t_0 \in \mathbb{R}$, we write $\mathcal{MM}^\Phi(\phi, \phi', M, t_0)$ for the moduli space of (Φ, t_0) -matched disks representing ϕ and ϕ' . We consider the parametrized moduli space

$$\mathcal{MM}^\Phi(\phi, \phi', M) = \bigcup_{t_0 \in \mathbb{R}} \mathcal{MM}^\Phi(\phi, \phi', M, t_0) \times \{t_0\}.$$

If t_0 is fixed, the expected dimension of $\mathcal{MM}^\Phi(\phi, \phi', M, t_0)$ is given by the formula

$$\text{ind}(\phi, \phi', M) = \mu(\phi) + \mu(\phi') - 2(|\mathbf{S}| + |\mathbf{C}|).$$

The map Φ counts pairs of curves (u, u') in $\mathcal{MM}^\Phi(\phi, \phi', M)/\mathbb{R}$, ranging over tuples with $\text{ind}(\phi, \phi', M) = 0$. Equivalently, we can think of Φ as counting elements of the non-parametrized moduli spaces $\mathcal{MM}^\Phi(\phi, \phi', M, t_0)$ for some fixed t_0 . (The parametrized perspective becomes helpful later).

Next, we explain the \mathcal{U} and \mathcal{V} weights of a curve. The basepoints not involved in the connected sum contribute powers of variables as normal. The marked points in $\mathbf{S} \cup \mathbf{S}' \cup \mathbf{C} \cup \mathbf{C}'$ contribute algebra elements which are the same as would be counted on the connected sum of the two diagrams, where we have removed any basepoints used for the connected sum. For the marked points in \mathbf{N} and \mathbf{N}' , the algebraic contribution is the same as on the disjoint union of the two diagrams, without the basepoints removed.

Concretely, if the connected sum is formed along a link component, and $p = w \in \mathbf{w}$ and $p' = z' \in \mathbf{z}'$, then the algebra element contributed by the marked points would be

$$\mathcal{U}^{|\mathbf{N}|} \mathcal{V}^{|\mathbf{N}'|}. \tag{9.3}$$

(There would be an additional contributions from the other basepoints not involved in the connected sum). If instead the connected sum is formed at a free basepoint $p = w \in \Sigma$ and some non-basepoint $p' \in \Sigma'$, then the algebra contribution from the marked points would be $\mathcal{U}^{|\mathbf{N}|}$.

We define a similar map

$$\Psi: CF_J^-(\mathcal{H}) \otimes_R CF_{J'}^-(\mathcal{H}') \rightarrow CF_{J \wedge J'}^-(\mathcal{H}, \mathcal{H}')$$

by counting holomorphic curves with similar conditions, but with the roles of the \mathbf{S} and \mathbf{N} labeled marked points switched.

Remark 9.8. Constant disks are counted by both Φ and Ψ .

Lemma 9.9. *The maps Φ and Ψ are chain maps.*

Proof. We focus on Φ since the argument for Ψ is not substantially different. Our proof is modeled on work of Ozsváth and Szabó in the setting of bordered knot Floer homology [OS19]. The proof is to count the ends of (Φ, t_0) -matched moduli spaces for triples (ϕ, ϕ', M) with $\text{ind}(\phi, \phi', M) = 1$. Modulo the \mathbb{R} -action on the parametrized moduli space, such moduli spaces are 1-dimensional. In the present situation, it is sufficient to fix $t_0 = 0$, and consider only $(\Phi, 0)$ -matched holomorphic curves. The ends are constrained generically to the following configurations:

- (Φ -1) Two paired marked points in \mathbf{S} and \mathbf{S}' may collide with the line λ_0 , away from the marked points in \mathbf{C} and \mathbf{C}' .
- (Φ -2) A pair of punctures in \mathbf{C} and \mathbf{C}' may collide along λ_0 .
- (Φ -3) A puncture of \mathbf{N} or \mathbf{N}' may collide with λ_0 (in the complement of \mathbf{C} and \mathbf{C}').
There are two subcases:

- (a) After the degeneration, the marked points along λ_0 do not alternate between those of u and u' .
- (b) After the degeneration, the marked points along λ_0 do alternate between those of u and u' .
- (Φ -4) A puncture of \mathbf{C} may degenerate into an index 2 beta boundary degeneration at height $t = 0$.
- (Φ -5) A puncture of \mathbf{C}' may degenerate into an index 2 alpha boundary degeneration at height $t = 0$.
- (Φ -6) Strip breaking may occur, leaving a $(\Phi, 0)$ -matched disk of index 0 as well as a holomorphic disk of index 1 in either positive or negative direction. There are two subcases:
 - (a) The index 1 holomorphic disk degenerates towards $-\infty$, and is perfectly-matched.
 - (b) The index 1 holomorphic disk degenerates towards $+\infty$, and has trivial matching (i.e. the projections of all marked points to $[0, 1] \times \mathbb{R}$ are distinct).

Most of these ends appear in canceling pairs, and the rest correspond to the relation $[\partial, \Phi] = 0$, as we describe presently.

The ends (Φ -1) cancel with the ends (Φ -2).

In an end of type (Φ -3a), there are two adjacent marked points along λ_0 which are both from u or both from u' . Such a curve appears twice in the boundary of the moduli spaces. See Figure 9.2.

The ends of type (Φ -3b) cancel with the end of type (Φ -4) and (Φ -5). Here we are using the mod 2 count of boundary degenerations from Proposition 9.6. Note also the algebra contributions coincide for the two canceling degenerations of type (Φ -3b) and type (Φ -4) or (Φ -5) (cf. equation (9.3)). If the connected sum is taken along a link component, each boundary degeneration which forms along λ_{t_0} will contain one puncture from $\mathbf{C} \cup \mathbf{C}'$ and also one link basepoint. The degeneration which cancels this boundary degeneration formation consists of a \mathbf{N} or \mathbf{N}' puncture colliding with λ_{t_0} . The algebra weight from the \mathbf{N} or \mathbf{N}' puncture coincides with the weight of the basepoint which is lost in the boundary degeneration. The case of a connected sum at a free-basepoint is similar.

The remaining ends are (Φ -6), which correspond exactly to the commutator $[\partial, \Phi]$. Summing all ends, we conclude that

$$\partial \circ \Phi + \Phi \circ \partial = 0,$$

completing the proof. □

Lemma 9.10. *The maps Φ and Ψ are homotopy inverses.*

Proof. We define two maps H_\wedge and H_\sqcup , which we prove satisfy

$$\text{id} + \Psi \circ \Phi = [\partial, H_\wedge] \quad \text{and} \quad \text{id} + \Phi \circ \Psi = [\partial, H_\sqcup]. \quad (9.4)$$

We focus on the map H_\wedge , since H_\sqcup is constructed by a straightforward modification.

The map H_\wedge counts certain curve pairs (u, u') where u has five collections of marked points, \mathbf{NN} , \mathbf{NC} , \mathbf{M} , \mathbf{SC} and \mathbf{SS} , and u' has five collections of marked points \mathbf{NN}' , \mathbf{NC}' , \mathbf{M}' , \mathbf{SC}' and \mathbf{SS}' .

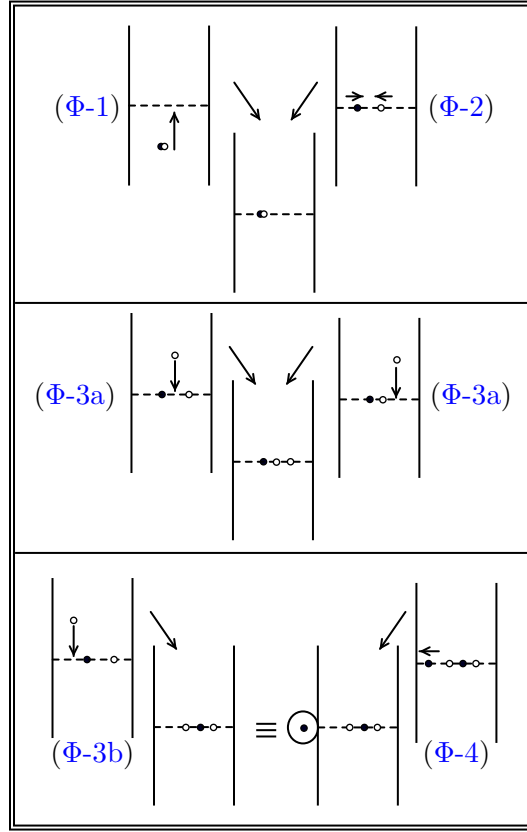

FIGURE 9.2. Some cancellations in the proof that Φ and Ψ are chain maps

Definition 9.11. Suppose that $t_0 < t_1$ are real numbers. We say a pair of marked holomorphic strips (u, u') is (H_\wedge, t_0, t_1) -matched if the following are satisfied:

- (1) The marked points of \mathbf{NN} and \mathbf{NN}' are perfectly matched. Furthermore their projection to \mathbb{R} lies above t_1 .
- (2) The marked points in \mathbf{NC} and \mathbf{NC}' both project to λ_{t_1} . Furthermore, $|\mathbf{NC}| = |\mathbf{NC}'|$. As one travels along λ_{t_1} , the marked points alternate between $|\mathbf{NC}|$ and $|\mathbf{NC}'|$, and the left-most marked point is from \mathbf{NC} , while the right most is from \mathbf{NC}' .
- (3) The marked points of \mathbf{M} and \mathbf{M}' have no matching condition. Their projection to $[0, 1] \times \mathbb{R}$ lies between λ_{t_0} and λ_{t_1} .
- (4) The marked points \mathbf{SC} and \mathbf{SC}' satisfy the same conditions as \mathbf{NC} and \mathbf{NC}' , except that they project to λ_{t_0} .

If (ϕ, ϕ') are two homology classes of disks, equipped with decorated sources and matching data M , and $t_0 < t_1$ are fixed, then the expected dimension of the moduli space of curves which are (H_\wedge, t_0, t_1) -matched and represent (ϕ, ϕ', M) is given by

$$\text{ind}(\phi, \phi', M) = \mu(\phi) + \mu(\phi') - 2|\mathbf{SS}| - 2|\mathbf{NN}| - 2|\mathbf{SC}| - 2|\mathbf{NC}|.$$

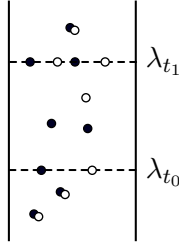
FIGURE 9.3. A (H_\wedge, t) -matched curve pair.

Write $\mathcal{MM}(\phi, \phi', M)$ for this moduli space. The parametrized moduli space

$$\mathcal{MM}(\phi, \phi', M) := \bigcup_{t_0 < t_1} \mathcal{MM}(\phi, \phi', M, t_0, t_1) \times \{(t_0, t_1)\}$$

has a free \mathbb{R} -action, corresponding to overall translation (acting diagonally on t_0 and t_1).

The map H_\wedge counts $\mathcal{MM}(\phi, \phi', M)/\mathbb{R}$ for triples (ϕ, ϕ', M) satisfying $\text{ind}(\phi, \phi', M) = -1$. In this case, the expected dimension of $\mathcal{MM}(\phi, \phi', M)$ is 1.

To verify Equation (9.4), we count the ends of the parametrized moduli spaces $\mathcal{MM}(\phi, \phi', M)/\mathbb{R}$ where $\text{ind}(\phi, \phi', M) = 0$ (so that $\dim \mathcal{MM}(\phi, \phi', M)/\mathbb{R} = 1$).

There are ends which occur at $0 < t_1 - t_0 < \infty$. These are the obvious analogs of the ends in the case of one special line $(\Phi-1), \dots, (\Phi-5)$. They cancel by an identical proof to the case of one special line.

It remains to analyze the curves which appear as $t_1 - t_0 \rightarrow 0$ or $t_1 - t_0 \rightarrow \infty$. The ends which appear as $t_1 - t_0 \rightarrow \infty$ are easy to analyze: they correspond exactly to the composition $\Psi \circ \Phi$. We now focus on the ends which appear as $t_1 - t_0 \rightarrow 0$. These correspond to the lines λ_{t_0} and λ_{t_1} colliding to form a single line, for which we write $\lambda_{t'}$. The limiting curves live in a moduli space of pairs (u, u') where the points of \mathbf{SS} are perfectly matched with \mathbf{SS}' and \mathbf{NN} are perfectly matched to \mathbf{NN}' , and the rest of the marked points are matched to $\lambda_{t'}$. For fixed t' , this moduli space has expected dimension

$$\mu(\phi) + \mu(\phi') - 2|\mathbf{SS}| - 2|\mathbf{NN}| - 2|\mathbf{SC}| - 2|\mathbf{NC}| - |\mathbf{M}| - |\mathbf{M}'|.$$

By assumption, the above quantity is $-|\mathbf{M}| - |\mathbf{M}'|$. The moduli space which is parametrized over all t' has dimension $-|\mathbf{M}| - |\mathbf{M}'| + 1$, but since it also has a free \mathbb{R} action, we conclude that $-|\mathbf{M}| - |\mathbf{M}'| \geq 0$, so $|\mathbf{M}| = |\mathbf{M}'| = 0$.

There are two remaining cases for the curves appearing as $t_1 - t_0 \rightarrow 0$:

$(H_\wedge-1)$ $|\mathbf{SC}| = |\mathbf{NC}| = |\mathbf{SC}'| = |\mathbf{NC}'| = 0$.

$(H_\wedge-2)$ At least one of $|\mathbf{SC}|, |\mathbf{NC}|, |\mathbf{SC}'|, |\mathbf{NC}'|$ is non-empty.

For the ends $(H_\wedge-1)$, there are no marked points along the special line and the limiting curve pair (u, u') is perfectly matched, similar to the curves counted by $\partial_{J_\wedge J'}$ in Equation (9.1), except (u, u') has index 0 (i.e. the expected dimension, ignoring the special line is 0). Using transversality and expected dimension counts, we see that u and u' must both represent the constant class. These ends contribute $\text{id}_{CF_{J_\wedge J'}^-(\mathcal{H}, \mathcal{H}')} to the left equation of (9.4).$

We now consider the ends labeled $(H_{\wedge-2})$. We claim that these appear in canceling pairs. Indeed, each such end appears with even multiplicity, corresponding to switching the roles of \mathbf{NC} and \mathbf{SC} , and switching \mathbf{NC}' and \mathbf{SC}' (i.e. having the special lines pass through each other). See Figure 9.4.

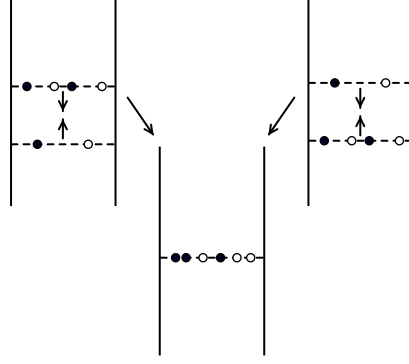

FIGURE 9.4. The cancellation of the ends labeled $(H_{\wedge-2})$.

The construction of the homotopy H_{\cup} is defined via the obvious modification, and a similar analysis goes through to establish the right equation of (9.4). \square

9.3. Connected sums and hypercubes. We now extend the work of the previous section to handle the more general case of hypercubes of dimension greater than 0. We focus on the case that we have fixed alpha curves $\alpha \subseteq \Sigma$ and $\alpha' \subseteq \Sigma'$, as well as hypercubes \mathcal{L}_{β} and $\mathcal{L}_{\beta'}$ of handleslide equivalent beta curves, which are algebraically rigid.

Similar to the setting of ordinary Floer complexes in Section 9.2, it is straightforward to construct a neck-stretching homotopy equivalence

$$CF_I^-(\Sigma \# \Sigma', \alpha \cup \alpha', \mathcal{L}_{\beta} \otimes \mathcal{L}_{\beta'}) \simeq CF_{J \wedge J'}^-(\Sigma \wedge \Sigma', \alpha \cup \alpha', \mathcal{L}_{\beta} \otimes \mathcal{L}_{\beta'}).$$

The construction is essentially the same as the construction of a homotopy equivalence of hypercubes for changing the almost complex structure. Compare [HHSZ20, Section 14.2].

The goal of this section is to describe a homotopy equivalence of hypercubes

$$\Phi: CF_{J \wedge J'}^-(\Sigma \wedge \Sigma', \alpha \cup \alpha', \mathcal{L}_{\beta} \otimes \mathcal{L}_{\beta'}) \rightarrow CF_{J, J'}^-(\Sigma \sqcup \Sigma', \alpha \cup \alpha', \mathcal{L}_{\beta} \otimes \mathcal{L}_{\beta'}).$$

In the domain of Φ , the curves counted are perfectly-matched. In codomain, the curves have trivial matching (i.e. they are counted in the normal way for disconnected Heegaard surfaces, as in Section 8.2). The map Φ is an extension of the map defined in the previous section, which we describe momentarily. Note that by Proposition 8.1, the codomain of Φ is homotopy equivalent to the tensor product of $CF_J^-(\Sigma, \alpha, \mathcal{L}_{\beta})$ and $CF_{J'}^-(\Sigma', \alpha', \mathcal{L}_{\beta'})$, if the hypercube $\mathcal{L}_{\beta} \otimes \mathcal{L}_{\beta'}$ is constructed with sufficiently small Hamiltonian translations.

Similar to the case of connected sums, we will define the map Φ to count holomorphic polygons with a special line.

To simplify the exposition and notation, it is helpful to establish a few conventions. Firstly, we recall that the holomorphic ℓ -gon maps require a choice of a family of almost

complex structures $(J_x)_{x \in K_{\ell-1}}$. The space $K_{\ell-1}$ may be identified with the moduli space of disks with ℓ marked points along its boundary. For the sake of notation, it is more convenient to consider the moduli space of $\ell - 2$ marked points along the line

$$\{0\} \times \mathbb{R} \subseteq [0, 1] \times \mathbb{R}.$$

Overall translation by the \mathbb{R} -action gives equivalent elements in the moduli space. For our purposes, it is actually more convenient to not initially quotient by this action, and consider a family of almost complex structures $(J_{x,\tau})_{(x,\tau) \in K_{\ell-1} \times \mathbb{R}}$. Let T_r denote translation of the \mathbb{R} component of $\Sigma \times [0, 1] \times \mathbb{R}$ by r units. We require that

$$J_{x,\tau} = (T_r^*)(J_{x,\tau+r}),$$

for each $x \in K_{\ell-1}$, and $\tau, r \in \mathbb{R}$. Note that this does *not* imply that each $J_{x,\tau}$ is translation invariant under the \mathbb{R} -action on $[0, 1] \times \mathbb{R}$.

With this convention, the normal ℓ -gon counting maps can be viewed as counting the 1-dimensional parametrized moduli spaces

$$\bigcup_{(x,\tau) \in K_{\ell-1} \times \mathbb{R}} \mathcal{M}_{J_x}(\psi) \times \{(x, \tau)\},$$

modulo their free \mathbb{R} -action.

If $t_0 \in \mathbb{R}$, the notion of a (Φ, t_0) -matched pair of $(\ell + 1)$ -gons is easily adapted from Definition 9.7. (Note that we define the map Φ , the indexing is somewhat more natural if we count $(\ell + 1)$ -gons than ℓ -gons). Here, t_0 denotes the height of the special line, where the marked points \mathbf{C} and \mathbf{C}' are matched. If (ψ, ψ', M) is a triple consisting of two homology classes of $(\ell + 1)$ -gons, and M is a pair of decorated source curves and matching data, and $(x, \tau) \in K_{\ell} \times \mathbb{R}$ and $t_0 \in \mathbb{R}$ is fixed, then the expected dimension of the moduli space of (Φ, t_0) -matched $(\ell + 1)$ -gons, denoted $\mathcal{MM}_{J_{x,\tau}}^{\Phi}(\psi, \psi', M, t_0)$, is given by

$$\text{ind}(\psi, \psi', M) = \mu(\psi) + \mu(\psi') - 2|\mathbf{S}| - 2|\mathbf{C}|.$$

This is because the moduli space with $J_{x,\tau}$ fixed but with no puncture constraints has expected dimension $\mu(\psi) + \mu(\psi')$, and the perfect matching below t_0 and the matching along the special line give a codimension $2(|\mathbf{S}| + |\mathbf{C}|)$ constraint.

If $J = (J_{(x,\tau)})_{(x,\tau) \in K_{\ell} \times \mathbb{R}}$ is a family, we define the parametrized moduli space

$$\mathcal{MM}_J^{\Phi}(\psi, \psi', M) = \bigcup_{\substack{(x,\tau) \in K_{\ell} \times \mathbb{R} \\ t_0 \in \mathbb{R}}} \mathcal{MM}_{J_{(x,\tau)}}^{\Phi}(\psi, \psi', M, t_0) \times \{(x, \tau, t_0)\},$$

which has expected dimension

$$e \dim \mathcal{MM}_J^{\Phi}(\psi, \psi', M) = \text{ind}(\psi, \psi', M) + \ell, \quad (9.5)$$

and has a free \mathbb{R} -action.

We now define our hypercube morphism Φ . If $\kappa \leq \kappa'$ and $\kappa, \kappa' \in \mathbb{E}_{n+m}$, we define the component $\Phi_{\kappa \rightarrow \kappa'}$ of Φ as follows. If $\kappa = \kappa' = (\varepsilon, \nu)$, then the map

$$\Phi_{\kappa \rightarrow \kappa'}: CF_{J \wedge J'}^-(\Sigma \wedge \Sigma', \alpha \cup \alpha', \beta_{\varepsilon} \cup \beta'_{\nu}) \rightarrow CF_{J, J'}^-(\Sigma \sqcup \Sigma', \alpha \cup \alpha', \beta_{\varepsilon} \cup \beta'_{\nu})$$

is the tensor product map defined in Section 9.2.

If $\kappa_1 < \dots < \kappa_\ell$ is an increasing sequence of points in \mathbb{E}_{n+m} , then we write $\kappa_j = (\varepsilon_j, \nu_j)$ and we define a map

$$\varphi_{\kappa_1 < \dots < \kappa_\ell}: CF^-(\Sigma \wedge \Sigma', \alpha \cup \alpha', \beta_{\varepsilon_1} \cup \beta'_{\nu_1}) \rightarrow CF^-(\Sigma \wedge \Sigma', \alpha \cup \alpha', \beta_{\varepsilon_\ell} \cup \beta'_{\nu_\ell})$$

by counting (Φ, t_0) -matched holomorphic $(\ell+1)$ -gons which have $\text{ind}(\psi, \psi', M) = 1 - \ell$, and all of whose special inputs come from $\mathcal{L}_\beta \otimes \mathcal{L}_{\beta'}$. By Equation (9.5) the parametrized moduli spaces of such families have expected dimension 1, and also have a free \mathbb{R} -action.

If $\kappa < \kappa'$, then we define

$$\Phi_{\kappa \rightarrow \kappa'} := \sum_{\kappa = \kappa_1 < \dots < \kappa_\ell = \kappa'} \varphi_{\kappa_1 < \dots < \kappa_\ell}$$

We may also define a map

$$\Psi: CF_{J,J'}^-(\Sigma \sqcup \Sigma', \alpha \cup \alpha', \mathcal{L}_\beta \otimes \mathcal{L}_{\beta'}) \rightarrow CF_{J \wedge J'}^-(\Sigma \wedge \Sigma', \alpha \cup \alpha', \mathcal{L}_\beta \otimes \mathcal{L}_{\beta'})$$

via the obvious modification.

Lemma 9.12. *Suppose that \mathcal{L}_β and $\mathcal{L}_{\beta'}$ are algebraically rigid hypercubes of attaching curves. If the Hamiltonian translations in the construction of $\mathcal{L}_\beta \otimes \mathcal{L}_{\beta'}$ are suitably small, then the following are the generic codimension 1 degenerations in the parametrized moduli spaces of (Φ, t_0) -matched $(\ell+1)$ -gon curve pairs representing classes with matching data satisfying $\text{ind}(\psi, \psi', M) = 2 - \ell$ (i.e. of expected dimension 1 after quotienting by the free \mathbb{R} -action), where the special beta inputs are from the hypercube $\mathcal{L}_\beta \otimes \mathcal{L}_{\beta'}$:*

- (Φ^ℓ -1) *Two paired marked points in \mathbf{S} and \mathbf{S}' may collide with the special line (away from the marked points \mathbf{C} and \mathbf{C}'). None of the punctures in $\mathbf{P} \cup \mathbf{P}'$ have the same height as the special line.*
- (Φ^ℓ -2) *A pair of punctures of \mathbf{C} and \mathbf{C}' may collide along λ_{t_0} (and the \mathbf{P} and \mathbf{P}' punctures have different heights than λ_{t_0}).*
- (Φ^ℓ -3) *A puncture of \mathbf{N} or \mathbf{N}' may collide with λ_{t_0} (in the complement of \mathbf{C} and \mathbf{C}'), and with different height than \mathbf{P} and \mathbf{P}').*
- (Φ^ℓ -4) *A puncture of \mathbf{C} may degenerate into an index 2 beta boundary degeneration or alpha boundary degeneration. The height λ_{t_0} is different than any puncture in \mathbf{P} or \mathbf{P}' .*
- (Φ^ℓ -5) *The holomorphic pair (u, u') may break into two \mathbb{R} -levels, exactly one of which contains the special line.*
- (Φ^ℓ -6) *Degenerations may occur which involve the punctures \mathbf{P} and \mathbf{P}' . These are constrained to the following:*
 - (a) *An index 1 disk pair may bubble at two punctures of $\mathbf{P} \cup \mathbf{P}'$. If it degenerates above the special line, then the matching is trivial. If it degenerates below the special line, the matching is perfect.*
 - (b) *Four punctures of $\mathbf{P} \cup \mathbf{P}'$ collide and bubble off a pair of index 0 holomorphic triangles. If they form below the special line, the matching is perfect. If they occur above the special line, the matching is trivial.*

See Figure 9.5 for a schematic of the above degenerations.

Proof. The claim that these degenerations have codimension 1 is clear. We claim that there are no further degenerations. There are two points which require explanation:

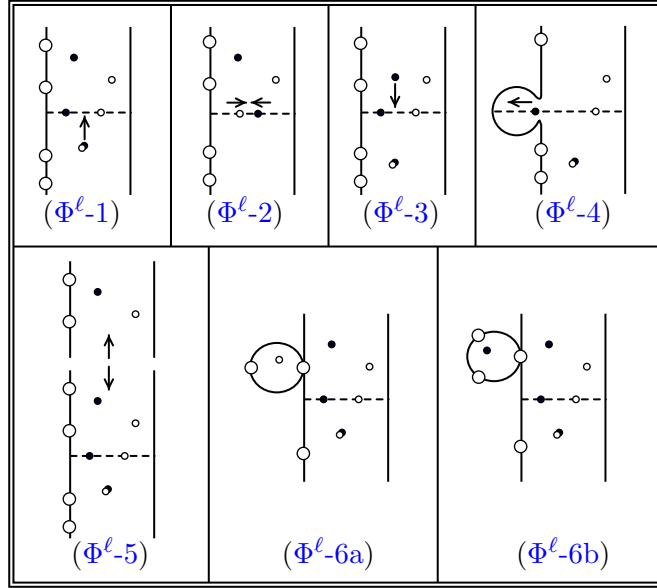

FIGURE 9.5. The generic degenerations of (Φ, t_0) -matched holomorphic ℓ -gon pairs. The large boundary dots denote punctures of \mathbf{P} and \mathbf{P}' .

- (P-1) There are generically no degenerations involving the punctures $\mathbf{P} \cup \mathbf{P}'$ which leave a puncture along $\{0\} \times \mathbb{R}$ of the same height as the special line λ_{t_0} , except for the boundary degenerations $(\Phi^{\ell-4})$.
- (P-2) The generic degenerations at punctures \mathbf{P} or \mathbf{P}' along $\{0\} \times \mathbb{R}$ (which necessarily occur at heights other than that of the special line by (P-1)) are constrained to those listed in $(\Phi^{\ell-6})$. In particular, they are constrained only to index 1 disk bubbling and index 0 triangle degenerations. Such curves are perfectly matched if they occur below the special line, and trivially matched if they occur above the special line. Degenerations of pairs of j -gons at these punctures are prohibited for $j > 3$.

See Figure 9.6 for a schematic of a degeneration which we claim is non-generic.

Both of the claims (P-1) and (P-2) follow from the same basic index bound, which holds for algebraically rigid Heegaard multi-diagrams where all the attaching curves are handleslide equivalent. Indeed, if $(S, \xi, \zeta, \mathbf{w})$ is such a diagram and $\phi \in \pi_2(\Theta_{\xi, \zeta}^+, \mathbf{y})$, then

$$\mu(\phi) = 2n_{\mathbf{w}}(\phi) + \text{gr}(\Theta_{\xi, \zeta}^+, \mathbf{y}),$$

by the relative grading formula. In particular, $\mu(\phi) \geq 2n_{\mathbf{w}}(\phi)$, since there are no generators in grading above $\Theta_{\xi, \zeta}^+$. Similarly, if $\mathcal{D} = (S, \xi_1, \dots, \xi_n, \mathbf{w})$ is a multi-diagram, where all ξ_i are handleslide equivalent, and $\psi \in \pi_2(\Theta_{\xi_1, \xi_2, \dots, \xi_{n-1}, \xi_n}^+, \mathbf{y})$, then

$$\mu(\psi) = 2n_{\mathbf{w}}(\psi) + \text{gr}(\Theta_{\xi_1, \xi_n}^+, \mathbf{y}). \quad (9.6)$$

The above formula also follows from the relative grading formula.

We now argue that degenerations (P-1) are non-generic. Consider a pair (u, u') of broken curves obtained as the limit of a 1-parameter family of (Φ, t_0) -matched $(\ell + 1)$ -gons, representing a pair of classes (ψ, ψ') , all of whose special inputs are the top degree

generators. Assume that each of u and u' consist of a j -gon and a k -gon for

$$j + k = \ell + 3.$$

Such a degeneration corresponds to the codimension 1 strata of K_ℓ . Our argument extends easily to further degenerations of into a tree of curves, corresponding to the higher codimension strata of K_ℓ , though we focus on the codimension 1 strata to simplify the notation.

Suppose that u degenerates into a pair u_r and u_l , where u_r is a map into $\Sigma \times [0, 1] \times \mathbb{R}$, and we view u_l as a map into $\Sigma \times \mathbb{H}$. Here, u_r and u_l have additional boundary punctures, and we think of u_r as a (Φ, t_0) -matched holomorphic k -gon, and we think of u_l as a holomorphic j -gon. We assume that u' similarly consists of a pair u'_l and u'_r , which are holomorphic j -gons and k -gons.

We assume for the sake of the argument that $j, k \geq 2$. We automatically have $k \geq 2$, since there are the punctures at $\pm\infty$. The case that $j = 1$ corresponds to a boundary degeneration. In this case, we may fill in the boundary puncture for the curves u_r and u'_r and obtain an $(\ell + 1)$ -gon. We leave it to the reader to analyze the case of boundary degenerations by adapting the index arguments we present.

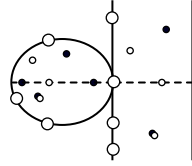

FIGURE 9.6. A putative example of a degeneration of type (P-1). Big dots are boundary punctures. Small dots are marked points. The left disk is identified with \mathbb{H} .

In the limit, write $\mathbf{N}_l, \mathbf{N}_r$, (resp. $\mathbf{C}_l, \mathbf{C}_r$) (resp. $\mathbf{S}_l, \mathbf{S}_r$) for the marked points of u_l and u_r that lie above above, (resp. on), (resp. below) the special line. Write \mathbf{N}'_l (and so forth) for the analogous marked points of u'_l and u'_r . Here, we use the same designation of \mathbf{N} , \mathbf{C} and \mathbf{S} as from the 1-parameter family (so in principle, it is possible for a \mathbf{N} -marked point to lie on the special line, though it will follow from our argument that these degenerations occur in too high of codimension to be generic).

By construction of the 1-parameter family relevant to the degeneration, we have

$$\mu(\psi) + \mu(\psi') + \ell - 2 - 2(|\mathbf{C}| + |\mathbf{S}|) = 0. \quad (9.7)$$

For these families, the parametrized moduli space has expected dimension 2 by Equation (9.5), and also has a free \mathbb{R} -action. We note that $|\mathbf{N}| = |\mathbf{N}_l| + |\mathbf{N}_r|$, and similarly for the other collections of marked points.

We may view the pair (u_l, u'_l) as determining a map to $(\Sigma \sqcup \Sigma') \times \mathbb{H}$, where $\mathbb{H} \subseteq \mathbb{C}$ the half plane $[0, \infty) \times \mathbb{R}$. We view the rightward puncture as being ∞ . Excluding the puncture at ∞ , there are $j - 1$ punctures along $\{0\} \times \mathbb{R}$. We normalize the limit around the special line, so that it coincides with $[0, \infty) \times \{0\}$. There is a 1-parameter family of conformal automorphisms of the half plane which preserve this line. They are multiplication by positive real numbers.

We claim that

$$\mu(\psi_l) + \mu(\psi'_l) + j - 2 - 2|\mathbf{S}_l| - \max(|\mathbf{C}_l| + |\mathbf{C}'_l|, 1) \geq 0. \quad (9.8)$$

The reasoning for the above equation is as follows. We may view the limiting curves as being elements of a moduli space of holomorphic curves which is parametrized by the moduli space of $j - 1$ marked points along $\{0\} \times \mathbb{R}$. This is a $j - 1$ dimensional moduli space, however there is a free action by $\mathbb{R} \times (0, \infty)$. The \mathbb{R} -factor translates in the i -direction, and the $(0, \infty)$ -factor scales by a real positive number. If $|\mathbf{C}_l| + |\mathbf{C}'_l| = 0$, then both of these actions preserve the parametrized moduli space, which has expected dimension $\mu(\psi_l) + \mu(\psi'_l) + j - 1 - 2|\mathbf{S}_l|$. Hence $\mu(\psi_l) + \mu(\psi'_l) + j - 3 - 2|\mathbf{S}_l| \geq 0$ if this moduli space is non-empty, as claimed. If $|\mathbf{C}_l| + |\mathbf{C}'_l| \geq 1$, then the \mathbb{R} -action which translates in the i -direction no longer preserves the matched moduli space, but the $(0, \infty)$ -action does preserve the matched moduli space, so instead we only obtain

$$\mu(\psi_l) + \mu(\psi'_l) + j - 2 - 2|\mathbf{S}_l| - |\mathbf{C}_l| - |\mathbf{C}'_l| \geq 0,$$

as claimed.

Similarly, (u_r, u'_r) can be viewed as living in a moduli space of k -gons where the marked points \mathbf{C}_r and \mathbf{C}'_r lie on the line λ_{t_0} , the marked points \mathbf{S}_r and \mathbf{S}'_r are perfectly matched, and also that there is a boundary puncture which has the same height as the special line. Equation (9.5) implies that the expected dimension of the (Φ, t_0) -matched moduli space, parametrized over all of $K_{k-1} \times \mathbb{R} \times \mathbb{R}$ is $\text{ind}(\psi_r, \psi'_r, M) + k - 1$. There is a free \mathbb{R} -action, as well as an additional constraint that the special line is at the same height as a puncture. Since the expected dimension of this moduli space must be nonnegative if it admits a representative, we conclude that

$$\mu(\psi_r) + \mu(\psi'_r) + k - 3 - 2|\mathbf{S}_r| - |\mathbf{C}_r| - |\mathbf{C}'_r| \geq 0. \quad (9.9)$$

We may rearrange (9.7) to obtain

$$\begin{aligned} 0 &= \mu(\psi) + \mu(\psi') + \ell - 2 - 2(|\mathbf{C}| + |\mathbf{S}|) \\ &= (\mu(\psi_l) + \mu(\psi'_l) + j - 2 - |\mathbf{C}_l| - |\mathbf{C}'_l| - 2|\mathbf{S}_l|) \\ &\quad + (\mu(\psi_r) + \mu(\psi'_r) + k - 3 - |\mathbf{C}_r| - |\mathbf{C}'_r| - 2|\mathbf{S}_r|). \end{aligned} \quad (9.10)$$

Equations (9.8) and (9.9) imply that Equation (9.10) is the sum of two nonnegative integers, the first of which is at least 1. Hence the equation is never satisfiable. This implies claim (P-1).

It remains to consider degenerations into polygons where the special line does not occur at the same height as one of the punctures in $\mathbf{P} \cup \mathbf{P}'$. In such cases, $|\mathbf{C}_l| = |\mathbf{C}'_l| = 0$. Furthermore, equations (9.8) and (9.9) adapt to show that

$$\begin{aligned} \mu(\psi_l) + \mu(\psi'_l) + j - 3 - 2|\mathbf{S}_l| &\geq 0 \quad \text{and} \\ \mu(\psi_r) + \mu(\psi'_r) + k - 2 - 2|\mathbf{S}_r| - |\mathbf{C}_r| - |\mathbf{C}'_r| &\geq 0. \end{aligned} \quad (9.11)$$

Arguing similarly to Equation (9.10), we see that both of the two inequalities above are equalities.

On the other hand, the hyperbox $\mathcal{L}_\beta \otimes \mathcal{L}_{\beta'}$ is algebraically rigid, regardless of whether the curves are viewed as living on $\Sigma \sqcup \Sigma'$ or $\Sigma \wedge \Sigma'$. In particular, if (u_l, u'_l) is a holomorphic j -gon which degenerates below the special line, represents the homology class (ψ_l, ψ'_l) of j -gons on $\Sigma \wedge \Sigma'$, and which has inputs only from $\mathcal{L}_\beta \otimes \mathcal{L}_{\beta'}$, then

$$\mu(\psi_l) + \mu(\psi'_l) - 2|\mathbf{S}_l| = 2n_{\mathbf{w}''}(\psi_l \wedge \psi'_l) + \text{gr}(\Theta^+, \mathbf{z}) \geq 0$$

where \mathbf{z} is the outgoing intersection point of $\psi_l \wedge \psi'_l$. From Equation (9.11), we conclude that

$$\mu(\psi_l) + \mu(\psi'_l) - 2|\mathbf{S}_l| = 3 - j = 2n_{\mathbf{w}''}(\psi_l \wedge \psi'_l) + \text{gr}(\Theta^+, \mathbf{z}) \geq 0.$$

There are exactly two possible cases: $j = 3$ and $n_{\mathbf{w}''}(\psi_l + \psi'_l) = \text{gr}(\Theta^+, \mathbf{z}) = 0$; and $j = 2$ and $n_{\mathbf{w}''}(\psi_l + \psi'_l) = 0$ and $\text{gr}(\Theta^+, \mathbf{z}) = 1$. The former corresponds to index 0 triangle pairs degenerating below the special line, and the latter corresponds to index 1 disks degenerating below the special line. Degenerations of j -gons above the special line are handled via an essentially identical argument. \square

Lemma 9.13. *The maps Φ and Ψ are chain maps of hypercubes.*

Proof. We focus on the map Φ , since the analysis for Ψ is nearly identical. Suppose $\kappa \leq \kappa' \in \mathbb{E}_{n+m}$, and consider the hypercube relations for $\text{Cone}(\Phi)$. If $\kappa = \kappa'$, then the hypercube relations follow from Lemma 9.9, so assume $\kappa < \kappa'$.

Suppose that $\kappa = \kappa_1 < \dots < \kappa_\ell = \kappa'$. We count the ends of 1-dimensional families of (Φ, t_0) -matched $\ell + 1$ -gons, which have inputs from $\mathcal{L}_\beta \otimes \mathcal{L}_{\beta'}$. The codimension 1 degenerations are analyzed in Lemma 9.12. Many of these ends have a similar cancellation pattern as to Lemma 9.9. For example the ends $(\Phi^{\ell-1})$ and $(\Phi^{\ell-2})$ cancel modulo 0. Similarly, each curve satisfying $(\Phi^{\ell-3})$ appears twice in the boundary of the modulo space, unless the limiting marked points alternate between Σ and Σ' , in which case the curves cancel the degenerations in $(\Phi^{\ell-4})$. The curves appearing in $(\Phi^{\ell-6})$ cancel modulo 2 because of the hypercube relations for $\mathcal{L}_\beta \otimes \mathcal{L}_{\beta'}$ (on both $\Sigma \sqcup \Sigma'$ and $\Sigma \wedge \Sigma'$). Note here we are also using the fact that the only holomorphic curves which contribute to the hypercube relations for $\mathcal{L}_\beta \otimes \mathcal{L}_{\beta'}$ are holomorphic disks of index 1 which do not cover any basepoints, and also index 0 holomorphic triangle pairs which also do not cover any basepoints. This follows because any ℓ -gon pair (u, u') with the inputs from $\mathcal{L}_\beta \otimes \mathcal{L}_{\beta'}$, which either has $\ell > 3$ or covers the basepoint, must have too high of index to appear in the hypercube relations by (9.6).

The remaining curves are those which appear in the degenerations labeled $(\Phi^{\ell-5})$. These ends correspond exactly to the hypercube relations for the mapping cone of Φ . This verifies that Φ is a chain map. \square

Lemma 9.14. *The maps Φ and Ψ are homotopy inverses.*

Proof. The proof is similar to the proof of Lemma 9.10. Indeed, one can define (H_\wedge, t_0) -matched holomorphic $(\ell + 1)$ -gons by analogy to the case of disks. Counting such curves gives a morphism of hypercubes

$$H_\wedge : CF^-(\Sigma \wedge \Sigma', \alpha \cup \alpha', \mathcal{L}_\beta \otimes \mathcal{L}_{\beta'}) \rightarrow CF^-(\Sigma \sqcup \Sigma', \alpha \cup \alpha', \mathcal{L}_\beta \otimes \mathcal{L}_{\beta'}).$$

By a straightforward adaptation of Lemma 9.12 to the case where there are two special lines, and by adapting the argument from Lemma 9.10 to handle the limiting curves appearing as the special lines collide, we obtain exactly that the following diagram is an $(n + m + 2)$ -dimensional hypercube of chain complexes:

$$\begin{array}{ccc} CF^-(\Sigma \wedge \Sigma', \alpha \cup \alpha', \mathcal{L}_\beta \otimes \mathcal{L}_{\beta'}) & \xrightarrow{\Phi} & CF^-(\Sigma \sqcup \Sigma', \alpha \cup \alpha', \mathcal{L}_\beta \otimes \mathcal{L}_{\beta'}) \\ \downarrow \text{id} & \dashrightarrow^{H_\wedge} & \downarrow \Psi \\ CF^-(\Sigma \wedge \Sigma', \alpha \cup \alpha', \mathcal{L}_\beta \otimes \mathcal{L}_{\beta'}) & \xrightarrow{\text{id}} & CF^-(\Sigma \wedge \Sigma', \alpha \cup \alpha', \mathcal{L}_\beta \otimes \mathcal{L}_{\beta'}) \end{array}$$

The above diagram realizes the relation

$$\Psi \circ \Phi + \text{id} = [\partial, H_\wedge],$$

completing the proof. A homotopy equivalence in the other direction is defined by the obvious adaptation. \square

Remark 9.15. The above arguments extend with only notational changes to show the following. Suppose \mathcal{L}_α and \mathcal{L}_β are algebraically rigid hypercubes of attaching curves on Σ , and $\mathcal{L}_{\alpha'}$ and $\mathcal{L}_{\beta'}$ are algebraically rigid hypercubes of attaching curves on Σ' . Furthermore, assume that we form admissible connected sums $\mathcal{L}_\alpha \otimes \mathcal{L}_{\alpha'}$ and $\mathcal{L}_\beta \otimes \mathcal{L}_{\beta'}$, in the sense of Definition 9.1. If the Hamiltonian translates used in the construction of $\mathcal{L}_\alpha \otimes \mathcal{L}_{\alpha'}$ and $\mathcal{L}_\beta \otimes \mathcal{L}_{\beta'}$ are sufficiently small, then

$$CF(\Sigma \# \Sigma', \mathcal{L}_\alpha \otimes \mathcal{L}_{\alpha'}, \mathcal{L}_\beta \otimes \mathcal{L}_{\beta'}) \simeq CF(\Sigma, \mathcal{L}_\alpha, \mathcal{L}_\beta) \otimes_{\mathbb{F}[U]} CF(\Sigma', \mathcal{L}_{\alpha'}, \mathcal{L}_{\beta'}).$$

10. THE PAIRING THEOREM

In this section, we prove the pairing theorem. We prove Theorems 1.3 and 1.4 of the introduction, as well as some generalizations for DA -bimodules.

10.1. The statement. We now state the pairing theorem (i.e. connected sum formula). In this section, we state the pairing theorem for links in terms of a box-tensor product. In Section 10.2, we unpack the statement in terms of the link surgery complexes. In Section 10.3, we prove the statement.

Theorem 10.1. *Suppose that L_1 and L_2 are two links in S^3 , and that we form their connected sum $L_1 \# L_2$ along two distinguished components $K_1 \subseteq L_1$ and $K_2 \subseteq L_2$. Then*

$$\mathcal{X}_{\Lambda_1 + \Lambda_2}(L_1 \# L_2)^{\mathcal{L}(\ell_1 + \ell_2 - 1)} \simeq \mathcal{X}_{\Lambda_1}(L_1)^{\mathcal{L}(\ell_1 - 1) \otimes \mathcal{K}}(L_1) \hat{\boxtimes}_{\mathcal{K}} \mathcal{X}_{\Lambda_2}^{\mathcal{L}(\ell_2)}(L_2)$$

In the above, the \mathcal{K} factor in the output of $\mathcal{X}_{\Lambda_1}(L_1)$ corresponds to K_1 , and the \mathcal{K} input in $\mathcal{X}_{\Lambda_2}(L_2)$ corresponds to K_2 .

Recall that the DA -bimodule $\mathcal{X}_{\Lambda_2}^{\mathcal{L}(\ell_2)}(L_2)$ was constructed in Section 6.6 by tensoring $\mathcal{X}_{\Lambda_2}^{\mathcal{L}(\ell_2)}$ with the merge bimodule $\mathcal{K} \otimes_{\mathcal{K}} M_2^{\mathcal{K}}$. In particular, an alternate perspective on the above theorem is that $\mathcal{X}_{\Lambda_1 + \Lambda_2}(L_1 \# L_2)^{\mathcal{L}(\ell_1 + \ell_2 - 1)}$ is obtained by tensoring $\mathcal{X}_{\Lambda_1}(L_1)^{\mathcal{L}(\ell_1)}$ and $\mathcal{X}_{\Lambda_2}(L_2)^{\mathcal{L}(\ell_2)}$ with the merge bimodule $\mathcal{K} \otimes_{\mathcal{K}} M_2^{\mathcal{K}}$.

10.2. Unpacking the statement. We now give a concrete reformulation of the pairing theorem from the previous section, in terms of the knot and link surgery complexes.

We begin by unpacking the claim for the Ozsváth–Szabó mapping cone complex $\mathbb{X}_\lambda(Y_1 \# Y_2, K_1 \# K_2)$. For $i \in \{1, 2\}$, the complex $\mathbb{X}_{\lambda_i}(Y_i, K_i)$ is the algebraic completion of the mapping cone

$$\text{Cone}\left(\mathcal{CFK}^-(Y_i, K_i) \xrightarrow{v_i + h_{\lambda_i}} \mathcal{V}^{-1} \mathcal{CFK}^-(Y_i, K_i) \right).$$

From the connected sum formula for knot Floer homology, we know that

$$\mathcal{CFK}^-(Y_1 \# Y_2, K_1 \# K_2) \cong \mathcal{CFK}^-(Y_1, K_1) \otimes_{\mathbb{F}[\mathcal{U}, \mathcal{V}]} \mathcal{CFK}^-(Y_2, K_2)$$

and similarly the localized module $\mathcal{V}^{-1} \mathcal{CFK}^-(Y_1 \# Y_2, K_1 \# K_2)$ decomposes as a tensor product over the ring $\mathbb{F}[\mathcal{U}, \mathcal{V}, \mathcal{V}^{-1}]$.

Note that these tensor products may themselves be described as box tensor products over the algebras $\mathbb{F}[\mathcal{U}, \mathcal{V}]$ and $\mathbb{F}[\mathcal{U}, \mathcal{V}, \mathcal{V}^{-1}]$. Indeed, if $\mathbf{x}_1, \dots, \mathbf{x}_n$ is a free-basis of $\mathcal{CFK}^-(Y_1, K_1)$, then we may form a type- D module $\mathcal{CFK}(Y_1, K_1)^{\mathbb{F}[\mathcal{U}, \mathcal{V}]}$, spanned over \mathbb{F} by $\mathbf{x}_1, \dots, \mathbf{x}_n$, with structure map δ^1 encoding the differential on $\mathcal{CFK}^-(Y_1, K_1)$. Similarly, we may view $\mathcal{CFK}^-(Y_2, K_2)$ as a type- A module ${}_{\mathbb{F}[\mathcal{U}, \mathcal{V}]} \mathcal{CFK}(Y_2, K_2)$, freely generated over $\mathbb{F}[\mathcal{U}, \mathcal{V}]$ by intersection points, and with only m_1 and m_2 non-vanishing. Clearly,

$$\mathcal{CFK}(Y_1, K_1)^{\mathbb{F}[\mathcal{U}, \mathcal{V}]} \boxtimes_{\mathbb{F}[\mathcal{U}, \mathcal{V}]} \mathcal{CFK}(Y_2, K_2) \cong \mathcal{CFK}^-(Y_1, K_1) \otimes_{\mathbb{F}[\mathcal{U}, \mathcal{V}]} \mathcal{CFK}^-(Y_2, K_2).$$

The maps v_1 and v_2 from the knot surgery formulas of K_1 and K_2 are the canonical inclusion maps for localization at \mathcal{V}_i , the map v on the tensor product is just the tensor product $v_1 \otimes v_2$.

On the other hand, the maps $h_{\lambda_1}^{(Y_1, K_1)}$ and $h_{\lambda_2}^{(Y_2, K_2)}$ are $[T]$ -equivariant, in the sense of Lemma 5.9. However it is straightforward to see that this implies that their tensor product $h_{\lambda_1}^{(Y_1, K_1)} \otimes h_{\lambda_2}^{(Y_2, K_2)}$ is well defined.

In the box tensor product $\mathcal{X}_{\lambda_1}(K_1)^{\mathcal{K}} \hat{\boxtimes}_{\mathcal{K}} \mathcal{X}_{\lambda_2}(K_2)$, there is a summand of the differential which corresponds to τ being output by $\mathcal{X}_{\lambda_1}(K_1)^{\mathcal{K}}$, and then input into ${}_{\mathcal{K}} \mathcal{X}_{\lambda_2}(K_2)$. This summand is identified with $h_{\lambda_1}^{(Y_1, K_1)} \otimes h_{\lambda_2}^{(Y_2, K_2)}$. Similarly, there is a summand of the differential that corresponds to a σ being output by $\mathcal{X}_{\lambda_1}(K_1)^{\mathcal{K}}$, and then input into ${}_{\mathcal{K}} \mathcal{X}_{\lambda_2}(K_2)$. This contributes $v_1 \otimes v_2$ to the differential.

We summarize the above observations with the following lemma:

Lemma 10.2. *If $K_1 \subseteq Y_1$ and $K_2 \subseteq Y_2$ are two knots in integer homology 3-spheres, then Theorem 10.1 is equivalent to the statement that the map $h_{\lambda_1 + \lambda_2}^{(Y_1 \# Y_2, K_1 \# K_2)}$ in Ozsváth and Szabó's surgery formula $\mathbb{X}_{\lambda_1 + \lambda_2}(Y_1 \# Y_2, K_1 \# K_2)$ satisfies*

$$h_{\lambda_1 + \lambda_2}^{(Y_1 \# Y_2, K_1 \# K_2)} = h_{\lambda_1}^{(Y_1, K_1)} \otimes h_{\lambda_2}^{(Y_2, K_2)}.$$

The pairing theorem for the link surgery formula has a similar restatement. Let $\mathbb{X}_{\Lambda_1}(L_1)$ and $\mathbb{X}_{\Lambda_2}(L_2)$ be the link surgery hypercubes of Manolescu and Ozsváth. Write

$$\mathbb{X}_{\Lambda_i}(L_i) \cong \text{Cone} \left(\mathcal{C}_0(L_i) \xrightarrow{\phi_i^- + \phi_i^+} \mathcal{C}_1(L_i) \right)$$

Here $\mathcal{C}_\nu(L_i)$ consists of the complexes of all points of the cube \mathbb{E}_{ℓ_i} such that the coordinate for K_i is $\nu \in \{0, 1\}$. The map ϕ_i^+ (resp. ϕ_i^-) is the sum of all cube arrows for oriented sublinks \vec{M} of L (with orientations potentially different than L) such that $K_i \subseteq \vec{M}$ (resp. $-K_i \subseteq \vec{M}$).

Note that if we forget the hypercube morphisms, and focus only on the groups and internal differentials, the ordinary connected sum formula for knots and links [OS04a, Section 7] provides an identification of chain complexes

$$\mathcal{C}_0(L_1 \# L_2) \cong \mathcal{C}_0(L_1) \hat{\otimes}_{\mathbb{F}[\mathcal{U}, \mathcal{V}]} \mathcal{C}_0(L_2)$$

and

$$\mathcal{C}_1(L_1 \# L_2) \cong \mathcal{C}_1(L_1) \hat{\otimes}_{\mathbb{F}[\mathcal{U}, \mathcal{V}, \mathcal{V}^{-1}]} \mathcal{C}_1(L_2).$$

Here, $\hat{\otimes}$ denotes the completed tensor product. The maps ϕ_i^+ are $\mathbb{F}[\mathcal{U}, \mathcal{V}]$ -equivariant, while ϕ_i^- are $[T]$ -equivariant. In particular, both tensor products $\phi_1^+ \otimes \phi_2^+$ and $\phi_1^- \otimes \phi_2^-$

are well-defined. The same logic as with the case of connected sums of knots gives the the following restatement of the pairing theorem for the surgery hypercubes:

Lemma 10.3. *Theorem 10.1 is equivalent to the statement that the surgery hypercube $\mathbb{X}_{\Lambda_1+\Lambda_2}(L_1\#L_2)$ is homotopy equivalent to the $(\ell_1 + \ell_2 - 1)$ -dimensional hypercube*

$$\text{Cone}(\mathcal{C}_0(L_1) \hat{\otimes} \mathcal{C}_0(L_2) \xrightarrow{\phi_1^+ \otimes \phi_2^+ + \phi_1^- \otimes \phi_2^-} \mathcal{C}_1(L_1) \hat{\otimes} \mathcal{C}_1(L_2))$$

For each $\nu \in \{0, 1\}$, the above complexes $\mathcal{C}_\nu(L_1) \hat{\otimes} \mathcal{C}_\nu(L_2)$ are equipped with the tensor product differential $D_1^\nu \otimes \text{id} + \text{id} \otimes D_2^\nu$, where D_j^ν is the total differential of the hypercube $\mathcal{C}_\nu(L_j)$ (i.e. the sum of the internal differentials as well as the hypercube maps).

10.3. Proof of the pairing theorem. We are now in position to prove the pairing theorem, Theorem 10.1:

Proof of Theorem 10.1. We use the restatement of the theorem in terms of mapping cones of hypercube morphisms from Lemma 10.3.

Firstly, it is clearly true that the ϕ^+ -maps are tensorial if we use a basic system of Heegaard diagrams. Indeed the only summands of the maps ϕ_1^+ and ϕ_2^+ which are non-trivial are the length 1 summands which increment only the index corresponding to the special components K_1 and K_2 . Similarly the only non-trivial summand of $\phi_{1\#2}^+$ is the length 1 map which increases only the coordinate corresponding to $K_1\#K_2$. The maps ϕ_1^+ , ϕ_2^+ and $\phi_{1\#2}^+$ are the canonical inclusions related to localizing at the \mathcal{V} variable associated to the components K_1 , K_2 and $K_1\#K_2$. Clearly they are tensorial.

We now consider the maps ϕ_i^- , for $i \in \{1, 2\}$, which appear in the statement. These maps will in general have summands of length greater than 1, but since we are using a basic system, the only non-trivial summands correspond to sublinks $\vec{M} \subseteq L_1\#L_2$, all of whose components are oriented oppositely to $L_1\#L_2$. (See the second paragraph of [MO10, Section 8.7]).

We focus on the largest hyperbox in a basic system, i.e. the one for $\vec{M} = -(L_1\#L_2)$. We will use the basic system which we constructed in Section 7.3. We write $\mathcal{L}_{\beta_1, \beta_2}^{-L_1\#L_2}$ for the maximal size hyperbox from this basic system.

We consider the hyperbox $CF^-(\Sigma_1\#\Sigma_2, \alpha_1 \cup \alpha_2, \mathcal{L}_{\beta_1, \beta_2}^{-L_1\#L_2})$, which we compress to obtain a hypercube $C(L_1\#L_2)$. In the hyperbox $\mathcal{L}_{\beta_1, \beta_2}^{-L_1\#L_2}$, we have only free-basepoints. Correspondingly, we may view the hypercube C as a free module over

$$R := \mathbb{F}[U_1, \dots, U_{\ell_1-1}, U_{\ell_1}, U_{\ell_1+1}, \dots, U_{\ell_1+\ell_2-1}]$$

where U_1, \dots, U_{ℓ_1} are the variables for L_1 , and $U_{\ell_1}, \dots, U_{\ell_1+\ell_2-1}$ are the variables for L_2 . (Here, U_{ℓ_1} is viewed as the variable for the special component $K_1\#K_2$).

We now consider $C(L_1\#L_2) \otimes_{\mathbb{F}} \mathbb{F}[\mathbb{H}(L_1\#L_2)]$. We write $\mathcal{T}_{\ell_1+\ell_2-1}$ for the Laurent polynomial ring in the variables $t_1, t_1^{-1}, \dots, t_{\ell_1+\ell_2-1}, t_{\ell_1+\ell_2-1}^{-1}$. We may view $\mathbb{F}[\mathbb{H}(L_1\#L_2)]$ as a module over $\mathcal{T}_{\ell_1+\ell_2-1}$.

If $\vec{N} \subseteq -L_1\#L_2$ is an oriented sublink, there is a corresponding algebra element $t_{\vec{N}}^{\Lambda_1+\Lambda_2} \in \mathcal{T}_{\ell_1+\ell_2-1}$, which is $e^{\Lambda_{L_1\#L_2, \vec{N}}}$ if we think of $\mathcal{T}_{\ell_1+\ell_2-1}$ as the group ring $\mathbb{F}[\mathbb{Z}^{\ell_1+\ell_2-1}] = \text{Span}_{\mathbb{F}}(e^a : a \in \mathbb{Z}^{\ell_1+\ell_2-1})$. In the hypercube $C(L_1\#L_2) \otimes_{\mathbb{F}} \mathbb{F}[\mathbb{H}(L_1\#L_2)]$, we multiply the map for a sublink $\vec{N} \subseteq -L_1\#L_2$ by $t_{\vec{N}}^{\Lambda_1+\Lambda_2}$ to obtain a diagram of chain complexes, for which we write $C_{\Lambda_1+\Lambda_2}(L_1\#L_2)$. Since $t_{\vec{N}_1 \cup \vec{N}_2}^{\Lambda_1+\Lambda_2} = t_{\vec{N}_1}^{\Lambda_1+\Lambda_2} \cdot t_{\vec{N}_2}^{\Lambda_1+\Lambda_2}$

when N_1 and N_2 are disjoint, the diagram $C_{\Lambda_1+\Lambda_2}(L_1\#L_2)$ is a hypercube of chain complexes.

Next, we describe several trivialization maps. If $\varepsilon \in \mathbb{E}_{\ell_1+\ell_2-1}$ then there is a map

$$\phi_\varepsilon: S_\varepsilon^{-1} \cdot \mathcal{CFL}(\alpha_1 \cup \alpha_2, \beta_1 \cup \beta_2, \mathbf{w}, \mathbf{z}) \rightarrow CF^-(\alpha_1 \cup \alpha_2, \beta_1 \cup \beta_2, \mathbf{w}_\varepsilon) \otimes \mathbb{F}[\mathbb{H}(L_1\#L_2)].$$

In the above, we write $\beta_1 \cup \beta_2$ for the beta curves at the corners of $\mathcal{L}_{\beta_1, \beta_2}^{-L_1\#L_2}$ (which are assumed to coincide). Also S_ε is the multiplicatively closed subset generated by \mathcal{V}_i for indices such that $\varepsilon(i) = 1$ and \mathcal{U}_i for indices such that $\varepsilon(i) = 0$. The basepoints \mathbf{w}_ε consist of $\ell_1 + \ell_2 - 1$ basepoints, which are w_i if $\varepsilon(i) = 1$ and z_i if $\varepsilon(i) = 0$.

This map ϕ_ε is defined as follows. The map sends an intersection point \mathbf{x} to itself, but changes the algebra elements. If $\varepsilon(i) = 0$, then $\mathcal{U}_i^{n_i} \mathcal{V}_i^{m_i}$ is sent to $U_i^{m_i} t_i^{A_i^{L_1\#L_2}(\mathbf{x})+m_i-n_i}$. If $\varepsilon(i) = 1$, then $\mathcal{U}_i^{n_i} \mathcal{V}_i^{m_i}$ is sent to $U_i^{n_i} t_i^{A_i^{L_1\#L_2}(\mathbf{x})+m_i-n_i}$. The map ϕ_ε is a chain isomorphism for all ε .

Recall that for the sublink $\vec{M} = -L_1\#L_2$, there is hypercube whose underlying group is the same as the link surgery complex, but whose differential counts the maps only for oriented sublinks of $-L_1\#L_2$. See [MO10, Proposition 9.4]. The maps in this hypercube may be described as follows. Write $\delta_{\varepsilon, \varepsilon'}$ for the structure maps of $C_{\Lambda_1+\Lambda_2}(L_1\#L_2)$. If $\varepsilon < \varepsilon'$, and \vec{N} is the sublink whose components correspond to the difference $\varepsilon' - \varepsilon$ and are negatively oriented relative to $L_1\#L_2$, then the hypercube map $\Phi_{\varepsilon, \varepsilon'}^{\vec{N}}$ is the composition of $\phi_{\varepsilon'}^{-1} \circ \delta_{\varepsilon, \varepsilon'} \circ \phi_\varepsilon$. (Note that technically, $\phi_{\varepsilon'}^{-1} \circ \delta_{\varepsilon, \varepsilon'} \circ \phi_\varepsilon$ should have an additional initial factor corresponding to the inclusion map from localizing at some of the \mathcal{U}_i variables, though we suppress this).

We now consider the basic system of Heegaard diagrams constructed in Section 7.3, for which we are writing $\mathcal{L}_{\beta_1, \beta_2}^{-L_1\#L_2}$. The hypercubes of attaching curves which appear in this basic system have a simple description in terms of tensor products of hypercubes of attaching curves. See Equation (7.1). Recall that this hyperbox was constructed by picking hyperboxes $\mathcal{L}_{\beta_1}^{-L_1}$ and $\mathcal{L}_{\beta_2}^{-L_2}$ of attaching curves with basepoint slides which were algebraically rigid, as constructed in Lemma 7.5. If $i \in \{1, 2\}$, write $\mathcal{L}_{\beta_i}^{-L_i, (0)}$ (resp. $\mathcal{L}_{\beta_i}^{-L_i, (1)}$) for the codimension 1 hyperbox whose index for the special component K_i is 0 (resp. maximal). Recall that we defined

$$\mathcal{L}_{\beta_1, \beta_2}^{-L_1\#L_2} = \text{St}(\mathcal{L}_{\beta_1}^{-L_1} \otimes \mathcal{L}_{\beta_2}^{-L_2, (0)}, \mathcal{L}_{\beta_1}^{-L_1, (1)} \otimes \mathcal{L}_{\beta_2}^{-L_2}).$$

Each of the individual hypercubes of the resulting hyperbox of chain complexes is obtained by pairing the tensor product of two hypercubes of beta attaching curves $\mathcal{L}_1 \otimes \mathcal{L}_2$ with $\alpha_1 \cup \alpha_2$ (and then possibly extending certain directions via the canonical isomorphism of the basepoint slides). By Propositions 8.1 and 9.4, for appropriately chosen attaching curves, there are natural homotopy equivalences

$$CF^-(\Sigma_1\#\Sigma_2, \alpha_1 \cup \alpha_2, \mathcal{L}_1 \otimes \mathcal{L}_2) \simeq CF^-(\Sigma_1, \alpha_1, \mathcal{L}_1) \otimes_{\mathbb{F}[U]} CF^-(\Sigma_2, \alpha_2, \mathcal{L}_2).$$

These homotopy equivalences are natural in the sense that they agree on common faces of hypercubes in the surgery hyperbox.

Note that by Lemma 2.8, the operations of stacking and pairing hyperboxes of attaching curves commute. In particular, the hypercube $C(L_1\#L_2)$ is obtained by stacking

the two hyperboxes

$$CF^-(\alpha_1, \mathcal{L}_{\beta_1}^{-L_1}) \otimes_{\mathbb{F}[U]} CF^-(\alpha_2, \mathcal{L}_{\beta_2}^{-L_2, (0)}) \quad \text{and} \quad CF^-(\alpha_1, \mathcal{L}_{\beta_1}^{-L_1, (1)}) \otimes_{\mathbb{F}[U]} CF^-(\alpha_2, \mathcal{L}_{\beta_2}^{-L_2})$$

and then compressing. We may use the inductive construction described in Section 2.3 to compress. In doing so, we may choose to compress the axis corresponding to the special link components K_1 and K_2 last. We obtain that $C(L_1 \# L_2)$ is homotopy equivalent to the compression of

$$C_0(L_1) \otimes_{\mathbb{F}[U]} C_0(L_2) \xrightarrow{f_1^- \otimes \text{id}} C_1(L_1) \otimes_{\mathbb{F}[U]} C_0(L_2) \xrightarrow{\text{id} \otimes f_2^-} C_1(L_1) \otimes_{\mathbb{F}[U]} C_1(L_2). \quad (10.1)$$

In Equation (10.1), $C_0(L_i)$ (resp. $C_1(L_i)$) is the codimension 1 subcube of $C(L_i)$ where the K_i component is 0 (resp. 1), and f_1^- and f_2^- are the sums of the hypercube structure maps of $C(L_1)$ and $C(L_2)$ which increase the coordinate corresponding to K_1 and K_2 , respectively.

We may identify

$$\mathbb{F}[\mathbb{H}(L_1 \# L_2)] \cong \mathbb{F}[\mathbb{H}(L_1)] \otimes_{\mathbb{F}[t, t^{-1}]} \mathbb{F}[\mathbb{H}(L_2)],$$

where the algebra $\mathbb{F}[t, t^{-1}]$ in the tensor product acts on the components corresponding to the distinguished components K_1 and K_2 .

If $\vec{N} \subseteq -L_1 \# L_2$, write $\vec{N}_1 \subseteq -L_1$ and $\vec{N}_2 \subseteq -L_2$ for the corresponding components. Note that

$$t_{\vec{N}}^{\Lambda_1 + \Lambda_2} = t_{\vec{N}_1}^{\Lambda_1} \otimes t_{\vec{N}_2}^{\Lambda_2},$$

with respect to the isomorphism $\mathcal{T}_{\ell_1 + \ell_2 - 1} \cong \mathcal{T}_{\ell_1} \otimes_{\mathbb{F}[t, t^{-1}]} \mathcal{T}_{\ell_2}$.

Weighting hypercube maps using the algebra elements $t_{\vec{N}_i}^{\Lambda_i}$, we obtain from Equation (10.1) that $C_{\Lambda_1 + \Lambda_2}(L_1 \# L_2)$ is the compression of the hyperbox

$$C_{\Lambda_1, 0}(L_1) \otimes C_{\Lambda_2, 0}(L_2) \xrightarrow{F_1^- \otimes \text{id}} C_{\Lambda_1, 1}(L_1) \otimes C_{\Lambda_2, 0}(L_2) \xrightarrow{\text{id} \otimes F_2^-} C_{\Lambda_1, 1}(L_1) \otimes C_{\Lambda_2, 1}(L_2). \quad (10.2)$$

where the tensor products above are over $\mathbb{F}[U, t, t^{-1}]$. Also, F_i^- is the sum of the hypercube structure maps of C_{Λ_i} for sublinks $\vec{N} \subseteq -L_i$ which contain $-K_i$.

If $\varepsilon \in \mathbb{E}_{\ell_1}$ and $\nu \in \mathbb{E}_{\ell_2}$ coincide on the index of K_1 and K_2 then we write (ε, ν) for the corresponding element of $\mathbb{E}_{\ell_1 + \ell_2 - 1}$. It is straightforward to verify that for such a pair (ε, ν) , we have $\phi_{(\varepsilon, \nu)}^{L_1 \# L_2} = \phi_{\varepsilon}^{L_1} \otimes \phi_{\nu}^{L_2}$. Hence, by compressing the hypercube in Equation (10.2) and composing with the $\phi_{(\varepsilon, \nu)}^{L_1 \# L_2}$ maps and their inverses, we obtain the description in Lemma 10.3. \square

11. ON THE LINK FLOER HOMOLOGY OF HOPF LINKS

In this section, we prove several helpful results centered on the link Floer homology of the Hopf link. In Section 11.1, we compute the link surgery complex for the negative Hopf link. In Section 11.2, we give several A_∞ perspectives on the Hopf link complex, and we apply the homological perturbation lemma to arrive at small models.

11.1. **The surgery complex of the Hopf link.** In this section, we compute the surgery hypercube for the Hopf link. We use the following model of the Hopf link:

$$\mathcal{CFL}^-(H) \cong \begin{array}{ccc} \mathbf{a} \leftarrow \mathcal{U}_2 - \mathbf{b} & & \\ \uparrow \mathcal{V}_1 & & \downarrow \mathcal{U}_1 \\ \mathbf{c} - \mathcal{V}_2 \rightarrow \mathbf{d} & & \end{array} \quad (11.1)$$

This complex is realized by the diagram in Figure 11.1. This complex is for the *negative* Hopf link, i.e., the two components have linking number -1 . The complex of the positive Hopf link has a similar model. The techniques of this section may also be applied, essentially verbatim, to the positive Hopf link, though we focus on the negative one for concreteness.

The Alexander gradings $A = (A_1, A_2)$ and Maslov gradings $\text{gr} = (\text{gr}_{\mathbf{w}}, \text{gr}_{\mathbf{z}})$ of the generators are

$$\begin{aligned} A(\mathbf{a}) &= \left(-\frac{1}{2}, \frac{1}{2}\right), & \text{gr}(\mathbf{a}) &= (0, 0), \\ A(\mathbf{b}) &= \left(-\frac{1}{2}, -\frac{1}{2}\right), & \text{gr}(\mathbf{b}) &= (-1, 1), \\ A(\mathbf{c}) &= \left(\frac{1}{2}, \frac{1}{2}\right), & \text{gr}(\mathbf{c}) &= (1, -1), \\ A(\mathbf{d}) &= \left(\frac{1}{2}, -\frac{1}{2}\right), & \text{gr}(\mathbf{d}) &= (0, 0). \end{aligned} \quad (11.2)$$

Note that we are using the conventions where the top degree generator of $HF^-(S^3, \mathbf{w})$ is in Maslov grading 0. See Remark 5.5.

We now compute the link surgery hypercube maps for the Hopf link. For the purposes of computation, it is easier to compute the induced maps after quotienting variables, instead of after localizing. Since the descent maps are defined by computing holomorphic polygons on diagrams where we have deleted certain basepoints, this is easily seen to contain equivalent information as the ordinary surgery hypercube. Compare Lemma 5.7.

As an example, if $L_1 \subseteq H$, then the descent map from surgery hypercube takes the form

$$\Phi_{H, H-L_1}^{-L_1} : \mathcal{CFL}^-(H) \rightarrow \mathcal{V}_1^{-1} \cdot \mathcal{CFL}^-(H).$$

The map $\Phi_{H, H-L_1}^{-L_1}$ is completely determined by the choice of framing on H , and the induced homotopy equivalence on the level of quotients

$$\tilde{\Phi}_{H, H-L_1}^{-L_1} : \mathcal{CFL}^-(H)/(\mathcal{U}_1 - 1) \rightarrow \mathcal{CFL}^-(H)/(\mathcal{V}_1 - 1).$$

In this section, we write $\tilde{\Phi}^{\vec{N}}$ for the descent map on the level of quotients of $\mathcal{CFL}^-(H)$.

Proposition 11.1. *Write L_1 and L_2 for the two components of the negative Hopf link. Up to overall equivalence, the maps for the Hopf link are as follows:*

(1) *The map*

$$\tilde{\Phi}_{H, L_2}^{-L_1} : \mathcal{CFL}^-(H)/(\mathcal{U}_1 - 1) \rightarrow \mathcal{CFL}^-(H)/(\mathcal{V}_1 - 1)$$

is given by the formula

$$\tilde{\Phi}_{H,L_2}^{-L_1} = \begin{array}{l} \mathbf{a} \longmapsto \mathbf{d} \\ \mathbf{b} \longmapsto 0 \\ \mathbf{c} \longmapsto \mathbf{b} + \mathcal{U}_2 \mathbf{c} \\ \mathbf{d} \longmapsto \mathcal{U}_2 \mathbf{d}. \end{array}$$

extended $\mathbb{F}[\mathcal{U}_2, \mathcal{V}_2]$ -equivariantly, and sending \mathcal{V}_1 to \mathcal{U}_1 .

(2) The map

$$\tilde{\Phi}_{L_1, \emptyset}^{-L_1} : \mathcal{CFL}^-(H)/(\mathcal{U}_1 - 1, \mathcal{V}_2 - 1) \rightarrow \mathcal{CFL}^-(H)/(\mathcal{V}_1 - 1, \mathcal{V}_2 - 1)$$

is given by the same formula as $\tilde{\Phi}_{H,L_2}^{-L_1}$, except with \mathcal{V}_2 set to 1.

(3) The map

$$\tilde{\Phi}_{H,L_1}^{-L_2} : \mathcal{CFL}^-(H)/(\mathcal{U}_2 - 1) \rightarrow \mathcal{CFL}^-(H)/(\mathcal{V}_2 - 1)$$

is given by the formula

$$\tilde{\Phi}_{H,L_1}^{-L_2} = \begin{array}{l} \mathbf{a} \longmapsto \mathcal{U}_1 \mathbf{a} \\ \mathbf{b} \longmapsto 0 \\ \mathbf{c} \longmapsto \mathbf{b} + \mathcal{U}_1 \mathbf{c} \\ \mathbf{d} \longmapsto \mathbf{a} \end{array},$$

extended equivariantly over $\mathbb{F}[\mathcal{U}_1, \mathcal{V}_1]$, and sending \mathcal{V}_2 to \mathcal{U}_2 .

(4) The map

$$\tilde{\Phi}_{L_2, \emptyset}^{-L_2} : \mathcal{CFL}^-(H)/(\mathcal{V}_1 - 1, \mathcal{U}_2 - 1) \rightarrow \mathcal{CFL}^-(H)/(\mathcal{V}_1 - 1, \mathcal{V}_2 - 1)$$

is given by the same formula as $\tilde{\Phi}_{H,L_1}^{-L_2}$, except with \mathcal{V}_1 set to 1.

(5) The length 2 map

$$\tilde{\Phi}_{H, \emptyset}^{-H} : \mathcal{CFL}^-(H)/(\mathcal{U}_1 - 1, \mathcal{U}_2 - 1) \rightarrow \mathcal{CFL}^-(H)/(\mathcal{V}_1 - 1, \mathcal{V}_2 - 1)$$

is given by the formula

$$\tilde{\Phi}_{H, \emptyset}^{-H} = \begin{array}{l} \mathbf{a} \longmapsto \mathbf{c} \\ \mathbf{b} \longmapsto 0 \\ \mathbf{c} \longmapsto \mathbf{d} \\ \mathbf{d} \longmapsto \mathbf{c} \end{array},$$

extended to send \mathcal{V}_1 to \mathcal{U}_1 and \mathcal{V}_2 to \mathcal{U}_2 .

(6) The length 1 maps with positively oriented components, e.g. $\tilde{\Phi}_{H,L_2}^{L_1}$, are the canonical quotient maps. The length 2 maps vanish for any orientation other than $-H$.

Remark 11.2. As we will see in the proof of the above proposition, all of the maps in the surgery hypercube for H are uniquely determined by the chain complex $\mathcal{CFL}^-(H)$, except for the length 2 map $\tilde{\Phi}_{H,L_2}^{L_1}$, which requires additional information to compute.

Proof. We focus first on the length 1 maps. Consider the complexes

$$\mathcal{C}/(\mathcal{U}_1 - 1) = \begin{array}{ccc} \mathbf{a} \leftarrow \mathcal{U}_2 - \mathbf{b} & & \\ \uparrow & & | \\ \mathcal{V}_1 & & 1 \\ | & & \downarrow \\ \mathbf{c} - \mathcal{V}_2 \rightarrow \mathbf{d}. & & \end{array} \quad \text{and} \quad \mathcal{C}/(\mathcal{V}_1 - 1) = \begin{array}{ccc} \mathbf{a} \leftarrow \mathcal{U}_2 - \mathbf{b} & & \\ \uparrow & & | \\ 1 & & \mathcal{U}_1 \\ | & & \downarrow \\ \mathbf{c} - \mathcal{V}_2 \rightarrow \mathbf{d}. & & \end{array}$$

The map $\tilde{\Phi}_{H,L_2}^{-L_1}$ is a homotopy equivalence between these two complexes, which is $\mathbb{F}[\mathcal{U}_2, \mathcal{V}_2]$ -equivariant, and sends \mathcal{V}_1 to \mathcal{U}_1 . We perform the following changes of basis:

$$\mathcal{C}/(\mathcal{U}_1 - 1) \cong \begin{array}{ccc} \mathbf{a} & & \mathbf{b} \\ \uparrow & & | \\ \mathcal{V}_1 + \mathcal{U}_2 \mathcal{V}_2 & & 1 \\ | & & \downarrow \\ \mathbf{c} + \mathcal{V}_2 \mathbf{b} & & \mathbf{d} + \mathcal{U}_2 \mathbf{a}. \end{array} \quad \text{and} \quad \mathcal{C}/(\mathcal{V}_1 - 1) \cong \begin{array}{ccc} \mathbf{a} + \mathcal{V}_2 \mathbf{d} & & \mathbf{b} + \mathcal{U}_2 \mathbf{c} \\ \uparrow & & | \\ 1 & & \mathcal{U}_1 + \mathcal{U}_2 \mathcal{V}_2 \\ | & & \downarrow \\ \mathbf{c} & & \mathbf{d} \end{array} \quad (11.3)$$

We may view each of the above complexes as the knot Floer complex for an unknot, with an extra free-basepoint. In the following we write $\text{gr}_{\mathbf{w}}$ for the grading induced by the complete collection of basepoints consisting of the \mathbf{w} -type link basepoints (i.e. the ones where the unknot intersects the Heegaard surface negatively), and all the free-basepoints. We write $\text{gr}_{\mathbf{z}}$ for the grading induced by the complete collection consisting of the \mathbf{z} -type basepoints and the free-basepoints. We may easily compute the $(\text{gr}_{\mathbf{w}}, \text{gr}_{\mathbf{z}})$ -gradings of the all of the quotiented complexes, viewed in this manner:

$$\begin{array}{ccc} \mathbf{a} \xrightarrow{(\text{gr}_{\mathbf{w}}, \text{gr}_{\mathbf{z}})} (0, 0) & & \mathbf{a} \longmapsto (0, -2) \\ \mathcal{C}/(\mathcal{U}_1 - 1) : \mathbf{b} \longmapsto (-1, 1) & \mathcal{C}/(\mathcal{V}_1 - 1) : \mathbf{b} \longmapsto (-1, -1) & \\ \mathbf{c} \longmapsto (-1, -1) & \mathbf{c} \longmapsto (1, -1) & \\ \mathbf{d} \longmapsto (-2, 0) & \mathbf{d} \longmapsto (0, 0) & \\ \\ \mathbf{a} \longmapsto (-2, 0) & & \mathbf{a} \longmapsto (0, 0) \\ \mathcal{C}/(\mathcal{U}_2 - 1) : \mathbf{b} \longmapsto (-1, 1) & \mathcal{C}/(\mathcal{V}_2 - 1) : \mathbf{b} \longmapsto (-1, -1) & \\ \mathbf{c} \longmapsto (-1, -1) & \mathbf{c} \longmapsto (1, -1) & \\ \mathbf{d} \longmapsto (0, 0) & \mathbf{d} \longmapsto (0, -2) & \end{array}$$

The homotopy equivalence $\tilde{\Phi}_{H,L_2}^{-L_1}$ is grading preserving with respect to the above gradings, since it is the map for changing Heegaard diagrams. It is straightforward to see from Equation (11.3) that there is a unique choice of non-zero chain map from $\mathcal{C}/(\mathcal{U}_1 - 1)$ to $\mathcal{C}/(\mathcal{V}_1 - 1)$ which is $(\text{gr}_{\mathbf{w}}, \text{gr}_{\mathbf{z}})$ -grading preserving, is $\mathbb{F}[\mathcal{U}_2, \mathcal{V}_2]$ -equivariant, and sends \mathcal{V}_1 to \mathcal{U}_1 . (Note here we are using the $(\text{gr}_{\mathbf{w}}, \text{gr}_{\mathbf{z}})$ -bigrading obtained by viewing $\mathcal{C}/(\mathcal{U}_1 - 1)$ and $\mathcal{C}/(\mathcal{V}_1 - 1)$ as the complex of an unknot, shown above; we are not using the gradings naively inherited from the Hopf link). This map is the homotopy equivalence $\tilde{\Phi}_{H,L_2}^{-L_1}$ in the map in the statement. By a symmetric argument, one obtains the formula for $\tilde{\Phi}_{H,L_1}^{-L_2}$ in the statement.

Next, by the definition of a basic system, the map $\tilde{\Phi}_{L_1, \emptyset}^{-L_1}$ is obtained by quotienting the domain and range of $\tilde{\Phi}_{H, L_2}^{-L_1}$ by $\mathcal{V}_2 - 1$. The maps $\tilde{\Phi}_{H, L_1}^{-L_2}$ and $\tilde{\Phi}_{L_2, \emptyset}^{-L_2}$ are related by a similar relation.

We now consider the diagonal map of the cube. Firstly, since we are working with a basis system, the length 2 map vanishes except for the orientation $-H$ (i.e. all components oriented negatively). In our present notation, this is the map

$$\tilde{\Phi}_{H, \emptyset}^{-H}: \mathcal{C}/(\mathcal{U}_1 - 1, \mathcal{U}_2 - 1) \rightarrow \mathcal{C}/(\mathcal{V}_1 - 1, \mathcal{V}_2 - 1).$$

We define the map

$$E := \tilde{\Phi}_{L_1, \emptyset}^{-L_1} \circ \tilde{\Phi}_{H, L_1}^{-L_2} + \tilde{\Phi}_{L_2, \emptyset}^{-L_2} \circ \tilde{\Phi}_{H, L_2}^{-L_1}. \quad (11.4)$$

Using our computations of the length 1 maps of the cube, we compute E to be

$$E = \begin{array}{l} \mathbf{a} \longmapsto \mathbf{a} + \mathbf{d} \\ \mathbf{b} \longmapsto 0 \\ \mathbf{c} \longmapsto (\mathcal{U}_1 + \mathcal{U}_2)\mathbf{c} \\ \mathbf{d} \longmapsto \mathbf{a} + \mathbf{d}, \end{array}$$

extended linearly by sending \mathcal{V}_1 to \mathcal{U}_1 and \mathcal{V}_2 to \mathcal{U}_2 .

Up to an overall chain homotopy intertwining $\mathbb{F}[\mathcal{V}_1, \mathcal{V}_2]$ and $\mathbb{F}[\mathcal{U}_1, \mathcal{U}_2]$, there are two choices for a graded null-homotopy of the map E . These are the maps:

$$H_1 := \begin{array}{l} \mathbf{a} \longmapsto \mathbf{c} \\ \mathbf{b} \longmapsto 0 \\ \mathbf{c} \longmapsto 0 \\ \mathbf{d} \longmapsto \mathbf{c}, \end{array} \quad \text{and} \quad H_2 := \begin{array}{l} \mathbf{a} \longmapsto \mathbf{c} \\ \mathbf{b} \longmapsto 0 \\ \mathbf{c} \longmapsto \mathbf{d} \\ \mathbf{d} \longmapsto \mathbf{c}, \end{array} \quad (11.5)$$

This is observed since H_1 and H_2 are easily checked to be valid homotopies, and up to chain homotopy, there is exactly one non-trivial $+1$ graded map from $\mathcal{C}/(\mathcal{U}_1 - 1, \mathcal{U}_2 - 1)$ to $\mathcal{C}/(\mathcal{V}_1 - 1, \mathcal{V}_2 - 1)$. This is the map which sends \mathbf{c} to \mathbf{d} , sends \mathcal{V}_i to \mathcal{U}_i , and vanishes on other generators. Hence, H_1 and H_2 are the only possible choices, up to further homotopy. We prove in the subsequent Lemma 11.3 that H_1 is not a valid choice, due to other formal properties of the hypercube, and hence the length 2 map of the surgery hypercube is H_2 . \square

We consider a point $p \in \alpha$, which we use to define a map A_p , counting disks weighted by the difference in multiplicities on the two sides of the point p . Note that the map A_p may be identified with the relative homology map of [Zem15, Section 5] if we pick a path λ which connects a basepoint on L_1 to a basepoint on L_2 and satisfies $\lambda \cap \alpha = \{p\}$.

The map A_p is defined on $\mathcal{CFL}^-(H)$, and is easily computed by counting holomorphic bigons to be given by the formula

$$A_p = \begin{array}{ccc} \mathbf{a} & \xrightarrow{\mathcal{V}_2} & \mathbf{b} \\ \downarrow \mathcal{U}_1 & & \uparrow \mathcal{V}_1 \\ \mathbf{c} & \xrightarrow{\mathcal{V}_2} & \mathbf{d} \\ & \xleftarrow{\mathcal{U}_2} & \end{array} = \begin{array}{l} \mathbf{a} \longmapsto \mathcal{V}_2 \mathbf{b} + \mathcal{U}_1 \mathbf{c} \\ \mathbf{b} \longmapsto 0 \\ \mathbf{c} \longmapsto \mathcal{V}_2 \mathbf{d} \\ \mathbf{d} \longmapsto \mathcal{U}_2 \mathbf{c} + \mathcal{V}_1 \mathbf{b} \end{array}$$

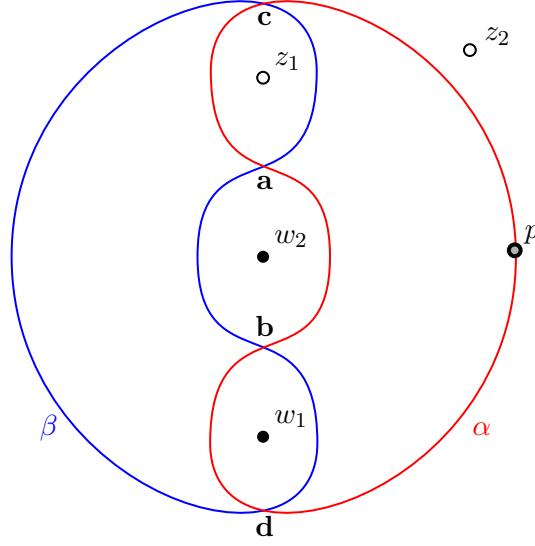

FIGURE 11.1. A diagram for the Hopf link with a special point $p \in \alpha$.

There is an extension of the map A_p for hypercubes, which is described in [HHSZ21b]. We recall the construction presently. Suppose that α is a set of alpha attaching curves, and \mathcal{L}_β is a hypercube of beta attaching curves, both on a pointed surface (Σ, \mathbf{w}) . Suppose that p is a point on an alpha circle α , and that the two components of $\Sigma \setminus \alpha$ which have α along their boundary contain the basepoints w and w' . We formally define the 1-dimensional hypercube

$$\mathcal{L}_\alpha^p = \alpha \xrightarrow{p} \alpha.$$

We may pair \mathcal{L}_α^p and \mathcal{L}_β to obtain a morphism of hypercubes, which we write as

$$CF^-(\mathcal{L}_\alpha^p, \mathcal{L}_\beta, \mathbf{w}) = \left(CF^-(\alpha, \mathcal{L}_\beta, \mathbf{w}) \xrightarrow{\mathcal{A}_p} CF^-(\alpha, \mathcal{L}_\beta, \mathbf{w}) \right).$$

To define the map \mathcal{A}_p , we formally view p as an input to the holomorphic polygon counting maps by defining $f_{\alpha, \alpha, \beta_1, \dots, \beta_{n-1}}(p, \mathbf{x}_1, \dots, \mathbf{x}_{n-1})$ to count holomorphic n -gons on the diagram $(\Sigma, \alpha, \beta_1, \dots, \beta_{n-1}, \mathbf{w})$ representing classes ψ of Maslov index $3 - n$, weighted by the quantity $\#(\partial_\alpha \psi) \cap \{p\}$. Using Gromov compactness, the standard proof that pairing hypercubes of attaching curves gives a hypercube of chain complexes instead adapts to give the relation

$$[\partial, \mathcal{A}_p] = (U_w + U_{w'}) \cdot \text{id}.$$

If $w \neq w'$, then the terms on the right hand side are contributed by the two index 2 alpha boundary degenerations which have p along their boundary. One of these degenerations covers w and the other covers w' . If $w = w'$, then the right hand side is 0. Further details are explained in [HHSZ21b]. See also [Zem15, Lemma 5.1] for the case of ordinary Heegaard Floer complexes.

The above construction of $CF^-(\mathcal{L}_\alpha^p, \mathcal{L}_\beta, \mathbf{w})$ also works if \mathcal{L}_β is a hypercube of beta attaching circles with basepoint slides, because the length one map for a basepoint slide is a tautological isomorphism.

With these considerations in mind, we obtain a diagram of the following form:

$$\begin{array}{ccccc}
\mathcal{C}/(\mathcal{U}_1 - 1, \mathcal{U}_2 - 1) & \xrightarrow{\tilde{\Phi}^{-L_1}} & \mathcal{C}/(\mathcal{V}_1 - 1, \mathcal{U}_2 - 1) & & \\
\downarrow \tilde{\Phi}^{-L_2} & \searrow A_p & \downarrow h_p^{-L_1} & \searrow A_p & \\
& \mathcal{C}/(\mathcal{U}_1 - 1, \mathcal{U}_2 - 1) & \xrightarrow{\tilde{\Phi}^{-L_1}} & \mathcal{C}/(\mathcal{V}_1 - 1, \mathcal{U}_2 - 1) & \\
\downarrow \tilde{\Phi}^{-L_2} & \searrow H & \downarrow \tilde{\Phi}^{-L_2} & \searrow H & \\
& \mathcal{C}/(\mathcal{U}_1 - 1, \mathcal{V}_2 - 1) & \xrightarrow{\tilde{\Phi}^{-L_1}} & \mathcal{C}/(\mathcal{V}_1 - 1, \mathcal{V}_2 - 1) & \\
\downarrow \tilde{\Phi}^{-L_2} & \searrow A_p & \downarrow h_p^{-L_1} & \searrow A_p & \\
& \mathcal{C}/(\mathcal{U}_1 - 1, \mathcal{V}_2 - 1) & \xrightarrow{\tilde{\Phi}^{-L_1}} & \mathcal{C}/(\mathcal{V}_1 - 1, \mathcal{V}_2 - 1) & \\
& & & & (11.6)
\end{array}$$

In the above diagram, both maps labeled $h_p^{-L_2}$ are induced by a single map from $\mathcal{C}/(\mathcal{V}_2 - 1)$ to $\mathcal{C}/(\mathcal{U}_2 - 1)$. The map labeled $h_p^{-L_1}$ is similar.

The diagram in Equation (11.6) does not satisfy the hypercube relations. Instead, if we view it as $\text{Cone}(\mathcal{A}_p)$, where \mathcal{A}_p is a morphism from the back face to the front face, then

$$[\partial, \mathcal{A}_p] = (\mathcal{U}_1 \mathcal{V}_1 + \mathcal{U}_2 \mathcal{V}_2) \cdot \text{id}.$$

We now analyze the maps labeled $h_p^{-L_i}$. Consider first $h_p^{-L_2}$. Both instances of this map is induced by a single map from $\mathcal{C}/(\mathcal{U}_2 - 1)$ to $\mathcal{C}/(\mathcal{V}_2 - 1)$, for which we also write $h_p^{-L_2}$. This maps preserves the Maslov bigradings, if we view $\mathcal{C}/(\mathcal{U}_2 - 1)$ and $\mathcal{C}/(\mathcal{V}_2 - 1)$ as the link Floer complexes for an unknot with an extra free basepoint. Extending the observation from the proof of Proposition 11.1 that we used to compute the length 1 maps, there were exactly two grading preserving chain maps from $\mathcal{C}/(\mathcal{U}_2 - 1)$ to $\mathcal{C}/(\mathcal{V}_2 - 1)$ which are $\mathbb{F}[\mathcal{U}_1, \mathcal{V}_1]$ -equivariant, and send \mathcal{V}_2 to \mathcal{U}_2 : the zero map, and the map labeled $\tilde{\Phi}^{-L_2}$. This observation constrains $h_p^{-L_2}$ to be one of two maps, which differ by the map $\tilde{\Phi}^{-L_2}$. The same comment applies for $h_p^{-L_1}$.

We compute that directly

$$[\tilde{\Phi}^{-L_1}, A_p] = 0.$$

Hence, by the above observation, we conclude that

$$h_p^{-L_1} = s \cdot \tilde{\Phi}^{-L_1} \quad (11.7)$$

for some $s \in \mathbb{F}$.

Similarly, we compute that

$$\begin{array}{l}
\mathbf{a} \longmapsto 0 \\
[\tilde{\Phi}^{-L_2}, A_p] = \mathbf{b} \longmapsto 0 \\
\mathbf{c} \longmapsto \mathcal{U}_2 \mathbf{a} + \mathcal{U}_1 \mathbf{d} \\
\mathbf{d} \longmapsto 0.
\end{array}$$

Hence,

$$h_p^{-L_2} = (\mathbf{c} \mapsto \mathbf{b}) + t \cdot \tilde{\Phi}^{-L_2}, \quad (11.8)$$

for some $t \in \mathbb{F}$.

Using the above observations, we are now able to compute the length 2 map of the link surgery hypercube of the Hopf link:

Lemma 11.3. *The length 3 hypercube relation in Equation (11.6) is satisfiable with H_2 , but not with H_1 . Hence H_2 is the length 2 map of the Hopf link surgery hypercube.*

Proof. For $i \in \{1, 2\}$, let C_i denote the sum of compositions of maps in (11.6) which would appear in the length 3 relation, except for $[\partial, \omega_p]$. Here, C_i is computed with the map $H = H_i$. The hypercube relations are satisfiable with H_i if and only if $C_i \simeq 0$.

We have determined the maps $h_p^{-L_2}$ and $h_p^{-L_1}$ up to a minor ambiguity, as shown in equations (11.7) and (11.8). Note that changing the value of s in $h_p^{-L_1}$ changes C_i by addition of the map E from (11.4), which we already know to be null-homotopic. Hence, it is sufficient to consider the case where $s = t = 0$.

One easily computes

$$C_1 = [h_p^{-L_2}, \tilde{\Phi}^{-L_1}] + [H_1, A_p] = \begin{array}{l} \mathbf{a} \longmapsto \mathbf{d} \\ \mathbf{b} \longmapsto 0 \\ \mathbf{c} \longmapsto \mathbf{b} + \mathcal{U}_2 \mathbf{c} \\ \mathbf{d} \longmapsto \mathbf{d}, \end{array}$$

which is not null-homotopic. Hence, H_1 is not a valid choice. It is easily checked that in fact

$$[h_p^{-L_2}, \tilde{\Phi}^{-L_1}] + [H_2, A_p] = 0.$$

Hence, the diagonal map must be H_2 . □

Remark 11.4. View the maps H_1 and H_2 as being $\mathbb{F}[U_1, U_2]$ -equivariant, where U_i acts by \mathcal{V}_i on the domain, and \mathcal{U}_i on the codomain. The maps H_1 and H_2 are homotopic over $\mathbb{F}[U_1]$ or $\mathbb{F}[U_2]$, but not over $\mathbb{F}[U_1, U_2]$. If we wanted to compute the Heegaard Floer homology of surgeries on the Hopf link, either H_1 or H_2 would give the same answer. See [Liu14, Section 5.2]. Since we will be taking tensor products, we need to know the length 2 map over the ring $\mathbb{F}[U_1, U_2]$, and there are algebraically two distinct models.

11.2. A_∞ perspectives on the Hopf link complex. In this section, we describe several A_∞ interpretations of the Hopf link complex. We will describe how to think of the Hopf link as a type- D module or a type- DA module. This perspective was first explored in [HHSZ21a].

Write $H = L_1 \cup L_2$ for the Hopf link. Write $P_1 = \mathbb{F}[\mathcal{U}_1, \mathcal{V}_1]$ and $P_2 = \mathbb{F}[\mathcal{U}_2, \mathcal{V}_2]$, where P_i contains the variables for L_i . Let us write \mathcal{C} for $\mathcal{CFL}^-(H)$.

We may view \mathcal{C} as a type- D module over P_2 . We do this by viewing \mathcal{C}^{P_2} as freely generated by \mathbf{a} , \mathbf{b} , \mathbf{c} and \mathbf{d} over P_1 . The structure map δ^1 is shown below:

$$\mathcal{C}^{P_2} \cong \begin{array}{ccc} & \mathbf{a} \xleftarrow{1|\mathcal{U}_2} & \mathbf{b} \\ \uparrow \gamma_1|1 & & \mathcal{U}_1|1 \downarrow \\ & \mathbf{c} \xrightarrow{1|\mathcal{V}_2} & \mathbf{d} \end{array} \quad (11.9)$$

An arrow from \mathbf{x} to \mathbf{y} labeled by $a|b$ indicates that $\delta^1(\mathbf{x})$ has a summand of $(a \cdot \mathbf{y}) \otimes b$.

It is helpful to realize that the above description of \mathcal{C}^{P_2} may be further decomposed as a box tensor product, as follows. Let Λ_2 denote the exterior algebra on two generators

$$\Lambda_2 := \Lambda^*(\phi_2, \psi_2).$$

There is a type- DD bimodule ${}^{\Lambda_2}\mathcal{K}^{P_2}$, (the canonical Koszul dualizing bimodule between the polynomial ring and the exterior algebra). As a vector space, $\mathcal{K} \cong \mathbb{F}$. The type- DD structure map is given by the formula

$$\delta^{1,1}(1) = \phi_2|1|\mathcal{U}_2 + \psi_2|1|\mathcal{V}_2.$$

We may define a type- A module \mathcal{C}_{Λ_2} , generated freely over P_1 by \mathbf{a} , \mathbf{b} , \mathbf{c} and \mathbf{d} , with module structure given by the following diagram

$$\mathcal{C}_{\Lambda_2} = \begin{array}{ccc} & \mathbf{a} \xleftarrow{\phi_2} & \mathbf{b} \\ \uparrow \gamma_1 & & \mathcal{U}_1 \downarrow \\ & \mathbf{c} \xrightarrow{\psi_2} & \mathbf{d} \end{array}$$

In the above, solid arrows denote the m_2 actions of Λ_2 , while the dashed arrows denote the m_1 actions (i.e. internal differentials). To illustrate the notation, if $f \in \mathbb{F}[\mathcal{U}_1, \mathcal{V}_1]$, then

$$m_2(f \cdot \mathbf{b}, \phi_2) = f \cdot \mathbf{a} \quad \text{and} \quad m_1(f \cdot \mathbf{b}) = \mathcal{U}_1 \cdot f \cdot \mathbf{d}.$$

The action of ψ_2 is similar.

Clearly, there is an isomorphism of type- D modules

$$\mathcal{C}^{P_2} \cong \mathcal{C}_{\Lambda_2} \boxtimes {}^{\Lambda_2}\mathcal{K}^{P_2}.$$

In the above, we have forgotten about the natural action of P_1 , given by ordinary multiplication. In fact, we may incorporate additionally this action to obtain bimodules ${}_{P_1}\mathcal{C}^{P_2}$ and ${}_{P_1}\mathcal{C}_{\Lambda_2}$, such that

$${}_{P_1}\mathcal{C}^{P_2} \cong {}_{P_1}\mathcal{C}_{\Lambda_2} \boxtimes {}^{\Lambda_2}\mathcal{K}^{P_2}.$$

The module ${}_{P_1}\mathcal{C}^{P_2}$ has only δ_1^1 and δ_2^1 non-trivial, and ${}_{P_1}\mathcal{C}_{\Lambda_2}$ has only $m_{0,1,0}$, $m_{1,1,0}$ and $m_{0,1,1}$ non-trivial. In the next section, we explore minimal models.

11.3. Minimal models for the Hopf link complex. We apply the homological perturbation lemma to obtain minimal models of the Hopf link bimodules from the previous section. We will define a DA -bimodule ${}_{P_1}Z^{P_2}$ which is homotopy equivalent to ${}_{P_1}\mathcal{C}^{P_2}$ and which has $\delta_1^1 = 0$.

First define the chain complex \mathcal{C}_0 by forgetting about the Λ_2 -action on \mathcal{C}_{Λ_2} . Over \mathbb{F}_2 , \mathcal{C}_0 is homotopy equivalent to its homology, which we view as the vector space

$$Z := \langle \mathbf{a} \rangle[\mathcal{U}_1] \oplus \langle \mathbf{d} \rangle[\mathcal{V}_1].$$

Here, $\langle \mathbf{a} \rangle[\mathcal{U}_1]$ denotes a copy of $\mathbb{F}[\mathcal{U}_1]$, generated by \mathbf{a} , and similarly for $\langle \mathbf{d} \rangle[\mathcal{V}_1]$. There are natural maps

$$i: Z \rightarrow \mathcal{C}_0 \quad \pi: \mathcal{C}_0 \rightarrow Z, \quad \text{and} \quad h: \mathcal{C}_0 \rightarrow \mathcal{C}_0$$

such that i and π are chain maps, $i \circ \pi = \text{id} + [m_1, h]$, $\pi \circ i = \text{id}$, $h \circ i = 0$, $\pi \circ h = 0$ and $h \circ h = 0$. The map i is given by

$$i(\mathcal{U}_1^n \mathbf{a}) = \mathcal{U}_1^n \mathbf{a} \quad \text{and} \quad i(\mathcal{V}_1^n \mathbf{d}) = \mathcal{V}_1^n \mathbf{d}.$$

The map π is given by

$$\pi(\mathcal{U}_1^n \mathcal{V}_1^m \mathbf{a}) = \begin{cases} \mathcal{U}_1^n \mathbf{a} & \text{if } m = 0 \\ 0 & \text{otherwise,} \end{cases} \quad \text{and} \quad \pi(\mathcal{U}_1^n \mathcal{V}_1^m \mathbf{d}) = \begin{cases} \mathcal{V}_1^m \mathbf{d} & \text{if } n = 0 \\ 0 & \text{otherwise.} \end{cases}$$

The map h is given by

$$h(\mathcal{U}_1^n \mathcal{V}_1^m \mathbf{a}) = \begin{cases} \mathcal{U}_1^n \mathcal{V}_1^{m-1} \mathbf{c} & \text{if } m \geq 1 \\ 0 & \text{otherwise,} \end{cases} \quad \text{and} \quad h(\mathcal{U}_1^n \mathcal{V}_1^m \mathbf{d}) = \begin{cases} \mathcal{U}_1^{n-1} \mathcal{V}_1^m \mathbf{b} & \text{if } n \geq 1 \\ 0 & \text{otherwise.} \end{cases}$$

The homological perturbation lemma for A_∞ -modules, Lemma 4.1, endows Z with a right action of Λ_2 , for which we write Z_{Λ_2} , which is A_∞ -homotopy equivalent to \mathcal{C}_{Λ_2} . In fact, the homotopy equivalence is given explicitly by the homological perturbation lemma. The maps i , π and h extend to A_∞ -module morphisms i_* , π_* and h_* . We box these morphisms with the identity map on ${}^{\Lambda_2}\mathcal{X}^{P_2}$ to obtain maps of type- D modules

$$\Pi^1: \mathcal{C}^{P_2} \rightarrow Z^{P_2}, \quad I^1: Z^{P_2} \rightarrow \mathcal{C}^{P_2} \quad \text{and} \quad H^1: \mathcal{C}^{P_2} \rightarrow \mathcal{C}^{P_2}.$$

Lemma 11.5. *The morphisms I^1 and Π^1 are type- D homomorphisms (i.e. $\partial_{\text{Mor}}(I^1) = 0$ and $\partial_{\text{Mor}}(\Pi^1) = 0$). Furthermore*

- (1) $\Pi^1 \circ I^1 = \text{id}$
- (2) $H^1 \circ H^1 = 0$.
- (3) $H^1 \circ I^1 = 0$.
- (4) $\Pi^1 \circ H^1 = 0$.
- (5) $I^1 \circ \Pi^1 = \text{id} + \partial_{\text{Mor}}(H^1)$.

Proof. Lemma 4.1 (the homological perturbation lemma) implies that the stated formulas hold for i_* , h_* and π_* . Boxing with the identity map preserves these relations since the algebra is Λ_2 (which is an associative algebra), so

$$(f_* \boxtimes \mathbb{I}_{\mathcal{X}}) \circ (g_* \boxtimes \mathbb{I}_{\mathcal{X}}) = ((f_* \circ g_*) \boxtimes \mathbb{I}_{\mathcal{X}}),$$

by [LOT15, Remark 2.2.28]. Furthermore boxing with the identity is a chain map:

$$\partial_{\text{Mor}}(f_* \boxtimes \mathbb{I}_{\mathcal{X}}) = (\partial_{\text{Mor}}(f_*) \boxtimes \mathbb{I}_{\mathcal{X}}).$$

See [LOT15, Lemma 2.3.3 (1)]. □

It is enlightening to compute concrete formulas for the morphisms Π^1 , H^1 and I^1 :

Lemma 11.6.

(1) I^1 is given by $I^1(\mathbf{x}) = \mathbf{x} \otimes 1$, for $\mathbf{x} \in Z$.

(2) Π^1 vanishes on $\text{Span}(\mathbf{c}, \mathbf{d})$, and satisfies:

$$\begin{aligned} \Pi^1(\mathcal{U}_1^i \mathcal{V}_1^j \mathbf{a}) &= \begin{cases} \mathcal{U}_1^{i-j} \mathbf{a} \otimes \mathcal{U}_2^j \mathcal{V}_2^j & \text{if } i \geq j \\ \mathcal{V}_1^{j-i-1} \mathbf{d} \otimes \mathcal{U}_2^i \mathcal{V}_2^{i+1} & \text{if } i < j \end{cases} \\ \Pi^1(\mathcal{U}_1^i \mathcal{V}_1^j \mathbf{d}) &= \begin{cases} \mathcal{U}_1^{i-j-1} \mathbf{a} \otimes \mathcal{U}_2^{j+1} \mathcal{V}_2^j & \text{if } i > j \\ \mathcal{V}_1^{j-i} \mathbf{d} \otimes \mathcal{U}_2^i \mathcal{V}_2^i & \text{if } i \leq j. \end{cases} \end{aligned}$$

(3) H^1 vanishes on $\text{Span}(\mathbf{b}, \mathbf{c})$, and maps $\text{Span}(\mathbf{a}, \mathbf{d})$ to $\text{Span}(\mathbf{c}, \mathbf{b}) \otimes P_2$. It is given by the formula

$$H^1(\mathcal{U}_1^i \mathcal{V}_1^j \mathbf{a}) = \begin{cases} \mathcal{U}_1^i \mathcal{V}_1^{j-1} \mathbf{c} \otimes 1 + \mathcal{U}_1^{i-1} \mathcal{V}_1^{j-1} \mathbf{b} \otimes \mathcal{V}_2 + \dots + \mathcal{U}_1^{i-j} \mathbf{b} \otimes \mathcal{U}_2^{j-1} \mathcal{V}_2^j & \text{if } j \leq i \\ \mathcal{U}_1^i \mathcal{V}_1^{j-1} \mathbf{c} \otimes 1 + \mathcal{U}_1^{i-1} \mathcal{V}_1^{j-1} \mathbf{b} \otimes \mathcal{V}_2 + \dots + \mathcal{V}_1^{j-i-1} \mathbf{c} \otimes \mathcal{U}_2^i \mathcal{V}_2^i & \text{if } j > i. \end{cases}$$

and

$$H^1(\mathcal{U}_1^i \mathcal{V}_1^j \mathbf{d}) = \begin{cases} \mathcal{U}_1^{i-1} \mathcal{V}_1^j \mathbf{b} \otimes 1 + \mathcal{U}_1^{i-1} \mathcal{V}_1^{j-1} \mathbf{c} \otimes \mathcal{U}_2 + \dots + \mathcal{U}_1^{i-j-1} \mathbf{b} \otimes \mathcal{U}_2^j \mathcal{V}_2^j & \text{if } i > j \\ \mathcal{U}_1^{i-1} \mathcal{V}_1^j \mathbf{b} \otimes 1 + \mathcal{U}_1^{i-1} \mathcal{V}_1^{j-1} \mathbf{c} \otimes \mathcal{U}_2 + \dots + \mathcal{V}_1^{j-i} \mathbf{c} \otimes \mathcal{U}_2^j \mathcal{V}_2^{j-1} & \text{if } i \leq j. \end{cases}$$

Proof. Lemma 4.1 gives a concrete formula for the A_∞ -action on Z_{Λ_2} . We will prove the first statement, and also compute $\Pi^1(\mathcal{U}_1^i \mathcal{V}_1^j \mathbf{a})$ when $i \geq j$ in order to illustrate the technique. We will leave the remaining cases to the reader.

Firstly, we begin with I^1 . We are boxing with $\mathbb{I}_{\mathcal{X}}$, so suppose that $a_1 | \dots | a_n | 1 | b_n | \dots | b_1$ is the output of repeated applications of $\delta^{1,1}$ on $\Lambda_2 \mathcal{X}^{P_2}$. The homological perturbation lemma gives a recipe for $m_{n+1}^Z(\mathbf{x}, a_1, \dots, a_n)$. See Figure 4.1. The recipe is to include \mathbf{x} into \mathcal{C} via i . We then apply $m_2(-, a_1)$, then h , then $m_2(-, a_2)$, then h , and so forth, until one applies $m(-, a_n)$. Then we apply π . The algebra output is the product $b_n \dots b_1$. The m_2 action of Λ_2 on \mathcal{C} vanishes on the image of i , so there are no contributions unless $n = 0$. The formula follows.

We now compute $\Pi^1(\mathcal{U}_1^i \mathcal{V}_1^j \mathbf{a})$ for $i \geq j$. We begin at $\mathcal{U}_1^i \mathcal{V}_1^j \mathbf{a} \in \mathcal{C}$. If $j = 0$, then $h(\mathcal{U}_1^i \mathcal{V}_1^j \mathbf{a}) = 0$, so our only option is to apply π , which gives $\mathcal{U}_1^i \mathbf{a}$ as claimed. If $j > 0$, the only option is to apply h to get $\mathcal{U}_1^i \mathcal{V}_1^{j-1} \mathbf{c}$. Then we apply $m_2(-, \psi_2)$ which gives $\mathcal{U}_1^i \mathcal{V}_1^{j-1} \mathbf{d} \otimes \mathcal{V}_2$. We then apply h and $m_2(-, \phi_2)$ and we get $\mathcal{U}_1^{i-1} \mathcal{V}_1^{j-1} \mathbf{a} \otimes \mathcal{U}_2 \mathcal{V}_2$. We repeat this procedure until we cannot apply h or m_2 any more. In the case that $i \geq j$, the final term in this sequence will be $\mathcal{U}_1^{i-j} \mathbf{a} \otimes \mathcal{U}_2^j \mathcal{V}_2^j$. All of the remaining claims follow a similar analysis. \square

Lemma 11.5 allows us to apply the homological perturbation lemma of DA -bimodules, Lemma 4.2, which equips Z with a DA -bimodule structure $P_1 Z^{P_2}$, and supplies morphisms of DA -bimodules

$$\Pi_*^1: P_1 \mathcal{C}^{P_2} \rightarrow P_1 Z^{P_2}, \quad I_*^1: P_1 Z^{P_2} \rightarrow P_1 \mathcal{C}^{P_2} \quad \text{and} \quad H_*^1: P_1 \mathcal{C}^{P_2} \rightarrow P_1 \mathcal{C}^{P_2}$$

which satisfy relations identical to Lemma 11.5.

Lemma 11.7.

(1) The structure maps δ_j^1 on $P_1 Z^{P_2}$ vanish if $j \neq 2$.

- (2) The maps Π_j^1 and H_j^1 vanish unless $j = 1$.
- (3) The map I_j^1 vanishes if $j > 2$.
- (4) The maps δ_*^1 and I_*^1 are strictly unital i.e. they vanish if 1 is an input, except for δ_2^1 , which satisfies $\delta_2^1(1 \otimes x) = x \otimes 1$. (Note that H_j^1 and Π_j^1 are trivially unital, since they are only non-trivial if $j = 1$).

Proof. The proofs of all statements are by explicit examination of the maps from the homological perturbation lemma.

We begin with the statements about δ_j^1 . Consider first a sequence of algebra elements (a_n, \dots, a_1) in P_1 . The rule for computing δ_j^1 is to input via I^1 , then apply m_2 , then we apply pairs of H^1 followed by m_2 until we exhaust (a_n, \dots, a_1) , and then finally we apply Π_1 . The algebra elements output are multiplied together by applying μ_2 repeatedly. However applying m_2 does not move an elements position in \mathcal{C} (i.e. \mathbf{a} , \mathbf{b} , \mathbf{c} or \mathbf{d}). The map H^1 does change the generator, and it maps $\text{Span}(\mathbf{a}, \mathbf{d})$ to $\text{Span}(\mathbf{c}, \mathbf{b}) \otimes P_2$, and vanishes on $\text{Span}(\mathbf{c}, \mathbf{b})$. If we apply another m_2 , we remain in $\text{Span}(\mathbf{c}, \mathbf{b})$. We note that Π^1 and H^1 both vanish on $\text{Span}(\mathbf{c}, \mathbf{b})$. In particular, the only terms making non-trivial contribution are those with one δ_2^1 , and no H^1 term. The same argument shows that Π_k^1 and H_k^1 vanish if $k > 1$.

To compute the map $I_{j+1}^1(a_j, \dots, a_1, \mathbf{x})$, the recipe is to first include \mathbf{x} into $\mathcal{C} \otimes P_2$ via I^1 . This includes \mathbf{x} into $\text{Span}(\mathbf{a}, \mathbf{d}) \otimes P_2$. We then apply $\delta_2^1(a_1, -)$. This preserves $\text{Span}(\mathbf{a}, \mathbf{d}) \otimes P_2$. Next we apply H^1 , which maps $\text{Span}(\mathbf{a}, \mathbf{d}) \otimes P_2$ to $\text{Span}(\mathbf{b}, \mathbf{c}) \otimes P_2$. Any further applications of $\delta_2^1(a_n, -)$ followed by H^1 would map to zero. Hence we may have I_2^1 , but not I_j^1 for $j > 2$.

The final statement about strict unality follows from the homological perturbation lemma. \square

It is helpful to explicitly compute δ_2^1 on $P_1 Z^{P_2}$. Since there is no δ_j^1 for $j > 2$ by Lemma 11.7, we compute only $\delta_2^1(\mathcal{U}_1, -)$ and $\delta_2^1(\mathcal{V}_1, -)$.

Lemma 11.8. *The map δ_2^1 on $P_1 Z^{P_2}$ satisfies the following.*

- (1) $\delta_2^1(\mathcal{U}_1, \mathcal{U}_1^n \mathbf{a}) = \mathcal{U}_1^{n+1} \mathbf{a} \otimes 1$.
- (2) $\delta_2^1(\mathcal{V}_1, \mathcal{U}_1^n \mathbf{a}) = \begin{cases} \mathcal{U}_1^{n-1} \mathbf{a} \otimes \mathcal{U}_2 \mathcal{V}_2 & \text{if } n > 0 \\ \mathbf{d} \otimes \mathcal{V}_2 & \text{if } n = 0. \end{cases}$
- (3) $\delta_2^1(\mathcal{V}_1, \mathcal{V}_1^m \mathbf{d}) = \mathcal{V}_1^{m+1} \mathbf{d} \otimes 1$.
- (4) $\delta_2^1(\mathcal{U}_1, \mathcal{V}_1^m \mathbf{d}) = \begin{cases} \mathcal{V}_1^{m-1} \mathbf{d} \otimes \mathcal{U}_2 \mathcal{V}_2 & \text{if } m > 0 \\ \mathbf{a} \otimes \mathcal{U}_2 & \text{if } m = 0. \end{cases}$

Finally, the complex $\mathcal{V}_1^{-1} \mathcal{C}$ will also be important to understand. Similarly to \mathcal{C} , this complex also has a simple minimal model, for which we write ${}_{\mathcal{V}_1^{-1} P_1} W^{P_2}$. As a vector space $W \cong \mathbb{F}[\mathcal{V}_1, \mathcal{V}_1^{-1}]$. We view W as being generated by $\mathcal{V}_1^i \mathbf{d}$ for $i \in \mathbb{Z}$. The same homological perturbation argument as before equips W with bimodule structure ${}_{\mathcal{V}_1^{-1} P_1} W^{P_2}$ which has $\delta_j^1 = 0$ unless $j = 2$. For completeness we record the actions:

Lemma 11.9. *The bimodule ${}_{\mathcal{V}_1^{-1} P_1} W^{P_2}$ has the following action:*

$$\delta_2^1(\mathcal{U}_1^i \mathcal{V}_1^j, \mathcal{V}_1^n \mathbf{d}) = \mathcal{V}_1^{j+n-i} \mathbf{d} \otimes \mathcal{U}_2^i \mathcal{V}_2^j.$$

We leave the proofs of Lemma 11.8 and 11.9 to the reader.

12. THE HOPF LINK OVER \mathcal{K}

In this section, we compute the DA -bimodule for the Hopf link over the knot surgery algebra \mathcal{K} .

12.1. The DA -bimodule of the Hopf link surgery complex. Write L_1 and L_2 for the two components of the Hopf link. We pick an integral framing λ_1 on L_1 . We think of L_1 as being the type- A component of H , while we think of L_2 as being the type- D component. We will write

$$\kappa_1 \mathcal{H}_{(\lambda_1, 0)}^{\mathcal{K}_2}$$

for the bimodule where we equip L_1 with the framing λ_1 , and we equip L_2 with the 0 framing.

The bimodule $\mathcal{H}_{(\lambda_1, 0)}$ has both a left and right action of \mathbf{I} . As a vector space over \mathbb{F} , \mathcal{H} decomposes as the direct product of four summands

$$\mathcal{H}_{(\lambda_1, 0)} = \begin{array}{cc} \mathcal{H}_{0,0} & \mathcal{H}_{1,0} \\ \mathcal{H}_{0,1} & \mathcal{H}_{1,1} \end{array}$$

where

$$\mathbf{I}_i \cdot \mathcal{H}_{(\lambda_1, 0)} \cdot \mathbf{I}_j = \mathcal{H}_{i,j}.$$

As vector spaces, we have for each $\varepsilon_2 \in \{0, 1\}$ that

$$\mathcal{H}_{0,\varepsilon_2} \cong \langle \mathbf{a}, \mathbf{b}, \mathbf{c}, \mathbf{d} \rangle \otimes_{\mathbb{F}_2} \mathbb{F}[\mathcal{U}_1, \mathcal{V}_1] \quad \text{and} \quad \mathcal{H}_{1,\varepsilon_2} \cong \langle \mathbf{a}, \mathbf{b}, \mathbf{c}, \mathbf{d} \rangle \otimes_{\mathbb{F}} \mathbb{F}[\mathcal{U}_1, \mathcal{V}_1, \mathcal{V}_1^{-1}].$$

The map δ_1^1 encodes the internal differentials from $\mathcal{CFL}^-(H)$, as well as the length 1 surgery maps for the component L_2 . Schematically, δ_1^1 has the following form

$$\delta_1^1 = \begin{array}{ccc} \begin{array}{c} \partial_1^1 \rightrightarrows \mathcal{H}_{0,0} \\ \downarrow \\ L_2 F_1^1 + {}^{-}L_2 F_1^1 \\ \downarrow \\ \partial_1^1 \rightrightarrows \mathcal{H}_{0,1} \end{array} & & \begin{array}{c} \mathcal{H}_{1,0} \overleftarrow{\partial_1^1} \\ \downarrow \\ L_2 G_1^1 + {}^{-}L_2 G_1^1 \\ \downarrow \\ \mathcal{H}_{1,1} \overleftarrow{\partial_1^1} \end{array} \end{array}$$

where we describe the maps for each arrow shortly.

The map δ_2^1 schematically takes the following form:

$$\delta_2^1 = \begin{array}{ccc} M_2^1 \rightrightarrows \mathcal{H}_{0,0} & \xrightarrow{L_1 P_2^1 + {}^{-}L_1 P_2^1} & \mathcal{H}_{1,0} \overleftarrow{M_2^1} \\ & \searrow^{-H\Omega_2^1} & \\ M_2^1 \rightrightarrows \mathcal{H}_{0,1} & \xrightarrow{L_1 Q_2^1 + {}^{-}L_1 Q_2^1} & \mathcal{H}_{1,1} \overleftarrow{M_2^1} \end{array} .$$

The maps δ_j^1 vanish if $j > 2$. We now describe concrete formulas for the maps labeled above:

Proposition 12.1. *Give the negative Hopf link framing $(\lambda_1, 0)$, where λ_1 is the framing on L_1 , and 0 is the framing on L_2 . The structure maps of $\kappa_1 \mathcal{H}_{(\lambda_1, 0)}^{\mathcal{K}_2}$ are as follows:*

- (1) *The maps ∂_1^1 correspond to the ordinary differential of the Hopf link complex. See Equation (11.1).*
- (2) *The maps denoted ${}^{L_1}P_2^1$, ${}^{-L_1}P_2^1$, ${}^{L_1}Q_2^1$ and ${}^{-L_1}Q_2^1$ correspond to the length 1 surgery maps for L_1 . The maps ${}^{L_1}P_2^1$ and ${}^{L_1}Q_2^1$ share the same formula as each other, and the maps ${}^{-L_1}P_2^1$ and ${}^{-L_1}Q_2^1$ share the same formula as each other. They are given by the following formulas*

(a)

$$\begin{aligned} \sigma_1 \otimes \mathbf{a} &\longmapsto \mathbf{a} \otimes 1 \\ {}^{L_1}P_2^1 = \sigma_1 \otimes \mathbf{b} &\longmapsto \mathbf{b} \otimes 1 \\ \sigma_1 \otimes \mathbf{c} &\longmapsto \mathbf{c} \otimes 1 \\ \sigma_1 \otimes \mathbf{d} &\longmapsto \mathbf{d} \otimes 1. \end{aligned}$$

(b)

$$\begin{aligned} \tau_1 \otimes \mathbf{a} &\longmapsto \psi_1^{\lambda_1 - 1} \mathbf{d} \otimes 1 \\ {}^{-L_1}P_2^1 = \tau_1 \otimes \mathbf{b} &\longmapsto 0 \\ \tau_1 \otimes \mathbf{c} &\longmapsto \psi_1^{\lambda_1 + 1} \mathbf{b} \otimes 1 + \psi_1^{\lambda_1} \mathbf{c} \otimes \mathcal{U}_2 \\ \tau_1 \otimes \mathbf{d} &\longmapsto \psi_1^{\lambda_1} \mathbf{d} \otimes \mathcal{U}_2. \end{aligned}$$

- (3) *The maps ${}^{L_2}F_1^1$ and ${}^{-L_2}F_1^1$ are the surgery maps for the component L_2 , with L_1 unreduced. They are given by the following formulas:*

(a)

$$\begin{aligned} \mathbf{a} &\longmapsto \mathbf{a} \otimes \sigma_2 \\ {}^{L_2}F_1^1 = \mathbf{b} &\longmapsto \mathbf{b} \otimes \sigma_2 \\ \mathbf{c} &\longmapsto \mathbf{c} \otimes \sigma_2 \\ \mathbf{d} &\longmapsto \mathbf{d} \otimes \sigma_2. \end{aligned}$$

(b)

$$\begin{aligned} \mathbf{a} &\longmapsto \mathcal{U}_1 \mathbf{a} \otimes \tau_2 \\ {}^{-L_2}F_1^1 = \mathbf{b} &\longmapsto 0 \\ \mathbf{c} &\longmapsto \mathbf{b} \otimes \psi_2 \tau_2 + \mathcal{U}_1 \mathbf{c} \otimes \tau_2 \\ \mathbf{d} &\longmapsto \mathbf{a} \otimes \psi_2^{-1} \tau_2 \end{aligned}$$

The maps ${}^{L_2}G_1^1$ and ${}^{-L_2}G_1^1$ are the surgery maps L_2 , with L_1 already reduced. They are given by the same formulas.

- (4) *The maps denoted M_2^1 are the maps for δ_2^1 applied to algebra elements which do not change the idempotent. The action of M_2^1 corresponds to ordinary polynomial multiplication, and projection onto idempotents.*

(5) The map $^{-H}\Omega_2^1$ is the length 2 surgery map for $-H = -L_1 \cup -L_2$. This map takes the following form

$$\begin{aligned} \tau_1 \otimes \mathbf{a} &\longmapsto \mathcal{V}_1^{\lambda_1-2} \mathbf{c} \otimes \mathcal{V}_2^{-1} \tau_2 \\ \tau_1 \otimes \mathbf{b} &\longmapsto 0 \\ \tau_1 \otimes \mathbf{c} &\longmapsto \mathcal{V}_1^{\lambda_1-1} \mathbf{d} \otimes \tau_2 \\ \tau_1 \otimes \mathbf{d} &\longmapsto \mathcal{V}_1^{\lambda_1-1} \mathbf{c} \otimes \mathcal{V}_2^{-2} \tau_2. \end{aligned}$$

Proof. The proof is to use our computation of the surgery hypercube maps of the Hopf link complex, and translate them into the DA -bimodule perspective we described in Section 6.6. In Proposition 11.1, we computed the surgery hypercube maps on certain quotients of the link Floer homology of the Hopf link. Using the fact that the surgery hypercube maps are suitably equivariant with respect to $\mathbb{F}[\mathcal{U}_1, \mathcal{U}_1, \mathcal{V}_1, \mathcal{V}_2]$, as in Lemma 5.9, it suffices to compute each of the maps on \mathbf{a} , \mathbf{b} , \mathbf{c} and \mathbf{d} . The only indeterminacy that was not resolved in Proposition 11.1 were the powers of the \mathcal{V}_1 and \mathcal{V}_2 variables on each term of the maps. These powers are uniquely determined by the Alexander grading change of the descent map, in the sense of Lemma 5.7. If $\Lambda = (\lambda_1, \lambda_2)$ is a framing on H , Manolescu and Ozsváth construct the map for descent along $-L_1$ to change the Alexander by $(\lambda_1, lk(L_1, L_2)) = (\lambda_1, -1)$, and the maps for descent along $-L_2$ to similarly change the Alexander grading by $(-1, \lambda_2)$. With these conventions in mind, one readily checks that the above formulas follow from Proposition 11.1 and the Alexander gradings in Equation (11.2). \square

12.2. Minimal models over \mathcal{K} . In this section, we describe a minimal model of the DA -bimodule $\kappa_1 \mathcal{H}_{(\lambda_1, 0)}^{\mathcal{K}_2}$, considered in the previous section, which we denote by

$$\kappa_1 \mathcal{Z}_{(\lambda_1, 0)}^{\mathcal{K}_2}.$$

The existence of the minimal model follows from the homological perturbation lemma for hypercubes of DA -bimodules. From the description of $\kappa_1 \mathcal{H}_{(\lambda_1, 0)}^{\mathcal{K}_2}$ it is clear that there is a filtration by the cube \mathbb{E}_2 . In Section 11.3, we described minimal models of $\mathcal{CFL}(H)^{\mathbb{F}[\mathcal{U}_2, \mathcal{V}_2]}$ and $\mathcal{V}_1^{-1} \mathcal{CFL}(H)^{\mathbb{F}[\mathcal{U}_2, \mathcal{V}_2]}$. Note that we may identify the underlying type- D module $\mathcal{H}_\varepsilon^{\mathcal{K}_2}$ with one of these type- D modules, for $\varepsilon \in \mathbb{E}_2$. Hence, the construction from Section 11.3 may be viewed as giving morphisms of type- D structures

$$\Pi_\varepsilon^1: \mathcal{H}_\varepsilon^{\mathcal{K}_2} \rightarrow \mathcal{Z}_\varepsilon^{\mathcal{K}_2}, \quad I_\varepsilon^1: \mathcal{Z}_\varepsilon^{\mathcal{K}_2} \rightarrow \mathcal{H}_\varepsilon^{\mathcal{K}_2} \quad \text{and} \quad H_\varepsilon^1: \mathcal{H}_\varepsilon^{\mathcal{K}_2} \rightarrow \mathcal{H}_\varepsilon^{\mathcal{K}_2}$$

which induce a homotopy equivalence of type- D structures, such that furthermore the algebraic assumptions of the homological perturbation lemma are satisfied. We obtain a homotopy equivalent hypercube of DA -bimodules $\kappa_1 \mathcal{Z}_{(\lambda_1, 0)}^{\mathcal{K}_2}$ by applying the homological perturbation lemma for hypercubes of DA -bimodules, Lemma 4.5. We now schematically sketch the induced type- D structure map:

$$\begin{array}{ccc} \mathcal{Z}_{0,0} & \mathcal{Z}_{1,0} & m_2^1 \xrightarrow{\quad} \mathcal{Z}_{0,0} - {}^{L_1 p_2^1} + {}^{-L_1 p_2^1} \rightarrow \mathcal{Z}_{1,0} \xleftarrow{\quad} m_2^1 \\ \delta_1^1 = \begin{array}{c} \downarrow \\ \downarrow \\ \downarrow \end{array} & \begin{array}{c} \downarrow \\ \downarrow \\ \downarrow \end{array} & \delta_2^1 = \\ \mathcal{Z}_{0,1} & \mathcal{Z}_{1,1} & m_2^1 \xrightarrow{\quad} \mathcal{Z}_{0,1} - {}^{L_1 q_2^1} + {}^{-L_1 q_2^1} \rightarrow \mathcal{Z}_{1,1} \xleftarrow{\quad} m_2^1 \end{array}$$

$$\delta_3^1 = \begin{array}{ccc} & \mathcal{Z}_{0,0} & \mathcal{Z}_{1,0} \\ & \searrow^{-H\omega_3^1} & \searrow \\ & \mathcal{Z}_{0,1} & \mathcal{Z}_{1,1} \end{array}$$

Proposition 12.2. *Give the negative Hopf link framing $(\lambda_1, 0)$. The structure maps of the minimal model $\kappa_1 \mathcal{Z}_{(\lambda_1, 0)}^{\mathcal{K}_2}$ are as follows:*

- (1) The maps m_2^1 are the same as the δ_2^1 maps in Lemmas 11.8 and 11.9.
- (2) The maps $L_1 p_2^1$ and $L_1 q_2^1$ are given by the same formulas as each other, as are $-L_1 p_2^1$ and $-L_1 q_2^1$. They are determined by the following formulas:
 - (a) $L_1 p_2^1(\sigma_1, \mathcal{U}_1^i \mathbf{a}) = \mathcal{V}_1^{-i-1} \mathbf{d} \otimes \mathcal{U}_2^i \mathcal{V}_2^{i+1}$ and $L_1 p_2^1(\sigma_1, \mathcal{V}_1^j \mathbf{d}) = \mathcal{V}_1^j \mathbf{d} \otimes 1$.
 - (b) $-L_1 p_2^1(\tau_1, \mathcal{U}_1^i \mathbf{a}) = \mathcal{V}_1^{-i-1+\lambda_1} \mathbf{d} \otimes 1$ and $-L_1 p_2^1(\tau_1, \mathcal{V}_1^j \mathbf{d}) = \mathcal{V}_1^{j+\lambda_1} \mathbf{d} \otimes \mathcal{U}_2^{j+1} \mathcal{V}_2^j$.
 - (c) $L_1 p_2^1(\tau_1, -) = 0$ and $-L_1 p_2^1(\sigma_1, -) = 0$.
- (3) The maps for $\pm L_2$ are as follows:
 - (a) $L_2 f_1^1(\mathcal{U}_1^i \mathbf{a}) = \mathcal{U}_1^i \mathbf{a} \otimes \sigma_2$ and $L_2 f_1^1(\mathcal{V}_1^j \mathbf{d}) = \mathcal{V}_1^j \mathbf{d} \otimes \sigma_2$.
 - (b) $-L_2 f_1^1(\mathcal{U}_1^i \mathbf{a}) = \mathcal{U}_1^{i+1} \mathbf{a} \otimes \tau_2$ and

$$-L_2 f_1^1(\mathcal{V}_1^j \mathbf{d}) = \begin{cases} \mathbf{a} \otimes \mathcal{V}_2^{-1} \tau_2 & \text{if } j = 0 \\ \mathcal{V}_1^{j-1} \mathbf{d} \otimes \tau_2 & \text{if } j > 0. \end{cases}$$

- (c) $L_2 g_1^1(\mathcal{V}_1^i \mathbf{d}) = \mathcal{V}_1^i \mathbf{d} \otimes \sigma_2$.
- (d) $-L_2 g_1^1(\mathcal{V}_1^i \mathbf{d}) = \mathcal{V}_1^{i-1} \mathbf{d} \otimes \tau_2$.
- (4) The map $-H\omega_3^1$ is determined by the relations

$$\begin{aligned} -H\omega_3^1(\tau_1, \mathcal{V}_1^m, \mathcal{U}_1^i \mathbf{a}) &= \min(i+1, m) \mathcal{V}_1^{\lambda_1+m-i-2} \mathbf{d} \otimes \mathcal{U}_1^{m-1} \mathcal{V}_1^{m-1} \tau_2 \\ -H\omega_3^1(\tau_1, \mathcal{U}_1^n, \mathcal{U}_1^i \mathbf{a}) &= 0 \\ -H\omega_3^1(\tau_1, \mathcal{U}_1^n, \mathcal{V}_1^j \mathbf{d}) &= \min(n, j) \mathcal{V}_1^{j-n+\lambda_1-1} \mathbf{d} \otimes \mathcal{U}_1^{j-1} \mathcal{V}_2^{j-2} \tau_2 \\ -H\omega_3^1(\tau_1, \mathcal{V}_1^m, \mathcal{V}_1^j \mathbf{d}) &= 0, \end{aligned}$$

and that $-H\omega_3^1$ vanishes if an algebra input is a multiple of σ_1 . The map $-H\omega_3^1$ also vanishes on pairs of algebra elements with other configurations of idempotents.

Remark 12.3. We have not enumerated a complete list of the structure maps. Additional powers of \mathcal{U}_1 and \mathcal{V}_1 may be added to arguments in the above maps. There are no terms of δ_{j+1}^1 for $j > 2$ however. A more minimal list could also have been made by specifying the length 1 maps on only \mathbf{a} and \mathbf{d} . As an example of several relations which are forced by the DA bimodule relations, we have

$$\begin{aligned} -H\omega_3^1(\tau_1, \mathcal{U}_1^i \mathcal{V}_1^j, \mathcal{U}_1^n \mathbf{a}) &= -H\omega_3^1(\tau, \mathcal{V}_1^j, \mathcal{U}_1^{i+n} \mathbf{a}) \quad \text{and} \\ -H\omega_3^1(\tau_1, \mathcal{U}_1^i \mathcal{V}_1^j, \mathcal{V}_1^n \mathbf{d}) &= -H\omega_3^1(\tau, \mathcal{U}_1^i, \mathcal{V}_1^{j+n} \mathbf{d}) \end{aligned}$$

Proof. All of these computations are performed algorithmically using the homological perturbation lemma for hypercubes of DA -bimodules, Lemma 4.5. For the first two sets of equations the computation is essentially straightforward. We first apply the map I_ε^1 , then we apply a length 1 map of the cube (either with no algebra input, as

for the maps labeled f_1^1 and g_1^1 , or with an algebra input of σ_1 or τ_1 , as for the maps p_2^1 and q_2^1). We leave these computations to the reader, as they are straightforward.

The map ${}^{-H}\omega_3^1$ is more interesting. There is exactly one configuration of morphism graph which gives a non-trivial evaluation. This occur for elements $\mathbf{x}_{0,0}$ in idempotent $\varepsilon = (0, 0)$. The structure graph is shown below:

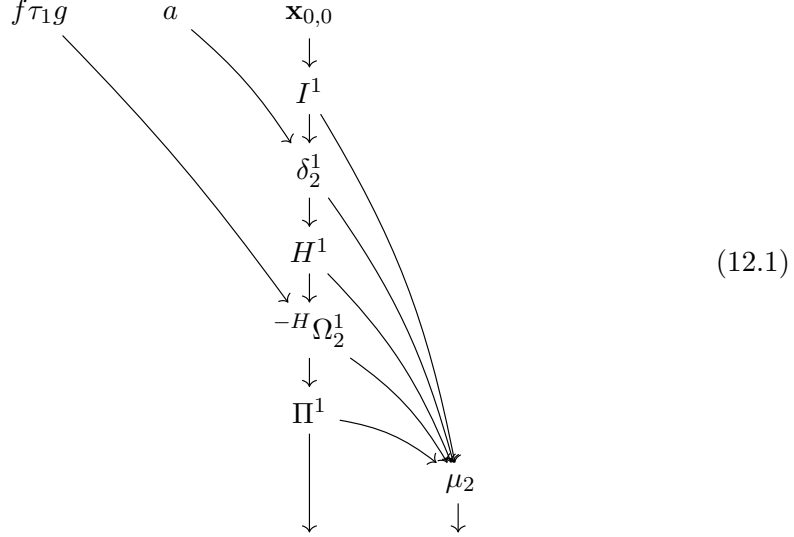

We focus on the case that $f = i_1$ and $g = i_0$. Consider first the case that $\mathbf{x} = \mathcal{U}_1^i \mathbf{a}$. If $a_1 = \mathcal{U}_1^n$, then $\delta_2^1(\mathcal{U}_1^n, \mathcal{U}_1^i \mathbf{a}) = \mathcal{U}_1^{i+n} \mathbf{a} \otimes 1$, however H^1 vanishes on this element, so we conclude that

$${}^{-H}\omega_3^1(\tau_1, \mathcal{U}_1^n, \mathcal{U}_1^i \mathbf{a}) = 0.$$

The same argument implies that ${}^{-H}\omega_3^1(\tau_1, \mathcal{V}_1^m, \mathcal{V}_1^j \mathbf{d}) = 0$.

We now consider the case that $\mathbf{x} = \mathcal{U}_1^i \mathbf{a}$ and $a_1 = \mathcal{V}_1^m$. In this case $H^1(\mathcal{U}_1^i \mathcal{V}_1^m \mathbf{a})$ is a sum involving both \mathbf{c} and \mathbf{b} . The next term in Equation (12.1) is an application of ${}^{-H}\Omega_2^1$, which vanishes on multiples of \mathbf{b} . In particular, we need only consider the terms of $H^1(\mathcal{U}_1^i \mathcal{V}_1^m \mathbf{a})$ involving \mathbf{c} . There are $\min(i+1, m)$ such terms. They are

$$\mathcal{U}_1^i \mathcal{V}_1^{m-1} \mathbf{c} \otimes 1 + \mathcal{U}_1^{i-1} \mathcal{V}_1^{m-2} \mathbf{c} \otimes \mathcal{U}_2 \mathcal{V}_2 + \mathcal{U}_1^{i-2} \mathcal{V}_1^{m-3} \mathbf{c} \otimes \mathcal{U}_2^2 \mathcal{V}_2^2 + \dots$$

(The sum is over all terms in the sequence above where \mathcal{U}_1 and \mathcal{V}_1 both have nonnegative exponent). We then apply ${}^{-H}\Omega_2^1$, Π^1 , and then multiply the outgoing algebra elements by repeatedly applying μ_2 . It is easy check that that the application of ${}^{-H}\Omega_2^1$, Π^1 , and μ_2 on each of the above summands coincide, so we will only consider their evaluation on $\mathcal{U}_1^i \mathcal{V}_1^{m-1} \mathbf{c} \otimes 1$. Applying ${}^{-H}\Omega_2^1$ gives

$$T(\mathcal{U}_1^i \mathcal{V}_1^{m-1}) \mathcal{V}_1^{\lambda_1-1} \mathbf{d} \otimes \tau_2 = \mathcal{U}_1^{m-1} \mathcal{V}_1^{2m-3-i} \mathbf{d} \otimes \tau_2.$$

Applying Π^1 to the above generator, and then multiplying the algebra elements gives

$$\mathcal{V}_1^{m-i-2} \mathbf{d} \otimes \mathcal{U}_1^{m-1} \mathcal{V}_1^{m-1} \tau_2.$$

There are $\min(i+1, m)$ such terms, giving the stated formula.

We now consider ${}^{-H}\omega_3^1(\tau_1, \mathcal{U}_1^n, \mathcal{V}_1^j \mathbf{d})$. The terms of $H^1(\mathcal{U}_1^n \mathcal{V}_1^j \mathbf{d})$ which involve \mathbf{c} are

$$\mathcal{U}_1^{n-1} \mathcal{V}_1^{j-1} \mathbf{c} \otimes \mathcal{U}_2 + \mathcal{U}_1^{n-2} \mathcal{V}_1^{j-2} \mathbf{c} \otimes \mathcal{U}_2^2 \mathcal{V}_2 + \dots$$

(As before, the sum contains all such elements in the sequence which have nonnegative powers of both \mathcal{U}_1 and \mathcal{V}_1). There are $\min(n, j)$ terms in this sum. As before, it is sufficient to evaluate ${}^{-H}\Omega_2^1$ and Π^1 only on the first term, and then multiply the result by $\min(n, j)$. Applying ${}^{-\tilde{H}}\Omega_2^1$, we obtain

$$T(\mathcal{U}_1^{n-1}\mathcal{V}_1^{j-1})\mathcal{V}_1^{\lambda_1-1}\mathbf{d} \otimes \tau_2\mathcal{U}_2 = \mathcal{U}_1^{j-1}\mathcal{V}_1^{2j-2+\lambda_1-n}\mathbf{d} \otimes \mathcal{V}_2^{-1}\tau_2.$$

Applying Π^1 and $\text{id} \otimes \mu_2$ gives

$$\mathcal{V}_1^{j-n+\lambda_1-1}\mathbf{d} \otimes \mathcal{U}_1^{j-1}\mathcal{V}_2^{j-2}\tau_2,$$

which proves the statement. \square

We now prove that the homotopy equivalences between $\kappa_1\mathcal{H}_{(\lambda_1,0)}^{\mathcal{K}_2}$ and $\kappa_1\mathcal{Z}_{(\lambda_1,0)}^{\mathcal{K}_2}$ are continuous with respect to the topologies described in Section 6. We topologize by giving \mathbf{a} , \mathbf{b} , \mathbf{c} and \mathbf{d} weight 0, and using the log-filtration from \mathcal{F}_{λ_1} , as in Section 6.3. We give $\mathcal{Z}_{(\lambda_1,0)}$ the filtration induced by the inclusion $\mathcal{Z}_{(\lambda_1,0)} \subseteq \mathcal{H}_{(\lambda_1,0)}$.

Lemma 12.4.

- (1) *The DA-bimodule structure maps on $\kappa_1\mathcal{H}_{(\lambda_1,0)}^{\mathcal{K}_2}$ and $\kappa_1\mathcal{Z}_{(\lambda_1,0)}^{\mathcal{K}_2}$ are weakly filtered with respect to the filtrations described above.*
- (2) *All of the maps involved in the homotopy equivalences described in Proposition 12.2 are weakly filtered.*

Proof. The weakly filtered property of the DA-bimodule structure maps on $\kappa_1\mathcal{H}_{(\lambda_1,0)}^{\mathcal{K}_2}$ is a consequence of the fact that the map δ^1 on $\mathcal{H}_{(\lambda_1,0)}^{\mathcal{K}_1 \otimes \mathcal{K}_2}$ is weakly filtered, since $\mathcal{H}_{(\lambda_1,0)}$ is a finitely generated vector space, and that $\kappa_1\mathcal{H}_{(\lambda_1,0)}^{\mathcal{K}_2}$ is obtained by a tensor product of $\mathcal{H}_{(\lambda_1,0)}^{\mathcal{K}_1 \otimes \mathcal{K}_2}$ with $\kappa_1 \otimes \kappa_1 M_2^{\mathcal{K}_1} \hat{\boxtimes} \kappa_1[\mathcal{F}_0]$.

The structure maps on $\kappa_1\mathcal{Z}_{(\lambda_1,0)}^{\mathcal{K}_2}$ and also the equivalence with $\kappa_1\mathcal{H}_{(\lambda_1,0)}^{\mathcal{K}_2}$ are given by the homological perturbation lemma. These maps are finite compositions of the maps Π^1 , H^1 , I^1 , as well as the map δ_2^1 of $\kappa_1\mathcal{H}_{(\lambda_1,0)}^{\mathcal{K}_2}$. Hence, it is sufficient to show that each of these maps is weakly filtered. The map I^1 is weakly filtered because it is given by $\mathbf{x} \mapsto \mathbf{x} \otimes 1$.

Consider the map Π^1 applied to elements in $\mathbf{I}_0 \cdot \mathcal{H}_{(\lambda_1,0)} \cdot \mathbf{I}_0$. This map is computed in Lemma 11.6. As an example, consider $\Pi^1(x)$ when $x = \mathcal{U}_1^i\mathcal{V}_1^j\mathbf{a}$ for $i \geq j \geq 0$. In this case,

$$\Pi^1(\mathcal{U}_1^i\mathcal{V}_1^j\mathbf{a}) = \mathcal{U}_1^{i-j}\mathbf{a} \otimes \mathcal{U}_2^j\mathcal{V}_2^j.$$

By definition,

$$w_{\mathcal{H}}(\mathcal{U}_1^i\mathcal{V}_1^j\mathbf{a}) = \min(i, j) + \log(1 + |i - j|)$$

while

$$w_{\mathcal{Z} \otimes \mathcal{K}}(\mathcal{U}_1^{i-j}\mathbf{a} \otimes \mathcal{U}_2^j\mathcal{V}_2^j) = \log(1 + |i - j|) + j.$$

Clearly $w_{\mathcal{H}}(x) \leq w_{\mathcal{Z} \otimes \mathcal{K}}(\Pi^1(x))$ in this case. A similar computation holds for the rest of $\mathbf{I}_0 \cdot \mathcal{H}_{(\lambda_1,0)} \cdot \mathbf{I}_0$, so Π^1 is weakly filtered in these idempotents. The same argument applies for $\mathbf{I}_0 \cdot \mathcal{H} \cdot \mathbf{I}_1$. We now consider Π^1 applied to $\mathbf{I}_1 \cdot \mathcal{H} \cdot \mathbf{I}_0$. In this case, we have

$$\Pi^1(\mathcal{U}_1^i\mathcal{V}_1^j\mathbf{a}) = \mathcal{V}_1^{j-i-1}\mathbf{d} \otimes \mathcal{U}_2^i\mathcal{V}_2^{i+1}.$$

We compute that

$$\begin{aligned} w_{\mathcal{H}}(\mathcal{V}_1^i \mathcal{V}_1^j \mathbf{a}) &= i + \log(1 + |i - j|) \\ w_{\mathcal{Z} \otimes \mathcal{K}}(\mathcal{V}_1^{j-i-1} \mathbf{d} \otimes \mathcal{V}_2^i \mathcal{V}_2^{i+1}) &= \log(1 + |j - i - 1|) + i - \log(2). \end{aligned}$$

In this case, we have $w_{\mathcal{H}}(x) \leq w_{\mathcal{Z} \otimes \mathcal{K}}(x) + 2$, so Π^1 is weakly filtered in these idempotents. The weakly filtered property on $\mathbf{I}_1 \cdot \mathcal{H} \cdot \mathbf{I}_1$ follows from an essentially identical argument.

The map H^1 is verified to be weakly filtered by a very similar argument. \square

13. THE HEEGAARD FLOER HOMOLOGY OF PLUMBED 3-MANIFOLDS

In this section, we describe how to compute the Heegaard Floer homology of 3-manifolds obtained by plumbing disk bundles according to a plumbing tree. In this section, we prove Theorems 1.11 and 1.12 of the introduction.

13.1. Elementary plumbing tangles.

Definition 13.1. A *tangle T with alternating boundary* is a tangle diagram in $\mathbb{R} \times [a, b]$ (viewed as a normally immersed, compact, and oriented 1-manifold with over and under crossings designated). Furthermore, we assume $\partial T \cap \mathbb{R} \times \{a\}$ and $\partial T \cap \mathbb{R} \times \{b\}$ both have even cardinality. Additionally, we assume that the points of $\partial T \cap \mathbb{R} \times \{a\}$ alternate in sign, and the left-most is negative. We assume the points of $\partial T \cap \mathbb{R} \times \{b\}$ also alternate in sign, but that the left-most is positive.

Suppose T is a tangle with alternating boundary and no closed components, let $2n$ be the number of points along the lower boundary, and let $2m$ be the number of points along the upper boundary. We associate the algebras $\mathcal{L}(n) = \otimes^n \mathcal{K}$ and $\mathcal{L}(m) = \otimes^m \mathcal{K}$ to the two ends of T .

Definition 13.2. Suppose T is a tangle with alternating boundary. We say that T is an *elementary plumbing tangle* if it additionally satisfies one of the following configurations:

- (1) (*Leaf tangle*) There are exactly $2n$ points along the top boundary, for some $n \geq 0$, and exactly $2n + 2$ points along the bottom boundary. Exactly one strand connects two points on the bottom boundary, and the rest connect the bottom to the top. This tangle has no crossings.
- (2) (*Hopf tangle*) There are $2n$ points along the top, and $2n$ points along the bottom, for $n \geq 2$. Except for two special strands, all strands connect the bottom to the top, and have no crossings. The two special strands are clasped as in Figure 13.1.
- (3) (*Merge tangle*) This tangle has no crossings. There are $2k$ consecutive special boundary points at the top, for some $k > 1$. The first and last of these special points are connected to the bottom. The remaining $2k - 2$ special points on the top are connected to an adjacent point on the top boundary. Additionally, there are exactly $2n$ additional strands to the left of the special points, for some $n \geq 0$, and these strands connect the bottom to the top. Similarly there are exactly $2m$ similar strands to the right, for some $m \geq 0$, and these strands connect the bottom to the top.
- (4) (*Root tangle*) This tangle has no crossings and has exactly 2 boundary points at the top, and none on the bottom.

A *minimal leaf tangle* is a leaf tangle where the bottom boundary has two points. Similarly a *minimal Hopf tangle* is one which has two points on the top boundary, and two points on the bottom boundary. A *minimal merge tangle* is one which has only two points on the bottom boundary. All root tangles are minimal.

Examples of elementary plumbing tangles are shown in Figure 13.1. It is easy to see that any link L_G obtained from a plumbing tree G may be arranged as a composition of elementary plumbing tangles.

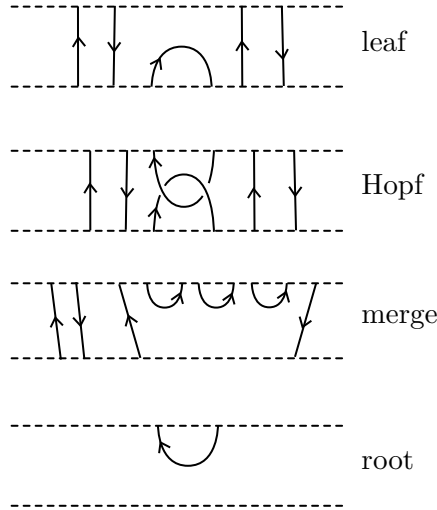

FIGURE 13.1. Elementary plumbing tangles.

13.2. Bimodules for elementary plumbing tangles. We now associate a bimodule to any elementary plumbing tangle. We assume additionally that each component of the tangle is equipped with an integer framing.

- (1) To a minimal leaf tangle, we associate the type- D module $\mathcal{D}^{\mathcal{K}}$ from Remark 6.9. To a general leaf tangle which has extra vertical strands, we use extension of scalars to construct a bimodule.
- (2) To a minimal Hopf tangle, we associate either the bimodule $\kappa_1 \mathcal{H}_{(\lambda_1, 0)}^{\mathcal{K}_2}$ or $\kappa_1 \mathcal{Z}_{(\lambda_1, 0)}^{\mathcal{K}_2}$, where λ_1 is the framing of the component associated to the type- A algebra. (The two bimodules are homotopy equivalent by Proposition 12.2). To a general Hopf tangle, we apply extension of scalars to construct a bimodule.
- (3) To a minimal merge tangle, with $2n$ points along the top boundary, we associate the merge bimodule $\mathcal{L}_{(n)}[M_n]^{\mathcal{K}}$ described in Section 6.4. To a general merge tangle, we use extension of scalars to construct a bimodule.
- (4) To the root tangle, we associate the framing module $\kappa[\mathcal{F}_\lambda]$ where λ is the framing of the lowest component of L_G .

Given an elementary plumbing tangle T , we write ${}_{\mathcal{A}_1} \mathcal{W}(T)^{\mathcal{A}_2}$ for the bimodule defined above. Here, \mathcal{A}_1 and \mathcal{A}_2 are tensor products of several copies of \mathcal{K} .

13.3. Computing the Heegaard Floer homology of plumbed 3-manifolds. We now prove Theorem 1.11 of the introduction.

Theorem 13.3. *Let G be a connected plumbing tree and let $L_G \subseteq S^3$ be the associated framed link, decomposed into a composition of elementary plumbing tangles T_1, \dots, T_n . Let \mathcal{A}_{j-1} and \mathcal{A}_j denote the algebras for T_j . Then*

$$\mathbf{CF}^-(Y(G))_{\mathbb{F}[[U]]} \simeq \mathcal{W}(T_1)^{\mathcal{A}_1} \hat{\boxtimes}_{\mathcal{A}_1} \mathcal{W}(T_2)^{\mathcal{A}_2} \hat{\boxtimes} \cdots \hat{\boxtimes}_{\mathcal{A}_{n-1}} \mathcal{W}(T_n)_{\mathbb{F}[[U]]}$$

The statement holds regardless of whether we build the Hopf bimodules from $\kappa_1 \mathcal{H}_{\Lambda}^{\mathcal{K}_2}$ or its minimal model $\kappa_1 \mathcal{Z}_{\Lambda}^{\mathcal{K}_2}$.

Proof. The proof may be performed by induction on the number of edges of the graph. As a first step, we use Lemma 6.7 to assume that the only merge bimodules which appear are the ones with two inputs, $\kappa_{\otimes \mathcal{K}} M_2^{\mathcal{K}}$. Additionally, we first consider only the case that the Hopf link complexes we use are the $\kappa \mathcal{H}_{(\lambda, 0)}^{\mathcal{K}}$ bimodules from Section 12. We assume as an inductive hypothesis that if G is a connected plumbing tree with at most n edges, decomposed into a composition of plumbing tangles T_1, \dots, T_k , where T_k is the unique root tangle, and Λ_0 is an integral framing on L_G which has framing 0 on the root vertex, then

$$\mathcal{X}_{\Lambda_0}(L_G)^{\mathcal{K}} \simeq \mathcal{W}(T_1)^{\mathcal{A}_1} \hat{\boxtimes} \cdots \hat{\boxtimes}_{\mathcal{A}_{k-1}} \mathcal{W}(T_k)^{\mathcal{K}}.$$

The base case when $n = 0$ is straightforward, since the right hand side of the above equation is just $\mathcal{D}^{\mathcal{K}}$, which is clearly the surgery complex of a 0-framed unknot.

If G' is a plumbing tree with $n + 1$ edges, then we arrange that G' is obtained from graphs with n or fewer edges by one of two procedures:

- (1) Adding a new valence 1 vertex below the root of a graph G which has n edges.
- (2) Merging two connected, rooted plumbing trees G_0 and G_1 at their roots, so that G_0 and G_1 have n or fewer edges.

In the first case, our definition of the iterative bimodule for G' is obtained by boxing in a Hopf link surgery bimodule. In this case, Theorem 10.1 implies that the tensor product of bimodules for G' recovers the surgery module for $L_{G'}$.

Next, we consider the second case, when we merge two connected plumbing trees at the root. In this case, we may apply Theorem 10.1 to obtain the result. Note that we may reorder levels corresponding to elementary tangles which topologically commute by Lemma 3.6.

Finally, we note that we may use the minimal models $\kappa_1 \mathcal{Z}_{(\lambda_1, 0)}^{\mathcal{K}_2}$ because we constructed homotopy equivalences between the uncompleted modules $\kappa_1 \mathcal{Z}_{(\lambda_1, 0)}^{\mathcal{K}_2} \simeq \kappa_1 \mathcal{H}_{(\lambda_1, 0)}^{\mathcal{K}_2}$ in Section 12.2, and we proved these maps were continuous with respect to the linear topologies in Lemma 12.4. \square

13.4. Comparison with lattice homology. We now make a comparison of the previous theorem with lattice homology. We recall that if G is a lattice tree with framing Λ , then there is a lattice complex $(\mathbb{C}\mathbb{F}_{\Lambda}^-(G), \partial)$. The complex was defined by Némethi [Ném08], and was a formalization of a construction due to Ozsváth and Szabó [OS03]. The version we work with may be found in [OSS14]. Due to their work, we state the following reformulation of lattice homology, which is more convenient for our purposes.

Definition 13.4. We take as the definition of $(\mathbb{C}\mathbb{F}_{\Lambda}^-(G), \partial)$ the following modification of the surgery formula for (L_G, Λ) :

- (CF-1) We replace each copy of $\mathfrak{A}^-(\mathcal{H}^{L-M}, \psi^M(\mathbf{s}))$ with its homology, which is a single copy of $\mathbb{F}[[U]]$ by [OS03, Lemma 2.6], (cf. [OSS14, Lemma 4.2]).
- (CF-2) The differential ∂ on the lattice complex consists of the maps induced on the level of homology by the length 1 maps of the Manolescu–Ozsváth surgery hypercube $\mathbb{X}_\Lambda(L_G)$.

Ozsváth, Stipsicz and Szabó [OSS14, Proposition 4.2] prove that the above modification of the Manolescu–Ozsváth link surgery complex $\mathbb{X}_\Lambda(L_G)$ is isomorphic to lattice homology. We take this as a proxy definition of lattice homology.

We now give a lattice homology analogs of Theorem 13.3. To do this, we construct two new bimodules, denoted $\kappa_1 \mathbb{H}_{(\lambda_1,0)}^{\mathcal{K}_2}$ and $\kappa_1 \mathbb{Z}_{(\lambda_1,0)}^{\mathcal{K}_2}$, which we think of as being the lattice analogs of $\kappa_1 \mathcal{H}_{(\lambda_1,0)}^{\mathcal{K}_2}$ and $\kappa_1 \mathcal{Z}_{(\lambda_1,0)}^{\mathcal{K}_2}$. The definitions are quite easy:

- (1) The generators of $\mathbb{H}_{(\lambda_1,0)}$ are identical to those of $\mathcal{H}_{(\lambda_1,0)}$. The map δ_1^1 is identical to the map from $\mathcal{H}_{(\lambda_1,0)}$ in Proposition 12.1. The map δ_2^1 is identical except for the map $^{-H}\Omega_2^1$, which is modified so that $\tau_1 \otimes \mathbf{c} \mapsto 0$.
- (2) The generators of $\mathbb{Z}_{(\lambda_1,0)}$ are identical to those of $\mathcal{Z}_{(\lambda_1,0)}$. The structure maps are identical, except that we omit the map $^{-H}\omega_3^1$ completely.

Remark 13.5. Another perspective on the bimodule $\kappa_1 \mathbb{H}_{(\lambda_1,0)}^{\mathcal{K}_2}$ is that it is obtained by using the wrong length 2 map on the Hopf link in Equation (11.5).

Lemma 13.6. $\kappa_1 \mathbb{H}_{(\lambda_1,0)}^{\mathcal{K}_2}$ and $\kappa_1 \mathbb{Z}_{(\lambda_1,0)}^{\mathcal{K}_2}$ are DA -bimodules and are homotopy equivalent.

Proof. We leave it to the reader to check that $\kappa_1 \mathbb{H}_{(\lambda_1,0)}^{\mathcal{K}_2}$ is a DA -bimodule. The fact that they are homotopy equivalent is proven similarly to Proposition 12.2. Indeed $\kappa_1 \mathbb{Z}_{(\lambda_1,0)}^{\mathcal{K}_2}$ is the result of applying the homological perturbation lemma to $\kappa_1 \mathbb{H}_{(\lambda_1,0)}^{\mathcal{K}_2}$. \square

Given an elementary plumbing tangle T , we may now construct lattice versions of the bimodules ${}_{\mathcal{A}}\mathcal{W}(T)^{\mathcal{A}'}$. We write ${}_{\mathcal{A}}\mathbb{W}(T)^{\mathcal{A}'}$ for these bimodules. For the merge, root and leaf tangles, we use the same bimodules as in Section 13.2. For the Hopf tangles, we use the bimodule $\kappa_1 \mathbb{H}_{(\lambda_1,0)}^{\mathcal{K}_2}$ (or its minimal models $\kappa_1 \mathbb{Z}_{(\lambda_1,0)}^{\mathcal{K}_2}$) in place of $\kappa_1 \mathcal{H}_{(\lambda_1,0)}^{\mathcal{K}_2}$ (or $\kappa_1 \mathcal{Z}_{(\lambda_1,0)}^{\mathcal{K}_2}$).

We now prove Theorem 1.12 of the introduction:

Theorem 13.7. *Let G be a connected plumbing tree, and let L_G be the associated framed link, decomposed into a composition of elementary plumbing tangles T_1, \dots, T_n . Let \mathcal{A}_{j-1} and \mathcal{A}_j denote the algebras for T_j . Then*

$$\mathbb{C}\mathbb{F}_\Lambda(G)_{\mathbb{F}[[U]]} \simeq \mathbb{W}(T_1)^{\mathcal{A}_1} \hat{\boxtimes} {}_{\mathcal{A}_1}\mathbb{W}(T_2)^{\mathcal{A}_2} \hat{\boxtimes} \dots \hat{\boxtimes} {}_{\mathcal{A}_{n-1}}\mathbb{W}(T_n)_{\mathbb{F}[[U]]}. \quad (13.1)$$

Proof. Since $\kappa_1 \mathbb{H}_{(\lambda_1,0)}^{\mathcal{K}_2}$ and $\kappa_1 \mathbb{Z}_{(\lambda_1,0)}^{\mathcal{K}_2}$ are homotopy equivalent by Lemma 13.6, it is sufficient to show the claim for $\kappa_1 \mathbb{Z}_{(\lambda_1,0)}^{\mathcal{K}_2}$. Write $\mathbb{W}_\Lambda(G)_{\mathbb{F}[[U]]}$ for the right-hand side of (13.1), using the \mathbb{H} -models. Write $\mathbb{W}'_\Lambda(G)_{\mathbb{F}[[U]]}$ for the right-hand side of (13.1), using the \mathbb{Z} -models. We may view $\kappa_1 \mathbb{Z}_{(\lambda,0)}^{\mathcal{K}_2}$ and $\kappa_1 \mathbb{H}_{(\lambda,0)}^{\mathcal{K}_2}$ as being filtered by \mathbb{E}_2 (i.e. being a hypercube of DA -bimodules). In our present situation, it is more helpful to ignore one axis of the filtration, and view $\kappa_1 \mathbb{Z}_{(\lambda,0)}^{\mathcal{K}_2}$ and $\kappa_1 \mathbb{H}_{(\lambda,0)}^{\mathcal{K}_2}$ as only being filtered

over \mathbb{E}_1 . The 0-term of the filtration is $\mathbf{I}_0 \cdot \kappa_1 \mathbb{Z}_{(\lambda,0)}^{\mathcal{K}_2}$, and the 1-term of the filtration is $\mathbf{I}_1 \cdot \kappa_1 \mathbb{Z}_{(\lambda,0)}^{\mathcal{K}_2}$. We similarly view the root module as being filtered by \mathbb{E}_1 . We view the merge and leaf bimodules as being concentrated in a single filtration level. When we tensor all of the bimodules together we get a complex which is filtered by \mathbb{E}_ℓ , i.e. a hypercube of chain complexes. Let us write \mathbb{W}_ε (resp. $\mathbb{W}_{\varepsilon'}$) for the complex of $\mathbb{W}_\Lambda(G)$ (resp. $\mathbb{W}'_\Lambda(G)$) at coordinate $\varepsilon \in \mathbb{E}_\ell$.

Note that the equivalence between $\mathbb{W}_\Lambda(G)$ and $\mathbb{W}'_\Lambda(G)$ is filtered, and so is its inverse, since they are constructed using the homological perturbation lemma of hypercubes of DA -bimodules.

In particular, if $\varepsilon \in \mathbb{E}_\ell$, we have that $\mathbb{W}_\varepsilon \simeq \mathbb{W}'_\varepsilon$, as chain complexes. Also, since $\mathcal{A}_{n-1} \mathbb{W}(T_n)_{\mathbb{F}[[U]]}$ is the framing module \mathcal{F}_λ , and the homotopy equivalences between $\mathbb{W}_\Lambda(G)$ and $\mathbb{W}'_\Lambda(G)$ are obtained by boxing the identity over $\mathbb{W}(T_n)$, we know that the homotopy equivalence $\mathbb{W}_\Lambda(G)_{\mathbb{F}[[U]]} \simeq \mathbb{W}'_\Lambda(G)_{\mathbb{F}[[U]]}$ will be $\mathbb{F}[[U]]$ -equivariant, (i.e. the maps relating them will be A_∞ module morphisms with $f_j = 0$ for $j > 1$). Also, $(\mathbb{W}'_\Lambda(G)_{\mathbb{F}[[U]]}, m_j)$ has $m_j = 0$ if $j > 2$.

Similarly, the $\mathbb{F}[[U]]$ action on both $\mathbb{W}_\Lambda(G)$ and $\mathbb{W}'_\Lambda(G)$ preserves the coordinate $\varepsilon \in \mathbb{E}_\ell$, so we may view each \mathbb{W}_ε and $\mathbb{W}_{\varepsilon'}$ as being a module over $\mathbb{F}[[U]]$.

However \mathbb{W}_ε is, by definition, the completion of link Floer complex $S_{M_\varepsilon}^{-1} \cdot \mathcal{CFL}^-(L_G)$, by Lemma 5.7, where M_ε denotes the set of link components L_i such that $\varepsilon(i) = 1$. In particular, it follows from [OS03, Lemma 4.2] that each \mathbb{W}'_ε is isomorphic to a direct product over $\mathfrak{s} \in \mathbb{H}(L)$ of copies of $\mathbb{F}[[U]]$, and in fact is identified with the completion of $H_*(S_{M_\varepsilon}^{-1} \cdot \mathcal{CFL}^-(L_G))$.

Finally, it is easy to see that the hypercube $\mathbb{W}'_\Lambda(G)$ has only length 1 maps, which are obtained by pushing the length one maps of $\mathbb{W}_\Lambda(G)$ to $\mathbb{W}'_\Lambda(G)$ via the homotopy equivalence $\mathbb{W}_\varepsilon \simeq \mathbb{W}'_\varepsilon$ at each $\varepsilon \in \mathbb{E}_\ell$. In particular, the hypercube maps of $\mathbb{W}'_\Lambda(G)$ are all of length 1, and the maps are induced by taking homology at each vertex of the surgery hypercube for L_G and using the induced maps on homology along each length 1 edge of the cube. Using our proxy definition of lattice homology in points (CF-1) and (CF-2), the equivalence follows. \square

14. BLOW-UPS AND MERIDIANAL DEHN TWISTS

In this section, we show that adding a ± 1 framed meridian to a link component has a simple effect algebraically. Adding a meridian may be encoded by taking the connected sum with a Hopf link, which in turn may be encoded by taking the tensor product with a bimodule constructed from the Hopf link complex.

We first define our algebraic candidates, which we call the bimodule for a *meridional Dehn twist*. We write $\kappa \mathcal{B}_{\pm 1}^{\mathcal{K}}$ for these bimodules. As an (\mathbf{I}, \mathbf{I}) -module, $\mathcal{B}_{\pm 1} \cong \mathbf{I}$ with the natural \mathbf{I} -action. The structure map δ_1^1 vanishes. If $a \in \mathbf{I}_j \cdot \mathcal{K} \cdot \mathbf{I}_j$ for either $j = 0$ or $j = 1$, then we set $\delta_2^1(a, i)$ to be $i \otimes a$ if $i \in \mathbf{I}$. Additionally, we set

$$\delta_2^1(\sigma, i_0) = i_1 \otimes \sigma \quad \text{and} \quad \delta_2^1(\tau, i_0) = i_1 \otimes \mathcal{V}^{\pm 1} \tau.$$

There is another natural bimodule, $\mathcal{B}_{\pm 1}^{\mathcal{K}}$ obtained by boxing in $\mathcal{D}^{\mathcal{K}}$. These are related via the tensoring with the bimodules $\kappa_{\mathcal{K} \otimes \mathcal{K}} M_2^{\mathcal{K}}$ and $\mathcal{D}^{\mathcal{K}}$ as follows:

$$\mathcal{B}_{\pm 1}^{\mathcal{K}} \boxtimes_{\kappa_{\mathcal{K} \otimes \mathcal{K}}} M_2^{\mathcal{K}} \cong \kappa \mathcal{B}_{\pm 1}^{\mathcal{K}}, \quad \text{and} \quad \mathcal{B}_{\pm 1}^{\mathcal{K}} \cong \mathcal{D}^{\mathcal{K}} \boxtimes_{\kappa} \mathcal{B}_{\pm 1}^{\mathcal{K}}. \quad (14.1)$$

We let $\kappa_2 \mathcal{H}_{(\pm 1, 0)}^{\mathcal{K}_2}$ denote the type- DA bimodule for a $(\pm 1, 0)$ -framed Hopf link, viewed as a DA -bimodule where both algebra components correspond to K_2 . By definition:

$$\kappa_2 \mathcal{H}_{(\pm 1, 0)}^{\mathcal{K}_2} = \mathcal{H}_{(\pm 1, 0)}^{\mathcal{K}_1 \otimes \mathcal{K}_2} \hat{\boxtimes} \kappa_2 \otimes \kappa_2 M_2^{\mathcal{K}_2} \hat{\boxtimes} \kappa_1 \mathcal{F}_0.$$

Proposition 14.1. *Let $\kappa_2 \mathcal{H}_{(\pm 1, 0)}^{\mathcal{K}_2}$ denote the type- DA bimodule for a $(\pm 1, 0)$ -framed negative Hopf link, as above. Then*

$$\kappa_2 \mathcal{H}_{(\pm 1, 0)}^{\mathcal{K}_2} \simeq \kappa_2 \mathcal{B}_{\mp 1}^{\mathcal{K}_2}.$$

The proof is a direct computation, which we do in several steps. Firstly, by (14.1) and the analogous relation for $\kappa_2 \mathcal{H}_{(\pm 1, 0)}^{\mathcal{K}_2}$ (which follows by the definition in Section 6.6), it is sufficient to show that

$$\mathcal{H}_{(\pm 1, 0)}^{\mathcal{K}_2} \simeq \mathcal{B}_{\mp 1}^{\mathcal{K}_2}.$$

As a second reduction, we use the type- D modules $\mathcal{Z}_{(\pm 1, 0)}^{\mathcal{K}_2}$ defined earlier. Similarly to Equation (6.6), we have

$$\mathcal{Z}_{(\pm 1, 0)}^{\mathcal{K}_2} \simeq \mathcal{D}^{\mathcal{K}_1} \hat{\boxtimes} \kappa_1 \mathcal{Z}_{(\pm 1, 0)}^{\mathcal{K}_2}.$$

Although $\kappa_1 \mathcal{Z}_{(\pm 1, 0)}^{\mathcal{K}_2}$ is the minimal model as a DA -bimodule, the type- D module $\mathcal{Z}_{(\pm 1, 0)}^{\mathcal{K}_2}$ may be reduced further. As a first step, note that the δ^1 map of this type- D module takes the following form

$$\begin{array}{ccc} \mathcal{Z}_{0,0}^{\mathcal{K}_2} & \xrightarrow{p_2^1(\sigma_1 + \tau_1, -)} & \mathcal{Z}_{1,0}^{\mathcal{K}_2} \\ | & & | \\ f_1^1 & & g_1^1 \\ \downarrow & & \downarrow \\ \mathcal{Z}_{0,1}^{\mathcal{K}_2} & \xrightarrow{q_2^1(\sigma_1 + \tau_1, -)} & \mathcal{Z}_{1,1}^{\mathcal{K}_2} \end{array}$$

In the above, we are writing f_1^1 for the map $L_2 f_1^1 + {}^{-L_2} f_1^1$, and similarly for all of the other maps. Note that ${}^{-H} \omega_3^1$ does not make any contribution.

Our argument will go by way of viewing the above diagram as a mapping cone from the top line to the bottom line, and then applying the homological perturbation lemma. Let us write

$$\mathcal{Q}_{\pm 1, \varepsilon}^{\mathcal{K}_2} = \text{Cone} \left(\mathcal{Z}_{0, \varepsilon}^{\mathcal{K}_2} \xrightarrow{p_2^1(\sigma_1 + \tau_1, -)} \mathcal{Z}_{1, \varepsilon}^{\mathcal{K}_2} \right)$$

We will write

$$J_{\pm 1}^1: \mathcal{Q}_{\pm 1, 0}^{\mathcal{K}_2} \rightarrow \mathcal{Q}_{\pm 1, 1}^{\mathcal{K}_2}$$

for the total morphism from the top line to the bottom line (i.e. $f_1^1 \oplus g_1^1$).

Write $\mathcal{W}_\varepsilon^{\mathcal{K}}$ for the module which is concentrated in idempotent \mathbf{I}_ε , and has a single generator, and vanishing δ^1 . Proposition 14.1 follows from the subsequent two lemmas:

Lemma 14.2. *There are maps*

$$I_\varepsilon^1: \mathcal{W}_\varepsilon^{\mathcal{K}} \rightarrow \mathcal{Q}_{-1, \varepsilon}^{\mathcal{K}}, \quad \Pi_\varepsilon^1: \mathcal{Q}_{-1, \varepsilon}^{\mathcal{K}} \rightarrow \mathcal{W}_\varepsilon^{\mathcal{K}}, \quad \text{and} \quad H_\varepsilon^1: \mathcal{Q}_{-1, \varepsilon}^{\mathcal{K}} \rightarrow \mathcal{Q}_{-1, \varepsilon}^{\mathcal{K}}$$

such that I_ε^1 and Π_ε^1 are cycles, and $I_\varepsilon^1 \circ \Pi_\varepsilon^1 = \text{id} + \partial_{\text{Mor}}(H_\varepsilon^1)$ and $\Pi_\varepsilon^1 \circ I_\varepsilon^1 = \text{id}$. Furthermore,

$$\Pi^1 \circ J^1 \circ I^1 = (i_0 \mapsto i_1 \otimes (\sigma + \mathcal{V}\tau)).$$

Here i_ε denotes the generator of $\mathcal{Q}_{-1, \varepsilon}^{\mathcal{K}}$. Also $\varepsilon_0 = 0$ and $\varepsilon_1 = 1$.

Proof. As a first step we record the mapping cone of $\mathcal{Q}_{-1,\varepsilon}^{\mathcal{K}}$. This is the type- D module

$$\begin{array}{cccccccccccc} \cdots & \mathcal{U}_1^3 \mathbf{a} & \mathcal{U}_1^2 \mathbf{a} & \mathcal{U}_1^1 \mathbf{a} & \mathbf{a} & \mathbf{d} & \mathcal{V}_1 \mathbf{d} & \mathcal{V}_1^2 \mathbf{d} & \mathcal{V}_1^3 \mathbf{d} & \cdots \\ & \swarrow & \downarrow & \swarrow & \downarrow & \swarrow & \downarrow & \swarrow & \downarrow & \swarrow \\ & \mathcal{U}_2^3 \mathcal{V}_2^4 & \mathcal{U}_2^2 \mathcal{V}_2^3 & \mathcal{U}_2^1 \mathcal{V}_2^2 & \mathcal{V}_2 & \mathcal{U}_2 & \mathcal{U}_2^2 \mathcal{V}_2 & \mathcal{U}_2^3 \mathcal{V}_2^2 & \mathcal{U}_2^4 \mathcal{V}_2^3 & \mathcal{U}_2^4 \mathcal{V}_2^3 & \downarrow \\ & \downarrow & \downarrow & \downarrow & \downarrow & \downarrow & \downarrow & \downarrow & \downarrow & \downarrow & \downarrow \\ \cdots & \mathcal{V}_1^{-4} \mathbf{d} & \mathcal{V}_1^{-3} \mathbf{d} & \mathcal{V}_1^{-2} \mathbf{d} & \mathcal{V}_1^{-1} \mathbf{d} & \mathbf{d} & \mathcal{V}_1 \mathbf{d} & \mathcal{V}_1^2 \mathbf{d} & \mathcal{V}_1^3 \mathbf{d} & \cdots \end{array}$$

We define the type- D module \mathcal{E}^Λ , where Λ is the exterior algebra on one generator. The module \mathcal{E} has a single generator, and differential $\delta^1(1) = 1 \otimes \theta$. Then $\mathcal{Q}_{-1,\varepsilon}^{\mathcal{K}}$ is obtained by boxing \mathcal{E}^Λ with the DA bimodule over (Λ, \mathcal{K}) shown below:

$$\begin{array}{cccccccccccc} \cdots & \mathcal{U}_1^3 \mathbf{a} & \mathcal{U}_1^2 \mathbf{a} & \mathcal{U}_1^1 \mathbf{a} & \mathbf{a} & \mathbf{d} & \mathcal{V}_1 \mathbf{d} & \mathcal{V}_1^2 \mathbf{d} & \mathcal{V}_1^3 \mathbf{d} & \cdots \\ & \swarrow & \downarrow & \swarrow & \downarrow & \swarrow & \downarrow & \swarrow & \downarrow & \swarrow \\ & \theta | \mathcal{U}_2^3 \mathcal{V}_2^4 & \theta | \mathcal{U}_2^2 \mathcal{V}_2^3 & \theta | \mathcal{U}_2^1 \mathcal{V}_2^2 & \theta | \mathcal{V}_2 & \theta | \mathcal{U}_2 & \theta | \mathcal{U}_2^2 \mathcal{V}_2 & \theta | \mathcal{U}_2^3 \mathcal{V}_2^2 & \theta | \mathcal{U}_2^4 \mathcal{V}_2^3 & \theta | \mathcal{U}_2^4 \mathcal{V}_2^3 & \downarrow \\ & \downarrow & \downarrow & \downarrow & \downarrow & \downarrow & \downarrow & \downarrow & \downarrow & \downarrow & \downarrow \\ \cdots & \mathcal{V}_1^{-4} \mathbf{d} & \mathcal{V}_1^{-3} \mathbf{d} & \mathcal{V}_1^{-2} \mathbf{d} & \mathcal{V}_1^{-1} \mathbf{d} & \mathbf{d} & \mathcal{V}_1 \mathbf{d} & \mathcal{V}_1^2 \mathbf{d} & \mathcal{V}_1^3 \mathbf{d} & \cdots \end{array}$$

In the above diagram, the solid lines denote the δ^1 action, while the dashed lines denote $\delta_2^1(\theta, -)$. A solid arrow from \mathbf{x} to \mathbf{y} with a 1 means that $\delta^1(\mathbf{x})$ has a summand of $\mathbf{y} \otimes 1$. If we ignore the type- A action, then the type- D module is equivalent to the one spanned by $\mathcal{V}_1^{-1} \mathbf{d}$ with vanishing δ^1 . There is a canonical inclusion map i^1 and projection map π^1 . A homotopy h^1 is defined by moving backwards along the solid arrows. Clearly i^1 and π^1 are type- D homomorphisms, and

$$i^1 \circ \pi^1 = \text{id} + \partial_{\text{Mor}}(h^1), \quad \pi^1 \circ i^1 = \text{id}.$$

Similarly, $\pi^1 \circ h^1 = 0$, $h^1 \circ h^1 = 0$, and $h^1 \circ i^1 = 0$. By the homological perturbation lemma, Lemma 4.2, i^1 , π^1 and h^1 extend to a homotopy equivalence of DA bimodules, which we denote by i_*^1 , π_*^1 and h_*^1 . We define the type- D module morphisms in the statement by

$$I^1 = \mathbb{I}_{\mathcal{E}} \boxtimes i_*^1, \quad \Pi^1 = \mathbb{I}_{\mathcal{E}} \boxtimes \pi_*^1, \quad \text{and} \quad H^1 = \mathbb{I}_{\mathcal{E}} \boxtimes h_*^1.$$

We leave it to the reader to check that the above expressions (which involve infinite sums on the completion) are convergent in the log-topology from Section 6, and in fact, the maps are weakly filtered in the sense of Definition 3.16.

All of the remaining claims in the statement are clear, except the ones involving the interaction with the map J^1 . We compute that I^1 maps i_0 to $\mathcal{V}_1^{-1} \mathbf{d} \otimes 1$. By the computation of Proposition 12.2, the map J^1 sends this to

$$\mathcal{V}_1^{-2} \mathbf{d} \otimes \tau_2 + \mathcal{V}_1^{-1} \mathbf{d} \otimes \sigma_2.$$

Then Π^1 maps this to

$$i_1 \otimes \mathcal{V}_2 \tau_2 + i_1 \otimes \sigma_2.$$

Note that the application of Π^1 to $\mathcal{V}_1^{-2} \mathbf{d} \otimes \tau_2$ is slightly subtle. Indeed the recipe from the homological perturbation lemma is to move backwards along the arrow from \mathbf{a} to $\mathcal{V}_1^{-2} \mathbf{d}$ and move forward along the arrow from \mathbf{a} to $\mathcal{V}_1^{-1} \mathbf{d}$, while picking up a factor of \mathcal{V}_2 . The proof is complete. \square

We now consider the case of $\mathcal{Q}_{+1,\varepsilon}^{\mathcal{K}}$:

Lemma 14.3. *There are maps*

$$I_\varepsilon^1: \mathcal{W}_\varepsilon^\mathcal{K} \rightarrow \mathcal{Q}_{+1,\varepsilon}^\mathcal{K}, \quad \Pi_\varepsilon^1: \mathcal{Q}_{+1,\varepsilon}^\mathcal{K} \rightarrow \mathcal{W}_\varepsilon^\mathcal{K}, \quad \text{and} \quad H_\varepsilon^1: \mathcal{Q}_{+1,\varepsilon}^\mathcal{K} \rightarrow \mathcal{Q}_{+1,\varepsilon}^\mathcal{K}$$

such that I_ε^1 and Π_ε^1 are type- D homomorphisms, and $I_\varepsilon^1 \circ \Pi_\varepsilon^1 = \text{id} + \partial_{\text{Mor}}(H_\varepsilon^1)$ and $\Pi_\varepsilon^1 \circ I_\varepsilon^1 = \text{id}$. Furthermore,

$$\Pi^1 \circ J^1 \circ I^1 = (i_0 \mapsto i_1 \otimes (\sigma + \mathcal{V}^{-1}\tau)).$$

Here i_ε denotes the generator of $\mathcal{Q}_{+1,\varepsilon}^\mathcal{K}$

Proof. The proof is very much the same as the proof with framing -1 . We write down the complex $\mathcal{Q}_{+1,\varepsilon}^\mathcal{K}$ below:

$$\begin{array}{cccccccccccc} \cdots & \mathcal{U}_1^3 \mathbf{a} & \mathcal{U}_1^2 \mathbf{a} & \mathcal{U}_1^1 \mathbf{a} & \mathbf{a} & \mathbf{d} & \mathcal{V}_1 \mathbf{d} & \mathcal{V}_1^2 \mathbf{d} & \mathcal{V}_1^3 \mathbf{d} & \cdots \\ & \downarrow \mathcal{U}_2^3 \mathcal{V}_2^4 & \downarrow \mathcal{U}_2^2 \mathcal{V}_2^3 & \downarrow \mathcal{U}_2^1 \mathcal{V}_2^2 & \downarrow \mathcal{V}_2 & \downarrow 1 & \downarrow 1 & \downarrow \mathcal{U}_2^2 \mathcal{V}_2 & \downarrow 1 & \downarrow \mathcal{U}_2^3 \mathcal{V}_2^2 & \downarrow 1 & \downarrow \mathcal{U}_2^4 \mathcal{V}_2^3 \\ \cdots & \mathcal{V}_1^{-4} \mathbf{d} & \mathcal{V}_1^{-3} \mathbf{d} & \mathcal{V}_1^{-2} \mathbf{d} & \mathcal{V}_1^{-1} \mathbf{d} & \mathbf{d} & \mathcal{V}_1 \mathbf{d} & \mathcal{V}_1^2 \mathbf{d} & \mathcal{V}_1^3 \mathbf{d} & \cdots \end{array}$$

Similar to the framing -1 case, we realize the above diagram as the box tensor product of \mathcal{E}^Λ with the following DA -bimodule over (Λ, \mathcal{K}) :

$$\begin{array}{cccccccccccc} \cdots & \mathcal{U}_1^3 \mathbf{a} & \mathcal{U}_1^2 \mathbf{a} & \mathcal{U}_1^1 \mathbf{a} & \mathbf{a} & \mathbf{d} & \mathcal{V}_1 \mathbf{d} & \mathcal{V}_1^2 \mathbf{d} & \mathcal{V}_1^3 \mathbf{d} & \cdots \\ & \downarrow \theta | \mathcal{U}_2^3 \mathcal{V}_2^4 & \downarrow \theta | \mathcal{U}_2^2 \mathcal{V}_2^3 & \downarrow \theta | \mathcal{U}_2^1 \mathcal{V}_2^2 & \downarrow \theta | \mathcal{V}_2 & \downarrow 1 & \downarrow \theta | \mathcal{U}_2 & \downarrow 1 & \downarrow \theta | \mathcal{U}_2^3 \mathcal{V}_2^2 & \downarrow 1 & \downarrow \theta | \mathcal{U}_2^4 \mathcal{V}_2^3 \\ \cdots & \mathcal{V}_1^{-4} \mathbf{d} & \mathcal{V}_1^{-3} \mathbf{d} & \mathcal{V}_1^{-2} \mathbf{d} & \mathcal{V}_1^{-1} \mathbf{d} & \mathbf{d} & \mathcal{V}_1 \mathbf{d} & \mathcal{V}_1^2 \mathbf{d} & \mathcal{V}_1^3 \mathbf{d} & \cdots \end{array}$$

We forget about the left Λ action and simplify the type- D structure. We build a homotopy equivalence with the module $\mathcal{W}_\varepsilon^\mathcal{K}$, by picking type- D module maps i^1 , π^1 and h^1 . The map i^1 sends i_ε to $(\mathbf{a} + \mathbf{d}) \otimes 1$. The map π^1 requires a choice. It is either $(\mathbf{a} \mapsto i_\varepsilon \otimes 1, \mathbf{d} \mapsto 0)$, or $(\mathbf{a} \mapsto 0, \mathbf{d} \mapsto i_\varepsilon \otimes 1)$. The choice of h^1 depends on our choice of π^1 . If π^1 sends \mathbf{a} to i_ε , then h^1 maps \mathbf{d} (on the bottom row) to $\mathbf{d} \otimes 1$ (on the top row). If π^1 maps \mathbf{d} to $i_\varepsilon \otimes 1$, then h^1 maps \mathbf{d} (bottom row) to $\mathbf{a} \otimes 1$ (top row). Arbitrarily, pick π^1 to map \mathbf{d} to $i_\varepsilon \otimes 1$. Away from the central region, the map h^1 just maps backwards along the arrows marked with a 1. One easily verifies that π^1 , i^1 and h^1 satisfy the assumptions of the homological perturbation lemma.

The homological perturbation lemma now gives us extensions π_*^1 , i_*^1 and h_*^1 . Boxing these with $\mathbb{L}_\mathcal{E}$ gives homotopy equivalences between $\mathcal{Q}_\varepsilon^\mathcal{K}$ and $\mathcal{W}_\varepsilon^\mathcal{K}$ described in the statement. Note that the maps I^1 , Π^1 and H^1 sometimes involve infinite sums, however it is straightforward to verify that the sums are convergent in the log-topology from Section 6.

It remains to perform the computation involving J^1 . We easily compute

$$I^1(i_0) = \cdots + \mathcal{U}_1 \mathbf{a} \otimes \mathcal{V}_2 + \mathbf{a} \otimes 1 + \mathbf{d} \otimes 1 + \mathcal{V}_1 \mathbf{d} \otimes \mathcal{U}_2 + \cdots$$

The map J^1 sends the above to

$$\begin{aligned} & \cdots + \mathcal{U}_1 \mathbf{a} \otimes \sigma_2 \mathcal{V}_2 + \mathbf{a} \otimes \sigma_2 + \mathbf{d} \otimes \sigma_2 + \mathcal{V}_1 \mathbf{d} \otimes \sigma_2 \mathcal{U}_2 + \cdots \\ & \cdots + \mathcal{U}_1^2 \mathbf{a} \otimes \tau_2 \mathcal{V}_2 + \mathcal{U}_1 \mathbf{a} \otimes \tau_2 + \mathbf{a} \otimes \mathcal{V}_2^{-1} \tau_2 + \mathbf{d} \otimes \tau_2 \mathcal{U}_2 + \cdots \end{aligned}$$

The map Π^1 evaluates the above $i_1 \otimes (\sigma_2 + \mathcal{V}_2^{-1} \tau_2)$ (regardless of which choice we made in the construction of π^1). Note, we are using here that $\tau_2 \mathcal{U}_2 = \mathcal{V}_2^{-1} \tau_2$. The proof is complete \square

APPENDIX A. CONNECTED SUMS AND SPLICING OPERATIONS

In this section, we describe some topology related to splicing knot complements. Everything in this section is well-known, and we only include it as a reference.

A.1. Splices and connected sums. Suppose that K_1 and K_2 are knots in S^3 . The complements of K_1 and K_2 are manifolds with torus boundary. The following is well known, though we give a proof for the convenience of the reader. Compare [Gor83, Section 7].

Lemma A.1. *Suppose that λ_1 and λ_2 are integral framings on knots K_1 and K_2 in S^3 , and let $[\lambda_1]$ and $[\lambda_2]$ denote the induced elements of $H_1(\partial S^3 \setminus N(K_1))$ and $H_1(\partial S^3 \setminus N(K_2))$. Then $S^3_{\lambda_1 + \lambda_2}(K_1 \# K_2)$ is diffeomorphic to the 3-manifold obtained by gluing $S^3 \setminus N(K_1)$ to $S^3 \setminus N(K_2)$ using the diffeomorphism which sends*

$$[\lambda_1] \mapsto -[\lambda_2] \quad \text{and} \quad [\mu_1] \mapsto [\mu_2].$$

Proof. Firstly, $S^3 \setminus N(K_1 \# K_2)$ is built by gluing $S^3 \setminus N(K_1)$ and $S^3 \setminus N(K_2)$ along an annulus whose oriented boundary components are μ_1 and $-\mu_2$. This is equivalent to gluing μ_1 to μ_2 . Next, we glue a solid torus to $S^3 \setminus N(K_1 \# K_2)$ along the framing $\lambda_1 + \lambda_2$. Gluing a solid torus is the same as gluing a 3-dimensional 2-handle and then a 3-handle, and it suffices to understand the 2-handle. If we attach a 3-dimensional 2-handle to $S^3 \setminus N(K_1 \# K_2)$ along $\lambda_1 * \lambda_2$, the effect is the same as gluing λ_1 to $-\lambda_2$. See Figure A.1. Here, $\lambda_1 * \lambda_2$ is the closed curve obtained by concatenating λ_1 and λ_2 across the annulus A twice. See Figure A.1. The proof is complete. \square

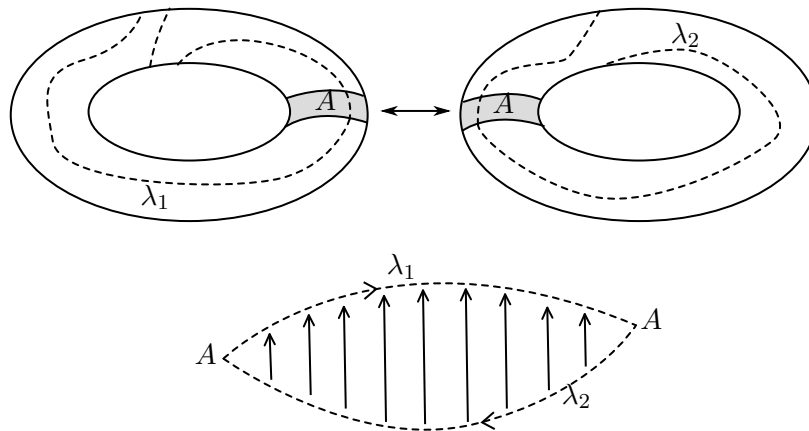

FIGURE A.1. Top: Gluing the complements of K_1 and K_2 along an annulus A to form the complement of $K_1 \# K_2$. Bottom: Attaching a 2-handle along $\lambda_1 * \lambda_2$ is the same as gluing λ_1 to $-\lambda_2$.

Remark A.2. The argument above also holds for arbitrary knots in 3-manifolds, as long as the framings are Morse. In this case, one needs to also interpret the framing $\lambda_1 + \lambda_2$ appropriately on $K_1 \# K_2$.

Remark A.3. The same argument works for links. Suppose that L_1 and L_2 are links in S^3 with framings Λ_1 and Λ_2 . Suppose that K_1 and K_2 are two chosen components of L_1 and L_2 , respectively. Then

$$S_{\Lambda_1 + \Lambda_2}^3(L_1 \# L_2) \cong M_{\Lambda_1}(L_1, K_1) \cup_{\phi} M_{\Lambda_2}(L_2, K_2),$$

where $M_{\Lambda_i}(L_i, K_i)$ is the manifold obtained by surgering along $L_i \setminus K_i$, and removing a neighborhood of K_i . The diffeomorphism ϕ which identifies $\partial N(K_1)$ with $\partial N(K_2)$ sends λ_1 to $-\lambda_2$, and μ_1 to μ_2 . The framing $\Lambda_1 + \Lambda_2$ is obtained by summing the framings for K_1 and K_2 , and leaving the remaining framings unchanged.

A.2. The Hopf link and changes of parametrization. We may naturally view the Hopf link as a link which changes the boundary parametrization. There are two ways to do this:

- (1) (Blow up) If K is the special component, and we connect sum with a Hopf link, and leave K the special component. If we give the other component of the Hopf link framing ± 1 , then we change the framing on $\partial N(K)$ by a Dehn twist along the meridian.
- (2) (Rotating layer) Noting that the complement of the Hopf link is $\mathbb{T}^2 \times I$, we may use the description from the previous remark to see the effect of connect summing the Hopf link to the special component, and using the new Hopf link component as the special component. The effect is to change the boundary parametrization by composing with one of the two maps:

$$\begin{aligned} \mu \mapsto \lambda \quad \text{and} \quad \lambda \mapsto -\mu, \quad \text{or} \\ \mu \mapsto -\lambda \quad \text{and} \quad \lambda \mapsto \mu. \end{aligned}$$

These two cases are distinguished by the sign of the Hopf link which is used in the connected sum.

REFERENCES

- [AM69] M. F. Atiyah and I. G. MacDonald, *Introduction to commutative algebra*, Addison-Wesley Publishing Co., Reading, Mass.-London-Don Mills, Ont., 1969.
- [Eft06] Eaman Eftekhary, *Heegaard Floer homology and Morse surgery*, 2006. e-print, arXiv:0603171 [math.GT].
- [Gor83] C. McA. Gordon, *Dehn surgery and satellite knots*, Trans. Amer. Math. Soc. **275** (1983), no. 2, 687–708.
- [Han16] Jonathan Hanselman, *Bordered Heegaard Floer homology and graph manifolds*, Algebr. Geom. Topol. **16** (2016), no. 6, 3103–3166.
- [HHSZ20] Kristen Hendricks, Jennifer Hom, Matthew Stoffregen, and Ian Zemke, *Surgery exact triangles and involutive Heegaard Floer homology*, 2020. e-print, arXiv:2011.00113 [math.GT].
- [HHSZ21a] ———, *A dual knot mapping cone formula for involutive Heegaard Floer homology*, 2021. In preparation.
- [HHSZ21b] ———, *Naturality and functoriality in involutive Heegaard Floer homology*, 2021. In preparation.
- [HK91] Johannes Huebschmann and Tornike Kadeishvili, *Small models for chain algebras*, Math. Z. **207** (1991), no. 2, 245–280.

- [HL19] Matthew Hedden and Adam Simon Levine, *A surgery formula for knot Floer homology*, 2019. e-print, arXiv:1901.02488 [math.GT].
- [HM17] Kristen Hendricks and Ciprian Manolescu, *Involutive Heegaard Floer homology*, *Duke Math. J.* **166** (2017), no. 7, 1211–1299.
- [Kad82] T. V. Kadeishvili, *The algebraic structure in the homology of an $A(\infty)$ -algebra*, *Soobshch. Akad. Nauk Gruzin. SSR* **108** (1982), no. 2, 249–252 (1983).
- [Kel02] Bernhard Keller, *Addendum to: “Introduction to A -infinity algebras and modules”*, *Homology Homotopy Appl.* **4** (2002), no. 1, 25–28.
- [KS01] Maxim Kontsevich and Yan Soibelman, *Homological mirror symmetry and torus fibrations*, *Symplectic geometry and mirror symmetry (Seoul, 2000)*, 2001, pp. 203–263.
- [Lip06] Robert Lipshitz, *A cylindrical reformulation of Heegaard Floer homology*, *Geom. Topol.* **10** (2006), 955–1097.
- [Liu14] Yajing Liu, *Heegaard Floer homology of surgeries on two-bridge links*, 2014. e-print, arXiv:1402.5727 [math.GT].
- [LOT14] Robert Lipshitz, Peter S. Ozsváth, and Dylan P. Thurston, *Bordered Floer homology and the spectral sequence of a branched double cover I*, *J. Topol.* **7** (2014), no. 4, 1155–1199.
- [LOT15] ———, *Bimodules in bordered Heegaard Floer homology*, *Geom. Topol.* **19** (2015), no. 2, 525–724.
- [LOT16] ———, *Bordered Floer homology and the spectral sequence of a branched double cover II: the spectral sequences agree*, *J. Topol.* **9** (2016), no. 2, 607–686.
- [LOT18] Robert Lipshitz, Peter S. Ozsváth, and Dylan P. Thurston, *Bordered Heegaard Floer homology*, *Mem. Amer. Math. Soc.* **254** (2018), no. 1216, viii+279.
- [LOT20] Robert Lipshitz, Peter Ozsváth, and Dylan Thurston, *Diagonals and A -infinity tensor products*, 2020. e-print, arXiv:2009.05222 [math.GT].
- [LOT21] ———, *A bordered HF^- algebra for the torus*, 2021. e-print arXiv:2108.12488 [math.GT].
- [MO10] Ciprian Manolescu and Peter S. Ozsváth, *Heegaard Floer homology and integer surgeries on links*, 2010. e-print, arXiv:1011.1317 [math.GT].
- [Ném05] András Némethi, *On the Ozsváth-Szabó invariant of negative definite plumbed 3-manifolds*, *Geom. Topol.* **9** (2005), 991–1042.
- [Ném08] ———, *Lattice cohomology of normal surface singularities*, *Publ. Res. Inst. Math. Sci.* **44** (2008), no. 2, 507–543.
- [OS03] Peter Ozsváth and Zoltán Szabó, *On the Floer homology of plumbed three-manifolds*, *Geom. Topol.* **7** (2003), 185–224.
- [OS04a] Peter Ozsváth and Zoltán Szabó, *Holomorphic disks and knot invariants*, *Adv. Math.* **186** (2004), no. 1, 58–116.
- [OS04b] ———, *Holomorphic disks and topological invariants for closed three-manifolds*, *Ann. of Math. (2)* **159** (2004), no. 3, 1027–1158.
- [OS04c] Peter S. Ozsváth and Zoltán Szabó, *Holomorphic disks and three-manifold invariants: properties and applications*, *Ann. of Math. (2)* **159** (2004), no. 3, 1159–1245.
- [OS08a] Peter Ozsváth and Zoltán Szabó, *Holomorphic disks, link invariants and the multi-variable Alexander polynomial*, *Algebr. Geom. Topol.* **8** (2008), no. 2, 615–692.
- [OS08b] Peter S. Ozsváth and Zoltán Szabó, *Knot Floer homology and integer surgeries*, *Algebr. Geom. Topol.* **8** (2008), no. 1, 101–153.
- [OS18] Peter Ozsváth and Zoltán Szabó, *Kauffman states, bordered algebras, and a bigraded knot invariant*, *Adv. Math.* **328** (2018), 1088–1198.
- [OS19] ———, *Algebras with matchings and knot Floer homology*, 2019. e-print arXiv:1912.01657 [math.GT].
- [OSS14] Peter Ozsváth, András I. Stipsicz, and Zoltán Szabó, *A spectral sequence on lattice homology*, *Quantum Topol.* **5** (2014), no. 4, 487–521.
- [Ras03] Jacob Rasmussen, *Floer homology and knot complements*, Ph.D. Thesis, 2003. arXiv:math/0306378.
- [Sei08] Paul Seidel, *Fukaya categories and Picard-Lefschetz theory*, *Zurich Lectures in Advanced Mathematics*, European Mathematical Society (EMS), Zürich, 2008.
- [Zem15] Ian Zemke, *Graph cobordisms and Heegaard Floer homology*, 2015. e-print, arXiv:1512.01184 [math.GT].

- [Zem17] ———, *Quasistabilization and basepoint moving maps in link Floer homology*, *Algebr. Geom. Topol.* **17** (2017), no. 6, 3461–3518.
- [Zem19a] ———, *Link cobordisms and absolute gradings on link Floer homology*, *Quantum Topol.* **10** (2019), no. 2, 207–323.
- [Zem19b] ———, *Link cobordisms and functoriality in link Floer homology*, *J. Topol.* **12** (2019), no. 1, 94–220.
- [Zem21] ———, *The equivalence of lattice and Heegaard-Floer homology*, 2021. e-print, arXiv 2111.14962 [math.GT].

DEPARTMENT OF MATHEMATICS, PRINCETON UNIVERSITY, PRINCETON, NJ, USA
Email address: `izemke@math.princeton.edu`