

Inner autoequivalences in general and those of monoidal categories in particular*

Pieter Hofstra¹, Martti Karvonen*

University of Ottawa, Department of Mathematics and Statistics, Ottawa, Canada

Abstract

We develop a general theory of (extended) inner autoequivalences of objects of any 2-category, generalizing the theory of isotropy groups to the 2-categorical setting. We show how dense subcategories let one compute isotropy in the presence of binary coproducts, unifying various known one-dimensional results and providing tractable computational tools in the two-dimensional setting. In particular, we show that the isotropy 2-group of a monoidal group coincides with its *Picard 2-group*, i.e., the 2-group on its weakly invertible objects.

Keywords: Picard 2-group, 2-category, 2-group, inner autoequivalence, dense pseudofunctor

2020 MSC: 18G45, 18M05, 18N10

Contents

1	Introduction	2
2	One-dimensional warm-up	7
3	Two-dimensional background	15
4	Two-dimensional isotropy	19

*This work was supported by NSERC.

*Corresponding author

Email address: `martti.karvonen@uottawa.ca` (Martti Karvonen)

¹Pieter Hofstra passed away shortly after giving his final comments on this manuscript.

5	Isotropy in the presence of binary coproducts	26
6	Isotropy and two-dimensional density	38
7	Monoidal categories	41
8	Monoidal fibrations	53
	Bibliography	57

1. Introduction

An inner automorphism of a group G is an automorphism $G \rightarrow G$ that is of the form $g \cdot (-) \cdot g^{-1}$, i.e., one that equals conjugation by an element of G . For an inner automorphism of G , there might be several elements of G that induce it—for instance, all central elements induce the identity on G . However, a fixed $g \in G$ induces more automorphisms than just one on G : in fact, for any homomorphism $\phi: G \rightarrow H$ it induces an inner automorphism of H by conjugation with $\phi(g)$. This family of automorphisms constitutes what [3] calls an *extended inner automorphism*: formally, this can be defined as a natural automorphism of the projection functor $G/\mathbf{Grp} \rightarrow \mathbf{Grp}$ (where G/\mathbf{Grp} is the co-slice category and where the projection takes a homomorphism $G \rightarrow H$ to H). The main result in loc. cit. is then that every such extended inner automorphism is induced by conjugation by a unique element of G , so that there is a natural isomorphism

$$\mathrm{Aut}(G/\mathbf{Grp} \rightarrow \mathbf{Grp}) \cong G.$$

This motivates the following definition.

Definition 1.1. Let \mathbf{C} be a category and X an object of \mathbf{C} . Then the (covariant) *isotropy group of \mathbf{C} at X* is the group $\mathcal{Z}(X)$ of natural automorphisms of the projection functor $P_X: X/\mathbf{C} \rightarrow \mathbf{C}$.

Explicitly, an automorphism

$$\alpha = (\alpha_f)_{f: X \rightarrow A} \in \mathcal{Z}(X) =_{\mathrm{def}} \mathrm{Aut}(P_X: X/\mathbf{C} \rightarrow \mathbf{C}) \quad (1.2)$$

consists of an automorphism $\alpha_f: A \rightarrow A$ for each $f: X \rightarrow A$ such that the square

$$\begin{array}{ccc} X & \xrightarrow{\alpha_{1_A}} & X \\ f \downarrow & & \downarrow f \\ A & \xrightarrow{\alpha_f} & A \end{array}$$

commutes. (In the terminology of universal algebra, α_f *extends* α_{1_A} .) Moreover, the naturality of α_f then amounts to requiring that for each $g: A \rightarrow B$, the square

$$\begin{array}{ccc} A & \xrightarrow{\alpha_f} & A \\ g \downarrow & & \downarrow g \\ B & \xrightarrow{\alpha_{gf}} & B \end{array}$$

commutes for any $g: A \rightarrow B$.

A morphism $x: X \rightarrow Y$ induces a homomorphism $\mathcal{Z}(X) \rightarrow \mathcal{Z}(Y)$ as follows: first, note that x induces a functor $x^*: Y/\mathbf{C} \rightarrow X/\mathbf{C}$ fitting into a strictly commuting triangle

$$\begin{array}{ccc} & Y/\mathbf{C} & \\ & \swarrow & \searrow \\ x^* & & P_Y \\ X/\mathbf{C} & \xrightarrow{\quad} & \mathbf{C} \\ & P_X & \end{array}$$

so that given $\alpha \in \mathcal{Z}(X)$ we can define $\mathcal{Z}(x)\alpha$ by whiskering along x^* , i.e., $\mathcal{Z}(x)\alpha := \alpha x^*$. In concrete terms, $\mathcal{Z}(x)\alpha$ is defined for $f: Y \rightarrow A$ by $(\mathcal{Z}(x)\alpha) = \alpha_{fx}$. Consequently, \mathcal{Z} is functorial in X ; as such, it can be thought of as rectifying the failure of the assignment $X \mapsto \text{Aut}(X)$ to be functorial. Indeed, there is, for each X , a comparison homomorphism

$$\theta_X: \mathcal{Z}(X) \rightarrow \text{Aut}(X).$$

In this viewpoint, one thinks of an arbitrary automorphism $h: X \rightarrow X$ as an “abstract inner automorphism” if it can be extended to such a family

α with $\alpha_{\text{id}} = h$; equivalently, these are the automorphisms in the image of the comparison map θ_X . Modulo size issues (discussed in the next section), we therefore have a functor

$$\mathcal{Z} : \mathbf{C} \rightarrow \mathbf{Grp}$$

called the (covariant) *isotropy group* of \mathbf{C} . In a topos-theoretic context this functor (or rather, the contravariant version) was studied in in [7], and in the context of (essentially) algebraic theories in [10, 11].

In particular, in [11] it is shown that for the 1-category **StrMonCat** of strict monoidal categories and strict monoidal functors, the isotropy group evaluated at a monoidal category $\mathbf{C} \in \mathbf{StrMonCat}$ is isomorphic to the *strict Picard group* of \mathbf{C} : this is the group of strictly invertible objects of \mathbf{C} ; here, an object X of \mathbf{C} is called strictly invertible when there exists another object Y such that $X \otimes Y = I = Y \otimes X$, where I is the tensor unit of \mathbf{C} .

In this work we introduce and investigate a two-dimensional version of the theory. We believe this is motivated in part by its intrinsic appeal; however, the example of the Picard group provides a concrete incentive to develop the generalization to 2-categories. Indeed, given a non-strict monoidal category, such as the category of modules over a ring, or the category of vector bundles over a space, we cannot apply directly the aforementioned result of [11]; instead, we would have to pass to a category of isomorphism classes of objects. Of course, this is similar in spirit to what is done traditionally, since the Picard group of a ring is usually defined to be the group of isomorphism classes of invertible modules. However, from the modern perspective of higher categories one associates instead with a (non-strict) monoidal category its Picard 2-group, that is, the monoidal groupoid of weakly invertible objects and isomorphisms between them. (For general discussion of 2-groups and related structures, see [2].)

Thus we aim to study, for a 2-category \mathbf{C} and an object X of \mathbf{C} , the 2-group of “extended inner autoequivalences” of \mathbf{C} by taking the pseudonatural autoequivalences of the projection $X/\mathbf{C} \rightarrow \mathbf{C}$. Somewhat more explicitly, an object α of this 2-group comprises, for each 1-cell $f : X \rightarrow A$, an equivalence $\alpha_f : A \rightarrow A$ rather than an isomorphism; moreover the naturality squares of α are now required to commute up to coherent invertible 2-cells (that are now part of the data of α) rather than up to equality.

It turns out that moving to the two-dimensional setting is not as straightforward as one might hope. The first and most elementary obstacle is the

following. For a 2-category \mathbf{C} , there are various notions of (co-)slice: there is the strict slice, the pseudo-slice, and the lax slice. Once we choose one of those, we may consider the projection 2-functor $P_X : X/\mathbf{C} \rightarrow \mathbf{C}$, and then we have another choice to make: are we to take 2-natural, pseudonatural, or lax natural autoequivalences of P_X ? As it turns out, several of the possible combinations fail. For example, if we were to consider the pseudo-slice X/\mathbf{C} , and define $\mathcal{Z}(X)$ to be the 2-group of pseudonatural autoequivalences of P_X , then while we can still define an action of \mathcal{Z} on 1-cells via whiskering (as in the one-dimensional case), \mathcal{Z} fails to be a 2-functor, because there in general is no well-defined action on 2-cells. This particular problem vanishes when one instead considers the lax slice and lax natural autoequivalences of the projection $X//\mathbf{C} \rightarrow \mathbf{C}$, but then there is another technical hurdle, namely that lax natural transformations do not form the 2-cells of a bicategory (or even tricategory), which prevents us from straightforwardly deducing the desired functoriality. We therefore have to exercise some caution when setting up the general theory. (See Section 4 for details.) As it turns out, however, there is an important situation in which the aforementioned problem goes away: when the ambient 2-category has binary coproducts, then it makes no difference whether one defines 2-isotropy in terms of the lax slice or in terms of the pseudo-slice.

A different obstacle, and perhaps a more important one, is that most prior computations of isotropy groups proceed by first identifying the isotropy group with a suitable group of definable automorphisms² and then computing the latter intricate syntactic arguments that are not that straightforward to generalize to two dimensions. Moreover, even with a suitable logical framework for reasoning syntactically about (certain classes of) 2-categories, carrying out syntactic arguments similar to those in [10, 11, 19, 20] seems unwieldy. To overcome this issue, we introduce a novel technique for computing isotropy groups, relying on the existence of binary coproducts and on a convenient choice of a dense subcategory. This technique is already interesting in the one-dimensional case, as it lets us compute various known isotropy groups with high efficiency, systematizes known results and sheds light on prior proofs. For instance, the aforementioned result of Bergman [3] revolves around considering the coproduct of a group with the free groups

²The idea that inner automorphisms are related to the definable ones is already present in [6], which inspired the title of this work.

on one and two generators. That these two groups appear in the argument is no accident, for they form a dense subcategory of the category of groups. Finally, this technique readily generalizes to the two-dimensional setting, and makes establishing some of the coherence conditions tractable by boiling the situation down to a small amount of data.

The plan of the paper is as follows. We begin in Section 2 by explaining the “coproducts-plus-density” technique with numerous examples in the one-dimensional case. After that, we will briefly review some required background concerning 2-categories in Section 3 before defining isotropy 2-groups and observing some basic properties in Section 4. In Section 5 we observe how the situation simplifies in the presence of binary coproducts, and in Section 6 we simplify it further in the presence of a dense subcategory. We then reap the payoff of these tools, by computing various isotropy 2-groups of interest:

- For the 2-category of groupoids, we show that the isotropy 2-groups vanish in Theorem 6.4. Thus groupoids have no nontrivial inner autoequivalences in our sense of the term. This should be compared with the results in [8].
- For the 2-category of indexed categories on \mathbf{C} , i.e., pseudofunctors $F: \mathbf{C}^{\text{op}} \rightarrow \mathbf{Cat}$, we show that the isotropy 2-group $\mathcal{Z}(F)$ is the 2-group of pseudonatural autoequivalences of $\text{id}_{\mathbf{C}}$. This generalizes the characterization of the covariant isotropy group of a presheaf topos in [11] (see also Example 2.5 for a statement and alternative proof of the result from loc. cit.)
- In Section 7 we compute the isotropy 2-groups of monoidal categories, showing that it behaves as one might guess based on the case of one-dimensional isotropy of strict monoidal categories and strict monoidal functors. Specifically, we show that if one takes the 2-category of monoidal categories, strong monoidal functors and monoidal natural transformations, then the isotropy 2-group $\mathcal{Z}(\mathbf{C})$ of a monoidal category \mathbf{C} is equivalent to the *Picard 2-group of \mathbf{C}* .
- We then conclude by joining the previous to results together: for a pseudofunctor $H: \mathbf{C} \rightarrow \mathbf{MonCat}$, the isotropy 2-group of H is equivalent to the product of $\text{Aut}(\text{id}_{\mathbf{C}})$ and the pseudolimit of the isotropy 2-groups of $H(A)$ for each $A \in \mathbf{C}$. Consequently, we obtain a characterization of the inner autoequivalences of monoidal fibrations in the sense of [18].

We point out that since we work with lax slices, pseudofunctors and pseudonatural transformations, our generalization of isotropy is genuinely bicategorical, rather than merely **Cat**-enriched, and hence does not follow directly from an (hitherto undone) enriched theory of isotropy. Despite this, we assume all of our 2-categories to be strict. This is mostly for notational convenience and due to us not being aware of examples of interest where the underlying 2-category fails to be strict—the basic definitions and results themselves generalize straightforwardly to bicategories.

2. One-dimensional warm-up

In this section we introduce a useful technique for computing isotropy. The 2-categorical version will be crucial in later sections, but we first explain and illustrate it in the one-dimensional setting, since the technique is already interesting and useful there. We first give an alternative characterization of \mathcal{Z} in the situation where \mathbf{C} has binary coproducts; after that, we show how the computation of \mathcal{Z} may be simplified by considering a dense subcategory of \mathbf{C} .

We will generally denote the isotropy functor by \mathcal{Z} , except when we discuss several different categories and their isotropy functors simultaneously, at which point we will disambiguate by writing $\mathcal{Z}_{\mathbf{C}}$, $\mathcal{Z}_{\mathbf{D}}$ and so on. Observe that \mathcal{Z} is not in general a functor from \mathbf{C} to the category of small groups, as the group of natural automorphisms of P_X might be a proper class. For instance, take the category of sets and bijections between them, and adjoin freely a new initial object 0 . In the resulting category \mathbf{C} , a natural automorphism of $0/\mathbf{C} \rightarrow \mathbf{C}$ can be uniquely specified by giving an automorphism of each cardinal, so that $\mathcal{Z}_{\mathbf{C}}(0)$ is a large group.

Definition 2.1. A category \mathbf{C} has *small isotropy* if for each object X of \mathbf{C} , the class of natural automorphisms of the projection $X/\mathbf{C} \rightarrow \mathbf{C}$ is in fact a set, so that \mathcal{Z} defines a functor $\mathbf{C} \rightarrow \mathbf{Grp}$.

Any small category has small isotropy. As we shall see, however (Theorem 2.4), it frequently happens that large categories still have small isotropy.

Let us assume now that \mathbf{C} has binary coproducts. Then for every object X of \mathbf{C} the projection $P_X: X/\mathbf{C} \rightarrow \mathbf{C}$ has a left adjoint $L_X: \mathbf{C} \rightarrow X/\mathbf{C}$ that sends $A \in \mathbf{C}$ to $i_X: X \rightarrow X + A$. Taking mates induces an isomorphism $\text{Aut}(P_X) \rightarrow \text{Aut}(L_X)^{\text{op}}$ for each X , as taking mates reverses the order of

composition. When reinterpreting an element of isotropy as a natural automorphism α of L_X , we find that the component of α at an object A is an isomorphism $\alpha_A : X + A \rightarrow X + A$ that fixes X , in the sense that the diagram (left)

$$\begin{array}{ccc}
 & X & \\
 i_X \swarrow & & \searrow i_X \\
 X + A & \xrightarrow{\alpha_A} & X + A
 \end{array}
 \qquad
 \begin{array}{ccc}
 X + A & \xrightarrow{\alpha_A} & X + A \\
 X + f \downarrow & & \downarrow X + f \\
 X + B & \xrightarrow{\alpha_B} & X + B
 \end{array}$$

commutes. Moreover, for any $f : A \rightarrow B$ we must have $\alpha_B(X + f) = (X + f)\alpha_A$, as in the diagram above (right).

Consequently, there is a unique way of extending the assignment $X \mapsto \text{Aut}(L_X)^{\text{op}}$ into a functor \mathcal{L} that is naturally isomorphic to \mathcal{Z} via these isomorphisms. A straightforward calculation shows that \mathcal{L} is then defined on objects by $\mathcal{L}(X) = \text{Aut}(L_X)^{\text{op}}$ and on morphisms by sending $f : X \rightarrow Y$ to the function $\mathcal{L}(f) : \text{Aut}(L_X)^{\text{op}} \rightarrow \text{Aut}(L_Y)^{\text{op}}$ which sends $t := (t_A)_{A \in \mathbf{C}} \in \text{Aut}(L_X)^{\text{op}}$ to $\mathcal{L}(f)(t)$ where $(\mathcal{L}(f)t)_A : Y + A \rightarrow Y + A$ is defined by commutativity of

$$\begin{array}{ccccc}
 A & \xrightarrow{i_A} & X + A & \xrightarrow{t_A} & X + A \\
 & \searrow & & & \downarrow f + \text{id}_A \\
 & & Y + A & \xrightarrow{(\mathcal{L}(f)t)_A} & Y + A \\
 Y & \xrightarrow{i_Y} & & & \\
 & \searrow & & \nearrow & \\
 & & & & Y
 \end{array}
 \qquad (2.2)$$

Consider now a functor $F : \mathbf{C} \rightarrow \mathbf{D}$. We write $\hat{F} : [\mathbf{D}^{\text{op}}, \mathbf{Set}] \rightarrow [\mathbf{C}^{\text{op}}, \mathbf{Set}]$ for the functor that restricts along F . Recall also that F is called *dense* if it satisfies any of the following equivalent conditions:

- (i) for all cocontinuous functors $G, H : \mathbf{D} \rightarrow \mathbf{E}$, restriction along F induces a bijection $\text{nat}(G, H) \rightarrow \text{nat}(GF, HF)$;
- (ii) the restricted Yoneda embedding $\mathbf{D} \xrightarrow{Y} [\mathbf{D}^{\text{op}}, \mathbf{Set}] \xrightarrow{\hat{F}} [\mathbf{C}^{\text{op}}, \mathbf{Set}]$ is fully faithful;
- (iii) for each $A, B \in \mathbf{D}$, the function

$$\mathbf{D}(A, B) \rightarrow [\mathbf{C}^{\text{op}}, \mathbf{Set}](\mathbf{D}(F-, A), \mathbf{D}(F-, B))$$

is a bijection.

(iv) for every object A of \mathbf{D} , A is the $\mathbf{D}(F(-), A)$ -weighted colimit of F .

(v) for every object A of \mathbf{D} , A is the colimit of $F/A \rightarrow \mathbf{C} \xrightarrow{F} \mathbf{D}$.

That (i)-(iv) are equivalent is proven more generally for enriched categories e.g. in [13, Chapter 5], and will serve as our template for bicategorical density in Section 6.

Remark 2.3. Note that when \mathbf{C} and \mathbf{D} are large categories, the functor categories $[\mathbf{C}^{\text{op}}, \mathbf{Set}]$ and $[\mathbf{D}^{\text{op}}, \mathbf{Set}]$ are “very large” and might not even exist in some foundations. However, both the theorem and its proof could be rephrased so as to avoid such very large structures, at the cost of making them slightly more cumbersome to state. For instance, (iii) is essentially a rephrasing of (ii), and one could talk about the class of natural transformations $\mathbf{D}(F-, A) \rightarrow \mathbf{D}(F-, B)$ without invoking a very large ambient category in which it lives as a hom-class. Similar remarks apply to our treatment of density in the 2-categorical case.

We now show that the isotropy of a category is determined by its restriction along any dense functor. This result is similar to one in [7], where it is shown that the contravariant isotropy functor of a presheaf topos sends colimits to limits and hence is determined by its values on the representables.

Theorem 2.4. *Let \mathbf{C} have binary coproducts and $K: \mathbf{D} \rightarrow \mathbf{C}$ be a dense functor. Then restriction along K defines an isomorphism $\mathcal{L} \cong \mathcal{L}_K$ where \mathcal{L}_K is defined on objects by $\mathcal{L}_K(X) = \text{Aut}(L_X \circ K)^{\text{op}}$ and on morphisms as in (2.2) with A of the form $K(B)$ for $B \in \mathbf{D}$. Thus $\mathcal{Z} \cong \mathcal{L}_K$.*

In particular, if there exists a dense $K: \mathbf{D} \rightarrow \mathbf{C}$ with small domain, then \mathbf{C} has small isotropy. As a result, any locally presentable category has small isotropy.

Proof. As L_X is a left adjoint and hence cocontinuous, density of K implies that $\text{Aut}(L_X)^{\text{op}} \cong \text{Aut}(L_X \circ K)^{\text{op}}$; moreover, this isomorphism is clearly natural in X . If we can choose a dense $K: \mathbf{D} \rightarrow \mathbf{C}$ with a small domain, then $\text{Aut}(L_X \circ K)$ and hence $\mathcal{Z}(X)$ is small for every X . The last claim follows from the fact that any locally presentable category is cocomplete and has a small dense subcategory [1, Theorem 1.20, Example 1.24(i)]. \square

Example 2.5. Let us use Theorem 2.4 to compute various isotropy groups of interest.

- For the category **Mon** of monoids, the full subcategory V on the single object $F\{x, y\}$, the free monoid on two generators, is a dense subcategory. We can use this to re-cast the argument given in [3] as follows.

For a monoid M , a natural automorphism of the composite

$$V \rightarrow \mathbf{Mon} \rightarrow M/\mathbf{Mon}$$

determines, and is determined by, an automorphism α of $i_M : M \rightarrow M + F\{x, y\}$. As such a automorphism must fix M , it is determined by a pair of elements $\alpha(x), \alpha(y) \in M + F\{x, y\}$. These elements can be written as words $w_1(x), w_2(y)$ in elements of $M \sqcup \{x, y\}$. Moreover, naturality at the map $x, y \mapsto x$ implies that $\alpha(x)$ is a word in $M \sqcup \{x\}$ and similarly $\alpha(y)$ is a word in $M \sqcup \{y\}$. Naturality at the swap map $x \mapsto y, y \mapsto x$ then implies that $w_1(x) = w_2(x)$, so α is determined by a single word $w(x)$ with $\alpha(x) = w(x)$ and $\alpha(y) = w(y)$.

Next, naturality at $x, y \mapsto xy$ implies that $w(x)w(y) = \alpha(x)\alpha(y) = \alpha(xy) = w(xy)$. In the word $w(x)w(y)$ each occurrence of x is to the left of each occurrence of y , which also must hold in $w(xy)$. Thus $w(x)$ contains x at most once, and as α is an automorphism, it contains it exactly once. Thus $\alpha(x) = w(x) = axb$ with $a, b \in M$. Now the equation $w(x)w(y) = w(xy)$ implies $ba = 1$ in M . On the other hand, naturality at $x, y \mapsto 1$ implies that $w(1) = 1$ so that $ab = 1$ and hence $b = a^{-1}$.

Conversely, it is easy to check that any invertible $a \in M$ determines such a natural automorphism, and hence that $\mathcal{Z}_{\mathbf{Mon}}$ is naturally isomorphic to the functor $M \mapsto \{\text{invertible elements of } M\}$, i.e., the right adjoint of the inclusion $\mathbf{Grp} \rightarrow \mathbf{Mon}$.

- Next, we consider a small category \mathbf{C} , and compute the isotropy of $[\mathbf{C}^{\text{op}}, \mathbf{Set}]$. Note that $y : \mathbf{C} \rightarrow [\mathbf{C}^{\text{op}}, \mathbf{Set}]$ is dense. Given $F \in [\mathbf{C}^{\text{op}}, \mathbf{Set}]$, an element of $\alpha \in \mathcal{Z}(F)$ is then determined by a natural family of isomorphisms $\alpha_A : F + yA \rightarrow F + yA$ fixing F . Since yA is indecomposable, it follows that α_A must be of the form $1_F + \beta_A$, where $\beta_A : yA \rightarrow yA$ is an isomorphism. By Yoneda's lemma, we may identify β_A with an automorphism of A ; and since these automorphisms are natural in A ,

they together form a natural automorphism of the identity functor on \mathbf{C} . (The group $\text{Aut}(1_{\mathbf{C}})$ is sometimes called the *center* of \mathbf{C} .) In conclusion, \mathcal{Z} on $[\mathbf{C}^{\text{op}}, \mathbf{Set}]$ is the constant functor with value $\text{Aut}(1_{\mathbf{C}})$.

The above argument goes through for the category of sheaves on site (\mathbf{C}, J) , provided that the topology J is subcanonical. We therefore also recover [20, Proposition 3.12.], which states that the isotropy functor $\mathcal{Z} : \mathbf{Sh}(\mathbf{C}, J) \rightarrow \mathbf{Grp}$ is constant with value $\text{Aut}(1_{\mathbf{C}})$, and which was proved in loc. cit. by syntactic means.

We next consider a weakening of the notion of dense functor. The main purpose of introducing this concept is that while restriction along such a weakly dense functor is not quite sufficient to recover the isotropy group, it still helps in showing in particular instances that the isotropy trivializes.

Proposition 2.6. *Let \mathbf{C} and \mathbf{D} be categories with \mathbf{D} cocomplete. The following conditions are equivalent for a functor $F : \mathbf{C} \rightarrow \mathbf{D}$.*

(i) *for all cocontinuous $G, H : \mathbf{D} \rightarrow \mathbf{E}$, restriction along F induces an injection $\text{nat}(G, H) \rightarrow \text{nat}(GF, HF)$.*

(ii) *the restricted Yoneda embedding $\mathbf{D} \xrightarrow{Y} [\mathbf{D}^{\text{op}}, \mathbf{Set}] \xrightarrow{\hat{F}} [\mathbf{C}^{\text{op}}, \mathbf{Set}]$ is faithful.*

(iii) *for each $A, B \in \mathbf{D}$, the function*

$$\mathbf{D}(A, B) \rightarrow \mathbf{Cat}(\mathbf{C}^{\text{op}}, \mathbf{Set})(\mathbf{D}(F-, A), \mathbf{D}(F-, B))$$

is an injection

(iv) *for every object A of \mathbf{D} , the canonical map $f : C_A \rightarrow A$ from the $\mathbf{D}(F(-), A)$ -weighted colimit of F to A is an epimorphism.*

Proof. Any representable $\mathbf{D}^{\text{op}} \rightarrow \mathbf{Set}$ is continuous, so that the corresponding opposite functor $\mathbf{D} \rightarrow \mathbf{Set}^{\text{op}}$ is cocontinuous. As the Yoneda embedding is fully faithful, (i) implies that the composite $\mathbf{D} \xrightarrow{Y} [\mathbf{D}^{\text{op}}, \mathbf{Set}] \xrightarrow{\hat{F}} [\mathbf{C}^{\text{op}}, \mathbf{Set}]$ is faithful.

(iii) is just a rephrasing of (ii), so that (ii) and (iii) are equivalent.

(iii) \Leftrightarrow (iv): Unwinding definitions we see that C_A being the $\mathbf{D}(F(-), A)$ -weighted colimit of F amounts to saying that there are isomorphisms

$$\mathbf{D}(C_A, B) \cong [\mathbf{C}^{\text{op}}, \mathbf{Set}](\mathbf{D}(F-, A), \mathbf{D}(F-, B))$$

natural in B . As a result, the canonical map

$$\mathbf{D}(A, B) \rightarrow [\mathbf{C}^{\text{op}}, \mathbf{Set}](\mathbf{D}(F-, A), \mathbf{D}(F-, B))$$

is injective if and only if $\mathbf{D}(A, B) \xrightarrow{-\circ f} \mathbf{D}(C_A, B)$ is, and injectivity of $\mathbf{D}(A, B) \xrightarrow{-\circ f} \mathbf{D}(C_A, B)$ for each B is equivalent to f being an epimorphism.

(iv) \Rightarrow (i): Recall that f is an epimorphism if and only if the diagram

$$\begin{array}{ccc} A & \xrightarrow{f} & B \\ f \downarrow & & \downarrow \text{id} \\ B & \xrightarrow{\text{id}} & B \end{array}$$

is a pushout diagram. Consequently, if $G, H: \mathbf{D} \rightarrow \mathbf{E}$ are cocontinuous, they both preserve the colimit C_A of (iv) and the epicness of the canonical map $f_A: C_A \rightarrow A$. Thus we have isomorphisms

$$\mathbf{E}(G(C_A), B) \cong [\mathbf{C}^{\text{op}}, \mathbf{Set}](\mathbf{D}(F-, A), \mathbf{E}(GF-, B))$$

natural in B and an epimorphism $Gf_A: G(C_A) \rightarrow A$ for any $A \in \mathbf{D}$. Consider natural transformations $\sigma, \tau: G \rightarrow H$ with $\sigma F = \tau F$. As the map $Gf_A: G(C_A) \rightarrow A$ is an epimorphism, to prove that $\sigma = \tau$ it suffices to show that $\sigma_{C_A} = \tau_{C_A}$ for each A . Replacing B with $H(C_A)$ in the isomorphism above, we get isomorphisms

$$\mathbf{E}(G(C_A), H(C_A)) \cong [\mathbf{C}^{\text{op}}, \mathbf{Set}](\mathbf{D}(F-, A), \mathbf{E}(GF-, H(C_A)))$$

for each A . Under this isomorphism, σ_{C_A} corresponds to the natural transformation $\mathbf{D}(F-, A) \rightarrow \mathbf{E}(GF-, HA)$ that sends $g: FX \rightarrow A$ to $GFX \xrightarrow{\sigma_X} HFX \xrightarrow{Hg} HA$. As a result, $\sigma F = \tau F$ implies $\sigma_{C_A} = \tau_{C_A}$ whence $\sigma = \tau$, as desired. \square

Definition 2.7. A functor is called *weakly dense* if it satisfies the equivalent conditions of Proposition 2.6.

The following theorem explains the point of considering such functors.

Theorem 2.8. *Let \mathbf{C} have binary coproducts and $K: \mathbf{D} \rightarrow \mathbf{C}$ be a weakly dense functor. Then there is a natural inclusion $\mathcal{Z} \hookrightarrow \mathcal{L}_K$ where \mathcal{L}_K is defined as in Theorem 2.4.*

Proof. Given the isomorphism $\mathcal{Z} \cong \mathcal{L}$, it suffices to show that restriction along K defines an injection $\mathcal{L} \rightarrow \mathcal{L}_K$, but this follows from the cocontinuity of each L_X and from condition (i) of Proposition 2.6. \square

In particular, if K is weakly dense and \mathcal{L}_K is trivial, then so is \mathcal{Z} .

Example 2.9. Let us see Theorem 2.8 in action.

- Let **Grpd** be the 1-category of (small) groupoids, and let I be the “walking isomorphism category”, i.e., the indiscrete category on two objects. Then the full subcategory on I is weakly dense in **Grpd** as two functors between groupoids are equal if and only if they agree on morphisms. For any groupoid G the only automorphism of $G + I$ fixing G has to send I to itself. Moreover, naturality with respect the constant maps $I \rightarrow I$ forces any such isomorphism to be the identity I , so the only natural automorphism of $\{I\} \rightarrow \mathbf{Grpd} \xrightarrow{L_G} G/\mathbf{Grpd}$ is the identity. Thus $\mathcal{Z}: \mathbf{Grpd} \rightarrow \mathbf{Grp}$ is constant at the trivial group.
- The full subcategory on \mathbb{Z} is weakly dense in **Ab**. An automorphism of $G + \mathbb{Z} = G \times \mathbb{Z}$ fixing G is determined by the image $(g, n) \in G \times \mathbb{Z}$ of $1 \in \mathbb{Z}$. As the inverse of this automorphism must also lie in G/\mathbf{Ab} , we must have $g = 0 \in G$ and $n = \pm 1$. Consequently, if K denotes the inclusion $\{\mathbb{Z}\} \rightarrow \mathbf{Ab}$, then \mathcal{L}_K is the constant functor on \mathbb{Z}_2 . Furthermore, one can easily check that both $-\text{id}$ and id define natural automorphisms of $G/\mathbf{Ab} \rightarrow \mathbf{Ab}$, so that $\mathcal{Z}_{\mathbf{Ab}}$ is also constant at \mathbb{Z}_2 .
- We sketch how to use weak density to obtain the aforementioned result of [11] stating that for the 1-category **StrMonCat** of strict monoidal categories and strict monoidal functors, the isotropy group of $\mathbf{C} \in \mathbf{StrMonCat}$ is isomorphic to the strict Picard group of \mathbf{C} . Let \mathbf{F} be the full subcategory of **StrMonCat** on the free monoidal category on two objects and on the free monoidal category on the category $\bullet \rightarrow \bullet$. The inclusion $K: \mathbf{F} \rightarrow \mathbf{StrMonCat}$ is weakly dense, as two strict monoidal functors are equal iff they agree on morphisms. The reason to include the free monoidal subcategory on two generators in \mathbf{F} as well

is that the resulting composite $\mathbf{F} \rightarrow \mathbf{StrMonCat} \xrightarrow{\text{ob}} \mathbf{Mon}$ is dense. Consequently, given a monoidal category \mathbf{C} , the diagram

$$\begin{array}{ccccc}
 \mathbf{F} & \xrightarrow{K} & \mathbf{StrMonCat} & \xrightarrow{L_{\mathbf{C}}} & \mathbf{C}/\mathbf{StrMonCat} \\
 & \searrow^{ob \circ K} & & & \downarrow \text{ob} \\
 & & \mathbf{Mon} & \xrightarrow{L_{\text{ob}(\mathbf{C})}} & \text{ob}(\mathbf{C})/\mathbf{Mon}
 \end{array}$$

commutes within isomorphism, inducing a homomorphism $\mathcal{L}_K(\mathbf{C}) \rightarrow \mathcal{Z}_{\mathbf{Mon}}(\text{ob}(\mathbf{C}))$. Furthermore, one can use the structure of the coproduct of \mathbf{C} with one of the free monoidal categories in question to show that this homomorphism $\mathcal{L}_K(\mathbf{C}) \rightarrow \mathcal{Z}_{\mathbf{Mon}}(\text{ob}(\mathbf{C}))$ is injective—ultimately, this follows from the fact that the relevant free monoidal categories are thin, so that whiskering an automorphism of $\mathbf{F} \xrightarrow{K} \mathbf{StrMonCat} \xrightarrow{L_{\mathbf{C}}} \mathbf{C}/\mathbf{StrMonCat}$ along $\mathbf{C}/\mathbf{StrMonCat} \rightarrow \text{ob}(\mathbf{C})/\mathbf{Mon}$ is injective. Precomposing this with the injection $\mathcal{Z}_{\mathbf{StrMonCat}}(\mathbf{C}) \hookrightarrow \mathcal{L}_K(\mathbf{C})$, we obtain an injection $\mathcal{Z}_{\mathbf{StrMonCat}}(\mathbf{C}) \hookrightarrow \mathcal{Z}_{\mathbf{Mon}}(\text{ob}(\mathbf{C}))$ from the isotropy group of \mathbf{C} to the strict Picard group of \mathbf{C} . Since any strictly invertible object of \mathbf{C} induces an element of $\mathcal{Z}_{\mathbf{StrMonCat}}(\mathbf{C})$ via conjugation, this map is in fact an isomorphism.

To conclude this section on one-dimensional isotropy, we remark that much of what we have discussed can be generalized without much effort to the *isotropy monoid* $\mathcal{M} : \mathbf{C} \rightarrow \mathbf{Mon}$, which is defined at an object X of \mathbf{C} by

$$\mathcal{M}(X) = \text{Nat}(P_X, P_X),$$

the monoid of natural endomorphisms of the projection $P_X : X/\mathbf{C} \rightarrow \mathbf{C}$. This generalization is already considered in Bergman [3], where it is shown that in several examples the monoid does not contain much interesting information not already present in the isotropy group. However, it turns out that when generalizing to the two-dimensional setting it will often be convenient to establish results for \mathcal{M} and deduce the corresponding statements for \mathcal{Z} , using the fact that \mathcal{Z} may now be re-expressed as the composite

$$\mathbf{C} \rightarrow \mathbf{Mon} \rightarrow \mathbf{Grp}$$

where the functor $\mathbf{Mon} \rightarrow \mathbf{Grp}$ sends a monoid to its group of invertible elements.

3. Two-dimensional background

We refer the reader to [12] for the general definitions of a pseudofunctor, lax and pseudonatural transformations between pseudofunctors, and of a modification between lax transformations. However, we will spell out explicitly in the next section what lax and pseudonatural transformations and modifications between them amount to in the special case under consideration. For us, all 2-categories are assumed to be strict, but this is mostly for convenience—the basic definitions and results themselves generalize straightforwardly to bicategories. For 2-categories \mathbf{C}, \mathbf{D} , we will use $[\mathbf{C}, \mathbf{D}]$ to denote the 2-category of pseudofunctors $\mathbf{C} \rightarrow \mathbf{D}$, pseudonatural transformations and modifications. We will use the fact that a pseudonatural transformation is a pseudonatural equivalence (i.e., an equivalence in $[\mathbf{C}, \mathbf{D}]$) if and only if each 1-cell component of the pseudonatural transformation is an equivalence.

Recall that given a functor $F: \mathbf{C} \rightarrow \mathbf{D}$ between 1-categories and an *arbitrary* family of isomorphisms $\{\sigma_A: F(A) \rightarrow G(A)\}_{A \in \mathbf{C}}$, there is a unique way of making $A \mapsto G(A)$ into a functor G so that σ gives an isomorphism $\sigma: F \rightarrow G$. We will repeatedly use the following two-dimensional analogues of this fact:

Lemma 3.1. • *Given a pseudofunctor $F: \mathbf{C} \rightarrow \mathbf{D}$, and arbitrary equivalence data*

$$\sigma_A: FA \rightleftarrows GA: \tau_A, \quad \Gamma_A: \text{id} \xrightarrow{\cong} \sigma_A \tau_A, \quad \Sigma: \tau_A \sigma_A \xrightarrow{\cong} \text{id}$$

for each $A \in \mathbf{C}$, there is a unique way of promoting $A \mapsto G(A)$ into a pseudofunctor G so that

$$\sigma: F \rightleftarrows G: \tau, \quad \Gamma: \text{id} \xrightarrow{\cong} \sigma \tau, \quad \Sigma: \tau \sigma \xrightarrow{\cong} \text{id}$$

defines a pseudonatural equivalence.

- *Given a pseudonatural transformation $\sigma: F \rightarrow G$, and arbitrary invertible 2-cells $\Gamma_A: \sigma_A \rightarrow \tau_A$ for each $A \in \mathbf{C}$, there is a unique pseudonatural transformation τ whose 1-cell components are given by $\{\tau_A\}_{A \in \mathbf{C}}$ for which the family $\{\Gamma_A\}_{A \in \mathbf{C}}$ defines a modification $\Gamma: \sigma \rightarrow \tau$.*

Definition 3.2. Let \mathbf{C} be a 2-category and X an object of \mathbf{C} . The lax slice $X//\mathbf{C}$ of \mathbf{C} under X is defined as follows. The objects of $X//\mathbf{C}$ are

pairs (A, f) , where A is an object and $f: X \rightarrow A$ is a 1-cell of \mathbf{C} . Given two objects $(A, f), (B, g)$ of $X//\mathbf{C}$, a 1-cell $f \rightarrow g$ is depicted in the triangle

$$\begin{array}{ccc} & X & \\ f \swarrow & \xRightarrow{\sigma} & \searrow g \\ A & \xrightarrow{j} & B \end{array}$$

and is given by a pair (j, σ) , where $j: A \rightarrow B$ is a 1-cell and $\sigma: hf \rightarrow g$ is a 2-cell of \mathbf{C} . A 2-cell $(j, \sigma) \rightarrow (k, \tau)$ is given by a 2-cell $\theta: j \rightarrow k$ in \mathbf{C} satisfying the equality of pasting diagrams

$$\begin{array}{ccc} & X & \\ f \swarrow & \xRightarrow[\tau]{k} & \searrow g \\ A & \xrightarrow{j} & B \end{array} \uparrow \theta = \begin{array}{ccc} & X & \\ f \swarrow & \xRightarrow{\sigma} & \searrow g \\ A & \xrightarrow{j} & B \end{array}$$

i.e., $\tau \circ (\theta f) = \sigma$.

The pseudo-slice X/\mathbf{C} is the locally full sub-2-category of $X//\mathbf{C}$ with the same objects, but whose 1-cells are those 1-cells (h, σ) of $X//\mathbf{C}$ with σ invertible in \mathbf{C} .

There is a strict 2-functor $Q_X: X//\mathbf{C} \rightarrow \mathbf{C}$ that sends a 2-cell $\theta: (j, \sigma) \rightarrow (k, \tau)$ of $X//\mathbf{C}$ to $\theta: j \rightarrow k$. We denote the (strict) inclusion 2-functor $X/\mathbf{C} \hookrightarrow X//\mathbf{C}$ by I_X and the composite $Q_X I_X$ by P_X .

For us, the word *2-group* refers to a monoidal groupoid in which every object X admits a weak inverse, i.e., an object X^{-1} such that $X \otimes X^{-1} \cong I \cong X^{-1} \otimes X$. A morphism of 2-groups is a strong monoidal functor, and a 2-cell between them is given by a monoidal natural transformation (which is necessarily an isomorphism). We denote the 2-category of (small) 2-groups by $\mathbf{2Grp}$. If \mathbf{C} is a 2-category and A is an object of \mathbf{C} , we denote by $\text{Aut}(A)$ the 2-group of autoequivalences of A and isomorphisms between them, where the tensor product is composition. In particular, we will assume that the ambient category of the identity functor $\text{id}_{\mathbf{C}}: \mathbf{C} \rightarrow \mathbf{C}$ is $[\mathbf{C}, \mathbf{C}]$, so that

$\text{Aut}(\text{id}_{\mathbf{C}})$ denotes the 2-group of pseudonatural autoequivalences of $\text{id}_{\mathbf{C}}$ and of invertible modifications between them.

We will now discuss some issues we face when dealing with lax natural transformations. First of all, whiskering a lax natural transformation along a pseudofunctor on either side results in a well-defined lax natural transformation [12, Section 11.1]. In fact, prewhiskering along $F: \mathbf{C} \rightarrow \mathbf{D}$ defines a pseudofunctor $[\mathbf{D}, \mathbf{E}]_l \rightarrow [\mathbf{C}, \mathbf{E}]_l$, where $[\mathbf{C}, \mathbf{D}]_l$ is the 2-category of pseudofunctors $\mathbf{C} \rightarrow \mathbf{D}$, lax natural transformations and modifications, and this pseudofunctor is strict whenever F is. However, it is well known that taking lax natural transformations do not form the 2-cells of a bicategory, or even of a tricategory, see e.g. the discussion in [16]. In addition to other problems that disappear when restricting to strict 2-functors between strict 2-categories, one has an issue with interchange: while whiskering lax natural transformations between 2-functors is a well-defined operation, the meaning of

$$\begin{array}{ccccc}
 & & F & & H \\
 & \curvearrowright & & \curvearrowright & \\
 \mathbf{C} & & & & \mathbf{D} & & & & \mathbf{E} \\
 & \curvearrowleft & & \curvearrowleft & \\
 & & G & & K
 \end{array}
 \quad (3.3)$$

is ambiguous in general when σ and τ are lax natural, as the two interpretations of the picture—namely, $(K\sigma) \circ (\tau F)$ and $(\tau G) \circ (H\sigma)$ —do not agree. The best we can do in this situation is to use τ in order to obtain 2-cells

$$\begin{array}{ccc}
 HF(A) & \xrightarrow{H(\sigma_A)} & HG(A) \\
 \tau_{F(A)} \downarrow & \nearrow \Psi[\sigma, \tau]_A & \downarrow \tau_{G(A)} \\
 KF(A) & \xrightarrow{K(\sigma_A)} & KG(A)
 \end{array}
 \quad (3.4)$$

resulting in a modification $\Psi = \Psi[\sigma, \tau] : (K\sigma) \circ (\tau F) \rightarrow (\tau G) \circ (H\sigma)$ that is guaranteed to be invertible only when each τ_{σ_A} is invertible (e.g. if τ is pseudonatural). The resulting 3-dimensional structure is roughly speaking a “tricategory with weak interchange”, and can be understood more formally in terms of the canonical self-enrichment stemming from the (lax) Gray tensor product [9, Section I.4], or if one wants to allow for pseudofunctors between strict 2-categories, in terms of categories “weakly enriched in Gray”, see e.g. the formalization in [22, Section 1.3]. However, for our purposes it’s sufficient

to work in a more pedestrian manner: when all lax natural transformations in sight are in fact pseudonatural, we are working in a tricategory, and when on occasion we need a lax natural transformation, we take care to only use invertibility of the (components of the) interchanger $\Psi[\sigma, \tau]_A$ in instances where τ_{σ_A} has been shown to be invertible. On occasion, we will also use this weak interchanger, so for future reference we will record a few trivial observations on it now:

Lemma 3.5. *Consider lax natural transformations σ, τ as in (3.3), and the interchanger $\Psi[\sigma, \tau]$ as defined by (3.4).*

1. *When τ is the identity, the resulting modification $\Psi[\sigma, \tau]$ is the identity modification; more generally, when τ is invertible, then so is $\Psi[\sigma, \tau]$.*
2. *When $\tau = \tau_1 \circ \tau_2$ is a composite of two lax natural transformations, then $\Psi[\sigma, \tau]$ is the composite of the pasting diagram:*

$$\begin{array}{ccc}
 HF & \xrightarrow{H.\sigma} & HG \\
 \tau_1.F \downarrow & \Psi[\sigma, \tau_1] \nearrow & \downarrow \tau_1.G \\
 LF & \xrightarrow{L.\sigma} & LG \\
 \tau_2.F \downarrow & \Psi[\sigma, \tau_2] \nearrow & \downarrow \tau_1.G \\
 KF & \xrightarrow{K.\sigma} & KG
 \end{array}$$

3. *For a modification $\Gamma : \tau \rightarrow \tau'$, we have, for each object A , an equality*

of pasting diagrams

$$\begin{array}{ccccc}
HF(A) & \xrightarrow{\quad} & HF(A) & \xrightarrow{H(\sigma_A)} & HG(A) \\
\tau_{FA} \downarrow & \nearrow \Gamma_{FA} & \tau'_{FA} \downarrow & \nearrow \Psi[\sigma, \tau']_A & \downarrow \tau'_{GA} \\
KF(A) & \xrightarrow{\quad} & KF(A) & \xrightarrow{K(\sigma_A)} & KG(A)
\end{array}$$

$$= \begin{array}{ccccc}
HF(A) & \xrightarrow{H(\sigma_A)} & HG(A) & \xrightarrow{\quad} & HG(A) \\
\tau_{FA} \downarrow & \nearrow \Psi[\sigma, \tau']_A & \downarrow \tau_{GA} & \nearrow \Gamma_{GA} & \tau'_{GA} \downarrow \\
KF(A) & \xrightarrow{K(\sigma_A)} & KG(A) & \xrightarrow{\quad} & KG(A)
\end{array}$$

Lastly, we will use string diagrams [17, 21] to aid our reasoning, both when reasoning inside a 2-category or a monoidal category, and when reasoning about pseudonatural transformations between 2-functors. Strictly speaking, in the latter case one might want to use three-dimensional surface diagrams, but for our purposes the two-dimensional string diagram calculus is sufficient: the main difference to the usual string diagrams is that instead of equations between string diagrams we get isomorphisms between them, representing invertible modifications. As we do not need to reason about equations between the resulting modifications, this two-dimensional reasoning strikes a good balance between readability and rigor.

Our convention is to write string diagrams bottom to top, e.g.

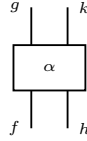

represents a 2-cell $\alpha : h \circ f \Rightarrow k \circ g$.

4. Two-dimensional isotropy

We now aim to define, for a 2-category \mathbf{C} , the isotropy 2-group of \mathbf{C} . It will be convenient to also introduce the notion of isotropy 2-monoid; in fact, once we define $\mathcal{M} : \mathbf{C} \rightarrow \mathbf{MonCat}$, the isotropy 2-group $\mathcal{Z} : \mathbf{C} \rightarrow \mathbf{2Grp}$ is

then simply the composite of \mathcal{M} with the 2-functor $\mathbf{MonCat} \rightarrow \mathbf{2Grp}$ that sends a monoidal category to the subcategory of weakly invertible objects. Towards defining \mathcal{M} and \mathcal{Z} , we first introduce an approximation to these concepts as follows:

Definition 4.1. Given a 2-category \mathbf{C} and an object X of \mathbf{C} , let $\mathcal{M}_{ps}(X)$ be the monoidal category whose objects are pseudonatural endomorphisms of $P_X: X/\mathbf{C} \rightarrow \mathbf{C}$, whose morphisms are given by modifications, and where the monoidal product is given by composition. We also let $\mathcal{Z}_{ps}(X)$ be the subcategory of \mathcal{M}_{ps} on the pseudonatural autoequivalences of P_X and the invertible modifications between them.

Unfortunately, this definition does not quite work in general: as the following example shows, the assignment $X \mapsto \mathcal{Z}_{ps}(X)$ (and similarly $X \mapsto \mathcal{M}_{ps}(X)$) need not be functorial.

Example 4.2. Let \mathbf{C} be the 2-category generated by

- Two objects X and Y
- Two 1-cells $f, g: X \rightarrow Y$ and two 1-cells $\alpha_f, \alpha_g: Y \rightarrow Y$
- A 2-cell $\theta: f \rightarrow g$

subject to the constraints

- α_f, α_g are isomorphisms
- $\alpha_f f = f$ and $\alpha_g = g$

A pictorial representation of the generators of \mathbf{C} is given by

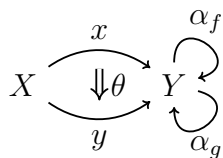

There is a 2-natural automorphism α of $X/\mathbf{C} \rightarrow \mathbf{C}$ whose components at id_X, f and g are given by id_X, α_f and α_g , respectively, with the remaining components determined uniquely by these choices. However, there is no 2-cell $\alpha_f \rightarrow \alpha_g$, and consequently no modification from α_f to α_g . This shows that in general one cannot get a 2-functor sending X to $\mathcal{Z}_{ps}(X)$.

We thus seek to modify the above definition in such a way that we obtain well-defined 2-functors. The solution is to consider the lax slice, together with a slightly wider class of transformations, defined as follows.

Definition 4.3. Given a 2-category \mathbf{C} and an object X of \mathbf{C} , we will call a lax natural endomorphism of $Q_X: X//\mathbf{C} \rightarrow \mathbf{C}$ *almost pseudonatural* if its restriction along $I_X: X/\mathbf{C} \rightarrow X//\mathbf{C}$ is pseudonatural.

It is straightforward to show that the composite of almost pseudonatural transformations is again almost pseudonatural: if α, β are such that $\alpha.I_X$ and $\beta.I_X$ are pseudonatural, then so is the composite $(\alpha \circ \beta).I_X = (\alpha.I_X) \circ (\beta.I_X)$.

Example 4.4. Assume \mathbf{C} has a pseudo-terminal object 1 . Then any 1-cell $x: 1 \rightarrow X$ in \mathbf{C} induces an endomorphism of $Q_X: X//\mathbf{C} \rightarrow \mathbf{C}$ whose 1-cell component at $f: X \rightarrow A$ is given by $A \xrightarrow{!} 1 \xrightarrow{x} X \xrightarrow{f} A$ and whose 2-cell components at $(j, \sigma): (A, f) \rightarrow (B, g)$ is given by

$$\begin{array}{ccccccc}
 A & \xrightarrow{!} & 1 & \xrightarrow{x} & X & \xrightarrow{f} & A \\
 j \downarrow & & \downarrow \text{id} & & \downarrow \text{id} & \swarrow \sigma & \downarrow j \\
 B & \xrightarrow{!} & 1 & \xrightarrow{x} & X & \xrightarrow{g} & B
 \end{array}$$

where the leftmost square is to be filled with the canonical isomorphism. Note that this 2-cell is invertible whenever j is, so that this endomorphism is almost pseudonatural. In the case where \mathbf{C} is the 2-category \mathbf{MonCat}_1 of monoidal categories, lax monoidal functors and monoidal natural transformations, such endomorphisms of $P_{\mathbf{C}}: \mathbf{C}//\mathbf{MonCat}_1 \rightarrow \mathbf{MonCat}_1$ thus correspond to monoids in \mathbf{C} . Moreover, modifications between two such endomorphisms correspond to monoid homomorphisms.

With this class of transformations we can now give the final definition of the isotropy 2-monoid and isotropy 2-group:

Definition 4.5. Given a 2-category \mathbf{C} and an object X of \mathbf{C} , the

1. *isotropy 2-monoid* $\mathcal{M}(X)$ at X is the monoidal category whose objects are almost pseudonatural endomorphisms of $Q_X: X//\mathbf{C} \rightarrow \mathbf{C}$, whose morphisms are modifications, and where the monoidal product is given by composition;

2. *isotropy 2-group* $\mathcal{Z}(X)$ at X is the 2-group whose objects are almost pseudonatural autoequivalences of $Q_X: X//\mathbf{C} \rightarrow \mathbf{C}$, whose morphisms are invertible modifications, and where the monoidal product is given by composition.

In Section 5 we will prove that under suitable assumptions on \mathbf{C} , we in fact have that $\mathcal{M} \cong \mathcal{M}_{ps}$ and $\mathcal{Z} \cong \mathcal{Z}_{ps}$.

In the remainder of this section we demonstrate that for general \mathbf{C} , \mathcal{M} and \mathcal{Z} are well-defined 2-functors. It suffices to show this for $X \mapsto \mathcal{M}(X)$, as \mathcal{Z} can be obtained from \mathcal{M} by postcomposing with the 2-functor $\mathbf{MonCat} \rightarrow \mathbf{2Grp}$ that sends a monoidal category to its 2-group of weakly invertible objects. We will deduce the functoriality of $X \mapsto \mathcal{M}(X)$ formally, but we will interleave this with an explicit discussion of how \mathcal{M} acts on objects, morphisms and 2-cells of \mathbf{C} . In fact, the same argument will establish functoriality of sending X to all lax natural endomorphisms Q_X and not just to the almost pseudonatural ones. However, as for our purposes $\mathcal{M}(X)$ already is merely a convenient ambient structure, we do not consider this variant of the isotropy 2-monoid further.

To begin, let us spell out the meaning of a lax natural endomorphism of $Q_X: X//\mathbf{C} \rightarrow \mathbf{C}$: the data for such an automorphism α consists of

- for each object (A, f) of $X//\mathbf{C}$, a 1-cell $\alpha_{(A,f)}: A \rightarrow A$ in \mathbf{C}
- for each 1-cell $(j, \sigma): (A, f) \rightarrow (B, g)$ of $X//\mathbf{C}$, a 2-cell $\alpha_{(j,\sigma)}: j\alpha_{(A,f)} \rightarrow \alpha_{(B,g)}j$ in \mathbf{C} , depicted by the pasting diagram

$$\begin{array}{ccc}
 A & \xrightarrow{j} & B \\
 \alpha_{(A,f)} \downarrow & \nearrow \alpha_{(j,\sigma)} & \downarrow \alpha_{(B,g)} \\
 A & \xrightarrow{j} & B
 \end{array}$$

or the string diagram

$$\begin{array}{c}
 j \quad \alpha_{(B,g)} \\
 | \quad | \\
 \boxed{\alpha_{(j,\sigma)}} \\
 | \quad | \\
 \alpha_{(A,f)} \quad j
 \end{array}$$

This data should satisfy the following conditions

- (2-naturality): for any 2-cell $\theta: (j, \sigma) \rightarrow (k, \tau)$ of $X//\mathbf{C}$ we have

- (unit constraint): for any identity 1-cell $(\text{id}_A, \text{id}_f): (A, f) \rightarrow (A, f)$ of $X//\mathbf{C}$ we have

- (respect for composites): for any $(j, \sigma): (A, f) \rightarrow (B, g)$ and $(k, \tau): (B, g) \rightarrow (C, h)$ we have

A lax natural endomorphism α of $Q_X: X//\mathbf{C} \rightarrow \mathbf{C}$ is almost pseudonatural if $\alpha_{[j, \sigma]}$ is invertible whenever σ is invertible.

A modification $\Gamma: \alpha \rightarrow \beta$ between two such lax natural transformations α, β consists of a 2-cell $\Gamma_{(A, f)}: \alpha_{(A, f)} \rightarrow \beta_{(A, f)}$ in \mathbf{C} for each object (A, f) of $X//\mathbf{C}$ such that

This equips $\mathcal{M}(X)$ with the structure of a category. This category is in fact a (strict) monoidal category, as a result of the general fact that for any

two 2-categories \mathbf{C}, \mathbf{D} there is a strict 2-category $[\mathbf{C}, \mathbf{D}]_l$ of pseudofunctor $\mathbf{C} \rightarrow \mathbf{D}$, lax natural transformations and modifications, so that for any functor $F: \mathbf{C} \rightarrow \mathbf{D}$ the category $[\mathbf{C}, \mathbf{D}]_l(F, F)$ is strictly monoidal. Moreover, it is easy to see that $\mathcal{M}(X)$ is indeed a monoidal subcategory of the category of all lax automorphisms of $Q_X: X//\mathbf{C} \rightarrow \mathbf{C}$.

We next describe the action of \mathcal{M} on morphisms and 2-cells. Given $x: X \rightarrow Y$ in \mathbf{C} , we now define $\mathcal{M}(x): \mathcal{M}(X) \rightarrow \mathcal{M}(Y)$. Conceptually, this can be defined by observing that x induces a 2-functor $x^*: Y//\mathbf{C} \rightarrow X//\mathbf{C}$ fitting into a strictly commuting triangle

$$\begin{array}{ccc} & Y//\mathbf{C} & \\ x^* \swarrow & & \searrow \\ X//\mathbf{C} & \longrightarrow & \mathbf{C} \end{array}$$

so that given $\alpha \in \mathcal{M}(X)$ we can define $\mathcal{M}(x)\alpha$ by whiskering along x^* . As whiskering along x^* also sends modifications to modifications and preserves composites of lax transformations on the nose, $\mathcal{M}(x)$ is in fact a strict monoidal functor.

Unwinding this definition amounts to defining the 1-cells of $\mathcal{M}(x)\alpha$ by setting $(\mathcal{M}(x)\alpha)_{(A,f)} := \alpha_{(A,fx)}$ for $(A, f) \in Y//\mathbf{C}$ and the 2-cells by setting $(\mathcal{M}(x)\alpha)_{j,\sigma} = \alpha_{(j,\sigma x)}$ for $(j, \sigma): (A, f) \rightarrow (B, g)$ in $Y//\mathbf{C}$, i.e.,

$$\begin{array}{c} \begin{array}{ccc} j & & (\mathcal{M}(x)\alpha)_{(B,g)} \\ | & & | \\ \boxed{(\mathcal{M}(x)\alpha)_{(j,\sigma)}} & & \\ | & & | \\ (\mathcal{M}(x)\alpha)_{(A,f)} & & j \end{array} & := & \begin{array}{ccc} j & & \alpha_{(B,gx)} \\ | & & | \\ \boxed{\alpha_{(j,\sigma x)}} & & \\ | & & | \\ \alpha_{(A,fx)} & & j \end{array} \end{array} .$$

Given a modification $\Gamma: \alpha \rightarrow \beta$, the modification $\mathcal{M}(x)\Gamma: \mathcal{M}(x)\alpha \rightarrow \mathcal{M}(x)\beta$ is then obtained by whiskering along x^* : explicitly this means that at an object (A, f) of $Y//\mathbf{C}$ we have $(\mathcal{M}(x)\Gamma)_{(A,f)} = \Gamma_{(A,fx)}$.

We next give the action of \mathcal{M} on a 2-cell $\theta: x \rightarrow y$, resulting in a monoidal natural transformation $\mathcal{M}(\theta): \mathcal{M}(x) \rightarrow \mathcal{M}(y)$. First of all, θ induces a 2-natural transformation $\theta^*: x^* \rightarrow y^*$. If we take $\alpha \in \mathcal{M}(X)$, then we have a

diagram

$$\begin{array}{ccc}
& x^* & \\
& \curvearrowright & \\
Y//\mathbf{C} & \Downarrow \theta^* & X//\mathbf{C} \\
& \curvearrowleft & \\
& y^* & \\
& & \begin{array}{ccc}
& Q_X & \\
& \curvearrowright & \\
& \Downarrow \alpha & \\
& \curvearrowleft & \\
& Q_X & \\
& & \mathbf{C}
\end{array}
\end{array}$$

Consequently, we may consider the interchange modification $\Psi[\theta^*, \alpha]$ as defined in (3.4); noting that $Q_X.\theta^* = 1$, we get a modification

$$\mathcal{M}(x)\alpha = \alpha x^* = \text{id} \circ (\alpha x^*) = (Q_X \theta^*) \circ (\alpha x^*) \xrightarrow{\Psi[\theta^*, \alpha]} (\alpha y^*) \circ (Q_X \theta^*) = \mathcal{M}(y)\alpha.$$

By Lemma 3.5 part 3, we have, for each modification $\Gamma : \alpha \rightarrow \beta$, a commutative square

$$\begin{array}{ccc}
(Q_X \theta^*) \circ (\alpha x^*) & \xrightarrow{\Psi[\theta^*, \alpha]} & (\alpha y^*) \circ (Q_X \theta^*) \\
\downarrow (Q_X \theta^*) \circ (\Gamma.x^*) & & \downarrow (\Gamma.y^*) \circ (Q_X \theta^*) \\
(Q_X \theta^*) \circ (\beta x^*) & \xrightarrow{\Psi[\theta^*, \beta]} & (\beta y^*) \circ (Q_X \theta^*)
\end{array}$$

from which it follows that $\mathcal{M}(\theta)$ is a natural transformation. Moreover, the first two properties of interchangers stated in Lemma 3.5 imply that this natural transformation is a monoidal one: the tensor unit of $\mathcal{M}(x)$ is the identity transformation for which this interchanger is the identity, and the interchanger at a composite agreeing with the composite of the interchangers implies that $\mathcal{M}(\theta)_{\alpha \otimes \beta} = \mathcal{M}(\theta)_\alpha \otimes \mathcal{M}(\theta)_\beta$.

We now describe explicitly what $\mathcal{M}(\theta)$ amounts to by describing its component modifications $\mathcal{M}(\theta)_\alpha : \mathcal{M}(x)\alpha \rightarrow \mathcal{M}(y)\alpha$ for each $\alpha \in \mathcal{M}(X)$. Given $\alpha \in \mathcal{M}(X)$, the data of such a modification consists of a 2-cell $\alpha_{(A,fx)} = (\mathcal{M}(x)\alpha)_{(A,f)} \rightarrow (\mathcal{M}(y)\alpha)_{(A,f)} = \alpha_{(A,fy)}$ for any object (A, f) of $Y//\mathbf{C}$. Observe now that θ induces a 1-cell $(\text{id}, f\theta) : (A, fx) \rightarrow (A, fy)$ in $X//\mathbf{C}$, so that $\alpha_{(\text{id}, f\theta)}$ is a 2-cell $\alpha_{(A,fx)} \rightarrow \alpha_{(A,fy)}$: it is these 2-cells that form $\mathcal{M}(\theta)_\alpha$.

We summarize all of the above in the following.

Theorem 4.6. *For a 2-category \mathbf{C} , the assignment $X \mapsto \mathcal{M}(X)$ underlies a well-defined 2-functor $\mathcal{M} : \mathbf{C} \rightarrow \mathbf{MonCat}$, and $X \mapsto \mathcal{Z}(X)$ underlies a well-defined 2-functor $\mathcal{Z} : \mathbf{C} \rightarrow \mathbf{2Grp}$.*

To conclude this section, we note that the isotropy 2-group truly is a generalization of the one-dimensional isotropy group: if \mathbf{C} is a 1-category viewed as a locally discrete 2-category $d\mathbf{C}$, then the resulting isotropy 2-group coincides with viewing the isotropy group $Z : \mathbf{C} \rightarrow \mathbf{Grp}$ as a locally discrete 2-group. More precisely, letting $d : \mathbf{Cat} \rightarrow \mathbf{2Cat}$ be the 2-functor that is left adjoint to the 2-functor $\mathbf{2Cat} \rightarrow \mathbf{Cat}$ that forgets the 2-cells, we obtain an extension of the composite

$$\mathbf{C} \rightarrow \mathbf{Grp} \rightarrow \mathbf{2Grp}$$

to a 2-functor $\tilde{Z} : d\mathbf{C} \rightarrow \mathbf{2Grp}$; this extension is precisely $\mathcal{Z} : d\mathbf{C} \rightarrow \mathbf{2Grp}$.

5. Isotropy in the presence of binary coproducts

To be able to compute \mathcal{Z} , we now move on generalize the tools of Section 2 to the 2-categorical setting, focusing on coproducts in this section. Throughout this section, we assume that \mathbf{C} has binary coproducts. To clarify the level of weakness intended, we refer to coproducts in the bicategorical sense, so that $\mathbf{C}(A + B, -)$ represents $\mathbf{C}(A, -) \times \mathbf{C}(B, -)$ up to a pseudonatural equivalence, which we assume to be fixed once and for all. We will write $[-, -]$ for the equivalence

$$\mathrm{hom}_{\mathbf{C}}(A, -) \times \mathrm{hom}_{\mathbf{C}}(B, -) \rightarrow \mathrm{hom}_{\mathbf{C}}(A + B, -),$$

so that $[f, g]$ gives the chosen factorization of f and g up to isomorphism through the coproduct injections. To avoid cluttering the diagrams, we will suppress the chosen invertible 2-cells from the notation, but we do not mean to assume that diagrams involving coproducts commute strictly.

With our assumptions, for each X , the coproducts in \mathbf{C} induce a pseudofunctor $L_X : \mathbf{C} \rightarrow X/\mathbf{C}$ sending

$$\begin{array}{ccc} & k & \\ A & \begin{array}{c} \curvearrowright \\ \uparrow \theta \\ \curvearrowleft \end{array} & B \\ & j & \end{array}$$

in \mathbf{C} to

$$\begin{array}{ccc}
& X & \\
i_X \swarrow & \cong & \searrow i_X \\
& X + k & \\
X + A \xrightarrow{\quad} & \Uparrow X + \theta & \xrightarrow{\quad} X + B \\
& \Downarrow & \\
& X + j &
\end{array}$$

in X/\mathbf{C} .

Now, L_X is the left biadjoint of $X/\mathbf{C} \xrightarrow{P_X} \mathbf{C}$.

In particular, taking mates induces a monoidal equivalence between the monoidal category of all pseudonatural endomorphisms of L_X and the reverse of that of all pseudonatural endomorphisms of P_X . Here by the reverse \mathbf{D}^{rev} of a monoidal category \mathbf{D} we refer to the monoidal category obtained from \mathbf{D} by keeping the underlying category fixed but switching the order of the tensor product, so that $A \otimes^{\text{rev}} B := B \otimes A$. Before showing that \mathcal{Z} can be computed in terms of automorphisms of L_X , we first show that the difference between pseudo- and lax slices is immaterial in the presence of binary coproducts. Towards this aim, let us first consider the composite $I_X L_X Q_X : X//\mathbf{C} \rightarrow X//\mathbf{C}$, which sends an object (A, f) to $i_X : X \rightarrow X + A$. We now observe that there is a canonical lax natural transformation $\tau : I_X L_X Q_X \rightarrow \text{id}_{X//\mathbf{C}}$ whose component at (A, f) is the 1-cell

$$\begin{array}{ccc}
& X & \\
i_X \swarrow & \cong & \searrow f \\
X + A & \xrightarrow{[f, \text{id}]} & A
\end{array}$$

and with lax naturality square at $(j, \sigma): (A, f) \rightarrow (B, g)$ given by

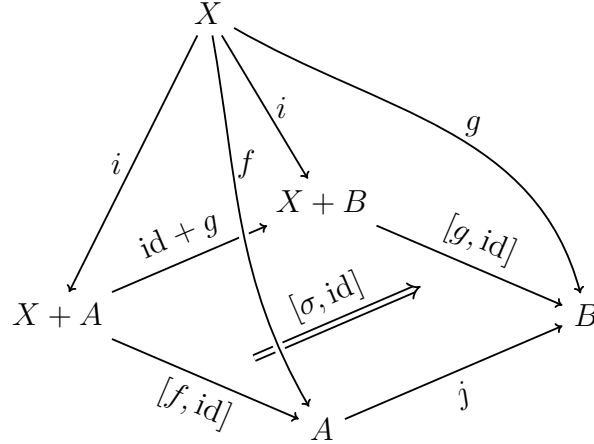

Theorem 5.1. *If \mathbf{C} has binary coproducts, then whiskering along $X/\mathbf{C} \hookrightarrow X//\mathbf{C}$ induces an isomorphism of monoidal categories $\mathcal{M}(X) \rightarrow \mathcal{M}_{ps}(X)$ and of 2-groups $\mathcal{Z}(X) \rightarrow \mathcal{Z}_{ps}(X)$*

Proof. It suffices to prove the claim for \mathcal{M} and $\mathcal{M}_{ps}(X)$ —if two monoidal categories are isomorphic, so are their associated 2-groups on weakly invertible objects. We’ll use G_X to denote the functor $\mathcal{M}(X) \rightarrow \mathcal{M}_{ps}(X)$ that acts by whiskering along $I_X : X/\mathbf{C} \hookrightarrow X//\mathbf{C}$. Note first that G_X is a strict monoidal functor. We will first show that G_X is an equivalence, by exhibiting a pseudoinverse $F_X : \mathcal{M}_{ps}(X) \rightarrow \mathcal{M}(X)$ and natural isomorphisms $F_X G_X \cong \text{id}$ and $G_X F_X \cong \text{id}$. The pseudoinverse $F_X : \mathcal{M}_{ps}(X) \rightarrow \mathcal{M}(X)$ is defined by

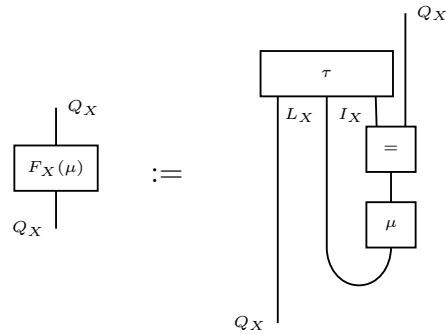

where τ is the lax natural transformation $I_X L_X Q_X \rightarrow \text{id}_{X//\mathbf{C}}$ described above.

We now describe F_X explicitly. Given $\mu \in \mathcal{M}_{ps}(X)$ and an object (A, f) of $X//\mathbf{C}$, $F_X(\mu)_{(A,f)}$ is defined as the composite

$$A \xrightarrow{i_A} X + A \xrightarrow{\mu_{i_X}} X + A \xrightarrow{[f, \text{id}]} A. \quad (5.2)$$

Given a 1-cell $(j, \sigma): (A, f) \rightarrow (B, g)$, the 2-cell $F_X(\mu)_{(j, \sigma)}$ arises via the diagram

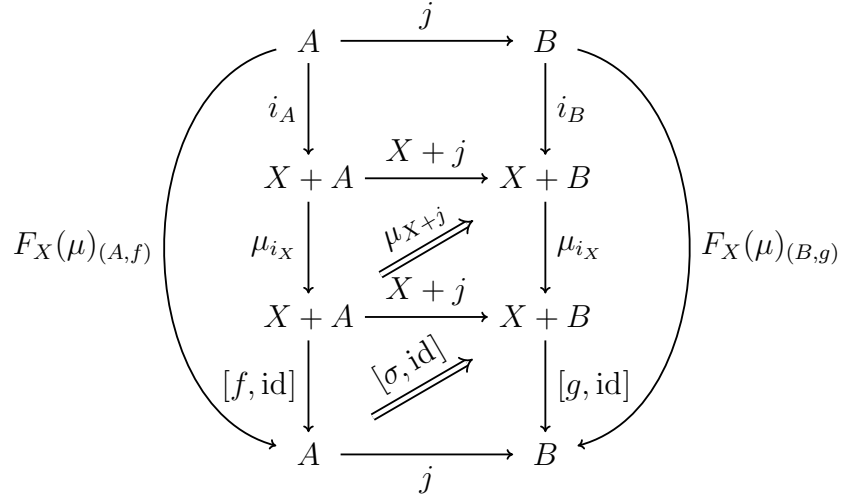

On morphisms, F_X acts by sending $\Gamma: \mu \rightarrow \nu$ to the modification $F_X(\Gamma): F_X(\mu) \rightarrow F_X(\nu)$ where $F_X(\Gamma)_{(A,f)}$ is defined by

$$A \xrightarrow{i_A} X + A \begin{array}{c} \xrightarrow{\mu_A} \\ \Downarrow \Gamma_A \\ \xrightarrow{\nu_A} \end{array} X + A \xrightarrow{[f, \text{id}]} A$$

Note that it follows from the description (5.2) by taking $\mu = 1$, we get:

$$(5.3)$$

We now show that F_X is the pseudoinverse of G_X . Note first that the string diagram representation of G_X is

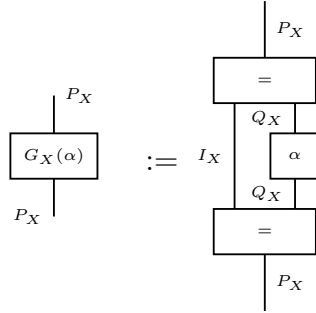

Then the isomorphism $F_X G_X \rightarrow \text{id}$ at $\alpha \in \mathcal{M}(X)$ is the composite

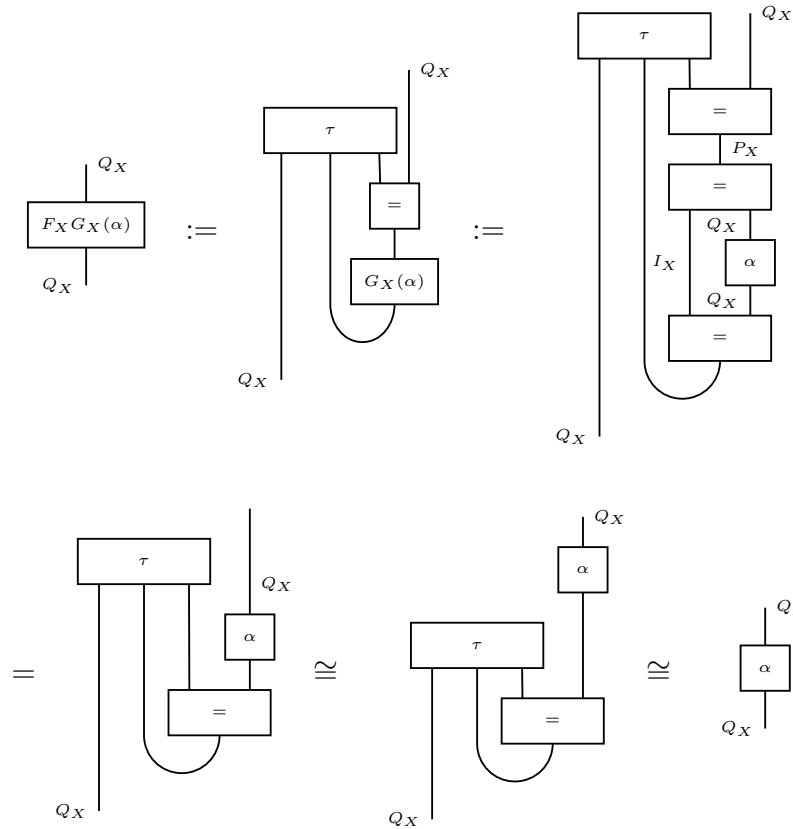

where the penultimate isomorphism is an instance of invertible interchange (as α is almost pseudonatural), and the last one is (5.3).

Explicitly, the modification $F_X G_X(\alpha) \rightarrow \alpha$ at the index (A, f) is given by

$$\begin{array}{c}
 \text{id} \\
 \curvearrowright \\
 \begin{array}{ccccc}
 & & X + A & \xrightarrow{[f, \text{id}]} & A \\
 & i_A \nearrow & \downarrow \alpha_{i_X} & \nearrow \alpha_{([f, \text{id}], \cong)} & \downarrow \alpha_{(A, f)} \\
 A & & X + A & & A \\
 & i_A \searrow & \downarrow G(\alpha)_{i_X} & \searrow [f, \text{id}] & \\
 & & G(\alpha)_{i_X} X + A & \xrightarrow{[f, \text{id}]} & A
 \end{array} \\
 \curvearrowleft \\
 F_X G_X(\alpha)_{(A, f)}
 \end{array}
 \tag{5.4}$$

The isomorphism $G_X F_X \rightarrow \text{id}$ at $\mu \in \mathcal{M}_{ps}(X)$ is the composite

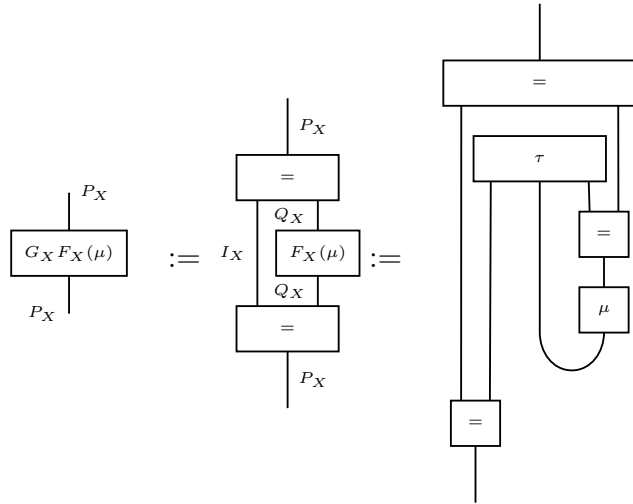

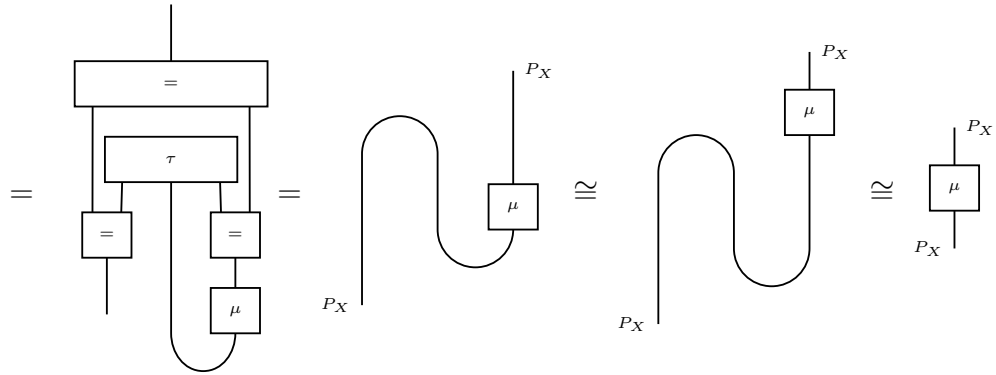

where we used the equality

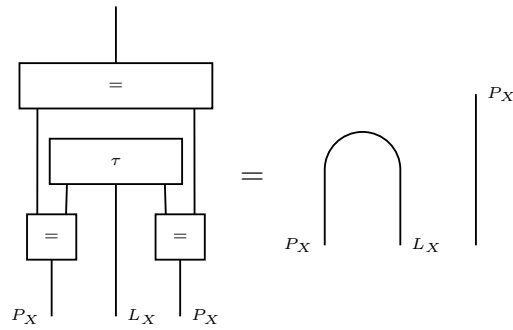

which is a consequence of (5.3).

Explicitly, the isomorphism $G_X F_X(\mu) \rightarrow \mu$ at (A, f) is rather like $F_X G_X(\alpha) \rightarrow \alpha$ and is given by

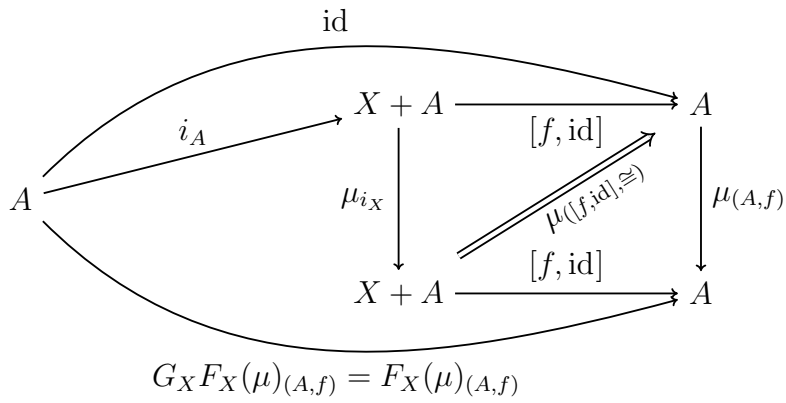

We now use this to show that G_X is in fact a strict monoidal isomorphism. As we already know that G_X is a strict monoidal functor and an equivalence, it suffices to show that G_X is bijective on objects. To see that G_X is surjective on objects is straightforward. Abstractly, this follows from the fact that any essentially surjective isofibration is in fact strictly surjective on objects. Explicitly, given $\mu \in \mathcal{M}_{ps}(X)$, we can choose α and an invertible modification $\Gamma: G_X(\alpha) \rightarrow \mu$. Now, there is a unique $\beta \in \mathcal{M}(X)$ such that the 2-cells of Γ induce an invertible modification $\alpha \rightarrow \beta$, and by construction $G_X(\beta) = \mu$.

To see that G_X is injective, note that the modification $F_X G_X(\alpha) \rightarrow \alpha$ being invertible implies that the 2-cells $\alpha_{(j,\sigma)}$ of α can be recovered by conjugating the 2-cells $F_X G_X(\alpha)_{(j,\sigma)}$ with the modification. Now, $F_X G_X(\alpha)_{(j,\sigma)}$ depends only on $G_X(\alpha)$, and by inspecting diagram 5.4, so do the component 2-cells of the modification $F_X G_X(\alpha) \rightarrow \alpha$. Hence $G(\alpha) = G(\beta)$ implies $\alpha = \beta$. \square

As a result, when binary coproducts exist, obstructions like those of Example 4.2 cannot arise. Indeed, the assignment sending X to pseudonatural endomorphisms of $P_X: X/\mathbf{C} \rightarrow \mathbf{C}$ becomes a 2-functor, with the action on 1-cells defined similarly as for \mathcal{M} (indeed, the action of \mathcal{M}_{ps} on 1-cells is well-defined even without coproducts). The action on 2-cells can be described as

follows. Given a 2-cell $x \begin{array}{c} \xrightarrow{x} \\ \Downarrow \sigma \\ \xrightarrow{y} \end{array} y$ in \mathbf{C} and $\alpha \in \mathcal{M}_{ps}$, we can define a

modification $\mathcal{M}_{ps}(\sigma)\alpha: \mathcal{M}_{ps}(x)\alpha \rightarrow \mathcal{M}_{ps}(y)\alpha$ by first extending α to $G(\alpha)$ and then restricting $\mathcal{M}(\sigma)$ to obtain a modification $\mathcal{M}_{ps}(x)\alpha \rightarrow \mathcal{M}_{ps}(y)\alpha$. Explicitly, the component of the resulting modification at (A, f) is given by

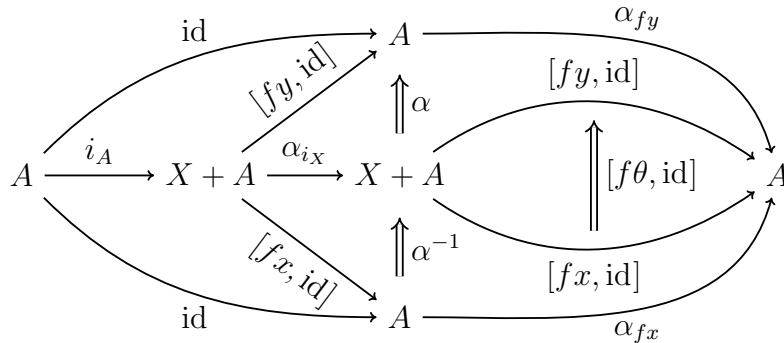

We can now also reformulate \mathcal{M} and \mathcal{Z} in terms of pseudonatural endo-

required 2-cell is defined on A by

$$\begin{array}{ccccc}
 & & & & (\mathcal{L}(x)\mu)_A \\
 & & & & \uparrow \\
 & & & & x + A \\
 & & & & \downarrow \\
 & & & & \theta + A \\
 & & & & \downarrow \\
 & & & & y + A \\
 & & & & \downarrow \\
 & & & & (\mathcal{L}(y)\mu)_A
 \end{array}
 \begin{array}{c}
 \begin{array}{c}
 \xrightarrow{i_A} \\
 \xrightarrow{i_A} \\
 \xrightarrow{i_A}
 \end{array}
 \begin{array}{c}
 Y + A \\
 X + A \\
 Y + A
 \end{array}
 \begin{array}{c}
 \xrightarrow{\mu_A} \\
 \xrightarrow{\mu_A} \\
 \xrightarrow{\mu_A}
 \end{array}
 \begin{array}{c}
 X + A \\
 X + A \\
 X + A
 \end{array}
 \begin{array}{c}
 \xrightarrow{x + A} \\
 \xrightarrow{\theta + A} \\
 \xrightarrow{y + A}
 \end{array}
 \begin{array}{c}
 Y + A \\
 Y + A \\
 Y + A
 \end{array}
 \end{array}$$

With this definition, we then obtain:

Corollary 5.5. *Let \mathbf{C} be a 2-category with binary coproducts. Then \mathcal{M} is pseudonaturally equivalent to the pseudofunctor \mathcal{N} defined above. Moreover, there is a pseudonatural equivalence between \mathcal{Z} and the functor \mathcal{L} that sends X to the reverse of the 2-group of all pseudonatural autoequivalences of $L_X: \mathbf{C} \rightarrow X/\mathbf{C}$ and invertible modifications between them, with the action of \mathcal{L} on 1 and 2-cells defined as for \mathcal{N} .*

Proof. It suffices to prove the claim for \mathcal{M} and \mathcal{N} , as the claim for \mathcal{Z} and \mathcal{L} follows from it. Taking mates induces a monoidal equivalence between the monoidal category of all pseudonatural endomorphisms of P_X and the reverse of the monoidal category of all pseudonatural endomorphisms of L_X . Composing this with the isomorphisms from Theorem 5.1 then gives an equivalence $\mathcal{N}(X) \cong \mathcal{Z}(X)$ for each X , and using these pointwise equivalences the assignment $X \mapsto \mathcal{N}(X)$ can be promoted (via Lemma 3.1) into a pseudofunctor \mathcal{N}' pseudonaturally equivalent to \mathcal{Z} . We now show that \mathcal{N}' is again equivalent to our desired \mathcal{N} from the statement of the corollary. In fact, as \mathcal{N}' already has the desired action on objects, it suffices to show that each monoidal functor $\mathcal{N}'(x)$ is (monoidally) isomorphic to $\mathcal{N}(x)$, for these monoidal isomorphisms can then be used to promote \mathcal{N}' into a pseudofunctor for which these monoidal isomorphisms then give an invertible icon $\mathcal{N}' \rightarrow \mathcal{N}$.

Now, $\mathcal{N}'(x)\mu$ is defined by

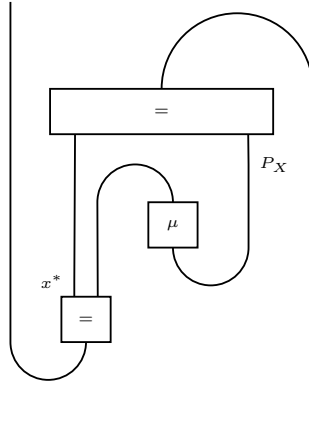

However, to know an element $\mu \in \mathcal{N}(Y)$ within isomorphism, it is enough to know the restrictions of the 1 and 2-cell components along inclusions $A \rightarrow X + A$ for each A . Hence $\mathcal{N}'(X)\mu$ is determined by

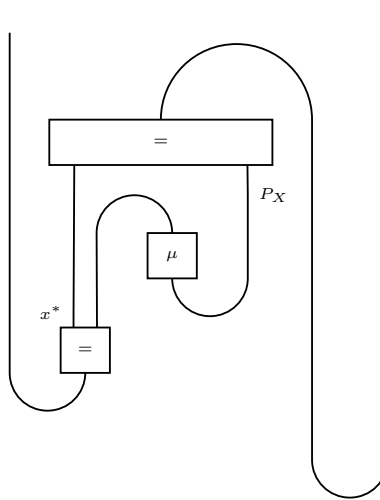

(*)

We now compute as follows

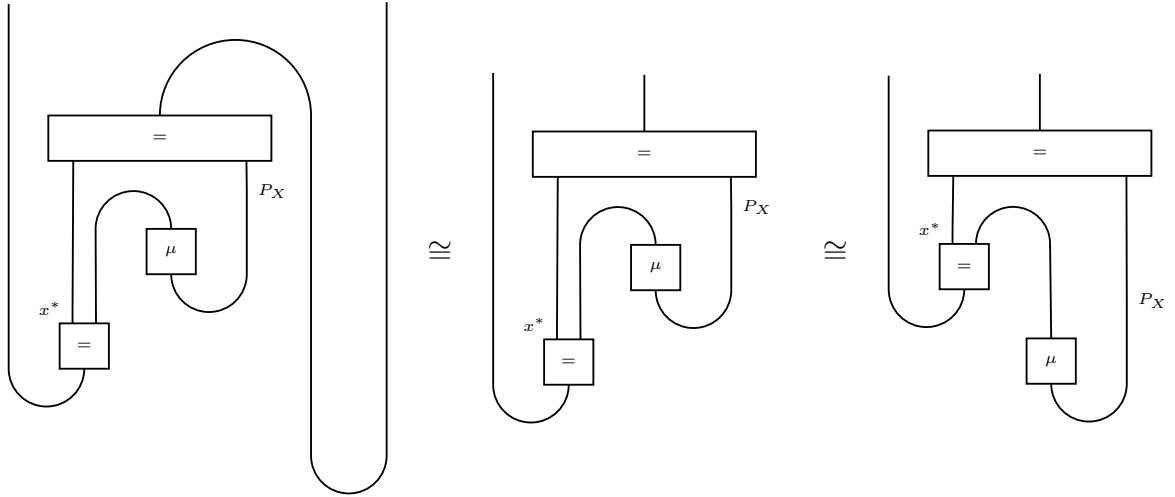

To simplify this further, we observe first that $x: X \rightarrow Y$ induces a pseudonatural transformation $\sigma(x): L_X \rightarrow x^*L_Y$ whose 1-cell component at an object $A \in \mathbf{C}$ is given by

$$\begin{array}{ccc}
 & X & \\
 i_X \swarrow & & \searrow x \\
 X + A & \xrightarrow{x + A} & Y + A \\
 & \cong & \swarrow i_Y
 \end{array}$$

There is an invertible modification

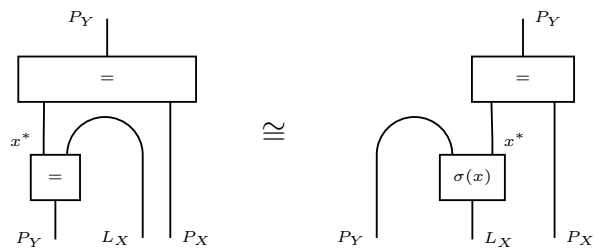

corresponding to the isomorphisms

$$\begin{array}{ccc}
 & x + A & \xrightarrow{\quad} & Y + A & \xrightarrow{[f, \text{id}]} & \\
 X + A & & & \cong & & A \\
 & & \xrightarrow{[fx, \text{id}]} & & &
 \end{array}$$

for $(A, f) \in Y/\mathbf{C}$, where the top path corresponds to a 1-cell of the RHS and the bottom path to a 1-cell of the LHS. We can then continue the calculation and conclude that $*$ is isomorphic to

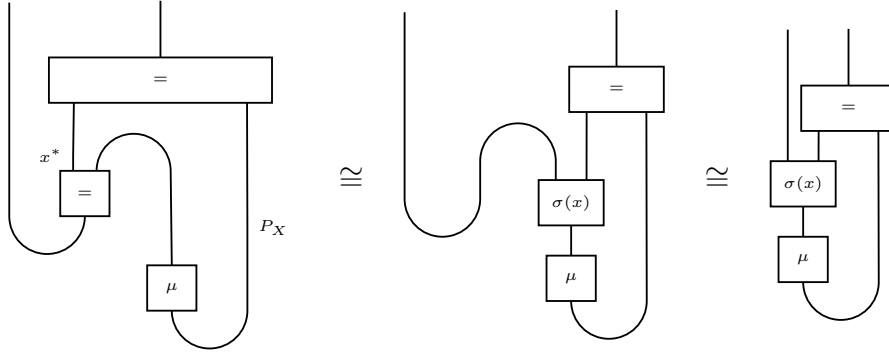

Unwinding the definition of the right hand side, we see that $\mathcal{N}'(x)\mu$ is isomorphic to $\mathcal{N}(x)\mu$. Moreover, this isomorphism is clearly natural in μ and it is monoidally natural as it respects composition of endomorphisms. It is straightforward to check that the resulting action on 2-cells is as desired. \square

6. Isotropy and two-dimensional density

We now seek to generalize the results about isotropy and dense functors from Section 2 to the two-dimensional setting. As we are unaware of a bicategorical treatment of density (as opposed to the strict \mathbf{Cat} -enriched notion) we will adapt (i)-(iv) of [14, Theorem 5.1] to the bicategorical setting. The word “cocontinuous” below is to be understood in the bicategorical sense i.e., as preserving bicolimits but not necessarily strict 2-categorical limits: for instance, any left biadjoint is cocontinuous in this sense.

Proposition 6.1. *Let \mathbf{C} and \mathbf{D} be bicategories. The following conditions are equivalent for a pseudofunctor $F: \mathbf{C} \rightarrow \mathbf{D}$.*

- (i) for all cocontinuous pseudofunctors $G, H: \mathbf{D} \rightarrow \mathbf{E}$, restriction along F induces an equivalence of categories $\text{hom}(G, H) \rightarrow \text{hom}(GF, HF)$.
- (ii) the restricted Yoneda embedding $\mathbf{D} \xrightarrow{Y} [\mathbf{D}^{\text{op}}, \mathbf{Cat}] \xrightarrow{\hat{F}} [\mathbf{C}^{\text{op}}, \mathbf{Cat}]$ is a local equivalence.
- (iii) for all objects A, B of \mathbf{D} , the functor

$$\mathbf{D}(A, B) \rightarrow [\mathbf{C}^{\text{op}}, \mathbf{Cat}](\mathbf{D}(F-, A), \mathbf{D}(F-, B))$$

is an equivalence.

- (iv) for every object A of \mathbf{D} , A is the $\mathbf{D}(F(-), A)$ -weighted colimit of F .

Proof. (i) \Rightarrow (ii):

Any representable $\mathbf{D}^{\text{op}} \rightarrow \mathbf{Cat}$ is continuous, so that the corresponding opposite pseudofunctor $\mathbf{D} \rightarrow \mathbf{Cat}^{\text{op}}$ is cocontinuous. As the Yoneda embedding is local equivalence, (i) implies that the composite

$$\mathbf{D} \xrightarrow{Y} [\mathbf{D}^{\text{op}}, \mathbf{Cat}] \xrightarrow{\hat{F}} [\mathbf{C}^{\text{op}}, \mathbf{Cat}]$$

is a local equivalence.

(iii) is just a rephrasing of (ii), so that (ii) and (iii) are equivalent. The same holds for (iv), as unwinding definitions we see that A being the $\mathbf{D}(F(-), A)$ -weighted colimit of F amounts to saying that there is an equivalence

$$\mathbf{D}(A, B) \simeq [\mathbf{C}^{\text{op}}, \mathbf{Cat}](\mathbf{D}(F-, A), \mathbf{D}(F-, B))$$

that is pseudonatural in B .

(iv) \Rightarrow (i): Let $G, H: \mathbf{D} \rightarrow \mathbf{E}$ be cocontinuous. Then G preserves the colimits of (iv), so that for any $A \in \mathbf{D}$ and $B \in \mathbf{E}$, we have equivalences

$$\mathbf{E}(GA, B) \simeq [\mathbf{C}^{\text{op}}, \mathbf{Cat}](\mathbf{D}(F-, A), \mathbf{E}(GF-, B))$$

pseudonatural in B . For a fixed A , setting $B = HA$ then gives an equivalence

$$\mathbf{E}(GA, HA) \simeq [\mathbf{C}^{\text{op}}, \mathbf{Cat}](\mathbf{D}(F-, A), \mathbf{E}(GF-, HA))$$

Now, a pseudonatural transformation $\tau: GF \rightarrow HF$ induces a pseudonatural transformation $\mathbf{D}(F-, A) \rightarrow \mathbf{E}(GF-, HA)$ that sends $f: FX \rightarrow A$ to $GF X \xrightarrow{\tau_X} HF X \xrightarrow{Hf} HA$, which hence corresponds to a map $\sigma_A: GA \rightarrow$

HA. The two-dimensional universal properties of A equips the family $(\sigma_A)_{A \in \mathbf{D}}$ with the structure of a pseudonatural transformation $\sigma: G \rightarrow F$ with the property that $\sigma F \cong \tau$. Thus restriction along F gives an essentially surjective functor $\text{hom}(G, H) \rightarrow \text{hom}(GF, HF)$. Using the two-dimensional universal properties one sees that it is fully faithful, as desired. \square

Definition 6.2. A pseudofunctor is called *dense* if it satisfies the equivalent conditions of Proposition 6.1.

The above notion might be more properly called bicategorical or 2-categorical density, as opposed to strict 2-categorical or **Cat**-enriched density as discussed in [14, Theorem 5.1]. Sometimes the notions coincide: for instance, the full subcategory on 1 is dense in **Cat** in both senses, while the full subcategory on 0 is not dense in either sense. We will discuss an example after Lemma 7.1 showing that **Cat**-enriched density does not imply bicategorical density. We also point out that, just as in the one-dimensional case, there is a weak version satisfying a similar result for isotropy. However, we refrain from formulating that since we will not need it for the present purposes.

We will now generalize Theorem 2.4 and show that dense pseudofunctors let one compute isotropy like in the one-dimensional case.

Corollary 6.3. *Let the \mathbf{C} be a 2-category with binary coproducts and $K: \mathbf{D} \rightarrow \mathbf{C}$ be a dense pseudofunctor. Then $\mathcal{Z}_{\mathbf{C}}$ is pseudonaturally equivalent to a pseudofunctor \mathcal{L}_K that sends $X \in \mathbf{C}$ to $\text{Aut}(L_X \circ K)$ and that on 1 and 2 -cells acts as in 5.5. If, moreover, K is small, then \mathbf{C} has essentially small isotropy, in the sense that $\mathcal{Z}_{\mathbf{C}}$ is pseudonaturally equivalent to a pseudofunctor taking values in the 2-category of small 2-groups.*

Proof. This follows from Corollary 5.5 and Proposition 6.1. \square

Using this, we can now compute various isotropy 2-groups of interest.

Theorem 6.4. *The isotropy 2-groups of groupoids vanish. More precisely, if \mathbf{Grpd} is the 2-category of groupoids, then $\mathcal{Z}: \mathbf{Grpd} \rightarrow \mathbf{2Grp}$ is pseudonaturally equivalent to the constant functor at the terminal 2-group.*

Proof. Let \mathbf{Grpd} be the 2-category of (small) groupoids, and let $\mathbf{1}$ be the terminal groupoid. Then the full subcategory on $\mathbf{1}$ is 2-categorically dense in \mathbf{Grpd} . For any groupoid \mathbf{G} , the only autoequivalence of $\mathbf{G} + \mathbf{1}$ that fixes \mathbf{G} (up to isomorphism) has to fix $\mathbf{1}$ exactly. Hence $\mathcal{L}_{\mathbf{1}}(G)$ and consequently $\mathcal{Z}(G)$ is equivalent to the trivial 2-group. \square

Note that this result really gives a pseudonatural equivalence and not an isomorphism. Indeed, given a groupoid G , one can obtain an element $\alpha: \mathcal{Z}(G)$ that is isomorphic but not equal to id by choosing for each $F: G \rightarrow H$ an autoequivalence $\alpha_f: H \rightarrow H$ and an isomorphism $\Gamma_f: \alpha_f \cong \text{id}_H$, as there is then a unique way of promoting α into an element of $\mathcal{Z}(G)$ so that Γ defines an invertible modification $\alpha \rightarrow \text{id}$. Thus $\mathcal{Z}(G)$ is a large 2-group that is equivalent to the trivial 2-group. Consequently, isotropy is trivial for groupoids whether one organizes them into a 1-category or into a 2-category. However, if one looks at groupoids and *cofunctors* between them, one gets a category with nontrivial isotropy, as shown in [8].

For the following application, we consider the 2-category $[\mathbf{C}^{\text{op}}, \mathbf{Cat}]$ of \mathbf{C} -indexed categories.

Theorem 6.5. *For a 2-category \mathbf{C} , the isotropy 2-functor of $[\mathbf{C}^{\text{op}}, \mathbf{Cat}]$ is pseudonaturally equivalent to the constant functor with value $\text{Aut}(\text{id}_{\mathbf{C}})$.*

Proof. The proof is similar to the one-dimensional case: the Yoneda embedding $y: \mathbf{C} \rightarrow [\mathbf{C}^{\text{op}}, \mathbf{Cat}]$ is dense so we can apply Theorem 6.3. For a pseudofunctor $F: \mathbf{C} \rightarrow \mathbf{Cat}$, an element of $\mathcal{L}_y(F)$ is then given by autoequivalences $F + yA \rightarrow F + yA$ that restrict to the identity on F and are pseudonatural in A . Consequently, they must map each yA to itself, and hence by bicategorical Yoneda Lemma we have $\mathcal{L}_y(F) \simeq \text{Aut}(\text{id}_{\mathbf{C}})$. \square

In particular, the isotropy of \mathbf{Cat} is trivial. Moreover, for \mathbf{C} is a 1-category and denoting by $\mathbf{Fib}(\mathbf{C})$ the 2-category of cloven fibrations over \mathbf{C} , the isotropy 2-functor $\mathcal{Z}: \mathbf{Fib}(\mathbf{C}) \rightarrow \mathbf{2Grp}$ is constant, and equivalent to the group $\text{Aut}(\text{id}_{\mathbf{C}})$ viewed as a locally discrete 2-group.

7. Monoidal categories

In this section we work out the motivating example of this paper, namely the Picard 2-group of a monoidal category. We begin by setting up some notation and recalling some basic constructions on and facts about monoidal categories. We let \mathbf{MonCat} denote the 2-category of strict monoidal categories, strong monoidal functors and monoidal natural transformations—the strictness on objects is purely a matter of technical convenience as allowing for general monoidal categories results in a biequivalent 2-category. The locally full subcategory on strict monoidal functors is denoted by \mathbf{MonCat}_s .

The forgetful functor $U: \mathbf{MonCat}_s \rightarrow \mathbf{Cat}$ has a left 2-adjoint $F: \mathbf{Cat} \rightarrow \mathbf{MonCat}_s$. For a given $\mathbf{C} \in \mathbf{Cat}$, the monoidal category $F\mathbf{C}$ can be described explicitly as follows: the objects and morphisms of $F\mathbf{C}$ are finite sequences of objects and morphisms of \mathbf{C} respectively, with the domain and codomain of a sequence morphisms given by the sequences of domains and codomains (so that $F\mathbf{C}$ only has morphisms between sequences of the same length). Composition and identities in $F\mathbf{C}$ are induced from those of \mathbf{C} and the monoidal product is given by concatenation of sequences. In particular, the free monoidal category $F\mathbf{n}$ for the discrete category \mathbf{n} on n objects results in a discrete monoidal category, whose monoid on objects is given by the free monoid on n generators. We will write A_1, \dots, A_n for the generators of $F\mathbf{n}$, and on occasion will also denote the generator of $F\mathbf{1}$ merely by A , and the generators of $F\mathbf{2}$ by A and B .

The universal property of $F\mathbf{n}$ states that a strict monoidal functor $F\mathbf{n} \rightarrow \mathbf{C}$ is uniquely specified by a list of n objects of \mathbf{C} —the images of the generators—and a monoidal natural transformation is uniquely determined by its components at the generators. We will routinely use this fact by denoting a morphism $F\mathbf{n} \rightarrow \mathbf{C}$ sending the generator A_i to $X_i \in \mathbf{C}$ by $F\mathbf{n} \xrightarrow{A_i \mapsto X_i} \mathbf{C}$ or simply by $F\mathbf{n} \xrightarrow{X_1, \dots, X_n} \mathbf{C}$.

In fact, $F\mathbf{n}$ (and $F\mathbf{C}$ more generally) enjoys also a universal property for *strong* monoidal functors out of $F\mathbf{n}$. More precisely, the inclusion

$$\mathbf{MonCat}_s(F\mathbf{C}, \mathbf{D}) \rightarrow \mathbf{MonCat}(F\mathbf{C}, \mathbf{D})$$

is an equivalence of categories.³

Now, basic results in two-dimensional monad theory [4] imply that \mathbf{MonCat}_s is cocomplete in the strict \mathbf{Cat} -enriched sense whereas \mathbf{MonCat} has all bicolimits. In particular, \mathbf{MonCat} has binary coproducts.

As we will only need coproducts of the form $\mathbf{C} + F\mathbf{n}$ in our later computations, we will only describe an explicit construction of the coproduct in this somewhat simpler case. The underlying monoid on objects of $\mathbf{C} + F\mathbf{n}$ is given by the coproduct of the corresponding monoids on \mathbf{C} and $F\mathbf{n}$. As (the set of objects of) $F\mathbf{n}$ is a free monoid, every object of $\mathbf{C} + F\mathbf{n}$ can hence be written as an alternating product $X_0 \otimes (\bigotimes_{i=1}^m A_{j_i} \otimes X_i)$, where $m \geq 0$, each X_i is an object of \mathbf{C} (possibly the tensor unit) and each A_{j_i} is some generator of $F\mathbf{n}$.

³This can be deduced by showing that free monoidal categories are flexible in the sense of [4, Remark 4.5].

Moreover, as $F\mathbf{n}$ is discrete and the underlying monoid is free, the number m of generators of $F\mathbf{n}$ occurring in an object of $\mathbf{C} + F\mathbf{n}$ is well-defined, and consequently morphisms of $\mathbf{C} + F\mathbf{n}$ are particularly simple to describe: there can be a morphism from $X_0 \otimes (\bigotimes_{i=1}^m A_{j_i} \otimes X_i)$ to $Y_0 \otimes (\bigotimes_{i=1}^k A_{l_i} \otimes Y_i)$ only if $m = k$ and $A_{j_i} = A_{l_i}$ for each $i = 1, \dots, m$, in which case any such morphism is necessarily of the form $f_0 \otimes (\bigotimes_{i=1}^m \text{id} \otimes f_i)$, with $f_i: X_i \rightarrow Y_i$ in \mathbf{C} . This is perhaps better explained via a string diagram: a generic morphism in $\mathbf{C} + F\mathbf{n}$ is of the form

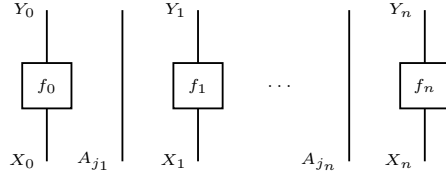

for $n \geq 0$. Moreover, two parallel such morphisms are equal in $\mathbf{C} + F\mathbf{n}$ if and only if their components in \mathbf{C} are equal, and this is true even if \mathbf{C} contains objects X for which $X \otimes (-)$ in \mathbf{C} fails to be faithful (like the zero object of \mathbf{Ab}).

We now identify a suitable dense sub-2-category of \mathbf{MonCat} .

Lemma 7.1. *The inclusion K of the full sub 2-category $\mathbf{F} = \mathbf{F}_{1,2,3}$ of \mathbf{MonCat} on the free monoidal categories on 1, 2 and 3 objects is dense in \mathbf{Moncat} .*

Proof. By Proposition 6.1, it suffices to verify for each $\mathbf{C}, \mathbf{D} \in \mathbf{MonCat}$, that the functor

$$\mathcal{F} : \mathbf{MonCat}(\mathbf{C}, \mathbf{D}) \rightarrow [\mathbf{F}, \mathbf{Cat}](\mathbf{MonCat}(K(-), \mathbf{C}), \mathbf{MonCat}(K(-), \mathbf{D}))$$

is an equivalence.

First of all, a monoidal functor $G: \mathbf{C} \rightarrow \mathbf{D}$ induces a pseudonatural (in fact, a 2-natural) transformation

$$G \circ -: \mathbf{MonCat}(K(-), \mathbf{C}) \rightarrow \mathbf{MonCat}(K(-), \mathbf{D}),$$

and a monoidal natural transformation $\sigma: G \rightarrow H$ induces a modification $\sigma \circ -: G \circ - \rightarrow H \circ -$. To see that the functor \mathcal{F} is faithful, assume $\sigma \neq \tau$, so that $\sigma_X \neq \tau_X$ for some object X of \mathbf{C} . Considering the unique strict monoidal functor $F\mathbf{1} \rightarrow \mathbf{C}$ that maps the generator to X we then see that $\sigma \circ - \neq \tau \circ -$. To see that \mathcal{F} is full, consider a modification $\Gamma: G \circ - \rightarrow H \circ -$. In particular, the component of Γ at $F\mathbf{1}$ gives a natural transformation

$$\begin{array}{ccc}
& G \circ - & \\
& \curvearrowright & \\
\mathbf{MonCat}(F\mathbf{1}, \mathbf{C}) & \Downarrow \Gamma_1 & \mathbf{MonCat}(F\mathbf{1}, \mathbf{D}) \\
& \curvearrowleft & \\
& H \circ - &
\end{array}$$

that corresponds to a natural transformation $G \rightarrow H$. By considering maps $F\mathbf{2} \rightarrow \mathbf{C}$, we can then verify that σ is a monoidal natural transformation so that $\Gamma = \sigma \circ -$.

It remains to show that \mathcal{F} is essentially full, so consider a pseudonatural transformation

$$V: \mathbf{MonCat}(K(-), \mathbf{C}) \rightarrow \mathbf{MonCat}(K(-), \mathbf{D}).$$

Using the universal property of $F\mathbf{1}$ we can use V to reconstruct a functor $G: \mathbf{C} \rightarrow \mathbf{D}$. More abstractly, we have equivalences $\mathbf{MonCat}(F\mathbf{1}, \mathbf{C}) \simeq \mathbf{MonCat}_s(F\mathbf{1}, \mathbf{C}) \cong \mathbf{Cat}(1, U\mathbf{C}) \cong U\mathbf{C}$, so that using these equivalences a functor $\mathbf{MonCat}(F\mathbf{1}, \mathbf{C}) \rightarrow \mathbf{MonCat}(F\mathbf{1}, \mathbf{D})$ gives rise to a functor $G: U\mathbf{C} \rightarrow U\mathbf{D}$. Using the universal property of $F\mathbf{2}$ we can endow this functor with the data of a strong monoidal functor. Finally, using the universal property of $F\mathbf{3}$ we can check the coherence conditions and verify that the resulting functor is indeed strong monoidal. It follows that $V \cong G \circ -$. \square

One would expect that the above result is deducible abstractly from the fact that the 2-monad giving rise to \mathbf{MonCat} has a specific finite presentation, much like for any algebraic theory that can be given by at most n -ary operations, the full subcategory on free models with $\leq n$ generators is dense. However, proving general results connecting presentations of 2-monads to dense subcategories of algebras would take us too far afield.

In passing, we note that we are now in a position to observe that \mathbf{Cat} -enriched density and bicategorical density are not equivalent. As any strong monoidal functor $F\mathbf{n} \rightarrow F\mathbf{m}$ is necessarily strictly monoidal, we may view \mathbf{F} both as a sub 2-category of \mathbf{MonCat} and of \mathbf{MonCat}_s . As a sub 2-category of \mathbf{MonCat}_s , one can show that \mathbf{F} is \mathbf{Cat} -dense. However, it is not dense in the bicategorical sense: due to flexibility of $F\mathbf{n}$, we have a pseudonatural equivalence $\mathbf{MonCat}(F\mathbf{m}, -) \simeq \mathbf{MonCat}_s(F\mathbf{m}, -)$, and consequently we

can see that pseudonatural transformations

$$\mathbf{MonCat}_s(K(-), \mathbf{C}) \rightarrow \mathbf{MonCat}_s(K(-), \mathbf{D})$$

(when the domain of the functors is \mathbf{F}) correspond to strong monoidal functors by the above Lemma, whereas 2-natural transformations correspond to strict monoidal functors by **Cat**-density. As the categories of strong and strict monoidal functors $\mathbf{C} \rightarrow \mathbf{D}$ are not in general equivalent, we see that \mathbf{F} is **Cat**-dense in \mathbf{MonCat}_s but not bicategorically dense.

We now turn to the main result of this section. Let

$$\text{Pic} : \mathbf{MonCat} \rightarrow \mathbf{2Grp}$$

be the 2-functor that sends a monoidal category \mathbf{C} to the 2-group on the weakly invertible elements of \mathbf{C} and isomorphisms between them, and a strong monoidal functor to its restriction on such elements. As the component of a monoidal natural transformation between strong monoidal functors at any dualizable object is invertible⁴ this functor is also well-defined on 2-cells.

Theorem 7.2. *The isotropy 2-group of monoidal categories is given by the Picard 2-group. More precisely, there is a pseudonatural equivalence $\mathcal{Z}(-) \simeq \text{Pic} : \mathbf{MonCat} \rightarrow \mathbf{2Grp}$.*

Before giving the proof, we establish a technical lemma concerning the pseudonaturality squares of objects of $\mathcal{L}_K(\mathbf{C})$. Let $K : \mathbf{F} \rightarrow \mathbf{MonCat}$ be the dense inclusion from Lemma 7.1, and let \mathbf{C} be a monoidal category. Consider an object α of $\mathcal{L}_K(\mathbf{C})$. Explicitly, α comprises three monoidal functors $\alpha_i : \mathbf{C} + F\mathbf{i} \rightarrow \mathbf{C} + F\mathbf{i}$, for each $H : F\mathbf{n} \rightarrow F\mathbf{m}$ an invertible 2-cell

$$\begin{array}{ccc} \mathbf{C} + F\mathbf{n} & \xrightarrow{\text{id} + H} & \mathbf{C} + F\mathbf{m} \\ \alpha_n \downarrow & \nearrow \alpha_H & \downarrow \alpha_m \\ \mathbf{C} + F\mathbf{n} & \xrightarrow{\text{id} + H} & \mathbf{C} + F\mathbf{m} \end{array}$$

⁴a generalization of this to Frobenius monoidal functors is given in [5, Proposition 7]

Lemma 7.3. *Let α be an object of $\mathcal{L}_X(\mathbf{C})$. Then α is completely determined by the functors α_i ($i=1, 2, 3$) and by the 2-cells α_H where H ranges over the functors*

$$\{F\mathbf{1} \xrightarrow{A \mapsto I} F\mathbf{1}\} \cup \{F\mathbf{1} \xrightarrow{A \mapsto A_i} F\mathbf{n} | n > 1\}.$$

In other words, if α' is another element of $\mathcal{L}_K(\mathbf{C})$ that coincides with α on its 1-cell components (so that $\alpha'_i = \alpha_i$) and on the pseudonaturality squares for the monoidal functors $\{F\mathbf{1} \xrightarrow{A \mapsto I} F\mathbf{1}\} \cup \{F\mathbf{1} \xrightarrow{A \mapsto A_i} F\mathbf{n} | n > 1\}$, then $\alpha' = \alpha$.

Proof. Throughout, we use the fact that to specify the 2-cell α_H for some $H : F\mathbf{n} \rightarrow F\mathbf{m}$, it suffices to specify, for each generator A_i of $F\mathbf{n}$, the component $\alpha_{H, A_i} : (1_{\mathbf{C}} + H)(\alpha_n(A_i)) \rightarrow \alpha_m(HA_i)$.

Consider first the map $F\mathbf{2} \xrightarrow{A_1 \mapsto A, A_2 \mapsto I} F\mathbf{1}$. As α is pseudonatural, we have the equations

$$\begin{array}{ccc} \mathbf{C} + F\mathbf{1} \xrightarrow{A \mapsto A_1} \mathbf{C} + F\mathbf{2} \xrightarrow{A, I} \mathbf{C} + F\mathbf{1} & \mathbf{C} + F\mathbf{1} \xrightarrow{\text{id}} \mathbf{C} + F\mathbf{1} \\ \alpha_1 \downarrow \nearrow \alpha^{A_1} & \downarrow \alpha_2 \nearrow \alpha^{A, I} & \downarrow \alpha_1 \\ \mathbf{C} + F\mathbf{1} \xrightarrow{A \mapsto A_1} \mathbf{C} + F\mathbf{2} \xrightarrow{A, I} \mathbf{C} + F\mathbf{1} & = & \mathbf{C} + F\mathbf{1} \xrightarrow{\text{id}} \mathbf{C} + F\mathbf{1} \end{array}$$

and

$$\begin{array}{ccc} \mathbf{C} + F\mathbf{1} \xrightarrow{A \mapsto A_2} \mathbf{C} + F\mathbf{2} \xrightarrow{A, I} \mathbf{C} + F\mathbf{1} & \mathbf{C} + F\mathbf{1} \xrightarrow{I} \mathbf{C} + F\mathbf{1} \\ \alpha_1 \downarrow \nearrow \alpha^{A_1} & \downarrow \alpha_2 \nearrow \alpha^{A, I} & \downarrow \alpha_1 \\ \mathbf{C} + F\mathbf{1} \xrightarrow{A \mapsto A_2} \mathbf{C} + F\mathbf{2} \xrightarrow{A, I} \mathbf{C} + F\mathbf{1} & = & \mathbf{C} + F\mathbf{1} \xrightarrow{I} \mathbf{C} + F\mathbf{1} \end{array}$$

so that the component of α at $F\mathbf{2} \xrightarrow{A_1 \mapsto A, A_2 \mapsto I} F\mathbf{1}$ is determined at the generators of $F\mathbf{2}$ by the above data, and hence determined altogether. The same holds for $F\mathbf{2} \xrightarrow{A_1 \mapsto I, A_2 \mapsto A} F\mathbf{1}$.

We now show that the same holds for $\alpha_{A \otimes B}$, i.e., the component of α at $F\mathbf{1} \xrightarrow{A \mapsto A_1 \otimes A_2} F\mathbf{2}$. This 2-cell is determined by its component at A which is a 1-cell $X \otimes A_1 \otimes A_2 \otimes X^{-1} \rightarrow X \otimes A_1 \otimes X^{-1} \otimes X \otimes A_2 \otimes X^{-1}$ in $\mathbf{C} + F\mathbf{2}$.

This 1-cell is by the construction of $\mathbf{C} + F\mathbf{2}$ of the form

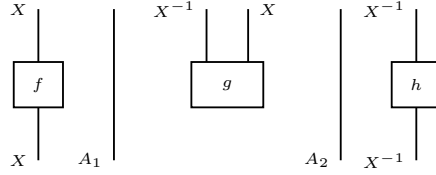

for some f, g, h .

Now, pseudonaturality of α implies the equations

$$\begin{array}{ccc}
 \mathbf{C} + F\mathbf{1} & \xrightarrow{A \otimes B} & \mathbf{C} + F\mathbf{2} & \xrightarrow{A, I} & \mathbf{C} + F\mathbf{1} & = & \mathbf{C} + F\mathbf{1} & \xrightarrow{\text{id}} & \mathbf{C} + F\mathbf{1} \\
 \alpha_1 \downarrow & \nearrow \alpha_{A \otimes B} & \downarrow \alpha_2 & \nearrow \alpha_{A, I} & \downarrow \alpha_1 & = & \alpha_1 \downarrow & = & \downarrow \alpha_1 \\
 \mathbf{C} + F\mathbf{1} & \xrightarrow{A \otimes I} & \mathbf{C} + F\mathbf{2} & \xrightarrow{A, I} & \mathbf{C} + F\mathbf{1} & = & \mathbf{C} + F\mathbf{1} & \xrightarrow{\text{id}} & \mathbf{C} + F\mathbf{1}
 \end{array}$$

and

$$\begin{array}{ccc}
 \mathbf{C} + F\mathbf{1} & \xrightarrow{A \otimes B} & \mathbf{C} + F\mathbf{2} & \xrightarrow{I, A} & \mathbf{C} + F\mathbf{1} & = & \mathbf{C} + F\mathbf{1} & \xrightarrow{\text{id}} & \mathbf{C} + F\mathbf{1} \\
 \alpha_1 \downarrow & \nearrow \alpha_{A \otimes B} & \downarrow \alpha_2 & \nearrow \alpha_{I, A} & \downarrow \alpha_1 & = & \alpha_1 \downarrow & = & \downarrow \alpha_1 \\
 \mathbf{C} + F\mathbf{1} & \xrightarrow{A \otimes I} & \mathbf{C} + F\mathbf{2} & \xrightarrow{I, A} & \mathbf{C} + F\mathbf{1} & = & \mathbf{C} + F\mathbf{1} & \xrightarrow{\text{id}} & \mathbf{C} + F\mathbf{1}
 \end{array}$$

As these natural transformations are monoidal, evaluating these equations at the generating object A of $F\mathbf{1}$ gives the equations

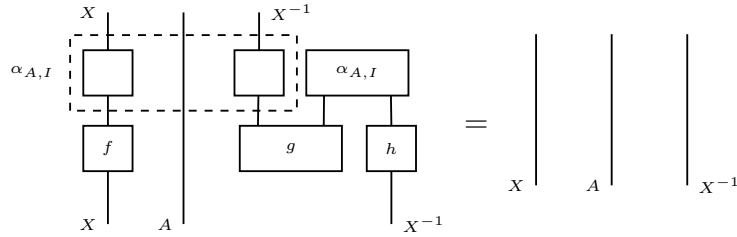

and

As $\alpha_{A,I}$ and $\alpha_{I,A}$ are invertible and have already been determined by the data at hand, these equations determine first f and h and consequently g , fixing $\alpha_{A \otimes B}$.

We now show that this is enough to determine the component of α at $F\mathbf{1} \xrightarrow{A \rightarrow W} F\mathbf{n}$ for any word W in the generators of $F\mathbf{n}$. If $W = I$, then this already follows from pseudonaturality of α at $F\mathbf{1} \xrightarrow{A \rightarrow I} F\mathbf{n} = F\mathbf{1} \xrightarrow{A \rightarrow I} F\mathbf{1} \xrightarrow{A \rightarrow A_i} F\mathbf{n}$. If W is a word of length 1, i.e., a generator, then for $n > 1$ it is fixed by assumption and for $n = 1$ by the fact that $\alpha_{\text{id}} = \text{id}$ by pseudonaturality. Now, if $W = W_1 \otimes W_2$ with components of α already determined at $A \mapsto W_1$ and at $A \mapsto W_2$, then the equality $F\mathbf{1} \xrightarrow{A \rightarrow A_i} F\mathbf{2} \xrightarrow{A_i \rightarrow W_i} F\mathbf{n} = F\mathbf{1} \xrightarrow{A \rightarrow W_i} F\mathbf{n}$ and pseudonaturality of α determine the component of α at $F\mathbf{2} \xrightarrow{A_i \rightarrow W_i} F\mathbf{n}$. Hence by induction the component of α is determined at $F\mathbf{1} \xrightarrow{A \rightarrow W} F\mathbf{n}$ for any word W in the generators of $F\mathbf{n}$, and hence at any map $F\mathbf{1} \xrightarrow{F} \mathbf{n}$. Consequently, for any map $F\mathbf{m} \rightarrow F\mathbf{n}$, the component of α at that map is determined for each generator of $F\mathbf{m}$, and hence altogether. Thus the pseudonaturality squares of α are uniquely determined by the 2-cells $\{\alpha_I\} \cup \{\alpha_{n,A_i} | n > 1\}$ corresponding to the monoidal functors $\{F\mathbf{1} \xrightarrow{A \rightarrow I} F\mathbf{1}\} \cup \{F\mathbf{1} \xrightarrow{A \rightarrow A_i} F\mathbf{n} | n > 1\}$ as desired. \square

With this result, we can now prove Theorem 7.2.

Proof of Theorem 7.2. Invoking Lemma 7.1 and Corollary 6.3, it is sufficient to show that $\text{Pic} \simeq \mathcal{L}_K$, where $K : \mathbf{F} \rightarrow \mathbf{MonCat}$. Since there is a 2-equivalence between 2-groups and coherent 2-groups [2] i.e., 2-groups where every object comes equipped with a chosen adjoint inverse, we might as well assume that this is the case both for each $\text{Pic}(\mathbf{C})$ and $\mathcal{L}_K(\mathbf{C})$. We now define a monoidal functor $\mathcal{G} = \mathcal{G}_{\mathbf{C}} : \text{Pic}(\mathbf{C}) \rightarrow \mathcal{L}_K(\mathbf{C})$ for each \mathbf{C} . Consider $X \in \text{Pic}(\mathbf{C})$ with inverse X^{-1} and isomorphisms

$$i : I \rightarrow X^{-1} \otimes X \quad \text{and} \quad e : X \otimes X^{-1} \rightarrow I$$

defined by identity on \mathbf{C} and by the diagram

$$\begin{array}{ccc}
 \begin{array}{c} Y \\ | \\ \boxed{f} \\ | \\ X \end{array} & \begin{array}{c} | \\ | \\ A_j \end{array} & \begin{array}{c} Y^{-1} \\ | \\ \boxed{f^{-1}} \\ | \\ X^{-1} \end{array}
 \end{array} \quad (7.4)$$

on the generator A_i of $F\mathbf{n}$. Hence \mathcal{G} defines a functor $\text{Pic}(\mathbf{C}) \rightarrow \mathcal{L}_K(\mathbf{C})$. It is straightforward to check that $\mathcal{G}(X \otimes Y) \cong \mathcal{G}(Y) \circ \mathcal{G}(X)$, so that \mathcal{G} is strong monoidal. It is also straightforward, albeit more tedious, to verify that the resulting functors $\text{Pic}(\mathbf{C}) \rightarrow \mathcal{L}_K(\mathbf{C})$ are pseudonatural in \mathbf{C} .

Hence it suffices to show that each functor $\mathcal{G}: \text{Pic}(\mathbf{C}) \rightarrow \mathcal{L}_K(\mathbf{C})$ is fully faithful and essentially surjective. By virtue of how \mathcal{G} acts on morphisms (7.4) and by the construction of $\mathbf{C} + F\mathbf{n}$, we see that the functor \mathcal{G} is faithful. To see that \mathcal{G} is full, consider a modification $\Gamma: \mathcal{G}(X) \rightarrow \mathcal{G}(Y)$. The component $\Gamma_1: \mathcal{G}(X)_1 \rightarrow \mathcal{G}(Y)_1$ at the generating object of $F\mathbf{1}$ has to be induced by maps $f: X \rightarrow Y$ and $g: X^{-1} \rightarrow Y^{-1}$. Now, as Γ is a modification we have the equation

$$\begin{array}{ccc}
 \mathbf{C} + F\mathbf{1} & \xrightarrow{I} & \mathbf{C} + F\mathbf{1} \\
 \mathcal{G}(X) \downarrow & \nearrow \mathcal{G}(X)_1 & \searrow \Gamma_1 \\
 \mathbf{C} + F\mathbf{1} & \xrightarrow{I} & \mathbf{C} + F\mathbf{1}
 \end{array}
 =
 \begin{array}{ccc}
 \mathbf{C} + F\mathbf{1} & \xrightarrow{I} & \mathbf{C} + F\mathbf{1} \\
 \mathcal{G}(X) \left(\Gamma_1 \right) \searrow & & \nearrow \mathcal{G}(Y)_1 \\
 \mathbf{C} + F\mathbf{1} & \xrightarrow{I} & \mathbf{C} + F\mathbf{1}
 \end{array}
 \begin{array}{c} \downarrow \mathcal{G}(Y) \\ \downarrow \mathcal{G}(Y) \end{array}$$

which for the generating object of $F\mathbf{1}$ amounts to

$$\begin{array}{ccc}
 \begin{array}{c} \boxed{f} \\ | \\ X \end{array} & \begin{array}{c} \boxed{g} \\ | \\ X^{-1} \end{array} & = & \begin{array}{c} \boxed{f^{-1}} \\ | \\ X^{-1} \end{array}
 \end{array}$$

so that g must satisfy

$$\begin{array}{ccc}
 \begin{array}{c} Y^{-1} \\ | \\ \boxed{g} \\ | \\ X^{-1} \end{array} & = & \begin{array}{c} Y^{-1} \\ | \\ \boxed{f^{-1}} \\ | \\ X^{-1} \end{array}
 \end{array}$$

and hence $\Gamma_1 = \mathcal{G}(f)_1$. Moreover, Γ_n for $n > 1$ is uniquely determined by its action on the generators of $F\mathbf{n}$, whence it is uniquely determined by whiskering it with the maps $\mathbf{C} + F\mathbf{1} \mapsto \mathbf{C} + F\mathbf{n}$ sending the generator of A_i to these generators, so that Γ_n is in fact determined by Γ_1 . As $\Gamma_1 = \mathcal{G}(f)_1$ by construction, we have $\Gamma = \mathcal{G}(f)$ as desired.

We next show that \mathcal{G} is essentially surjective, so let $\alpha \in \mathcal{L}_K(\mathbf{C})$. Now, α_1 is determined within monoidal isomorphism by $\alpha(A)$, which by construction of $\mathbf{C} + F\mathbf{1}$ is given by a word in $w(A)$ in the objects of \mathbf{C} and A . Because α is pseudonatural, for each object Y of $F\mathbf{2}$, the square

$$\begin{array}{ccc} \mathbf{C} + F\mathbf{1} & \xrightarrow{\mathbf{C} + Y} & \mathbf{C} + F\mathbf{2} \\ \alpha_1 \downarrow & & \downarrow \alpha_2 \\ \mathbf{C} + F\mathbf{1} & \xrightarrow{\mathbf{C} + Y} & \mathbf{C} + F\mathbf{2} \end{array}$$

must commute up to natural isomorphism. This means that α_2 acts, up to isomorphism, by $w(-)$ i.e., by replacing instances of A in the word $w(A)$ with the corresponding object of $F\mathbf{n}$. The same reasoning applies to α_3 . Hence we assume (replacing α_n by a monoidally isomorphic functor if necessary) that α_n is exactly given by $w(-)$ on $F\mathbf{n}$. As α_1 is an equivalence, this word has to contain A at least once. As α_2 is strong monoidal, we must have $w(A) \otimes w(B) \cong w(A \otimes B)$. Now, each instance of A is to the left of each instance of B in the word $w(A) \otimes w(B)$, and hence this has to hold true of $w(A \otimes B)$. Hence $w(A)$ has to contain A exactly once, so that $w(A) = X \otimes A \otimes Y$ for some $X, Y \in \mathbf{C}$. The strong monoidal structure of α_2 then induces an isomorphism $Y \otimes X \rightarrow I$ and an isomorphism $X \otimes Y \rightarrow I$, so we have $Y \cong X^{-1}$. We may hence assume that α_n is equal to the strict monoidal functor $\mathcal{G}(X)_n$.

However, we are not yet finished as the pseudonaturality squares of α may differ from those of $\mathcal{G}(X)$. We will produce an invertible modification $\Gamma: \alpha \rightarrow \mathcal{G}(X)$ using the following strategy. First of all, any invertible Γ_1, Γ_2 and Γ_3 will induce a modification $\Gamma: \alpha \rightarrow \beta$ for a unique pseudonatural β . We will proceed by finding some $\Gamma_1, \Gamma_2, \Gamma_3$ for which we can conclude that $\beta = \mathcal{G}(X)$ using Lemma 7.3. This means that it suffices to find $\Gamma_1, \Gamma_2, \Gamma_3$ so that the resulting β agrees with $\mathcal{G}(X)$ on the pseudonaturality 2-cells required by Lemma 7.3, and conversely, we can use desired equations in order to find Γ .

Our first step is to find an isomorphism $\Gamma_1: \alpha_1 = \mathcal{G}(X)_1 \rightarrow \mathcal{G}(X)_1$ satisfying the pasting diagram

$$\begin{array}{ccc}
 \mathbf{C} + F\mathbf{1} \xrightarrow{I} \mathbf{C} + F\mathbf{1} & & \mathbf{C} + F\mathbf{1} \xrightarrow{I} \mathbf{C} + F\mathbf{1} \\
 \mathcal{G}(X) \downarrow \nearrow \alpha_1 & \mathcal{G}(X) \left(\begin{array}{c} \xrightarrow{\Gamma_1} \\ \xrightarrow{\Gamma_1} \end{array} \right) \mathcal{G}(X) & = & \mathcal{G}(X) \left(\begin{array}{c} \xrightarrow{\Gamma_1} \\ \xrightarrow{\Gamma_1} \end{array} \right) \mathcal{G}(X) \nearrow \mathcal{G}(X)_1 & \downarrow \mathcal{G}(X) \\
 \mathbf{C} + F\mathbf{1} \xrightarrow{I} \mathbf{C} + F\mathbf{1} & & \mathbf{C} + F\mathbf{1} \xrightarrow{I} \mathbf{C} + F\mathbf{1}
 \end{array}$$

This is to ensure that the resulting pseudonatural transformation agrees with $\mathcal{G}(X)$ for $F\mathbf{1} \xrightarrow{A \rightarrow I} F\mathbf{1}$.

Now, any automorphism of $\mathcal{G}(X)_1$ is induced by an automorphism of $X \otimes A \otimes X^{-1}$ which necessarily is of the form $f \otimes \text{id}_A \otimes g$. Moreover, as Γ_1 is a monoidal natural transformation, its component at I is given by the identity. Thus finding such a Γ_1 amounts to finding invertible f, g such that

$$\begin{array}{c} \text{---} \\ \text{---} \end{array} \begin{array}{c} \boxed{f} \quad \boxed{g} \\ \text{---} \end{array} \begin{array}{c} \text{---} \\ \text{---} \end{array} = \begin{array}{c} \boxed{\alpha_I} \\ \text{---} \end{array} \begin{array}{c} \text{---} \\ \text{---} \end{array}$$

$x \quad \quad \quad x^{-1} \qquad \qquad \qquad x \quad \quad \quad x^{-1}$

As

$$\begin{array}{c} \text{---} \\ \text{---} \end{array} \begin{array}{c} \boxed{\alpha_I} \\ \text{---} \end{array} \begin{array}{c} \text{---} \\ \text{---} \end{array} = \begin{array}{c} \boxed{\alpha_I} \\ \text{---} \end{array} \begin{array}{c} \text{---} \\ \text{---} \end{array}$$

$x \quad \quad \quad x^{-1} \qquad \qquad \qquad x \quad \quad \quad x^{-1}$

this can be solved by setting $f = \text{id}_X$ and defining g via

$$\begin{array}{c} \text{---} \\ \text{---} \end{array} \begin{array}{c} \boxed{\alpha_I} \\ \text{---} \end{array} \begin{array}{c} \text{---} \\ \text{---} \end{array}$$

$x^{-1} \quad \quad \quad x^{-1}$

Now that we've defined Γ_1 , consider the desired pasting equalities

$$\begin{array}{ccc}
\mathbf{C} + F\mathbf{1} & \xrightarrow{A_i} & \mathbf{C} + F\mathbf{n} \\
\mathcal{G}(X) \downarrow & \nearrow \alpha^{A_i} & \mathcal{G}(X) \left(\begin{array}{c} \Gamma_1 \\ \Rightarrow \end{array} \right) \mathcal{G}(X) \\
\mathbf{C} + F\mathbf{1} & \xrightarrow{A_I} & \mathbf{C} + F\mathbf{n}
\end{array} = \begin{array}{ccc}
\mathbf{C} + F\mathbf{1} & \xrightarrow{A_i} & \mathbf{C} + F\mathbf{n} \\
\mathcal{G}(X) \left(\begin{array}{c} \Gamma_1 \\ \Rightarrow \end{array} \right) \mathcal{G}(X) & \nearrow \mathcal{G}(X) & \mathcal{G}(X) \downarrow \\
\mathbf{C} + F\mathbf{1} & \xrightarrow{A_i} & \mathbf{C} + F\mathbf{n}
\end{array}$$

for maps $F\mathbf{1} \xrightarrow{A \rightarrow A_i} F\mathbf{n}$ for generators A_i of $F\mathbf{n}$ with $n > 1$. As α is invertible, these determine the components of Γ_2, Γ_3 uniquely at the generators, and hence fix unique monoidal natural transformations Γ_2, Γ_3 satisfying these equations.

It remains to show that $(\Gamma_i)_{i=1}^3$ defines a modification $\Gamma: \alpha \rightarrow \mathcal{G}(X)$, i.e., that the desired equations are satisfied for all maps $F\mathbf{m} \rightarrow F\mathbf{n}$. However, this follows from our earlier observation: given $(\Gamma_i)_{i=1}^3$, there is a unique pseudonatural transformation β such that $(\Gamma_i)_{i=1}^3$ defines a modification $\Gamma\alpha \rightarrow \beta$. By construction, β agrees with $\mathcal{G}(X)$ at its 1-cell components and at the 2-cell components corresponding to the monoidal functors $\{F\mathbf{1} \xrightarrow{A \rightarrow I} F\mathbf{1}\} \cup \{F\mathbf{1} \xrightarrow{A \rightarrow A_i} F\mathbf{n} | n > 1\}$, so that we must have $\beta = \mathcal{G}(X)$ by Lemma 7.3. Thus \mathcal{G} is essentially surjective as desired. \square

8. Monoidal fibrations

In this final section we combine two of the earlier results by characterizing the 2-isotropy of the 2-category of pseudofunctors $[\mathbf{C}^{\text{op}}, \mathbf{MonCat}]$, pseudonatural transformations and modifications. When \mathbf{C} is locally discrete, this 2-category is equivalent to the category of *monoidal fibrations* over \mathbf{C} in the sense of [18]. One might expect that the result is deducible directly from Theorems 6.5 and 7.2 given the similar but more general results proven in the one-dimensional case in [19]. However, as a full understanding of isotropy (both in one and two dimensions) in functor categories is outside the scope of this paper, we will proceed by a direct proof, highlighting the interesting components while merely sketching the repetitive parts of the arguments.

We begin by identifying a suitable dense sub-2-category of $[\mathbf{C}^{\text{op}}, \mathbf{MonCat}]$. Note that we have a diagram

$$\mathbf{C} \xrightarrow{Y} [\mathbf{C}^{\text{op}}, \mathbf{Cat}] \xrightarrow{F \circ -} [\mathbf{C}^{\text{op}}, \mathbf{MonCat}]$$

where Y is the Yoneda embedding and $F : \mathbf{Cat} \rightarrow \mathbf{MonCat}$ is the free monoidal category functor as before. We will write \overline{A} for the image of an object A of \mathbf{C} under this composite functor. Thus $\overline{A} : \mathbf{C}^{\text{op}} \rightarrow \mathbf{MonCat}$ acts on objects by $\overline{A}(C) = F(\mathbf{C}(C, a))$, the free monoidal category on the hom-category $\mathbf{C}(C, A)$.

Lemma 8.1. *The full sub 2-category \mathbf{D} of $[\mathbf{C}^{\text{op}}, \mathbf{MonCat}]$ spanned by the objects $\{\overline{A}, \overline{A} + \overline{A}, \overline{A} + \overline{A} + \overline{A} \mid A \in \mathbf{C}\}$ is dense.*

Proof. The proof proceeds along the lines of Lemma 7.1—indeed, when \mathbf{C} is the terminal category, we obtain Lemma 7.1 as a special case. Let us denote the inclusion $\mathbf{D} \hookrightarrow [\mathbf{C}^{\text{op}}, \mathbf{MonCat}]$ by \mathcal{F} . Fixing pseudofunctors $G, H : \mathbf{C} \rightarrow \mathbf{D}$, it suffices to show that the functor

$$[\mathbf{C}^{\text{op}}, \mathbf{MonCat}](G, H) \rightarrow [\mathbf{D}^{\text{op}}, \mathbf{Cat}]([\mathbf{C}^{\text{op}}, \mathbf{MonCat}](\mathcal{F}-, G), [\mathbf{C}^{\text{op}}, \mathbf{MonCat}](\mathcal{F}-, H))$$

is an equivalence. To see that it is faithful, consider two distinct modifications Γ, Γ' between pseudonatural transformations $G \rightarrow H$. As $\Gamma \neq \Gamma'$, we must have $\Gamma_A \neq \Gamma'_A$ for some $A \in \mathbf{C}$. Consequently, the components of the induced modifications differ at \overline{A} , showing faithfulness. To see that this functor is full, consider a modification Γ between the pseudonatural transformations induced by $\sigma, \tau : G \rightarrow H$. Now, the universal property of each \overline{A} lets us recover a natural transformation $\Gamma'_A : \sigma_A \rightarrow \tau_A$ for each A , and the universal property of $\overline{A} + \overline{A}$ lets us verify that these natural transformations are monoidal. Consequently, Γ' defines a modification $\sigma \rightarrow \tau$ and maps to Γ , showing fullness.

To see that the functor is essentially full, consider a pseudonatural transformation

$$\sigma : [\mathbf{C}^{\text{op}}, \mathbf{MonCat}](\mathcal{F}-, G) \rightarrow [\mathbf{C}^{\text{op}}, \mathbf{MonCat}](\mathcal{F}-, H)$$

in $[\mathbf{D}^{\text{op}}, \mathbf{Cat}]$. Now, we have a pseudonatural equivalence

$$[\mathbf{C}^{\text{op}}, \mathbf{Cat}](y-, UG) \simeq [\mathbf{C}^{\text{op}}, \mathbf{MonCat}]((F \circ -)y-, G)$$

so that restricting to objects of the form \overline{A} , we obtain a pseudonatural transformation $[\mathbf{C}^{\text{op}}, \mathbf{Cat}](y-, UG) \rightarrow [\mathbf{C}^{\text{op}}, \mathbf{Cat}](y-, UH)$ which by Yoneda corresponds to a pseudonatural transformation $UG \rightarrow UH$. Hence it suffices to show that the components of this pseudonatural transformation live

in **MonCat**. Considering objects of the form $\overline{A} + \overline{A}$ lets us endow the 1-cell components with the data of a strong monoidal functor, and considering objects of the form $\overline{A} + \overline{A} + \overline{A}$ lets us check that these are in fact strong monoidal. Considering objects of the form $\overline{A} + \overline{A}$ again lets us then verify that the 2-cell components are monoidal natural transformations. Taken together, this lets us find a pseudonatural transformation $G \rightarrow H$ that induces σ within isomorphism. \square

The description of the isotropy 2-group of a monoidal fibration uses the notion of a (conical) pseudolimit of a pseudofunctor $H: \mathbf{C}^{\text{op}} \rightarrow \mathbf{2Grp}$. This notion is defined in the general case in [12, Section 5.1] and in [15]. Such pseudolimits are inherited from **MonCat**, and may be explicitly described as follows.

Objects of $\lim H$ consist of families $X = (X_A \in H(A))_{A \in \mathbf{C}}$ together with isomorphisms $x_f: X_A \rightarrow H(f)X_B$ for $f: A \rightarrow B$ in \mathbf{C} ; these are subject to the unit and cocycle conditions $x_1 = 1$ and $x_{gf} = H(f)(x_g) \circ x_f$.

Morphisms $m: (X, x) \rightarrow (Y, y)$ are families of morphisms $(m_A: X_A \rightarrow Y_A)_{A \in \mathbf{C}}$ such that for all $f: A \rightarrow B$ we have $H(m_B) \circ x_f = y_f \circ m_A$.

Tensor The monoidal structure and inverses of objects and of morphisms of $\lim H$ are computed pointwise, resulting in a 2-group.

We can now state the main result of this section:

Theorem 8.2. *For a small 2-category \mathbf{C} , the isotropy 2-functor*

$$\mathcal{Z}_{[\mathbf{C}^{\text{op}}, \mathbf{MonCat}]}: [\mathbf{C}^{\text{op}}, \mathbf{MonCat}] \rightarrow \mathbf{2Grp}$$

is pseudonaturally equivalent to the functor sending $H: \mathbf{C}^{\text{op}} \rightarrow \mathbf{MonCat}$ to $\text{Aut}(\text{id}_{\mathbf{C}}) \times \lim(\text{Pic} \circ H)$.

Proof. As the the argument resembles the proof of Theorem 7.2, we will restrict ourselves to a sketch. The category $[\mathbf{C}^{\text{op}}, \mathbf{MonCat}]$ inherits binary coproducts from **MonCat**, so we may compute the isotropy 2-group using Corollary 6.3 and the dense subcategory $\mathcal{F}: \mathbf{D} \rightarrow [\mathbf{C}^{\text{op}}, \mathbf{MonCat}]$ provided by Lemma 8.1. Thus it suffices to provide equivalences

$$\text{Aut}(\text{id}_{\mathbf{C}}) \times \lim(\text{Pic} \circ H) \rightarrow \mathcal{L}_{\mathcal{F}}(H)$$

that are pseudonatural in H .

Given an element $(\sigma, (X, x))$ of $\text{Aut}(\text{id}_C) \times \lim(\text{Pic} \circ H)$, we define the corresponding element

$$(\mathcal{L}_{\mathcal{F}}(H))_{\bar{A}}: H + \bar{A} \rightarrow H + \bar{A}$$

of $\mathcal{L}_{\mathcal{F}}(H)$ at the object \bar{A} as follows: given an object C of \mathbf{C} ,

$$(\mathcal{L}_{\mathcal{F}}(H))_{\bar{A}, C}: HC + \bar{A}C \rightarrow HC + \bar{A}C$$

is the identity on HC , and on $\bar{A}C$ sends a generator $l \in \mathbf{C}(C, A)$ to

$$l \mapsto X_A \otimes (\sigma_A \circ l) \otimes X_A^{-1}.$$

The action of $\mathcal{L}_{\mathcal{F}}(H)$ at $\bar{A} + \bar{A}$ and $\bar{A} + \bar{A} + \bar{A}$ is defined similarly. Then the requisite pseudonaturality 2-cells are induced by those of σ and by the cups and caps as in the proof of Theorem 7.2. It is straightforward to check that this assignment on objects can be extended to a (\otimes -reversing) monoidal functor that is fully faithful, and that this family of functors is pseudonatural in H .

To see that each of these functors is essentially surjective on objects, consider an arbitrary pseudonatural autoequivalence of

$$\mathbf{D} \xrightarrow{\mathcal{F}} [\mathbf{C}^{\text{op}}, \mathbf{MonCat}] \rightarrow H/[\mathbf{C}^{\text{op}}, \mathbf{MonCat}].$$

The 1-cells of such an autoequivalence consist of autoequivalences of $H + \bar{A}$, $H + \bar{A} + \bar{A}$ and of $H + \bar{A} + \bar{A} + \bar{A}$ for each $A \in \mathbf{C}$ that fix H (within isomorphism). By the universal property of $\bar{A}(A) = F(\mathbf{C}(A, A))$ and by Yoneda such autoequivalences correspond to elements of $H(A) + F\mathbf{C}(A, A)$, which in turn correspond to words in $H(A)$ and $\mathbf{C}(A, A)$. As in the proof of Theorem 7.2, the pseudonaturality constraints imply that these words have to be (up to isomorphism) of the form $X_A \otimes \hat{f} \otimes X_A^{-1}$, with $\hat{f} \in F\mathbf{C}(A, A)$. For this to result in an equivalence, we must have $\hat{f} = f \in \mathbf{C}(A, A)$ for some equivalence f . Now, pseudonaturality in $A \in \mathbf{C}$ implies that the family X_A is in $\lim \text{Pic} \circ H$, and that the family $f: A \rightarrow A$ defines an autoequivalence of $\text{id}_{\mathbf{C}}$. Thus we have demonstrated that any element of $\mathcal{L}_{\mathcal{F}}(H)$ is isomorphic to one whose 1-cell components are exactly as determined by an element of $\text{Aut}(\text{id}_C) \times \lim(\text{Pic} \circ H)$. It remains to show that given such an element of $\mathcal{L}_{\mathcal{F}}(H)$, it is isomorphic to one whose 2-cells are exactly as determined by

an element of $\text{Aut}(\text{id}_C) \times \lim(\text{Pic} \circ H)$. This can be done by generalizing the similar argument in the proof of Theorem 7.2 to show that, up to invertible modification, the 2-cell components in H are exactly as desired, as the 2-cell components in the other summand are as desired by Yoneda. \square

This result can be seen as a first step towards a two-dimensional generalization of [19], where, under suitable conditions, one shows that there is a natural isomorphism between $\mathcal{Z}_{[\mathbf{C}, T\text{-Alg}]}(H)$ and $\text{Aut}(\text{id}_C) \times \lim \mathcal{Z}_{T\text{-Alg}} \circ H$.

Bibliography

- [1] Jiří Adámek and Jiří Rosický. *Locally presentable and accessible categories*, volume 189 of *London Mathematical Society Lecture Note Series*. Cambridge University Press, Cambridge, 1994. doi:10.1017/cbo9780511600579.
- [2] John C Baez and Aaron D Lauda. Higher-Dimensional Algebra V: 2-groups. *Theory and Applications of Categories*, 12(14):423–491, 2004.
- [3] George M Bergman. An inner automorphism is only an inner automorphism, but an inner endomorphism can be something strange. *Publicacions Matemàtiques*, 56(1):91–126, 2012. doi:10.5565/publmat_56112_04.
- [4] Robert Blackwell, Gregory M Kelly, and A John Power. Two-dimensional monad theory. *Journal of Pure and Applied Algebra*, 59(1):1–41, 1989. doi:10.1016/0022-4049(89)90160-6.
- [5] Brian Day and Craig Pastro. Note on Frobenius monoidal functors. *New York Journal of Mathematics*, 14:733–742, 2008.
- [6] Peter Freyd. Algebra valued functors in general and tensor products in particular. In *Colloquium Mathematicum*, volume 14, pages 89–106. Institute of Mathematics, Polish Academy of Sciences, 1966. doi:10.4064/cm-14-1-89-106.
- [7] Jonathon Funk, Pieter Hofstra, and Benjamin Steinberg. Isotropy and Crossed Toposes. *Theory and Applications of Categories*, 26(24):660–709, 2012.

- [8] Richard Garner. Inner automorphisms of groupoids, 2019. [arXiv:1907.10378](#).
- [9] John W. Gray. *Formal Category Theory: Adjointness for 2-Categories*. Springer Berlin Heidelberg, 1974. doi:10.1007/bfb0061280.
- [10] Pieter Hofstra, Jason Parker, and Philip Scott. Isotropy of Algebraic Theories. *Electronic Notes in Theoretical Computer Science*, 341:201–217, December 2018. doi:10.1016/j.entcs.2018.11.010.
- [11] Pieter Hofstra, Jason Parker, and Philip J. Scott. Polymorphic Automorphisms and the Picard group. In *6th International Conference on Formal Structures for Computation and Deduction (FSCD 2021)*, volume 195 of *Leibniz International Proceedings in Informatics (LIPIcs)*, pages 26:1–26:17, Dagstuhl, Germany, 2021. Schloss Dagstuhl – Leibniz-Zentrum für Informatik. doi:10.4230/LIPIcs.FSCD.2021.26.
- [12] Niles Johnson and Donald Yau. *2-Dimensional Categories*. Oxford University Press, 2021. doi:10.1093/oso/9780198871378.001.0001.
- [13] G. M. Kelly. *Basic concepts of enriched category theory*, volume 64. Cambridge University Press, 1982. Reprinted in [14].
- [14] G. M. Kelly. Basic concepts of enriched category theory. *Reprints in Theory and Applications of Categories*, (10):1–136, 2005.
- [15] Gregory Maxwell Kelly. Elementary observations on 2-categorical limits. *Bulletin of the Australian Mathematical Society*, 39(2):301–317, 1989. doi:10.1017/s0004972700002781.
- [16] Stephen Lack. Icons. *Applied Categorical Structures*, 18(3):289–307, April 2008. doi:10.1007/s10485-008-9136-5.
- [17] Daniel Marsden. *Category Theory Using String Diagrams*, 2014. [arXiv:1401.7220](#).
- [18] Joe Moeller and Christina Vasilakopoulou. Monoidal Grothendieck construction. *Theory and Applications of Categories*, 35(31):1159–1207, 2020.
- [19] Jason Parker. Inner automorphisms of presheaves of groups, 2021. [arXiv:2107.13989](#).

- [20] Jason Parker. Covariant Isotropy of Grothendieck Toposes. *Applied Categorical Structures*, 2022. doi:<https://doi.org/10.1007/s10485-022-09674-0>.
- [21] P. Selinger. A Survey of Graphical Languages for Monoidal Categories. In *New Structures for Physics*, pages 289–356, 2010. doi:[10.1007/978-3-642-12821-9_4](https://doi.org/10.1007/978-3-642-12821-9_4).
- [22] D. Verity. *Enriched categories, internal categories and change of base*. PhD thesis, University of Cambridge, 1992. Reprinted in [23].
- [23] D. Verity. Enriched categories, internal categories and change of base. *Reprints in Theory and Applications of Categories*, (20):1–266, 2011.