

Cyber Risk Assessment for Capital Management

Wing Fung Chong[†], Runhuan Feng^{*}, Hins Hu[‡], and Linfeng Zhang^{**}

[†]*Department of Actuarial Mathematics and Statistics, Heriot-Watt University. Email: alfred.chong@hw.ac.uk.*

^{*}*Department of Mathematics, University of Illinois at Urbana-Champaign. Email: {rfeng, lzhang18}@illinois.edu.*

[‡]*Systems Engineering, Cornell University. Email: zh223@cornell.edu.*

Abstract

Cyber risk is an omnipresent risk in the increasingly digitized world that is known to be difficult to quantify and assess. Despite the fact that cyber risk shows distinct characteristics from conventional risks, most existing models for cyber risk in the insurance literature have been purely based on frequency-severity analysis, which was developed for classical property and casualty risks. In contrast, the cybersecurity engineering literature employs different approaches, under which cyber incidents are viewed as threats or hacker attacks acting on a particular set of vulnerabilities. There appears a gap in cyber risk modeling between engineering and insurance literature. This paper presents a novel model to capture this unique dynamics of cyber risk known from engineering and to model loss distributions based on industry loss data and a particular company's cybersecurity profile. The analysis leads to a new tool for allocating resources of the company between cybersecurity investments and loss-absorbing reserves.

Keywords: cyber risk assessment, information systems, cybersecurity investments, capital allocation, IT policy and management, economics of IS.

1 Introduction

As modern businesses and public-sector entities have become greatly reliant on information technology (IT) to boost the efficiency of workflows and stay connected with the world, potential cyber incidents, such as data breaches, are imposing great dangers on organizations' daily operations. To effectively manage cyber risk, cyber risk assessment is a complex but essential task for IT departments before any measures are effectively implemented. However, as an emerging type of risk, cyber risk is more difficult to assess than many other traditional risks for reasons including the following.

*Corresponding author

- *Lack of quantitative tools for comprehensive cyber risk assessment.* Although there are lots of efforts in quantifying some aspects of cyber risk, such as the impact of data breaches (see, for example, Xu et al. (2018) and Eling and Wirfs (2019)), it should be recognized that cyber systems consist of numerous types of physical and virtual components, and they may have drastically different risk exposures. In order to guide business decisions on cyber risk management, a comprehensive and quantitative assessment of the risk that integrates all those components is crucial, but the tool for such a purpose is lacking in the literature or on the market.
- *Adaptive nature of cyber risk.* As summarized in Pfleeger and Cunningham (2010) and DiMase et al. (2015), cyber risk is dynamic in the sense that in cyberspace, adversaries are consistently developing new strategies and attacks to overcome or bypass existing defense mechanisms. In other words, even a well-protected system by today's cybersecurity technology may still be vulnerable again in a future time. Therefore, an ideal framework for cyber risk assessment has to take both internal factors, such as security measures, and external factors, such as trending attacking techniques, into account. The latter component is usually missing in many existing risk assessment approaches.
- *Correlated losses.* It is well-known that because of the connectedness of the cyberspace, cyber risks are correlated. Böhme and Kataria (2006) discussed two modes of correlation, namely intra-firm risk correlation and global risk correlation. From the perspective of a decision maker, who manages the cyber risk of a particular company, the intra-firm correlation is more of a concern. That is, a single cyber incident may result in multiple points of failure, each of which can lead to a loss; see, for example, Alderson et al. (2014). Such a dependence among losses can be obscure and easily overlooked by risk managers.

Developing innovative risk assessment methods with those difficulties being addressed is of interest to researchers in both the engineering community and the economics and finance community. As the impact of cyber risk is profound in the modern society, there have been vastly different approaches for cyber risk assessment, developed in the engineering community and the economics literature respectively.

Engineering literature

In the engineering literature, researchers oftentimes focus on the structural properties of cyber systems and study the risks at a microscopic level. For example, Wang and Lu (2013) discussed security issues associated with smart grids with extensive insights into the vulnerabilities in individual components of the network, such as different types of denial-of-service attacks that might be performed on various components of the communication layer, and then proposed countermeasures to potential threats. Those insights are helpful for smart grid operators to identify risks and build a list of action items for risk mitigation. For the identification and reduction of cyber risks in other

settings, there are studies that take similar approaches, such as Frustaci et al. (2018) and Parkinson et al. (2017), which concern the Internet of Things and autonomous vehicles, respectively. Based on the same methodology but for more generalized use cases in industrial environments, regulators and leaders of the cybersecurity industry have developed a handful of guidelines and frameworks. For example, the National Institute of Standards and Technology (NIST) has developed a generic set of controls called the Cybersecurity Framework (CSF) (see NIST (2018)), which can be used as a voluntary guidance for organizations to manage their cyber risk. Largely derived from that framework, the Critical Infrastructure Protection (CIP) Standards is developed and enforced by the North American Electric Reliability Corporation (NERC) in the utility industry (see NERC (2008)). Similarly, as a cybersecurity industry leader, the Center for Internet Security (CIS) has compiled a detailed list of commonly known vulnerable components in cyber systems and best practices in risk mitigation into CIS Controls (see CIS (2021)).

In terms of their practicality, one potential shortcoming of these is the lack of insight into the prioritization of tasks from the cost-benefit perspective. For example, Security and Privacy Controls for Federal Information Systems and Organizations (known as SP 800-53) is a core component in NIST CSF (see NIST (2013)), and although it assigns priority codes to security controls, as clarified in the document, those codes are for implementation sequencing that is reasoned from the engineering point of view, but they provide no information on whether or not it is economically beneficial to implement a certain control. Except those who are subject to the requirements in SP 800-53 (including government agencies, contractors, and subcontractors), other organizations may find such guidelines not instructive enough on how to allocate capital and spend money on implementing these security controls. As mentioned in Gordon et al. (2015), private-sector firms have other investment decisions than cybersecurity and they all compete for limited organizational resources. For this reason, cost-benefit analysis is important in the decision-making process regarding cybersecurity investment.

To associate cyber assets with economic losses, Tatar et al. (2020) proposed that once the topology of a system is determined, the impact of potential cyber attacks can be evaluated using an attack graph and an impact graph, the former of which describes the possible attack path along interconnected nodes, and the latter of which quantitatively estimates the potential impacts on nodes of a system. This method requires a microscopic assessment on individual software and hardware vulnerabilities with respect to their probability of being exploited, which might be difficult to realize using any empirical methods given the data scarcity issue.

Overall, engineering approaches mainly focus on infrastructural details, but may not provide enough support for strategical investment and capital allocation planning. Although there are attempts to establish the link between the infrastructure of cyber systems and the losses arising from them, the capital component in cyber risk management is largely missing in mainstream solutions provided by the engineering community.

Economics literature

In the economics and finance literature, more emphasis is on the losses caused by cyber incidents, while cyber systems are often highly abstracted. For example, Liu et al. (2020) modeled a power system as a collection of nodes and modeled the dynamics of an attack on that system using an absorbing semi-Markov process, which further lead to discussions on the financial consequences of cyber threats. Eling and Wirfs (2019) studied a dataset that contains historical cyber losses, identified classes of cyber risks depending on causes, such as human error or technical failure, and then modeled loss frequency and severity by probability distributions. Eling and Jung (2018) studied a collection of historical data breaches and used vine copulas to model the dependence among cyber losses in terms of the number of breached records. Using the same dataset of data breaches, Xu et al. (2018) performed trend analyses and built stochastic models for the frequency and size of data breaches caused by hacking. A recent work by Chen et al. (2021a) analyzed an economic insurance pricing model that took into account the impact of cyber incidents on the production side as well the loss of premium customers on the sales side.

Many of the studies from the economics and finance perspective help understand the consequences of cyber incidents, thus providing organizations with hints on how to prepare for potential losses resulting from various types of cyber incidents. There are also several economics studies that try to draw connections between cyber losses and cybersecurity practices, such as how losses can be reduced by implementing certain security controls. For example, Gordon and Loeb (2002) proposed a model for calculating the optimal level of investment. The model expresses the probability of experiencing a security breach as a function of security investment and then uses this probability to calculate the expected loss. The optimal investment in cybersecurity is thus obtained when the marginal investment is equal to the marginal reduction in expected loss. Smeraldi and Malacaria (2014) formulated investment in cybersecurity as an optimization problem, known as the knapsack problem, where there is a target to protect, a fixed budget, and a set of cyber resources that each can be invested in and generates a return, *i.e.*, some level of protection for the target. The goal is to maximize the overall return with the limited budget. The authors also proposed some variants to this problem, where there could be interactions between resources, *e.g.*, one could be an alternative of the combination of another two resources in terms of the generated return, and where there could be multiple targets to protect. These studies provide some insights into the question on how much should be spent on cybersecurity based on the principle that there should be an equilibrium in the trade-off between cyber investment and the residual cyber risk. That is, a decision maker can choose to either spend more on cybersecurity investment and less on the capital reserved for cyber losses, or the other way around.

To generalize this problem a little more, we can see it as the trade-off between the immediate cost and the potential cost in the future. This type of problem is commonplace in the economics literature on other topics than cyber. For example, the well-known Laffer curve suggests that if a government sets a high tax rate, the initial revenue from taxation may be large, but because of the low profitability, companies may reduce economic activities and the economy may contract,

thus leading to low tax revenue. On the contrary, if there is a low tax rate, companies increase production and the economy expands due to a higher profitability, thus leading to an expanded source of revenue in the future (see Wanniski (1978)). Clearly, the government needs to strike a balance between the immediate tax income and the income in the long run. Other than taxation, the Laffer curve effect has been studied and applied in many different fields as well; see, for example, Tragler et al. (2001) and Janvry and Sadoulet (2006).

Ideally, the thought process for investment in cyber should be no different. However, as found in Rowe and Gallaher (2006), organizations rarely incorporate this type of cost-benefit analysis in cyber risk management. What might hinder the development of such strategies is that the existing studies, such as Gordon and Loeb (2002) and Smeraldi and Malacaria (2014), provide no identification of specific cyber assets and vulnerabilities. When multiple vulnerabilities and sources of losses are in concern, the lack of structural information on cyber systems can make it difficult for organizations to create actionable plans and put specific controls in place.

Capital management framework for cyber risk and contributions

By observing the approaches taken by these two communities and comparing their differences, we find that solutions to specific cybersecurity challenges are usually the focus of engineering research, whereas the economics and finance community typically emphasizes the outcomes of cyber incidents. We believe these two aspects are both important because the former offers instructions on how to address specific cyber threats by implementing certain security controls, and the latter generates economic incentives for organizations to take actions to reduce the risk. However, we are not aware of any unified solution that takes benefit of both perspectives. Imagine that an organization is considering investing in a set of CIS Controls. To make this management decision, it needs to assess how much reduction in losses can be achieved by implementing those controls and determine how much should be invested in each of them. These questions are yet to be answered.

To address them, we propose a framework that quantifies this relationship and can be easily incorporated in the risk management decision making process. This framework consists of two components as follows,

- (i) *Ex-ante investment*, which is the investment in implementing security controls, such as hiring cybersecurity professionals, applying security patches, and training personnel, and it has an immediate effect on reducing cyber risk exposure *before* any incidents happen (see, for example, August and Tunca (2006), Cavusoglu et al. (2008), and Li et al. (2019)). In this paper, we assume that the company has already implemented some controls which match the industry-average security standard, and our discussions on cybersecurity investments surround any additional spending on top of that level.
- (ii) *Ex-post-loss reserve*, which is the emergency fund set up to cover losses resulting from cyber incidents, such as forensics costs, costs for repairing or replacing cyber assets, and legal liabilities in case of lawsuits. Note that, this fund is indeed reserved *before* any cyber incidents

happen, but it is then used to absorb losses *after* the incidents, which explains its ex-post-loss effect.

Our approach takes both components into consideration and finds an optimal strategy for businesses to allocate their budgets on implementing various cyber controls and preparing for potential future losses. The goal is to allocate a minimal amount of budget, including both the ex-ante investments and the ex-post-loss coverage fund, for cyber risks, and at the same time, to minimize the impact of cyber incidents.

The main contribution of this paper is five-fold.

- This paper presents the first quantitative description of the cascade model previously known in the engineering literature, to the best knowledge of authors. It bridges the gap between the engineering approach and the economics and finance approach to cyber risk assessment by providing a unifying framework. The new approach utilizes both the structural information of cyber systems and historical cyber loss data to provide risk assessment and management insights that are quantitative and specific to individual components in cyber systems.
- The framework is compatible and can be implemented along with the existing standards for cybersecurity, such as the NIST CSF. This feature is important for the practicality of a cyber risk management method, but is generally missing in the quantitative methods that have been proposed. Therefore, our work offers a pragmatic tool for decision making in the process of complying with industry regulations and standards of practice.
- The framework addresses the three aforementioned challenges in cyber risk assessment. Not limited to any specific type of risk, it incorporates the quantitative assessment of potential losses that may arise from various points of failure in a cyber system. In addition, the framework considers both external threats and internal vulnerabilities and assets, so that when a new threat emerges due to the adaptive nature of cyber risk, the model can be easily updated to reflect such a change in environment. Various cyber components are linked in this framework via attack paths, and that captures the dependence among the risk exposures of them.
- The framework also offers a tool of capital management that enables users to quantify and assess the trade-off between cybersecurity investment and loss reserve. The capital management model shows an extension of the Laffer curve in economics, which is a classic tool used in economics to understand the balance between tax rates and tax revenue.
- The paper presents a novel application of collective risk modeling and Pareto optimization, which are rarely discussed in the context of cyber risk. It presents that for the cyber risk management in a business environment, there are competing priorities and objectives, and those techniques are well-suited for such a problem.

The proposed risk assessment and capital allocation methods are implemented in R language, which can be found in the supplementary materials of this paper. Its practicality is demonstrated with real data. Practitioners may easily adopt the codes for their company specific applications.

The overall organization of the rest of this paper is as follows. Section 2 proposes a tensor-based loss model for cyber risk assessment, which incorporates the structural information of risk arrival. Based on the risk assessment results, Section 3 introduces the holistic framework of optimizing capital allocation for cybersecurity investment and cyber loss reserve. Section 4 provides a case study that integrates the risk assessment process and the decision making of capital allocation for cyber risk management. Section 5 concludes and outlines some potential future directions.

2 Cyber Risk Assessment

2.1 Cascade model

Böhme et al. (2019) developed a *cascade model* to describe the arrival of cyber incident, in which each arrival process is summarized as follows.

- (i) Once a *threat* is initiated by an attacker, it will exploit *vulnerabilities* in a cyber system.
- (ii) The vulnerabilities that are not fully eliminated by security *controls* will then be the viable paths for the threat to impact *assets* in the system.
- (iii) Eventually, assets of different types and values will generate distinct *impacts*.

In this paper, we take the inspiration from this model and extend it for cyber risk assessment and capital management. As summarized in the arrival process, there are five essential cascade components in the model; we shall first explain their details below and use an example to allude the relationship among them.

- A *threat* is an action that has the potential of causing damage to a cyber system. They might be initiated externally by hackers or cyber criminals with malicious intent, or they could simply be reckless actions performed internally which lead to unintentional damage. For instance, a common threat for password protected accounts is external dictionary attack, which utilizes a large pool of possible passwords to guess the correct one by trial and error until succeeding.
- A *vulnerability* is a cyber weakness that may be exploited by a threat. A threat alone cannot induce any harm if it fails to match any vulnerabilities in the system. For example, allowing an unlimited number of password attempts is a perfect match to the dictionary attack; provided with sufficient computational power, the attacker will eventually get the correct password, which is only a matter of time.
- A *control* is a security measure that is designed for patching a vulnerability. If a control is applied to a vulnerability, the risk of that vulnerability being exploited by the threat(s) will

be reduced. For instance, the company, which is liable to the password protected accounts, can limit the number of password attempts before an account is temporarily locked, and hence lengthen the eventually succeeding time of the attacker; it can further enforce multi-factor authentication, or mandate regular change of passwords to the account holders, as an additional layer of security.

- An *asset* is associated with the information technology component of a certain entity, which can be tangible or intangible. The value of a cyber asset relies on its confidentiality, integrity, and availability, which are together known as the CIA triad (see Cebula and Young (2010)), and they are likely to be damaged or completely destroyed in cyber incidents. For example, a successful password attack would obtain all available private data in a victim account without permission and being noticed.
- An *impact* is a materialized loss arising from a cyber asset in a cyber incident. The impact may consist of various types of costs, such as the direct loss of value of a physical cyber asset when it becomes inoperable, or the legal cost if there is a lawsuit derived from the incident. For instance, the successful password attacker might directly steal any monetary benefit from the victim account using the data. In this paper, the impact is the base random variable for developing a cyber loss model.

With these five key cascade components being clearly defined, Figure 1 visualizes the structure of the cascade model as well as the relationship among the components. Hereafter, the first four cascade components are occasionally denoted as T, V, C, and A, followed by counting indices; for example, T1 represents the first threat while V4 represents the fourth vulnerability in the system. Although the impacts are denoted as I in the figure, we shall use another more conventional notation for these base random variables.

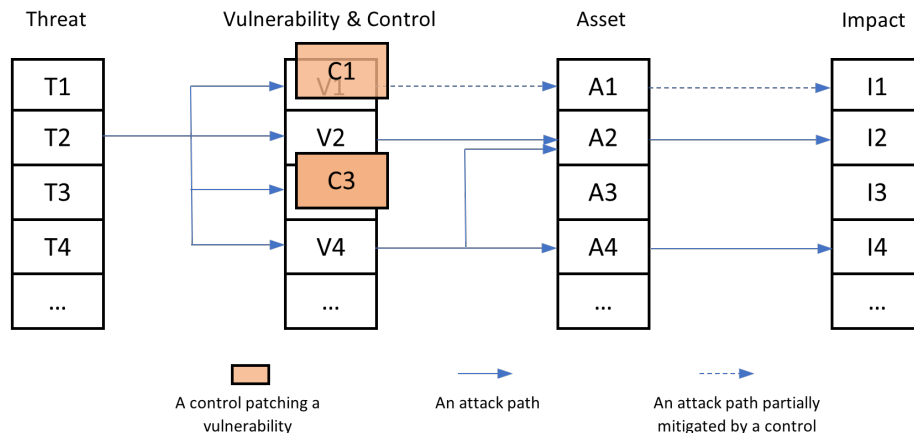

Figure 1: Cyber cascade model, and example of cyber incident, due to the second threat, where the first (resp. third) vulnerability is partially (resp. fully) patched by the first (resp. third) control

2.2 Mapping relationships among cascade components

In order to develop the quantitative cyber loss model based on the cascade model, the relationship among the cascade components must be concisely defined. As we can observe from Figure 1, since an asset being attacked induces one and only one impact, which shall be characterized by a random variable, there are only three mappings to be established, where the vulnerability serves as the core component and relates respectively to the threat, asset, and control. From now on, suppose that there are l types of threats, m categories of vulnerabilities, and n classes of assets.

- *Vulnerability-threat mapping*

This is a general many-to-many relationship, where a threat may exploit one or more vulnerabilities, and a vulnerability may be exploited by one or more threats. It characterizes the *external risk* by the intrinsic nature of a cyber event, which could be initiated externally or performed internally. This mapping is defined by a matrix A , which is of size $l \times m$, such that, for $i = 1, 2, \dots, l$ and $j = 1, 2, \dots, m$,

$$A_{ij} = \begin{cases} 1 & \text{if } V_j \text{ can be exploited by } T_i; \\ 0 & \text{otherwise.} \end{cases}$$

- *Vulnerability-asset mapping*

This is another general many-to-many relationship, where a vulnerability may associate with one or more assets, and an asset may be associated with one or more vulnerabilities. It characterizes the *internal risk* by the overall configurations inside a cyber system. This mapping is defined by a matrix B of size $m \times n$, such that, for $j = 1, 2, \dots, m$ and $k = 1, 2, \dots, n$,

$$B_{jk} = \begin{cases} 1 & \text{if } A_k \text{ is associated with } V_j; \\ 0 & \text{otherwise.} \end{cases}$$

- *Vulnerability-control mapping*

This is naturally a one-to-one and onto relationship based on the definition of controls. It characterizes the effectiveness of each control set in mitigating the corresponding vulnerability. For each vulnerability $j = 1, 2, \dots, m$, define $\theta_j \in [0, 1]$ be the scaling factor to the potential loss(es) due to this V_j , after a certain control set C_j is applied. When the vulnerability j is only guarded by the control set at the industry standard, $\theta_j = 1$. Note that the industry standard, instead of a completely insecure state that no control is applied at all, is considered in this paper, because many basic controls, such as built-in security features of many software applications, exist by default and thus an entirely insecure environment is nowhere to be found. Additional control measure C_j reduces the value of θ_j ; in particular, when the vulnerability j is fully eliminated, $\theta_j = 0$. The vulnerability-control mapping is summarized by the vector $\boldsymbol{\theta} = [\theta_1, \theta_2, \dots, \theta_m]$.

Since the vulnerabilities are shared across all three mappings, the relationships among threat, asset, and control can be obtained via composite mappings through the vulnerabilities. These mapping relationships indeed exist in practice, where cybersecurity controls are proposed to patch vulnerabilities and block pathways from threats to assets. For example, in the CIS (Center for Internet Security) Controls framework, CIS (2021) provided a comprehensive relationship between 20 controls and 5 assets; for illustration, the relationship is duplicated in Appendix A. Another example is that, based on this framework, SANS Institute (2013) did an empirical study, which maps most of those CIS controls with 25 threats compiled by Verizon Security Research & Cyber Intelligence Center (2021); the mapping is also repeated in Appendix B for demonstration.

Example 2.1. To plainly illustrate the quantitative cyber loss model, we shall assume the following smaller mapping matrices to be referred repeatedly for risk assessment in the remaining of Section 2.

$$A = \begin{array}{c} \text{T1} \\ \text{T2} \\ \text{T3} \end{array} \begin{array}{ccc} \text{V1} & \text{V2} & \text{V3} \\ \left(\begin{array}{ccc} 0 & 1 & 0 \\ 0 & 1 & 0 \\ 0 & 1 & 1 \end{array} \right), & B = \begin{array}{c} \text{V1} \\ \text{V2} \\ \text{V3} \end{array} \begin{array}{ccc} \text{A1} & \text{A2} & \text{A3} \\ \left(\begin{array}{ccc} 1 & 0 & 1 \\ 1 & 0 & 0 \\ 1 & 1 & 0 \end{array} \right), & \boldsymbol{\theta} = \begin{array}{ccc} \text{V1} & \text{V2} & \text{V3} \\ \left(\begin{array}{ccc} 1/2 & 1/3 & 1/4 \end{array} \right).$$

2.3 Tensor structure

With the aid of the three defined mappings above, we can define a single quantity for characterizing the effect by a cyber event on a controlled cyber system. To this end, for $i = 1, 2, \dots, l$, $j = 1, 2, \dots, m$, and $k = 1, 2, \dots, n$, let

$$D_{ijk} = A_{ij}B_{jk}\theta_j. \quad (1)$$

This quantity summarizes whether the cyber system is in danger of the cyber event, from the i -th threat by the j -th controlled vulnerability on the k -th asset, and if so, how extreme the impact is.

- If $D_{ijk} = 1$, the i -th threat, j -th controlled vulnerability, and k -th asset together will induce full impact to the system. This is the aggregate result of that V_j is exploited by T_i and that A_k is associated with V_j , and when no additional, other than industry standard, control C_j is implemented to patch V_j .
- If $0 < D_{ijk} < 1$, the i -th threat, j -th controlled vulnerability, and k -th asset together will induce partial impact to the cyber system. Note that the partial impact here is defined relative to the full impact when $D_{ijk} = 1$, and an impact is considered as partial when additional controls that exceed the industry-average level are implemented but are not yet able to completely eliminate the vulnerability. In this case, V_j is exploited by T_i , A_k is associated with V_j , and C_j only partially patches V_j .
- If $D_{ijk} = 0$, the i -th threat, j -th controlled vulnerability, and k -th asset together will not induce any impact to the system. This is either because, V_j cannot be exploited by T_i , or A_k is not associated with V_j , or V_j is fully patched by C_j .

The structural information of the cyber cascade model can then be revealed in terms of a *tensor* D , of size $l \times m \times n$, which shall prove itself useful in developing the quantitative cyber loss model in later sections. To clearly picture this abstract object, we revisit Example 2.1 as follows.

Figure 2a depicts the tensor in Example 2.1, while Figure 2b summarizes the elements of that tensor. In the example, as there are 3 types of threats, 3 categories of vulnerabilities, and 3 classes of assets, the tensor is defined in the finite set $\{T1, T2, T3\} \times \{V1, V2, V3\} \times \{A1, A2, A3\}$, where \times represents the Cartesian product herein. The tensor can be generalized to include the three mappings by introducing the origin O ; indeed, the vulnerability-threat matrix A can be positioned on the A -plane, which is defined by the coordinates (Ti, Vj, O) , while the vulnerability-asset matrix B can be set on the B -plane, which is defined by the coordinates (O, Vj, Ak) ; the vulnerability-control vector θ can be put on the θ -axis, which is defined by the coordinates (O, Vj, O) . Finally, the O -plane, which is defined by the coordinates (Ti, O, Ak) and represents the threat-asset mapping matrix AB , shall be handy in illustrating the cyber loss model in later sections. Such a generalization also applies for any finite set of threats, vulnerabilities, and assets.

2.4 Tensor-based cyber loss model

As pointed out in Section 2.1, an impact from each cyber incident is in fact a base random variable which models a random loss to the controlled cyber system. The impact depends on two factors. The first one is how the cyber event happens; that is, which threat is acted, either internally or externally, and in turn which vulnerability is exploited, as well as which asset is consequently affected; in addition, whether the vulnerability is patched. The first factor has been addressed by the tensor D introduced in the last section, which depends on the controlled cyber system.

The second factor lies in the loss size itself. To this end, for $i = 1, 2, \dots, l$, $j = 1, 2, \dots, m$, and $k = 1, 2, \dots, n$, let X_{ijk}^0 be the random variable which represents the raw loss due to a cyber incident, from the i -th threat by the j -th vulnerability on the k -th asset. Herein, the raw loss represents a cyber loss which is not further mitigated by additional cybersecurity controls, but is mitigated by those at the industry-average level. These random variables can be summarized by another tensor X^0 , of size $l \times m \times n$.

The contingent impact information from the cyber incident to the controlled cyber system of interest is then given by the element-wise product of the two tensors D and X^0 ; that is,

$$X = D \circ X^0, \quad (2)$$

where \circ stands for the element-wise multiplication between two tensors herein. In particular, if the cyber incident is from the i -th threat, by the j -th controlled vulnerability, on the k -th asset, the impact will be given by $X_{ijk} = D_{ijk}X_{ijk}^0$.

Example 2.2. We revisit Example 2.1 to further illustrate the cyber loss model. While the structure of the tensor in Figure 3a of Example 2.1 is similar to that in Figure 2a, they are actually different since Figure 3a depicts the loss tensor in which each element is an impact random variable,

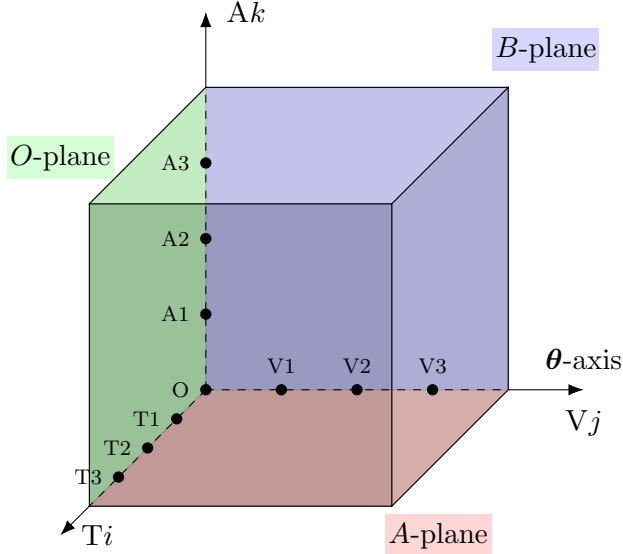

(a) Tensor structure of cyber cascade model in Example 2.1

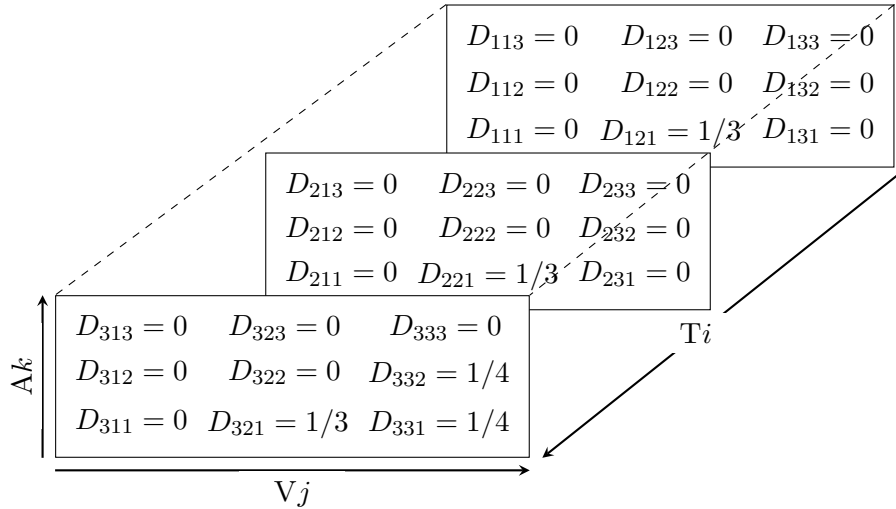

(b) Elements in tensor of Example 2.1

Figure 2: Example of tensor representation for cyber cascade model

as shown in Figure 3b. Therein, the elements are calculated based on Equation (2). For example, in accordance with Example 2.1, a viable attack path is represented by the red dashed arrows in Figure 3a, where T3 is acted on V3, which is partially patched by C3, and consequently affects A2. The impact associated with that path is given by

$$X_{332} = D_{332} X_{332}^0 = A_{33} B_{32} \theta_3 X_{332}^0 = (1/4) X_{332}^0.$$

However, if an attack path is not feasible, such as that T3 exploits V3 but A3 is not associated with V3, the impact will become null that

$$X_{333} = D_{333}X_{333}^0 = A_{33}B_{33}\theta_3X_{333}^0 = (0)X_{333}^0 = 0,$$

as $B_{33} = 0$, even if the raw random loss X_{333}^0 is non-zero.

2.5 Aggregate cyber loss

The abstract tensor-based cyber loss model in the last section does not directly provide much practical use for enterprise risk management purposes. It is, instead, an aggregate cyber loss over a given time period, say one fiscal year, during which multiple cyber incidents might emerge, would be called desirable to cyber risk managers. On one hand, as we shall see below, the loss model aggregating across cyber events is not new but based on the well-known collective risk model. On the other hand, the aggregate loss model for each cyber incident is derived by the loss tensor from the cascade model, which does not exist in the literature, and is based on, as alluded in Section 2.1, that a cyber event is due to a threat being acted.

2.5.1 Loss model for each cyber incident

We first fix a particular cyber event in the given period of time. Let L be the aggregate loss of that cyber incident. Since each incident is initiated by one and only one threat, the aggregate loss is given by the sum of mutually exclusive losses, in which each loss is due to a unique threat. To this end, define, for $i = 1, 2, \dots, l$,

$$Y_i = \begin{cases} 1 & \text{if } T_i \text{ is attempted;} \\ 0 & \text{otherwise,} \end{cases}$$

where, for any distinct $i_1, i_2 = 1, 2, \dots, l$, $\mathbb{P}(Y_{i_1} = 1, Y_{i_2} = 1) = 0$ and $\sum_{i=1}^l \mathbb{P}(Y_i = 1) = 1$; denote $\mathbb{P}(Y_i = 1)$ by p_i , and thus $\sum_{i=1}^l p_i = 1$. Moreover, let Z_i be the random loss due to the i -th threat, for $i = 1, 2, \dots, l$; since each threat exploits multiple controlled vulnerabilities, while each vulnerability associates with multiple assets, several impacts would be materialized due to that particular threat being acted; consequently,

$$Z_i = \sum_{k=1}^n \sum_{j=1}^m X_{ijk} = \sum_{j=1}^m X_{ij1} + \sum_{j=1}^m X_{ij2} + \dots + \sum_{j=1}^m X_{ijn}.$$

While the order of the double summations does not matter, we choose to aggregate the impacts across vulnerabilities first, and then across assets, to prepare for cyber capital management in later sections, where we shall provide practical reasons for this order. Let also Z_{ik} be the random loss

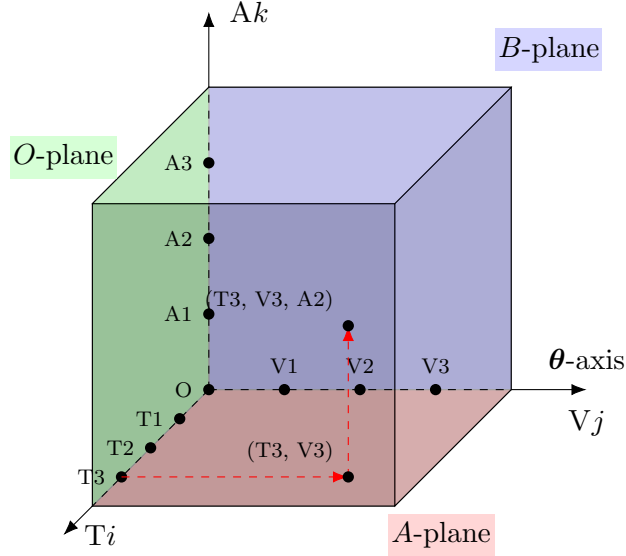

(a) Loss tensor and viable attack path in Example 2.1

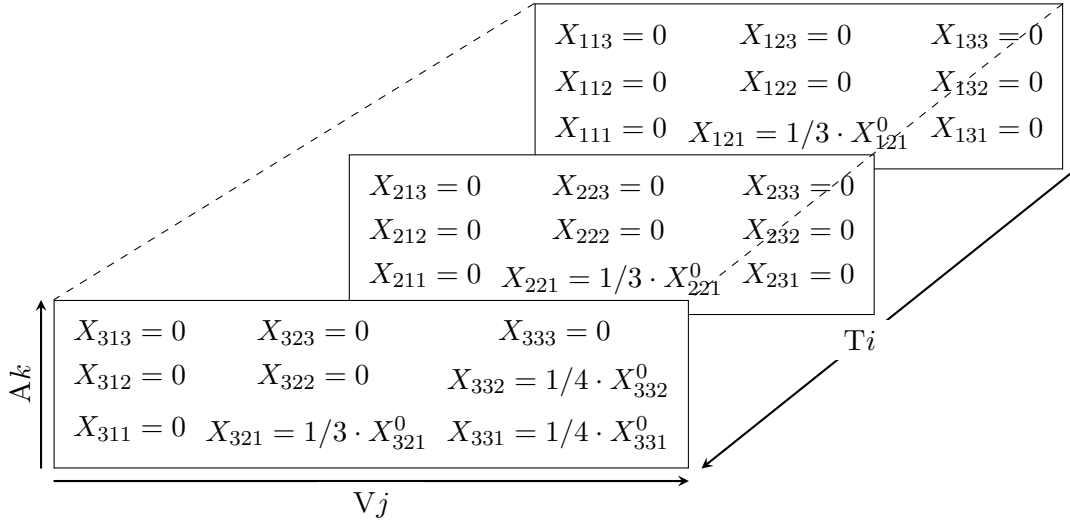

(b) Elements in loss tensor of Example 2.1

Figure 3: Example of tensor-based cyber loss model

due to the i -th threat on the k -th asset, for $i = 1, 2, \dots, l$ and $k = 1, 2, \dots, n$; and thus,

$$Z_{ik} = \sum_{j=1}^m X_{ijk} \quad \text{and} \quad Z_i = \sum_{k=1}^n Z_{ik}. \quad (3)$$

Therefore, the aggregate loss of the cyber event is given by

$$L = \sum_{i=1}^l Z_i \mathbb{1}_{\{Y_i=1\}}. \quad (4)$$

Revisiting Example 2.1 should ease the understanding of this series of aggregations. Figure 4 illustrates that the impact aggregation across vulnerabilities in (3) can be pictorially understood as compressing the impact random variables in the loss tensor towards the O -plane. Moreover, from Figure 4, the additional impact aggregation across assets in (3) can be realized as further compressing the aggregated random losses on the O -plane towards the T_i -axis. Finally, the materialized aggregate loss in (4) due to the cyber incident picks either Z_1 , Z_2 , or Z_3 on the T_i -axis.

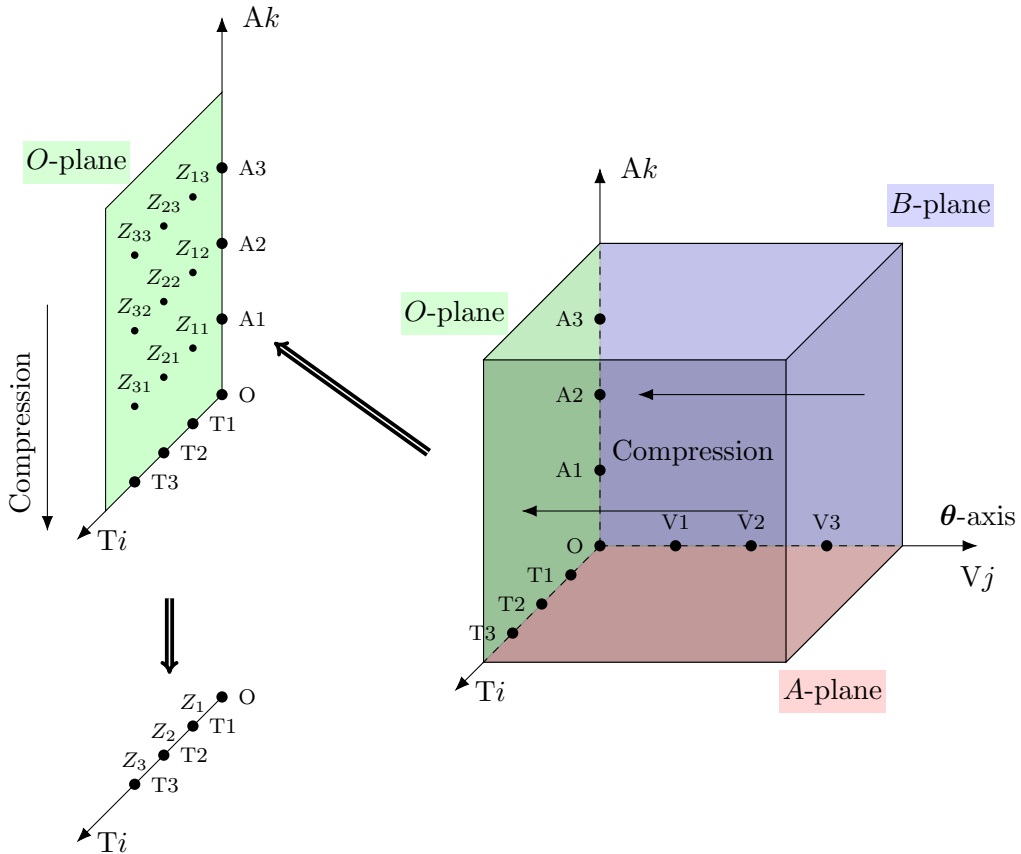

Figure 4: Impact aggregation across vulnerabilities and assets in Example 2.1

By (3) and (4), the distribution of aggregate loss of the cyber incident can be obtained by two

convolutions, followed by a mixing:

$$f_{Z_{ik}} = f_{X_{i1k}} * f_{X_{i2k}} * \cdots * f_{X_{imk}}, \quad \text{for } i = 1, 2, \dots, l \text{ and } k = 1, 2, \dots, n; \quad (5)$$

$$f_{Z_i} = f_{Z_{i1}} * f_{Z_{i2}} * \cdots * f_{Z_{in}}, \quad \text{for } i = 1, 2, \dots, l; \quad f_L = \sum_{i=1}^l p_i f_{Z_i}, \quad (6)$$

where $*$ represents the convolution operator, and f_R is the probability density function of a generic random variable R .

2.5.2 Collective risk model

Armed with the aggregate loss model for each cyber event, the aggregate loss model over the given period of time is simply resembling the renowned collective risk model. Let N be a non-negative random variable which represents the total number of cyber incidents. Let L^r , for $r = 1, 2, \dots$, be a sequence of independent and identically distributed aggregate losses, where L^r represents the aggregate loss of the r -th cyber incident and follows the distribution of f_L given in (6). Assume that the total number of cyber incidents N is independent of the aggregate losses L^r . Therefore, the total aggregate loss over the given time period $S = \sum_{r=1}^N L^r$, and its probability density function is given by

$$f_S = \lim_{\tilde{n} \rightarrow \infty} \sum_{r=0}^{\tilde{n}} (f_{L^1} * f_{L^2} * \cdots * f_{L^r}) \times p_N(r), \quad (7)$$

where $p_N(\cdot)$ is the probability mass function of the random variable N .

For the purpose of cyber capital management in later sections, let S_{ik} be the aggregate loss of cyber incidents from the i -th threat on the k -th asset over the given time period, where $i = 1, 2, \dots, l$ and $k = 1, 2, \dots, n$. It can be expressed as $S_{ik} = \sum_{r=1}^{N_{ik}} Z_{ik}^r$, where N_{ik} is a non-negative random variable to represent the number of cyber incidents from the i -th threat on the k -th asset, and Z_{ik}^r , for $r = 1, 2, \dots$, is a sequence of independent and identically distributed random losses due to T_i on A_k , and each Z_{ik}^r represents the random loss of the r -th cyber incident associated with (T_i, A_k) and follows the distribution of $f_{Z_{ik}}$ given in (5). The distribution of S_{ik} can be obtained in a similar manner as in (7), as long as N_{ik} and Z_{ik}^r are independent. Note that $S = \sum_{i=1}^l \sum_{k=1}^n S_{ik}$. We, again, defer providing the practical reasons for this choice of granularity for aggregate loss to the next section.

3 Cyber Capital Management

As in general risk management practice, company managers can make use of the quantitative loss model developed in the last section to outline capital allocation scheme for the cyber risks. On one hand, *ex-ante investment* should be budgeted for improving the existing cybersecurity controls or implementing new ones in order to mitigate potential cyber losses. On the other hand, *ex-post-loss coverage reserve* should be planned to weather the realized extreme cyber losses and to ensure

uninterrupted business operations. While the latter type of capital, *i.e.*, ex-post-loss reserve, has been extensively studied in the risk management literature for any class of risk, the former type, *i.e.*, ex-ante investment, has been seldom discussed in any risk management framework. The following section utilizes the cyber cascade model proposed in the last section to address the novel ex-ante investment problem and discusses its relationship with the classical problem of ex-post-loss reserve.

3.1 Trade-off: ex-ante investment versus ex-post-loss reserve

Recall that the cyber cascade model is characterized by the three mappings defined in Section 2.2. The vulnerability-threat and vulnerability-asset mappings are typically determined by the company’s cyber infrastructure and external factors of cyber actions. Company managers have the authority to allocate ex-ante investment for cybersecurity controls to revise the vulnerability-control mapping. Therefore, an impact, *i.e.*, a loss, from each cyber incident can be mitigated through partially, or even fully, patching the currently existing vulnerabilities, *i.e.*, any remaining vulnerabilities after industry-standard controls have already been applied, via investment in additional cybersecurity controls.

Let M_j , for $j = 1, 2, \dots, m$, be the cybersecurity investment amount to the control C_j for the vulnerability V_j . The investment amount M_j to the j -th control in turn affects the scaling factor to the potential loss(es) due to the V_j , which is $\theta_j(M_j)$; in particular, the investment amount and the scaling factor are inversely proportional to each other, that when the ex-ante investment is large, the scaling factor becomes small, and vice versa. Since the total aggregate loss S , and the aggregate loss S_{ik} because of (T_i, A_k) , for $i = 1, 2, \dots, l$ and $k = 1, 2, \dots, n$, over the given period of time, depend on the scaling vector θ , they are actually driven by the investment vector $\mathbf{M} = [M_1, M_2, \dots, M_m]$. In the sequel, we shall write such dependence for the aggregate losses $S(\mathbf{M})$ and $S_{ik}(\mathbf{M})$.

They guide us to the underlying trade-off between ex-ante investment and ex-post-loss reserve. When the management allocates no or little additional capital for the cybersecurity investment beyond the industry standard, the scaling factor vanishes such that the cyber system experiences almost full impact from contingent cyber events. In this case, the realized aggregate losses within the period could be massive, which require the management to plan a tremendous amount of reserve to absorb losses. For example, in the 2017 WannaCry attack where the threat is encrypting ransomware, many organizations were exposed to it because of their lack of data recovery capability, which is the exploited vulnerability in such events. However, this vulnerability could have been easily patched by relatively low cost preventative measures such as reliable backups for important data, and thus the materialized impact of the attack could have been substantially reduced, which leads to a lower cost of business or production recovery from data inaccessibility. This corresponds to the left side of the curve in Figure 5, which resembles the well-known Laffer curve, where a marginal increase in cybersecurity investment can significantly reduce the expected amount of spending on recovery after cyber incidents, and reduce the total allocated capital.

However, this does not necessarily imply that the cyber risk manager should fully allocate

capital for cybersecurity investment only. The well-known Gordon-Loeb model (see Gordon and Loeb (2002) and Gordon et al. (2016)) states that the marginal benefit, in terms of the reduction of reserve, decreases for each unit of cybersecurity investment. Therefore, as pointed out by Ruan (2019), if the total allocated capital is to be minimized, there will be a certain level of cybersecurity investment such that any additional investment allocation is not worthy for such small marginal return. This corresponds to the right side of the curve in Figure 5.

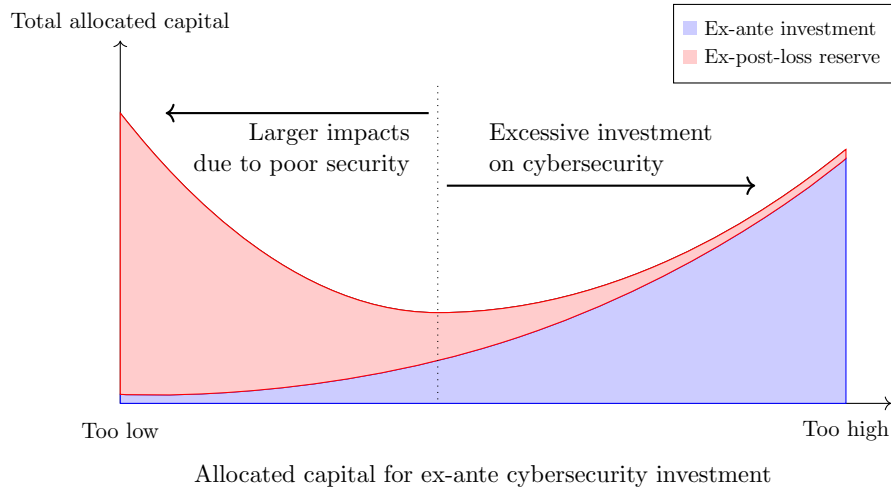

Figure 5: Trade-off between ex-ante investment and ex-post-loss reserve for cyber risks

3.2 Optimal capital allocation

How to find the sweetspot for the ex-ante investment and ex-post-loss reserve trade-off should be one of the key elements to be considered in any cyber capital management practice. Regarding the targets of investments, there is no ambiguity that they should be cybersecurity controls that patch vulnerabilities. However, the company could make reserves for different classes of targets. For example, the company could set aside funds for individual assets, *e.g.*, separate reserves for data and physical assets. Similarly, reserves could be prepared specific to different threats. In this paper, we follow some existing practices in the cybersecurity and the cyber insurance industries. Cyber risk management tools, such as the Thrivaca model by Arx Nimbus, LLC. (2021), offer their clients the estimation of cyber losses at the granularity of threat-asset pairs. Moreover, since one could perceive reserve as a kind of self-insurance, assigning reserves to threat-asset pairs is in line with the common practice in cyber insurance policies. For example, the *CyberOne™ Coverage* offered by Hartford Steam Boiler (2017) covers cyber losses resulting from different attacks, such as malware and denial-of-service attacks, which are various types of threats, and the covered losses include data and system restoration costs, which arise from various classes of assets. Therefore, as alluded in Section 2, the reserve is allocated to the aggregate loss $S_{ik}(\mathbf{M})$ due to (Ti, Ak) , for $i = 1, 2, \dots, l$, and $k = 1, 2, \dots, n$.

In addition, there are two other common conflicting interests and priorities in a general cap-

ital management framework, which we review as follows and shall provide detailed account after formulating the optimal capital allocation problem.

- (Standalone and corporate allocations) Naturally, the management has to budget total capital at the whole corporate level which concerns the aggregate loss $S(\mathbf{M})$. For project financing, performance measure, and regulatory supervision purposes, the management also has to allocate reserve at standalone levels.
- (Loss-reserve matching and reduction in opportunity cost) On one hand, the cyber risk manager should plan and allocate reserve at both corporate and standalone levels such that they do not deviate much from the realized aggregate losses. On the other hand, reserve needs to be kept as liquid assets, such as cash and money market funds, which typically yield little return; the liquidity requirement indirectly causes an opportunity cost, which should be minimized.

In order to achieve those three compromises altogether, we propose to apply the holistic principle by Chong et al. (2021), which allows the manager to solve the cyber capital allocation as one single optimization problem; see also its recent application to pandemic resources management in Chen et al. (2021b).

$$\begin{aligned}
& \inf_{\mathbf{M} \in \mathcal{M}, \mathbf{K} \in \mathcal{K}} \underbrace{\left[\underbrace{\sum_{j=1}^m \eta_j M_j}_{\textcircled{3}} + \underbrace{\sum_{i=1}^l \sum_{k=1}^n \nu_{ik} K_{ik}}_{\textcircled{4}} + \underbrace{\sum_{i=1}^l \sum_{k=1}^n \omega_{ik} \mathbb{E} \left[(S_{ik}(\mathbf{M}) - K_{ik})^2 h_{ik}(S_{ik}(\mathbf{M})) \right]}_{\textcircled{5}} \right]}_{\textcircled{1}} \\
& + \underbrace{\left[\underbrace{\eta M}_{\textcircled{6}} + \underbrace{\nu K}_{\textcircled{7}} + \underbrace{\omega \mathbb{E} \left[(S(\mathbf{M}) - K)^2 h(S(\mathbf{M})) \right]}_{\textcircled{8}} \right]}_{\textcircled{2}},
\end{aligned} \tag{8}$$

where

- \mathcal{M} is the set of admissible ex-ante investment allocation $\mathbf{M} = [M_1, M_2, \dots, M_m]$ that $\mathcal{M} \subseteq \mathbb{R}^m$, and $M = \sum_{j=1}^m M_j$ is the corporate investment;
- \mathcal{K} is the set of admissible ex-post-loss reserve allocation $\mathbf{K} = [K_{ik}]_{i=1,2,\dots,l;k=1,2,\dots,n}$ that $\mathcal{K} \subseteq \mathbb{R}^{l \times n}$, and $K = \sum_{i=1}^l \sum_{k=1}^n K_{ik}$ is the corporate reserve;
- $\eta_j, \nu_{ik}, \omega_{ik}, \eta, \nu, \omega \geq 0$ are the weights of objectives. Notice that, since the weighted expected deviances, $\mathbb{E} \left[(S_{ik}(\mathbf{M}) - K_{ik})^2 h_{ik}(S_{ik}(\mathbf{M})) \right]$ and $\mathbb{E} \left[(S(\mathbf{M}) - K)^2 h(S(\mathbf{M})) \right]$, are quadratic, their units are measured in square dollars; yet, as the opportunity cost of allocated capitals, M_j, K_{ik}, M , and K , are linear, their units are measured in plain dollar. To practically and

fairly consider their aggregate effects as in (8), the weights of the expected deviances, ω_{ik} and ω , are composed of importance weights with no dollar unit, ω_{ik}^I and ω^I , and unit-exchange weights with reciprocal dollar units, ω_{ik}^E and ω^E , that each weight is their products, *i.e.*, $\omega_{ik} = \omega_{ik}^I \omega_{ik}^E$ for $i = 1, 2, \dots, l$ and $k = 1, 2, \dots, n$, and $\omega = \omega^I \omega^E$. The importance weights, ω_{ik}^I and ω^I , are compared relatively with other importance weights of no dollar unit, η_j , ν_{ik} , η , and ν . The choice of unit-exchange weights, ω_{ik}^E and ω^E , shall be discussed with an aid of the numerical example in Section 4;

- $h_{ik}(S_{ik})$ and $h(S)$ are the weighted penalty functions, for which $\mathbb{E}[h_{ik}(S_{ik})] = \mathbb{E}[h(S)] = 1$, which measure the deviation of realized aggregate losses from the allocated reserve intended to cover the losses; the family of such functions are summarized in Furman and Zitikis (2008), Dhaene et al. (2012), and Chong et al. (2021).

The holistic cyber capital allocation solved by (8) shall indeed take those three equilibriums into account, which can also be read from various pieces in the objective function.

- (Standalone and corporate allocations) The standalone allocation scheme is represented by ①, where investments on cybersecurity controls and reserves as losses buffer are balanced on the level of vulnerabilities and threat-asset pairs. In contrast, ② represents the corporate allocation scheme, in which the total investment and reserve are determined in the equilibrium.
- (Loss-reserve matching and reduction in opportunity cost) The matchings are given in ⑤ for standalone allocations, and in ⑧ for corporate allocation. They are achieved by minimizing the mismatching cost, which is the weighted expected deviance between the realized aggregate loss and the allocated reserve for covering the loss. The deviance is given in the quadratic form since cyber incidents might cause ripple effects, as described in University of Oxford and Axis (2020), which could lead to additional losses if the initial impact cannot be well contained due to the lack of reserve. Therefore, the relationship between loss-reserve mismatching and its cost should be non-linear. For instance, if a cyber attack disrupts the production lines of a manufacturer, and there is not sufficient fund for resuming the operation promptly, the manufacturer may face additional contractual liabilities for the late delivery of products. As for minimizing the opportunity cost for holding liquid assets as reserve, they are represented by ④ for standalone allocations, and by ⑦ for corporate allocation.
- (Ex-ante investment and ex-post-loss reserve) The trade-off between investment and reserve introduced in Section 3.1 is also weighed in. The costs of cybersecurity investment are given in ③ for standalone allocations, and in ⑥ for corporate allocation, whereas the reserve costs are ④ and ⑤ together, as well as ⑦ and ⑧ together. Note that the cost of reserve incorporates the consideration for the balancing between sufficient loss reserve and economical opportunity cost, as discussed in the last point.

3.3 Holistic cyber capital allocation

The capital allocation problem in (8) can be solved in two steps. First, for each ex-ante investment allocation $\mathbf{M} \in \mathcal{M}$, the optimal ex-post-loss reserve allocation $\mathbf{K}^* \in \mathcal{K}$, which depends on the fixed investment \mathbf{M} , is solved from (8) without the objective terms ③ and ⑥. Then, the optimal reserve $\mathbf{K}^*(\mathbf{M})$ is substituted back into (8), which is solved for the optimal investment \mathbf{M}^* . Consequently, the optimal investment and reserve allocation is given by the pair $(\mathbf{M}^*, \mathbf{K}^*(\mathbf{M}^*))$. The first step was resolved in Chong et al. (2021); for the sake of completeness and ease of exposition of the second step, we shall briefly review the solution of the optimal ex-post-loss reserve $\mathbf{K}^*(\mathbf{M})$. For the optimal investment \mathbf{M}^* in the second step, a pairwise comparison between admissible investment allocations shall again shed light on the trade-off between ex-ante investment and ex-post-loss reserve. In the sequel, an investment or a reserve is admissible as long as it is non-negative, which should be practically assumed.

3.3.1 Optimal ex-post-loss reserve

Throughout this subsection, fix a non-negative investment allocation \mathbf{M} . We shall first present the unconstrained solution, *i.e.*, when $\mathcal{K} = \mathbb{R}^{l \times n}$ in (8), as it shall lead us on how to solve the optimal reserve with the non-negativity constraint.

With $\mathcal{K} = \mathbb{R}^{l \times n}$, the optimal ex-post-loss reserve $\tilde{\mathbf{K}}^*(\mathbf{M})$ is given by, for any $i' = 1, 2, \dots, l$, and $k' = 1, 2, \dots, n$,

$$\tilde{K}_{i'k'}^*(\mathbf{M}) = \bar{K}_{i'k'}(\mathbf{M}) - \tilde{W}_{i'k'} \left(\sum_{i=1}^l \sum_{k=1}^n \bar{K}_{ik}(\mathbf{M}) - \bar{K}(\mathbf{M}) \right), \quad (9)$$

and the corporate reserve is

$$\tilde{K}^*(\mathbf{M}) = \sum_{i=1}^l \sum_{k=1}^n \tilde{K}_{ik}^*(\mathbf{M}) = \bar{K}(\mathbf{M}) + \tilde{W} \left(\sum_{i=1}^l \sum_{k=1}^n \bar{K}_{ik}(\mathbf{M}) - \bar{K}(\mathbf{M}) \right),$$

where, for any $i' = 1, 2, \dots, l$, and $k' = 1, 2, \dots, n$,

$$\bar{K}_{i'k'}(\mathbf{M}) = \mathbb{E}[S_{i'k'}(\mathbf{M}) h_{i'k'}(S_{i'k'}(\mathbf{M}))] - \frac{\nu_{i'k'}}{2\omega_{i'k'}}, \quad \bar{K}(\mathbf{M}) = \mathbb{E}[S(\mathbf{M}) h(S(\mathbf{M}))] - \frac{\nu}{2\omega}, \quad (10)$$

$$\tilde{W}_{i'k'} = \frac{\frac{1}{\omega_{i'k'}}}{\frac{1}{\omega} + \sum_{i=1}^l \sum_{k=1}^n \frac{1}{\omega_{ik}}}, \quad \tilde{W} = \frac{\frac{1}{\omega}}{\frac{1}{\omega} + \sum_{i=1}^l \sum_{k=1}^n \frac{1}{\omega_{ik}}}.$$

These four components constituting the optimal and corporate reserves are respectively the optimal standalone reserve $\bar{K}_{i'k'}(\mathbf{M})$, the optimal corporate reserve $\bar{K}(\mathbf{M})$, and harmonic weights $\tilde{W}_{i'k'}$, \tilde{W} . Note that $\tilde{W} + \sum_{i=1}^l \sum_{k=1}^n \tilde{W}_{ik} = 1$. The optimal standalone reserve describes the amount planned to a particular threat-asset pair $(T_{i'}, A_{k'})$ if it were the only pair to be allocated with reserve. When $\nu_{i'k'}$ is relatively larger than $\omega_{i'k'}$, *i.e.*, it is more costly to allocate reserve for the

threat-asset pair $(T_{i'}, Ak')$, in terms of the opportunity cost over the loss-reserve mismatching cost, its optimal reserve is reduced. Similar interpretations hold for the optimal corporate reserve. The harmonic weights represent the competition among optimal standalone reserves and the optimal corporate reserve. When $\omega_{i'k'}$ is relatively larger than the other ω_{ik} and ω , the corresponding harmonic weight $\widetilde{W}_{i'k'}$ is small, and thus the optimal reserve inclines to its own optimal standalone reserve.

Let us discuss the case when the non-negativity constraint, *i.e.*, $\mathcal{K} = \mathbb{R}_+^{l \times n}$, is imposed. On one hand, if all of the unconstrained optimal ex-post-loss reserve solved in (9) satisfy the constraint, they are also optimal for the constrained case. On the other hand, if some of the unconstrained reserve solved in (9) do not satisfy the constraint, they should instead be assigned by the lower bound as reserve, which is zero in this setting. Hence, these threat-asset pairs should not compete with other pairs, as well as the whole corporate, for reserve resources, and this should be reflected in the revised harmonic weights which exclude those non-competing threat-asset pairs. However, before all of the constrained optimal ex-post-loss reserve are solved, the exact threat-asset pairs being bound by the non-negativity constraint are *not known a priori*. To this end, we introduce an auxiliary variable I_{ik} , for $i = 1, 2, \dots, l$, and $k = 1, 2, \dots, n$, which takes a value either 0 or 1. Then, all of the constrained optimal ex-post-loss reserve $K^*(\mathbf{M})$, together with the auxiliary variables as by-products, are solved by the following set of equations.

$$K_{i'k'}^*(\mathbf{M}) = \begin{cases} K_{i'k'}(\mathbf{M}) & \text{if } K_{i'k'}(\mathbf{M}) \geq 0 \\ 0 & \text{if } K_{i'k'}(\mathbf{M}) < 0 \end{cases}, \quad \mathbb{1}_{\{K_{i'k'}(\mathbf{M}) \geq 0\}} = I_{i'k'}, \quad (11)$$

for all $i' = 1, 2, \dots, l$, and $k' = 1, 2, \dots, n$, where

$$K_{i'k'}(\mathbf{M}) = \overline{K}_{i'k'}(\mathbf{M}) - W_{i'k'} \left(\sum_{i=1, i \neq i'}^l \sum_{k=1, k \neq k'}^n \overline{K}_{ik}(\mathbf{M}) I_{ik} + \overline{K}_{i'k'}(\mathbf{M}) - \overline{K}(\mathbf{M}) \right),$$

and the optimal standalone reserve $\overline{K}_{i'k'}(\mathbf{M})$, as well as the optimal corporate reserve $\overline{K}(\mathbf{M})$, are still given by (10), but the harmonic weight is revised as

$$W_{i'k'} = \frac{\frac{1}{\omega_{i'k'}}}{\frac{1}{\omega} + \frac{1}{\omega_{i'k'}} + \sum_{i=1, i \neq i'}^l \sum_{k=1, k \neq k'}^n \frac{1}{\omega_{ik}} I_{ik}}.$$

For further detailed account of the constrained solution, and the proof of obtaining the set of equations, see Chong et al. (2021).

3.3.2 Optimal ex-ante investment

With the ex-post-loss reserve being optimized given by (11), the total cost (8), which depends on the ex-ante investment for cybersecurity controls, involves two parts:

- the residual cost of reserve

$$g_r(\mathbf{M}) = \sum_{i=1}^l \sum_{k=1}^n \nu_{ik} K_{ik}^*(\mathbf{M}) + \sum_{i=1}^l \sum_{k=1}^n \omega_{ik} \mathbb{E} \left[(S_{ik}(\mathbf{M}) - K_{ik}^*(\mathbf{M}))^2 h_{ik}(S_{ik}(\mathbf{M})) \right] \\ + \nu K^*(\mathbf{M}) + \omega \mathbb{E} \left[(S(\mathbf{M}) - K^*(\mathbf{M}))^2 h(S(\mathbf{M})) \right]; \quad (12)$$

- the cost of cybersecurity investment

$$g_c(\mathbf{M}) = \sum_{j=1}^m \eta_j M_j + \eta M. \quad (13)$$

Therefore, for any two non-negative investment allocations $\mathbf{M}_p, \mathbf{M}_q \in \mathcal{M} \subseteq \mathbb{R}_+^m$, the investment \mathbf{M}_p is better off than the other investment \mathbf{M}_q if

$$g_r(\mathbf{M}_q) - g_r(\mathbf{M}_p) \geq g_c(\mathbf{M}_p) - g_c(\mathbf{M}_q).$$

This inequality echoes again the trade-off between ex-ante investment and ex-post-loss reserve. Suppose that \mathbf{M}_q is an existing investment allocation for the cybersecurity controls, while \mathbf{M}_p is an exploring allocation strategy. The inequality entails that, if the reduction of the residual cost of reserve is more than the additional cost of cybersecurity investment, the new allocation \mathbf{M}_p is worthy. Generally speaking, this is because the marginal benefit outweighs the marginal cost. This is perfectly in line with the advocate in cybersecurity investment literature, such as Cavusoglu et al. (2004), Gordon and Loeb (2002), and Ruan (2019), that an investment should not be made if it does not generate more benefit than the investment cost itself.

4 Case Study

This section provides a proof of concept case study to illustrate the cyber risk assessment and capital management framework proposed in this paper. A historical cyber incident dataset acquired from the Advisen Ltd. is used for the demonstration. The dataset contains 103,061 cyber incidents. There are 125 variables coded for each incident, which can be classified into four categories; they are

- (i) the information of a victim company,
- (ii) the nature of an incident,
- (iii) the consequences of the incident, and
- (iv) the information of any associated lawsuits.

Since the proposed framework is for a particular cyber system of interest, we indiscriminately select a victim company from the dataset for this case study. For confidential courtesy, we shall refer the victim company as Company X in the sequel.

4.1 Loss tensor

To assess the cyber risk of Company X, we need to first identify all possible threats, vulnerabilities, and assets, as well as their mapping relationships, for its underlying cyber system. However, the acquired dataset from the Advisen Ltd. does not contain any sensitive information of a victim company, such as its internal configuration nor external exposure. Therefore, we assume that the historical cyber incidents of the victim company have exhaustively covered all possible T_i , V_j , and A_k , for $i = 1, 2, \dots, l$, $j = 1, 2, \dots, m$, and $k = 1, 2, \dots, n$, as well as the mapping matrices A and B . As a consequence, we implicitly assume that the victim company could not fully patch the vulnerabilities by only industry-average cybersecurity controls in the past, which is usually the case in practice.

For the Company X, there are $l = 2$ types of threats, $m = 3$ categories of vulnerabilities, and $n = 2$ classes of assets, which are summarized in Table 1.

i	Threat
1	Data Breach
2	Privacy Violation
j	Vulnerability
1	Communication System
2	Data System
3	Software
k	Asset
1	Personal Financial Information (PFI)
2	Personally Identifiable Information (PII)

Table 1: Indexed threats, vulnerabilities, and assets of Company X

In fact, the entire dataset covers two more types of threats and one more category of vulnerabilities. As summarized in Kesan and Zhang (2020), the four types of threats are data breach, privacy violation, extortion & fraud, and IT error. As for the four categories of vulnerabilities, they are communication system, data system, software, and hardware. The PFI and PII are indeed the only two classes of assets covered in the whole dataset.

The mapping matrices of the threats, vulnerabilities, and assets for the Company X are given by

$$A = \begin{matrix} & \begin{matrix} \text{V1} & \text{V2} & \text{V3} \end{matrix} \\ \begin{matrix} \text{T1} \\ \text{T2} \end{matrix} & \begin{pmatrix} 0 & 0 & 1 \\ 1 & 1 & 0 \end{pmatrix} \end{matrix}, \quad B = \begin{matrix} & \begin{matrix} \text{A1} & \text{A2} \end{matrix} \\ \begin{matrix} \text{V1} \\ \text{V2} \\ \text{V3} \end{matrix} & \begin{pmatrix} 0 & 1 \\ 0 & 1 \\ 1 & 0 \end{pmatrix} \end{matrix}.$$

Together with the cybersecurity controls $\boldsymbol{\theta} = [\theta_1, \theta_2, \theta_3]$, which shall be determined later by the ex-ante investment allocation $\mathbf{M} = [M_1, M_2, M_3]$, the cyber loss tensor of the Company X is shown in Figure 6; the models for the raw random losses X_{131}^0 , X_{212}^0 , and X_{222}^0 shall be discussed in the

following section.

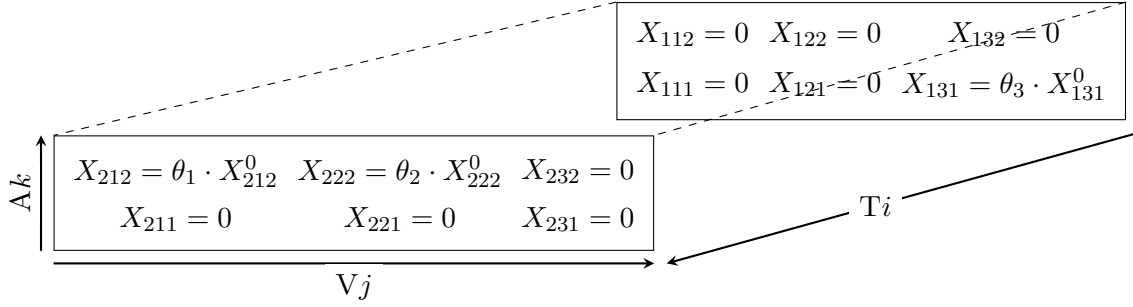

Figure 6: Loss tensor of Company X

4.2 Aggregate loss

To obtain the distributions of the aggregate losses, S and S_{ik} , for $i = 1, 2$, and $k = 1, 2$, for the purpose of capital allocation, we need to first model the severity for the raw random losses, as well as the frequency for the numbers of cyber incidents. As alluded from the loss tensor of the Company X in Figure 6, it suffices to model the losses X_{131}^0 , X_{212}^0 , and X_{222}^0 . Moreover, from Figure 6, since $Z_{12} = X_{112} + X_{122} + X_{132} = 0$ and $Z_{21} = X_{211} + X_{221} + X_{231} = 0$, regardless of the realized values of N_{12} and N_{21} , we have $S_{12} = S_{21} = 0$; and thus, it suffices to model the total number of cyber incidents N , and the numbers of cyber events, N_{11} and N_{22} , for the threat-asset pairs (T1, A1) and (T2, A2), of the Company X.

Recall that a raw cyber loss should be independent of the company of interest; therefore, all independent cyber losses from the historical incidents, which emerged in the industry where the Company X lies in, are used for statistical inference purposes. Table 2 provides their summary statistics from the dataset.

Summary Statistics	X_{131}^0	X_{212}^0	X_{222}^0
Number of Total Observations	751	6061	3668
Number of Independent Observations	607	5260	3541
Number of Zero Losses	69	4546	3200
Number of Non-Zero Losses	538	714	341
Non-Zero Losses Minimum	10	101	9
Non-Zero Losses First Quartile	27050	11247	7500
Non-Zero Losses Median	2.06×10^5	1.37×10^5	7.07×10^4
Non-Zero Losses Third Quartile	1.59×10^6	1.83×10^6	9.69×10^5
Non-Zero Losses Maximum	1.56×10^9	5.05×10^8	1.76×10^9
Non-Zero Losses Mean	2.05×10^7	4.58×10^6	7.35×10^6

Table 2: Summary statistics of industry-wide cyber losses

From the summary statistics, we can easily infer that zero-inflated models are necessary for fitting these three raw losses well. For the parts of positive loss, Weibull distribution turns out to

provide a good fit. Table 3 shows the results of Pearson’s chi-square tests and their corresponding statistical significances with respect to the significance level 0.05.

Raw Random Loss	p -Value	Testing Decision
X_{131}^0	0.4545	Accepted
X_{212}^0	0.4605	Accepted
X_{222}^0	0.4429	Accepted

Table 3: Statistical significances of estimated Weibull distributions

Together with the scaling control vector $\boldsymbol{\theta} = [\theta_1, \theta_2, \theta_3]$, the cumulative distribution function

$$F_{X_{ijk}}(x) = \begin{cases} q_{ijk} & \text{if } x = 0 \\ q_{ijk} + (1 - q_{ijk}) \left(1 - \exp \left(- \left(\frac{x}{\theta_j \lambda_{ijk}} \right)^{b_{ijk}} \right) \right) & \text{if } x > 0 \end{cases}, \quad (14)$$

for $(i, j, k) \in \{(1, 3, 1), (2, 1, 2), (2, 2, 2)\}$, where the estimated probability mass for zero loss q_{ijk} , as well as the estimated shape and scale parameters b_{ijk}, λ_{ijk} of the Weibull distribution, are summarized in Table 4.

(i, j, k)	q_{ijk}	b_{ijk}	λ_{ijk}
(1, 3, 1)	0.114	0.303	1.212×10^6
(2, 1, 2)	0.864	0.349	7.427×10^5
(2, 2, 2)	0.904	0.338	4.130×10^5

Table 4: Estimated parameters of zero-inflated Weibull distributions for raw cyber losses

The fitted zero-inflated Weibull distributions are then discretized for preparing the two convolutions and the mixture in (5) and (6), in which the probabilities p_1 and p_2 of the mutually exclusive occurrence of T1 and T2 for the Company X are respectively estimated as 0.015 and 0.985.

We fix one fiscal year for the capital allocation purpose. Therefore, the acquired dataset with the historical cyber incidents for the Company X from 1997 to 2017 induce 21 observations for each frequency random variable N , N_{11} , and N_{22} . We assume that they follow the Poisson distribution. By the maximum likelihood estimation, the estimated means of these three frequency random variables are 6.48, 0.1, and 6.38 respectively.

Finally, as the distribution of the frequency random variables lies in the $(a, b, 0)$ class, we make use of the well-known Panjer recursion (Panjer (1981)) to obtain the distributions of the total aggregate loss S , as well as the threat-asset pairing aggregate losses S_{11} and S_{22} .

4.3 Capital Allocation

First of all, since $S_{12}(\mathbf{M}) = S_{21}(\mathbf{M}) = 0$ for any $\mathbf{M} \in \mathcal{M}$, and due to the non-negativity constraint, it is obvious that the optimal ex-post-loss reserve $K_{12}^*(\mathbf{M}^*) = K_{21}^*(\mathbf{M}^*) = 0$, regardless of the

optimal ex-ante investment \mathbf{M}^* .

We assume that the manager either, invests a fixed amount \overline{M}_j , or does not allocate any investment, to the cybersecurity control C_j , in addition to the industry-average level, for the vulnerability V_j , for $j = 1, 2, \dots, m$. As a result, if $M = \overline{M}_j$, the losses due to V_j are scaled by $\theta_j \in (0, 1)$, *i.e.*, the j -th vulnerability is partially, but not fully, patched; if $M = 0$, the V_j is only guarded by the industry-standard control, and thus $\theta_j = 1$ that the Company X shall experience full impact from the raw losses due to V_j for its vulnerable cyber system. Therefore, the set of admissible investment allocation $\mathcal{M} = \{0, \overline{M}_1\} \times \{0, \overline{M}_2\} \times \{0, \overline{M}_3\}$, where \times represents the Cartesian product herein; and thus, there are eight possible investment allocations \mathbf{M}_p , for $p = 1, 2, \dots, 8$, with the corresponding eight possible cybersecurity control vectors $\boldsymbol{\theta}_p$, which in turn affects the distribution of the impacts via (14), as well as that of the aggregate losses $S(\mathbf{M}_p)$, $S_{11}(\mathbf{M}_p)$, and $S_{22}(\mathbf{M}_p)$.

As mentioned in Section 3.3, the optimal ex-post-loss reserves $K_{11}^*(\mathbf{M}_p)$ and $K_{22}^*(\mathbf{M}_p)$ shall first be solved for each investment allocation \mathbf{M}_p , for $p = 1, 2, \dots, 8$; and the optimal ex-ante investment $\mathbf{M}^* \in \mathcal{M}$ shall then be solved by minimizing the sum of the residual cost of reserve in (12) and the cost of cybersecurity investment in (13), among the eight possible investment allocations. The weighted penalty functions for deviances at individual threat-asset pairs and the aggregate deviance are chosen to be

$$h_{ik}(S_{ik}(\mathbf{M})) = \frac{\mathbb{1}_{\{S_{ik}(\mathbf{M}) > \text{VaR}_{0.9}(S_{ik}(\mathbf{M}))\}}}{\mathbb{P}(S_{ik}(\mathbf{M}) > \text{VaR}_{0.9}(S_{ik}(\mathbf{M})))},$$

for $i = 1, 2$ and $k = 1, 2$, and

$$h(S(\mathbf{M})) = \frac{\mathbb{1}_{\{S(\mathbf{M}) > \text{VaR}_{0.9}(S(\mathbf{M}))\}}}{\mathbb{P}(S(\mathbf{M}) > \text{VaR}_{0.9}(S(\mathbf{M})))},$$

respectively, where $\text{VaR}_{0.9}(\cdot)$ is the Value-at-Risk of a random variable measured at confidence level of 90%. Correspondingly, the reserve that minimizes the weighted expected deviance is measured by the Tail Value-of-Risk at the same confidence level. Moreover, the following are the parameters for cybersecurity investment and control in this case study: $\overline{M}_1 = 2 \times 10^6$ (\$2 Million), $\overline{M}_2 = 10^7$ (\$10 Million), $\overline{M}_3 = 10^6$ (\$1 Million), and $\theta_1 = \theta_2 = \theta_3 = 0.2$. The relative importance weights $\eta_j, \nu_{ik}, \omega_{ik}^I, \eta, \nu$, and ω^I are set as 1; that is, all objectives are equally important.

In the following, we explain a practical choice for the unit-exchange weights, ω_{ik}^E and ω^E . At the optimality, the marginal decrease of the unit-exchanged weighted expected deviance, $\omega^E \mathbb{E}[(S(\mathbf{M}) - K)^2 h(S(\mathbf{M}))]$, coincides with the marginal increase of the opportunity cost of ex-post-loss reserve, K , and thus deduces a reasonable unit-exchange weight. However, the optimal ex-post-loss reserve is *not known a priori* when the unit-exchange weight is set. Hence, we propose to set the weight by equating the *average* marginal decrease of the unit-exchanged weighted expected deviance with the (*average*) marginal increase of the opportunity cost of ex-post-loss reserve, K . The average is taken at two extreme ex-post-loss reserve allocations; the first one is zero reserve, which is derived when only the objective of opportunity cost is considered; the second one is the optimal standalone reserve $\hat{K} := \mathbb{E}[S(\mathbf{M})h(S(\mathbf{M}))]$, which is derived when only the objective of unit-exchanged weighted

expected deviance is considered. See Figure 7 for its pictorial illustration. Therefore,

$$\frac{\omega^E \mathbb{E}[(S(\mathbf{M}) - 0)^2 h(S(\mathbf{M}))] - \omega^E \mathbb{E}[(S(\mathbf{M}) - \hat{K})^2 h(S(\mathbf{M}))]}{\hat{K} - 0} = 1,$$

which yields $\omega^E = \frac{1}{\mathbb{E}[S(\mathbf{M})h(S(\mathbf{M}))]}$. Similarly, we propose that, for $i = 1, 2$ and $k = 1, 2$, $\omega_{ik}^E = \frac{1}{\mathbb{E}[S_{ik}(\mathbf{M})h_{ik}(S_{ik}(\mathbf{M}))]}$.

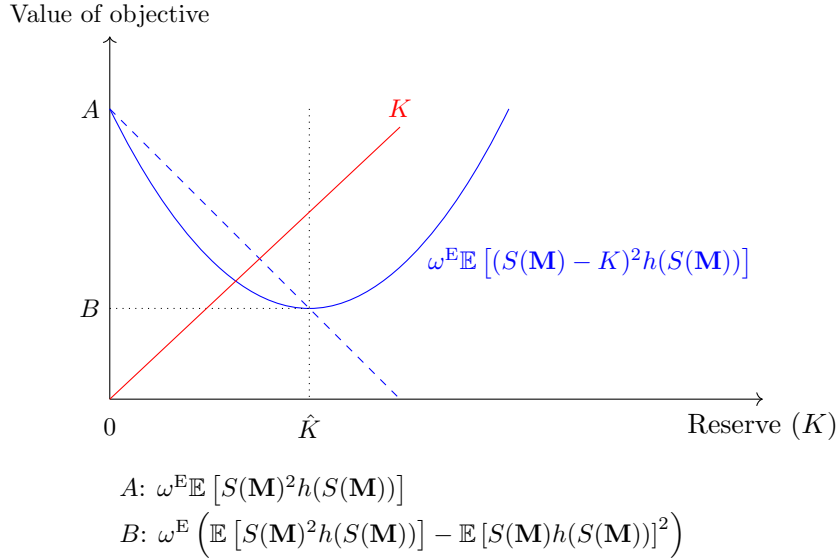

Figure 7: Equating average marginal changes of objectives to determine unit-exchange weight

Table 5 summarizes the findings. Therein, each row shows the corresponding investment allocations, cybersecurity controls, and the optimal reserves for the threat-asset pairs (T1,A1) and (T2,A2), as well as the residual cost of reserve and the cost of cybersecurity investment. The highlighted column indicates the case with the optimal ex-ante investments which minimize the sum of the two costs; in this case, the first and third vulnerabilities of the Company X are additionally patched while the second one is left as being guarded only by an industry-average control.

To understand this result, we shall consider the following two questions: 1) why should the company make investments to patch V1 and V3? 2) why should the company not invest in mitigating V2?

For the first question, given the cascade model, it is easy to see that V3 is the only link between T1 and A1, and therefore, mitigating V3 results in a significant reduction in the loss on the threat-asset pair (T1, A1). That further cuts the optimal reserve allocated on that pair by more than 50%, from around \$1.5 million (see $\tilde{K}_{11}^*(\mathbf{M}_p)$, for $p = 1, 2, 3, 4$) to near \$0.7 million (see $\tilde{K}_{11}^*(\mathbf{M}_p)$, for $p = 5, 6, 7, 8$). Suggested by the comparison between a strategy that has a non-zero M_3^p and the one that does not, *e.g.*, \mathbf{M}_5 and \mathbf{M}_1 , The overall benefit of investing in V3, in terms of the reduction in weighted reserves and weighted expected deviances, is $g_r(\mathbf{M}_1) - g_r(\mathbf{M}_5) = 5.19$, whereas the increase in weighted costs of cybersecurity investment is only $g_c(\mathbf{M}_5) - g_c(\mathbf{M}_1) = 2$.

Ex-Ente Investment Allocations	\mathbf{M}_p	\mathbf{M}_1	\mathbf{M}_2	\mathbf{M}_3	\mathbf{M}_4	\mathbf{M}_5	\mathbf{M}_6	\mathbf{M}_7	\mathbf{M}_8
Investment	M_1^p	0.00	2.00	0.00	2.00	0.00	2.00	0.00	2.00
Breakdown	M_2^p	0.00	0.00	10.00	10.00	0.00	0.00	10.00	10.00
(in millions)	M_3^p	0.00	0.00	0.00	0.00	1.00	1.00	1.00	1.00
Cybersecurity	θ_1^p	1.00	0.20	1.00	0.20	1.00	0.20	1.00	0.20
Controls	θ_2^p	1.00	1.00	0.20	0.20	1.00	1.00	0.20	0.20
	θ_3^p	1.00	1.00	1.00	1.00	0.20	0.20	0.20	0.20
Constrained	$\tilde{K}_{11}^*(\mathbf{M}_p)$	1.49	1.53	1.51	1.53	0.73	0.74	0.73	0.73
Optimal Ex-Post	$\tilde{K}_{12}^*(\mathbf{M}_p)$	0.00	0.00	0.00	0.00	0.00	0.00	0.00	0.00
Reserves	$\tilde{K}_{21}^*(\mathbf{M}_p)$	0.00	0.00	0.00	0.00	0.00	0.00	0.00	0.00
(in millions)	$\tilde{K}_{22}^*(\mathbf{M}_p)$	8.64	6.94	8.62	4.47	9.19	7.21	9.09	4.63
Cost Function	$g_c(\mathbf{M}_p)$	0.00	4.00	20.00	24.00	2.00	6.00	22.00	26.00
Values	$g_r(\mathbf{M}_p)$	69.61	52.99	64.56	44.40	64.42	47.82	59.44	38.63
(in millions)	$g_c(\mathbf{M}_p) + g_r(\mathbf{M}_p)$	69.61	56.99	84.56	68.40	66.42	53.82	81.44	64.63

Table 5: Comparison between different investment and capital allocation strategies.

Since the benefit outweighs the cost, investing in V3 is a rational business decision when reserves are allocated following the holistic principle.

In contrast, for the loss on threat-asset pair (T2, A2), two paths can cause such an impact via vulnerability V1 and V2, and the magnitudes of their raw impacts are comparable (see Table 2). Therefore, patching either of them only contributes to a fractional decrease in the required reserve on (T2, A2). For example, $1 - \frac{\tilde{K}_{22}^*(\mathbf{M}_6)}{\tilde{K}_{22}^*(\mathbf{M}_5)} = 26.4\%$ and $1 - \frac{\tilde{K}_{22}^*(\mathbf{M}_7)}{\tilde{K}_{22}^*(\mathbf{M}_5)} = 7.1\%$, which are both much smaller than the aforementioned 50%. The optimal reserve on that threat-asset pair is only significantly reduced when both V1 and V2 are mitigated (see $\tilde{K}_{22}^*(\mathbf{M}_8)$). However, by following the cost-benefit analysis as previously done for V3, we observe that only investing in V1 generates sufficient reduction in residual cost of reserve $g_r(\mathbf{M}_5) - g_r(\mathbf{M}_6) = 13.6$ to cover the additional cost in cybersecurity investment $g_c(\mathbf{M}_6 - g_c(\mathbf{M}_5)) = 4$, and that is not the case when investment is made for only V2 or both V and V2, given that \overline{M}_2 the cost of implementing the control of V2 is extraordinarily high, and that answers why Company X should not invest in V2.

In sum, Table 5, as a final result yielded by the proposed framework in this paper, offers business decision makers an intuitive and effective way to compare between different cybersecurity investment and reserve allocation strategies.

5 Concluding Remarks and Future Directions

In this paper, a cyber cascade model has been proposed for cyber risk assessment and capital management. Classical actuarial and economic models of cyber risks often focus on data trend analysis and do not capture distinct features of cyber risk from other risks. In contrast, engineering literature tends to offer microscopic examination of cyber risks, such as attack graphs, which makes

it difficult to measure financial impact at a macro level. The model presented in this paper utilizes structural properties of cybersecurity to analyze the cyber risk, through the interactions of threat, vulnerability, control, asset, resulting in financial impact. As an application, we develop capital allocation scheme in both ex-ante investment and ex-post-loss reserve. To deal with the trade-off between cybersecurity investment and weathering reserve, as well as to balance the classical competing interests and priorities in enterprise risk management, the optimal ex-ante investment and ex-post-loss reserve allocations are solved via the holistic approach. We particularly shed light on the cost-and-benefit analysis between cybersecurity investment and reduction of after-reserve residual risk in this paper.

Several parts of this paper could be further studied. First, we assume that financial losses due to a vulnerability can be linearly reduced by implementing a control. It is possible in practice that the control does not scale down the losses but increases the probability of zero loss; in this case, the loss tensor is no longer an element-wise multiplication of the cascade model tensor and the raw loss tensor. But rather one needs to modify the impact with point mass at zero loss. Second, the case study in this paper is based on the publicly acquirable dataset developed and maintained by the Advisen Ltd. which could not reveal sensitive information of victim companies like internal configuration for vulnerabilities, implemented controls, and assets, as well as external exposure for threats. Therefore, we make disputable assumptions for illustrative purposes of the case study. To overcome this, one shall team up with industry partners to implement the proposed cyber risk assessment and capital management framework in a case-by-case basis.

References

- Alderson, David L., Gerald G. Brown, and William M. Carlyle (2014). “Assessing and Improving Operational Resilience of Critical Infrastructures and Other Systems”. *Bridging Data and Decisions*. INFORMS, pp. 180–215.
- Arx Nimbus, LLC. (2021). *The 2021 Digital Risk Checklist*. URL: <https://www.arxnimbus.com/cyber-security-risk-whitepaper-download>.
- August, Terrence and Tunay I. Tunca (2006). “Network Software Security and User Incentives”. *Management Science* 52.11, pp. 1703–1720.
- Böhme, Rainer and Gaurav Kataria (2006). “Models and Measures for Correlation in Cyber-Insurance”. *5th Annual Workshop on the Economics of Information Security, WEIS 2006*. URL: <http://weis2006.econinfosec.org/docs/16.pdf>.
- Böhme, Rainer, Stefan Laube, and Markus Riek (2019). “A Fundamental Approach to Cyber Risk Analysis”. *Variance* 12.2, pp. 161–185.
- Cavusoglu, Hasan, Huseyin Cavusoglu, and Jun Zhang (2008). “Security Patch Management: Share the Burden or Share the Damage?” *Management Science* 54.4, pp. 657–670.
- Cavusoglu, Huseyin, Birendra Mishra, and Srinivasan Raghunathan (2004). “The Effect of Internet Security Breach Announcements on Market Value: Capital Market Reactions for Breached Firms and Internet Security Developers”. *International Journal of Electronic Commerce* 9.1, pp. 70–104.
- Cebula, James L. and Lisa R. Young (2010). *A Taxonomy of Operational Cyber Security Risks*. Tech. rep. Carnegie-Mellon Univ Pittsburgh Pa Software Engineering Inst.
- Chen, Chang-Chih, Chia-Chien Chang, and Min-The Yu (2021a). “Cyber Risks and Cyber Insurance Valuation”. *Working Paper*.
- Chen, Xiaowei, Wing Fung Chong, Runhuan Feng, and Linfeng Zhang (2021b). “Pandemic Risk Management: Resources Contingency Planning and Allocation”. *Insurance: Mathematics and Economics* 101B, pp. 359–383.
- Chong, Wing Fung, Runhuan Feng, and Longhao Jin (2021). “Holistic Principle for Risk Aggregation and Capital Allocation”. *Annals of Operations Research*.
- CIS (2021). *CIS Controls*. Center for Internet Security, Inc. URL: <https://learn.cisecurity.org/cis-controls-download>.
- Dhaene, Jan, Andreas Tsanakas, Emiliano A. Valdez, and Steven Vanduffel (2012). “Optimal Capital Allocation Principles”. *Journal of Risk and Insurance* 79.1, pp. 1–28.
- DiMase, Daniel, Zachary A. Collier, Kenneth Heffner, and Igor Linkov (2015). “Systems Engineering Framework for Cyber Physical Security and Resilience”. *Environment Systems and Decisions* 35.2, pp. 291–300.
- Eling, Martin and Kwangmin Jung (2018). “Copula Approaches for Modeling Cross-sectional Dependence of Data Breach Losses”. *Insurance: Mathematics and Economics* 82, pp. 167–180.
- Eling, Martin and Jan Wirfs (2019). “What Are the Actual Costs of Cyber Risk Events?” *European Journal of Operational Research* 272.3, pp. 1109–1119.

- Frustaci, Mario, Pasquale Pace, Gianluca Aloï, and Giancarlo Fortino (2018). “Evaluating Critical Security Issues of the IoT World: Present and Future Challenges”. *IEEE Internet of Things Journal* 5.4, pp. 2483–2495.
- Furman, Edward and Ričardas Zitìkis (2008). “Weighted Risk Capital Allocations”. *Insurance: Mathematics and Economics* 43.2, pp. 263–269.
- Gordon, Lawrence A. and Martin P. Loeb (2002). “The Economics of Information Security Investment”. *ACM Transactions on Information and System Security* 5.4, pp. 438–457.
- Gordon, Lawrence A., Martin P. Loeb, William Lucyshyn, and Lei Zhou (2015). “Increasing Cybersecurity Investments in Private Sector Firms”. *Journal of Cybersecurity* 1.1, pp. 3–17.
- Gordon, Lawrence A., Martin P. Loeb, and Lei Zhou (2016). “Investing in Cybersecurity: Insights from the Gordon-Loeb Model”. *Journal of Information Security* 07.2, pp. 49–59.
- Hartford Steam Boiler (2017). *HSB CyberOne™ Coverage*. URL: https://www.munichre.com/content/dam/munichre/contentlounge/website-pieces/documents/CyberOne_HSB.pdf/_jcr_content/renditions/original./CyberOne_HSB.pdf.
- Janvry, Alain de and Elisabeth Sadoulet (2006). “Optimal Share Contracts with Moral Hazard on Effort and in Output Reporting: Managing the Double Laffer Curve Effect”. *Oxford Economic Papers* 59.2, pp. 253–274.
- Kesan, Jay P. and Linfeng Zhang (2020). “Analysis of Cyber Incident Categories Based on Losses”. *ACM Transactions on Management Information Systems* 11.4, pp. 1–28.
- Li, Ling, Wu He, Li Xu, Ivan Ash, Mohd Anwar, and Xiaohong Yuan (2019). “Investigating the Impact of Cybersecurity Policy Awareness on Employees’ Cybersecurity Behavior”. *International Journal of Information Management* 45, pp. 13–24.
- Liu, Zhaoxi, Wei Wei, Lingfeng Wang, Chee-Wooi Ten, and Yeonwoo Rho (2020). “An Actuarial Framework for Power System Reliability Considering Cybersecurity Threats”. *IEEE Transactions on Power Systems*.
- NERC (2008). *Critical Infrastructure Protection Standards*. North American Electric Reliability Corporation. URL: <https://www.nerc.com/pa/Stand/Pages/CIPStandards.aspx>.
- NIST (2013). *Security and Privacy Controls for Federal Information Systems and Organizations*. Tech. rep.
- (2018). *Framework for Improving Critical Infrastructure Cybersecurity*. National Institute of Standards and Technology. URL: <https://nvlpubs.nist.gov/nistpubs/CSWP/NIST.CSWP.04162018.pdf>.
- Panjer, Harry H. (1981). “Recursive Evaluation of a Family of Compound Distributions”. *ASTIN Bulletin* 12.1, pp. 22–26.
- Parkinson, Simon, Paul Ward, Kyle Wilson, and Jonathan Miller (2017). “Cyber Threats Facing Autonomous and Connected Vehicles: Future Challenges”. *IEEE Transactions on Intelligent Transportation Systems* 18.11, pp. 2898–2915.
- Pfleeger, Shari Lawrence and Robert K. Cunningham (2010). “Why Measuring Security Is Hard”. *IEEE Security & Privacy Magazine* 8.4, pp. 46–54.

- Rowe, Brent R. and Michael P. Gallaher (2006). “Private Sector Cyber Security Investment: An Empirical Analysis”. *5th Annual Workshop on the Economics of Information Security, WEIS 2006*.
- Ruan, Keyun (2019). “The Point of Diminishing Return on Cyber Risk Investment”. *Digital Asset Valuation and Cyber Risk Management*. Elsevier, pp. 99–115.
- SANS Institute (2013). *Mapping the Critical Security Controls (CSC) v4.0 to the Verizon VERIS 2013 Threats - Executive Summary*. URL: https://www.sans.org/media/critical-security-controls/critical_security_controls_v4.0.pdf.
- Smeraldi, Fabrizio and Pasquale Malacaria (2014). “How to Spend It: Optimal Investment for Cyber Security”. *Proceedings of the 1st International Workshop on Agents and CyberSecurity*. ACM Press.
- Tatar, Unal, Omer Keskin, Hayretidin Bahsi, and Cesar A. Pinto (2020). *Quantification of Cyber Risk for Actuaries: An Economic-Functional Approach*. Society of Actuaries. URL: <https://www.soa.org/globalassets/assets/files/resources/research-report/2020/quantification-cyber-risk.pdf>.
- Tragler, Gernot, Jonathan P. Caulkins, and Gustav Feichtinger (2001). “Optimal Dynamic Allocation of Treatment and Enforcement in Illicit Drug Control”. *Operations Research* 49.3, pp. 352–362.
- University of Oxford and Axis (2020). *White Paper: Calculating Residual Cyber-risk*. University of Oxford and Axis. URL: <https://www.cs.ox.ac.uk/projects/ACVAR/White%20Paper%20-%20Calculating%20residual%20cyber-risk.pdf>.
- Verizon Security Research & Cyber Intelligence Center (2021). *Vocabulary for Event Recording and Incident Sharing (VERIS)*. URL: <https://github.com/vz-risk/veris>.
- Wang, Wenye and Zhuo Lu (2013). “Cyber Security in the Smart Grid: Survey and Challenges”. *Computer Networks* 57.5, pp. 1344–1371.
- Wanniski, Jude (1978). “Taxes, Revenues, and the Laffer Curve”. *The Public Interest* 50, pp. 3–16.
- Xu, Maochao, Kristin M. Schweitzer, Raymond M. Bateman, and Shouhuai Xu (2018). “Modeling and Predicting Cyber Hacking Breaches”. *IEEE Transactions on Information Forensics and Security* 13.11, pp. 2856–2871.

Appendix A Mapping Relationship between Control and Asset

Control Name	Assets			
	Devices	Applications	Users	Data
1. Inventory and Control of Hardware Assets	1			
2. Inventory and Control of Software Assets		1		
3. Continuous Vulnerability Management		1	1	
4. Controlled Use of Administrative Privileges		1	1	
5. Secure Configuration for Hardware and Software on Mobile Devices, Laptops, Workstations and Servers				1
6. Maintenance, Monitoring and Analysis of Audit Logs		1	1	1
7. Email and Web Browser Protections	1			
8. Malware Defenses	1			
9. Limitation and Control of Network Ports, Protocols and Services				1
10. Data Recovery Capabilities				
11. Secure Configuration for Network Devices, such as Firewalls, Routers and Switches	1		1	1
12. Boundary Defense				
13. Data Protection				1
14. Controlled Access Based on the Need to Know				1
15. Wireless Access Control	1		1	1
16. Account Monitoring and Control				
17. Implement a Security Awareness and Training Program			1	
18. Application Software Security			1	
19. Incident Response and Management	1	1		1
20. Penetration Tests and Red Team Exercises				

Table 6: Controls and assets defined in the CIS Controls. Value 1 represents that the control mitigates the vulnerability in the corresponding asset. A blank cell means there is no relationship between the control and the asset.

Appendix B Mapping Relationship between Threat and Control

Threats	CIS Controls																			
	1	2	3	4	5	6	7	8	9	10	11	12	13	14	15	16	17	18	19	20
Tampering (alter physical form or function)	1		1																	
Backdoor (enable remote access)	1	1	1	1	1						1	1		1						
Use of stolen authentication credentials										1										
Export data to another site or system																				1
Use of Backdoor or C2 channel	1	1	1	1	1						1	1								
Phishing (or any type of *ishing)	1	1	1	1	1						1	1								
Command and control (C2)	1	1	1	1	1						1	1								
Downloader (pull updates or other malware)																				
Brute force or password guessing attacks																				
Spyware, keylogger or form-grabber (capture user input or activity)	1	1	1	1	1						1	1								
Capture data stored on system disk																				1
System or network utilities (e.g., PsTools, Netcat)	1	1	1	1	1						1	1								
Abuse of system access privileges																				
Ram scraper or memory parser (capture data from volatile memory)	1	1	1	1	1						1	1								1
Use of unapproved hardware or devices																				
SQL injection																				
Embezzlement, skimming, and related fraud																				
Theft (taking assets without permission)	1																			1
Bribery or solicitation																				
Disable or interfere with security controls																				
Password dumper (extract credential hashes)	1	1	1	1	1						1	1								
Misconfiguration																				
Programming error (flaws or bugs in custom code)																				
Misdelivery (direct or deliver to wrong recipient)																				
Loss or misplacement	1																			1
																				1

Table 7: The mapping between threats and CIS Controls from SANS Institute (2013).