

NECESSARY AND SUFFICIENT CONDITIONS FOR MINIMIZERS IN ONE-DIMENSIONAL PROBLEMS WITH NATURAL BOUNDARY CONDITIONS

PAVOL QUITTNER

Department of Applied Mathematics and Statistics, Comenius University
Mlynská dolina, 84248 Bratislava, Slovakia
email: quittner@fmph.uniba.sk

ABSTRACT. This paper deals with necessary and sufficient conditions for weak and strong minimizers of functionals $\Phi(u) = \int_a^b f(x, u(x), u'(x)) dx$, where $u \in C^1([a, b], \mathbb{R}^N)$. Such conditions (based on the Jacobi theory or the Weierstrass field of extremals) are well known in the case of fixed boundary conditions at $x = a$ and/or $x = b$. We prove that analogous conditions are true also in the case, when one considers natural boundary conditions both at $x = a$ and $x = b$ (for some or all components u_i of $u = (u_1, \dots, u_N)$). In addition, we provide several interesting examples which show how our conditions can be verified. In particular, we also solve some open problems in [A. Majumdar, A. Raisch: Stability of twisted rods, helices and buckling solutions in three dimensions, *Nonlinearity* 27 (2014), 2841–2867] by finding optimal necessary and sufficient conditions for the stability of a naturally straight Kirchhoff rod under mixed or Neumann boundary conditions.

Keywords. Minimizer, natural boundary conditions, conjugate points, field of extremals, stability, elastica

AMS Classification. 49K05, 74K10, 74G65, 34B15

1. INTRODUCTION

This paper deals with necessary and sufficient conditions for weak and strong¹ (local) minimizers of one-dimensional problems with natural or mixed boundary conditions. We consider the functional

$$\Phi : C^1([a, b], \mathbb{R}^N) \rightarrow \mathbb{R} : u \mapsto \int_a^b f(x, u(x), u'(x)) dx,$$

where $-\infty < a < b < \infty$, $u = (u_1, u_2, \dots, u_N)$, and the Lagrangian²

$$f : [a, b] \times \mathbb{R}^N \times \mathbb{R}^N \rightarrow \mathbb{R} : (x, u, p) \mapsto f(x, u, p)$$

is sufficiently smooth ($f \in C^3$ or $f \in C^2$). We also we fix a C^1 function $u^0 : [a, b] \rightarrow \mathbb{R}^N$, and, denoting

$$g^0(x) := g(x, u^0(x), (u^0)'(x)) \quad \text{with } g \in \{f, f_x, f_{u_i}, f_{p_i}, f_{p_i p_j}, \dots\},$$

Supported in part by the Slovak Research and Development Agency under the contract No. APVV-18-0308 and by VEGA grant 1/0339/21.

¹See Definition 6 for the definition of weak and strong minimizers.

²By u we denote both functions $[a, b] \rightarrow \mathbb{R}^N$ and the independent variable in \mathbb{R}^N .

we often assume that there exists $c^0 > 0$ such that

$$\sum_{i,j=1}^N f_{p_i p_j}^0(x) \xi_i \xi_j \geq c^0 |\xi|^2, \quad \xi \in \mathbb{R}^N, x \in [a, b]. \quad (1)$$

Finally, we fix (possibly empty) sets $I_a^{\mathcal{D}}, I_b^{\mathcal{D}} \subset I := \{1, 2, \dots, N\}$, set $I_x^{\mathcal{N}} := I \setminus I_x^{\mathcal{D}}$ for $x \in \{a, b\}$, and we assume that u^0 is a critical point of Φ in the set $u^0 + C_{\mathcal{D}}^1$, where

$$C_{\mathcal{D}}^1 := \{v \in C^1([a, b], \mathbb{R}^N) : v_i(a) = 0 \text{ for } i \in I_a^{\mathcal{D}}, v_i(b) = 0 \text{ for } i \in I_b^{\mathcal{D}}\}, \quad (2)$$

i.e. $\Phi'(u^0)h = 0$ for any $h \in C_{\mathcal{D}}^1$, where Φ' denotes the Fréchet derivative of Φ . It is well known that if $f \in C^1$, then such critical point u^0 is an extremal, i.e. it satisfies the Euler equations $\frac{d}{dx}(f_{p_i}^0) = f_{u_i}^0$, $i = 1, 2, \dots, N$, and u^0 also has to satisfy the natural boundary conditions

$$f_{p_i}^0(a) = 0 \text{ for } i \in I_a^{\mathcal{N}} \quad \text{and} \quad f_{p_i}^0(b) = 0 \text{ for } i \in I_b^{\mathcal{N}}. \quad (3)$$

In addition, if $k \geq 2$ and $f \in C^k$ satisfies (1), then $u^0 \in C^k$, see Theorem 9.

If $I_a^{\mathcal{N}} = I_b^{\mathcal{N}} = \emptyset$, i.e. if one considers the Dirichlet (fixed) boundary conditions, then necessary and sufficient conditions for u^0 to be a minimizer belong to the classical results in the calculus of variations, see [9, 7, 10], for example. They are based on the Jacobi theory (conjugate points) and the Weierstrass field of extremals, and some of them are also known if either $I_a^{\mathcal{N}} = \emptyset$ or $I_b^{\mathcal{N}} = \emptyset$ (see [1, 11] and the references therein). On the other hand, if both $I_a^{\mathcal{N}}, I_b^{\mathcal{N}}$ are nonempty, then a satisfactory theory seems to be missing. This has already been observed in [14], where the author considered the scalar case $N = 1$, a very special class of Lagrangians (in particular, his natural boundary conditions are of the form $u'(a) = u'(b) = 0$) and derived rather complicated necessary and sufficient conditions for weak minimizers. It is well known that if $N = 1$ and $I_a^{\mathcal{N}} = I_b^{\mathcal{N}} = \emptyset$, then necessary and sufficient conditions for weak minimizers are equivalent to the nonexistence of conjugate points of a nontrivial solution h of the Jacobi equation. The author of [14] considered the conjugate points of the derivative h' , but then the desired conditions require the computation of an index at each conjugate point and just the sum of those indices can determine the fact whether u^0 is a weak minimizer. The reference [14] has been cited by many papers: Some of the citing papers use the complicated theory in [14] for scalar problems with special Lagrangians (see [12], for example), some use various ad-hoc estimates to obtain at least partial results in the vector-valued case (when the theory in [14] does not seem to apply, see [13], for example) and some refrain from considering the natural boundary conditions because of the complexity of the theory in [14], see [5], for example, where the authors write: "... the application of the conjugate point test with nonclamped ends is a delicate issue ...".

The main purpose of this paper is to show that the classical necessary and sufficient conditions for weak and strong minimizers in the case $I_a^{\mathcal{N}} = I_b^{\mathcal{N}} = \emptyset$ have their full analogues also for general $I_a^{\mathcal{N}}, I_b^{\mathcal{N}}$. In addition, we provide several interesting examples which show how those conditions can be verified. In particular, we also solve some open problems in [13] by finding optimal necessary and sufficient conditions for the stability of a naturally straight Kirchhoff rod under mixed or Neumann boundary conditions.

2. MAIN RESULTS

To describe our results in detail, let us first introduce some notation. Assuming that

$$f \in C^3 \text{ satisfies (1), where } u^0 \in C^1([a, b], \mathbb{R}^N) \text{ is an extremal satisfying (3),} \quad (4)$$

and denoting $\sum_k = \sum_{k=1}^N$, we set

$$\Psi(h) := \int_a^b \sum_{i,j} \left(f_{p_i p_j}^0 h_i' h_j' + f_{p_i u_j}^0 h_i' h_j + f_{u_i p_j}^0 h_i h_j' + f_{u_i u_j}^0 h_i h_j \right) dx, \quad h \in W^{1,2}([a, b], \mathbb{R}^N).$$

If $h \in C^1$, then $\Psi(h) = \Phi''(u^0)(h, h)$. In addition, if $h \in C^2$, then

$$\Psi(h) = \int_a^b \sum_i (\mathcal{A}_i h) h_i dx + \sum_i (\mathcal{B}_i h) h_i \Big|_a^b,$$

where

$$\mathcal{B}_i h := \sum_j \left(f_{p_i p_j}^0 h_j' + f_{p_i u_j}^0 h_j \right) \quad \text{and} \quad \mathcal{A}_i h := -\frac{d}{dx} (\mathcal{B}_i h) + \sum_j \left(f_{u_i p_j}^0 h_j' + f_{u_i u_j}^0 h_j \right).$$

Set also $B_\varepsilon := \{\xi \in \mathbb{R}^N : |\xi| < \varepsilon\}$, $\mathcal{A}h := (\mathcal{A}_1 h, \dots, \mathcal{A}_N h)$, $\mathcal{B}h := (\mathcal{B}_1 h, \dots, \mathcal{B}_N h)$, $f_p := (f_{p_1}, \dots, f_{p_N})$, $f_u = (f_{u_1}, \dots, f_{u_N})$. Finally, if $x \in \{a, b\}$, then we set $\mathbb{R}_{\mathcal{D},x}^N := \{\xi \in \mathbb{R}^N : \xi_i = 0 \text{ for } i \in I_x^{\mathcal{D}}\}$ and $\mathbb{R}_{\mathcal{N},x}^N := \{\xi \in \mathbb{R}^N : \xi_i = 0 \text{ for } i \in I_x^{\mathcal{N}}\}$, and if W is a space of functions $[a, b] \rightarrow \mathbb{R}^N$, then $W_{\mathcal{D},x} := \{v \in W : v(x) \in \mathbb{R}_{\mathcal{D},x}^N\}$ and $W_{\mathcal{D}} := W_{\mathcal{D},a} \cap W_{\mathcal{D},b}$. Notice that the last notation coincides with that in (2) if $W = C^1$.

Consider weak (local) minimizers in the scalar case first. Assume that

$$h \text{ is a nontrivial solution of the Jacobi equation } \mathcal{A}h = 0. \quad (5)$$

Then the following result for problems with fixed boundary conditions is well known.

Theorem 1. *Assume (4) with $N = 1$ and (5). Let $I_a^{\mathcal{N}} = I_b^{\mathcal{N}} = \emptyset$ and $h(a) = 0$.*

- (i) *If $h(y) = 0$ for some $y \in (a, b)$, then u^0 is not a weak minimizer.*
- (ii) *If $h(y) \neq 0$ for any $y \in (a, b)$, then u^0 is a weak minimizer.*

Our analogue in the case of natural boundary conditions is the following theorem.

Theorem 2. *Assume (4) with $N = 1$ and (5). Let $I_a^{\mathcal{N}} = I_b^{\mathcal{N}} = \{1\}$ and $\mathcal{B}h(a) = 0$.*

- (i) *If $h(y) = 0$ for some $y \in (a, b]$ or $\mathcal{B}h(b)h(b) < 0$, then u^0 is not a weak minimizer.*
- (ii) *If $h(y) \neq 0$ for any $y \in (a, b]$ and $\mathcal{B}h(b)h(b) > 0$, then u^0 is a weak minimizer.*

The condition $\mathcal{B}h(a) = 0$ in Theorem 2(ii) can be replaced with $\mathcal{B}h(a)h(a) \leq 0$, see Theorem 11. Theorem 2 is a special case of the following general theorem.

Theorem 3. *Assume (4). Let $h^{(1)}, \dots, h^{(N)}$ be linearly independent solutions of the Jacobi equation $\mathcal{A}h = 0$ satisfying the initial conditions $h(a) \in \mathbb{R}_{\mathcal{D},a}^N$, $\mathcal{B}h(a) \in \mathbb{R}_{\mathcal{N},a}^N$. Set $D(x) := \det(h^{(1)}(x), \dots, h^{(N)}(x))$, $H := \text{span}(h^{(1)}, \dots, h^{(N)})$ and $H_0 := \{h \in H : h(b) = 0\}$.*

- (i) *If $D(x) = 0$ for some $x \in (a, b)$ or*

$$I_b^{\mathcal{N}} \neq \emptyset \quad \text{and} \quad \mathcal{B}h(b) \cdot h(b) < 0 \text{ for some } h \in H_{\mathcal{D},b},$$

then u^0 is not a weak minimizer.

(ii) If $D > 0$ in $(a, b]$ and

$$\text{either } I_b^N = \emptyset \text{ or } \mathcal{B}h(b) \cdot h(b) > 0 \text{ for any } h \in H_{\mathcal{D},b} \setminus \{0\},$$

then u^0 is a weak minimizer.

(iii) Let $D > 0$ in (a, b) , $D(b) = 0$ (hence $H_0 \neq \{0\}$), and $I_b^N \neq \emptyset$. If

$$\text{there exists } h \in H_0 \text{ such that } \mathcal{B}_i h(b) \neq 0 \text{ for some } i \in I_b^N, \quad (6)$$

then u^0 is not a weak minimizer. If $I_b^D = \emptyset$, then (6) is always true.

Remark 4. (i) The proof of Theorem 3 shows that the conditions in Theorem 3 guaranteeing that u_0 is or is not a minimizer imply that the functional Ψ is positive definite in $W_{\mathcal{D}}^{1,2}$ or there exists $h \in W_{\mathcal{D}}^{1,2}$ such that $\Psi(h) < 0$, respectively. If Ψ is positive semidefinite but not positive definite, then there exists $h^* \in W_{\mathcal{D}}^{1,2} \setminus \{0\}$ such that $0 = \Psi(h^*) = \inf_{W_{\mathcal{D}}^{1,2}} \Psi$ and h^* can be determined from our analysis. For example, if $N = 1$ and $I_a^D = I_b^D = \emptyset$ (cf. Theorem 2), then h^* is a positive (or negative) solution of the Jacobi equation satisfying $\mathcal{B}h^*(a) = \mathcal{B}h^*(b) = 0$. If Φ depends smoothly on a parameter θ , u^0 is a critical point of Φ for any θ , and u^0 is (or is not, respectively) a weak minimizer for $\theta > \theta^*$ (or $\theta < \theta^*$, respectively), then the critical parameter θ^* corresponds to the case where h^* exists. (Such situation occurs, for example, in the study of stability of a twisted rod in Section 7.) In this case one can expect bifurcation for the problem $\Phi'(u) = 0$ at $\theta = \theta^*$ in the direction of h^* , cf. [8, Theorem 5.6].

(ii) Let $h^{(k)}$, $k = 1, 2, \dots, N$, be as in Theorem 3, $\xi \in \mathbb{R}^N$ and $h^\xi := \sum_k \xi_k h^{(k)}$. Set $A := (a_{kl})_{k,l=1}^N$, where $a_{kl} = \mathcal{B}h^{(k)}(b) \cdot h^{(l)}(b)$, and

$$\Xi_{\mathcal{D}} := \{\xi \in \mathbb{R}^N : h^\xi(b) \in \mathbb{R}_{\mathcal{D},b}^N\}.$$

Then $\mathcal{B}h^\xi(b) \cdot h^\xi(b) = A\xi \cdot \xi$, i.e. the condition $\mathcal{B}h(b) \cdot h(b) > 0$ for any $h \in H_{\mathcal{D},b} \setminus \{0\}$ in Theorem 3(ii), for example, is equivalent to $A\xi \cdot \xi > 0$ for any $\xi \in \Xi_{\mathcal{D}} \setminus \{0\}$. In particular, if $I_b^D = \emptyset$ (and $D(b) \neq 0$), then that condition is equivalent to the positive definiteness of the matrix A . Notice also that $a_{kl} = a_{lk}$ due to $2a_{kl} = \Psi'(h^{(k)})h^{(l)}$ and $\Psi'(h^{(k)})h^{(l)} = \Psi'(h^{(l)})h^{(k)}$. \square

Next consider strong (local) minimizers. It is known that in the case of the Dirichlet boundary conditions, the existence of a field of extremals³ $\varphi(x, \alpha)$ satisfying the self-adjointness condition (7), and the nonnegativity of the Weierstrass function

$$E(x, u, p, q) := f(x, u, q) - f(x, u, p) - (q - p) \cdot f_p(x, u, p)$$

for suitable (x, u, p, q) imply that u^0 is a strong minimizer. In addition, the existence of the field is guaranteed by the sufficient condition for the weak minimizer in Theorem 3(ii). In the general case we have the following analogue (see Theorem 14 for a simpler version in the scalar case $N = 1$):

Theorem 5. Let $f \in C^2$, $\varepsilon > 0$, and let $u^0 \in C^2$ be an extremal satisfying (3).

(i) Let there exist a field of extremals \mathcal{P} for u^0 satisfying the conditions

$$\frac{\partial f_{p_i}(a, v, \psi(a, v))}{\partial v_j} = \frac{\partial f_{p_j}(a, v, \psi(a, v))}{\partial v_i} \quad \text{whenever } i, j \in I, v - u^0(a) \in B_\varepsilon, \quad (7)$$

³See Definition 12 for the definitions of the field of extremals and its slope ψ .

$$f_p(a, v, \psi(a, v)) \cdot (v - u^0(a)) \leq 0, \quad \text{whenever } v - u^0(a) \in \mathbb{R}_{\mathcal{D},a}^N \cap B_\varepsilon, \quad (8)$$

$$f_p(b, v, \psi(b, v)) \cdot (v - u^0(b)) \geq 0, \quad \text{whenever } v - u^0(b) \in \mathbb{R}_{\mathcal{D},b}^N \cap B_\varepsilon, \quad (9)$$

where ψ denotes the slope of the field. Assume also

$$E(x, v, \psi(x, v), q) \geq 0 \quad \text{for all } ((x, v), q) \in \mathcal{P} \times \mathbb{R}^N. \quad (10)$$

Then u^0 is a strong minimizer.

If (10) is only true for all $(x, v) \in \mathcal{P}$ and $q = q(x, v)$ satisfying $|q - \psi(x, v)| \leq \eta$ for some $\eta > 0$, then u^0 is a weak minimizer.

If the field is global (i.e. $\mathcal{P} = [a, b] \times \mathbb{R}^N$) and (7), (8), (9) are true with B_ε replaced by \mathbb{R}^N , then u^0 is a global minimizer.

(ii) Assume $I_a^{\mathcal{D}} = \emptyset$ and let there exist a field of extremals satisfying (7). If the reversed inequality “ \geq ” is true in (8), and the reversed strict inequality “ $<$ ” is true in (9) for $v = u^0(b) + tw^0$, where $t \in (0, 1)$ and $w^0 \in \mathbb{R}_{\mathcal{D},b}^N$ is fixed, then u_0 is not a weak minimizer.

(iii) Assume (4) and let the sufficient conditions for a weak minimizer in Theorem 3(ii) be satisfied. If $I_a^{\mathcal{D}} = \emptyset$ or $I_a^{\mathcal{N}} = \emptyset$ or

$$\begin{aligned} f_{p_i}(a, u, p) \text{ for } i \in I_a^{\mathcal{D}} \text{ does not depend } u_j, p_j \text{ with } j \notin I_a^{\mathcal{D}}, \\ \text{and } f_{p_i u_j} = f_{p_j u_i} \text{ for } i, j \in I_a^{\mathcal{D}}, \end{aligned} \quad (11)$$

then the field of extremals satisfying (7),(8),(9) exists.

It is known that the condition $E(x, u^0(x), (u^0)'(x), q) \geq 0$ for all $q \in \mathbb{R}^N$ or $q = q(x)$ satisfying $|q - (u^0)'(x)| \leq \eta$ is necessary for u^0 to be a strong or weak minimizer, respectively (see Theorem 9), hence the nonnegativity conditions on E in Theorem 5 are not far from optimal. Similarly, Theorem 5(ii) shows that the sufficient conditions (8)–(9) in Theorem 5(i) are also necessary in some sense, at least if $I_a^{\mathcal{D}} = \emptyset$.

Finally, let us make a few comments on our examples/applications.

Section 6 contains several scalar examples. In particular, examples 16, 17 and 18 deal with Lagrangians of the form $f = f(u, p)$. In those examples, the existence of extremals and the corresponding fields with suitable properties follows from an easy phase plane analysis, and we can use Theorem 5 even without knowing the extremal u^0 explicitly. Example 16 deals with the stability of a planar rod: The results are known (see [12]), but our approach is simpler. Example 17 deals with Lagrangians of the form $f(u, p) = g(p) + u^2$, where g is a double-well function. Unlike in Example 16, the corresponding functionals can possess weak minimizers which are not strong ones. In addition, we also show that in the case of a symmetric g , the functional Φ does not possess strong minimizers, while in a non-symmetric case, Φ attains its global infimum for $b - a$ small enough. The functional in Example 18 possesses two global minimizers and we show that their existence can be proved both by arguments based on the weak lower semicontinuity and coerciveness of Φ in a suitable Sobolev space, and by more classical arguments based on Theorem 5.

In Section 7 we investigate the stability of an unbuckled state of an inextensible, un-shearable, isotropic Kirchhoff rod. This problem has already been studied in [13], but the results there are not optimal if the boundary conditions are not the Dirichlet ones. We consider such cases and show that Theorem 3 yields optimal stability results.

3. PRELIMINARIES

In this section we discuss the notions of weak and strong local minimizers and some known necessary conditions (including the Euler and Du Bois-Reymond equations) which only depend on the local behavior of the Lagrangian.

Let $1 \leq q \leq \infty$. By $\|\cdot\|_{1,q}$ and $\|\cdot\|_q$ we denote the norms in $W^{1,q}$ and L^q , respectively. By C^1 and $W^{1,q}$ we usually denote the spaces $C^1([a, b], \mathbb{R}^N)$ and $W^{1,q}([a, b], \mathbb{R}^N)$, respectively.

Definition 6. Let $1 \leq q \leq \infty$ and $X \in \{C^1, W^{1,q}\}$. The function $u^0 \in X$ is called a *weak local* or *local* or *strong local minimizer* in $u^0 + X_{\mathcal{D}}$ if there exists $\varepsilon > 0$ such that $\Phi(u) \geq \Phi(u^0)$ for any $u \in u^0 + X_{\mathcal{D}}$ satisfying $\|u - u^0\|_{1,\infty} < \varepsilon$ or $\|u - u^0\|_X < \varepsilon$ or $\|u - u^0\|_{\infty} < \varepsilon$, respectively.

Since the adjectives weak and strong are not meaningful in the case of global minimizers, we often omit the word “local” in the notions of weak and strong local minimizers. It is easily seen that each strong minimizer is a local minimizer and each local minimizer is a weak minimizer. On the other hand, weak or local minimizers need not be strong minimizers, see Example 7. If $X \in \{C^1, W^{1,\infty}\}$, then the notions of weak minimizers and local minimizers are equivalent, but if $X = W^{1,q}$ with $q < \infty$, then weak minimizers need not be local minimizers, see Example 7 again. For some classes of Lagrangians the notions of weak and strong minimizers do coincide, see Proposition 8 and cf. also [3].

Notice also that if $q < \infty$ and Φ is continuous in $W^{1,q}$, then the density of $C_{\mathcal{D}}^1$ in $W_{\mathcal{D}}^{1,q}$ implies that each (weak, local or strong) minimizer $u^0 \in C^1$ in $u^0 + C_{\mathcal{D}}^1$ is also the corresponding minimizer in $u^0 + W_{\mathcal{D}}^{1,q}$.

Example 7. Let $N = 1$, $I_a^{\mathcal{D}} = I_b^{\mathcal{D}} = \emptyset$ and $u^0 \equiv 0$. Then the following can be easily proved (see [4] for a detailed proof and see also [16] for similar examples in the case $I_a^{\mathcal{N}} = I_b^{\mathcal{N}} = \emptyset$): If $f(x, u, p) = p^2 + p^3$, then u^0 is a weak minimizer in both C^1 and $W^{1,3}$ but it is neither a local minimizer in $W^{1,3}$ nor a strong minimizer in C^1 . If $f(x, u, p) = p^2 - p^4 u^2 + u^2$, then u^0 is local minimizer in $W^{1,4}$ but it is not a strong minimizer in $W^{1,4}$. \square

In the rest of this paper we will mainly deal with minimizers in (subsets of) C^1 , hence a weak or strong minimizer will implicitly mean a weak or strong minimizer in $u^0 + C_{\mathcal{D}}^1$. The choice of the class of Lagrangians and boundary conditions in the following proposition is motivated by Example 16, where we consider the stability of a planar rod.

Proposition 8. Let $N = 1$, $I_a^{\mathcal{D}} = I_b^{\mathcal{D}} = \emptyset$ and $f(x, u, p) = (p - K)^2 + g(u)$, where $K \in \mathbb{R}$ and $g \in C^1(\mathbb{R})$. If $u^0 \in C^1$ is a weak minimizer, then it is a strong minimizer.

Proof. The proof is based on an idea due to [6]. A detailed proof can be found in [4] so that we will just sketch it.

Let $u^0 \in C^1$ be a weak minimizer. Assume first that there exist $v_k \in W^{1,2}$ such that $r_k := \|v_k - u^0\|_{1,2} \rightarrow 0$ and $\Phi(v_k) < \Phi(u^0)$. There exists a minimizer u_k of Φ in the set $\{u \in W^{1,2} : \|u - u^0\|_{1,2} \leq r_k\}$, hence $\Phi(u_k) < \Phi(u^0)$. Set $\Theta(u) := \|u - u^0\|_{1,2}^2$. Then there exists a Lagrange multiplier $\lambda_k \leq 0$ such that $\Phi'(u_k) = \lambda_k \Theta'(u_k)$ (where the derivatives are considered in $W^{1,2}$). Standard theory implies that $u^0, u_k \in C^2$ solve the Euler equation

$$2(1 - \lambda_k)u_k'' = g'(u_k) - 2\lambda_k((u^0)'' + u_k - u^0),$$

which shows that the sequence u_k is bounded in C^2 . Since $u_k \rightarrow u^0$ in $W^{1,2}$, the boundedness in C^2 implies $u_k \rightarrow u^0$ in C^1 which contradicts the fact, that u^0 is a weak minimizer. Consequently, u^0 is a local minimizer in $W^{1,2}$.

Next assume that there exist $v_k \in C^1$ such that $\|v_k - u^0\|_\infty \rightarrow 0$ and $\Phi(v_k) < \Phi(u^0)$. Then it is easy to see that

$$0 < \Phi(u^0) - \Phi(v_k) \leq -\|v_k - u^0\|_{1,2}^2 + o(1),$$

hence $v_k \rightarrow u^0$ in $W^{1,2}$, which yields a contradiction. Consequently, u^0 is a strong minimizer. \square

The following theorem is well known (see [10, 7, 16], for example).

Theorem 9. (i) Let $f = f(x, (u, p)) \in C^{0,1}$ (i.e. $f \in C$ and f is C^1 with respect to (u, p)), and let $u^0 \in C^1$ be a critical point of Φ in $u^0 + C_{\mathcal{D}}^1$. Then the function f_p^0 is of class C^1 , u^0 satisfies the Euler equation $\frac{d}{dx} f_p^0 = f_u^0$ in $[a, b]$, and the natural boundary conditions (3). If, in addition, $f \in C^1$ and either $u^0 \in C^2$ or u^0 is a weak minimizer, then the function $f^0 - (u^0)' \cdot f_p^0$ is of class C^1 and u^0 satisfies the Du Bois-Reymond equation

$$\frac{d}{dx}(f^0 - (u^0)' \cdot f_p^0) = f_x^0 \quad \text{in } [a, b]. \quad (12)$$

If $f \in C^2$ and $u^0 \in C^2$ satisfies (12), $(u^0)' \neq 0$ a.e., then u^0 is an extremal.

(ii) Let $f \in C^{0,1}$ and $f_p \in C^1$. If $u^0 \in C^1$ is a critical point of Φ in $u^0 + C_{\mathcal{D}}^1$ and (1) is true, then $u^0 \in C^2$. If, in addition, $f \in C^k$, $k \geq 3$, then $u^0 \in C^k$.

(iii) Let $f \in C^2$ and let $u^0 \in C^1$ be a weak minimizer of Φ in $u^0 + C_{\mathcal{D}}^1$. Then the matrix $(f_{p_i p_j}^0)(x)$ is positive semidefinite for all $x \in [a, b]$, and there exists $\delta > 0$ such that $E(x, u^0(x), (u^0)'(x), q) \geq 0$ whenever $x \in [a, b]$ and $|q - (u^0)'(x)| < \delta$. If u^0 is a strong minimizer, then $E(x, u^0(x), (u^0)'(x), q) \geq 0$ for all $x \in [a, b]$ and $q \in \mathbb{R}$.

(iv) Let $f(\cdot, u, p)$ be measurable for any (u, p) and let $f(x, \cdot, \cdot) \in C^1$ for a.e. x . Let $q > 1$, $f(\cdot, 0, 0) \in L^1$, and let the derivatives f_u, f_p satisfy the growth conditions

$$\left. \begin{aligned} |f_u(x, u, p)| &\leq M(|u|)(a_0(x) + |p|^q) \\ |f_p(x, u, p)| &\leq M(|u|)(a_1(x) + |p|^{q-1}) \end{aligned} \right\} \quad \text{for a.e. } x \text{ and all } u, p,$$

where $a_0 \in L^1$, $a_1 \in L^{q/(q-1)}$ and $M : [0, \infty) \rightarrow [0, \infty)$ is nondecreasing. Then $\Phi \in C^1(W^{1,q})$, and if u^0 is a critical point of Φ in $u^0 + W_{\mathcal{D}}^{1,q}$, then there exists $C \in \mathbb{R}^N$ such that

$$f_p^0(x) = \int_a^x f_u^0(\xi) d\xi + C \quad \text{for a.e. } x \in [a, b].$$

4. JACOBI THEORY

In this section we will prove Theorem 3 and a generalization of Theorem 2. Throughout this section we assume (4).

Given $y \in (a, b]$, let

$$X_y := \{h \in W^{1,2}([a, y], \mathbb{R}^N) : h(a) \in \mathbb{R}_{\mathcal{D},a}^N, h(y) = 0\}$$

be endowed with the norm $\|h\|_{X_y} := (\int_a^y \sum_{i,j} f_{p_i p_j}^0 h_i' h_j' dx)^{1/2}$ (which is equivalent to the standard norm in $W^{1,2}$ for $h \in X_y$ due to (1) and the boundary condition $h(y) = 0$), and

let S_y denote the unit sphere in X_y . If $\tilde{y} \in (y, b]$ and $h \in X_y$, then the function \tilde{h} defined by $\tilde{h}(x) := h(x)$ for $x \in [a, y]$, $\tilde{h}(x) := 0$ for $x \in (y, \tilde{y}]$, belongs to $X_{\tilde{y}}$ and $\|\tilde{h}\|_{X_{\tilde{y}}} = \|h\|_{X_y}$. Consequently, X_y can be considered as a subspace of $X_{\tilde{y}}$ and $S_y \subset S_{\tilde{y}}$. Set also

$$\lambda_1 = \lambda_1(y) := \inf_{h \in S_y} \Psi(h) = 1 + \inf_{h \in S_y} \hat{\Psi}(h),$$

where $h = h(x)$ is extended by zero for $x > y$ and

$$\hat{\Psi}(h) := \int_a^b \sum_{i,j} \left(f_{p_i u_j}^0 h'_i h_j + f_{u_i p_j}^0 h_i h'_j + f_{u_i u_j}^0 h_i h_j \right) dx.$$

Since $S_y \subset S_{\tilde{y}}$ if $y < \tilde{y}$, the function λ_1 is nonincreasing. In addition, one can easily show that λ_1 is continuous and $\lim_{y \rightarrow a+} \lambda_1(y) \geq c^0$, where c^0 is the constant in (1).

Proposition 10. *Let D be as in Theorem 3 and $y \in (a, b]$.*

If $\lambda_1(y) = 0$, then $D(y) = 0$ and $\lambda_1(z) < 0$ for $z \in (y, b]$. If $D(y) = 0$, then $\lambda_1(y) \leq 0$.

If $h \in X_b$, then $\Psi(h) \geq \lambda_1(b) \|h\|_{X_b}^2$. If $\lambda_1(b) < 0$, then there exists $h \in X_b$ such that $\Psi(h) < 0$.

Proof. Let $\lambda_1(y) = 0$ and let B_y denote the closed unit ball in X_y . Since $\hat{\Psi}$ is weakly sequentially continuous, there exists $h_y \in B_y$ such that $\hat{\Psi}(h_y) = \inf_{B_y} \hat{\Psi} = -1$. We have $h_y \in S_y$ (otherwise $th_y \in B_y$ for some $t > 1$, and $\hat{\Psi}(th_y) = t^2 \hat{\Psi}(h_y) < \inf_{B_y} \hat{\Psi}$, which yields a contradiction). Since $\Psi(h_y) = \inf_{S_y} \Psi = 0$, h_y is a global minimizer of Ψ in X_y , hence it satisfies the Jacobi equation $\mathcal{A}h = 0$ and the natural boundary conditions $\mathcal{B}h(a) \in \mathbb{R}_{\mathcal{N},a}^N$. Consequently, there exists $\alpha \in \mathbb{R}^N \setminus \{0\}$ such that $h_y = \sum_k \alpha_k h^{(k)}$, where $h^{(k)}$ are as in Theorem 3. Since $h_y(y) = 0$, we have $D(y) = 0$.

Next assume on the contrary that $\lambda_1(y) = 0 = \lambda_1(z)$ for some $z \in (y, b]$. Then the minimizer h_y extended by zero on $(y, z]$ is a global minimizer of Ψ in X_z , hence Theorem 9(iv) and the particular form of Ψ yield $h_y \in C^1([a, z])$. Consequently, $h(y) = h'(y) = 0$, which yields a contradiction with the uniqueness of solutions of the Jacobi equation with prescribed initial conditions for both h and h' .

Next assume that $D(y) = 0$. Then there exists $\alpha \in \mathbb{R}^N \setminus \{0\}$ such that $h := \sum_k \alpha_k h^{(k)}$ satisfies $h(y) = 0$, hence $h \in X_y$. In addition, $\Psi(h) = \mathcal{B}h \cdot h \Big|_a^b = 0$, hence $\lambda_1 \leq 0$.

The remaining assertions are obvious. \square

Proof of Theorem 3. As already announced in Remark 4(i), we will show that the conditions in Theorem 3 guaranteeing that u_0 is or is not a minimizer imply that the functional Ψ is positive definite in $W_{\mathcal{D}}^{1,2}$ or there exists $h \in W_{\mathcal{D}}^{1,2}$ such that $\Psi(h) < 0$, respectively. First let us show that these positivity or negativity properties of Ψ imply that u^0 is or is not a weak minimizer, respectively.

Assume that $\Psi(h) \geq c \|h\|_{1,2}^2$ for some $c > 0$ and all $h \in W_{\mathcal{D}}^{1,2}$ and recall that $\Psi(h) = \Phi''(u^0)(h, h)$ if $h \in C^1$. If u^1 is close u^0 in C^1 and Ψ^1 denotes the functional Ψ with u^0 replaced by u^1 , then one can easily check that $\Psi^1(h) = \Phi''(u^1)(h, h) \geq \frac{c}{2} \|h\|_{1,2}^2$ for $h \in C_{\mathcal{D}}^1$, and the Mean Value Theorem implies the existence of $\theta \in (0, 1)$ such that

$$\Phi(u^0 + h) - \Phi(u^0) = \frac{1}{2} \Phi''(u^0 + \theta h)(h, h) \geq \frac{c}{4} \|h\|_{1,2}^2 \geq 0$$

whenever $h \in C_{\mathcal{D}}^1$ is small enough. Consequently, u^0 is a weak minimizer.

If $\Psi(h) < 0$ for some $h \in W_{\mathcal{D}}^{1,2}$, then the density of $C_{\mathcal{D}}^1$ in $W_{\mathcal{D}}^{1,2}$ and the continuity of Ψ in $W_{\mathcal{D}}^{1,2}$ guarantee the existence of $\tilde{h} \in C_{\mathcal{D}}^1$ such that $0 > \Psi(\tilde{h}) = \Phi''(u^0)(\tilde{h}, \tilde{h})$, which shows that u^0 is not a minimizer.

(i) If $D(x) = 0$ for some $x \in (a, b)$, then Proposition 10 implies the existence of $h \in X_b \subset W_{\mathcal{D}}^{1,2}$ such that $\Psi(h) < 0$.

If $I_b^{\mathcal{N}} \neq \emptyset$ and $\mathcal{B}h(b) \cdot h(b) < 0$ for some $h \in H_{\mathcal{D},b} \subset W_{\mathcal{D}}^{1,2}$, then $\mathcal{A}h = 0$, $h_i(a) = 0$ for $i \in I_a^{\mathcal{D}}$ and $\mathcal{B}_i h(a) = 0$ for $i \in I_a^{\mathcal{N}}$, hence

$$\Psi(h) = \mathcal{B}h \cdot h \Big|_a^b = \mathcal{B}h(b) \cdot h(b) < 0.$$

(ii) Assume that $D > 0$ in $(a, b]$. Then Proposition 10 implies $\lambda_1(b) > 0$ and $\Psi(h) \geq \lambda_1(b) \|h\|_{X_b}^2$ for $h \in X_b$. If $I_b^{\mathcal{N}} = \emptyset$, then $X_b = W_{\mathcal{D}}^{1,2}$, hence we are done.

Next assume that $I_b^{\mathcal{N}} \neq \emptyset$ and $\mathcal{B}\tilde{h}(b) \cdot \tilde{h}(b) > 0$ for any $\tilde{h} \in H_{\mathcal{D},b} \setminus \{0\}$, and let $h \in W_{\mathcal{D}}^{1,2}$ be fixed. Since $D(b) \neq 0$, there exists $\alpha \in \mathbb{R}^{\mathcal{N}}$ such that $\tilde{h} := \sum_k \alpha_k h^{(k)}$ satisfies $\tilde{h}(b) = h(b)$. In particular, $\tilde{h} \in H_{\mathcal{D},b}$. Set $\hat{h} := h - \tilde{h}$. Then $\hat{h} \in X_b$, hence $\Psi(\hat{h}) \geq \lambda_1(b) \|\hat{h}\|_{X_b}^2$. In addition, $\Psi(\tilde{h}) = \mathcal{B}\tilde{h}(b) \cdot \tilde{h}(b) \geq \tilde{c}|\alpha|^2$ for some $\tilde{c} > 0$. Since

$$\Psi'(\hat{h})\tilde{h} = \Psi'(\tilde{h})\hat{h} = 2 \int_a^b \mathcal{A}\tilde{h} \cdot \hat{h} \, dx + 2\mathcal{B}\tilde{h} \cdot \hat{h} \Big|_a^b = 0,$$

there exists $c > 0$ such that

$$\Psi(h) = \Psi(\tilde{h} + \hat{h}) = \Psi(\tilde{h}) + \Psi(\hat{h}) \geq c \|h\|_{1,2}^2.$$

(iii) Let $h \in H_0$ and $\mathcal{B}_i h(b) \neq 0$ for some $i \in I_b^{\mathcal{N}}$. Then $\Psi(h) = 0$, and h is a global minimizer of Ψ in X_b due to Proposition 10. Choosing suitable $\tilde{h} \in C_{\mathcal{D}}^1$ with $\tilde{h}(a) = 0$, $\tilde{h}_j(b) = \delta_{ij}$, we obtain $\Psi'(h)\tilde{h} = \mathcal{B}_i h(b) \neq 0$, hence $\Psi(h + \varepsilon\tilde{h}) < 0$ for ε small, $\varepsilon \neq 0$. \square

Next we use different arguments in order to prove a generalization of Theorem 2.

Theorem 11. *Assume (4) with $N = 1$, and let $I_a^{\mathcal{N}} = I_b^{\mathcal{N}} = \{1\}$. Let h_0 be a nontrivial solution of the Jacobi equation $\mathcal{A}h = 0$. If $h_0(y) > 0$ for any $y \in (a, b]$ and $\mathcal{B}h_0(b) > 0 \geq \mathcal{B}h_0(a)$, then u^0 is a weak minimizer.*

Proof. A detailed proof can be found in [4] so that we will just sketch it.

Set $M := \{h \in W^{1,2}([a, b]) : \|h\|_2 = 1\}$. Since Ψ is weakly sequentially lower semi-continuous and coercive on M , there exists $h_M \in M$ which is a global minimizer of Ψ in M . If $c_M := \Psi(h_M) > 0$, then $\Psi(h) \geq c_M \|h\|_2^2$, and it is not difficult to show that this inequality, the particular form of Ψ and the inequality $\|h\|_{\infty} \leq \varepsilon \|h\|_{1,2} + C_{\varepsilon} \|h\|_2$ imply $\Psi(h) \geq c \|h\|_{1,2}^2$ for some $c > 0$, hence we are done.

Now assume that $c_M \leq 0$. Replacing h_M with $|h_M|$ we may assume $h_M \geq 0$. Set $\Theta(h) := \|h\|_2^2$ for $h \in W^{1,2}([a, b])$. Then there exists a Lagrange multiplier λ such that $\Psi'(h_M) = \lambda \Theta'(h_M)$, hence $\lambda = \frac{1}{2} \Psi'(h_M) h_M = \Psi(h_M) = c_M \leq 0$. Standard arguments guarantee that h_M is a C^2 solution of the Euler equation $\mathcal{A}h = \lambda h$ and satisfies the natural boundary conditions $\mathcal{B}h_M(a) = \mathcal{B}h_M(b) = 0$. The uniqueness for ODEs, the nonnegativity of h_0, h_M , and the boundary conditions for h_0, h_M imply $h_0, h_M > 0$ in $[a, b]$. Multiplying the equation $\mathcal{A}h_M = \lambda h_M$ with h_0 and integrating by parts twice yields

$$0 = \int_a^b (\mathcal{A}h_M - \lambda h_M) h_0 \, dx = (-\mathcal{B}h_M h_0 + \mathcal{B}h_0 h_M) \Big|_a^b - \lambda \int_a^b h_M h_0 \, dx \geq \mathcal{B}h_0(b) h_M(b) > 0,$$

a contradiction. □

5. FIELD OF EXTREMALS

In this section we will prove Theorem 5.

Definition 12. Let $f \in C^2$, $\varepsilon > 0$, and let $u^0 \in C^2$ be an extremal. The image \mathcal{P} of a C^1 -diffeomorphism $P : [a, b] \times B_\varepsilon \rightarrow [a, b] \times \mathbb{R}^N : (x, \alpha) \mapsto (x, \varphi(x, \alpha))$ is called the *field of extremals for u^0* if $\varphi_x \in C^1$, $\varphi(\cdot, \alpha)$ is an extremal for each α , and $\varphi(\cdot, 0) = u^0$. The *slope* of the field of extremals \mathcal{P} is defined as $\psi : \mathcal{P} \rightarrow \mathbb{R}^N : (x, v) \mapsto \varphi_x(x, \alpha(x, v))$, where $\alpha(x, v)$ is defined by $\varphi(x, \alpha(x, v)) = v$.

I what follows we assume that

$$\begin{aligned} f &\in C^2, u^0 \in C^2 \text{ is an extremal,} \\ \mathcal{P} &\text{ is a field of extremals for } u^0 \text{ with slope } \psi, \text{ and (7) is true.} \end{aligned} \quad (13)$$

Given $v \in C^1([a, b], \mathbb{R}^N)$ such that $\text{graph}(v) := \{(x, v(x)) : x \in [a, b]\} \subset \mathcal{P}$, we define the Hilbert invariant integral

$$I(v) := \int_a^b [f(x, v(x), \psi(x, v(x))) + (v'(x) - \psi(x, v(x))) \cdot f_p(x, v(x), \psi(x, v(x)))] dx.$$

Proposition 13. *Assume (13). Then there exists $S \in C^2(\mathcal{P})$ such that*

$$\begin{aligned} I(v) &= S(b, v(b)) - S(a, v(a)) \quad \text{for any } v \in C^1([a, b], \mathbb{R}^N) \text{ with } \text{graph}(v) \subset \mathcal{P}, \\ S_v(x, v) &= f_p(x, v, \psi(x, v)) \quad \text{for any } (x, v) \in \mathcal{P}. \end{aligned} \quad (14)$$

Proof. The assertion is well known but we give a sketch of its proof for the reader's convenience. If $w = (w_1, \dots, w_N)$ depends on θ , then we denote $w_{i,\theta} := \frac{\partial w_i}{\partial \theta}$. By differentiating the identity $\varphi_x(x, \alpha) = \psi(x, \varphi(x, \alpha))$ we obtain

$$\varphi_{j,xx} = \psi_{j,x} + \sum_k \psi_{j,v_k} \varphi_{k,x} = \psi_{j,x} + \sum_k \psi_{j,v_k} \psi_k.$$

If we substitute this relation into the Euler equations

$$\sum_j (f_{p_i p_j} \varphi_{j,xx} + f_{p_i u_j} \varphi_{j,x}) + f_{p_i x} - f_{u_i} = 0,$$

(where the arguments of the derivatives of f and φ are $(x, \varphi(x, \alpha), \varphi_x(x, \alpha))$ and (x, α) , respectively), then we obtain

$$\sum_j (f_{p_i p_j} (\psi_{j,x} + \sum_k \psi_{j,v_k} \psi_k) + f_{p_i u_j} \psi_j) + f_{p_i x} - f_{u_i} = 0, \quad (15)$$

where the arguments of the derivatives of f and ψ are $(x, v, \psi(x, v))$ and (x, v) , respectively. For $(x, v) \in \mathcal{P}$ we set

$$\begin{aligned} V(x, v) &:= f(x, v, \psi(x, v)) - f_p(x, v, \psi(x, v)) \cdot \psi(x, v), \\ W(x, v) &:= f_p(x, v, \psi(x, v)). \end{aligned} \quad (16)$$

We claim that

$$(W_{i,v_j} - W_{j,v_i})(x, v) = \frac{\partial f_{p_i}(x, v, \psi(x, v))}{\partial v_j} - \frac{\partial f_{p_j}(x, v, \psi(x, v))}{\partial v_i} = 0, \quad i, j \in I. \quad (17)$$

In fact, if f and φ are of class C^3 , then setting $v = \varphi(x, \alpha)$ and $\psi(x, v) = \varphi_x(x, \alpha)$ in (17), the Euler equations imply that the d/dx -derivative of the resulting expression vanishes, hence the conclusion follows from (7). Such argument can also be used without the additional smoothness assumptions on f, φ , see the proof of [10, Proposition 6.1.1.4].

Now (17) and (15) imply $V_v = W_x$. This fact and (17) guarantee the existence of $S \in C^2(\mathcal{P})$ such that $S_x = V$ and $S_v = W$. Finally,

$$\begin{aligned} I(v) &= \int_a^b (V + W \cdot v') dx = \int_a^b (S_x + S_v \cdot v') dx = \int_a^b \frac{d}{dx} S(x, v(x)) dx \\ &= S(b, v(b)) - S(a, v(a)). \end{aligned}$$

□

Proof of Theorem 5. (i) Let $u - u^0 \in C_{\mathcal{D}}^1$, $\text{graph}(u) \subset \mathcal{P}$, and let S be the function from Proposition 13. If u is close to u^0 in the sup-norm, then the assumptions (8)–(9) guarantee

$$S(a, u(a)) - S(a, u^0(a)) = \int_0^1 S_v(a, u^0(a) + t(u(a) - u^0(a))) \cdot (u(a) - u^0(a)) dt \leq 0,$$

and similarly $S(b, u(b)) - S(b, u^0(b)) \geq 0$, hence $I(u^0) \leq I(u)$ due to Proposition 13. This fact and assumption (10) imply

$$\Phi(u) - \Phi(u^0) = \Phi(u) - I(u^0) \geq \Phi(u) - I(u) = \int_a^b E(x, u(x), \psi(x, u(x)), u'(x)) dx \geq 0,$$

hence u^0 is a strong minimizer. The remaining assertions in (i) are obvious.

(ii) Choose $t_k \rightarrow 0+$ and let α_k be such that $\varphi(b, \alpha_k) = u^0(b) + t_k w^0$. Then $u^k := \varphi(\cdot, \alpha_k) \rightarrow u^0$ in C^1 , $u^k - u^0 \in C_{\mathcal{D}}^1$ due to $I_a^{\mathcal{D}} = \emptyset$ and $w^0 \in \mathbb{R}_{\mathcal{D}, b}^N$, and, similarly as in (i), we obtain

$$\Phi(u^k) = I(u^k) = S(b, u^k(b)) - S(a, u^k(a)) < S(b, u^0(b)) - S(a, u^0(a)) = I(u^0) = \Phi(u^0),$$

hence u^0 is not a minimizer.

(iii) First assume that $I_a^{\mathcal{N}} = \emptyset$. If $I_b^{\mathcal{N}} = \emptyset$, then the assertion is well known (see [9] or [10], for example), hence we may assume $I_b^{\mathcal{N}} \neq \emptyset$. Our assumptions imply $D > 0$ in $(a, b]$ and $\mathcal{B}h(b) \cdot h(b) > 0$ for any $h \in H_{\mathcal{D}, b} \setminus \{0\}$. We may also assume that f is defined and of class C^3 in an open neighbourhood of $\{(x, u^0(x), (u^0)'(x)) : x \in [a, b]\}$ in $\mathbb{R} \times \mathbb{R}^N \times \mathbb{R}^N$ (see [4] for a detailed proof if $N = 1$). Consequently, there exists $\varepsilon > 0$ small such that u^0 can be extended (as an extremal) for $x \in [a - \varepsilon, a]$, f^0 satisfies (1) in $[a - \varepsilon, b]$, and the solutions $h^{(k)}$, $k = 1, 2, \dots, N$ of the Jacobi equation in $[a - \varepsilon, b]$ with initial conditions $h^{(k)}(a - \varepsilon) = 0$, $(h_i^{(k)})'(a - \varepsilon) = \delta_{ik}$, satisfy $D > 0$ in $(a - \varepsilon, b]$ and $\mathcal{B}h(b) \cdot h(b) > 0$ for any $h \in H_{\mathcal{D}, b} \setminus \{0\}$ due to the continuous dependence of solutions of ODEs on initial values. Let $\varphi(\cdot, \alpha)$ be the extremal satisfying the initial conditions $\varphi(a - \varepsilon, \alpha) = u^0(a - \varepsilon)$, $\varphi_x(a, \alpha) = (u^0)'(a - \varepsilon) + \alpha$. The arguments in [9, 10] guarantee that such extremals define a field of extremals for u^0 (in $[a, b]$) satisfying (7). Condition (8) is empty, hence we only have to show that (9) is true. Thus assume that $v - u^0(b) \in \mathbb{R}_{\mathcal{D}, b}^N \cap B_\varepsilon \setminus \{0\}$. We have $v = \varphi(b, \alpha)$ for some α small. Set $h^\alpha := \sum_k \alpha_k h^{(k)}$. If $i \in I_b^{\mathcal{D}}$, then $0 = \varphi_i(b, \alpha) - u_i^0(b) = h_i^\alpha(b) + o(\alpha)$, hence $h^\alpha = h^{\tilde{\alpha}} + o(\alpha)$ for some $h^{\tilde{\alpha}} \in H_{\mathcal{D}, b} \setminus \{0\}$ and $\tilde{\alpha} = \alpha + o(\alpha)$. Since our assumptions

imply $\mathcal{B}h^{\tilde{\alpha}}(b) \cdot h^{\tilde{\alpha}}(b) = \sum_{i \in I_b^{\mathcal{N}}} \mathcal{B}_i h^{\tilde{\alpha}}(b) h_i^{\tilde{\alpha}}(b) > 0$, we also have

$$\begin{aligned} f_p(b, v, \psi(b, v)) \cdot (v - u^0(b)) &= \sum_{i \in I_b^{\mathcal{N}}} f_{p_i}(b, \varphi(b, \alpha), \varphi_x(b, \alpha)) (\varphi_i(b, \alpha) - u_i^0(b)) \\ &= \sum_{i \in I_b^{\mathcal{N}}} (\mathcal{B}_i h^{\tilde{\alpha}}(b) + o(\tilde{\alpha})) (h_i^{\tilde{\alpha}}(b) + o(\tilde{\alpha})) \\ &= \sum_{i \in I_b^{\mathcal{N}}} (\mathcal{B}_i h^{\tilde{\alpha}}(b) + o(\tilde{\alpha})) (h_i^{\tilde{\alpha}}(b) + o(\tilde{\alpha})) > 0. \end{aligned}$$

Next assume $I_a^{\mathcal{D}} = \emptyset$. Since our proof in this case uses similar arguments as in the case $I_a^{\mathcal{N}} = \emptyset$ (and a very detailed proof in the case $N = 1$ can be found in [4]), we will be brief. Given $\alpha \in \mathbb{R}^N$ small and $v = v(\alpha) := u^0(a) + \alpha$, the Implicit Function Theorem implies the existence of a unique $w = w(\alpha) \in \mathbb{R}^N$ close to $(u^0)'(a)$ such $f_p(a, v(\alpha), w(\alpha)) = 0$. Let $\varphi(\cdot, \alpha)$ be the extremal satisfying the initial conditions $\varphi(a, \alpha) = v(\alpha)$, $\varphi_x(a, \alpha) = w(\alpha)$. We claim that such extremals $\varphi(\cdot, \alpha)$ define the required field. In fact, the function P in Definition 12 is a C^1 -diffeomorphism and $\varphi_x \in C^1$ due to the differentiability of solutions of ODEs on initial values and the fact that $h^{(k)} := \frac{\partial \varphi}{\partial \alpha_k}(\cdot, 0)$, $k = 1, \dots, N$, are linearly independent solutions of the Jacobi equation $\mathcal{A}h = 0$ satisfying the initial conditions $\mathcal{B}h(a) = 0$, hence $\det(h^{(1)}, \dots, h^{(N)}) > 0$ in $[a, b]$ due to our assumptions. Properties (7) and (8) follow from $f_p(a, v, \psi(a, v)) = 0$ and the proof of (9) is the same as in the case $I_a^{\mathcal{N}} = \emptyset$.

Finally assume (11). Let $h^{(1)}, \dots, h^{(N)}$ be solutions of the Jacobi equation $\mathcal{A}h = 0$ in $[a, b]$ satisfying the initial conditions

$$\begin{aligned} h_i^{(k)}(a) &= \eta \delta_{ik} & \text{for } k \in I_a^{\mathcal{D}}, i \in I, & & (h_i^{(k)})'(a) &= \delta_{ik} & \text{for } k \in I, i \in I_a^{\mathcal{D}}, \\ h_i^{(k)}(a) &= \delta_{ik} & \text{for } k \in I_a^{\mathcal{N}}, i \in I, & & \mathcal{B}_i h^{(k)}(a) &= 0 & \text{for } k \in I, i \in I_a^{\mathcal{N}}, \end{aligned}$$

where $\eta \in [0, 1]$. If $\zeta \geq 0$ is small, then

$$\begin{aligned} h_i^{(k)}(a + \zeta) &= (\eta + \zeta) \delta_{ik} + o(\zeta) & \text{if } k, i \in I_a^{\mathcal{D}}, \\ h_i^{(k)}(a + \zeta) &= \delta_{ik} + O(\zeta) & \text{otherwise,} \end{aligned}$$

hence $D(x) := \det(h^{(1)}(x), \dots, h^{(N)}(x)) > 0$ for $x \in [a, a + \zeta]$ and $\eta \in (0, 1]$. If $\eta = 0$, then our assumptions imply $D(x) > 0$ for $x \in [a + \zeta, b]$ and $\mathcal{B}h(b) \cdot h(b) > 0$ for any $h := \sum_k \beta_k h^{(k)}$ satisfying $h_i(b) = 0$ for $i \in I_b^{\mathcal{D}}$ and $h \neq 0$. Those properties remain true for $\eta > 0$ small and we fix such $\eta > 0$. Set $v_i(\alpha) = u_i^0(a) + \eta \alpha_i$ if $i \in I_a^{\mathcal{D}}$, $v_i(\alpha) = u_i^0(a) + \alpha_i$ if $i \in I_a^{\mathcal{N}}$ and $w_i(\alpha) = (u_i^0)'(a) + \alpha_i$ if $i \in I_a^{\mathcal{D}}$. The Implicit Function Theorem guarantees that there exist unique $w_i(\alpha)$ for $i \in I_a^{\mathcal{N}}$ (close to $(u_i^0)'(a)$) such that $f_{p_i}(a, v(\alpha), w(\alpha)) = 0$ for $i \in I_a^{\mathcal{N}}$ and α small. Let $\varphi(\cdot, \alpha)$ be extremals satisfying the initial conditions $\varphi(a, \alpha) = v(\alpha)$, $\varphi_x(a, \alpha) = w(\alpha)$. Then $\varphi_{\alpha_k}(a, 0) = h^{(k)}(a)$ and $\varphi_{x\alpha_k}(a, 0) = (h^{(k)})'(a)$, which shows that these extremals define a field of extremals for α small. The same arguments as above guarantee that properties (8),(9) are satisfied. Let us show that (7) is true. If $i, j \in I_a^{\mathcal{N}}$, then this follows from $f_{p_i}(a, v, \psi(a, v)) = f_{p_j}(a, v, \psi(a, v)) = 0$. Let $i \in I_a^{\mathcal{D}}$. If $j \in I_a^{\mathcal{N}}$, then the left-hand side in (7) is zero due to $f_{p_i u_j} = f_{p_i p_j} = 0$. If $j \in I_a^{\mathcal{D}}$, then that left-hand side equals $f_{p_i u_j}(a, v, \psi(a, v)) + \sum_{k \in I} f_{p_i p_k}(a, v, \psi(a, v)) \psi_{k, v_j}(a, v)$. Since $f_{p_i u_j} = f_{p_j u_i}$,

$f_{p_i p_k}(a, v, \psi(a, v)) = 0$ for $k \in I_a^N$ and $\psi_{k, v_j}(a, v) = \frac{1}{\eta} \delta_{kj}$ if $k \in I_a^{\mathcal{D}}$, we see that that left-hand side equals to the right-hand side. \square

6. SCALAR EXAMPLES

Throughout this section we assume $N = 1$ and $I_a^{\mathcal{D}} = I_b^{\mathcal{D}} = \emptyset$. Since we will often use Theorem 5, let us first reformulate it in this special case. Notice that the extremals in the field of extremals satisfy $\varphi_\alpha(x, \alpha) \neq 0$, hence we can assume $\varphi_\alpha > 0$ without loss of generality.

Theorem 14. *Let $N = 1$, $I_a^{\mathcal{D}} = I_b^{\mathcal{D}} = \emptyset$, $f \in C^2$ and let $u^0 \in C^2$ be an extremal satisfying (3).*

(i) *Let there exist a field of extremals $\mathcal{P} = \{(x, \varphi(x, \alpha)) : x \in [a, b], \alpha \in (-\varepsilon, \varepsilon)\}$ for u^0 satisfying the conditions $\varphi_\alpha > 0$ and*

$$f_p^\alpha(a)\alpha \leq 0 \leq f_p^\alpha(b)\alpha, \quad \alpha \in (-\varepsilon, \varepsilon), \quad (18)$$

where $f_p^\alpha(x) := f_p(x, \varphi(x, \alpha), \varphi_x(x, \alpha))$. Assume also

$$E(x, v, \psi(x, v), q) \geq 0 \quad \text{for all } ((x, v), q) \in \mathcal{P} \times \mathbb{R}. \quad (19)$$

Then u^0 is a strong minimizer.

If (19) is only true for all $(x, v) \in \mathcal{P}$ and $q = q(x, v)$ satisfying $|q - \psi(x, v)| \leq \eta$ for some $\eta > 0$, then u^0 is a weak minimizer.

If $\mathcal{P} = [a, b] \times \mathbb{R}$, then u^0 is a global minimizer.

(ii) *Let there exist a field of extremals satisfying $\varphi_\alpha > 0$. If, for $\alpha > 0$ or $\alpha < 0$, the reversed inequalities in (18) are true and one of them is strict (for example, if $f_p^\alpha(a) \geq 0 > f_p^\alpha(b)$ for $\alpha > 0$), then u_0 is not a weak minimizer.*

(iii) *Assume (4) and let the sufficient conditions for a weak minimizer in Theorem 2(ii) be satisfied. Then the field of extremals satisfying $\varphi_\alpha > 0$ and (18) exists.*

Notice also that if $f_{up}^0 = 0$ and we set $P := f_{pp}^0$, $Q := f_{uu}^0$, then $\Psi(h) = \int_a^b (P(h')^2 + Qh^2) dx$ (hence Ψ is positive definite in $W^{1,2}$ if $P, Q > 0$), and the Jacobi equation has the form $-\frac{d}{dx}(Ph') + Qh = 0$.

Example 15. Let $f = p^2 + g(x)u^2$, where $g \in L^\infty([a, b])$, and $u^0 = 0$. Assume that the solution of the Jacobi equation $h'' = gh$ with initial conditions $h(a) = 1$, $h'(a) = 0$, satisfies $h > 0$ in $[a, b]$ and $h'(b) \geq 0$. Then Theorem 9(iv) and the proof of Theorem 3 guarantee that $2\Phi(u) = \Psi(u) \geq 0$ for any $u \in W^{1,2}([a, b])$, i.e.

$$\int_a^b g^- u^2 dx \leq \int_a^b g^+ u^2 dx + \int_a^b (u')^2 dx, \quad u \in W^{1,2}([a, b]), \quad (20)$$

where $g^\pm := \max(\pm g, 0)$. Let, for example, $0 = a < d < b$, $g = -1$ on $[a, d]$, $g = K^2$ on $(d, b]$, and let either $d < \pi/2$ and K be large enough ($K \geq K_0$, where $K_0 \cotg(d) = \cotgh(K_0(b-d))$, $K_0 > 0$), or $d < \pi/4$, $K = 1$ and b be large enough ($b \geq b_0 := d + \frac{1}{2} \log((\cos d + \sin d)/(\cos d - \sin d))$). Then the conditions on h mentioned above are satisfied, hence (20) is true. In particular, $\int_0^d u^2 dx \leq \int_d^b u^2 dx + \int_0^b (u')^2 dx$ (i.e. $2 \int_0^d u^2 dx \leq \|u\|_{1,2}^2$) if $d < \pi/4$ and $b \geq b_0$, hence $2 \int_{-\pi/4}^{\pi/4} u^2 dx \leq \|u\|_{1,2}^2$ for any $u \in W^{1,2}(\mathbb{R})$. \square

In the following examples we will consider Lagrangians $f = f(u, p)$ and we will use the phase plane analysis for the Du Bois-Reymond equation $f^0 - (u^0)' f_p^0 = C$.

Example 16. The study of the deformation of a planar weightless inextensible and un-shearable rod (satisfying suitable boundary conditions) leads to the minimization of the functional

$$\Phi(u) = \int_0^1 \left(\frac{1}{2}(u' - K)^2 + M \cos u \right) dx, \quad u \in C^1([0, 1]),$$

where $M > 0$, and u denotes the angle between the tangent to the rod and a suitable vertical, see [12, (97)] and cf. also [2]. The functional Φ possesses multiple extremals satisfying the natural boundary conditions $u'(0) = u'(1) = K$, see [12] for their detailed analysis. Their stability was also analyzed in [12], but that analysis based on the approach from [14] is unnecessarily complicated. Somewhat simpler arguments were used in [2], but those arguments cannot be used for all critical points. We will show that Theorems 2 and 14 yield a very simple way how to determine the stability of any critical point.

Proposition 8 shows that u^0 is a weak minimizer of Φ if and only if it is a strong minimizer. Therefore we will only speak about minimizers. Notice also that $f_p = 1$ and the Weierstrass function satisfies $E(x, u, p, q) = \frac{1}{2}(q - p)^2 \geq 0$. Theorem 9 guarantees that any critical point of Φ is C^∞ and satisfies the Du Bois-Reymond equation $(u')^2 = 2M \cos u + C$, where C is a constant. Conversely, any non-constant solution of the Du Bois-Reymond equation is an extremal.

We consider the phase plane (u, v) , where $v = u'$, and set

$$\phi_C := \{(u, v) : v^2 = 2M \cos u + C\}, \quad C \in (-2M, \infty)$$

(see Figure 1). The considerations above show that given any non-constant critical point u^0 , there exists $C^0 > -2M$ such that $(u^0(x), (u^0)'(x)) \in \phi_{C^0}$ for $x \in [0, 1]$, $(u^0)'(0) = (u^0)'(1)$. On the other hand, if $(A_0, K), (A_1, K) \in \phi_{C^0}$ for some $C^0 \in (2M, \infty)$, $A_0 \neq A_1$, and a C^1 -function u^0 corresponds to the part of curve ϕ_{C^0} between (A_0, K) and (A_1, K) (i.e. $(u^0(x), (u^0)'(x)) \in \phi_{C^0}$ for $x \in [0, 1]$, $(u^0(0), (u^0)'(0)) = (A_0, K)$ and $(u^0(b), (u^0)'(b)) = (A_1, K)$ for some $b > 0$), then u^0 is a critical point if and only if $b = 1$ (the value of b is uniquely determined in this case since $(u^0)' \neq 0$). Similar assertion is true if $C^0 \in (-2M, 2M]$ ($K \neq 0$ if $C^0 = 2M$), but this time one can have $(u^0(b), (u^0)'(b)) = (A_1, K)$ for multiple values of b (since u^0 need not be monotone), and one has to allow $A_1 = A_0$.

Let us first consider a critical point u^0 being a part of curve ϕ_{C^0} with $C^0 > 2M$, and let (A_i, K) be as above. For symmetry reasons we may assume $K > 0$. Notice that $u'' = -2M \sin u$, $|(u^0)''(0)| = |(u^0)''(1)|$, and that $u^0(x)$ can also be defined (as an extremal, hence a part of ϕ_{C^0}) for $x \notin [0, 1]$.

If $(u^0)''(0) < 0 < (u^0)''(1)$ (i.e. $u^0(0) \in (2k\pi, (2k+1)\pi)$ and $u^0(1) \in ((2m+1)\pi, (2m+2)\pi)$ for some $m \geq k$; see the extremal u^0 with $(u^0)'(0) = K_1$ in Figure 1), then $\varphi(x, \alpha) := u^0(x + \alpha)$, $x \in [0, 1]$, $\alpha \in (-\varepsilon, \varepsilon)$, is a field of extremals for u^0 satisfying (18), hence Theorem 14(i) guarantees that u^0 is a minimizer. If $(u^0)''(0) > 0 > (u^0)''(1)$, then the same argument and Theorem 14(ii) show that u^0 is not a minimizer.

Next assume that $(u^0)''(0) \cdot (u^0)''(1) \geq 0$. We will show that u^0 is not a minimizer.

Assume $(u^0)''(0) < 0$, or $(u^0)''(0) = 0$ and $(u^0)'''(0) < 0$ (the cases $(u^0)''(0) > 0$, or $(u^0)''(0) = 0$ and $(u^0)'''(0) > 0$ are analogous). We necessarily have $A_1 = A_0 + 2k_0\pi$ for some $k_0 \in \{1, 2, \dots\}$. Let $\varphi(\cdot, \alpha)$ (with $|\alpha|$ being small) be the extremal with initial values $Z_0 := (\varphi(0, \alpha), \varphi_x(0, \alpha)) = (A_0 + \alpha, K)$ (see the extremal u^0 with $(u^0)'(0) = K_2$ in Figure 1). Then φ is a field of extremals for u^0 , and $\varphi(\cdot, \alpha)$ is a part of the curve ϕ_{C^α} , where C^α is close to C^0 , $C^\alpha > C^0$ if $\alpha > 0$.

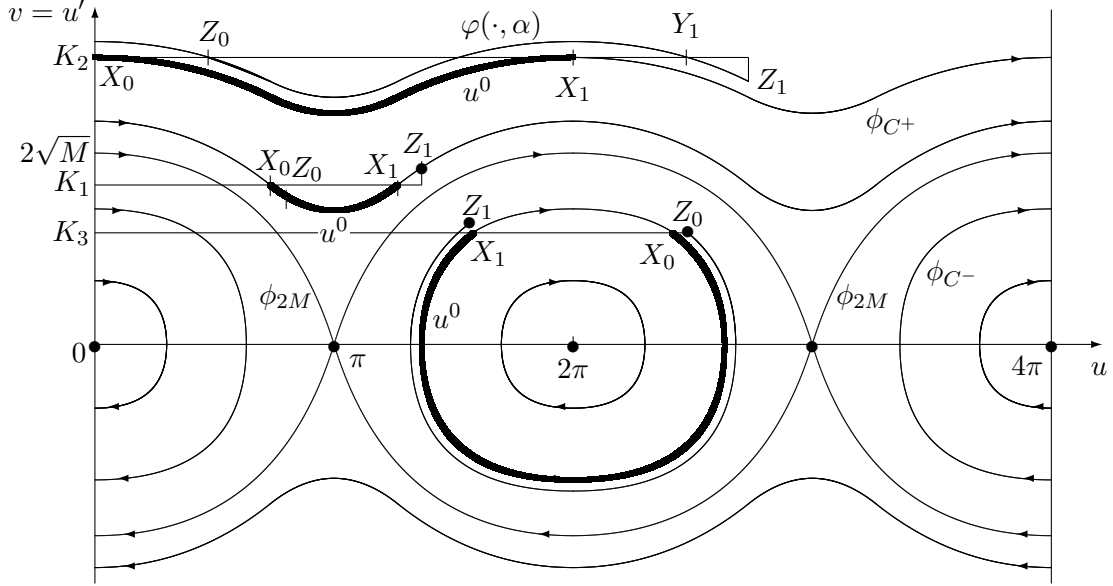

FIGURE 1. Phase plane and extremals for Example 16 and $0 \leq u \leq 4\pi$; $C^- < 2M < C^+$, $Z_i = (\varphi(i, \alpha), \varphi_x(i, \alpha))$, $i = 1, 2$, $Y_1 = (A_1 + \alpha, K)$, $X_i = (A_i, K) = (u^0(i), (u^0)'(i))$, $i = 1, 2$.

Let $\alpha > 0$ be small. If u^1 and u^2 are extremals in ϕ_{C^0} and ϕ_{C^α} , respectively, and $u^1(0) = u^2(0) = 0$, then $u^1(b_1) = u^2(b_2) = 2\pi$ for some $0 < b_1 < b_2$ (due to $(u^2)' > (u^1)'$ whenever $u^2 = u^1$). This fact and the 2π -periodicity of the problem guarantee that $\varphi(b, \alpha) = A_1 + \alpha$ for some $b < 1$, hence $\varphi_x(1, \alpha) < (u^0)'(1)$, and Theorem 14(ii) implies that u^0 is not a minimizer.

Next consider the case $C^0 \in (-2M, 2M]$ and $K \geq 0$; $K \neq 0$ if $C^0 = 2M$. If $K > 0$ and $(u^0)''(0) > 0 > (u^0)''(1)$, then the same arguments as above guarantee that u^0 is not a minimizer. If $K = 0$ or $(u^0)''(0) < 0 < (u^0)''(1)$ (hence $A_1 < A_0$) or $(u^0)''(0) \cdot (u^0)''(1) \geq 0$ (hence $A_0 = A_1 = 2k\pi$), then choosing $\varphi(\cdot, \alpha)$ to be an extremal satisfying initial conditions $(\varphi(0, \alpha), \varphi_x(0, \alpha)) = (A_0 + \alpha, K)$ we see from the phase plane that $\varphi(\cdot, \alpha)$ and u^0 intersect in $(0, 1)$ for any $\alpha \neq 0$ small (if, for example, $(u^0)''(0) < 0 < (u^0)''(1)$ and $\alpha > 0$ is small, then there exists $y \in (0, 1)$ such that $\varphi(y, \alpha) = \min \varphi(\cdot, \alpha) < \min u^0$, and the inequalities $\varphi(0, \alpha) > u^0(0)$, $\varphi(y, \alpha) < u^0(y)$ imply that $\varphi(\cdot, \alpha)$ and u^0 intersect in $(0, y)$; see the extremal u^0 with $(u^0)'(0) = K_3$ in Figure 1). Consequently, $h := \varphi_x(\cdot, 0)$ is a solution of the Jacobi equation satisfying $h(0) = 1$, $h'(0) = 0$, $h(y) = 0$ for some $y \in (0, 1]$, and Theorem 2 guarantees that u^0 is not a minimizer.

Similar considerations as above can be used in the case of constant extremals $k\pi$, but we will use a different argument: If $u^0 \equiv (2k+1)\pi$, then $P = 1$, $Q = -M \cos u^0 = M$, and the solution $h(x) = e^{\sqrt{M}x} + e^{-\sqrt{M}x}$ of the Jacobi equation satisfies $h > 0$, $h'(0) = 0$, $h'(1) > 0$, hence u^0 is a minimizer. If $u^0 \equiv 2k\pi$, then $P = 1$, $Q = -M$ and the solution $h(x) = \cos(\sqrt{M}x)$ of the Jacobi equation satisfies $h(0) > 0$, $h'(0) = 0$ and either $h(x) = 0$ for some $x \in (0, 1]$ or $h'(1) < 0$, hence u^0 is not a minimizer. \square

Example 17. Consider the functional $\Phi(u) = \int_a^b f(u, u') dx$ in $C^1([a, b])$, where $f(u, p) = g(p) + u^2$ and g is a double-well function. More precisely, we will consider the following two cases (see Figure 2):

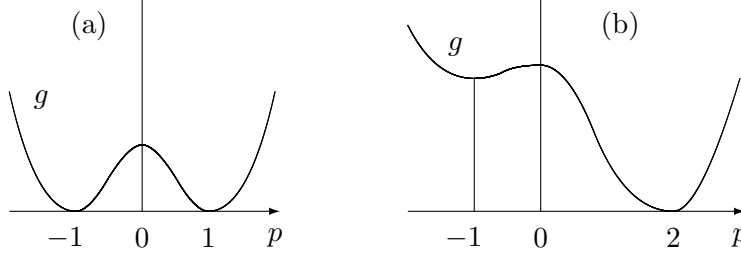

FIGURE 2. Graphs of g in the symmetric and non-symmetric cases.

- (a) $g(p) = (p^2 - 1)^2$ (hence $g'(p) = 4p(p^2 - 1)$, $g''(p) = 4(3p^2 - 1)$),
 (b) $g(p) = \frac{1}{4}p^4 - \frac{1}{3}p^3 - p^2 + \frac{8}{3}$ (hence $g'(p) = (p + 1)p(p - 2)$, $g''(p) = 3p^2 - 2p - 2$).

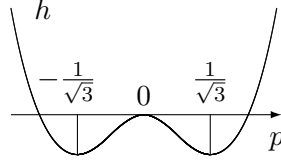

FIGURE 3. Graph of h in the symmetric case.

Let us consider the symmetric case (a) first. The Du Bois-Reymond equation has the form

$$u^2 = C + h(u'), \quad \text{where } h(p) := 3p^4 - 2p^2,$$

see Figures 3 and 4 for the graph of h and the phase plane (u, u') , respectively. All minimizers have to satisfy $u'(a), u'(b) \in \{0, \pm 1\}$; the only constant extremal is $u \equiv 0$.

Since $f_{pp}(u, p) = 4(3p^2 - 1)$, the extremals in the region $|u'| \leq 1/\sqrt{3}$ (satisfying $(u^0)'(a) = (u^0)'(b) = 0$) are not local minimizers (and they also cannot be local maximizers since $\Phi''(u^0)(1, 1) > 0$). The extremal u^* with $(u^*)'(a) = 1$ and $\min(u^*)' = 1/\sqrt{3}$ (see Figure 4) satisfies $u^*(b^*) = 1$ for some $b^* > a$. If $b \in (a, b^*)$, then there exists a unique extremal u^0 satisfying $(u^0)'(a) = (u^0)'(b) = 1$ (and a unique extremal u^1 satisfying $(u^1)'(a) = (u^1)'(b) = -1$); in addition $(u^0)' > 1/\sqrt{3}$ (and $(u^1)' < -1/\sqrt{3}$). Since $P, Q > 0$ and the Weierstrass function $E = (q - p)^2((q + p)^2 + 2(p^2 - 1))$ considered as a function of q changes sign if $|p| < 1$, the extremals u^0, u^1 are weak but not strong minimizers. Notice also that $\inf \Phi = 0$ is not attained (neither in C^1 , nor in $W^{1,4}$): A minimizing sequence in C^1 can be obtained by suitable smooth approximation of piecewise C^1 -functions u_ε satisfying $|u'_\varepsilon| = 1$ a.e. and $|u_\varepsilon| \leq \varepsilon$.

Next consider the nonsymmetric case (b). The Du Bois-Reymond equation has the form

$$u^2 = C + h(u'), \quad \text{where } h(p) := \frac{3}{4}p^4 - \frac{2}{3}p^3 - p^2,$$

see Figures 5 and 6 for the graph of h and the phase plane (u, u') , respectively. All minimizers have to satisfy $u'(a), u'(b) \in \{0, -1, 2\}$; the only constant extremal is $u \equiv 0$.

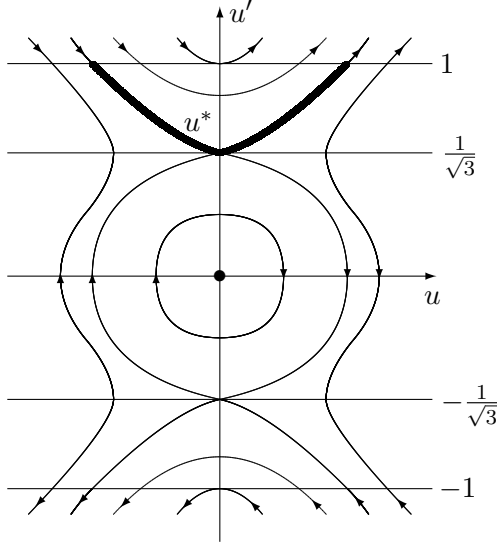
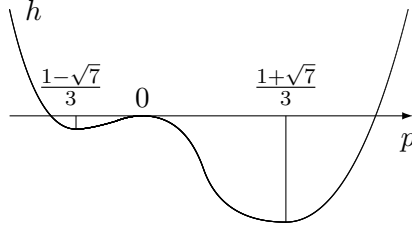

FIGURE 4. Phase plane in the symmetric case.

FIGURE 5. Graph of h in the non-symmetric case.

Since $f_{pp}(u, p) = 3p^2 - 2p - 2$, similarly as in case (a) we see that the extremals in the region $u' \in [\frac{1-\sqrt{7}}{3}, \frac{1+\sqrt{7}}{3}]$ are neither local minimizers nor local maximizers. The extremal u^* with $(u^*)'(a) = 2$ and $\min(u^*)' = \frac{1+\sqrt{7}}{3}$ (see Figure 6) satisfies $u^*(b^*) = 2$ for some $b^* > a$. If $b \in (a, b^*)$, then there exists a unique extremal u^0 satisfying $(u^0)'(a) = (u^0)'(b) = 2$ and, as above, this extremal is a weak local minimizer. However, now $E = \frac{1}{12}(q-p)^2((\sqrt{3}(q+p) - \frac{2}{\sqrt{3}})^2 + 6p^2 - 4p - 13\frac{1}{3}) \geq 0$ for all q if $p \leq p_1$ or $p \geq p_2$, where if $p_1 = \frac{1}{3}(1 - \sqrt{21}) < -1$, $p_2 = \frac{1}{3}(1 + \sqrt{21}) \in (\frac{1}{3}(1 + \sqrt{7}), 2)$, hence u^0 is a strong local minimizer provided $\min(u^0)' > p_2$ (and it is not if $\min(u^0)' < p_2$). In fact, if $\min(u^0)' > p_2$, then the phase plane analysis shows that there exists a global field of extremals for u^0 satisfying the assumptions of Theorem 14(i), with slope $\psi > p_2$, hence u^0 is a global minimizer: If $\alpha > 0$, then the extremals $u^\alpha := \varphi(\cdot, \alpha)$ in the global field can be chosen such that $\varphi(\cdot, \alpha)$ is the solution of the Du Bois-Reymond equation with $(\varphi(0, \alpha), \varphi_x(0, \alpha)) = Z_\alpha$, where $Z_\alpha = (u^0(x + \alpha), (u^0)'(x + \alpha))$ if $\alpha \leq b - a - \varepsilon$ (i.e. $\varphi(x, \alpha) = u^0(x + \alpha)$), $Z_\alpha = (u^0(b) + \alpha - (b - a), 2)$ if $\alpha \geq b - a + \varepsilon$, and Z_α is a smooth function of $\alpha > 0$ such that $\varphi_\alpha > 0$ (see a very similar construction in Example 18). If $\alpha < 0$, then the construction is symmetric (e.g. $\varphi(x, \alpha) = u^0(x + \alpha)$ if $\alpha \geq -(b - a) + \varepsilon$).

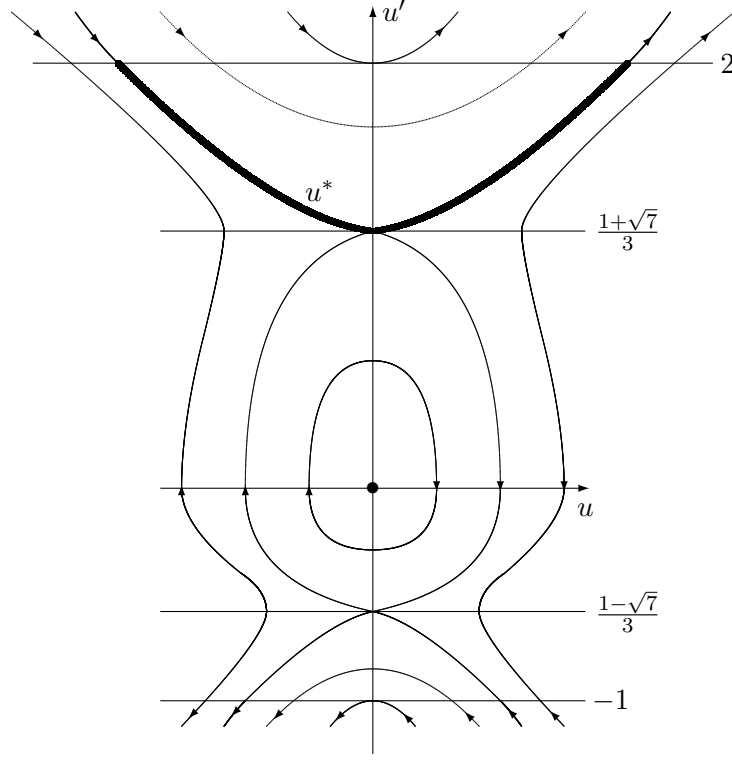

FIGURE 6. Phase plane in the non-symmetric case.

An analogous analysis also shows that the extremals in the region $u' < \frac{1-\sqrt{7}}{3}$ are weak but not strong local minimizers. \square

Example 18. Consider the functional

$$\Phi(u) = \int_0^1 ((u')^4 - 2uu' + 3u^2) dx, \quad u \in C^1([0, 1]),$$

hence $f(u, p) = p^4 - 2up + 3u^2$. We will show that Φ possesses two global minimizers in $X := W^{1,4}([0, 1])$: $u^0(x) = \frac{1}{4}x^2$ and $-u^0$.

We have $\Phi(u^0) = \Phi(-u^0) < 0$. Assume $\Phi(u) \leq \Phi(u^0)$ for some $u \in X$, $u \neq \pm u^0$. Then

$$u^2(0) - u^2(1) = - \int_0^1 2uu' dx \leq \Phi(u) < 0,$$

hence $u(1) \neq 0$. If the function u changes sign, then there exist $x_1 < x_2 < x_3$ such that $u(x_2) = 0$, $u(x_1)u(x_3) < 0$ and u does not change sign in $[x_2, 1]$. Set $\tilde{u}(x) := 0$ for $x \leq x_2$, $\tilde{u}(x) := u(x)$ for $x > x_2$. Then

$$\begin{aligned} \Phi(\tilde{u}) &= \int_{x_2}^1 ((u')^4 - 2uu' + 3u^2) dx \\ &< u^2(0) - u^2(x_2) + \int_0^{x_2} ((u')^4 + 3u^2) dx + \int_{x_2}^1 ((u')^4 - 2uu' + 3u^2) dx = \Phi(u), \end{aligned}$$

and \tilde{u} does not change sign, $\tilde{u} \neq \pm u^0$, hence replacing u with \tilde{u} we can assume that u does not change sign. Since $\Phi(u) = \Phi(-u)$, we can assume $u \geq 0$. This will yield a contradiction if we show that u^0 is the unique global minimizer in the class of nonnegative functions.

One can easily show that Φ is weakly lower semicontinuous and coercive in the reflexive space X , hence it possesses a global minimizer u^1 . The considerations above show that we may assume $u^1 \geq 0$. Since $\Phi \in C^1(X)$, Theorem 9(iv) implies that u^1 is a solution of the integrated Euler equation, and this yields $u^1 \in C^1([0, 1])$. Now Theorem 9 implies that u^1 is a solution of the Du Bois-Reymond equation $(u')^4 = u^2 - C$ for some C . Since $u^1 \geq 0$, we have either $u^1 \equiv 0$ (but this is excluded due to $0 = \Phi(0) > \Phi(u^0)$) or the trajectory of u^1 in the phase plane (see Figure 7) is a part of some of the curves $\phi_C := \{(u, v) : v^4 = u^2 - C\}$. In addition, u^1 has to satisfy the natural boundary conditions, i.e. $(u^1(0), (u^1)'(0))$ and $(u^1(1), (u^1)'(1))$ have to lie on the curve $\{(u, v) : f_p(u, v) = 0\}$. We will show that the only solution of this problem is the function u^0 , whose trajectory is a part of the curve ϕ_0 , hence $u^1 = u^0$. In fact, the solution cannot lie on ϕ_C for $C > 0$, since those curves intersect the curve $\{(u, v) : f_p(u, v) = 0\}$ only once. If $C < 0$, then the curves ϕ_C can intersect the curve $\{(u, v) : f_p(u, v) = 0\}$ twice only for $|C|$ small (see Figure 7), and in such case, the function u^2 , whose trajectory corresponds to the curve ϕ_C between those two intersections, is defined on an interval of length less than one (since $(u^2)'(x) > (u^0)'(x)$ if $u^2(x) = u^0(x)$), hence u^2 is not a solution.

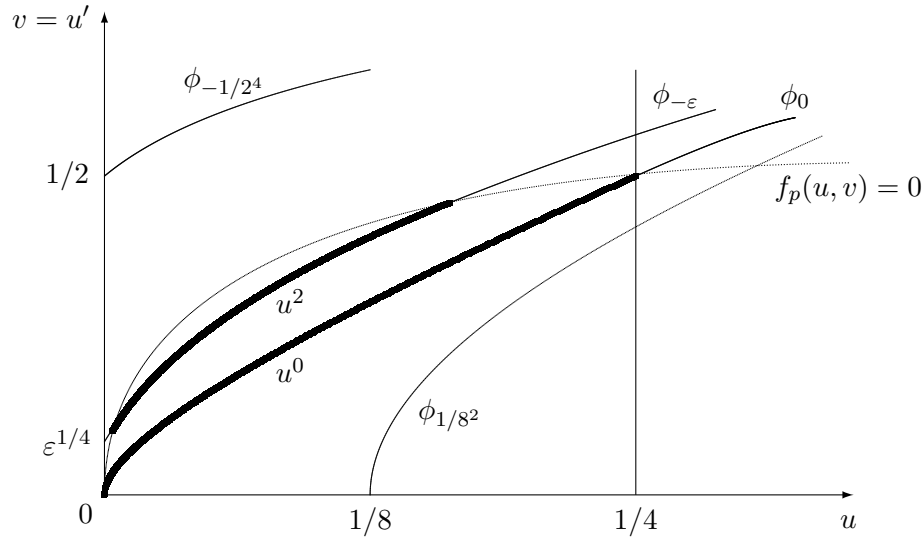

FIGURE 7. Phase plane for $v^4 = u^2 - C$.

We will show that the results above can also be obtained by more classical arguments (which use neither weak lower semicontinuity nor reflexivity). In fact, we will show by using Theorem 14 that u^0 is the only global minimizer of Φ in $\{u \in C^1([0, 1]) : u \geq 0\}$. The continuity of Φ in X and the density of C^1 in X then imply that u^0 is also a global minimizer in $\{u \in X : u \geq 0\}$.

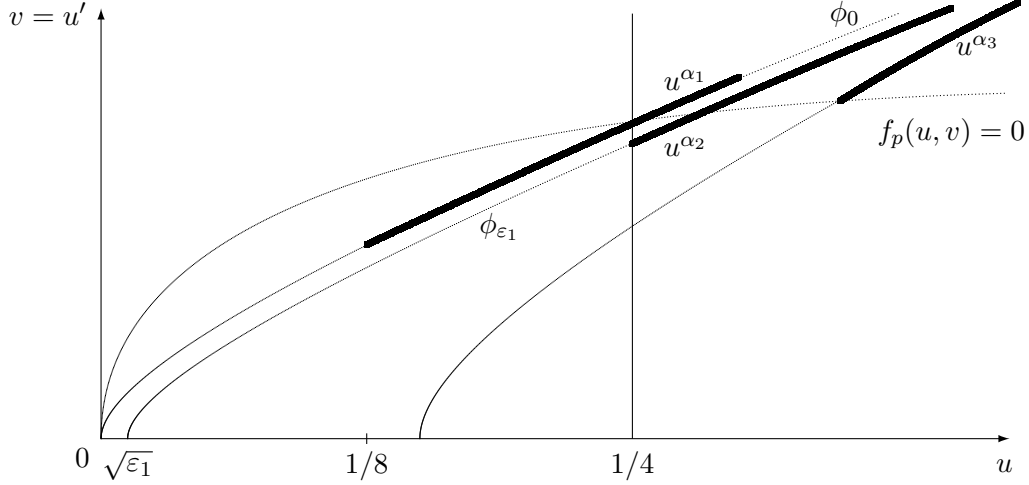

FIGURE 8. Extremals $u^{\alpha_i} := \varphi(\cdot, \alpha_i)$, $0 < \alpha_1 < \frac{1-\varepsilon}{4} < \alpha_2 = \frac{1}{4} < \frac{1+\varepsilon}{4} < \alpha_3$.

The Weierstrass function satisfies $E(x, u, p, q) = (q - p)^2[(q + p)^2 + 2p^2] \geq 0$, hence the proof of Theorem 14 guarantees that it is sufficient to find a field of extremals $\varphi(\cdot, \alpha)$ covering the set $[0, 1] \times [0, \infty)$ and satisfying the conditions $\varphi_\alpha > 0$, $f_p^\alpha(0)\alpha \leq 0 \leq f_p^\alpha(1)\alpha$.

Consider $\varepsilon > 0$ small ($\varepsilon < 1 - \sqrt{8/9}$) and choose smooth functions $C : [0, \infty) \rightarrow [0, \infty)$ and $h : [0, 1/4] \rightarrow [0, 1]$ such that

$$0 \leq C'(\alpha) < 2\alpha, \quad C(\alpha) = 0 \text{ if } \alpha \leq \frac{1-\varepsilon}{4}, \quad C(\alpha) = \alpha^2 - \left(\frac{\alpha}{2}\right)^{4/3} \text{ if } \alpha \geq \frac{1+\varepsilon}{4},$$

$$h' > 0, \quad h(\alpha) = \alpha \text{ if } \alpha \leq \varepsilon, \quad h(\alpha) = 2\sqrt{\alpha} \text{ if } \alpha \geq \frac{1}{8}.$$

If $\alpha < 0$, then set $\varphi(x, \alpha) = \left(\frac{x+\alpha}{2}\right)^2$ for $x \in [-\alpha, 1]$. If $\alpha \geq 0$, then we choose $\varphi(\cdot, \alpha)$ to be the solution of the ODE $\varphi_x(0, \alpha) = (\varphi(\cdot, \alpha)^2 - C(\alpha))^{1/4}$ with initial value

$$\varphi(0, \alpha) = \left(\frac{h(\alpha)}{2}\right)^2 \text{ if } \alpha \leq \frac{1-\varepsilon}{4}, \quad \varphi(0, \alpha) = \alpha \text{ if } \alpha > \frac{1-\varepsilon}{4}.$$

Then $f_p^\alpha(1) < 0$ if $\alpha < 0$ and $f_p^\alpha(0) \leq 0 < f_p^\alpha(1)$ if $\alpha > 0$ (cf. Figure 8).

It remains to show that $\varphi_\alpha > 0$. Assume first $\alpha > \frac{1}{8}$, and denote $w(x) := \varphi_\alpha(x, \alpha)$. Since $\varphi_x = (\varphi^2 - C(\alpha))^{1/4}$ and $w(0) = 1$, we have

$$w' = \frac{2\varphi(\cdot, \alpha)w - C'(\alpha)}{4(\varphi(\cdot, \alpha)^2 - C(\alpha))^{3/4}} \geq 0, \quad w \geq 1,$$

due to $C'(\alpha) < 2\alpha$ and $\varphi(\cdot, \alpha) \geq \varphi(0, \alpha) = \alpha$, hence $\varphi_\alpha > 0$.

Finally let $\alpha \leq \frac{1}{8}$. If $x + \alpha > 0$, then the inequality $\varphi_\alpha > 0$ can be easily verified by a direct computation. If $x + \alpha = 0$ (hence $\alpha \leq 0$), then $\varphi(x, \alpha) = 0$ and $\lim_{\alpha \rightarrow 0^+} \frac{1}{\alpha} \varphi(x, \alpha) = 0$, but the proof of Theorem 14 shows that u^0 is a global minimizer in the class of nonnegative C^1 functions. In addition, that proof implies that $\Phi(u) > \Phi(u^0)$ for each $u \in C^1$ satisfying $u \geq 0$, $u \not\equiv u^0$. \square

7. STABILITY OF A TWISTED ROD

In this section we use Theorem 3 in order to determine the stability of an unbuckled state of an inextensible, unshearable, isotropic Kirchhoff rod. Under suitable assumptions the strain energy of the rod is given by

$$\Phi(u) = \int_0^1 \left(\frac{A}{2} ((u'_1)^2 + (u'_2)^2 \sin^2 u_1) + \frac{C}{2} (u'_3 + u'_2 \cos u_1)^2 + FL^2 \sin u_1 \cos u_2 \right) dx,$$

where u_1, u_2, u_3 are so called Euler angles describing the orientation of the director basis, $A, C > 0$ are constants, L is the rod-length and $F \in \mathbb{R}$ is an external terminal load, see [13, (9)]. The unbuckled state is given by $u^0(x) := (\frac{\pi}{2}, 0, 2\pi Mx)$ where M is a twist parameter. Notice that u^0 is an extremal satisfying the natural boundary conditions $f_{p_i}^0(x) = 0$ for $i = 1, 2$ and $x = 0, 1$. The stability of u^0 was studied in [13] under the fixed boundary condition $u_3(x) = u_3^0(x)$ for $x = 0, 1$, and one of the following sets of boundary conditions for u_1, u_2 :

$$u_1(0) = u_1(1) = \pi/2, \quad u_2(0) = u_2(1) = 0, \quad (21)$$

$$u_1(0) = u_1(1) = \pi/2, \quad u'_2(0) = u'_2(1) = 0, \quad (22)$$

$$u'_1(0) = u'_1(1) = 0, \quad u'_2(0) = u'_2(1) = 0. \quad (23)$$

The results in [13] are essentially optimal in the case (21), but the results in the cases (22) and (23) are only partial, leaving several open problems. Notice that the Neumann boundary conditions are not the same as the natural boundary conditions in general (see [15] for related issues), but one can easily show that the problem of stability of u^0 considered in [13] in cases (22) and (23) is equivalent to the question whether u^0 is a weak minimizer of Φ in $u^0 + C_{\mathcal{D}}^1$ with $I_0^{\mathcal{N}}, I_1^{\mathcal{N}} = \{2\}$ and $I_0^{\mathcal{N}}, I_1^{\mathcal{N}} = \{1, 2\}$, respectively, hence we can use Theorem 3 in order to solve those problems. In fact, we will consider all possible subsets $I_0^{\mathcal{N}}, I_1^{\mathcal{N}}$ of $\{1, 2\}$, and in each case we will find the borderline between the stability and instability (i.e. between the situations when u^0 is and is not a weak minimizer). In order to have a more graphic notation, given $I_0^{\mathcal{N}}, I_1^{\mathcal{N}}$, we denote the corresponding case by $(\begin{smallmatrix} C_{11}C_{12} \\ C_{21}C_{22} \end{smallmatrix})$, where $C_{ij} = \mathcal{N}$ if $i \in I_j^{\mathcal{N}}$, $C_{ij} = \mathcal{D}$ otherwise. For example, $(\begin{smallmatrix} \mathcal{D}\mathcal{D} \\ \mathcal{N}\mathcal{N} \end{smallmatrix})$ corresponds to the case $I_0^{\mathcal{N}} = I_1^{\mathcal{N}} = \{2\}$, i.e. (22). Set also

$$\alpha := \frac{2\pi CM}{A}, \quad \beta := -\frac{FL^2}{A}, \quad \gamma := \sqrt{\left| \beta - \frac{1}{4}\alpha^2 \right|}, \quad \delta := \frac{\alpha}{2}, \quad \theta := \frac{2\gamma\delta}{\gamma^2 + \delta^2}.$$

We will show that we may assume $\alpha > 0$, and for any $(\begin{smallmatrix} C_{11}C_{12} \\ C_{21}C_{22} \end{smallmatrix})$ with $C_{ij} \in \{\mathcal{D}, \mathcal{N}\}$ we will find a function $g = g_{\begin{smallmatrix} C_{11}C_{12} \\ C_{21}C_{22} \end{smallmatrix}} : (0, \infty) \rightarrow \mathbb{R} : \alpha \mapsto \beta$ which describes the borderline between stability and instability. In the particular cases (21), (22) and (23) we will also use the notation

$$g_{\mathcal{D}} := g_{\mathcal{D}\mathcal{D}}, \quad g_{\mathcal{M}} := g_{\mathcal{N}\mathcal{N}}, \quad \text{and} \quad g_{\mathcal{N}} := g_{\mathcal{N}\mathcal{N}},$$

respectively (the notation $g_{\mathcal{M}}$ reflects the fact that case (22) is called ‘‘Mixed’’ in [13, (13)]).

Proposition 19. *Let u^0 be as above, $\alpha > 0$, and let $I_0^{\mathcal{N}}, I_1^{\mathcal{N}} \subset \{1, 2\}$ be fixed. Then there exists a continuous function $g : (0, \infty) \rightarrow \mathbb{R}$ having the properties mentioned above, i.e. if $\beta > g(\alpha)$ or $\beta < g(\alpha)$, then u^0 is or is not a weak minimizer, respectively.*

(i) Let $I_0^{\mathcal{D}} \neq \emptyset \neq I_1^{\mathcal{D}}$. Then

$$g_{\mathcal{N}\mathcal{D}}^{\mathcal{D}\mathcal{D}} = g_{\mathcal{D}\mathcal{N}}^{\mathcal{D}\mathcal{D}} = g_{\mathcal{D}\mathcal{D}}^{\mathcal{D}\mathcal{N}} = g_{\mathcal{D}\mathcal{D}}^{\mathcal{N}\mathcal{D}}, \quad g_{\mathcal{N}\mathcal{D}}^{\mathcal{D}\mathcal{N}} = g_{\mathcal{D}\mathcal{N}}^{\mathcal{N}\mathcal{D}}, \quad g_{\mathcal{N}\mathcal{N}}^{\mathcal{D}\mathcal{D}} = g_{\mathcal{D}\mathcal{D}}^{\mathcal{N}\mathcal{N}} (= g_M), \quad (24)$$

$$\left. \begin{aligned} g_D(\alpha) &= \frac{\alpha^2}{4} - \pi^2, & g_{\mathcal{N}\mathcal{D}}^{\mathcal{D}\mathcal{D}}(\alpha) &= \frac{\alpha^2}{4} - \frac{\pi^2}{4}, \\ g_{\mathcal{N}\mathcal{D}}^{\mathcal{D}\mathcal{N}}(\alpha) &= (k + \frac{1}{2})\pi(\alpha - (k + \frac{1}{2})\pi) & \text{if } \alpha \in [2k\pi, 2(k+1)\pi], & \quad k = 0, 1, 2, \dots, \\ g_M(\alpha) &= k\pi(\alpha - k\pi) & \text{if } \alpha \in [(2k-1)\pi, (2k+1)\pi], & \quad k = 0, 1, 2, \dots \end{aligned} \right\} \quad (25)$$

(ii) Let either $I_0^{\mathcal{D}} = \emptyset$ or $I_1^{\mathcal{D}} = \emptyset$. Then

$$g_{\mathcal{N}\mathcal{D}}^{\mathcal{N}\mathcal{D}} = g_{\mathcal{D}\mathcal{N}}^{\mathcal{D}\mathcal{N}}, \quad g_{\mathcal{N}\mathcal{N}}^{\mathcal{N}\mathcal{N}} = g_{\mathcal{D}\mathcal{N}}^{\mathcal{N}\mathcal{N}}, \quad g_{\mathcal{N}\mathcal{D}}^{\mathcal{N}\mathcal{D}} = g_{\mathcal{N}\mathcal{N}}^{\mathcal{D}\mathcal{N}}, \quad (26)$$

$$g_N(\alpha) = \inf\{\beta \geq \frac{1}{2}\alpha^2 : (1 - \theta^2) \cosh(2\gamma) + \theta^2 \cos(2\delta) = 1\} \in [\frac{1}{2}\alpha^2, \alpha^2],$$

$$g_{\mathcal{N}\mathcal{D}}^{\mathcal{N}\mathcal{D}}(\alpha) = \begin{cases} \sup\{\beta \in (\frac{1}{4}\alpha^2, \frac{1}{2}\alpha^2) : (\alpha^2 - 2\beta) \cosh(2\gamma) = 2\beta\} & \text{if } \alpha > 2, \\ \frac{1}{4}\alpha^2 & \text{if } \alpha = 2, \\ \sup\{\beta \in (\frac{1}{4}(\alpha^2 - \pi^2), \frac{1}{4}\alpha^2) : (\alpha^2 - 2\beta) \cos(2\gamma) = 2\beta\} & \text{if } \alpha \in (0, 2), \end{cases}$$

$$g_{\mathcal{N}\mathcal{D}}^{\mathcal{N}\mathcal{N}}(\alpha) = \inf\{\beta \geq \beta_\alpha : (\gamma^2 - \delta^2) \sinh(2\gamma) = 2\gamma\delta \sin(2\delta)\}, \quad \beta_\alpha := \begin{cases} \frac{1}{2}\alpha^2 & \text{if } \alpha \leq \pi, \\ g_{\mathcal{N}\mathcal{D}}^{\mathcal{N}\mathcal{D}}(\alpha) & \text{if } \alpha > \pi, \end{cases}$$

$$g_{\mathcal{N}\mathcal{N}}^{\mathcal{N}\mathcal{D}}(\alpha) = \begin{cases} \inf\{\beta \geq g_{\mathcal{N}\mathcal{D}}^{\mathcal{N}\mathcal{D}}(\alpha) : (\gamma^2 - \delta^2) \sinh(2\gamma) = -2\gamma\delta \sin(2\delta)\} & \text{if } \alpha \geq \alpha_0, \\ \inf\{\beta \geq g_{\mathcal{N}\mathcal{D}}^{\mathcal{N}\mathcal{D}}(\alpha) : \xi_1^2 \sin \xi_2 \cos \xi_1 = \xi_2^2 \sin \xi_1 \cos \xi_2\} & \text{if } \alpha \in (\frac{1}{2}\pi, \alpha_0), \\ 0 & \text{if } \alpha \in (0, \frac{1}{2}\pi], \end{cases}$$

where $\xi_i := -\frac{1}{2}\alpha \pm \gamma$ and $\alpha_0 > 0$ is defined by $\alpha_0 = 2 \sin \alpha_0$.

Remark 20. (i) If u^0 is a weak minimizer of Φ with given $I_0^{\mathcal{N}}, I_1^{\mathcal{N}}$ (and the borderline function g), then it remains a weak minimizer if we replace $I_x^{\mathcal{N}}$ with any subset of $I_x^{\mathcal{N}}$ for $x = 0, 1$, since the set $C_{\mathcal{D}}^1$ becomes smaller. Therefore the new borderline function \tilde{g} has to satisfy $\tilde{g} \leq g$. In particular, $g_D \leq g \leq g_N$ for any borderline function g , $g_{\mathcal{N}\mathcal{D}}^{\mathcal{N}\mathcal{D}} \leq \min(g_{\mathcal{N}\mathcal{N}}^{\mathcal{N}\mathcal{N}}, g_{\mathcal{N}\mathcal{D}}^{\mathcal{N}\mathcal{D}})$, and $g_{\mathcal{N}\mathcal{D}}^{\mathcal{N}\mathcal{D}}(\alpha) \geq g_{\mathcal{D}\mathcal{D}}^{\mathcal{D}\mathcal{D}}(\alpha) = \frac{1}{4}(\alpha^2 - \pi^2)$. We also have $g_N(\alpha) \leq \alpha^2$ since the Cauchy inequality implies that the corresponding functional Ψ is positive definite for $\beta > \alpha^2$.

(ii) If $\alpha \in (0, \alpha_0)$ is fixed, then the function $\Xi(\beta) := \xi_1^2 \sin \xi_2 \cos \xi_1 - \xi_2^2 \sin \xi_1 \cos \xi_2$ appearing in the formula for $g_{\mathcal{N}\mathcal{N}}^{\mathcal{N}\mathcal{D}}$ in Proposition 19 has a unique root β^* in the interval $[g_{\mathcal{N}\mathcal{D}}^{\mathcal{N}\mathcal{D}}(\alpha), \frac{1}{4}\alpha^2)$: This follows from our proof, since any root in that interval corresponds to the case when the corresponding functional Ψ is positive semidefinite but not positive definite, and the form of Ψ guarantees that, given α , this can happen only for one β . Consequently,

$$g_{\mathcal{N}\mathcal{N}}^{\mathcal{N}\mathcal{D}}(\alpha) = \sup\{\alpha < \frac{1}{4}\alpha^2 : \xi_1^2 \sin \xi_2 \cos \xi_1 = \xi_2^2 \sin \xi_1 \cos \xi_2\} \quad \text{if } \alpha \in (0, \alpha_0).$$

In addition, our proof implies that if $\beta^* > g_{\mathcal{N}\mathcal{D}}^{\mathcal{N}\mathcal{D}}(\alpha)$, then Ξ changes sign at β^* . Similarly, if $\alpha > \alpha_0$ (or $\alpha > 0$, resp.), then the function $(\gamma^2 - \delta^2) \sinh(2\gamma) + 2\gamma\delta \sin(2\delta)$ (or $(\gamma^2 - \delta^2) \sinh(2\gamma) - 2\gamma\delta \sin(2\delta)$, resp.) has a unique root β^* in the interval $[g_{\mathcal{N}\mathcal{D}}^{\mathcal{N}\mathcal{D}}(\alpha), \infty)$ (or $[\beta_\alpha, \infty)$, resp.), and it changes sign at β^* if $\beta^* > g_{\mathcal{N}\mathcal{D}}^{\mathcal{N}\mathcal{D}}(\alpha)$ (or $\beta^* > \beta_\alpha$, resp.). In addition, the estimates in (i) guarantee that that root β^* satisfies $\beta^* \leq g_N(\alpha) \leq \alpha^2$. Analogous statements are true in the case of g_N .

(iii) The borderline function g_M was estimated above and below in [13] by functions

$$\overline{g_M}(\alpha) := \max(0, \alpha^2 - \pi^2) \quad \text{and} \quad \underline{g_M}(\alpha) := (\alpha^2 - \pi^2)/(\alpha^2 + \pi^2),$$

respectively, see Figure 9. The authors of [13] also provided the upper bound $\overline{g_N}(\alpha) := \frac{1}{4}\alpha^2$ for $g_N(\alpha)$, but that bound is incorrect: The error in their proof is explained below.

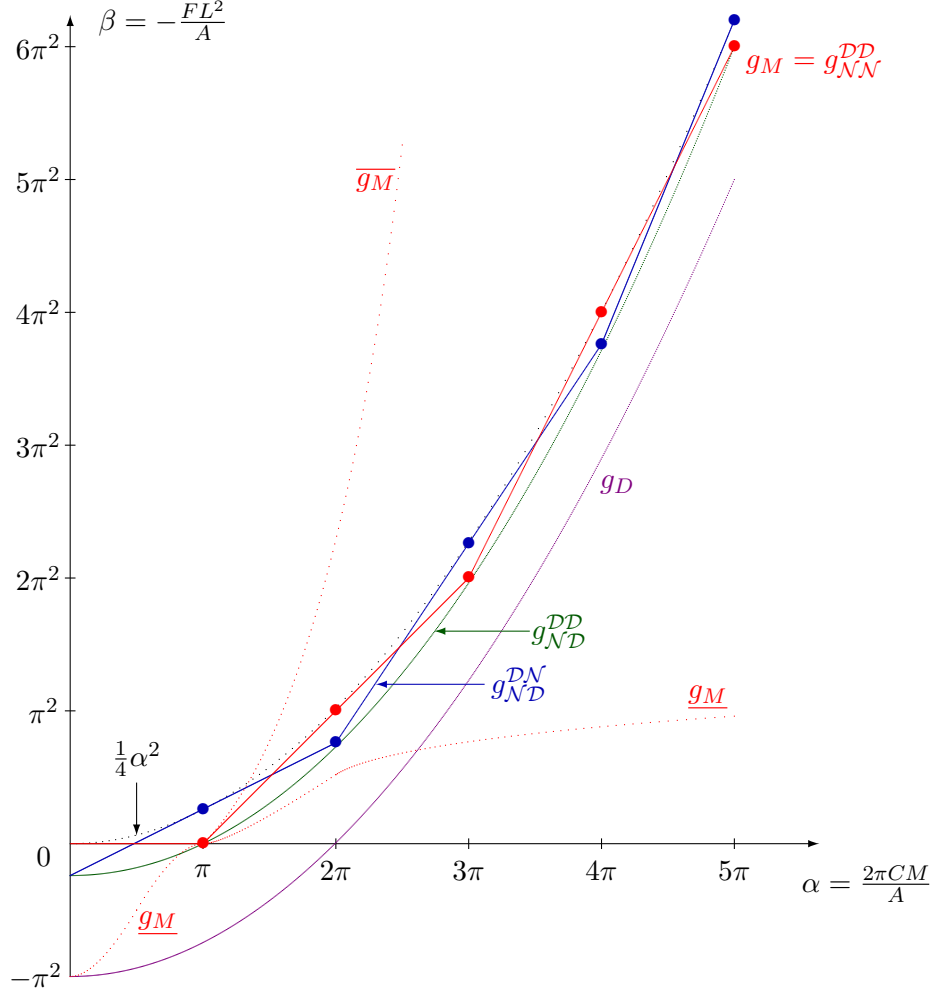
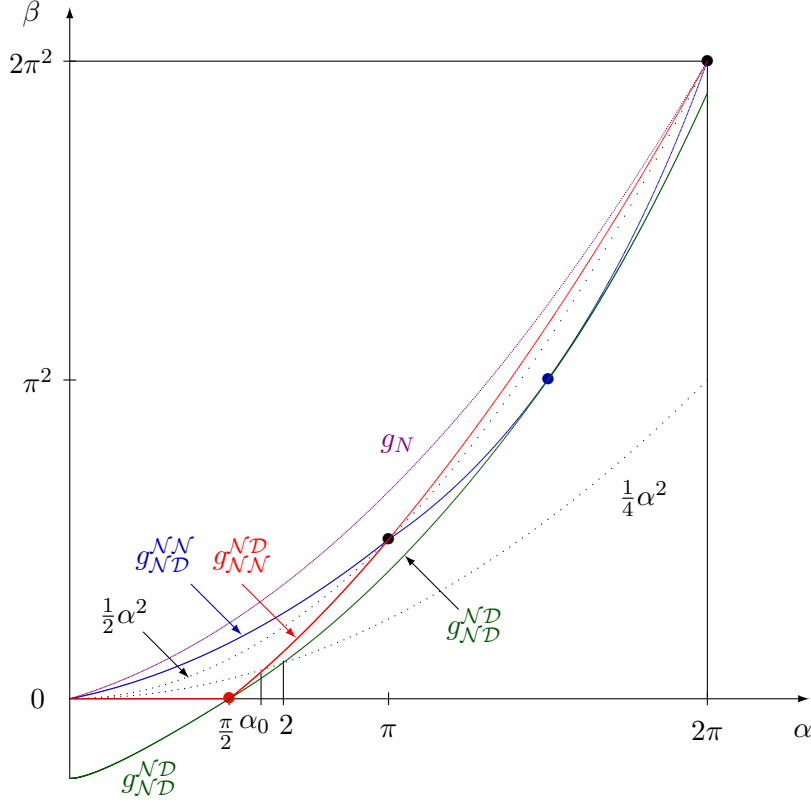

FIGURE 9. The case $I_0^D \neq \emptyset \neq I_1^D$.

(iv) We have $g_M(\alpha) > g_{N^D}^D(\alpha)$ except for $\alpha = \alpha_k := (2k - 1)\pi$, $k = 1, 2, \dots$. If $\alpha = \alpha_k$ and $\beta = g_{N^D}^D(\alpha) = g_M(\alpha)$, then the function D in Theorem 3 satisfies $D > 0$ in $(0, 1)$, $D(1) = 0$, and these facts show that the condition (6) is also necessary for the instability statement $\Psi(h) < 0$ for some $h \in W_D^{1,2}$. For example, if $k = 2$ (i.e. $\alpha = 3\pi$, $\beta = 2\pi^2$), then our proof shows that H_0 is spanned by $h(x) := (-\sin(\pi x) - \sin(2\pi x), \cos(\pi x) + \cos(2\pi x))$ and $\mathcal{B}_2 h(1) = h_2(1) = h_1(1) = 0$ which violates (6). This degeneracy seems to be also responsible for the non-smooth behavior of g_M at $\alpha = \alpha_k$.

FIGURE 10. The case $I_0^D = \emptyset$.TABLE 1. Numerical values of functions g and $\Delta_{\max} := g_N - g_{ND}^{ND}$ if $I_0^D = \emptyset$.

α/π	$g_N(\alpha)/\pi^2$	$g_{NN}^{NN}(\alpha)/\pi^2$	$\hat{g}(\alpha)/\pi^2$	$g_{NN}^{ND}(\alpha)/\pi^2$	$g_{ND}^{ND}(\alpha)/\pi^2$	$\Delta_{\max}(\alpha)/\pi^2$
0	0	0	0	0	-0.25	0.25
0.3	0.0842	0.0732	0.045	0.0000	-0.1222	0.2064
0.5	0.2137	0.1679	0.125	0.0000	0.0000	0.2137
0.7	0.3792	0.2820	0.245	0.1826	0.1533	0.2258
1.0	0.6717	0.5000	0.500	0.5000	0.4446	0.2271
1.3	1.0067	0.8197	0.845	0.8663	0.8129	0.1938
1.5	1.2549	1.1032	1.125	1.1440	1.1032	0.1516
1.7	1.5279	1.4334	1.445	1.4558	1.4305	0.0973
2.0	2.0000	2.0000	2.000	2.0000	1.9923	0.0076
2.5	3.2058	3.1274	3.125	3.1225	3.1225	0.0832
3.0	4.5759	4.5000	4.500	4.5000	4.4992	0.0767
3.5	6.1596	6.1248	6.125	6.1252	6.1248	0.0348
4.0	8.0000	8.0000	8.000	8.0000	7.9999	0.0001

(v) The function $\hat{g}(\alpha) := \frac{1}{2}\alpha^2$ is a good approximation of functions g in Proposition 19(ii) for α large, see Table 1 and Figure 10. The functions g_{NN}^{ND}, g_{ND}^{NN} oscillate between g_N and

$g_{\mathcal{N}\mathcal{D}}^{\mathcal{N}\mathcal{D}}$, they intersect each other whenever $\alpha = k\pi$, $k = 1, 2, \dots$, and then their common values equal $\hat{g}(\alpha)$ (and also $g_N(\alpha)$ if k is even). Similarly, $\min(g_{\mathcal{N}\mathcal{N}}^{\mathcal{N}\mathcal{D}}(\alpha), g_{\mathcal{N}\mathcal{D}}^{\mathcal{N}\mathcal{N}}(\alpha)) = g_{\mathcal{N}\mathcal{D}}^{\mathcal{N}\mathcal{D}}(\alpha)$ if $\alpha = (k + \frac{1}{2})\pi$, $k = 0, 1, 2, \dots$. Similar behavior of functions $\tilde{g}(\alpha) = \frac{1}{4}\alpha^2$ and $g_M, g_{\mathcal{N}\mathcal{D}}^{\mathcal{D}\mathcal{N}}, g_{\mathcal{N}\mathcal{D}}^{\mathcal{D}\mathcal{D}}$ can be observed in Figure 9. The formulas for functions g in Proposition 19(ii) can be used in the numerical computations of g , but they also can be used in the study of the asymptotic or qualitative behavior of g . For example, they imply that $\lim_{\alpha \rightarrow 0^+} \frac{g_N(\alpha)}{\alpha^2} = 1$, $\lim_{\alpha \rightarrow \infty} (\hat{g} - g_{\mathcal{N}\mathcal{D}}^{\mathcal{N}\mathcal{D}})(\alpha) = 0$, $g_{\mathcal{N}\mathcal{D}}^{\mathcal{N}\mathcal{D}}$ is $C^1 \setminus C^2$ at $\alpha = 2$, and g_N is $C \setminus C^1$ at $\alpha = 2k\pi$, $k = 1, 2, \dots$.

(vi) Numerical computations determining the borderlines for stability could be used also if we did not know the formulas for functions g in Proposition 19. Given (α_0, β_0) such that the problem with parameters (α_0, β_0) is unstable, it is sufficient to numerically solve the Jacobi equations with suitable initial conditions (by the Euler method, for example), with $\beta_k := \beta_0 + k\varepsilon$, $k = 1, 2, \dots$, until the sufficient condition for the stability is met. Alternatively, if $\beta_0 < \beta_1$ and the problem with parameters (α_0, β_0) or (α_0, β_1) is stable or unstable, respectively, then one can set $\beta_2 := (\beta_0 + \beta_1)/2$, and, if the problem with parameters (α_0, β_2) is stable or unstable, set $\beta_3 := (\beta_0 + \beta_2)/2$ or $\beta_3 := (\beta_2 + \beta_1)/2$, respectively, etc. In fact, we used such general approach to compute the numerical values of functions g_N and $g_{\mathcal{N}\mathcal{D}}^{\mathcal{N}\mathcal{D}}$ first, and we verified a posteriori that the computed critical parameters correspond to the critical values determined by Proposition 19. \square

Proof of Proposition 19. Notice that u^0 is a critical point of Φ for any choice of $I_0^{\mathcal{N}}, I_1^{\mathcal{N}} \subset \{1, 2\}$. By Remark 4(i) we have to determine the positivity of the functional Ψ in $W_{\mathcal{D}}^{1,2}$. We have $\Psi(h) = \Psi_1(h_1, h_2) + \Psi_2(h_3)$, where

$$\Psi_1(h_1, h_2) = A \int_0^1 ((h_1')^2 + (h_2')^2 - 2\alpha h_2' h_1 + \beta(h_1^2 + h_2^2)) dx, \quad \Psi_2(h_3) = C \int_0^1 (h_3')^2 dx.$$

Since the positivity of Ψ does not change if we replace α by $-\alpha$ (consider $-h_1$ instead of h_1), we may assume $\alpha \geq 0$. Since the case $\alpha = 0$ is trivial, we assume $\alpha > 0$. Since Ψ_2 is positive definite in $W_0^{1,2}([0, 1])$, it is sufficient to study the positivity of $\tilde{\Psi} := \frac{1}{2A}\Psi_1$. The existence of continuous borderline functions g follows from the form of $\tilde{\Psi}$. The corresponding system of Jacobi equations is

$$\begin{aligned} h_1'' + \alpha h_2' - \beta h_1 &= 0, \\ h_2'' - \alpha h_1' - \beta h_2 &= 0, \end{aligned} \tag{27}$$

and the initial conditions for $h^{(1)}, h^{(2)}$ in Theorem 3 are $h_i = 0$ if $i \notin I_0^{\mathcal{N}}$, $h_1' = 0$ if $1 \in I_0^{\mathcal{N}}$, and $h_2' = \alpha h_1$ if $2 \in I_0^{\mathcal{N}}$.

Notice that if $I_0^{\mathcal{D}} \neq \emptyset \neq I_1^{\mathcal{D}}$, then $h_1 h_2(0) = h_1 h_2(1) = 0$ for any $h \in W_{\mathcal{D}}$, hence

$$\int_0^1 h_2' h_1 dx = - \int_0^1 h_1' h_2 dx. \tag{28}$$

Identity (28) shows that the value of Ψ does not change if we replace h_1 with h_2 and α with $-\alpha$. In general, the value of Ψ does not change if we replace h_i with $\tilde{h}_i(x) = h_i(1-x)$ and α with $-\alpha$. These two observations guarantee (24) and (26).

Let us first consider the cases in Proposition 19(i), i.e. $I_0^{\mathcal{D}} \neq \emptyset \neq I_1^{\mathcal{D}}$. Then (28) guarantees $\int_0^1 2h_2' h_1 dx = \int_0^1 (h_2' h_1 - h_1' h_2) dx$ and the Cauchy inequality implies that $\tilde{\Psi}$ is positive definite if $\alpha^2 < 4\beta$. Hence it is sufficient to study the case $\alpha^2 \geq 4\beta$.

The case $\binom{\mathcal{D}\mathcal{D}}{\mathcal{D}\mathcal{D}}$ has already been solved in [13, Proposition 3], but Theorem 3 enables us to show $g_{\mathcal{D}}(\alpha) = \frac{\alpha^2}{4} - \pi^2$ in a simpler way. Assume $\alpha^2 > 4\beta$. We can set $h^{(1)}(x) = (\sin \xi_1 x - \sin \xi_2 x, \cos \xi_1 x - \cos \xi_2 x)$ and $h^{(2)}(x) = (-\cos \xi_1 x + \cos \xi_2 x, \sin \xi_1 x - \sin \xi_2 x)$, where $\xi_{1,2} = -\frac{1}{2}\alpha \pm \gamma$. The function D in Theorem 3 satisfies $D(x) = 2 - \cos(\xi_1 - \xi_2)x$, hence $D \neq 0$ in $(0, 1]$ if and only if $|\xi_1 - \xi_2| < 2\pi$, i.e. if $\beta > g_{\mathcal{D}}(\alpha)$. Consequently, if $\beta > g_{\mathcal{D}}(\alpha)$, then u^0 is a weak minimizer (this remains true also if $4\beta = \alpha^2$ due to the monotonicity of $\tilde{\Psi}$ with respect to β), and if $\beta < g_{\mathcal{D}}(\alpha)$, then u^0 is not a weak minimizer.

The remaining cases in Proposition 19(i) are $\binom{\mathcal{D}\mathcal{D}}{\mathcal{N}\mathcal{D}}$, $\binom{\mathcal{D}\mathcal{N}}{\mathcal{N}\mathcal{D}}$, and $\binom{\mathcal{D}\mathcal{D}}{\mathcal{N}\mathcal{N}}$. Since we may assume $\alpha^2 \geq 4\beta$, we will distinguish two subcases:

- (i-1) $\alpha^2 > 4\beta$,
- (i-2) $\alpha^2 = 4\beta$.

(i-1) Assume $\alpha^2 > 4\beta$. One can easily check that we can set $h^{(i)}(x) := (\sin \xi_i x, \cos \xi_i x)$, $i = 1, 2$, where $\xi_{1,2} := -\frac{1}{2}\alpha \pm \gamma$. The function D in Theorem 3 satisfies $D(x) = \sin(\xi_1 - \xi_2)x$, hence $D \neq 0$ in $(0, 1]$ if and only if $|\xi_1 - \xi_2| < \pi$, i.e. if $\alpha^2 - 4\beta < \pi^2$. If $I_1^{\mathcal{N}} = \emptyset$, then this solves our problem, i.e. we obtain $g_{\mathcal{N}\mathcal{D}}^{\mathcal{D}\mathcal{D}}(\alpha) = \frac{\alpha^2}{4} - \frac{\pi^2}{4}$. If $I_1^{\mathcal{N}} = \{2\}$, then $H_{\mathcal{D},b}$ is spanned by $h := \sin \xi_2 h^{(1)} - \sin \xi_1 h^{(2)}$. We have

$$B := \mathcal{B}h(1) \cdot h(1) = h'_2(1)h_2(1) = (\xi_2 - \xi_1) \sin(\xi_2 - \xi_1) \sin \xi_1 \sin \xi_2$$

and, assuming $\alpha \in [(2k-1)\pi, (2k+1)\pi]$, $k = 1, 2, \dots$, we have $B > 0$ or $B < 0$ if and only if $\beta > k\pi(\alpha - k\pi)$ or $\beta < k\pi(\alpha - k\pi)$, respectively. If $\alpha \in (0, \pi)$, then $B > 0$ or $B < 0$ if $\beta > 0$ or $\beta < 0$, respectively.

- (i-2) If $\alpha^2 = 4\beta$, then one can set

$$h^{(1)}(x) := (\sin \xi x, \cos \xi x) \quad \text{and} \quad h^{(2)}(x) := (x \cos \xi x, -x \sin \xi x), \quad \text{where } \xi := -\alpha/2,$$

hence $D(x) = x \neq 0$ for any $x > 0$. If $I_1^{\mathcal{N}} = \{2\}$, then $H_{\mathcal{D},b}$ is spanned by $h := (\cos \xi)h^{(1)} - (\sin \xi)h^{(2)}$ and

$$\mathcal{B}h(1) \cdot h(1) = h'_2(1)h_2(1) = \sin^2 \xi > 0$$

whenever $\alpha \neq 2\pi k$. This shows that the formula for g_M in (25) is true. The formula for $g_{\mathcal{N}\mathcal{D}}^{\mathcal{D}\mathcal{N}}$ can be obtained by the same way.

Next consider the cases in Proposition 19(ii), i.e. $\binom{\mathcal{N}\mathcal{D}}{\mathcal{N}\mathcal{D}}$, $\binom{\mathcal{N}\mathcal{N}}{\mathcal{N}\mathcal{D}}$, $\binom{\mathcal{N}\mathcal{D}}{\mathcal{N}\mathcal{N}}$ and $\binom{\mathcal{N}\mathcal{N}}{\mathcal{N}\mathcal{N}}$. We will distinguish the following four subcases:

- (ii-1) $\beta = \frac{1}{2}\alpha^2$,
- (ii-2) $\beta = \frac{1}{4}\alpha^2$,
- (ii-3) $\beta > \frac{1}{4}\alpha^2$ and $\beta \neq \frac{1}{2}\alpha^2$,
- (ii-4) $\beta < \frac{1}{4}\alpha^2$.

(ii-1) Assume that $\beta = \frac{1}{2}\alpha^2$. We will show that u^0 is a weak minimizer in the case $\binom{\mathcal{N}\mathcal{D}}{\mathcal{N}\mathcal{D}}$ and u^0 is not a weak minimizer in the case $\binom{\mathcal{N}\mathcal{N}}{\mathcal{N}\mathcal{N}}$ if $\alpha \neq 2k\pi$. In addition, in the case $\binom{\mathcal{N}\mathcal{N}}{\mathcal{N}\mathcal{D}}$, u^0 is or is not a weak minimizer if $\alpha \in ((2k-1)\pi, 2k\pi)$ or $\alpha \in (2k\pi, (2k+1)\pi)$, respectively, and the opposite is true in the case $\binom{\mathcal{N}\mathcal{D}}{\mathcal{N}\mathcal{N}}$.

If we set $\delta := \alpha/2$ and

$$\begin{aligned} h^{(1)}(x) &:= (e^{\delta x}(\cos(\delta x) - \sin(\delta x)), e^{\delta x}(\cos(\delta x) + \sin(\delta x))), \\ h^{(2)}(x) &:= (e^{-\delta x}(\cos(\delta x) + \sin(\delta x)), e^{-\delta x}(-\cos(\delta x) + \sin(\delta x))), \end{aligned}$$

then we obtain $D \equiv -2$, hence u^0 is a weak minimizer in the case $\binom{\mathcal{N}\mathcal{D}}{\mathcal{N}\mathcal{D}}$.

Considering the case $\binom{\mathcal{N}\mathcal{N}}{\mathcal{N}\mathcal{N}}$, one can check that the matrix $A = (a_{kl})$ in Remark 4(ii) satisfies

$$a_{11} = 4\delta e^{2\delta} \sin^2 \delta, \quad a_{22} = -4\delta e^{-2\delta} \sin^2 \delta, \quad a_{12} = a_{21} = -4\delta \sin \delta \cos \delta,$$

hence if $\delta \neq k\pi$, then there exists $h \in H = H_{\mathcal{D},1}$ such that $\mathcal{B}h(1) \cdot h(1) < 0$, i.e. u^0 is not a weak minimizer. If $\delta = k\pi$, then $A = 0$ (degenerate case). Already these facts contradict [13, Proposition 5] which claims the stability for $\beta > \frac{1}{4}\alpha^2$. In fact, the authors of [13] mention in their proof that ‘‘We have not used any integration by parts ...’’, but they seem to use [13, (35)–(37)], and [13, (35)] does use an integration by parts requiring the boundary conditions $h_1 h_2(0) = h_1 h_2(1)$.

In the cases $\binom{\mathcal{N}\mathcal{D}}{\mathcal{N}\mathcal{N}}$ and $\binom{\mathcal{N}\mathcal{N}}{\mathcal{N}\mathcal{D}}$ we set

$$h := e^{-\delta}(\cos \delta + \sin \delta)h^{(1)} - e^{\delta}(\cos \delta - \sin \delta)h^{(2)}$$

and

$$h := e^{-\delta}(\cos \delta - \sin \delta)h^{(1)} + e^{\delta}(\cos \delta + \sin \delta)h^{(2)}$$

to obtain $h_1(1) = 0$ and $h_2(1) = 0$, respectively. In the first case we have $h_2(1) = 2$, $h_2'(1) = \alpha \sin \alpha$, and in the second case $h_1(1) = 2$ and $h_1'(1) = -\alpha \sin \alpha$, which concludes the proof of our statements for $\beta = \frac{1}{2}\alpha^2$.

(ii-2) Assume that $\beta = \frac{1}{4}\alpha^2$. Set $\xi := -\frac{1}{2}\alpha$ and

$$\begin{aligned} h^{(1)}(x) &:= (\sin(\xi x) - \xi x \cos(\xi x), \cos(\xi x) + \xi x \sin(\xi x)), \\ h^{(2)}(x) &:= (\cos(\xi x) - \xi x \sin(\xi x), -\sin(\xi x) - \xi x \cos(\xi x)). \end{aligned}$$

Notice that the function D in Theorem 3 satisfies $D(x) = \xi^2 x^2 - 1$, hence $D < 0$ in $[0, 1]$ if $\alpha < 2$, and $D(x) = 0$ for some $x \in (0, 1)$ if $\alpha > 2$. This shows that $\frac{1}{4}\alpha^2 < g_{\mathcal{N}\mathcal{D}}^{\mathcal{N}\mathcal{D}}(\alpha) \leq \min(g_{\mathcal{N}\mathcal{D}}^{\mathcal{N}\mathcal{N}}(\alpha), g_{\mathcal{N}\mathcal{N}}^{\mathcal{N}\mathcal{D}}(\alpha), g_{\mathcal{N}}(\alpha))$ if $\alpha > 2$, i.e. u^0 cannot be a weak minimizer in any case.

Let $\alpha < 2$. Then u^0 is a weak minimizer in the case $\binom{\mathcal{N}\mathcal{D}}{\mathcal{N}\mathcal{D}}$, but cannot be a weak minimizer in the cases $\binom{\mathcal{N}\mathcal{N}}{\mathcal{N}\mathcal{D}}$, $\binom{\mathcal{N}\mathcal{N}}{\mathcal{N}\mathcal{N}}$ due to (ii-1). It remains to consider the case $\binom{\mathcal{N}\mathcal{D}}{\mathcal{N}\mathcal{N}}$. Set

$$h := (\cos \xi - \xi \sin \xi)h^{(1)} - (\sin \xi - \xi \cos \xi)h^{(2)},$$

so that $h_1(1) = 0$. Then the restriction $\alpha < 2$ implies $h_2(1) = 1 - \xi^2 > 0$. Since $h_2'(1) = -\xi^2 + \xi \sin(2\xi)$, we see that $h_2'(1)h_2(1) > 0$ only if $\alpha < \alpha_0$, where α_0 is defined by $\alpha_0 = 2 \sin \alpha_0$ ($\alpha_0 \doteq 0.6\pi$).

(ii-3) Assume $\beta > \frac{1}{4}\alpha^2$, $\beta \neq \frac{1}{2}\alpha^2$, and set

$$\varphi(x) := e^{\gamma x}(\gamma^2 - \delta^2), \quad \psi_{\pm}(x) := e^{-\gamma x}(\gamma \pm \delta)^2.$$

Then we can take

$$\begin{aligned} h^{(1)}(x) &:= [(\varphi(x) + \psi_+(x))(\cos(\delta x) + \sin(\delta x)), (\varphi(x) + \psi_+(x))(-\cos(\delta x) + \sin(\delta x))], \\ h^{(2)}(x) &:= [(\varphi(x) + \psi_-(x))(\cos(\delta x) - \sin(\delta x)), (\varphi(x) + \psi_-(x))(\cos(\delta x) + \sin(\delta x))], \end{aligned}$$

and an easy computation yields

$$D(x) = 4(\gamma^2 - \delta^2) \left((\gamma^2 - \delta^2) \cosh(2\gamma x) + \gamma^2 + \delta^2 \right). \quad (29)$$

The function D does not vanish in $[0, 1]$ if $\gamma > \delta$ (i.e. $\beta > \frac{1}{2}\alpha^2$), or $\gamma < \delta$ and $\cosh(2\gamma) < \frac{\gamma^2 + \delta^2}{\delta^2 - \gamma^2}$. The last inequality can be written in the form

$$(\alpha^2 - 2\beta) \cosh(2\gamma) < 2\beta. \quad (30)$$

In the case $\binom{\mathcal{NN}}{\mathcal{NN}}$, one has to consider the numbers a_{kl} in Remark 4(ii):

$$\begin{aligned} a_{11} &= 2\gamma(\varphi^2 - \psi_+^2)(1) + 2\delta(\varphi + \psi_+)^2(1) \cos(2\delta), \\ a_{22} &= 2\gamma(\varphi^2 - \psi_-^2)(1) - 2\delta(\varphi + \psi_-)^2(1) \cos(2\delta), \\ a_{12} &= a_{21} = -2\delta(\varphi + \psi_+)(\varphi + \psi_-)(1) \sin(2\delta). \end{aligned}$$

If $\gamma > \delta$ (i.e. $\beta > \frac{1}{2}\alpha^2$), then

$$a_{11}(\gamma + \delta)^{-2} + a_{22}(\gamma - \delta)^{-2} = 8(\gamma^2 + \delta^2)(\gamma - \theta\delta \cos(2\delta)) \sinh(2\gamma) > 0,$$

hence the matrix A is positive definite if and only if $a_{11}a_{22} > a_{12}^2$, which is equivalent to

$$(1 - \theta^2) \cosh(2\gamma) + \theta^2 \cos(2\delta) > 1. \quad (31)$$

We used the assumption $\beta > \frac{1}{2}\alpha^2$ in order to derive (31), but this is not restrictive, since we know that u^0 can only be a weak minimizer of our problem in the case $\binom{\mathcal{NN}}{\mathcal{NN}}$ when $\beta > \frac{1}{2}\alpha^2$. Hence in this case the condition (31) determines the domain of stability.

In the cases $\binom{\mathcal{ND}}{\mathcal{ND}}$ and $\binom{\mathcal{ND}}{\mathcal{NN}}$, we set

$$h := (\varphi(1) + \psi_-(1))(\cos \delta + \sin \delta)h^{(1)} + (\varphi(1) + \psi_+(1))(\cos \delta - \sin \delta)h^{(2)}$$

and

$$h := (\varphi(1) + \psi_-(1))(\cos \delta - \sin \delta)h^{(1)} - (\varphi(1) + \psi_+(1))(\cos \delta + \sin \delta)h^{(2)},$$

respectively. Then $h_2(1) = 0$, $h_1(1) = D(1)$,

$$h_1' h_1(1) = 4\gamma(\gamma^2 - \delta^2)D(1)((\gamma^2 - \delta^2) \sinh(2\gamma) - 2\gamma\delta \sin(2\delta)),$$

and $h_1(1) = 0$, $h_2(1) = -D(1)$,

$$h_2' h_2(1) = 4\gamma(\gamma^2 - \delta^2)D(1)((\gamma^2 - \delta^2) \sinh(2\gamma) + 2\gamma\delta \sin(2\delta)),$$

respectively, where D is as in (29). Consequently, assuming that D does not vanish in $[0, 1]$ (i.e. (30) is true), the stability conditions are

$$(\gamma^2 - \delta^2) \sinh(2\gamma) - 2\gamma\delta \sin(2\delta) > 0 \quad (32)$$

and

$$(\gamma^2 - \delta^2) \sinh(2\gamma) + 2\gamma\delta \sin(2\delta) > 0, \quad (33)$$

respectively. Notice that if $\beta = \frac{1}{2}\alpha^2$, then (32) and (33) are equivalent to the corresponding stability conditions in case (ii-1).

(ii-4) If $\beta < \frac{1}{4}\alpha^2$, then we can set

$$\begin{aligned} h^{(1)}(x) &:= (\xi_2 \sin(\xi_1 x) - \xi_1 \sin(\xi_2 x), \xi_2 \cos(\xi_1 x) - \xi_1 \cos(\xi_2 x)), \\ h^{(2)}(x) &:= (\xi_1 \cos(\xi_1 x) - \xi_2 \cos(\xi_2 x), -\xi_1 \sin(\xi_1 x) + \xi_2 \sin(\xi_2 x)), \end{aligned}$$

where $\xi_{1,2} = -\frac{1}{2}\alpha \pm \gamma$, and we obtain

$$D(x) = -2\beta + (\alpha^2 - 2\beta) \cos(2\gamma x). \quad (34)$$

If $\alpha^2 - 4\beta \geq \pi^2$, then D changes sign in $[0, 1]$. Hence the condition $D > 0$ in $[0, 1]$ is equivalent to

$$\alpha^2 - 4\beta < \pi^2 \quad \text{and} \quad (\alpha^2 - 2\beta) \cos(2\gamma) > 2\beta. \quad (35)$$

It is not difficult to check (cf. case (ii-2)) that if $\alpha < 2$ or $\alpha > 2$, then (35) or (30), respectively, is the (essentially optimal) sufficient condition for the stability in our problem in the case $(\mathcal{N}^{\mathcal{D}}_{\mathcal{N}^{\mathcal{D}}})$. If $\alpha = 2$, then that sufficient condition is $\beta > 1$.

Case (ii-2) shows that it remains to consider only the case $(\mathcal{N}^{\mathcal{D}}_{\mathcal{N}^{\mathcal{N}}})$ and $\alpha < \alpha_0$. Take

$$h := (\xi_1 \cos \xi_1 - \xi_2 \cos \xi_2)h^{(1)} - (\xi_2 \sin \xi_1 - \xi_1 \sin \xi_2)h^{(2)}.$$

Then $h_1(1) = 0$, $h_2(1) = -D(1)$ (where D is as in (34)), and

$$h'_2(1) = (\xi_1^2 \sin \xi_2 \cos \xi_1 - \xi_2^2 \sin \xi_1 \cos \xi_2)(\xi_2 - \xi_1).$$

Assuming $D > 0$ in $[0, 1]$ (i.e. (35)), the condition $h'_2 h_2(1) > 0$ is equivalent to

$$\xi_1^2 \sin \xi_2 \cos \xi_1 > \xi_2^2 \sin \xi_1 \cos \xi_2. \quad (36)$$

Since $\xi_1 = 0$ if $\beta = 0$, (36) can only be true if $\beta > 0$. It is not difficult to see that $g_{\mathcal{N}^{\mathcal{D}}_{\mathcal{N}^{\mathcal{N}}}}(\alpha) = 0$ for $\alpha \leq \frac{1}{2}\pi$ and $g_{\mathcal{N}^{\mathcal{D}}_{\mathcal{N}^{\mathcal{N}}}}(\alpha_0) = \frac{1}{4}\alpha_0^2$. If $\alpha > \alpha_0$, then (33) determines $g_{\mathcal{N}^{\mathcal{D}}_{\mathcal{N}^{\mathcal{N}}}}(\alpha)$.

The formulas for functions g in Proposition 19(ii) follow from the stability conditions (30),(31),(32),(33),(35),(36). \square

REFERENCES

- [1] M. Batista: On Jacobi's condition for the simplest problem of calculus of variations with mixed boundary conditions. *Appl. Math. Letters* 52 (2016), 132–141
- [2] M. Batista: On stability of non-inflectional elastica. *C. R. Mécanique* 348 (2020), 137–148.
- [3] M. Batista: On a strong minimum of stable forms of elastica. *Mech. Res. Commun.* 107 (2020), Art. 103522
- [4] D. Bednárík: Weak and strong minimizers of variational integrals. Master thesis, Comenius University, Bratislava 2022 (<http://www.iam.fmph.uniba.sk/institute/quittner/bednarik.pdf>)
- [5] A. Borum, T. Bretl: When is a helix stable? *Phys. Rev. Letters* 125 (2020), Art. 088001
- [6] H. Brezis, L. Nirenberg: H^1 versus C^1 local minimizers. *C. R. Acad. Sci. Paris* 317 (1993), 465–472
- [7] L. Cesari: *Optimization - theory and applications*. Springer, Berlin 1983
- [8] M. Cicalese, M. Ruf, F. Solombrino: On global and local minimizers of prestrained thin elastic rods. *Calc. Var.* 56 (2017), Art. 115
- [9] I.M. Gelfand, S.V. Fomin: *Calculus of Variations*. Prentice Hall, Englewood Cliffs, N.J., 1963
- [10] M. Giaquinta, S. Hildebrandt: *Calculus of Variations I*. Springer, Berlin - Heidelberg, 2004
- [11] M. Jin: Stability to discontinuous perturbations for one inflexion Euler elasticas with one end fixed and the other clamped in rotation. *Eur. J. Mech. A Solids* 81 (2020), Art. 103954
- [12] T. Lessinnes, A. Goriely: Geometric conditions for the positive definiteness of the second variation in one-dimensional problems. *Nonlinearity* 30 (2017), 2023–2062
- [13] A. Majumdar, A. Raisch: Stability of twisted rods, helices and buckling solutions in three dimensions. *Nonlinearity* 27 (2014), 2841–2867
- [14] R.S. Manning: Conjugate points revisited and Neumann-Neumann problems. *SIAM Review* 51 (2009), 193–212
- [15] P.J. Olver: Boundary conditions and null Lagrangians in the calculus of variations and elasticity. Preprint 2022
- [16] P. Quittner: An introduction to the calculus of variations. Electronic lecture notes, Comenius University, Bratislava 2011 (in Slovak; <http://www.iam.fmph.uniba.sk/institute/quittner/vm.pdf>)