

Generating function method for the efficient computation of expected allocations*

Christopher Blier-Wong[†], H el ene Cossette, and Etienne Marceau

 cole d'actuariat, Universit  Laval, Qu bec, Canada

July 7, 2022

Abstract

Consider a risk portfolio with aggregate loss random variable $S = X_1 + \dots + X_n$ defined as the sum of the n individual losses X_1, \dots, X_n . The expected allocation, $E[X_i \times 1_{\{S=k\}}]$, for $i = 1, \dots, n$ and $k \in \mathbb{N}$, is a vital quantity for risk allocation and risk-sharing. For example, one uses this value to compute peer-to-peer contributions under the conditional mean risk-sharing rule and capital allocated to a line of business under the Euler risk allocation paradigm. This paper introduces an ordinary generating function for expected allocations, a power series representation of the expected allocation of an individual risk given the total risks in the portfolio when all risks are discrete. First, we provide a simple relationship between the ordinary generating function for expected allocations and the probability generating function. Then, leveraging properties of ordinary generating functions, we reveal new theoretical results on closed-form solutions to risk allocation problems, especially when dealing with Katz or compound Katz distributions. Then, we present an efficient algorithm to recover the expected allocations using the fast Fourier transform, providing a new practical tool to compute expected allocations quickly. The latter approach is exceptionally efficient for a portfolio of independent risks.

Keywords: Risk allocation, generating functions, conditional mean risk-sharing, fast Fourier transform, Euler risk allocation

1 Introduction

1.1 Risk-sharing and risk allocation

In operation research, risk management and actuarial science, one often deals with many risks. Therefore, it is more convenient to make decisions based on aggregate risks (or risks of the entire

*This work was partially supported by the Natural Sciences and Engineering Research Council of Canada (Blier-Wong: 559169, Cossette: 04273; Marceau: 05605). We thank Christian Y. Robert for fruitful discussions.

[†]Corresponding author, christopher.blier-wong.1@ulaval.ca

company) rather than many small risks (or agents, like departments or business units). However, once these decisions are made, one must propagate the decisions to the agents composing the aggregate risk. Two areas of research that study redistribution methods include risk-sharing and risk allocation.

Risk-sharing refers to constructing a random vector that allocates a total risk to granular risks. When constructing this random vector, one may use a risk-sharing rule, which determines how the redistribution occurs. One important risk-sharing rule is the conditional mean risk-sharing rule [Denuit and Dhaene, 2012], such that one participant pays his expected value, conditional to the aggregate (random) risk. Since this total risk is unknown, the conditional mean risk-sharing rule constructs a random vector.

On the other hand, risk allocation refers to redistributing the amount resulting by applying a risk measure to its granular risks. Risk allocations deconstruct a total risk measure into the contributions of granular risks to the total risk measure. This approach is sometimes called top-down risk allocation. In insurance, finance and banking, standard risk measures include the Value-at-Risk (VaR) and the Tail-Value-at-Risk (TVaR, also known as expected shortfall or conditional tail expectation). There are many debates about selecting the VaR or the TVaR as risk measures; see [Embrechts et al., 2014] for a comparison. We will consider extensions of the VaR and TVaR called the Range-Value-at-Risk (RVaR), introduced by [Cont et al., 2010]. The RVaR is a two-parameter risk measure that contains the VaR and the TVaR as special cases. The RVaR risk measure is a special case of a distortion risk measure, see, for instance, [Wang, 1996, Kusuoka, 2001]. More general classes of distortion risk measures are not necessarily linear. Further, [Denault, 2001] proposes a set of axioms which, if satisfied, are said to be coherent allocations of risk capital. Theorem 5 of that paper shows that the risk measure must be linear for coherent allocations of homogeneous risk measures to exist. Therefore, considering RVaRs is sufficient for the most useful purposes; we discuss polynomial risk measures in Section 6.

Although risk-sharing and risk allocation are typically considered separate disciplines, we will see that they share a similar mathematical problem in special cases, which one may solve using expected allocations, a quantity we introduce later in this section.

1.2 Notation and problem

Let \mathbb{N} be the set of non-negative integers $\{0, 1, 2, \dots\}$, while \mathbb{N}^+ be $\mathbb{N} \setminus 0$. Consider a portfolio of n risks $\mathbf{X} = (X_1, \dots, X_n)$ where each random variable (rv) has a lattice-type support $h\mathbb{N} = \{hk | k \in \mathbb{N}, h \in \mathbb{R}^+\}$. The joint cumulative distribution function (cdf) and probability mass function (pmf) are respectively $F_{\mathbf{X}}(\mathbf{x})$ and $f_{\mathbf{X}}(\mathbf{x})$, for $\mathbf{x} \in \{h\mathbb{N}\} \times \dots \times \{h\mathbb{N}\} = \{h\mathbb{N}\}^n$ and marginal cdfs and pmfs are noted $F_{X_i}(x) = \Pr(X_i \leq x)$ and $f_{X_i}(x) = \Pr(X_i = x)$, for $x \in h\mathbb{N}$ and $i \in \{1, \dots, n\}$. Throughout the paper, we assume that $E[X_i] < \infty$, for $i \in \{1, \dots, n\}$. The rv representing the portfolio aggregate loss is $S = X_1 + \dots + X_n$, with cdf F_S , pmf f_S and expectation $E[S] = \sum_{i=1}^n E[X_i] < \infty$.

This paper aims to study methods based on ordinary generating functions to compute the expectation, which we present in the following definition.

Definition 1.1 (Expected allocation). Let \mathbf{X} be a vector of rvs, each with lattice-type support $h\mathbb{N}$, and $S = X_1 + \dots + X_n$. The expected allocation of X_i to a total outcome $S = s$ is defined as

$E[X_i \times 1_{\{S=s\}}]$, for $i \in \{1, \dots, n\}$ and $s \in h\mathbb{N}$.

In the spirit of Definition 1.1, we introduce the expected cumulative allocation defined by

$$E[X_i \times 1_{\{S \leq s\}}] = \sum_{x \in \{0, h, \dots, s\}} E[X_i \times 1_{\{S=x\}}], \quad (1)$$

for $s \in h\mathbb{N}$ and $i \in \{1, \dots, n\}$. Observe that

$$\sum_{s \in h\mathbb{N}} E[X_i \times 1_{\{S=s\}}] = \lim_{s \rightarrow \infty} E[X_i \times 1_{\{S \leq s\}}] = E[X_i], \quad i \in \{1, \dots, n\}. \quad (2)$$

It follows from (1) and (2) that the expected *decumulative* allocation¹ is given by

$$E[X_i \times 1_{\{S > s\}}] = \sum_{x \in \{s+h, s+2h, \dots\}} E[X_i \times 1_{\{S=x\}}] = E[X_i] - E[X_i \times 1_{\{S \leq s\}}], \quad (3)$$

for $s \in h\mathbb{N}$ and $i \in \{1, \dots, n\}$. From Definition 1.1, one verifies that expected allocation satisfies the two following identities:

$$\sum_{i=1}^n E[X_i \times 1_{\{S=s\}}] = s \Pr(S = s), \quad s \in h\mathbb{N}, \quad (4)$$

and

$$\sum_{i=1}^n \sum_{s \in h\mathbb{N}} E[X_i \times 1_{\{S=s\}}] = E[S]. \quad (5)$$

Based on (5), each quantity $E[X_i \times 1_{\{S=s\}}]$, for $i \in \{1, \dots, n\}$ and $s \in h\mathbb{N}$, represent a single contribution to the expectation of S . The sum of all those contributions gives $E[S]$.

Although rarely considered directly, expected allocations play an important role in peer-to-peer insurance pricing and risk allocation based on Euler's rule.

In peer-to-peer insurance pricing schemes, one is interested in computing a participant's contribution according to a risk-sharing rule. The conditional mean risk-sharing rule, studied in, for instance, [Denuit and Dhaene, 2012], is a popular choice, where the price for the i th participant is the expected contribution of risk X_i , for $i \in \{1, \dots, n\}$, given that the actual loss S is s , that is,

$$E[X_i | S = s] = \frac{E[X_i \times 1_{\{S=s\}}]}{\Pr(S = s)}, \quad (6)$$

assuming $\Pr(S = s) \neq 0$, for $s \in h\mathbb{N}$. Given (4), $\sum_{i=1}^n E[X_i | S = s] = s$, meaning that, under the conditional mean sharing rule, the sum of the prices of all the participants of the pool is equal to the total losses s , for $s \in h\mathbb{N}$. The authors of [Denuit et al., 2022] provide a list of twelve desirable properties for risk-sharing rules and prove that the conditional mean risk-sharing rule satisfies eleven out of them.

Another application of expected allocations in peer-to-peer insurance happens when the pool transfers parts of its risks to reinsurance companies. Fix two levels $0 < \ell_1 < \ell_2 < \infty$ for $\ell_1 \in h\mathbb{N}$

¹The term *decumulative* in this context is inspired by [Yaari, 1987].

and $\ell_2 \in h\mathbb{N}$. Consider a pool which retains the first level of risk up to level $0 < \ell_1 < \infty$, then transfers the losses from ℓ_1 to ℓ_2 to a first reinsurer, and finally, all losses above level ℓ_2 to a second reinsurer. Then one is interested in computing the contribution of a participant to the retained losses and to the transferred losses in each layer, that is, using (1), (2), and (3), $E[X_1 \times 1_{\{S \leq \ell_1\}}]$,

$$E[X_1 \times 1_{\{\ell_1 < S \leq \ell_2\}}] = \sum_{x \in \{\ell_1 + h, \dots, \ell_2\}} E[X_1 \times 1_{\{S=x\}}] = E[X_1 \times 1_{\{S \leq \ell_2\}}] - E[X_1 \times 1_{\{S \leq \ell_1\}}] \quad (7)$$

and $E[X_1 \times 1_{\{S > \ell_2\}}]$, respectively. Such expressions also appear when computing the allocations to different layers of collateralized debt obligations, see, for instance, Section 3.5 of [Tasche, 2007] for details.

Expected allocations also appear in risk allocation based on Euler's rule. Regulatory capital requirements are typically risk measures based on the aggregate rv of an insurance company's portfolio. One risk measure of theoretical and practical interest is the TVaR. Risk allocation is an important research area in actuarial science, quantitative risk management and operations research, which aims to compute the contribution of each risk based on the total required (or available) capital. When using the TVaR as a regulatory capital requirement risk measure, one may compute the contributions of each risk to the capital based on the Euler risk-sharing paradigm.

Following [Embrechts and Hofert, 2013], define the generalized inverse of S at level κ , $0 < \kappa < 1$, by

$$F_S^{-1}(\kappa) = \inf_{x \in \mathbb{R}} \{F_S(x) \geq \kappa\}.$$

Define the VaR of the rv S as $VaR_\kappa(S) = F_S^{-1}(\kappa)$ and the TVaR of the rv S at level κ as

$$TVaR_\kappa(S) = \frac{1}{1-\kappa} \int_\kappa^1 F_S^{-1}(u) du = \frac{E[S \times 1_{\{S > VaR_\kappa(S)\}}] + VaR_\kappa(S)(F_S(VaR_\kappa(S)) - \kappa)}{1-\kappa}. \quad (8)$$

As mentioned in the introduction, the lack of consensus around the choice between the VaR and the TVaR encourages us to consider a larger class of risk measures; we consider the R VaR here.

Definition 1.2. The range-value-at-risk is defined as

$$RVaR_{\alpha_1, \alpha_2}(X) = \begin{cases} \frac{1}{\alpha_2 - \alpha_1} \int_{\alpha_1}^{\alpha_2} VaR_u(X) du, & \alpha_1 < \alpha_2 \\ VaR_{\alpha_1}(X), & \alpha_1 = \alpha_2 \end{cases},$$

for $0 \leq \alpha_1 \leq \alpha_2 \leq 1$.

Clearly, the range-value-at-risk corresponds to $VaR_\kappa(X)$ if $\alpha_1 = \alpha_2 = \kappa$. Further, if $\alpha_1 = \kappa$ and $\alpha_2 = 1$, then the corresponding R VaR is also $TVaR_\kappa(X)$. Using the identity

$$\frac{1}{\alpha_2 - \alpha_1} [(1 - \alpha_1)TVaR_{\alpha_1}(S) - (1 - \alpha_2)TVaR_{\alpha_2}(S)],$$

we have from (8) that

$$RVaR_{\alpha_1, \alpha_2}(S) = \frac{1}{\alpha_2 - \alpha_1} \left\{ F_S^{-1}(\alpha_1)[F_S(F_S^{-1}(\alpha_1)) - \alpha_1] + E[S \times 1_{\{F_S^{-1}(\alpha_1) < S \leq F_S^{-1}(\alpha_2)\}}] \right. \\ \left. + F_S^{-1}(\alpha_2)[\alpha_2 - F_S(F_S^{-1}(\alpha_2))] \right\}$$

Applying Euler's rule for risk allocation, introduced by [Tasche, 1999], the contribution of X_i is $\text{RVaR}_{\alpha_1, \alpha_2}(X_i; S) = E[X_i | S = \text{VaR}_{\alpha_1}(S)]$ for $\alpha_1 = \alpha_2$ and

$$\begin{aligned} \text{RVaR}_{\alpha_1, \alpha_2}(X_i; S) &= \frac{1}{\alpha_2 - \alpha_1} \left(E \left[X_1 \times 1_{\{S = F_S^{-1}(\alpha_1)\}} \right] \frac{F_S(F_S^{-1}(\alpha_1)) - \alpha_1}{\Pr(S = F_S^{-1}(\alpha_1))} \right. \\ &\quad + E \left[X_1 \times 1_{\{F_S^{-1}(\alpha_1) < S \leq F_S^{-1}(\alpha_2)\}} \right] \\ &\quad \left. + E \left[X_1 \times 1_{\{S = F_S^{-1}(\alpha_2)\}} \right] \frac{\alpha_2 - F_S(F_S^{-1}(\alpha_2))}{\Pr(S = F_S^{-1}(\alpha_2))} \right), \end{aligned} \quad (9)$$

for $\alpha_1 < \alpha_2$. Notice that out of the three expected values in (9), two are expected allocations. The third one can be written as a difference of cumulative allocations (or alternatively, decumulative allocations), using the relation in (7). Note also that the RVaR takes the same form as the conditional mean in (6) for a single value of $s \in h\mathbb{N}$.

The Euler-based RVaR decomposition is a top-down risk allocation method of risk allocation. By the additive property of the expected value, the full allocation property [McNeil et al., 2015] holds:

$$\text{RVaR}_{\alpha_1, \alpha_2}(S) = \sum_{i=1}^n \text{RVaR}_{\alpha_1, \alpha_2}(X_i; S).$$

The relations in (6) and (9) require the computation of the expected allocation $E[X_i \times 1_{\{S=s\}}]$ for $s \in h\mathbb{N}$. One therefore seeks an efficient method to compute these values.

One finds two common approaches to computing expected allocations in the actuarial science and quantitative risk management literature. Under the first approach, one uses the direct method for computing expected allocations through summation or integration. Let $S_{-i} = \sum_{j=1, j \neq i}^n X_j$, then one may compute

$$E[X_1 \times 1_{\{S=s\}}] = \sum_{x \in \{0, h, 2h, \dots, s\}} x f_{X_1, S_{-1}}(x, s - x), \quad s \in h\mathbb{N}.$$

The direct summation method is used in [Cossette et al., 2018] for discrete rvs when the dependence structure is an Archimedean copula. In Section 5 of [Bargès et al., 2009], the authors use this approach in a continuous setting to compute TVaR-based allocations for a mixture of exponential distributions linked through a FGM copula. The second approach is used notably in [Furman and Landsman, 2005, Furman and Landsman, 2008], where the authors use the size-biased transform of a rv to compute the expected allocations. See also [Arratia et al., 2019] for a review on the size-biased transform and its applications in several contexts. The method states that

$$E[X_1 \times 1_{\{S=s\}}] = E[X_1] \Pr(\tilde{X}_1 + S_{-1} = s), \quad s \in h\mathbb{N}, \quad (10)$$

where \tilde{X}_1 is the size-biased transform of X_1 with pmf

$$f_{\tilde{X}_1}(x) = x f_{X_1}(x) / E[X_1], \quad x \in h\mathbb{N}. \quad (11)$$

The authors of, for instance, [Denuit and Dhaene, 2012, Denuit, 2020, Denuit and Robert, 2020], use the size-biased transform method to derive properties and results about the conditional mean risk-sharing rule.

The main result of this paper is a representation of the ordinary generating function (OGF) for expected allocations in terms of the joint probability generating functions (pgf) of the random vector \mathbf{X} . We then present efficient algorithms to compute the expected allocation $E[X_i \times 1_{\{S=s\}}]$, for $i \in \{1, \dots, n\}$ and $s \in h\mathbb{N}$. In some cases, one can extract the values explicitly from the OGF of expected allocations, expressed either as a function of the pmf of S or as a convolution operation. One can use an efficient algorithm such as the fast Fourier transform (FFT) to recover the expected allocations directly from the OGF.

Our approach provides a generating function method, as opposed to a direct computation method. The method of generating functions is common in discrete mathematics and number theory. One can use generating functions to compute a term in the Fibonacci sequence, find the average of a sequence, study recurrence relations or prove combinatorial identities, see [Wilf, 2006] for details. Generating functions often provide convenient and elegant methods to compute or extract terms from a sequence where closed-form formulas would be tedious. A problem encountered within this paper is related to finding the number of partitions (restricted partitions in some cases, see Section 4.4 for an example with Bernoulli rvs), to determine if it is possible for two agents to share a risk for a given outcome of the total risk. It isn't surprising to observe that generating functions are suitable to solve these problems within the context of discrete rvs. Generating function methods, sometimes referred to as transform methods, are also used to compute the pmf of aggregate rvs or compound distributions, see, for example, [Embrechts et al., 1993], [Grubel and Hermesmeier, 1999], and [Embrechts and Frei, 2009] for applications of transform methods in operations research and actuarial science.

To simplify the notation in the theory developed in the remainder of this paper, we set $h = 1$, that is, we consider only rvs which have integer support. Therefore, for the remainder of this paper, the n -variate random vector \mathbf{X} takes values in \mathbb{N}^n . One may transform a rv with lattice-type support $h\mathbb{N}$ into one of integer support \mathbb{N} by multiplying the rv by the constant h^{-1} . By linearity of the expected allocation, one may easily recover expected allocations for the original rv.

Typically, one uses conditional mean risk-sharing and risk allocation for small-sized pools or few lines of businesses. However, the efficient methods based on OGFs proposed in this paper enable one to use these techniques even for a large portfolio of risks. It follows that risk managers will have the ability to perform risk allocation at the customer level once equipped with generating functions for expected allocations.

The paper is organized as follows. In Section 2, we present the OGF for expected allocations and provide a relationship with the pgf. We also provide an efficient method to extract the expected allocations from the OGF. Section 3 presents expressions for the expected allocation in the case of (compound) Katz distributions. In Section 5, we provide three results when the components of the random vector are dependent. Section 6 discusses further generalizations of our results for continuous rvs.

2 Ordinary generating functions for expected allocations

2.1 Ordinary generating functions

Ordinary generating functions are a useful mathematical tool since they capture every value of a sequence into one formula. See Chapter 7 of [Graham et al., 1994] or the monograph [Wilf, 2006] for details on generating functions, and Chapter 3 of [Sedgewick and Flajolet, 2013] for efficient algorithms to extract the values of the sequence. Following Section 3.1 of [Sedgewick and Flajolet, 2013], we provide the following definition of ordinary generating functions.

Definition 2.1 (Ordinary generating function). For a sequence $\{a_k\}_{k \in \mathbb{N}}$, the function

$$A(z) = \sum_{k=0}^{\infty} a_k z^k, \quad |z| \leq 1, \quad (12)$$

is its ordinary generating function (OGF). We use the notation $[z^k]A(z)$ to refer to the coefficient a_k , $k \in \mathbb{N}$.

In the following theorem, we summarize the relevant operations that one can perform on generating functions (see Theorem 3.1 and Table 3.2 of [Sedgewick and Flajolet, 2013] for details).

Theorem 2.2. *If $A(z) = \sum_{k=0}^{\infty} a_k z^k$ and $B(z) = \sum_{k=0}^{\infty} b_k z^k$ are two OGFs, then the following operations produce OGFs with the corresponding sequences:*

1. *Addition* $A(z) + B(z) = \sum_{k=0}^{\infty} (a_k + b_k) z^k$.
2. *Right shift* $zA(z) = \sum_{k=1}^{\infty} a_{k-1} z^k$.
3. *Index multiply* $A'(z) = \sum_{k=0}^{\infty} (k+1) a_{k+1} z^k$.
4. *Convolution* $A(z)B(z) = \sum_{k=0}^{\infty} \left(\sum_{j=0}^k a_j b_{k-j} \right) z^k$.
5. *Partial sum* $A(z)/(1-z) = \sum_{k=0}^{\infty} \left(\sum_{j=0}^k a_j \right) z^k$.

When $a_k \geq 0$ for $k \in \mathbb{N}$ and $\sum_{k=0}^{\infty} a_k = 1$, then the OGF is the probability generating function (pgf) of a discrete rv X , denoted \mathcal{P}_X , where the values of the pmf of the rv X is $f_X(k) = \Pr(X = k) = a_k$, $k \in \mathbb{N}$. The expression in (12) becomes

$$\mathcal{P}_X(z) = \sum_{k=0}^{\infty} f_X(k) z^k, \quad |z| \leq 1. \quad (13)$$

The pgf is an important tool in all areas of probability, statistics, and actuarial science, as explained, for example, in Section 5.1 in [Grimmett and Stirzaker, 2020], and Sections 1.2 and 2.4 in [Panjer and Willmot, 1992].

In this paper, we rely on a multivariate ordinary generating function capturing the values of the pmf of a discrete random vector. As described in Section 34.2.1 of [Johnson et al., 1997], the pgf of

a vector of discrete rvs $\mathbf{X} = (X_1, \dots, X_n)$, with joint pmf $f_{\mathbf{X}}$, is

$$\mathcal{P}_{\mathbf{X}}(z_1, \dots, z_n) = E \left[z_1^{X_1} \times \dots \times z_n^{X_n} \right] = \sum_{k_1=0}^{\infty} \dots \sum_{k_n=0}^{\infty} z_1^{k_1} \times \dots \times z_n^{k_n} f_{\mathbf{X}}(k_1, \dots, k_n), \quad (14)$$

for $|z_j| \leq 1$, $j \in \{1, \dots, n\}$. For more details on multivariate pgf and their properties, see, for instance, Appendix A in [Axelrod and Kimmel, 2015] and on multivariate ordinary generating functions, Chapter 3 of [Flajolet and Sedgewick, 2009].

The following theorem, a generalization of Theorem 1 of [Wang, 1998], shows the usefulness the multivariate pgf to capture at once the dependence relations between the components of \mathbf{X} and aggregation of subsets of them.

Theorem 2.3. *Let $\mathcal{A} = \{A_1, \dots, A_m\}$ be a partition of the set $\{1, \dots, n\}$, for $m \leq n$. Define the random vector $\mathbf{Y}_{\mathcal{A}} = (Y_{A_1}, \dots, Y_{A_m})$ with $Y_{A_j} = \sum_{i \in A_j} X_i$, for $j \in \{1, \dots, m\}$. Then the multivariate pgf of $\mathbf{Y}_{\mathcal{A}}$ is*

$$\mathcal{P}_{\mathbf{Y}_{\mathcal{A}}}(t_1, \dots, t_m) = \mathcal{P}_{\mathbf{X}} \left(\prod_{j=1}^m t_j^{1_{\{1 \in A_j\}}}, \dots, \prod_{j=1}^m t_j^{1_{\{n \in A_j\}}} \right), \quad |t_j| \leq 1, \quad j \in \{1, \dots, m\}. \quad (15)$$

If the margins of \mathbf{X} correspond to risks related to individual business units, then one may apply Theorem 2.3 to obtain the pgf of random vectors at the department or division level within the organizational hierarchy of the entire business. If the margins of \mathbf{X} correspond to individual risks in an insurance portfolio, then Theorem 2.3 provides an expression for the pgf of total risks aggregated by coverage type or geographic regions.

Here are special cases of partitions useful in the context of Theorem 2.3. When $m = 1$, such that $A_1 = \{1, \dots, n\}$ and $Y_{A_1} = S$, the result in (15) leads to Theorem 1 of [Wang, 1998]. For $m = 2$, we have $A_1 \subset \{1, \dots, n\}$ and $A_2 = A_1^C = \{1, \dots, n\} \setminus A_1$, that is, a subset of $\{1, \dots, n\}$ and its complement. Finally, if $m = n$, then $A_j = \{j\}$ and $Y_{A_j} = X_j$, for $j \in \{1, \dots, n\}$. Remark that for each product in the arguments of (15), only one value of t_j , for $j \in \{1, \dots, m\}$, remains since \mathcal{A} is a partition of a set.

As noted in Section 4.2 of [Wang, 1998] and Section 5.1 of [Grimmett and Stirzaker, 2020], one may use pgfs to extract factorial moments, mixed moments and pmfs. In the remainder of this section, we add expected allocations to this list.

2.2 Ordinary generating functions for expected allocations

In this paper our interest is that of computing expected allocations, hence we define the function $\mathcal{P}_S^{[i]}(t)$ as the OGF of the sequence of expected allocations for the rv X_i , that is,

$$\mathcal{P}_S^{[i]}(t) := \sum_{k=0}^{\infty} t^k E \left[X_i \times 1_{\{S=k\}} \right], \quad (16)$$

for $i \in \{1, \dots, n\}$.

Aiming to simplify the presentation, unless otherwise specified, we develop formulas for $i = 1$ for the remainder of this paper. One may obtain the other expected allocations by appropriate reindexing.

The following theorem is at the basis of the results in this paper and provides a link between the OGF of the expected allocations of the rv X_1 and the joint pgf of \mathbf{X} .

Theorem 2.4. *If \mathbf{X} is a vector of rvs with multivariate pgf $\mathcal{P}_{\mathbf{X}}$ and S is the aggregate rv, then the expression of $\mathcal{P}_S^{[i]}$ is given by*

$$\mathcal{P}_S^{[i]}(t) = \left[t_i \times \frac{\partial}{\partial t_i} P_{\mathbf{X}}(t_1, \dots, t_n) \right]_{t_1 = \dots = t_n = t}, \quad i \in \{1, \dots, n\}. \quad (17)$$

Proof. We provide a proof for $i = 1$, the other cases follow from appropriate reindexing of the random vector. Applying Theorem 2.3 with $m = 2$, $A_1 = 1$ and $A_2 = \{2, \dots, b\}$, the pgf of (X_1, S_{-1}) is

$$\mathcal{P}_{X_1, S_{-1}}(t_1, t_{-1}) = E \left[t_1^{X_1} t_{-1}^{X_2 + \dots + X_n} \right] = \mathcal{P}_{\mathbf{X}}(t_1, t_{-1}, \dots, t_{-1})$$

for $|t_1| \leq 1$ and $|t_{-1}| \leq 1$. We define

$$\mathcal{P}_{X_1, S_{-1}}^{[1]}(t_1, t_{-1}) = \sum_{k_1=0}^{\infty} \sum_{k_2=0}^{\infty} k_1 t_1^{k_1} t_{-1}^{k_2} f_{X_1, S_{-1}}(k_1, k_2),$$

which becomes

$$\mathcal{P}_{X_1, S_{-1}}^{[1]}(t_1, t_{-1}) = t_1 \frac{\partial}{\partial t_1} \sum_{k_1=0}^{\infty} \sum_{k_2=0}^{\infty} t_1^{k_1} t_{-1}^{k_2} f_{X_1, S_{-1}}(k_1, k_2) = t_1 \times \frac{\partial}{\partial t_1} \mathcal{P}_{X_1, S_{-1}}(t_1, t_{-1}).$$

Finally, it follows from the same arguments as in Theorem 2.3 that $\mathcal{P}_S^{[1]}(t) = \mathcal{P}_{X_1, S_{-1}}^{[1]}(t, t)$, which becomes

$$\mathcal{P}_S^{[1]}(t) = \sum_{k_1=0}^{\infty} \sum_{k_2=0}^{\infty} k_1 t^{k_1} t^{k_2} f_{X_1, S_{-1}}(k_1, k_2) = \sum_{k=0}^{\infty} t^k \sum_{k_1=0}^k k_1 f_{X_1, S_{-1}}(k_1, k - k_1) = \sum_{k=0}^{\infty} t^k E [X_1 \times 1_{\{S=k\}}], \quad (18)$$

where (18) is the power series representation in (16) of expected allocations, as desired. \square

From the uniqueness theorem of pgfs (see, for instance, Section 5.1 of [Grimmett and Stirzaker, 2020]), one can recover the values of $E [X_1 \times 1_{\{S=k\}}]$, $k \in \mathbb{N}$, by differentiating

$$[t^k] \mathcal{P}_S^{[1]}(t) = E [X_1 \times 1_{\{S=k\}}] = \frac{1}{k!} \left. \frac{d^k}{dt^k} \mathcal{P}_S^{[1]}(t) \right|_{t=0},$$

or using an algorithm to extract the coefficients of a polynomial. The entire Section 2.3 provides a method using FFT to extract the coefficients from the OGF for expected allocations. Consequently, (18) is a powerful tool to capture every expected allocation for X_1 within a single function.

An especially convenient corollary holds for the allocation of a rv which is independent from the remaining risks.

Corollary 2.5. *If X_1 and S_{-1} are independent, then the expression of $\mathcal{P}_S^{[1]}$ in (17) becomes*

$$\mathcal{P}_S^{[1]}(t) = t\mathcal{P}'_{X_1}(t)\mathcal{P}_{S_{-1}}(t). \quad (19)$$

Aiming a more efficient method to compute the expectations, we find an OGF for the expected cumulative allocation defined in (1).

Corollary 2.6. *If \mathbf{X} is a vector of rvs with the joint pgf $\mathcal{P}_{\mathbf{X}}$ and S is the aggregate rv, then the function*

$$\mathcal{P}_S^{[1]}(t)/(1-t) = \frac{1}{1-t} \left[t_1 \times \frac{\partial}{\partial t_1} \mathcal{P}_{\mathbf{X}}(t_1, \dots, t_n) \right]_{t_1=\dots=t_n=t}$$

is the OGF of the sequence of expected cumulative allocations $\{E[X_1 \times 1_{\{S \leq k\}}]\}_{k \in \mathbb{N}}$.

Proof. Applying operation 5 of Theorem 2.2, we have

$$\frac{\mathcal{P}_S^{[1]}(t)}{1-t} = \sum_{k=0}^{\infty} t^k \left(\sum_{j=0}^k E[X_1 \times 1_{\{S=j\}}] \right) = \sum_{k=0}^{\infty} t^k E[X_1 \times 1_{\{S \leq k\}}]. \quad (20)$$

□

2.3 Outline of the FFT-based computation strategy

Equipped with an OGF for expected allocations, one may seek to solve for the expected allocations analytically. However, in most cases, this will be tedious or impossible. One therefore requires numerical algorithms to compute the expected allocations. We now provide an algorithm to recover the expected allocations.

A significant advantage of working with pgfs (and more generally, with OGFs) is that the fast Fourier transform algorithm of [Cooley and Tukey, 1965] provides an efficient method to extract the values of OGFs, as explained in Chapter 30 of [Cormen et al., 2009]. See also [Embrechts et al., 1993] for applications of the fast Fourier transform in actuarial science and quantitative risk management.

Define the characteristic function of S as

$$\phi_S(t) := E[e^{itS}] = \mathcal{P}_S(e^{it})$$

and analogously, the characteristic version of the OGF for expected allocations,

$$\phi_S^{[1]}(t) := \sum_{k=0}^{\infty} e^{itk} E[X_1 \times 1_{\{S=k\}}] = \mathcal{P}_S^{[1]}(e^{it}).$$

In this section, we aim to recover the values of $E[X_1 \times 1_{\{S=k\}}]$ using the discrete Fourier transform (DFT). Set $\mathbf{f}_X = (f_X(0), f_X(1), \dots, f_X(k_{max} - 1))$ for a truncation point $k_{max} \in \mathbb{N}$. Here we assume that $f_X(k) = 0$ for $k \geq k_{max}$ such that there is no truncation error. The DFT of \mathbf{f}_X , noted $\hat{\mathbf{f}}_X = (\hat{f}_X(0), \hat{f}_X(1), \dots, \hat{f}_X(k_{max} - 1))$, is

$$\hat{f}_X(k) = \sum_{j=0}^{k_{max}-1} f_X(j) e^{i2\pi jk/k_{max}}, \quad k = 0, \dots, k_{max} - 1. \quad (21)$$

The inverse DFT can recover the original sequence with

$$f_X(k) = \frac{1}{k_{max}} \sum_{j=0}^{k_{max}-1} \operatorname{Re} \left(\widehat{f}_X(j) e^{-i2\pi jk/k_{max}} \right), \quad k = 0, \dots, k_{max} - 1. \quad (22)$$

The authors of [Embretchts and Frei, 2009] explain how computing the pmf of a compound sum is more efficient with the FFT than using Panjer recursion or direct convolution. We now show how to apply the FFT algorithm to compute expected allocations. Let $\mu_{1:k} = E[X_1 \times 1_{\{S=k\}}]$ for $k = 0, \dots, k_{max} - 1$ and $\boldsymbol{\mu}_1 = (\mu_{1:0}, \dots, \mu_{1:(k_{max}-1)})$ with the obvious case $\mu_{1:0} = 0$. Then, the discrete Fourier transform of $\boldsymbol{\mu}_1$, noted $\widehat{\boldsymbol{\mu}}_1 = (\widehat{\mu}_{1:0}, \dots, \widehat{\mu}_{1:(k_{max}-1)})$, is

$$\widehat{\mu}_{1:j} = \mathcal{P}_S^{[1]} \left(e^{i2\pi j/k_{max}} \right), \quad j = 0, \dots, k_{max} - 1. \quad (23)$$

For notational convenience, we write the vector $\{e^{i2\pi j/k_{max}}\}_{0 \leq j \leq k_{max}-1}$ as $\widehat{\boldsymbol{e}}_1$. Then, we have that $\widehat{\boldsymbol{\mu}}_1 = \mathcal{P}_S^{[1]}(\widehat{\boldsymbol{e}}_1)$. Computing the inverse DFT of (23) yields the values of $E[X_1 \times 1_{\{S=k\}}]$ for $k = 0, \dots, k_{max} - 1$. If k_{max} is a power of 2, algorithms like the FFT of [Cooley and Tukey, 1965] are especially efficient.

Note that computing the cumulative expected allocations is trickier since division by $(1-t)$ is undefined for $|t| = 1$. One, therefore, requires simplifications before applying the FFT algorithm to the OGF of expected cumulative allocations. In practice, one only obtains a slight numerical advantage from using the FFT algorithm for expected cumulative allocations, which has algorithmic complexity $O(n \log n)$. If one computes expected allocations with the FFT algorithm and takes the cumulative sum of the result, the algorithmic complexity becomes $O(n \log n + n)$, which is only slightly longer than computing directly the cumulative expected allocations.

One consideration when using the FFT algorithm is that one must select a truncation point large enough such that $f_S(k_{max}) = 0$. One could have a large value of k_{max} if S is a large portfolio or if individual risks have heavy tails. In the context of peer-to-peer insurance with a stop loss reinsurance contract with trigger ω , we have $f_S(x) = 0$ for $x > \omega$, and $E[X_1 \times 1_{\{S=k\}}] = E[X_1 \times 1_{\{S=\omega\}}]$ for all $k \geq \omega$; thus stop loss contracts sets an upper bound to the truncation point required.

If X_1 is a discrete rv, independent of S_{-1} , then the OGF for expected allocations is given by (19). If we have no closed-form solution for $\mathcal{P}'_{X_1}(t)$, then one can compute the DFT of $t\mathcal{P}'_{X_1}(t)$ by using the pmf of X_1 and the properties of OGFs. One can compute the pgf of X_1 as $\mathcal{P}_{X_1}(t) = \sum_{k=0}^{\infty} t^k f_{X_1}(k)$ and $t\mathcal{P}'_{X_1}(t) = \sum_{k=0}^{\infty} t^k k f_{X_1}(k)$. It follows that one can compute the DFT of $t\mathcal{P}'_{X_1}(t)$ as the DFT of the vector $\{k f_{X_1}(k)\}_{k \in \mathbb{N}}$. We can compute the DFT of $t\mathcal{P}'_{X_1}(t)/(1-t)$ as the DFT of the partial sum of the vector $\{k f_{X_1}(k)\}_{k \in \mathbb{N}}$.

To apply the generating function approach with FFT algorithm (or other efficient convolution algorithms) when the rvs are continuous, one needs to discretize their continuous cdfs for a step size $h \in \mathbb{R}^+$. For a brief presentation of the upper, lower and mean preserving discretization methods and their applications with the FFT algorithm, see, for instance, Section 5 of [Bargès et al., 2009] and Section 2 of [Embretchts and Frei, 2009]. Stochastic orders properties for each of these three methods are examined in Chapter 1 of [Muller and Stoyan, 2002].

3 Implications for Katz distributions

Let M be a positive discrete rv following a distribution belonging to the Katz family of distributions (see [Katz, 1965], Section 2.5.4 of [Winkelmann, 2008] and Section 2.3.1 of [Johnson et al., 2005]), also referred to as the $(a, b, 0)$ family of distributions in [Klugman et al., 2018]. The pmf of M satisfies the recurrence relation

$$f_M(k) = (a + b/k)f_M(k-1), \quad k \in \mathbb{N}^+, \quad (24)$$

where $a < 1$ and $b > 0$. The expectation is $E[M] = b/(1-a)$, while the variance is $Var(M) = b/(1-a)^2$. One derives the following result for the pgf of M from (24).

Lemma 3.1. *If M follows a Katz distribution, then its pgf satisfies the differential equation $\mathcal{P}'_M(t) = (a+b)/(1-at)\mathcal{P}_M(t)$.*

Proof. See Section 4.5.1 of [Dickson, 2017]. □

Note that the solution to the differential equation in Lemma 3.1, as provided in equation (2.41) of [Johnson et al., 2005], is $\mathcal{P}_M(t) = [(1-a)/(1-at)]^{(b/a+1)}$, for $|t| \leq 1$.

Members of the Katz family are the Poisson distribution (with $a = 0$ and $b = \lambda$), the binomial distribution (with $a = -q/(1-q)$ and $b = (n+1)q/(1-q)$) and the negative binomial distribution with pmf given by

$$f_M(k) = \binom{r+k-1}{k} q^r (1-q)^k, \quad k \in \mathbb{N},$$

with $a = 1-q$ and $b = (r-1)(1-q)$. Note that each distribution have different starting values within the recurrence relation (provided in the references mentioned above), but the starting values aren't required within the current paper.

3.1 Allocations and family of Katz distributions

The following theorem presents an efficient formula to compute expected allocations.

Theorem 3.2. *Let X_1 follow a Katz distribution and be independent of S_{-1} . For $|a| < 1$ and $k \in \mathbb{N}^+$, we have*

$$[t^k]\mathcal{P}_S^{[1]}(t) = E[X_1 \times 1_{\{S=k\}}] = (a+b) \sum_{j=0}^{k-1} a^j f_S(k-1-j) \quad (25)$$

and

$$[t^k] \left\{ \frac{\mathcal{P}_S^{[1]}(t)}{1-t} \right\} = E[X_1 \times 1_{\{S \leq k\}}] = (a+b) \sum_{j=0}^{k-1} a^j F_S(k-1-j) \quad (26a)$$

$$= (a+b) \sum_{j=0}^{k-1} \frac{1-a^{j+1}}{1-a} f_S(k-1-j). \quad (26b)$$

Proof. Applying Corollary 2.5 and Lemma 3.1, the OGF for expected allocations is

$$\mathcal{P}_S^{[1]}(t) = t\mathcal{P}'_{X_1}(t)\mathcal{P}_{S-1}(t) = t\frac{a+b}{1-at}\mathcal{P}_{X_1}(t)\mathcal{P}_{S-1}(t) = t\frac{a+b}{1-at}\mathcal{P}_S(t). \quad (27)$$

Then, (25) follows from Property 4 of OGFs in Theorem 2.2. The relation in (26a) follows from another application of Property 4 of Theorem 2.2 to (25). Alternatively, the OGF for expected cumulative allocations is

$$\frac{\mathcal{P}_S^{[1]}(t)}{1-t} = (a+b)\frac{t}{(1-at)(1-t)}\mathcal{P}_S(t) = \frac{a+b}{a-1}\mathcal{P}_S(t)\left(\frac{1}{1-at} - \frac{1}{1-t}\right) = \frac{a+b}{a-1}\mathcal{P}_S(t)\sum_{k=0}^{\infty}t^k(a^k-1) \quad (28)$$

for $|t| < 1$. Then, (26b) also follows from the convolution property of OGFs in Theorem 2.2. \square

Notice that (25) and (26b) require the same number of computations, so it isn't more complex to compute cumulative allocations than individual valued allocations. We also have the relationship

$$(a-1)E[X_1 \times 1_{\{S \leq k\}}] = aE[X_1 \times 1_{\{S=k\}}] - (a+b)F_S(k-1), \quad |a| < 1, \quad k \in \mathbb{N}. \quad (29)$$

As both the expected allocation and the expected cumulative allocation are required to compute (7), the relationship in (29) is quite useful, since one does not need to compute every expected allocation in (1).

We list the implications of Theorem 3.2 in Table 1, which hold whenever X_1 and (X_2, \dots, X_n) are independent, no matter the random vector (X_2, \dots, X_n) , assuming that the expectations exist. The following two examples are special cases of Theorem 3.2 with practical interest.

Example 3.3 (Poisson distributions). Assume that X_1, \dots, X_n are independent with $X_i \sim Pois(\lambda_i)$, $i \in \{1, \dots, n\}$. Then, $S \sim Pois(\lambda_S)$, with $\lambda_S = \lambda_1 + \dots + \lambda_n$. From (25) of Theorem 3.2, we recover the result presented in Section 10.3 of [Marceau, 2013, page 413],

$$[t^k]\mathcal{P}_S^{[1]}(t) = E[X_1 \times 1_{\{S=k\}}] = \lambda_1 \frac{\lambda_S^{k-1} e^{-\lambda_S}}{(k-1)!} = \frac{\lambda_1}{\lambda_S} k \Pr(S=k), \quad k \in \mathbb{N}.$$

Thus, we have $E[X_1|S=k] = \lambda_1/\lambda_S k$ which is a linear function of k , hence the contribution under the conditional mean risk sharing rule coincides with the contribution under the proportional (or linear) allocation rule. \triangle

Example 3.4 (Negative binomial distributions). Assume that X_1, \dots, X_n are independent with $X_i \sim NB(r_i, q_i)$, $i \in \{1, \dots, n\}$. Inserting $a = (1 - q_1)$ and $b = (r_1 - 1)(1 - q_1)$ into (27), we have

$$\mathcal{P}_S^{[1]}(t) = t\frac{r_1(1-q_1)}{1-(1-q_1)t}\mathcal{P}_S(t) = t\frac{r_1(1-q_1)}{q_1}\left(\frac{q_1}{1-(1-q_1)t}\right)^{r_1+1}\mathcal{P}_{S-1}(t) := \frac{r_1(1-q_1)}{q_1}\mathcal{P}_{S^*}(t),$$

where S^* is the convolution of n negative binomial distributions, shifted to the right by one. Applying Theorem 1 of [Furman, 2007], we obtain

$$[t^k]\mathcal{P}_S^{[1]}(t) = E[X_1 \times 1_{\{S=k\}}] = r_1 \frac{1-q_1}{q_1} R \sum_{\ell=0}^{\infty} \delta_\ell \binom{r+\ell+k-1}{k} (q^*)^{r+1+\ell} (1-q^*)^{k-1},$$

where $q^* = \min(q_1, \dots, q_n)$, $r = r_1 + \dots + r_n$,

$$R = \left(\frac{q^*}{1 - q^*} \right)^n \prod_{j=1}^n \frac{(1 - q_j)}{q_j}$$

$$\delta_{\ell+1} = \frac{1}{\ell + 1} \sum_{i=1}^{\ell+1} i \xi_i \delta_{\ell+1-i}; \quad \delta_0 = 1; \quad \ell \in \mathbb{N}_0$$

and

$$\xi_i = \frac{r_1 + 1}{i} \left(1 - \frac{(1 - q^*)q_1}{q^*(1 - q_1)} \right) + \sum_{j=2}^n \frac{r_j}{i} \left(1 - \frac{(1 - q^*)q_j}{q^*(1 - q_j)} \right).$$

△

For binomial distributions, one requires the success probability to satisfy $q < 1/2$ such that $|a| < 1$. Alternately, if $q > 1/2$, one could express the problem in terms of failure probability $1 - q$ and then apply Theorem 3.2.

	Poisson	Negative binomial	Binomial
a	0	$1 - q$	$-q/(1 - q)$, for $0 < q < 1/2$
b	λ	$(r - 1)(1 - q)$	$(n + 1)1/(1 - q)$
$E[X_1 \times 1_{\{S=k\}}]$	$\lambda f_S(k - 1)$	$r \sum_{j=1}^k (1 - q)^j f_S(k - j)$	$n \sum_{j=1}^k (-1)^{j+1} \left(\frac{q}{1 - q} \right)^j f_S(k - j)$
$E[X_1 \times 1_{\{S \leq k\}}]$ (v1)	$\lambda F_S(k - 1)$	$r \sum_{j=1}^k (1 - q)^j F_S(k - j)$	$n \sum_{j=1}^k (-1)^{j+1} \left(\frac{q}{1 - q} \right)^j F_S(k - j)$
$E[X_1 \times 1_{\{S \leq k\}}]$ (v2)	$\lambda F_S(k - 1)$	$r \frac{1 - q}{q} \sum_{j=1}^k (1 - (1 - q)^j) f_S(k - j)$	$-n \sum_{j=1}^k \frac{1 - \left(\frac{q}{1 - q} \right)^{j+1}}{1 + \frac{q}{1 - q}} f_S(k - j)$

Table 1: Implications of Theorem 3.2 for all distributions.

3.2 Allocations and family of compound Katz distributions

Let M be a frequency rv with support on \mathbb{N} . Let $\{B_1, B_2, \dots\}$ form a sequence of independent and non-negative severity rvs, also independent of M . Within the context of the current paper, we assume that the severity rvs have support on \mathbb{N} . In this section, we consider cases where the rv X is defined as a random sum, that is,

$$X = \begin{cases} 0, & M = 0 \\ \sum_{j=1}^M B_j, & M > 0 \end{cases}. \quad (30)$$

It follows from (30) that the pmf of X is

$$f_X(k) = \begin{cases} \Pr(M = 0), & k = 0 \\ \sum_{j=1}^{\infty} \Pr(M = j) \Pr(B_1 + \dots + B_j = k), & k \in \mathbb{N} \end{cases}.$$

Evaluation of $\Pr(B_1 + \dots + B_j = k)$ is analytically and computationally expensive since direct computation is the result of $j - 1$ convolutions. Fortunately, [Panjer, 1981] and others have developed efficient recursive relationships to compute the pmf of X when M is a Katz distribution, we often refer to these relations as Panjer recursions. We are now interested in the OGF for expected allocations for compound Katz distributions such that we may have an efficient algorithm for expected allocations.

Theorem 3.5. Let X_1 be a compound Katz distribution with parameter $|a| < 1$ and discrete severity rv B_1 , with X_1 independent of S_{-1} . The expected OGF of expected allocations is

$$\mathcal{P}_S^{[1]}(t) = t\mathcal{P}'_{B_1}(t)\mathcal{P}'_{M_1}(\mathcal{P}_{B_1}(t))\mathcal{P}_{S_{-1}}(t). \quad (31)$$

Further, if $|a\mathcal{P}_{B_1}(t)| < 1$ for all $|t| < 1$, then

$$\mathcal{P}_S^{[1]}(t) = t\mathcal{P}'_{B_1}(t)\frac{a+b}{1-a\mathcal{P}_{B_1}(t)}\mathcal{P}_S(t). \quad (32)$$

Proof. The pgf of the compound rv X_1 is $\mathcal{P}_{X_1}(t) = \mathcal{P}_{M_1}(\mathcal{P}_{B_1}(t))$, then (31) follows directly from (18). The relation in (32) follows from the chain rule and Lemma 3.1. \square

Example 3.6 (Independent compound Poisson distributions). Let X_1 be a rv in the class of compound Poisson distributions, whose severity distribution is discrete with support \mathbb{N} . We have

$$\mathcal{P}_S^{[1]}(t) = \lambda_1 t\mathcal{P}'_{B_1}(t)\mathcal{P}_{M_1}(\mathcal{P}_{B_1}(t))\mathcal{P}_{S_{-1}}(t) = \lambda_1 t\mathcal{P}'_{B_1}(t)\mathcal{P}_S(t). \quad (33)$$

It follows that

$$[t^k]\mathcal{P}_S^{[1]}(t) = E[X_1 \times 1_{\{S=k\}}] = \lambda_1 \sum_{l=1}^k l f_{B_1}(l) f_S(k-l), \quad k \in \mathbb{N}^+$$

and

$$\begin{aligned} [t^k] \left\{ \frac{\mathcal{P}_S^{[1]}(t)}{1-t} \right\} &= E[X_1 \times 1_{\{S \leq k\}}] = \lambda_1 \sum_{l=1}^k E[B_1 \times 1_{\{B_1 \leq l\}}] f_S(k-l), \quad k \in \mathbb{N}^+ \\ &= \lambda_1 \sum_{l=1}^k l f_{B_1}(l) F_S(k-l), \quad k \in \mathbb{N}^+. \end{aligned}$$

\triangle

Remark 3.7. The results of Proposition 3.5 are analogous to the results in Section 4 of [Denuit and Robert, 2020] when the severity follows a discrete distribution. One can recover continuous versions of the results from [Denuit and Robert, 2020] using the continuous version of the OGF for expected cumulative allocations, see Section 6 for details. \triangle

3.3 Algorithm for a sum of independent compound Poisson distributed rvs

Consider a portfolio of n participants, where X_i is a compound Poisson distributed rv with frequency parameter λ_i and discrete severity rv B_i for $i = 1, \dots, n$. We have $\mathcal{P}_S(t) = \prod_{i=1}^n \mathcal{P}_{M_i}(\mathcal{P}_{B_i}(t))$. For Poisson distributions, the OGF of expected allocations for the i th risk, $i \in \{1, \dots, n\}$, is $\lambda_i t \mathcal{P}'_{B_i}(t) \mathcal{P}_S(t)$.

We use the FFT algorithm to compute the expected allocations. Using FFT to compute the values of f_S is the most computationally intensive step. Fortunately, since the term $\mathcal{P}_S(t)$ is present for the OGF of the probability mass of S , of the expected allocations and of the expected cumulative allocations, one must only compute the DFT of $\mathcal{P}_S(t)$ once. In Algorithm 1, we present a method to compute the expected allocations in an efficient manner using the FFT. One can change line 6 by the cumulative sum of the vector to compute cumulative expected allocations.

Algorithm 1: Conditional expected allocations for compound Poisson distributions.

Input: Parameters $\lambda_i, \mathbf{f}_{B_i}$ for $i = 1, \dots, n$.
Output: Expected allocations $E[X_i|S = k]$ for $k = 0, \dots, k_{max} - 1$ and $i = 1, \dots, n$

- 1 **for** $i = 1, \dots, n$ **do**
- 2 \lfloor Compute $\widehat{\mathbf{f}}_{X_i} = \mathcal{P}_{X_i}(\widehat{\mathbf{e}}_1)$ or with (21);
- 3 Compute the DFT of S as the element-wise product $\widehat{\mathbf{f}}_S = \prod_{i=1}^n \widehat{\mathbf{f}}_{X_i}$;
- 4 Compute \mathbf{f}_S by taking the inverse DFT of $\widehat{\mathbf{f}}_S$;
- 5 **for** $i = 1, \dots, n$ **do**
- 6 \lfloor Compute the DFT $\widehat{\phi}_{B_i}$ of the vector $\{(k+1)f_{B_i}(k+1)\}_{0 \leq k \leq k_{max}-1}$;
- 7 Compute element-wise $\widehat{\boldsymbol{\mu}}_i = \lambda_i \widehat{\mathbf{e}}_1 \times \widehat{\phi}_{B_i} \times \widehat{\mathbf{f}}_S$;
- 8 Compute $\boldsymbol{\mu}_i$ as the inverse DFT of $\widehat{\boldsymbol{\mu}}_i$;
- 9 \lfloor Compute $\{E[X_i|S = k]\}_{0 \leq k \leq k_{max}-1}$ by the element-wise division $\boldsymbol{\mu}_i / \mathbf{f}_S$;
- 10 **Return** $\{E[X_i|S = k]\}_{0 \leq k \leq k_{max}-1}$ for $i = 1, \dots, n$.

i	λ_i	$f_{C_i}(1)$	$f_{C_i}(2)$	$f_{C_i}(3)$	$f_{C_i}(4)$
1	0.08	0.1	0.2	0.4	0.3
2	0.08	0.15	0.25	0.3	0.3
3	0.1	0.1	0.2	0.3	0.4
4	0.1	0.15	0.25	0.3	0.3

Table 2: Values of λ_i and f_{C_i} for each participant $i \in \{1, \dots, 4\}$ for a small pool of four participants.

4 Applications of the FFT algorithm

In this section, we present a few applications which use the FFT algorithm to solve expected allocations and observe their implications for risk-sharing. We start with a small portfolio of risks, where the FFT algorithm is not essential, but which will explain the method and point out numerical considerations. Then we consider a larger portfolio, to show that the method scales well to problems with many agents. Finally we apply arithmetization techniques to a problem involving heavy tailed risks. To the best of our knowledge, our method is the first that is capable of efficiently handling the large portfolio and heavy tailed portfolios examined in this section, unless each risk is identically distributed, testifying to the utility of our approach.

4.1 Small portfolio of independent compound Poisson distributed rvs

We replicate Case 1 of the application in Section 6.1 of [Denuit, 2019]. Consider four participants in a pool, and each participant contributes risk X_i that follows a compound Poisson distribution, with parameter λ_i and a discrete severity whose pmf is f_{C_i} with support $\{1, 2, 3, 4\}$, for $i \in \{1, \dots, 4\}$. We present the values of λ_i and f_{C_i} for each participant $i \in \{1, \dots, 4\}$ in Table 2. We provide the R code in Appendix A.1, the numerical values that follow come from R version 4.0.4. Other than the setup and validation code, the actual computation of conditional means takes fewer than 15 lines (even if the number of participants grows). We recover the values in [Denuit, 2019].

In Figure 1, we present three graphs: the pmf of S , the total expected allocations for a given

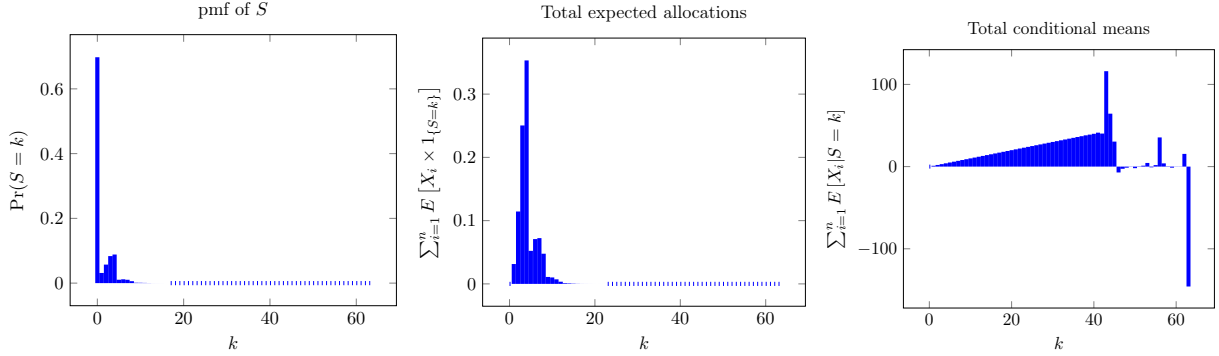

Figure 1: Left: pmf of S . Middle: $\sum_{i=1}^n E[X_i \times 1_{\{S=k\}}]$. Right: $\sum_{i=1}^n E[X_i | S = k]$.

outcome of S , and the total conditional means for a given outcome of S . As stated in (4), one should have $\sum_{i=1}^n E[X_i \times 1_{\{S=k\}}] = k \Pr(S = k)$, which is what we observe in the middle plane of Figure 1. However, one may experience numerical issues when computing the conditional means with the FFT algorithm for values of k where $\Pr(S = k)$ is very small (that is, for impossible events). Note that the sum of conditional means over all participants, for a fixed value of $k \in \mathbb{N}$, should be k . We plot this curve on the right of Figure 1, and it is linear between $k = 0$ and $k = 37$. However, one has $\sum_{i=1}^n E[X_i | S = 38] = 38.05$, which is slightly higher than 38. The FFT method of computing expected allocations provide inaccurate values when the mass function is zero, for example, we have $\sum_{i=1}^n E[X_i | S = 43] = 116$ and $\sum_{i=1}^n E[X_i | S = 63] = -146$. However, we have $\Pr(S = 43) = 1.7 \times 10^{-17}$ and $\Pr(S = 63) = 3.3 \times 10^{-19}$, that is, they are numerically indecipherable from zero because of underflow issues. We return to the discussion of numerical irregularities in the next application.

4.2 Large portfolio of independent compound Poisson distributed rvs

In the second application, we consider a portfolio or pool of 10 000 risks. Each risk X_i is independent and follows a compound Poisson distribution with parameter λ_i , with severity rv $B_i \sim NB(r_i, q_i)$, implying that $E[X_i] = \lambda_i r_i (1 - q_i) / q_i$, for $i = 1, \dots, 10\,000$. We set each risk to have different triplets of parameters. For illustration purposes we simulate the triplets of parameters (λ_i, r_i, q_i) for $i = 1, \dots, 10\,000$ according to $\lambda_i \sim Exp(10)$, $r_i \sim Unif(\{1, 2, 3, 4, 5, 6\})$ and $q_i \sim Unif([0.4, 0.5])$ such that on average, $\lambda_i = 0.1$, $r_i = 3.5$ and $q_i = 0.45$. We present the simulated parameters along with the expected values for the first 8 contracts in Table 3.

i	1	2	3	4	5	6	7	8
λ_i	0.161152	0.031859	0.027368	0.238748	0.115137	0.470203	0.146247	0.011747
q_i	0.489756	0.423367	0.455898	0.451500	0.486834	0.440405	0.440082	0.481335
r_i	2	6	1	4	6	5	3	1
$E[X_i]$	0.335788	0.260354	0.032662	1.160162	0.728190	2.987289	0.558214	0.012658

Table 3: First 8 set of parameters.

We present the code in Appendix A.2, using R version 4.0.4. In Figure 2 (left), we present a plot of $\sum_{i=1}^n E[X_i | S = k]$, for $k \in \{0, 1, \dots, k_{max} - 1\}$. The theoretical value for this expectation is k ,

so one should obtain a straight line, which does occur for $3650 \leq k \leq 5250$. For values of k outside this range, we obtain erratic results, which is due to underflow issues. Indeed, looking at Figure 2, one notices that the pmf of S is non-zero for $3800 \leq k \leq 5000$, hence both $E[X_i \times 1_{\{S=k\}}]$ and $\Pr(S = k)$ are smaller than the precision when using double-precision floating-point format with IEEE 754. Hence, the ratio of two underflow values cause unreliable results and one should discard the corresponding allocations. However, the validation curve is linear over the range where S has a non-zero pmf, so the conditional means of interest are available. The underflow issue occurs with most applications of FFT to identify expected allocations. One can define a range of valid expected allocations by discarding the values of k such that $|k - \sum_{i=1}^n E[X_i | S = k]|$ is larger than some tolerance (we use 10^{-8}). This in no way invalidates the expected allocations obtained using the FFT method, in the same way that using the FFT for risk aggregation may provide negative values for probability masses, when the true probability mass is too small for the floating-point format of the computer program. Our analysis of numerical issues serve only as a warning of considering conditional means only for events of non-zero probability.

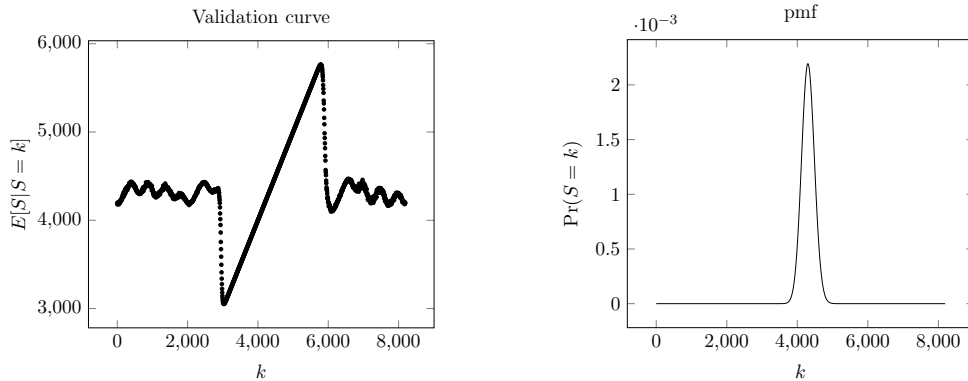

Figure 2: Left: total conditional means. Right: pmf of S .

The listing in Appendix A.2 computes $1600 \times 10\,000$ conditional means at once and takes approximately 16 seconds on a personal computer (with a Intel®Core™i5-7600K CPU @ 3.80GHz CPU).

In Figure 3 we present the pmf of the conditional means $E[X_i | S]$, for $i \in \{1, \dots, 8\}$. Note that all eight pmfs share the same values on the y -axis, but have different values on the x -axis. This is because the probability masses for conditional means are given by the relationship $\Pr(E[X_i | S] = E[X_i | S = k]) = \Pr(S = k)$, for all $i \in \{1, \dots, 10\,000\}$ and $k \in \mathbb{N}$. The only difference are the domains of $E[X_i | S]$ for $i \in \{1, \dots, 10\,000\}$. Indeed, although the pmf for the conditional means of risk $j = 2$ (in red) appears to be a single point mass, we observe by magnifying that the pmf shares the probability values from the other pmfs. Also, as shown by the authors of [Denuit and Robert, 2021b] that under mild technical conditions, the conditional means converge to the expected value. For illustration purposes, we add vertical dashed lines at the expected values.

Note that we optimize our algorithm for speed, so we store intermediate values of f_B and \hat{f}_X in vectors. The code required about 10Gb of RAM to store the intermediate values, which may become high for home computers. In this situation, we recommend storing intermediate values in a separate file or not storing the values at all (which will require computing \hat{f}_X several times, but take much less RAM).

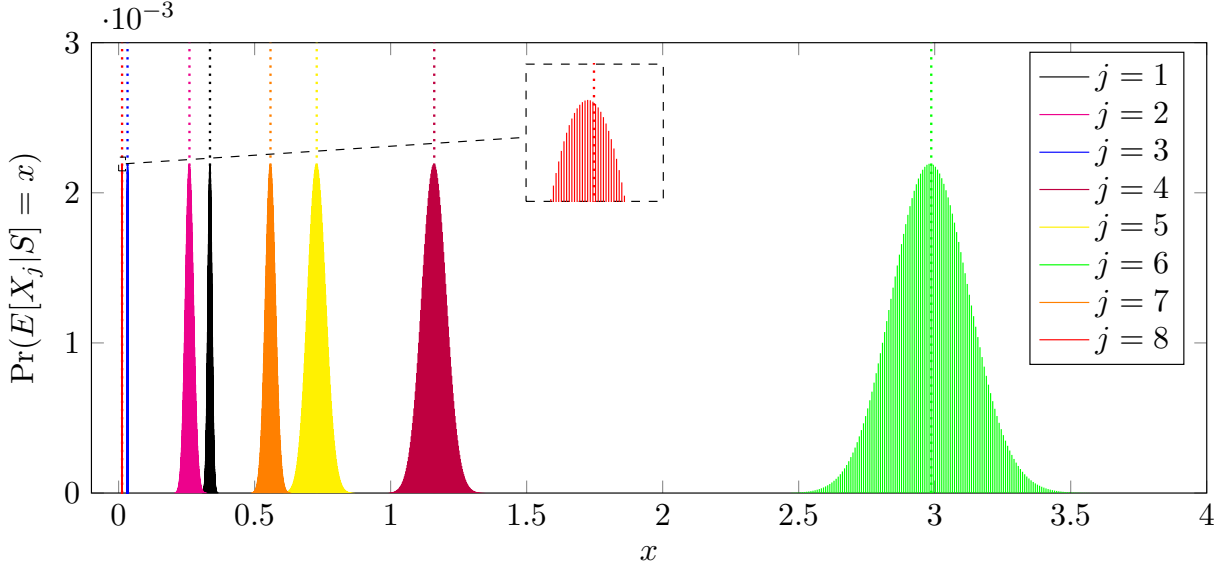

Figure 3: pmf of the conditional means $E[X_i|S]$, for the contracts $i \in \{1, \dots, 8\}$. The vertical lines go through the values $E[X_i]$, for $i = 1, \dots, 8$.

4.3 Portfolio of heavy tailed risks

Next, we consider the computation of expected allocations for a portfolio of heavy-tailed risks. In particular, we consider risks whose variance does not exist; hence the central limit theorem results of [Denuit and Robert, 2021b] do not hold because the variance of the sum of each rv does not exist. We consider a portfolio of size $n \in \{3, 100, 1000\}$ and compare the behaviour of the first three contracts. Our goal is to illustrate empirically that the conditional mean for each contract converges to their individual mean. We set $X_i, i \in \{1, \dots, n\}$, to follow an arithmetized Pareto distribution defined using the moment matching method, see, for instance, Appendix E.2 of [Klugman et al., 2018]. Further, we select parameters $\alpha_i \in [1.3, 1.9]$, for $i \in \{1, \dots, n\}$, so the variance of individual risks does not exist. For the first three risks, we select $(\alpha_1, \alpha_2, \alpha_3) = (1.3, 1.6, 1.9)$ and $(\lambda_1, \lambda_2, \lambda_3) = (10(1.3 - 1), 10(1.6 - 1), 10(1.9 - 1))$ such that $E[X_j] \approx 10$ for $i \in \{1, 2, 3\}$. We write the approximate symbol since the mean may not be preserved exactly due to truncation, since Pareto rvs are heavy tailed. For the remaining risks $X_i, i \in \{4, \dots, 1000\}$, we simulate the parameters according to $\alpha_i \sim Unif([1.3, 1.9])$ and $\lambda_i \sim Unif([5, 15])$, implying $50/9 \leq E[X_j] \leq 50$ for $i \in \{4, \dots, 1000\}$, and the variance does not exist for any risk in the portfolio. We provide the code in Appendix A.3.

In Figure 4 we present the cdf of the conditional means for risks X_1, X_2 and X_3 . The dashed, dotted, and dash-dotted lines present the cdf of conditional means for $n = 3, 100$ and 1000 respectively. Due to the heavy tailed risks, one must select a large truncation point k_{max} to avoid aliasing (see, for instance, [Grubel and Hermesmeier, 1999] and [Embrechts and Frei, 2009] for discussions on aliasing with FFT methods for aggregation). Hence, we compute $1\,000 \times 2^{20}$ values, which takes approximately 9 minutes on a personal laptop. To facilitate comparisons, we present the cdf of X_i in red and the expected value of X_i in green (vertical line), $i \in \{1, 2, 3\}$. Each cdf cross once, hence following the Karlin-Novikoff criteria and since they share the same mean, then the conditional means are ordered under the convex order, which is expected, see, for instance, [Denuit and Dhaene, 2012].

One may observe that the cdfs of the conditional means approach the cdf of a degenerate rv at the mean. The conditional mean of X_3 approaches the degenerate rv at its mean faster since its tail is lighter than X_1 or X_2 . Indeed, one observes that the cdf of $E[X_3 \times 1_{\{X_1 + \dots + X_{1000} = k\}}]$ is almost vertical, while the cdf of $E[X_1 \times 1_{\{X_1 + \dots + X_{1000} = k\}}]$ is not.

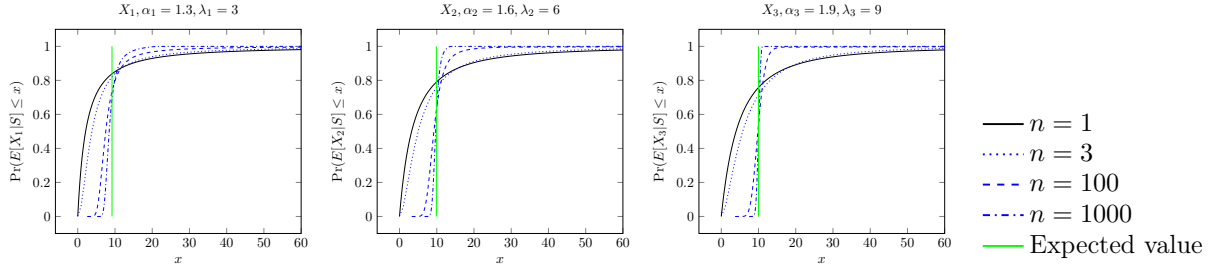

Figure 4: Cumulative distribution function of conditional means for $n = 1, 3, 100, 1000$.

According to this application, one observes that the conditional mean $E[X_1|S]$ converges in probability to the expected value $E[X_1]$ as the size of the portfolio increases. However, future research remains to show that this conjecture is true in general, that is, providing a law of large numbers result for the conditional mean, generalizing the results of [Denuit and Robert, 2020] and [Denuit and Robert, 2021b].

4.4 Application: small portfolio of heterogeneous claims

Let $\mathbf{I} = (I_1, \dots, I_n)$ be a vector of independent Bernoulli rvs with marginal probabilities $q_i \in (0, 1)$, for $i \in \{1, \dots, n\}$. Further define the rv $X_i = b_i \times I_i$, with $b_i \in \mathbb{N}^+$, for $i \in \{1, \dots, n\}$. This model is sometimes called the individual risk model (with a fixed payment amount) and has applications for instance in life insurance, where death benefits are usually known in advance, or for insurance-linked securities in situations where investors recover their initial investment unless a trigger event occurs before the maturity date. The interested reader may refer to [Klugman et al., 2013] for detailed examples of the individual risk model. The multivariate pgf of $\mathbf{X} = (X_1, \dots, X_n)$ is

$$\mathcal{P}_{\mathbf{X}}(t_1, \dots, t_n) = \prod_{i=1}^n (1 - q_i + q_i t_i^{b_i}), \quad (34)$$

while the OGF of the sequence of expected allocations for risk X_1 is

$$\mathcal{P}_S^{[1]}(t) = q_1 b_1 t^{b_1} \prod_{i=2}^n (1 - q_i + q_i t^{b_i}).$$

To compute exact values of the pmf and expected allocations using the FFT approach, one must select $k_{max} \geq 1 + \sum_{i=1}^n b_i$ (or alternatively, select the smallest m such that $2^m \geq 1 + \sum_{i=1}^n b_i$).

Let us discuss some of the theoretical difficulties with computing the conditional means in the context of this application. To do so, we will need some notation. The cardinality of a set \mathcal{A} is denoted by $|\mathcal{A}|$. Define the set $\mathcal{B} = \{(x_1, \dots, x_n) : x_i \in \{0, b_i\}, 1 \leq i \leq n\}$ as all distinct possible outcomes of \mathbf{X} . Note that $|\mathcal{B}| = 2^n$. Define $\mathcal{B}_k = \{(x_1, \dots, x_n) \in \mathcal{B} : \sum_{i=1}^n x_i = k\}$, for $k = 0, 1, \dots, s_{max}$, where $s_{max} = \sum_{i=1}^n b_i$. Note that $|\mathcal{B}_0| = 1$ and $|\mathcal{B}_{s_{max}}| = 1$.

The sets \mathcal{B}_k and $\mathcal{B}_{k'}$ are mutually exclusive, i.e. $\mathcal{B}_k \cap \mathcal{B}_{k'} = \emptyset$, for $k \neq k' \in \{1, \dots, n\}$. Also, $\bigcup_{k=0}^{s_{max}} \mathcal{B}_k = \mathcal{B}$. When \mathcal{B}_k is empty ($\mathcal{B}_k = \emptyset$), we have $|\mathcal{B}_k| = 0$, meaning the event $\{S = k\}$ is impossible. Such situations may occur when the number of contracts is small and the coverage amounts are heterogeneous. We say that k is a possible outcome of the total losses S if $|\mathcal{B}_k| > 0$.

Fix $k \in \{0, 1, \dots, s_{max}\}$ such that $|\mathcal{B}_k| = 1$, and let (x_1, \dots, x_n) be the element of that singleton. This implies that the conditional expectation is given by $E[X_i|S = k] = x_i$, for $x_i \in \{0, b_i\}$, which means that $E[X_i|S = k]$ can take the values 0 or its full coverage b_i , for $i \in \{1, \dots, n\}$. In other words, the support of $E[X_i|S = k]$ is the same as the support of X_i , hence a participant in a pool has not benefited from a diversification of its risk if $S = k$ has occurred, no matter the size n of the portfolio. As $|\mathcal{B}_k|$ increases, $E[X_i|S = k]$ can take more values, and these are the situations where insurance provides more value to customers. Counting the number of partitions of a set is a difficult problem in number theory. Fortunately, the OGF method provides a numerical solution to compute the expected allocations without further notions of number theory. See also Example 4.1 of [Demuit et al., 2021] for a situation where no diversification occurs for some participants due to partitions of odd numbers.

We consider a portfolio of $n = 6$ risks. We present the parameters for this example in Table 4, and the code to replicate this study is in Appendix A.4.

i	1	2	3	4	5	6
b_i	1	3	10	4	5	10
q_i	0.8	0.2	0.3	0.05	0.15	0.25

Table 4: Marginal parameters for small portfolio of heterogeneous claims.

In Figure 5, we present the conditional means along with the pmf and cdf of conditional means for risks X_1 , X_2 and X_3 . We describe each panel in the following:

- The left panel presents the values of $E[X_i|S]$, for $i \in \{1, 2, 3\}$. Note that for the claim severity values in Table 4, we have $|\mathcal{B}_2| = |\mathcal{B}_{31}| = 0$, hence the events $S = 2$ and $S = 31$ are impossible and we have $\Pr(S = 2) = \Pr(S = 31) = 0$. When computed using the pgf in (39) and the FFT algorithm, we have $\Pr(S = 2) = \Pr(S = 31) \approx 10^{-16}$ since this is the underflow error using double precision with IEEE 754. Hence, the conditional means should be 0 for $k = 2$ and $k = 31$, division of two underflowed values generates erratic results. These values should be rejected from the analysis, but we show them in red here as a warning of numerical problems with the FFT method if one is not wary of underflow versus true zeroes when using the FFT method. As in other applications, one should observe the total conditional means (row 4 of Figure 5) and retain the values that form a step function with steps of 1. Conditional means which deviate from its expected total should be discarded, either due to underflow or to division by zero. However, the events which cause numerical issues have zero or negligible probability (under 10^{-16}), hence the expectations of interest do not suffer from underflow.

Also of interest is the shape of conditional means as a function of k . For $i = 1$, we have unpredictable expected allocations since the outcome 1 is often a part of \mathcal{B}_k , $k \in \mathbb{N}^+$, and q_1 is greater than q_i , $i \in \{2, \dots, 6\}$. For $i = 2$, we have predictable expected allocations since 3 is a part of \mathcal{B}_k for cyclical values of k , and 3 does not divide the other values of b_i , $i \in \{1, 3, 4, 5, 6\}$. Finally, we have $b_3 = 10$ and $b_6 = 10$. Hence, the conditional allocations are often shared

between risks X_3 and X_6 , though not perfectly since $q_3 \neq q_6$. In row 3 of Figure 5, we also have a mass around 7.5 since the outcomes $X_1 = 1$, $X_4 = 4$ and $X_5 = 5$ yields $S = 10$. Once again the allocation is above 7.5 since $\Pr(X_3 = 10) + \Pr(X_6 = 10) > \Pr(X_1 = 1, X_4 = 4, X_5 = 5)$.

- The middle panel presents the pmf of $E[X_i|S]$, for $i \in \{1, 2, 3\}$. The support of this rv is the set of values $\{E[X_i|S = k], k \in \mathbb{N}\}$, for $i \in \{1, 2, 3\}$. Notice that the support of this rv is sparse, for small portfolios with heterogeneous values of $b_i, i \in \{1, \dots, n\}$.
- The right panel presents the cdf of $E[X_i|S]$, for $i \in \{1, 2, 3\}$, which simplifies the interpretation of the middle panel since the probability masses may appear close together.

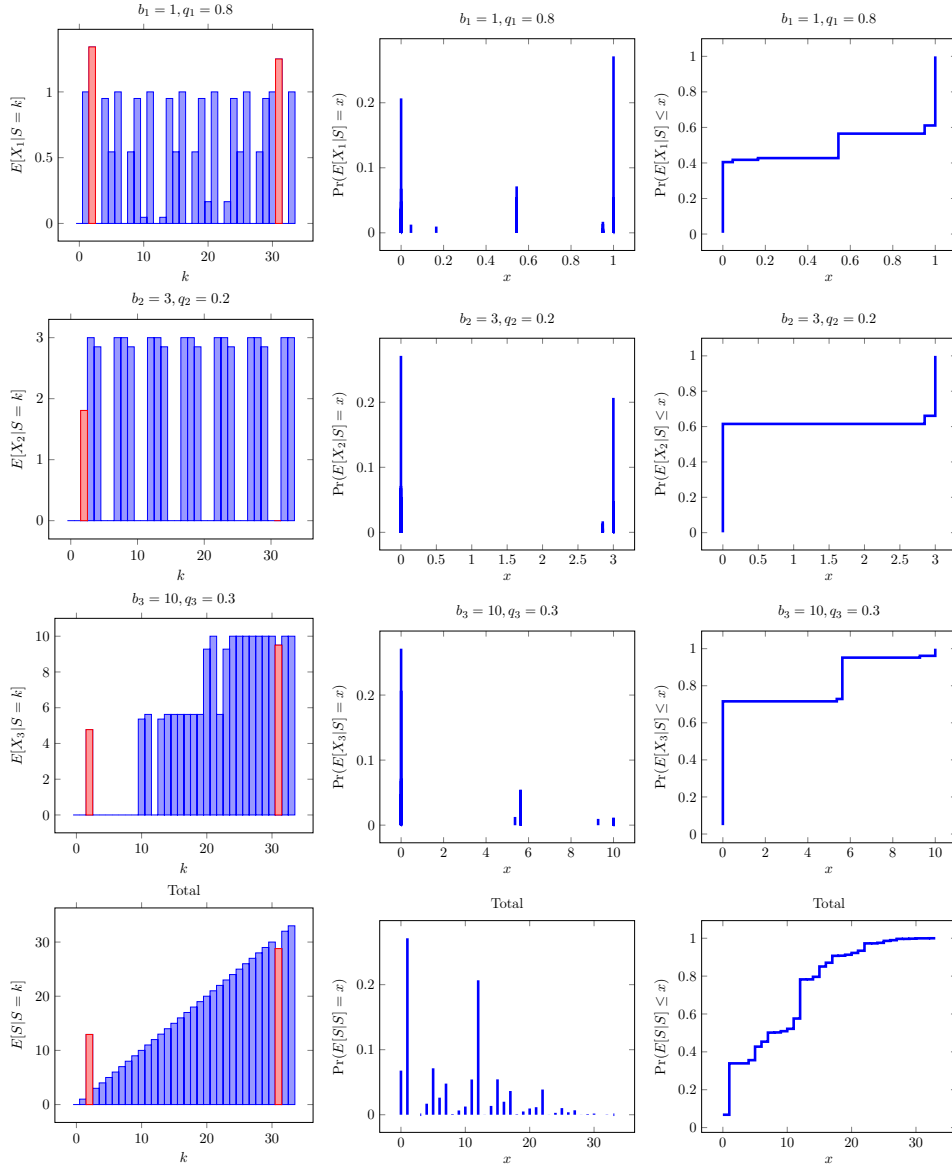

Figure 5: Left: conditional means. Middle: pmf of conditional means. Right: cdf of conditional means.

Note that as more participants enter the pool, more risks may diversify, that is, \mathcal{B}_k has a higher cardinality for all $k \in \mathbb{N}^+$. It follows that the risks diversify and the pmf of expected allocations is less sparse. In Figure 6, we replicate the above study but add 69 participants where we sample the parameters according to $q_i \sim Unif([0, 1])$ and $b_i \sim Unif(\{1, 2, \dots, 10\})$. We present the results for risk 3 (with $b_3 = 10$) and the total pool in Figure 6. We observe once again that there are numerical issues for large values of k in the left panel. However, the middle panel is much less sparse than in Figure 5.

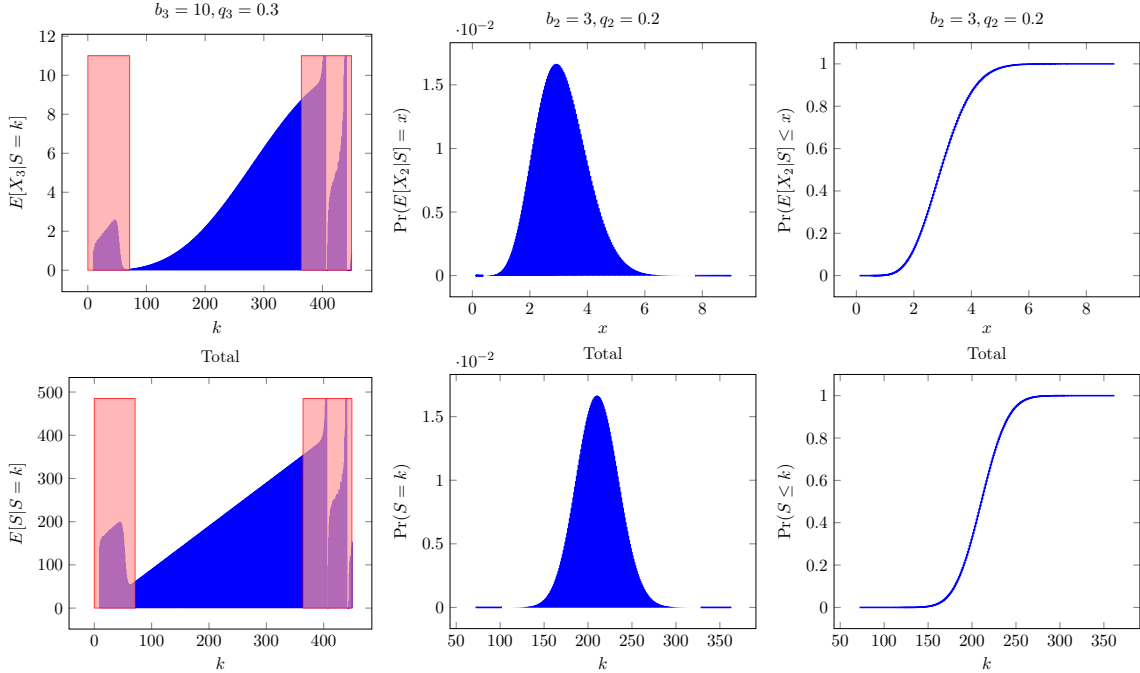

Figure 6: Pool of 75 participants. Left: conditional means. Middle: pmf of conditional means. Right: cdf of conditional means.

5 Sum of dependent rvs

One may also use the methods described in this paper to compute expected allocations for dependent rvs. One obtains convenient results when the multivariate pgf is simple to differentiate, which is sometimes the case for mixture models (which include common shock models). The results from this section supplement the literature on risk allocation or risk sharing for mixture models as studied in Section 3 of [Cossette et al., 2018] or Section 4 of [Denuit and Robert, 2021a].

5.1 Multivariate Poisson distribution constructed with common shocks

As a first example, we present a common shock model. Multivariate Poisson distributions based on common shocks are studied notably in [Teicher, 1954] and [Mahamunulu, 1967]. The interested reader may also consult [Lindskog and McNeil, 2003] for actuarial applications of common shock

Poisson models.

Example 5.1 (Hierarchical common Poisson shocks). Let $Y_A \sim \text{Pois}(\lambda_A)$ for $A \in \{\{1, 2\}^3 \cup \{1, 2\}^2 \cup \{0, 1, 2\}\}$ be independent rvs. We construct dependent rvs through the common shock framework $X_{ijk} = Y_{ijk} + Y_{ij} + Y_i + Y_0$ for $(i, j, k) \in \{1, 2\}^3$. This is a special case of the multivariate Poisson distribution from [Mahamunulu, 1967], and we illustrate the dependence structure in Figure 7. Let

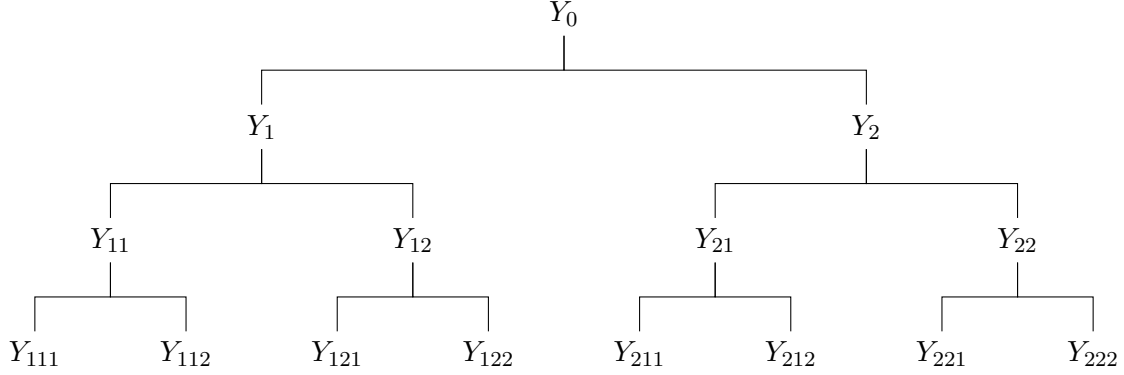

Figure 7: Hierarchical Poisson common shock structure.

$S = \sum_{(i,j,k) \in \{1,2\}^3} X_{ijk}$. Then one may verify that S follows a compound Poisson distribution, so one may use Panjer recursion or FFT to compute the values of the pmf of S . Further, the OGF for the expected allocations of risk X_{ijk} , for $(i, j, k) \in \{1, 2\}^3$, is

$$\mathcal{P}_S^{[ijk]}(t) = (\lambda_{ijk}t + \lambda_{ij}t^2 + \lambda_it^4 + \lambda_0t^8) \mathcal{P}_S(t).$$

For $(i, j, k) \in \{1, 2\}^3$, we deduce that

$$E [X_{ijk} \times 1_{\{S=k\}}] = \begin{cases} 0, & k = 0 \\ \lambda_{ijk}f_S(k-1), & k = 1 \\ \lambda_{ijk}f_S(k-1) + \lambda_{ij}f_S(k-2), & k = 2, 3 \\ \lambda_{ijk}f_S(k-1) + \lambda_{ij}f_S(k-2) + \lambda_if_S(k-4), & k = 4, \dots, 7 \\ \lambda_{ijk}f_S(k-1) + \lambda_{ij}f_S(k-2) + \lambda_if_S(k-4) + \lambda_0f_S(k-8), & k = 8, 9, \dots \end{cases}.$$

More general Poisson common shock models as proposed in [Mahamunulu, 1967] yield similar expressions for expected and cumulative expected allocations. \triangle

5.2 Multivariate mixed Poisson distribution

Next, we consider a multivariate mixed Poisson distribution. We induce dependence using a mixture random vector $\Theta = (\Theta_1, \dots, \Theta_n)$ with $E[\Theta_i] = 1$ for $i = 1, \dots, n$. Consider a vector of conditionally independent rvs $(X_i | \Theta_i = \theta_i) \sim \text{Poisson}(\lambda_i \theta_i)$ for $i = 1, \dots, n$. The joint pgf of (X_1, \dots, X_n) is

$$\mathcal{P}_{\mathbf{X}}(t_1, \dots, t_n) = E_{\Theta} \left[e^{\Theta_1 \lambda_1 (t_1 - 1)} \dots e^{\Theta_n \lambda_n (t_n - 1)} \right] = \mathcal{M}_{\Theta}(\lambda_1(t_1 - 1), \dots, \lambda_n(t_n - 1)), \quad (35)$$

where \mathcal{M}_{Θ} is the joint moment generating function (mgf) of Θ . Then, combining Theorem 2.4 and (35), we find that

$$\mathcal{P}_S^{[1]}(t) = \lambda_1 t \left[\frac{\partial}{\partial x} \mathcal{M}_{\Theta}(x, \lambda_2(t-1), \dots, \lambda_n(t-1)) \right] \Big|_{x=\lambda_1(t-1)}. \quad (36)$$

Example 5.2 (Poisson-gamma common mixture). We consider a mixture distribution from a bivariate gamma common shock model described in [Mathai and Moschopoulos, 1991]. Let us define three independent rvs $Y_i, i \in \{0, 1, 2\}$ where $Y_0 \sim \text{Gamma}(\gamma_0, \beta_0)$, and $Y_i \sim \text{Gamma}(r_i - \gamma_0, r_i)$ for $i \in \{1, 2\}$ with $0 \leq \gamma_0 \leq \min(r_1, r_2)$. Let $\Theta_i = \beta_0/r_i Y_0 + Y_i$ for $i = 1, 2$. Then the pair of rvs (Θ_1, Θ_2) follows a bivariate gamma distribution with marginals $\Theta_i \sim \text{Ga}(r_i, r_i), i = 1, 2$ and γ_0 is a dependence parameter. The joint mgf of the pair of rvs (Θ_1, Θ_2) is

$$\mathcal{M}_{\Theta_1, \Theta_2}(x_1, x_2) = \left(1 - \frac{x_1}{r_1}\right)^{-(r_1 - \gamma_0)} \left(1 - \frac{x_2}{r_2}\right)^{-(r_2 - \gamma_0)} \left(1 - \frac{x_1}{r_1} - \frac{x_2}{r_2}\right)^{-\gamma_0} \quad (37)$$

and its derivative with respect to x_1 is

$$\frac{\partial}{\partial x_1} \mathcal{M}_{\Theta_1, \Theta_2}(x_1, x_2) = \left(\frac{r_1 - \gamma_0}{r_1} \frac{1}{1 - x_1/r_1} + \frac{\gamma_0}{r_1} \frac{1}{1 - x_1/r_1 - x_2/r_2}\right) \mathcal{M}_{\Theta_1, \Theta_2}(x_1, x_2). \quad (38)$$

Consequently, the mixed Poisson distributed random vector (X_1, X_2) follows a bivariate negative binomial distribution. It follows from (35) and (37) that

$$\mathcal{P}_S(t) = (1 - \zeta_1(t - 1))^{-(r_1 - \gamma_0)} (1 - \zeta_2(t - 1))^{-(r_2 - \gamma_0)} (1 - \zeta_{12}(t - 1))^{-\gamma_0},$$

where $\zeta_1 = \lambda_1/r_1, \zeta_2 = \lambda_2/r_2$ and $\zeta_{12} = \lambda_1/r_1 + \lambda_2/r_2$. We recognize that S is the sum of three independent negative binomial rvs with parameters $(r_1 - \gamma_0, 1/(1 - \zeta_1)), (r_2 - \gamma_0, 1/(1 - \zeta_2))$ and $(\gamma_0, 1/(1 - \zeta_{12}))$. The expression of the pmf f_S of S is given in Theorem 1 of [Furman, 2007]. From (36) and (38) we get the following expression for the OGF for expected allocations:

$$\mathcal{P}_S^{[1]}(t) = \lambda_1 t \left(\frac{1 - \gamma_0/r_1}{1 - \zeta_1(t - 1)} + \frac{\gamma_0/r_1}{1 - \zeta_{12}(t - 1)}\right) \mathcal{P}_S(t).$$

Finally, we can recover the expected allocations using FFT or with the convolution

$$[t^k] \mathcal{P}_S^{[1]}(t) = E[X_1 \times 1_{\{S=k\}}] = \lambda_1 \sum_{j=0}^{k-1} \left[\left(1 - \frac{\gamma_0}{r_1}\right) \frac{1}{1 + \zeta_1} \left(\frac{\zeta_1}{1 + \zeta_1}\right)^j + \frac{\gamma_0}{r_1} \frac{1}{1 + \zeta_{12}} \left(\frac{\zeta_{12}}{1 + \zeta_{12}}\right)^j\right] f_S(k-1-j).$$

One may develop similar expressions for expected cumulative allocations, applying the cumulative operator to the geometric series or to the pmf of S . \triangle

5.3 Multivariate Bernoulli distributions defined with Archimedean copulas

Finally, we consider a multivariate Bernoulli distribution whose dependence structure is defined with an Archimedean copula. Let (I_1, \dots, I_n) form a random vector, where the marginal distributions are Bernoulli with success probability $q_i \in (0, 1)$, for $i \in \{1, \dots, n\}$. Following [Marshall and Olkin, 1988], we define the random vector according to $\Pr(I_i = 1 | \Theta = \theta) = r_i^\theta$, where Θ is a mixing rv with strictly positive support. The relationship between the parameters r_i and q_i is

$$\Pr(I_i = 1) = E_\Theta[r_i^\Theta] = \mathcal{L}_\Theta(-\ln r_i),$$

from which it follows that $r_i = \exp\{-\mathcal{L}_\Theta^{-1}(q_i)\}$, where $\mathcal{L}_\Theta(t)$ and $\mathcal{L}_\Theta^{-1}(t)$ are respectively the Laplace-Stieltjes transform and the inverse Laplace-Stieltjes transform of the mixing rv. Further define the rv $X_i = b_i \times I_i$, with $b_i \in \mathbb{N}^+$ for $i \in \{1, \dots, n\}$. Note that the rvs $(X_i | \Theta = \theta)$ are conditionally

independent, for $i \in \{1, \dots, n\}$ and $\theta > 0$. It follows that the multivariate pgf of $\mathbf{X} = (X_1, \dots, X_n)$ is

$$\mathcal{P}_{\mathbf{X}}(t_1, \dots, t_n) = E \left[\prod_{i=1}^n (1 - r_i^\theta + r_i^\theta t_i^{b_i}) \right] = \int_0^\infty \prod_{i=1}^n (1 - r_i^\theta + r_i^\theta t_i^{b_i}) dF_\Theta(\theta).$$

This model has applications for instance in life insurance, where death benefits are usually known in advance, or for insurance-linked securities in situations where investors recover their initial investment unless a trigger event occurs before the maturity date.

We note that the underlying dependence structure in this model is an Archimedean copula, see, for instance, [Marshall and Olkin, 1988], Section 4.7.5.2 of [Denuit et al., 2006] or Section 7.4 of [McNeil et al., 2015] for the frailty construction of Archimedean copulas using common mixtures.

We consider the case where Θ is a discrete rv with support \mathbb{N}^+ . Following the computational strategy from [Cossette et al., 2018], we select a threshold value $\theta^* = F_\Theta^{-1}(1 - \varepsilon)$ for a small $\varepsilon > 0$ and we have

$$\mathcal{P}_S(t) = \sum_{\theta=1}^{\theta^*} \Pr(\Theta = \theta) \prod_{i=1}^n (1 - r_i^\theta + r_i^\theta t^{b_i}). \quad (39)$$

Note that when the components of the random vector are independent, the rv S follows a generalized Poisson-binomial distribution [Zhang et al., 2018]. In the case of (39), we notice the pgf of a mixture of generalized Poisson-binomial distributions, where the mixture rv comes from the frailty construction of Archimedean copulas.

The OGF of the sequence of expected allocations for risk X_1 is

$$\mathcal{P}_S^{[1]}(t) = \sum_{\theta=1}^{\theta^*} \Pr(\Theta = \theta) r_1^\theta b_1 t^{b_1} \prod_{i=2}^n (1 - r_i^\theta + r_i^\theta t^{b_i}).$$

Example 5.3. We consider a portfolio of $n = 6$ risks, with Θ following a shifted geometric rv with pmf $f_\Theta(k) = (1 - \alpha)\alpha^{k-1}$, for $k \in \mathbb{N}^+$, with $\alpha = 0.5$. It follows that the underlying dependence structure is an Ali-Mikhail-Haq copula. Following [Cossette et al., 2018], we select a threshold $\varepsilon = 10^{-10}$, such that $\theta^* = 34$. The indemnity payments are the same as in Table 4. We present the validation curve, the pmf for the conditional means of risk X_3 , and the pmf of S in Figure 8 for $\alpha \in \{0, 0.1, 0.5, 0.8, 0.95\}$. Increasing the dependence parameter has the effect of increasing the probability of zero contributions and of full ($X_3 = b_3$) contributions. For other allocation values, the support of $E[X_3|S]$ tends to cluster around the same value of 6 since increasing the dependence also increases the probability of mutual occurrence. Indeed, the probabilities for the outcomes $X_1 = 1, X_4 = 4$ and $X_5 = 5$ become more likely (resp. 0.006, 0.007, 0.011, 0.02 and 0.032 for $\alpha = 0, 0.1, 0.5, 0.8$ and 0.95), so more diversification occurs when the total costs are divisible by 10, as α increases.

Next, we add 69 participants to the pool to investigate the effect of reducing the sparsity of the possible expected allocations. We present the validation curve, the values of $\Pr(E[X_3|S] = k)$ for $k \in \{0, \dots, 441\}$ and $\alpha = \{0, 0.1, 0.5, 0.8, 0.95\}$ in Figure 9. Note that the pmf of S does not always converge to a normal distribution, hence central limit theorems do not apply. Indeed, the common mixture representation of the Ali-Mikhail-Haq copula generates multiple nodes for the pmf of S in this example. However, the OGF method with the FFT algorithm lets us extract the exact values of the pmf of expected allocations with ease. As we increase the dependence parameter,

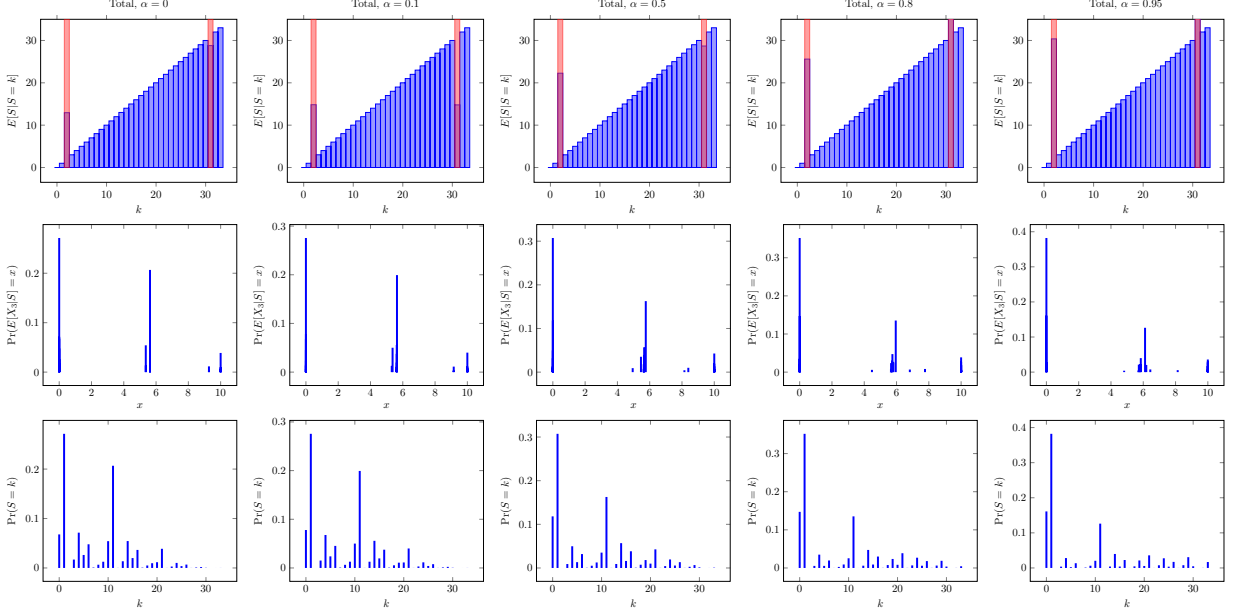

Figure 8: Pool of six participants.

the probability mass of S and $E[X_3|S]$ is less concentrated around its means, thus the tail of the distributions have non-zero mass, so there are no numerical issues in the validation curve. The code for this example is provided in Appendix A.4. \triangle

6 Discussion

We proposed a generating function method to compute the expected allocation, which has valuable applications in peer-to-peer insurance and risk allocation problems. The method simplifies solutions to some risk allocation problems and enables FFT-based algorithms for fast computations.

The link between derivatives of pgfs and conditional distributions is not new. See, for instance, the use of derivatives to study conditional distributions with Poisson rvs [Subrahmaniam, 1966, Kocherlakota, 1988] or with phase-type distributions [Ren and Zitikis, 2017]. In a bivariate setting, [Kocherlakota, 1992] show that the conditional pgf of X_1 given the sum $S = X_1 + X_2 = s$ is

$$\mathcal{P}_{X_1|S}(t_1|k) = \frac{\frac{\partial^k}{\partial t_2^k} \mathcal{P}_{X_1, X_2}(t_1 t_2, t_2) \Big|_{t_1=t, t_2=0}}{\frac{\partial^k}{\partial t_2^k} \mathcal{P}_{X_1, X_2}(t_1 t_2, t_2) \Big|_{t_1=1, t_2=0}},$$

for $|t_1| \leq 1$ and $k \in \mathbb{N}$. However, computing conditional expected values in this case would involve computing multiple partial derivatives of the bivariate pgf. The method proposed in this paper considers only requires one partial derivative, a more convenient and tractable task.

We remark that the generating function method provides a simpler proof of the size-biased transform method of computing expected allocations for discrete rvs. With \tilde{X} representing the size-biased transform of the rv X , along with the definition of the size-biased transform in (11), the

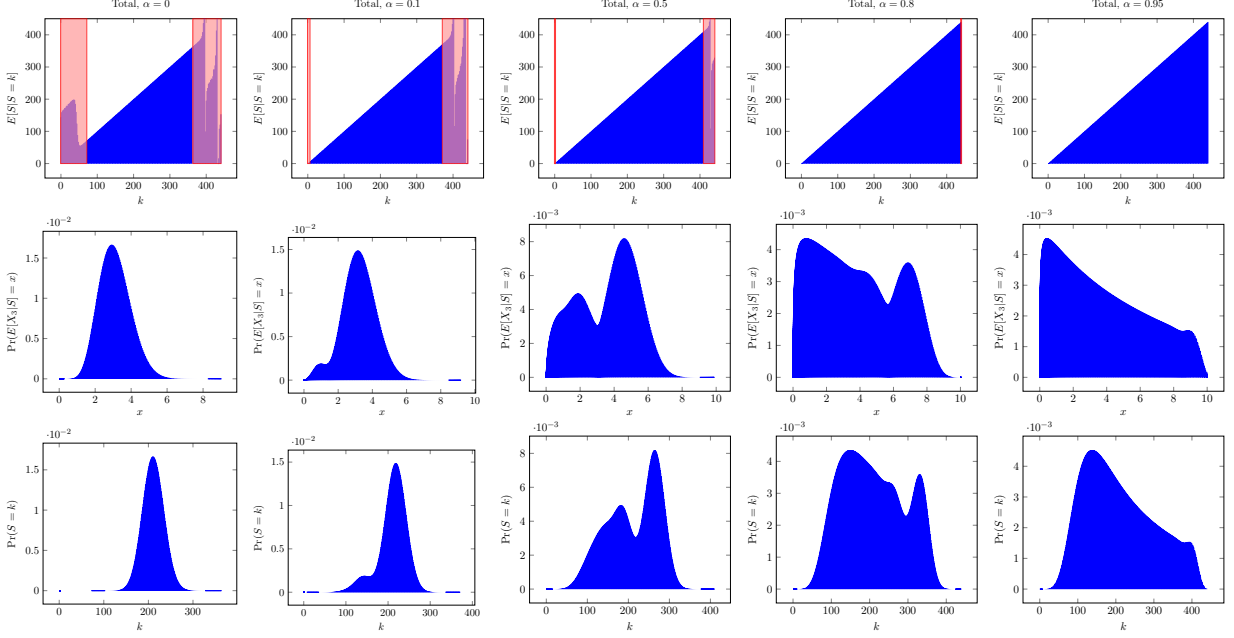

Figure 9: Pool of 75 participants.

relationship between the pgfs of X and \tilde{X} is

$$\mathcal{P}_{\tilde{X}}(t) = E[t^{\tilde{X}}] = \sum_{k=0}^{\infty} t^k f_{\tilde{X}}(k) = \frac{t}{E[X]} \sum_{k=0}^{\infty} k t^{k-1} f_X(k) = \frac{t}{E[X]} \frac{d}{dt} \sum_{k=0}^{\infty} t^k f_X(k) = \frac{t}{E[X]} P'_X(t),$$

for $|t| \leq 1$. Alternatively, one can obtain the pgf of \tilde{X} by applying operation 2 (right shift) and 3 (index multiply) of OGFs from Theorem 2.2. See also Section 2.2.1 of [Arratia et al., 2019] for discussions on the characteristic function and pgfs of size-biased rvs. From (18), we have

$$\mathcal{P}_S^{[1]}(t) = E[X_1 t^S] = \sum_{k=0}^{\infty} t^k \sum_{k_1=0}^k k_1 f_{X_1, S_{-1}}(k_1, k - k_1) = \sum_{k=0}^{\infty} t^k \sum_{k_1=0}^k \frac{f_{\tilde{X}_1, S_{-1}}(k_1, k - k_1)}{E[X_1]},$$

then $E[X_1] \mathcal{P}_S^{[1]}(t)$ is the pgf of $\tilde{X}_1 + S_{-1}$, so (10) follows immediately.

Future research could involve developing methods to quantify or correct aliasing errors for heavy-tailed distributions. In Section 4.3, we use a very large truncation point ($k_{max} = 2^{20}$). As computer processors continue to perform faster computations, it is convenient to increase the truncation point; however, it may also be convenient to provide methods that reduce this error source for efficiency's sake. The authors of [Grubel and Hermesmeier, 1999] quantify the aliasing error related to using the FFT algorithm to compute the pmf of compound distributions and also propose a tilting procedure to reduce this error. Developing a similar theory for the OGFs of expected allocations and expected cumulative allocations will increase these methods' efficiency.

Another research topic involves the allocation of tail variance. In [Furman and Landsman, 2006], the authors introduce the tail variance, defined by

$$TV_{\kappa}(X) = Var(X|X > F_X^{-1}(\kappa)),$$

with $\kappa \in (0, 1)$, and propose allocations via the tail covariance allocation rule,

$$TCov_\kappa(X_1|S) = Cov(X_1, S|S > F_S^{-1}(\kappa)) = \sum_{j=1}^n Cov(X_1, X_j|S > F_S^{-1}(\kappa)).$$

One can obtain efficient algorithms to compute the desired expectations once again. We have

$$E[X_1 X_j t^S] = \left\{ t_1 t_j \frac{\partial^2}{\partial t_1 \partial t_j} \mathcal{P}_{X_1, \dots, X_n}(t_1, \dots, t_n) \right\} \Big|_{t_1 = \dots = t_n = t}$$

for $j \in \{1, \dots, n\} \setminus \{1\}$. The OGF for expected allocations for the second factorial moment is

$$E[X_1(X_1 - 1)t^S] = \left\{ t_1^2 \frac{\partial^2}{\partial t_1^2} \mathcal{P}_{X_1, S-1}(t_1, t_2) \right\} \Big|_{t_1 = t_2 = t},$$

one can generalize the latter formula to k th factorial moments by taking subsequent derivatives. It follows that $E[X_1 X_j | S > k]$ and $E[X_1^2 | S > k]$ can be computed with

$$E[X_1 X_j \times 1_{\{S \leq k\}}] = [t^k] \left\{ \frac{E[X_1 X_j t^S]}{1 - t} \right\}$$

and

$$E[X_1^2 \times 1_{\{S \leq k\}}] = [t^k] \left\{ \frac{E[X_1(X_1 - 1)t^S] + \mathcal{P}_S^{[1]}(t)}{1 - t} \right\}.$$

Finally, one can consider the implications of this method in the continuous case. Letting $\mathcal{L}_{X_1, \dots, X_n}$ denote the multivariate Laplace-Stieltjes transform of the vector (X_1, \dots, X_n) , one can show that

$$-\frac{\partial}{\partial t_1} \mathcal{L}_{X_1, \dots, X_n}(t_1, \dots, t_n) \Big|_{t_1 = \dots = t_n = t},$$

for $t \geq 0$, is the Laplace transform of $E[X_1 \times 1_{\{S=s\}}]$. One could use this formulation to obtain new closed-form expressions for expected allocations, compute expected allocations through numerical inversion of Laplace transforms, or develop asymptotic properties of expected allocations. We note that the Laplace transform of size-biased rvs in the context of continuous rvs is explored in, for instance, [Furman et al., 2020].

A R code for the numerical applications

A.1 Small portfolio of independent compound Poisson rvs

```
n_participants <- 4
kmax <- 2^6
cmax <- 4
lam <- list(0.08, 0.08, 0.1, 0.1)
fc <- list(c(0, 0.1, 0.2, 0.4, 0.3, rep(0, kmax - cmax - 1)),
c(0, 0.15, 0.25, 0.3, 0.3, rep(0, kmax - cmax - 1)),
c(0, 0.1, 0.2, 0.3, 0.4, rep(0, kmax - cmax - 1)),
c(0, 0.15, 0.25, 0.3, 0.3, rep(0, kmax - cmax - 1)))
```

```

dft_fx <- list()
phic <- list()
mu <- list()
conditional_mean <- list()

for(i in 1:n_participants) {
  dft_fx[[i]] <- exp(lam[[i]] * (fft(fc[[i]]) - 1))
  phic[[i]] <- fft(c(1:cmax * fc[[i]][2:(cmax + 1)], rep(0, kmax - cmax)))
}

dft_fs <- Reduce("*", dft_fx)
fs <- Re(fft(dft_fs, inverse = TRUE))/kmax
e1 <- exp(-2i*pi*(0:(kmax-1))/kmax)

for(i in 1:n_participants) {
  dft_mu <- e1 * phic[[i]] * lam[[i]] * dft_fs
  mu[[i]] <- Re(fft(dft_mu, inverse = TRUE))/kmax
  conditional_mean[[i]] <- mu[[i]]/fs
}

sapply(conditional_mean, "[", 2) # Validation
conditional_mean_total <- Reduce("+", conditional_mean)
conditional_mean_total[1 + 1:10] # Validation

```

A.2 Large portfolio of independent compound Poisson rvs

```

set.seed(10112021)
n_participants <- 10000
kmax <- 2^13
lam <- list()
fc <- list()
mu <- list()

lambdas <- rexp(n_participants, 10)
rs <- sample(1:6, n_participants, replace = TRUE)
qs <- runif(n_participants, 0.4, 0.5)

# Assign parameters
for(i in 1:n_participants) {
  lam[[i]] <- lambdas[i]
  fci <- dnbinom(0:(kmax-2), rs[i], qs[i])
  fc[[i]] <- c(fci, 1 - sum(fci))
}

dft_fx <- list()
phic <- list()
cm <- list()

for(i in 1:n_participants) {
  dft_fx[[i]] <- exp(lam[[i]] * (fft(fc[[i]]) - 1))
  phic[[i]] <- fft(c(1:(kmax-1) * fc[[i]][-1], 0))
}

dft_fs <- Reduce("*", dft_fx)
fs <- Re(fft(dft_fs, inverse = TRUE))/kmax
e1 <- exp(-2i*pi*(0:(kmax-1))/kmax)

```

```

for(i in 1:n_participants) {
  dft_mu <- e1 * phic[[i]] * lam[[i]] * dft_fs
  mu[[i]] <- Re(fft(dft_mu, inverse = TRUE))/kmax
  cm[[i]] <- mu[[i]]/fs
}

cm_tot <- Reduce("+", cm)
cm_tot[1 + seq(4000, 5000, 100)] # Validation

```

A.3 Portfolio of heavy-tailed risks

```

library(actuar)
n <- 3

xmax <- 2^15
kmax <- 2^20
alphas <- seq(1.3, 1.9, 0.3)
lambdas <- 10 * (alphas - 1)

phis <- rep(1, kmax)
cm3 <- list()

for(i in 1:n) {
  fx <- discretize(ppareto(x, alphas[i], lambdas[i]), 0, xmax - 1,
  method = "unbiased", lev = levpareto(x, alphas[i], lambdas[i]))
  phix <- fft(c(fx, rep(0, kmax - xmax)))
  phis <- phis * phix
}

fs3 <- Re(fft(phis, inverse = TRUE))/kmax
good_values <- (fs3 >= 0)

for(i in 1:n) {
  fx <- discretize(ppareto(x, alphas[i], lambdas[i]), 0, xmax - 1,
  method = "unbiased", lev = levpareto(x, alphas[i], lambdas[i]))
  phix <- fft(c(fx, rep(0, kmax - xmax)))
  phi_deriv_x1 <- fft(c((1:(xmax - 1)) * fx[-1], rep(0, kmax - xmax + 1)))
  agf <- phis / phix * phi_deriv_x1 * exp(-2i*pi*(0:(kmax-1))/kmax)
  cm3[[i]] <- (Re(fft(agf, inverse = TRUE))/kmax / fs3)[1:xmax]
}

```

A.4 Archimedean copula example

```

set.seed(20220314)
n <- 6
# bi <- sample(1:10, n, replace = TRUE)
bi <- c(1, 3, 10, 4, 5, 10)
qi <- c(0.1, 0.15, 0.2, 0.25, 0.3)

kmax <- sum(bi) + 1
fft1 <- exp(-2i * pi * (0:(kmax - 1))/kmax)

alph <- 0

```

```

eps_theta <- 1e-10
theta_max <- max(2, floor(log(eps_theta)/log(alph)) + 1)
f_theta <- alph**(1:theta_max - 1) * (1 - alph)

LST_inv_geom <- function(u) log((1 - alph)/u + alph)
fft1 <- exp(-2i * pi * (0:(kmax - 1))/kmax)

qi <- runif(n)
ri <- exp(-LST_inv_geom(qi))

fgp_S <- function(s) {
  marginals <- apply(sapply(1:n, function(k) 1 - ri[k]^(1:theta_max) + ri[k]^(1:theta_max) * s^bi[k]
  )), 1, prod)
  sum(f_theta * marginals)
}

fgp_S <- Vectorize(fgp_S)
phis <- fgp_S(fft1)

fs <- (Re(fft(phis, inverse = TRUE))/kmax)

fgp_alloc_i <- function(s, i) {
  marginals <- bi[i] * ri[i]^(1:theta_max) * s^bi[i] * apply(sapply((1:n)[-i], function(k) 1 - ri[k]
  )^(1:theta_max) + ri[k]^(1:theta_max) * s^bi[k]), 1, prod)
  sum(f_theta * marginals)
}

fgp_alloc_i <- Vectorize(fgp_alloc_i)
phi_alloc_1 <- fgp_alloc_i(fft1, 1)
conditional_mean_1 <- (Re(fft(phi_alloc_1, inverse = TRUE))/kmax/fs)
round(conditional_mean_1, 3)
plot(conditional_mean_1, type = 's')

```

References

- [Arratia et al., 2019] Arratia, R., Goldstein, L., and Kochman, F. (2019). Size bias for one and all. *Probability Surveys*, 16:1–61.
- [Axelrod and Kimmel, 2015] Axelrod, D. and Kimmel, M. (2015). *Branching processes in biology*. Springer-Verlag.
- [Bargès et al., 2009] Bargès, M., Cossette, H., and Marceau, E. (2009). TVaR-based capital allocation with copulas. *Insurance: Mathematics and Economics*, 45(3):348–361.
- [Cont et al., 2010] Cont, R., Deguest, R., and Scandolo, G. (2010). Robustness and sensitivity analysis of risk measurement procedures. *Quantitative Finance*, 10(6):593–606.
- [Cooley and Tukey, 1965] Cooley, J. W. and Tukey, J. W. (1965). An algorithm for the machine calculation of complex Fourier series. *Mathematics of computation*, 19(90):297–301.
- [Cormen et al., 2009] Cormen, T. H., Leiserson, C. E., Rivest, R. L., and Stein, C. (2009). *Introduction to Algorithms*. MIT Press.

- [Cossette et al., 2018] Cossette, H., Marceau, E., Mtalai, I., and Veilleux, D. (2018). Dependent risk models with Archimedean copulas: A computational strategy based on common mixtures and applications. *Insurance: Mathematics and Economics*, 78:53–71.
- [Denault, 2001] Denault, M. (2001). Coherent allocation of risk capital. *Journal of risk*, 4:1–34.
- [Denuit, 2019] Denuit, M. (2019). Size-Biased Transform and Conditional Mean Risk Sharing, with Application to P2p Insurance and Tontines. *ASTIN Bulletin: The Journal of the IAA*, 49(3):591–617.
- [Denuit, 2020] Denuit, M. (2020). Size-Biased Risk Measures of Compound Sums. *North American Actuarial Journal*, 24(4):512–532.
- [Denuit and Dhaene, 2012] Denuit, M. and Dhaene, J. (2012). Convex order and comonotonic conditional mean risk sharing. *Insurance: Mathematics and Economics*, 51(2):265–270.
- [Denuit et al., 2006] Denuit, M., Dhaene, J., Goovaerts, M., and Kaas, R. (2006). *Actuarial Theory for Dependent Risks Measures, Orders and Models*. Wiley.
- [Denuit et al., 2022] Denuit, M., Dhaene, J., and Robert, C. Y. (2022). Risk-sharing rules and their properties, with applications to peer-to-peer insurance. *Journal of Risk and Insurance*.
- [Denuit et al., 2021] Denuit, M., Hieber, P., and Robert, C. Y. (2021). Mortality credits within large survivor funds. *ASTIN Bulletin: The Journal of the IAA*, pages 1–22.
- [Denuit and Robert, 2020] Denuit, M. and Robert, C. Y. (2020). Large-loss behavior of conditional mean risk sharing. *ASTIN Bulletin*, 50(3):1093–1122.
- [Denuit and Robert, 2021a] Denuit, M. and Robert, C. Y. (2021a). Conditional Tail Expectation Decomposition and Conditional Mean Risk Sharing for Dependent and Conditionally Independent Losses. *Methodology and Computing in Applied Probability*.
- [Denuit and Robert, 2021b] Denuit, M. and Robert, C. Y. (2021b). From risk sharing to pure premium for a large number of heterogeneous losses. *Insurance: Mathematics and Economics*, 96:116–126.
- [Dickson, 2017] Dickson, D. C. M. (2017). *Insurance Risk and Ruin*. International Series on Actuarial Science. Cambridge University Press, Cambridge, United Kingdom, second edition edition.
- [Embrechts and Frei, 2009] Embrechts, P. and Frei, M. (2009). Panjer recursion versus FFT for compound distributions. *Mathematical Methods of Operations Research*, 69(3):497–508.
- [Embrechts et al., 1993] Embrechts, P., Grübel, R., and Pitts, S. M. (1993). Some applications of the fast Fourier transform algorithm in insurance mathematics This paper is dedicated to Professor W. S. Jewell on the occasion of his 60th birthday. *Statistica Neerlandica*, 47(1):59–75.
- [Embrechts and Hofert, 2013] Embrechts, P. and Hofert, M. (2013). A note on generalized inverses. *Mathematical Methods of Operations Research*, 77(3):423–432.
- [Embrechts et al., 2014] Embrechts, P., Puccetti, G., Rüschendorf, L., Wang, R., and Beleraj, A. (2014). An academic response to basel 3.5. *Risks*, 2(1):25–48.
- [Flajolet and Sedgewick, 2009] Flajolet, P. and Sedgewick, R. (2009). *Analytic combinatorics*. Cambridge University press.

- [Furman, 2007] Furman, E. (2007). On the convolution of the negative binomial random variables. *Statistics & probability letters*, 77(2):169–172.
- [Furman et al., 2020] Furman, E., Hackmann, D., and Kuznetsov, A. (2020). On log-normal convolutions: An analytical–numerical method with applications to economic capital determination. *Insurance: Mathematics and Economics*, 90:120–134.
- [Furman and Landsman, 2005] Furman, E. and Landsman, Z. (2005). Risk capital decomposition for a multivariate dependent gamma portfolio. *Insurance: Mathematics and Economics*, 37(3):635–649.
- [Furman and Landsman, 2006] Furman, E. and Landsman, Z. (2006). Tail Variance Premium with Applications for Elliptical Portfolio of Risks. *ASTIN Bulletin*, 36(2):433–462.
- [Furman and Landsman, 2008] Furman, E. and Landsman, Z. (2008). Economic Capital Allocations for Non-negative Portfolios of Dependent Risks. *ASTIN Bulletin: The Journal of the IAA*, 38(2):601–619.
- [Graham et al., 1994] Graham, R. L., Knuth, D. E., and Patashnik, O. (1994). *Concrete Mathematics: A Foundation for Computer Science*. Addison-Wesley, Reading, Mass, 2nd ed edition.
- [Grimmett and Stirzaker, 2020] Grimmett, G. and Stirzaker, D. (2020). *Probability and Random Processes*. Oxford University Press.
- [Grubel and Hermesmeier, 1999] Grubel, R. and Hermesmeier, R. (1999). Computation of compound distributions i: Aliasing errors and exponential tilting. *ASTIN Bulletin: The Journal of the IAA*, 29(2):197–214.
- [Johnson et al., 1997] Johnson, N. L., Kotz, S., and Balakrishnan, N. (1997). *Discrete Multivariate Distributions*. Wiley Series in Probability and Statistics. Wiley.
- [Johnson et al., 2005] Johnson, N. L., Kotz, S., and Kemp, A. W. (2005). *Univariate discrete distributions*. John Wiley & Sons.
- [Katz, 1965] Katz, L. (1965). Unified treatment of a broad class of discrete probability distributions. *Classical and contagious discrete distributions*, 1:175–182.
- [Klugman et al., 2013] Klugman, S. A., Panjer, H. H., and Willmot, G. E. (2013). *Loss Models: Further Topics*. John Wiley & Sons.
- [Klugman et al., 2018] Klugman, S. A., Panjer, H. H., and Willmot, G. E. (2018). *Loss Models: From Data to Decisions*. Wiley Series in Probability and Statistics. Society of Actuaries ; John Wiley and Sons, Inc, [Schaumburg, IL] : Hoboken, NJ, fifth edition edition.
- [Kocherlakota, 1992] Kocherlakota (1992). *Bivariate Discrete Distributions*. CRC Press.
- [Kocherlakota, 1988] Kocherlakota, S. (1988). On the compounded bivariate Poisson distribution: A unified treatment. *Annals of the Institute of Statistical Mathematics*, 40(1):61–76.
- [Kusuoka, 2001] Kusuoka, S. (2001). On law invariant coherent risk measures. In *Advances in mathematical economics*, pages 83–95. Springer.
- [Lindskog and McNeil, 2003] Lindskog, F. and McNeil, A. J. (2003). Common Poisson shock models: Applications to insurance and credit risk modelling. *ASTIN Bulletin*, 33(2):209–238.

- [Mahamunulu, 1967] Mahamunulu, D. M. (1967). A note on regression in the multivariate Poisson distribution. *Journal of the American Statistical Association*, 62(317):251–258.
- [Marceau, 2013] Marceau, É. (2013). *Modélisation et évaluation quantitative des risques en actuariat*. Springer Paris, Paris.
- [Marshall and Olkin, 1988] Marshall, A. W. and Olkin, I. (1988). Families of Multivariate Distributions. *Journal of the American Statistical Association*, 83(403):834–841.
- [Mathai and Moschopoulos, 1991] Mathai, A. M. and Moschopoulos, P. G. (1991). On a multivariate gamma. *Journal of Multivariate Analysis*, 39(1):135–153.
- [McNeil et al., 2015] McNeil, A. J., Frey, R., and Embrechts, P. (2015). *Quantitative Risk Management: Concepts, Techniques and Tools*. Princeton Series in Finance. Princeton University Press, Princeton, NJ, revised edition.
- [Muller and Stoyan, 2002] Muller, A. and Stoyan, D. (2002). *Comparison Methods for Stochastic Models and Risks*, volume 389. Wiley.
- [Panjer, 1981] Panjer, H. H. (1981). Recursive evaluation of a family of compound distributions. *ASTIN Bulletin*, 12(1):22–26.
- [Panjer and Willmot, 1992] Panjer, H. H. and Willmot, G. E. (1992). *Insurance Risk Models*. Society of Actuaries.
- [Ren and Zitikis, 2017] Ren, J. and Zitikis, R. (2017). CMPH: A multivariate phase-type aggregate loss distribution. *Dependence Modeling*, 5(1):304–315.
- [Sedgewick and Flajolet, 2013] Sedgewick, R. and Flajolet, P. (2013). *An Introduction to the Analysis of Algorithms*. Addison-Wesley, Upper Saddle River, NJ, 2nd ed edition.
- [Subrahmaniam, 1966] Subrahmaniam, K. (1966). A Test for "Intrinsic Correlation" in the Theory of Accident Proneness. *Journal of the Royal Statistical Society. Series B (Methodological)*, 28(1):180–189.
- [Tasche, 1999] Tasche, D. (1999). Risk contributions and performance measurement. *Report of the Lehrstuhl für mathematische Statistik, TU München*.
- [Tasche, 2007] Tasche, D. (2007). Capital allocation to business units and sub-portfolios: the Euler principle. *arXiv preprint arXiv:0708.2542*.
- [Teicher, 1954] Teicher, H. (1954). On the multivariate Poisson distribution. *Scandinavian Actuarial Journal*, 1954(1):1–9.
- [Wang, 1996] Wang, S. (1996). Premium calculation by transforming the layer premium density. *ASTIN Bulletin: The Journal of the IAA*, 26(1):71–92.
- [Wang, 1998] Wang, S. S. (1998). Aggregation of correlated risk portfolios: Models and algorithms. *Proceedings of the Casualty Actuarial Society*, page 92.
- [Wilf, 2006] Wilf, H. S. (2006). *Generatingfunctionology*. A K Peters, Wellesley, Mass, 3rd ed edition.

- [Winkelmann, 2008] Winkelmann, R. (2008). *Econometric analysis of count data*. Springer Science & Business Media.
- [Yaari, 1987] Yaari, M. E. (1987). The dual theory of choice under risk. *Econometrica: Journal of the Econometric Society*, pages 95–115.
- [Zhang et al., 2018] Zhang, M., Hong, Y., and Balakrishnan, N. (2018). The generalized Poisson-binomial distribution and the computation of its distribution function. *Journal of Statistical Computation and Simulation*, 88(8):1515–1527.