

Homological Knot Invariants from Mirror Symmetry

Mina Aganagic

Abstract

In 1999, Khovanov showed that a link invariant known as the Jones polynomial is the Euler characteristic of a homology theory. The knot categorification problem is to find a general construction of knot homology groups, and to explain their meaning – what are they homologies of?

Homological mirror symmetry, formulated by Kontsevich in 1994, naturally produces hosts of homological invariants. Typically though, it leads to invariants which have no particular interest outside of the problem at hand.

I showed recently that there is a new family of mirror pairs of manifolds, for which homological mirror symmetry does lead to interesting invariants and solves the knot categorification problem. The resulting invariants are computable explicitly for any simple Lie algebra, and certain Lie superalgebras.

1. Introduction

There are many beautiful strands that connect mathematics and physics. Two of the most fruitful ones are knot theory and mirror symmetry. I will describe a new connection between them. We will find a solution to the knot categorification problem as a new application of homological mirror symmetry.

1.1. Quantum link invariants

In 1984, Jones constructed a polynomial invariant of links in \mathbb{R}^3 [42]. The Jones polynomial is defined by picking a projection of the link to a plane, the skein relation it satisfies

$$q^{n/2}P_{\nearrow\searrow} - q^{-n/2}P_{\searrow\nearrow} = (q^{1/2} - q^{-1/2})P_{\gamma\tau}$$

where $n=2$, and the value for the unknot. It has the same flavor as the Alexander polynomial, dating back to 1928 [8], which one gets by setting $n=0$ instead.

The proper framework for these invariants was provided by Witten in 1988, who showed that they originate from three-dimensional Chern–Simons theory based on a Lie algebra ${}^L\mathfrak{g}$ [82]. In particular, the Jones polynomial comes from ${}^L\mathfrak{g} = \mathfrak{su}_2$ with links colored by the defining two-dimensional representation. The Alexander polynomial comes from the same setting by taking ${}^L\mathfrak{g}$ to be a Lie superalgebra $\mathfrak{gl}_{1|1}$. The resulting link invariants are known as the $U_q({}^L\mathfrak{g})$ quantum group invariants. The relation to quantum groups was discovered by Reshetikhin and Turaev [67].

1.2. The knot categorification problem

The quantum invariants of links are Laurent polynomials in $q^{1/2}$, with integer coefficients. In 1999, Khovanov showed [48, 49] that one can associate to a projection of the link to a plane a bigraded complex of vector spaces

$$C^{*,j}(K) = \dots C^{i-1,j}(K) \xrightarrow{\partial^{i-1}} C^{i,j}(K) \xrightarrow{\partial^i} \dots,$$

whose cohomology $\mathcal{H}^{i,j}(K) = \ker \partial^i / \text{im } \partial^{i-1}$ categorifies the Jones polynomial,

$$J_K(q) = \sum_{i,j} (-1)^i q^{j/2} \text{rk } \mathcal{H}^{i,j}(K).$$

Moreover, the cohomology groups

$$\mathcal{H}^{*,*}(K) = \bigoplus_{i,j} \mathcal{H}^{i,j}(K)$$

are independent of the choice of projection; they are themselves link invariants.

1.2.1.

Khovanov's construction is part of the categorification program initiated by Crane and Frenkel [25], which aims to lift integers to vector spaces and vector spaces to categories. A toy model of categorification comes from a Riemannian manifold M , whose Euler

characteristic

$$\chi(M) = \sum_{k \in \mathbb{Z}} (-1)^k \dim \mathcal{H}^k(M)$$

is categorified by the cohomology $\mathcal{H}^k(M) = \ker d_k / \text{im } d_{k-1}$ of the de Rham complex

$$C^* = \dots C^{k-1} \xrightarrow{d_{k-1}} C^k \xrightarrow{d_k} \dots$$

The Euler characteristic is, from the physics perspective, the partition function of supersymmetric quantum mechanics with M as a target space $\chi(M) = \text{Tr}(-1)^F e^{-\beta H}$, with Laplacian $H = dd^* + d^*d$ as the Hamiltonian, and $d = \sum_k d_k$ as the supersymmetry operator. If h is a Morse function on M , the complex can be replaced by a Morse–Smale–Witten complex C_h^* with the differential $d_h = e^h d e^{-h}$. The complex C_h^* is the space of perturbative ground states of a σ -model on M with potential h [81]. The action of the differential d_h is generated by solutions to flow equations, called instantons.

1.2.2.

Khovanov’s remarkable categorification of the Jones polynomial is explicit and easily computable. It has generalizations of similar flavor for ${}^L\mathfrak{g} = \mathfrak{su}_n$, and links colored by its minuscule representations [51].

In 2013, Webster showed [78] that for any ${}^L\mathfrak{g}$, there exists an algebraic framework for categorification of $U_q({}^L\mathfrak{g})$ invariants of links in \mathbb{R}^3 , based on a derived category of modules of an associative algebra. The KLRW algebra, defined in [78], generalizes the algebras of Khovanov and Lauda [50] and Rouquier [68]. Unlike Khovanov’s construction, Webster’s categorification is anything but explicit.

1.2.3.

Despite the successes of the program, one is missing a fundamental principle which explains why is categorification possible – the construction has no right to exist. Unlike in our toy example of categorification of the Euler characteristic of a Riemannian manifold, Khovanov’s construction and its generalizations did not come from either geometry or physics in any unified way. The problem Khovanov initiated is to find a general framework for link homology, that works uniformly for all Lie algebras, explains what link homology groups are, and why they exist.

1.3. Homological invariants from mirror symmetry

The solution to the problem comes from a new relation between mirror symmetry and representation theory.

Homological mirror symmetry relates pairs of categories of geometric origin [55]: a derived category of coherent sheaves and a version of the derived Fukaya category, in which complementary aspects of the theory are simple to understand. Occasionally, one can make mirror symmetry manifest, by showing that both categories are equivalent to a derived category of modules of a single algebra.

I will describe a new family of mirror pairs, in which homological mirror symmetry can be made manifest and leads to the solution to the knot categorification problem [1,2]. Many special features exist in this family, in part due to its deep connections to representation theory. As a result, the theory is solvable explicitly, as opposed to only formally [4,5].

1.4. The solution

We will get not one, but two solutions to the knot categorification problem. The first solution [1] is based on \mathcal{D}_X , the derived category of equivariant coherent sheaves on a certain holomorphic symplectic manifold X , which plays a role in the geometric Langlands correspondence. Recently, Webster proved that \mathcal{D}_X is equivalent to $\mathcal{D}_{\mathcal{A}}$, the derived category of modules of an algebra \mathcal{A} which is a cylindrical version of the KLRW algebra from [79,80]. The generalization allows the theory to describe links in $\mathbb{R}^2 \times S^1$, as well as in \mathbb{R}^3 .

The second solution [2] is based on \mathcal{D}_Y , the derived Fukaya–Seidel category of a certain manifold Y with potential W . The theory generalizes Heegard–Floer theory [63,64,66], which categorifies the Alexander polynomial, from $L\mathfrak{g} = \mathfrak{gl}_{1|1}$, to arbitrary $L\mathfrak{g}$.

The two solutions are related by equivariant homological mirror symmetry, which is not an equivalence of categories, but a correspondence of objects and morphisms coming from a pair of adjoint functors. In \mathcal{D}_X , we will learn which question we need to ask to obtain $U_q(L\mathfrak{g})$ link homology. In \mathcal{D}_Y , we will learn how to answer it.

In [5], we give an explicit algorithm for computing homological link invariants from \mathcal{D}_Y , for any simple Lie algebra $L\mathfrak{g}$ and links colored by its minuscule representations. It has an extension to Lie superalgebras $L\mathfrak{g} = \mathfrak{gl}_{m|n}$ and $\mathfrak{sp}_{m|2n}$. In [4], we set the mathematical foundations of \mathcal{D}_Y and prove (equivariant) homological mirror symmetry relating it to \mathcal{D}_X .

2. Knot invariants and conformal field theory

Most approaches to categorification of $U_q(L\mathfrak{g})$ link invariants start with quantum groups and their modules. We will start by recalling how quantum groups came into the story. The seeming detour will help us understand how $U_q(L\mathfrak{g})$ link invariants arise from geometry, and what categorifies them.

2.1. Knizhnik–Zamolodchikov equation and quantum groups

Chern–Simons theory associates to a punctured Riemann surface \mathcal{A} a vector space, its Hilbert space. As Witten showed [82], the Hilbert space is finite dimensional, and spanned by vectors that have a name. They are known as conformal blocks of the affine Lie algebra $L\mathfrak{g}_\kappa$. The effective level κ is an arbitrary complex number, related to \mathfrak{q} by $\mathfrak{q} = e^{\frac{2\pi i}{\kappa}}$. While in principle arbitrary representations of $L\mathfrak{g}$ can occur, in relating to geometry and categorification, we will take them to be minuscule.

To get invariants of knots in \mathbb{R}^3 , one typically takes \mathcal{A} to be a complex plane with punctures. It is equivalent, but for our purposes better, to take \mathcal{A} to be an infinite complex cylinder. This way, we will be able to describe invariants of links in $\mathbb{R}^2 \times S^1$, as well.

2.1.1.

Every conformal block, and hence every state in the Hilbert space, can be obtained explicitly as a solution to a linear differential equation discovered by Knizhnik and Zamolodchikov in 1984 [53]. The KZ equation we get is of trigonometric type, schematically

$$(2.1) \quad \kappa \partial_i \mathcal{V} = \sum_{j \neq i} r_{ij}(a_i/a_j) \mathcal{V},$$

since \mathcal{A} is an infinite cylinder. Here, $\partial_i = a_i \frac{\partial}{\partial a_i}$, where a_i is any of the n punctures in the interior of \mathcal{A} , colored by a representation V_i of ${}^L\mathfrak{g}$. The right hand side of (2.1) is given in terms of classical r -matrices of ${}^L\mathfrak{g}$, and acts irreducibly on a subspace of $V_1 \otimes \cdots \otimes V_n$ of a fixed weight ν , where \mathcal{V} takes values [32, 33].

The KZ equations define a flat connection on a vector bundle over the configuration space of distinct points $a_1, \dots, a_n \in \mathcal{A}$. The flatness of the connection is the integrability condition for the equation.

2.1.2.

The monodromy problem of the KZ equation, which is to describe analytic continuation of its fundamental solution along a path in the configuration space, has an explicit solution. Drinfeld [30] and Kazhdan and Lusztig [47] proved that the monodromy matrix \mathfrak{B} of the KZ connection is a product of R -matrices of the $U_q({}^L\mathfrak{g})$ quantum group corresponding to ${}^L\mathfrak{g}$. The R -matrices describe reorderings of neighboring pairs of punctures.

The monodromy matrix \mathfrak{B} is the Chern–Simons path integral on $\mathcal{A} \times [0, 1]$ in presence of a colored braid. By composing braids, we get a representation of the affine braid group based on the $U_q({}^L\mathfrak{g})$ quantum group, acting on the space of solutions to the KZ equation. The braid group is affine, since \mathcal{A} is a cylinder and not a plane.

2.1.3.

Any link can be represented as a plat closure of some braid. The Chern-Simons path integral together with the link computes a very specific matrix element of the braiding

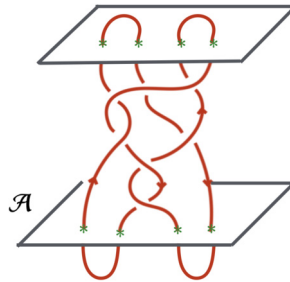

Figure 1 Every link arises as a plat closure of a braid.

matrix \mathfrak{B} , picked out by a pair of states in the Hilbert space corresponding to the top and the bottom of Figure 1.

These states, describing a collection of cups and caps, are very special solutions of the KZ equation in which pairs of punctures, colored by conjugate representations V_i and V_i^* , come together and fuse to disappear. In this way, both fusion and braiding enter the problem.

2.2. A categorification wishlist

To categorify $U_q(\mathcal{L}\mathfrak{g})$ invariants of links in \mathbb{R}^3 , we would like to associate, to the space of conformal blocks of $\widehat{\mathcal{L}\mathfrak{g}}$ on the Riemann surface \mathcal{A} , a bigraded category, which in addition to the cohomological grading has a grading associated to \mathfrak{q} . Additional $\text{rk}(\mathcal{L}\mathfrak{g})$ gradings are needed to categorify invariants of links in $\mathbb{R}^2 \times S^1$, as they depend on the choice of a flat $\mathcal{L}\mathfrak{g}$ connection around the S^1 . To braids, we would like to associate functors between the categories corresponding to the top and bottom. To links, we would like to associate a vector space whose elements are morphisms between the objects of the categories associated to the top and bottom, up to the action of the braiding functor. Moreover, we would like to do this in a way that recovers quantum link invariants upon decategorification. One typically proceeds by coming up with a category, and then works to prove that decategorification gives the link invariants one set out to categorify. A virtue of the solutions in [1,2] is that the second step is automatic.

3. Mirror symmetry

Mirror symmetry is a string duality which relates σ -models on a pair of Calabi–Yau manifolds \mathcal{X} and \mathcal{Y} . Its mathematical imprint are relations between very different problems in complex geometry of \mathcal{X} (“B-type”) and symplectic geometry of \mathcal{Y} (“A-type”), and vice versa.

Mirror symmetry was discovered as a duality of σ -models on closed Riemann surfaces D . In string theory, one must allow Riemann surfaces with boundaries. This enriches the theory by introducing “branes,” which are boundary conditions at ∂D and naturally objects of a category [9].

By asking how mirror symmetry acts on branes turned out to yield deep insights into mirror symmetry. One such insight is due to Strominger, Yau, and Zaslov [75], who showed that in order for every point-like brane on \mathcal{X} to have a mirror on \mathcal{Y} , mirror manifolds have to be fibered by a pair of (special Lagrangian) dual tori T and T^\vee , over a common base.

3.1. Homological mirror symmetry

Kontsevich conjectured in his 1994 ICM address [55] that mirror symmetry should be understood as an equivalence of a pair of categories of branes, one associated to complex geometry of \mathcal{X} , the other to symplectic geometry of \mathcal{Y} .

The category of branes associated to complex geometry of \mathcal{X} is the derived category of coherent sheaves,

$$\mathcal{D}_{\mathcal{X}} = D^b \text{Coh}_T(\mathcal{X}).$$

Its objects are ‘‘B-type branes,’’ supported on complex submanifolds of \mathcal{X} . The category of branes associated to symplectic geometry is the derived Fukaya category

$$\mathcal{D}_{\mathcal{Y}} = \text{DFuk}(\mathcal{Y}),$$

whose objects are ‘‘A-type branes,’’ supported on Lagrangian submanifolds of \mathcal{Y} , together with a choice of orientation and a flat bundle. For example, mirror symmetry should map the structure sheaf of a point in \mathcal{X} to a Lagrangian brane in \mathcal{Y} supported on a T^\vee fiber. The choice of a flat $U(1)$ connection is the position of the point in the dual fiber T .

Kontsevich’ homological mirror symmetry is a conjecture that the category of B-branes on \mathcal{X} and the category of A-branes on \mathcal{Y} are equivalent,

$$\mathcal{D}_{\mathcal{X}} \cong \mathcal{D}_{\mathcal{Y}},$$

and that this equivalence characterizes what mirror symmetry is.

3.2. Quantum differential equation and its monodromy

Knizhnik–Zamolodchikov equation, which plays a central role in knot theory, has a geometric counterpart. In the world of mirror symmetry, there is an equally fundamental differential equation,

$$(3.1) \quad \partial_i \mathcal{V}_\alpha - (C_i)_\alpha^\beta \mathcal{V}_\beta = 0.$$

The equation is known as the quantum differential equation of \mathcal{X} . Both the equation and its monodromy problem featured prominently, starting with the first papers on mirror symmetry, see [37] for an early account. In (3.1), $(C_i)_\alpha^\beta = C_{\gamma_i \alpha \delta} \eta^{\delta \beta}$ is a connection on a vector bundle with fibers $H^{\text{even}}(\mathcal{X}) = \bigoplus_k H^k(\mathcal{X}, \wedge^k T_{\mathcal{X}}^*)$ over the complexified Kahler moduli space. The derivative stands for $\partial_i = a_i \frac{\partial}{\partial a_i}$, so that $\partial_i a^d = (\gamma_i, d) a^d$ for a curve of degree $d \in H_2(\mathcal{X})$. The connection comes from quantum multiplication with classes $\gamma_i \in H^2(\mathcal{X})$. Given three de Rham cohomology classes on \mathcal{X} , their quantum product

$$(3.2) \quad C_{\alpha\beta\gamma} = \sum_{d \geq 0, d \in H_2(\mathcal{X})} (\alpha, \beta, \gamma)_d a^d$$

is a deformation of the classical cup product $(\alpha, \beta, \gamma)_0 = \int_{\mathcal{X}} \alpha \wedge \beta \wedge \gamma$ coming from Gromov–Witten theory of \mathcal{X} : $(\alpha, \beta, \gamma)_d$ is computed by an integral over the moduli space of degree d holomorphic maps from $D = \mathbb{P}^1$ to \mathcal{X} whose image meets classes Poincaré dual of α, β and γ at points. The quantum product, together with the invariant inner product $\eta_{\alpha\beta} = \int_{\mathcal{X}} \alpha \wedge \beta$, gives rise to an associative algebra with structure constants $C_{\alpha\beta}{}^\delta = C_{\alpha\beta\gamma} \eta^{\gamma\delta}$. Flatness of the connection follows from the WDVV equations [27, 31, 83].

From the mirror perspective of \mathcal{Y} , the connection is the classical Gauss–Manin connection on the vector bundle over the moduli space of complex structures on \mathcal{Y} , with fibers the mid-dimensional cohomology $H^d(\mathcal{Y})$ as mirror symmetry identifies $H^k(\mathcal{X}, \wedge^k T_{\mathcal{X}}^*)$ with $H^k(\mathcal{Y}, \wedge^{d-k} T_{\mathcal{Y}}^*)$.

3.2.1.

Solutions to the equation live in a vector space, spanned by K-theory classes of branes [22,36,41,46]. These are B-type branes on \mathcal{X} , objects of $\mathcal{D}_{\mathcal{X}}$, and A-type branes on \mathcal{Y} , objects of $\mathcal{D}_{\mathcal{Y}}$. A characteristic feature is that the equation and its solutions mix the A- and B-type structures on the same manifold.

From the perspective of \mathcal{X} , the solutions of the quantum differential equation come from Gromov–Witten theory. They are obtained by counting holomorphic maps from a domain curve D to X , where D is best thought of as an infinite cigar [39,40] together with insertions of a class in $\alpha \in H_{\text{even}}^*(X)$ at the origin, and $[\mathcal{F}] \in K(X)$ at infinity. The latter is the K-theory class of a B-type brane $\mathcal{F} \in \mathcal{D}_{\mathcal{X}}$ which serves as the boundary condition at the S^1 boundary at infinity of D . In the mirror \mathcal{Y} , the A- and B-type structures get exchanged. In the interior of D , supersymmetry is preserved by B-type twist, and at the boundary at infinity we place an A-type brane $\mathcal{L} \in \mathcal{D}_{\mathcal{Y}}$, whose K-theory class picks which solution of the equation we get.

3.2.2.

One of the key mirror symmetry predictions is that monodromy of the quantum differential equation gets categorified by the action of derived autoequivalences of $\mathcal{D}_{\mathcal{X}}$. It is related by mirror symmetry to the monodromy of the Gauss–Manin connection, computed by Picard–Lefschetz theory, whose categorification by $\mathcal{D}_{\mathcal{Y}}$ is developed by Seidel [71].

The flat section \mathcal{V} of the connection in (3.1) has a close cousin. This is Douglas’ [9,28,29] Π -stability central charge function $\mathcal{Z}^0 : K(\mathcal{D}) \rightarrow \mathbb{C}$, whose existence motivated Bridgeland’s formulation of stability conditions [17]. The Π -stability central charge \mathcal{Z}^0 arises from the same setting as \mathcal{V} , except one places trivial insertions at the origin of D . This implies that monodromies of \mathcal{V} and \mathcal{Z}^0 coincide [22]. In the context of the mirror \mathcal{Y} , given any brane $\mathcal{L} \in \mathcal{D}_{\mathcal{Y}}$, its central charge is simply $\mathcal{Z}^0[\mathcal{L}] = \int_{\mathcal{L}} \Omega$, where Ω is the top holomorphic form on \mathcal{Y} . The stable objects are special Lagrangians, on which the phase of Ω is constant. By mirror symmetry, monodromy of \mathcal{Z}^0 is expected to induce the action of monodromy on $\mathcal{D}_{\mathcal{X}}$. Examples of braid group actions on the derived categories include works of Khovanov and Seidel [52], Seidel and Thomas [74], and others [18,77].

4. Homological link invariants from B-branes

The Knizhnik–Zamolodchikov equation not only has the same flavor as the quantum differential equation, but for some very special choices of X , they coincide. For the time being, we will take ${}^L\mathfrak{g}$ to be simply laced, so it coincides with its Langlands dual \mathfrak{g} .

4.1. The geometry

The manifold X may be described as the moduli space of G -monopoles on

$$(4.1) \quad \mathbb{R}^3 = \mathbb{R} \times \mathbb{C},$$

with prescribed singularities. The monopole group G is related to ${}^L G$, the Chern–Simons gauge group, by Langlands or electric–magnetic duality. In Chern–Simons theory, the knots are labeled by representations of ${}^L G$ and viewed as paths of heavy particles, charged electrically under ${}^L G$. In the geometric description, the same heavy particles appear as singular, Dirac-type monopoles of the Langlands dual group G . The fact the magnetic description is what is needed to understand categorification was anticipated by Witten [84–87].

4.1.1.

Place a singular G monopole for every finite puncture on $\mathcal{A} \cong \mathbb{R} \times S^1$, at the point on \mathbb{R} obtained by forgetting the S^1 . Singular monopole charges are elements of the cocharacter lattice of G , which Langlands duality identifies with the character lattice of ${}^L G$. Pick the charge of the monopole to be the highest weight μ_i of the ${}^L G$ representation V_i coloring the puncture. The relative positions of singular monopoles on \mathbb{R}^3 are the moduli of the metric on \mathcal{X} , so we will hold them fixed.

The smooth monopole charge is a positive root of ${}^L G$; choose it so that the total monopole charge is the weight ν of subspace of representation $\bigotimes_i V_i$, where the conformal blocks take values. For our current purpose, it suffices to assume

$$(4.2) \quad \nu = \sum_i \mu_i - \sum_{a=1}^{rk} d_a {}^L e_a,$$

is a dominant weight; ${}^L e_a$ are the simple positive roots of ${}^L \mathfrak{g}$. Provided μ_i are minuscule co-weights of G and no pairs of singular monopoles coincide, the monopole moduli space \mathcal{X} is a smooth hyper-Kähler manifold of dimension

$$\dim_{\mathbb{C}}(\mathcal{X}) = 2 \sum_a d_a.$$

It is parameterized, in part, by positions of smooth monopoles on \mathbb{R}^3 .

4.1.2.

A choice of complex structure on \mathcal{X} reflects a split of \mathbb{R}^3 as $\mathbb{R} \times \mathbb{C}$. The relative positions of singular monopoles on \mathbb{C} become the complex structure moduli, and the relative positions of monopoles on \mathbb{R} the Kahler moduli.

This identifies the complexified Kahler moduli space of \mathcal{X} (where the Kahler form gets complexified by a periodic two-form) with the configuration space of n distinct punctures on $\mathcal{A} = \mathbb{R} \times S^1$, modulo overall translations, as in Figure 2.



Figure 2 Punctures on \mathcal{A} correspond to singular G -monopoles on $\mathbb{R} \in \mathbb{R} \times \mathbb{C}$.

4.1.3.

As a hyper-Kähler manifold, \mathcal{X} has more symmetries than a typical Calabi–Yau. For its quantum cohomology to be nontrivial, and for the quantum differential equation to coincide with the KZ equation, we need to work equivariantly with respect to a torus action that scales its holomorphic symplectic form

$$\omega^{2,0} \rightarrow \mathfrak{q} \omega^{2,0}.$$

For this to be a symmetry, we will place all the singular monopoles at the origin of \mathbb{C} ; \mathcal{X} has a larger torus of symmetries

$$T = \Lambda \times \mathbb{C}_{\mathfrak{q}}^{\times},$$

where Λ preserves the holomorphic symplectic form, and comes from the Cartan torus of G . The equivariant parameters of the Λ -action correspond to the choice of a flat ${}^L G$ connection of Chern–Simons theory on $\mathbb{R}^2 \times S^1$.

4.1.4.

The same manifold \mathcal{X} has appeared in mathematics before, as a resolution of a transversal slice in the affine Grassmannian $\mathrm{Gr}_G = G((z))/G[[z]]$ of G , often denoted by

$$(4.3) \quad \mathcal{X} = \mathrm{Gr}_{\vec{\mu}, \nu}.$$

The two are related by thinking of monopole moduli space \mathcal{X} as obtained by a sequence of Hecke modifications of holomorphic G -bundles on \mathbb{C} [45].

Manifold \mathcal{X} is also the Coulomb branch of a 3d quiver gauge theory with $\mathcal{N} = 4$ supersymmetry, with quiver based on the Dynkin diagram of \mathfrak{g} , see e.g. [19]. The ranks of the flavor and gauge symmetry groups are determined from the weights μ and ν .

4.1.5.

The vector $\vec{\mu} = (\mu_1, \dots, \mu_n)$ in (4.3) encodes singular monopole charges, and the order in which they appear on \mathbb{R} , and ν is the total monopole charge. The ordering of entries of $\vec{\mu}$ is a choice of a chamber in the Kähler moduli. We will suppress $\vec{\mu}$ for the most part, and denote all the corresponding distinct symplectic manifolds by \mathcal{X} .

4.1.6.

By a recent theorem of Danilenko [26], the Knizhnik–Zamolodchikov equation corresponding to the Riemann surface $\mathcal{A} = \mathbb{R} \times S^1$, with punctures colored by minuscule representations V_i of ${}^L \mathfrak{g}$, coincides with the quantum differential equation of the T -equivariant Gromov–Witten theory on $\mathcal{X} = \mathrm{Gr}_{\vec{\mu}, \nu}$.

This has many deep consequences.

4.2. Branes and braiding

Since the KZ equation is the quantum-differential equation of T -equivariant Gromov–Witten theory of \mathcal{X} , the space of its solutions gets identified with $K_T(\mathcal{X})$, the T -equivariant K -theory of \mathcal{X} .

This is the K -group of the category of its B-type branes, the derived category of T -equivariant coherent sheaves on \mathcal{X} ,

$$\mathcal{D}_{\mathcal{X}} = D^b \text{Coh}_T(\mathcal{X}).$$

This connection between the KZ equation and $\mathcal{D}_{\mathcal{X}}$ is the starting point for our first solution of the categorification problem.

4.2.1.

A colored braid with n strands in $\mathcal{A} \times [0, 1]$ has a geometric interpretation as a path in the complexified Kahler moduli of \mathcal{X} that avoids singularities, as the order of punctures on \mathcal{A} corresponds to a choice of chamber in the Kahler moduli of \mathcal{X} .

The monodromy of the quantum differential equation along this path acts on $K_T(\mathcal{X})$. Since the quantum differential equation coincides with the KZ equation, by the theorem of [26], $K_T(\mathcal{X})$ becomes a module for $U_q(\mathfrak{L}\mathfrak{g})$, corresponding to the weight ν subspace of representation $V_1 \otimes \cdots \otimes V_n$.

The fact that derived equivalences of $\mathcal{D}_{\mathcal{X}}$ categorify this action is not only an expectation, but also a theorem by Bezrukavnikov and Okounkov [14], whose proof makes use of quantization of \mathcal{X} in characteristic p .

4.2.2.

From physics perspective, the reason derived equivalences of $\mathcal{D}_{\mathcal{X}}$ had to categorify the action of monodromy of the quantum differential equation on $K_T(\mathcal{X})$ is as follows.

Braid group acts, in the σ -model on the cigar D from Section 3.2.1, by letting the moduli of \mathcal{X} vary according to the braid near the boundary at infinity. The Euclidean time, running along the cigar, is identified with the time along the braid. This leads to a Berry phase-type problem studied by Cecotti and Vafa [22]. It follows that the σ -model on the annulus, with moduli that vary according to the braid, computes the matrix element of the monodromy \mathfrak{B} , picked out by a pair of branes \mathcal{F}_0 and \mathcal{F}_1 at its boundaries.

The σ -model on the same Euclidian annulus, where we take the time to run around S^1 instead, computes the index of the supercharge Q preserved by the two branes. The cohomology of Q is computed by $\mathcal{D}_{\mathcal{X}}$ as its most basic ingredient, the space of morphisms

$$\text{Hom}_{\mathcal{D}_{\mathcal{X}}}^{**}(\mathcal{B}\mathcal{F}_0, \mathcal{F}_1)$$

between the branes. This is the space of supersymmetric ground states of the σ -model on a strip, obtained by cutting the annulus open. We took here all the variations of moduli to happen near one boundary, at the expense of changing a boundary condition from \mathcal{F}_0 to $\mathcal{B}\mathcal{F}_0$. This does not affect the homology [1, 35], for the very same reason the theory depends on the homotopy type of the braid only. Per construction, the graded Euler characteristic of the homology theory, computed by closing the strip back up to the annulus, is the braiding matrix element,

$$(4.4) \quad \chi(\mathcal{B}\mathcal{F}_0, \mathcal{F}_1) = (\mathfrak{B}\mathcal{V}_0, \mathcal{V}_1),$$

between the conformal blocks $\mathcal{V}_{0,1} = \mathcal{V}[\mathcal{F}_{0,1}]$ of the two branes.

Thus, by viewing the same Euclidian annulus in two different ways, we learn that the braid group action on the derived category

$$(4.5) \quad \mathcal{B} : \mathcal{D}_{\mathcal{X}_{\bar{\mu}}} \rightarrow \mathcal{D}_{\mathcal{X}_{\bar{\mu}'}}$$

manifestly categorifies the monodromy matrix $\mathfrak{B} \in U_{\mathfrak{q}}(L\mathfrak{g})$ of the KZ equation.

4.3. Link invariants from perverse equivalences

The quantum $U_{\mathfrak{q}}(L\mathfrak{g})$ invariants of knots and links are matrix elements of the braiding matrix \mathfrak{B} , so they too will be categorified by $\mathcal{D}_{\mathcal{X}}$, provided we can identify objects $\mathcal{U} \in \mathcal{D}_{\mathcal{X}}$ which serve as cups and caps.

Conformal blocks corresponding to cups and caps are defined using fusion [62]. The geometric analogue of fusion, in terms of \mathcal{X} and its category of branes, was shown in [1] to be the existence of certain perverse filtrations on $\mathcal{D}_{\mathcal{X}}$, defined by abstractly by Chuang and Rouquier [24]. The utility of perverse filtrations for understanding the action of braiding on $\mathcal{D}_{\mathcal{X}}$ parallels the utility of fusion in describing the action of braiding in conformal field theory. In particular, it leads to identification of the cup and cap branes \mathcal{U} we need, and a simple proof that $\text{Hom}_{\mathcal{D}_{\mathcal{X}}}^{*,*}(\mathcal{B}\mathcal{U}, \mathcal{U})$ are homological invariants of links [1].

4.3.1.

As we bring a pair of punctures at a_i and a_j on \mathcal{A} together, we get a new natural basis of solutions to the KZ equation, called the fusion basis, whose virtue is that it diagonalizes braiding. The possible eigenvectors are labeled by the representations

$$(4.6) \quad V_i \otimes V_j = \bigoplus_{m=0}^{m_{\max}} V_{k_m},$$

that occur in the tensor product of representations V_i and V_j labeling the punctures. Because V_i and V_j are minuscule representations, the nonzero multiplicities on the right-hand side are all equal to 1. The cap arises as a special case, obtained by starting with a pair of conjugate representations V_i and V_i^* , and picking the trivial representation in their tensor product.

4.3.2.

From perspective of \mathcal{X} , a pair of singular monopoles of charges μ_i and μ_j are coming together on \mathbb{R} , as in Figure 2, and we approach a wall in Kahler moduli at which \mathcal{X} develops a singularity. At the singularity, a collection of cycles vanishes. This is due to monopole bubbling phenomena described by Kapustin and Witten in [45].

The types of monopole bubbling that can occur are labeled by representations V_{k_m} that occur in the tensor product $V_i \otimes V_j$. The moduli space of monopoles whose positions we need to tune for the bubbling of type V_{k_m} to occur is $\text{Gr}_{\mu_{k_m}}^{(\mu_i, \mu_j)} = T^*F_{k_m}$, where μ_{k_m} is the highest weight of V_{k_m} . This space is transverse to the locus where exactly $\mu_i + \mu_j - \mu_{k_m}$ monopoles have bubbled off [1]. It has a vanishing cycle F_{k_m} , corresponding to the representation V_{k_m} , as its zero section. (Viewing \mathcal{X} as the Coulomb branch, monopole bubbling is related to partial Higgsing phenomena.)

4.3.3.

Conformal blocks which diagonalize the action of braiding do not in general come from actual objects of the derived category \mathcal{D}_X . As is well known from Picard–Lefschetz theory, eigensheaves of braiding, branes on which the braiding acts only by degree shifts $\mathcal{BE} = \mathcal{E}[D_{\mathcal{E}}]\{C_{\mathcal{E}}\}$, are very rare.

What one gets instead [1] is a filtration

$$(4.7) \quad \mathcal{D}_{k_0} \subset \mathcal{D}_{k_1} \subset \cdots \subset \mathcal{D}_{k_{\max}} = \mathcal{D}_X,$$

by the order of vanishing of the Π -stability central charge $\mathcal{Z}^0 : K(X) \rightarrow \mathbb{C}$. More precisely, one gets a pair of such filtrations, one on each side of the wall. Crossing the wall preserves the filtration, but has the effect of mixing up branes at a given order in the filtration, with those at lower orders, whose central charge vanishes faster. Because X is hyper-Kähler, the Π -stability central charge is given in terms of classical geometry (by Eq. (4.7) of [1]).

The existence of the filtration with the stated properties follows from the existence of the equivariant central charge function \mathcal{Z} ,

$$(4.8) \quad \mathcal{Z} : K_T(X) \rightarrow \mathbb{C},$$

and the fact the action of braiding on $K_T(X)$ lifts to the action on \mathcal{D}_X , by the theorem of [14]. The equivariant central charge \mathcal{Z} is computed by the equivariant Gromov–Witten theory on X in a manner analogous to \mathcal{V} , starting with the σ -model on the cigar D except with no insertion at its tip. It reduces to the Π -stability central charge \mathcal{Z}^0 by turning the equivariant parameters off.

4.3.4.

While \mathcal{B} has few eigensheaves in \mathcal{D}_X , it acts by degree shifts

$$(4.9) \quad \mathcal{B} : \mathcal{D}_{k_m} / \mathcal{D}_{k_{m-1}} \rightarrow \mathcal{D}_{k_m} / \mathcal{D}_{k_{m-1}}[D_{k_m}]\{C_{k_m}\},$$

on the quotient subcategories. The degree shifts may be read off from the eigenvectors of the action of braiding on the equivariant central charge function \mathcal{Z} . As the punctures at a_i and a_j come together, the eigenvector corresponding to the representation V_{k_m} in (4.6), vanishes as [1]

$$\mathcal{Z}_{k_m} = (a_i - a_j)^{D_{k_m} + C_{k_m}/\kappa} \times \text{finite}.$$

It follows that braiding a_i and a_j counterclockwise acts by

$$\mathcal{Z}_{k_m} \rightarrow (-1)^{D_{k_m}} \mathfrak{q}^{\frac{1}{2}C_{k_m}} \mathcal{Z}_{k_m}.$$

The cohomological degree shift $D_{k_m} = \dim_{\mathbb{C}} F_{k_m}$ is by the dimension of the vanishing cycle. The equivariant degree shift C_{k_m} is essentially the one familiar from the action of braiding on conformal blocks of $\widehat{L\mathfrak{g}}$ in the fusion basis [1].

4.3.5.

The derived equivalences of this type are the perverse equivalences of Chuang and Rouquier [23, 24]. They envisioned them as a way to describe derived equivalences which come from variations of Bridgeland stability conditions, but with few examples from geometry.

Traditionally, braid group actions on derived categories of coherent sheaves, or B-branes, are fairly difficult to describe, see for example [20, 21]. Braid group actions on the categories of A-branes are much easier to understand, via Picard–Lefschetz theory and its categorical uplifts [71], see e.g. [52, 77]. The theory of variations of stability conditions, by Douglas and Bridgeland, was invented to bridge the two [9, 29].

4.3.6.

As a by-product, we learn that conformal blocks describing collections cups or caps colored by minuscule representations, come from branes in \mathcal{D}_X which have a simple geometric meaning [1].

Take $X = \text{Gr}_0^{(\mu_1, \mu_1^*, \dots, \mu_d, \mu_d^*)}$ corresponding to \mathcal{A} with $n = 2d$ punctures, colored by pairs of complex conjugate, minuscule representations V_i and V_i^* . We get a vanishing cycle U in X which is a product of d minuscule Grassmannians,

$$U = G/P_1 \times \cdots \times G/P_d,$$

where P_i is the maximal parabolic subgroup of G associated to representation V_i . This vanishing cycle embeds in X as a compact holomorphic Lagrangian, so in the neighborhood of U , we can model X as T^*U . The structure sheaf

$$\mathcal{U} = \mathcal{O}_U \in \mathcal{D}_X$$

of U is the brane we are after. The Grassmannian G/P_i is the cycle that vanishes when a single pair of singular monopoles of charges μ_i and μ_i^* come together, as $\text{Gr}_0^{(\mu_i, \mu_i^*)} = T^*G/P_i$.

The brane \mathcal{U} lives at the very bottom of a d -fold filtration which \mathcal{D}_X develops at the intersection of d walls in the Kahler moduli of X corresponding to bringing punctures together pairwise. It follows \mathcal{U} is the eigensheaf of braiding each pair of matched endpoints. It is extremely special, for the same reason the trivial representation is special.

4.3.7.

Just as fusion provides the right language to understand the action of braiding in conformal field theory, the perverse filtrations provide the right language to describe the action of braiding on derived categories. Using perverse filtrations and the very special properties of the vanishing cycle branes $\mathcal{U} \in \mathcal{D}_X$, one gets the following theorem [1]:

Theorem 1. *For any simply laced Lie algebra ${}^L\mathfrak{g}$, the homology groups*

$$\text{Hom}_{\mathcal{D}_X}^{*,*}(\mathcal{B}\mathcal{U}, \mathcal{U}),$$

categorify $U_q({}^L\mathfrak{g})$ quantum link invariants, and are themselves link invariants.

4.3.8.

As an illustration, proving that (the equivalent of) the pitchfork move in the figure below holds in $\mathcal{D}_{\mathcal{X}}$

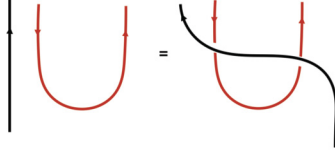

Figure 3 A move equivalent to the pitchfork move.

requires showing that we have a derived equivalence

$$(4.10) \quad \mathcal{B} \circ \mathcal{C}_i \cong \mathcal{C}_i'',$$

where \mathcal{C}_i and \mathcal{C}_i'' are cup functors on the right and the left in Figure 3, respectively. They increase the number of strands by two and map

$$\mathcal{C}_i : \mathcal{D}_{\mathcal{X}_{n-2}} \rightarrow \mathcal{D}_{\mathcal{X}_n} \quad \text{and} \quad \mathcal{C}_i'' : \mathcal{D}_{\mathcal{X}_{n-2}} \rightarrow \mathcal{D}_{\mathcal{X}_n''},$$

where the subscript serves to indicate the number of strands. The functor \mathcal{B} is the equivalence of categories from the theorem of [14]

$$\mathcal{B} : \mathcal{D}_{\mathcal{X}_n} \rightarrow \mathcal{D}_{\mathcal{X}_n''},$$

corresponding to braiding $V_k(a_k)$ with $V_i(a_i) \otimes V_i^*(a_j)$ where V_i and V_i^* color the red and V_k the black strand in Figure 3.

To prove the identity (4.10) note that

$$(4.11) \quad \mathcal{C}_i \mathcal{D}_{\mathcal{X}_{n-2}} \subset \mathcal{D}_{\mathcal{X}_n} \quad \text{and} \quad \mathcal{C}_i'' \mathcal{D}_{\mathcal{X}_{n-2}} \subset \mathcal{D}_{\mathcal{X}_n''},$$

are the subcategories which are the bottom-most part of the double filtrations of $\mathcal{D}_{\mathcal{X}_n}$ and $\mathcal{D}_{\mathcal{X}_n''}$, corresponding to the intersection of walls at which the three punctures come together. By the definition of perverse filtrations, the functor \mathcal{B} acts at a bottom part of a double filtration at most by degree shifts. The degree shifts are trivial too, since if they were not, the relation we are after would not hold even in conformal field theory, and we know it does. To complete the proof, one recalls that a perverse equivalence that acts by degree shifts that are trivial is an equivalence of categories [24].

Proofs of invariance under the Reidemeister 0 and the framed Reidemeister I moves are similar. The invariance under Reidemeister II and III moves follows from the theorem of [14]. One should compare this to proofs of the same relations in [20,21], which are more technical and less general.

4.3.9.

An elementary consequence is a geometric explanation of mirror symmetry which relates the $U_q(\mathcal{L}\mathfrak{g})$ invariants of a link K and its mirror reflection K^* .

It is a consequence of a basic property of \mathcal{D}_X , Serre duality. Serre duality implies the isomorphism of homology groups on X which is a $2d$ complex-dimensional Calabi–Yau manifold,

$$(4.12) \quad \mathrm{Hom}_{\mathcal{D}_X}(\mathcal{B}\mathcal{U}, \mathcal{U}[M]\{J_0, \vec{J}\}) = \mathrm{Hom}_{\mathcal{D}_X}(\mathcal{B}\mathcal{U}, \mathcal{U}[2d - M]\{-d - J_0, -\vec{J}\}).$$

The equivariant degree shift comes from the fact the unique holomorphic section of the canonical bundle has weight d under the $\mathbb{C}_q^\times \subset T$ action. Mirror symmetry follows by taking Euler characteristic of both sides [1].

4.4. Algebra from B-branes

Bezrukavnikov and Kaledin, using quantization in characteristic p , constructed a tilting vector bundle \mathcal{T} , on any X which is a symplectic resolution [12, 13, 43, 44]. Its endomorphism algebra

$$\mathcal{A} = \mathrm{Hom}_{\mathcal{D}_X}^*(\mathcal{T}, \mathcal{T})$$

is an ordinary associative algebra, graded only by equivariant degrees. The derived category $\mathcal{D}_{\mathcal{A}}$ of its modules is equivalent to \mathcal{D}_X ,

$$\mathcal{D}_X \cong \mathcal{D}_{\mathcal{A}},$$

essentially per definition.

Webster recently computed the algebra \mathcal{A} for our X [80], and showed that it coincides with a cylindrical version of the KLRW algebra from [78]. Working with the cylindrical KLRW algebra, as opposed to the ordinary one, leads to invariants of links in $\mathbb{R}^2 \times S^1$ and not just in \mathbb{R}^3 . The KLRW algebra generalizes the algebras of Khovanov and Lauda [50] and Rouquier [68]. The cylindrical version of the KLR algebra corresponds to X which is a Coulomb branch of a pure 3D gauge theory.

4.4.1.

The description of link homologies via $\mathcal{D}_X = \mathrm{DCoh}_T(X)$ provides a geometric meaning of homological $U_q(\mathcal{L}\mathfrak{g})$ link invariants. Even so, without further input, the description of link homologies either in terms of \mathcal{D}_X or $\mathcal{D}_{\mathcal{A}}$ is purely formal. With the help of (equivariant) homological mirror symmetry, we will give a description of link homology groups which is explicit and explicitly computable; in this sense, link homology groups come to life in the mirror.

5. Mirror symmetry for monopole moduli space

In the very best instances, homological mirror symmetry relating $\mathcal{D}_{\mathcal{Y}}$ and \mathcal{D}_X can be made manifest, by showing that each is equivalent to $\mathcal{D}_{\mathcal{A}}$, the derived category of mod-

ules of the same associative algebra \mathcal{A} ,

$$(5.1) \quad \mathcal{D}_X \cong \mathcal{D}_{\mathcal{A}} \cong \mathcal{D}_Y.$$

The algebra

$$\mathcal{A} = \text{Hom}_{\mathcal{D}}^*(\mathcal{T}, \mathcal{T})$$

is the endomorphism algebra of a set of branes $\mathcal{T} = \bigoplus_C \mathcal{T}_C$, which generate \mathcal{D}_X and \mathcal{D}_Y . For economy, we will be denoting branes related by mirror symmetry by the same letter.

An elementary example [10] is mirror symmetry relating a pair of infinite cylinders, $X = \mathbb{C}^\times$ and $Y = \mathbb{R} \times S^1$, whose torus fibers are dual S^1 's. Both \mathcal{D}_X , the derived category of coherent sheaves on X , and \mathcal{D}_Y , based on the wrapped Fukaya category, are generated by a single object \mathcal{T} , a flat line bundle on X and a real-line Lagrangian on Y . Their algebras of open strings are the same, equal to the algebra $\mathcal{A} = \mathbb{C}[x^{\pm 1}]$ of holomorphic functions on the cylinder.

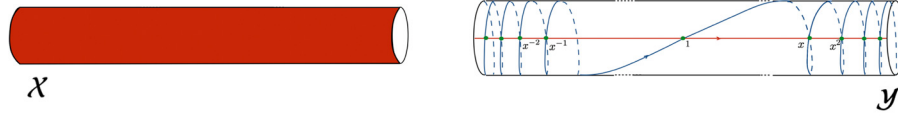

Figure 4 A simple example of manifest mirror symmetry.

5.1. The algebra for homological mirror symmetry

In our setting, the generator \mathcal{T} of \mathcal{D}_X is the tilting generator of Bezrukavnikov and Kaledin from Section 4.4. Webster's proof of the equivalence of categorification of $U_q(L\mathfrak{g})$ link invariants and B-type branes on X and via the cKLRW algebra \mathcal{A} should be understood as the first of the two equivalences in (5.1).

5.1.1.

The mirror Y of X is the moduli space of G monopoles, of the same charges as X except on $\mathbb{R}^2 \times S^1$ instead of on \mathbb{R}^3 , with only complex and no Kahler moduli turned on, and equipped with a potential [2]. Without the potential, the mirror to Y would be another moduli space of G monopoles on $\mathbb{R}^2 \times S^1$.

The theory based on \mathcal{D}_Y , the derived Fukaya–Seidel category of Y , is in the same spirit as the work of Seidel and Smith [72]. They pioneered geometric approaches to link homology, but produced a only singly graded theory, known as symplectic Khovanov homology. The computation of \mathcal{D}_Y , which makes mirror symmetry in (5.1) manifest, is given in the joint work with Danilenko, Li, and Zhou [4].

5.2. The core of the monopole moduli space

Working equivariantly with respect to a \mathbb{C}_q^\times -symmetry which scales the holomorphic symplectic form of \mathcal{X} , all the information about its geometry should be encoded in a core locus preserved by such actions.

The core X is a singular holomorphic Lagrangian in \mathcal{X} which is the union of supports of all stable envelopes [7, 61]. Equivalently, X is the union of all attracting sets of Λ -torus actions on \mathcal{X} , where we let Λ vary over all chambers. If we view \mathcal{X} as the monopole moduli space, we can put this more simply: X is the locus where all the monopoles, singular or not, are at the origin of \mathbb{C} in $\mathbb{R} \times \mathbb{C}$. Viewing it as a Coulomb branch, X is the locus at which the complex scalar fields in vector multiplets vanish.

We will define the equivariant mirror \mathcal{Y} of \mathcal{X} to be the ordinary mirror of its core, so we have

$$\begin{array}{ccc}
 \mathcal{X} & \xleftarrow{\text{mirror}} & \mathcal{Y} \\
 \uparrow & \swarrow \text{equiv. mirror} & \uparrow \\
 X & \xleftarrow{\text{mirror}} & Y
 \end{array}$$

Working equivariantly with respect to the T -action on \mathcal{X} , the equivariant mirror gets a potential W , making the theory on \mathcal{Y} into a Landau–Ginsburg model. While X embeds into \mathcal{X} as a holomorphic Lagrangian of dimension d , \mathcal{Y} fibers over Y with holomorphic Lagrangian $(\mathbb{C}^\times)^d$ fibers.

5.2.1.

A model example is \mathcal{X} which is the resolution of an A_{n-1} hypersurface singularity, $uv = z^n$; \mathcal{X} is the moduli space of a single smooth $G = \text{SU}(2)/\mathbb{Z}_2$ monopole, in the presence of n singular ones. The core X is a collection of $n - 1$ \mathbb{P}^1 's with a pair of infinite discs attached, as in Figure 5.

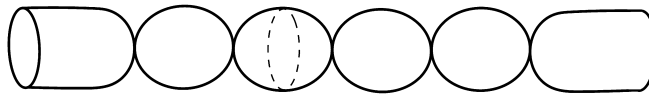

Figure 5 Core X of a resolution of the A_{n-1} singularity.

The ordinary mirror \mathcal{Y} of \mathcal{X} is the complex structure deformation of the “multiplicative” A_{n-1} surface singularity, with a potential which we will not need. \mathcal{Y} is a \mathbb{C}^\times fibration over Y which is itself an infinite cylinder, a copy of \mathbb{C}^\times with n points deleted. At the marked points, the \mathbb{C}^\times fibers degenerate. There are $n - 1$ Lagrangian spheres in \mathcal{Y} , which

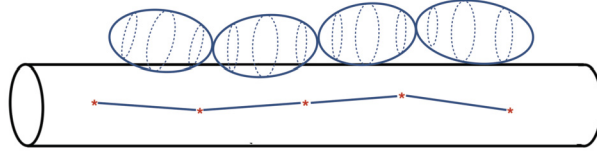

Figure 6 Lagrangian spheres in \mathcal{Y} mirror the vanishing \mathbb{P}^1 's in \mathcal{X} .

are mirror to $n - 1$ \mathbb{P}^1 's in \mathcal{X} . They project to Lagrangians in Y which begin and end at the punctures.

5.2.2.

The model example corresponds to $LG = \text{SU}(2)$ Chern–Simons theory on $\mathbb{R}^2 \times S^1$, and $\widehat{\mathfrak{su}}_2$ conformal blocks on $\mathcal{A} = \mathbb{R} \times S^1$. The n punctures on \mathcal{A} are colored by the fundamental, two-dimensional representation $V_{1/2}$ of \mathfrak{su}_2 , and we take the subspace of weight one level below the highest. Note that Y coincides with the Riemann surface \mathcal{A} where the conformal blocks live. This is not an accident.

In the model example, both X and Y are S^1 fibrations over \mathbb{R} with n marked points. At the marked points, the S^1 fibers of X degenerate. In Y , this is mirrored by fibers that decompactify, due to points which are deleted.

5.2.3.

More generally, for $\mathcal{X} = \text{Gr}_{\vec{\mu}}^v$, we have d_a smooth G -monopoles colored by simple roots $L e_a$ and otherwise identical. It follows that the common base of SYZ fibrations of X and Y is the configuration space of the smooth monopoles on the real line \mathbb{R} with n marked points. The marked points are labeled by the weights μ_i of $L\mathfrak{g}$, which are the singular monopole charges.

An explicit description of Y , as well as its category of A-branes \mathcal{B}_Y , is given [4]. Here we will only describe some of its features. In an open set, Y coincides with

$$Y_0 = \bigotimes_{a=1}^{rk} \text{Sym}^{d_a} \mathcal{A},$$

the configuration space of $d = \sum_{a=1}^{rk} d_a$ points on the punctured Riemann surface \mathcal{A} , “colored” by simple roots $L e_a$ of $L\mathfrak{g}$, but otherwise identical. The open set is the complement of the divisor of zeros and of poles of function f^0 in (5.5).

The top holomorphic form on Y is

$$(5.2) \quad \Omega = \bigwedge_{a=1}^{rk} \bigwedge_{\alpha=1}^{d_a} \frac{dy_{\alpha,a}}{y_{\alpha,a}},$$

where $y_{\alpha,a}$ are coordinates on d copies of \mathcal{A} , viewed as the complex plane with 0 and ∞ deleted. While Ω itself is not globally well defined, so K_Y is not trivial, $\Omega^{\otimes 2}$ is well defined

and

$$(5.3) \quad 2c_1(K_Y) = 0.$$

This allows \mathcal{D}_Y to have a \mathbb{Z} -valued cohomological grading. The symplectic form on Y is inherited from the symplectic form on \mathcal{Y} , by restricting it to the vanishing $(S^1)^d$ in each of its $(\mathbb{C}^\times)^d$ fibers over Y [4]. The precise choice of symplectic structure is the one compatible with mirror symmetry which we used to define Y , as the equivariant mirror of $\mathcal{X} = \text{Gr}_{\vec{\mu}, \nu}^{\vec{\mu}}$ and the ordinary mirror of its core.

Including the equivariant T -equivariant action on X and X corresponds to adding to the σ -model on Y a potential

$$(5.4) \quad W = \lambda_0 W^0 + \sum_{a=1}^{rk} \lambda_a W^a,$$

which is a multivalued holomorphic function on Y ; λ_a are the equivariant parameters of the Λ -action on X , and

$$\mathfrak{q} = e^{2\pi i \lambda_0}.$$

The potentials W^0 and W^a are given by

$$W^0 = \ln f^0, \quad W^a = \ln \prod_{\alpha=1}^{d_a} y_{a,\alpha},$$

where

$$(5.5) \quad f^0(y) = \prod_{a=1}^{rk} \prod_{\alpha=1}^{d_a} \frac{\prod_i (1 - a_i / y_{\alpha,a})^{\langle L e_a, \mu_i \rangle}}{\prod_{(b,\beta) \neq (a,\alpha)} (1 - y_{\beta,b} / y_{\alpha,a})^{\langle L e_a, L e_b \rangle / 2}}.$$

The superpotential W breaks the conformal invariance of the σ -model to Y if $\lambda_0 \neq 0$, since only a quasihomogenous superpotential is compatible with it. This is mirror to breaking of conformal invariance on \mathcal{X} by the $\mathbb{C}_\mathfrak{q}^\times$ -action for $\mathfrak{q} \neq 1$.

Since W^0 and W^a are multivalued, Y is equipped with a collection of closed one-forms with integer periods

$$c^0 = dW^0 / 2\pi i, \quad c^a = dW^a / 2\pi i \in H^1(Y, \mathbb{Z}),$$

which introduce additional gradings in the category of A-branes, as in [73].

5.2.4.

From the mirror perspective, the conformal blocks of $\widehat{L_{\mathfrak{g}}}$ come from the B-twisted Landau–Ginsburg model (Y, W) on D which is an infinitely long cigar, with A-type boundary condition at infinity corresponding to a Lagrangian $L \in Y$. The partition function of the theory has the following form:

$$(5.6) \quad \mathcal{V}_\alpha[L] = \int_L \Phi_\alpha \Omega e^{-W},$$

where Φ_α are chiral ring operators, inserted at the tip of the cigar [22, 39, 40]. By placing the trivial insertion at the origin instead, we get the equivariant central charge function $\mathcal{Z}[L] =$

$\int_L \Omega e^{-W}$; by further turning the equivariant parameters off, the potential W vanishes and the equivariant central charge becomes the ordinary brane central charge $\mathcal{Z}^0[L] = \int_L \Omega$.

We have (re)discovered, from mirror symmetry, an integral representation of the conformal blocks of $\widehat{\mathcal{L}\mathfrak{g}}$. This “free field representation” of conformal blocks, remarkable for its simplicity [32], goes back to the 1980s work of Kohno and Feigin and Frenkel [34, 54], and of Schechtman and Varchenko [69, 70].

5.2.5.

There is a reconstruction theory, due to Givental [38] and Teleman [76], which says that, starting with the solution of the quantum differential equation or its mirror counterpart, one gets to reconstruct all genus topological string amplitudes for any semi-simple 2D field theory. The semi-simplicity condition is satisfied in our case, as W has isolated critical points. It follows the B-twisted Landau–Ginsburg model on (Y, W) and A-twisted T -equivariant sigma model on X are equivalent to all genus [2]. Thus, equivariant mirror symmetry holds as an equivalence of topological string amplitudes.

5.3. Equivariant Fukaya–Seidel category

For every A-brane L at the boundary at infinity of the cigar D , we get a solution of the KZ equation. The brane is an object of

$$\mathcal{D}_Y = D(\mathcal{F}S(Y, W)),$$

the derived Fukaya–Seidel category of Y with potential W . The category should be thought of as a category of equivariant A-branes, due to the fact W in (5.4) is multivalued. Another novel aspect of \mathcal{D}_Y is that it provides an example of Fukaya–Seidel category with coefficients in perverse sheaves. This structure, inherited from equivariant mirror symmetry, was discovered in [4].

5.3.1.

Objects of \mathcal{D}_Y are Lagrangians in Y , equipped with some extra data. A Lagrangian in Y is a product of d one-dimensional curves on \mathcal{A} which are colored by simple roots and may be immersed; or a simplex obtained from an embedded curve, as a configuration space of d partially ordered colored points. The theory also includes more abstract branes, which are iterated mapping cones over morphisms between Lagrangians.

5.3.2.

The extra data includes a grading by Maslov and equivariant degrees. The equivariant grading of a brane in \mathcal{D}_Y is defined by choosing a lift of the phase of e^{-W} to a real-valued function on the Lagrangian L . The equivariant degree shift operation,

$$L \rightarrow L\{\vec{d}\},$$

with $\vec{d} \in \mathbb{Z}^{r+1}$, corresponds to changing the lift of W on L , now viewed as a graded Lagrangian, $W|_{L\{\vec{d}\}} = W|_L + 2\pi i \vec{\lambda} \cdot \vec{d}$. This is analogous to how a choice of a lift of the

phase of $\Omega^{\otimes 2}$ defines the Maslov, or cohomological, grading of a Lagrangian. This restricts the Lagrangians that give rise to objects of \mathcal{D}_Y to those for which such lifts can be defined.

More generally, branes in \mathcal{D}_Y are graded Lagrangians L equipped with an extra structure of a local system Λ of modules of a certain algebra \mathcal{B} we will describe shortly. For the time being, only branes for which Λ is trivial will play a role for us.

5.3.3.

The space of morphisms between a pair of Lagrangian branes in a derived Fukaya category

$$\mathrm{Hom}_{\mathcal{D}_Y}^{*,*}(L_0, L_1) = \ker Q / \mathrm{im} Q,$$

is defined by Floer theory, which itself is modeled after Morse theory approach to supersymmetric quantum mechanics, from the introduction. The role of the Morse complex is taken by the Floer complex.

For branes equipped with a trivial local system, the Floer complex

$$(5.7) \quad \mathrm{CF}^{*,*}(L_0, L_1) = \bigoplus_{\mathcal{P} \in L_0 \cap L_1} \mathbb{C}\mathcal{P}$$

is a graded vector space spanned by the intersection points of the two Lagrangians, together with the action of a differential Q . The complex is graded by the fermion number, which is the Maslov index, and the equivariant gradings, thanks to the fact W is multivalued.

The action of the differential on this space

$$Q : \mathrm{CF}^{*,*}(L_0, L_1) \rightarrow \mathrm{CF}^{*+1,*}(L_0, L_1)$$

is generated by instantons. In Floer theory, the coefficient of \mathcal{P}' in $Q\mathcal{P}$ is obtained by “counting” holomorphic strips in Y with boundary on L_0 and L_1 , interpolating from \mathcal{P} to \mathcal{P}' , of Maslov index 1 and equivariant degree 0. The cohomology of the resulting complex is Floer cohomology.

5.3.4.

A simplification in the present case is that, just as branes have a description in terms of the Riemann surface, so do their intersection points, as well as the maps between them.

The theory that results is a generalization of Heegard–Floer theory, which is associated to ${}^L\mathfrak{g} = \mathfrak{gl}_{1|1}$ and categorifies the Alexander polynomial [63, 64]. Heegard–Floer theory has target $Y_{\mathfrak{gl}_{1|1}} = \mathrm{Sym}^d(\mathcal{A})$, the symmetric product of d copies of \mathcal{A} . $Y_{\mathfrak{gl}_{1|1}}$ should be thought of as a configuration space of fermions on the Riemann surface, as opposed to anyons for $Y_{\mathfrak{su}_2}$; in particular, their top holomorphic forms differ.

While we so far assumed that ${}^L\mathfrak{g}$ is simply laced, the \mathcal{D}_Y has an extension to non-simply laced Lie algebras, as well as $\mathfrak{gl}_{m|n}$ and $\mathfrak{sp}_{m|2n}$ Lie superalgebras, described in [3, 5].

5.4. Link invariants and equivariant mirror symmetry

Mirror symmetry helps us understand exactly which questions we need to ask to recover homological knot invariants from Y .

5.4.1.

Since Y is the ordinary mirror of X , we should start by understanding how to recover homological knot invariants from X , rather than \mathcal{X} . Every B-brane on \mathcal{X} which is relevant for us comes from a B -brane on X via an exact functor

$$(5.8) \quad f_* : \mathcal{D}_X \rightarrow \mathcal{D}_{\mathcal{X}},$$

which interprets a sheaf “downstairs” on X as a sheaf “upstairs” on \mathcal{X} . The functor f_* is more precisely the right-derived functor Rf_* . Its adjoint

$$(5.9) \quad f^* : \mathcal{D}_{\mathcal{X}} \rightarrow \mathcal{D}_X$$

is the left derived functor Lf^* , and corresponds to tensoring with the structure sheaf $\otimes_{\mathcal{O}_X}$, and restricting. Adjointness implies that, given any pair of branes on \mathcal{X} that come from X ,

$$\mathcal{F} = f_*F, \quad \mathcal{G} = f_*G,$$

the Hom’s upstairs, in $\mathcal{D}_{\mathcal{X}}$, agree with the Hom’s downstairs, in \mathcal{D}_X ,

$$(5.10) \quad \mathrm{Hom}_{\mathcal{D}_{\mathcal{X}}}(\mathcal{F}, \mathcal{G}) = \mathrm{Hom}_{\mathcal{D}_X}(f^*f_*F, G),$$

after replacing F with f^*f_*F . The functor f^*f_* is not identity on \mathcal{D}_X .

5.4.2.

The equivariant homological mirror symmetry relating $\mathcal{D}_{\mathcal{X}}$ and $\mathcal{D}_{\mathcal{Y}}$ is not an equivalence of categories, but a correspondence of branes and Hom’s which come from a pair of adjoint functors h_* and h^* , inherited from f_* and f^* via the downstairs homological mirror symmetry:

$$\begin{array}{ccc} \mathcal{D}_{\mathcal{X}} & & \\ & \swarrow h_* & \\ & & \mathcal{D}_{\mathcal{Y}} \\ & \nwarrow h^* & \end{array}$$

Alternatively, h^* and h_* come by composing the upstairs mirror symmetry with a pair of functors $k^* : \mathcal{D}_{\mathcal{Y}} \rightarrow \mathcal{D}_Y$ and $k_* : \mathcal{D}_Y \rightarrow \mathcal{D}_{\mathcal{Y}}$, which are mirror to f^* and f_* . The functors k^*, k_* come from Lagrangian correspondences; their construction is described in joint work with McBreen, Shende, and Zhou [6]. The functor k_* amounts to pairing a brane downstairs, with a vanishing torus fiber over it; this is how Figure 6 arises in our model example. The adjoint functors let us recover answers to all interesting questions about \mathcal{X} from Y .

5.4.3.

For any simply laced Lie algebra ${}^L\mathfrak{g}$, the branes $\mathcal{U} \in \mathcal{D}_{\mathcal{X}}$ which serve as cups upstairs are the structure sheaves of (products of) minuscule Grassmannians, as described in Section 4.3.6. They come via the functor h_* from branes $I_{\mathcal{U}} \in \mathcal{D}_Y$ downstairs, on Y

$$\mathcal{U} = h_*I_{\mathcal{U}},$$



Figure 7 The cup and cap A-branes corresponding to the defining representation of $L\mathfrak{g} = \mathfrak{su}_4$, colored by its three simple roots; they are equivariant mirror to a B-brane supported on a \mathbb{P}^4 as its structure sheaf.

which are (products of) generalized intervals. A minuscule Grassmannian G/P_i is the h_* -image of a brane which is the configuration space of colored points on an interval ending on a pair of punctures on \mathcal{A} corresponding to representations V_i and V_i^* . The points are colored by simple positive roots in $\mu_i + \mu_i^* = \sum_a d_{a,i} L e_a$, and ordered in the sequence by which, to obtain the lowest weight μ_i^* in representation V_i , we subtract simple positive roots from the highest weight μ_i . Because V_i and V_i^* are minuscule representations, the ordering and hence the brane $I_{\mathcal{U}}$ is unique, up to equivalence and a choice of grading. The \mathcal{U} branes project back down as generalized figure-eight branes; these are nested products of figure-eights, colored by simple roots

$$h^*\mathcal{U} = h^*h_*I_{\mathcal{U}} = E_{\mathcal{U}},$$

and ordered analogously, as in Figure 7. As objects of \mathcal{D}_Y , these branes are best described iterated cones over more elementary branes, mirror to stable basis branes [5]. The cup and cap branes all come with trivial local systems, for which the Floer complexes are the familiar ones, given by (5.7).

As an example, for $L\mathfrak{g} = \mathfrak{su}_2$ the only minuscule representation is the defining representation $V_i = V_{\frac{1}{2}}$, which is self-conjugate. The cup brane \mathcal{U} in \mathcal{X} is a product of d non-intersecting \mathbb{P}^1 's. It comes, as the image of h_* , from a brane $I_{\mathcal{U}}$ in Y which is a product of d simple intervals, connecting pairs of punctures that come together. The \mathcal{U} -brane projects back down, via the h^* functor, as a product of d elementary figure-eight branes. The branes are graded by Maslov and equivariant gradings, as described in [2].

5.4.4.

In the description based on Y , both the branes, and the action of braiding on them is geometric, so we can simply start with a link and a choice of projection to the surface $\mathcal{A} = \mathbb{R} \times S^1$. A link contained in a three ball in $\mathbb{R}^2 \times S^1$ is equivalent to the same link in \mathbb{R}^3 , and projects to a contractible patch on \mathcal{A} .

To translate the link to a pair of A-branes, start by choosing bicoloring of the link projection, such that each of its components has an equal number of red and blue segments, and the red always underpass the blue. For a link component colored by a representation V_i of $L\mathfrak{g}$, place a puncture colored by its highest weight μ_i where a blue segment begins and its conjugate μ_i^* where it ends; the orientation of the link component distinguishes the two.

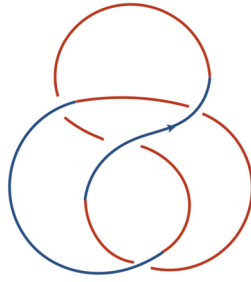

Figure 8 A bicoloring of the left-handed trefoil.

The mirror Lagrangians $I_{\mathcal{U}}$ and $\mathcal{B}E_{\mathcal{U}}$ are obtained by replacing all the blue segments by the interval branes, and all the red segments by figure-eight branes, related by equivariant mirror symmetry to minuscule Grassmannian branes. This data determines both Y and the branes on it we need. The variant of the second step, applicable for Lie superalgebras, is described in [5].

Equivariant mirror symmetry predicts that a homological link invariant is the space of morphisms

$$(5.11) \quad \mathrm{Hom}_{\mathcal{D}_Y}^{*,*}(\mathcal{B}E_{\mathcal{U}}, I_{\mathcal{U}}) = \bigoplus_{k \in \mathbb{Z}, \vec{d} \in \mathbb{Z}^{r^{k+1}}} \mathrm{Hom}_{\mathcal{D}_Y}(\mathcal{B}E_{\mathcal{U}}, I_{\mathcal{U}}[k]\{\vec{d}\}),$$

the cohomology of the Floer complex of the two branes. In what follows, we will explain how to compute it.

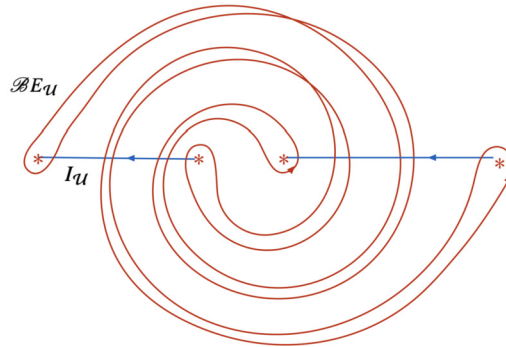

Figure 9 The branes corresponding to the left-handed trefoil in $\mathcal{L}_{\mathfrak{g}} = \mathfrak{su}_2$. The knot was isotoped relative to Figure 8.

5.4.5.

To evaluate the Euler characteristic of the homology in (5.11), one simply counts intersection points of Lagrangians, keeping track of gradings. For links in \mathbb{R}^3 , the equivariant

grading in (5.11) collapses to a \mathbb{Z} -grading. The Euler characteristic becomes

$$(5.12) \quad \chi(\mathcal{BE}_U, I_U) = \bigoplus_{\mathcal{P} \in \mathcal{BE}_U \cap I_U} (-1)^{M(\mathcal{P})} q^{J(\mathcal{P})},$$

where $M(\mathcal{P})$ and $J(\mathcal{P})$ are the Maslov and c^0 -grading of the point \mathcal{P} ; as in Heegard–Floer theory, there are purely combinatorial formulas for them [3,5]. Mirror symmetry implies that this is the $U_q(L\mathfrak{g})$ invariant of the link in \mathbb{R}^3 .

The fact that for $L\mathfrak{g} = \mathfrak{su}_2$ the graded count of intersection points in (5.12) reproduces the Jones polynomial is a theorem of Bigelow [15], building on the work of Lawrence [56–58]. Bigelow also proved the statement for $L\mathfrak{g} = \mathfrak{su}_N$ with links colored by the defining representation [16]. The equivariant homological mirror symmetry explains the origin of Bigelow’s peculiar construction, and generalizes it to other $U_q(L\mathfrak{g})$ link invariants.¹

5.4.6.

The action of the differential Q on the Floer complex, defined by counting holomorphic maps from a disk D to Y with boundaries on the pair of Lagrangians, should have a reformulation [2] in terms of counting holomorphic curves embedded in $D \times \mathcal{A}$ with certain properties, generalizing the cylindrical formulation of Heegard–Floer theory due to Lipshitz [59]. The curve must have a projection to D as a $d = \sum_a d_a$ -fold cover, with branching only between components of one color, and a projection to \mathcal{A} as a domain with boundaries on one-dimensional Lagrangians of matching colors. In addition, the potential W must pull back to D as a regular holomorphic function. Computing the action of Q in this framework reduces to solving a sequence of well defined, but hard, problems in complex analysis in one dimension, which are applications of the Riemannian mapping theorem, similar to that in [63].

6. Homological link invariants from A-branes

To compute the link homology groups

$$(6.1) \quad \text{Hom}_{\mathcal{D}_Y}^{*,*}(\mathcal{BE}_U, I_U),$$

we will make use of mirror symmetry which relates X and Y and is the equivalence of categories

$$(6.2) \quad \mathcal{D}_X \cong \mathcal{D}_A \cong \mathcal{D}_Y,$$

proven in [4]. A basic virtue of mirror symmetry is that it sums up holomorphic curve counts. In our case, it solves all the disk-counting problems required to find the action of the differential Q on the Floer complex underlying (6.1).

¹ In [60], Bigelow’s representation of the Jones polynomial, specialized to $q = 1$, was related to the Euler characteristic of symplectic Khovanov homology of [73].

6.1. The algebra of A-branes

As in the simplest examples of homological mirror symmetry, \mathcal{D}_X and \mathcal{D}_Y are both generated by a finite set of branes.

6.1.1.

From perspective of Y , the generating set of branes come from products of real line Lagrangians on \mathcal{A} , colored by $d = \sum_a d_a$ simple roots. The brane is unchanged by reordering a pair of its neighboring Lagrangian components, provided they are colored by roots which are not linked in the Dynkin diagram $\langle {}^L e_a, {}^L e_b \rangle = 0$. It is also unchanged by passing a component colored by ${}^L e_a$ across a puncture colored by a weight μ_i with $\langle {}^L e_a, \mu_i \rangle = 0$.

There is a generating brane

$$T_C = T_{i_1} \times \cdots \times T_{i_d} \in \mathcal{D}_Y,$$

for every inequivalent ordering of d colored real lines on the cylinder. Their direct sum

$$T = \bigoplus_C T_C \in \mathcal{D}_Y,$$

is the generator of \mathcal{D}_Y which is mirror to the tilting vector bundle on X , which generates \mathcal{D}_X . This generalizes the simplest example of mirror symmetry from Section 5.1. As before, we will be denoting branes on X and on Y related by homological mirror symmetry by the same letter.

6.1.2.

A well known phenomenon in mirror symmetry is that it may introduce Lagrangians with an extra structure of a local system, a nontrivial flat $U(1)$ bundle. The mirror of a structure sheaf of a generic point, in our model example of mirror symmetry from Section 5.1, is a Lagrangian of this sort.

Here, we find a generalization of this [4]. The pair of adjoint functors h_* and h^* that relate \mathcal{D}_Y with its equivariant mirror \mathcal{D}_X equip each T -brane with a vector bundle or, more precisely, with a local system of modules for a graded algebra \mathcal{B} . The algebra is a product $\mathcal{B} = \bigotimes_{a=1}^r \mathcal{B}_{d_a}$, where \mathcal{B}_d has a representation as the quotient of the algebra of polynomials in d variables z_1, \dots, z_d which sets their symmetric functions to zero. The z 's have equivariant \mathfrak{q} -degree equal to one.

As a consequence, the downstairs theory is not simply the Fukaya category of Y , but a Fukaya category with coefficients [4]: Floer complexes assign to each intersection point $\mathcal{P} \in L_0 \cap L_1$ a vector space $\text{hom}_{\mathcal{B}}(\Lambda_0|_{\mathcal{P}}, \Lambda_1|_{\mathcal{P}})$ of homomorphisms of \mathcal{B} -modules $\Lambda_{0,1}$ which $L_{0,1}$ are equipped with. The cup and cap branes $E_{\mathcal{U}}$ and $I_{\mathcal{U}}$ come with trivial modules for \mathcal{B} . The T_C branes correspond to modules for \mathcal{B} equal to \mathcal{B} itself.

6.1.3.

Since the T_C -branes are noncompact, defining the Hom's between them requires care. The Hom's

$$\text{Hom}_{\mathcal{D}_Y}(T_C, T'_C[k]\{\vec{d}\}) = \text{HF}(T_C^{\xi}, T'_C[k]\{\vec{d}\})$$

are defined through a perturbation of T_C which induces wrapping near infinities of \mathcal{A} , as in Figure 4, and other examples of wrapped Fukaya categories.

The Floer cohomology groups HF are cohomology groups of the Floer complex whose generators are intersection points of the T_C branes, with coefficients in \mathcal{B} . The generators all have homological degree zero, so the Floer differential is trivial, and

$$(6.3) \quad \text{Hom}_{\mathcal{D}_Y}(T_C, T_{C'}[k]\{\vec{d}\}) = 0, \quad \text{for all } k \neq 0 \text{ and all } \vec{d}.$$

The Floer product on \mathcal{D}_Y makes

$$A = \text{Hom}_{\mathcal{D}_Y}^*(T, T) = \bigoplus_{C, C'} \bigoplus_{\vec{d} \in \mathbb{Z}^{r^{k+1}}} \text{Hom}_{\mathcal{D}_X}(T_C, T_{C'}\{\vec{d}\})$$

into an algebra, which is an ordinary associative algebra, graded only by equivariant degrees.

6.1.4.

The vanishing in (6.3) mirrors the tilting property of T viewed as the generator of \mathcal{D}_X . The tilting vector bundle $T \in \mathcal{D}_X$ is inherited from the Bezrukavnikov–Kaledin tilting bundle \mathcal{T} on \mathcal{X} ,

$$\mathcal{T} = \bigoplus_C \mathcal{T}_C \in \mathcal{D}_X,$$

from Section 4.4, as the image of the f^* functor, which is tensoring with the structure sheaf of X and restriction, $f^*\mathcal{T} = T \in \mathcal{D}_X$. The endomorphism of the upstairs tilting generator \mathcal{T} ,

$$\mathcal{A} = \text{Hom}_{\mathcal{D}_X}^*(\mathcal{T}, \mathcal{T}),$$

is the cylindrical KLRW algebra.

Since \mathcal{T} is a vector bundle on \mathcal{X} , the center of \mathcal{A} is the algebra of holomorphic functions on \mathcal{X} . The downstairs algebra is a quotient of the upstairs one, by a two-sided ideal

$$(6.4) \quad A = \mathcal{A} / \mathcal{I}.$$

The ideal \mathcal{I} is generated by holomorphic functions that vanish on the core X .

6.1.5.

The cKLRW algebra \mathcal{A} is defined as an algebra of colored strands on a cylinder, decorated with dots, where composition is represented by stacking cylinders and rescaling [80]. The local algebra relations are those of the ordinary KLRW algebra from [78]. Placing the theory on the cylinder, it gets additional gradings by the winding number of strands of a given color, corresponding to the equivariant Λ -action on \mathcal{X} .

The elements of the algebra $A = \mathcal{A} / \mathcal{I}$ have a geometric interpretation by recalling the Floer complex $\text{CF}^*(T_C, T_{C'})$ is fundamentally generated by paths rather than the intersection points. The S^1 of the algebra cylinder is the S^1 in the Riemann surface \mathcal{A} ; its vertical direction parameterizes the path. The geometric intersection points of the T -branes on \mathcal{A} correspond to strings in A . The flat bundle morphisms, a copy of \mathcal{B} for each geometric intersection point, dress the strings by dots of the same color. The algebra \mathcal{B} is the quotient, of the subalgebra of \mathcal{A} generated by dots, by the ideal \mathcal{I} of their symmetric functions.

6.2. The meaning of link homology

Since $T = \bigoplus_C T_C$ generates \mathcal{D}_Y , like every Lagrangian in \mathcal{D}_Y , the $\mathcal{B}E_{\mathcal{U}}$ brane has a description as a complex

$$(6.5) \quad \mathcal{B}E_{\mathcal{U}} \cong \cdots \xrightarrow{t_1} \mathcal{B}E_1(T) \xrightarrow{t_0} \mathcal{B}E_0(T),$$

every term of which is a direct sum of T_C -branes. The complex is the projective resolution of the $\mathcal{B}E_{\mathcal{U}}$ brane. It describes how to get the $\mathcal{B}E_{\mathcal{U}} \in \mathcal{D}_Y$ brane by starting with the direct sum brane

$$(6.6) \quad \mathcal{B}E(T) = \bigoplus_k \mathcal{B}E_k(T)[k],$$

with a trivial differential, and taking iterated cones over elements $t_k \in A$. This deforms the differential to

$$(6.7) \quad Q_A = \sum_k t_k \in A,$$

which takes

$$Q_A : \mathcal{B}E(T) \rightarrow \mathcal{B}E(T)[1],$$

as a cohomological degree 1 and equivariant degree 0 operator, which squares to zero $Q_A^2 = 0$ in the algebra A .

6.2.1.

The category of A-branes \mathcal{D}_Y has a second, Koszul dual set of generators, which are the vanishing cycle branes $I = \bigoplus_C I_C$ of [2]. The I - and the T -branes are dual in the sense that the only nonvanishing morphisms from the T - to the I -branes are

$$(6.8) \quad \text{Hom}_{\mathcal{D}_Y}(T_C, I_{C'}) = \mathbb{C} \delta_{C, C'}.$$

The I_C -branes and the T_C -branes are, respectively, the simple and the projective modules of the algebra A .

6.2.2.

Among the I -branes, we find the branes $I_{\mathcal{U}} \in \mathcal{D}_Y$ which serve as cups. This is a wonderful simplification because it implies that from the complex in (6.5), we get for free a complex of vector spaces:

$$(6.9) \quad 0 \rightarrow \text{hom}_A(\mathcal{B}E_0(T), I_{\mathcal{U}}\{\vec{d}\}) \xrightarrow{t_0} \text{hom}_A(\mathcal{B}E_1(T), I_{\mathcal{U}}\{\vec{d}\}) \xrightarrow{t_1} \cdots .$$

The maps in the complex (6.9) are induced from the complex in (6.5). The cohomologies of this complex are the link homologies we are after,

$$(6.10) \quad \text{Hom}_{\mathcal{D}_Y}(\mathcal{B}E_{\mathcal{U}}, I_{\mathcal{U}}[k]\{\vec{d}\}) = H^k(\text{hom}_A(\mathcal{B}E_{\mathcal{U}}, I_{\mathcal{U}})).$$

6.2.3.

We learn that link homology captures only a small part of the geometry of $\mathcal{BE}_{\mathcal{U}}$, the braided cup brane, or more precisely, of the complex that resolves it. Because the T -branes are dual to the I -branes by (6.8), almost all terms in the complex (6.9) vanish. The cohomology (6.10) of small complex that remains is the $U_{\mathfrak{q}}(L_{\mathfrak{g}})$ link homology.

6.2.4.

The complex (6.9) itself has a geometric interpretation as the Floer complex,

$$\mathrm{CF}^{*,*}(\mathcal{BE}_{\mathcal{U}}, I_{\mathcal{U}}).$$

Namely, the vector space at the k th term of the complex

$$\mathrm{hom}_A(\mathcal{BE}_k(T), I_{\mathcal{U}}\{\vec{d}\})$$

is identified, by construction described in section 6.3, with that spanned by the intersection points of the $\mathcal{BE}_{\mathcal{U}}$ brane and the $I_{\mathcal{U}}$ brane, of cohomological degree $[k]$ and equivariant degree $\{\vec{d}\}$.

The maps in the complex

$$\cdots \xrightarrow{t_{k-1}} \mathrm{hom}_A(\mathcal{BE}_k(T), I_{\mathcal{U}}\{\vec{d}\}) \xrightarrow{t_k} \mathrm{hom}_A(\mathcal{BE}_{k+1}(T), I_{\mathcal{U}}\{\vec{d}\}) \xrightarrow{t_{k+1}} \cdots$$

encode the action of the Floer differential. A priori, computing these requires counting holomorphic disk instantons. In our case, mirror symmetry (6.2) has summed them up.

6.3. Projective resolutions from geometry

The projective resolution in (6.5) encodes all the $U_{\mathfrak{q}}(L_{\mathfrak{g}})$ link homology, and more. Finding the resolution requires solving two problems, both in general difficult. We will solve simultaneously [5].

6.3.1.

The first problem is to compute which module of the algebra A the brane $\mathcal{BE}_{\mathcal{U}}$ gets mapped to by the Yoneda functor

$$L \in \mathcal{D}_Y \rightarrow \mathrm{Hom}_{\mathcal{D}_Y}^{*,*}(T, L) \in \mathcal{D}_A.$$

This functor, which is the source of the equivalence $\mathcal{D}_Y \cong \mathcal{D}_A$, maps a brane L to a right module for A , on which the algebra acts as

$$\mathrm{Hom}_{\mathcal{D}_Y}^{*,*}(T, L) \otimes \mathrm{Hom}_{\mathcal{D}_Y}^*(T, T) \rightarrow \mathrm{Hom}_{\mathcal{D}_Y}^{*,*}(T, L).$$

Evaluating this action requires counting disk instantons.

6.3.2.

The second problem is to find the resolution of this module, as in (6.5). The Yoneda functor maps the T_C branes to projective modules of the algebra A , so the resolution in (6.5) is a projective resolution of the A module corresponding to the $\mathcal{BE}_{\mathcal{U}}$ brane. This problem is known to be solvable, however, only formally so, by infinite bar resolutions.

6.3.3.

In our setting, these two problems get solved together. Fortune smiles since the $\mathcal{BE}_{\mathcal{U}} \in \mathcal{D}_Y$ branes are products of d one-dimensional Lagrangians on \mathcal{A} , for which the complex resolving brane (6.5) can be deduced explicitly, from the geometry of the brane.

6.3.4.

Take a pair of branes L' and L'' on Y which are products of d one-dimensional Lagrangians on \mathcal{A} , chosen to coincide up to one of their factors. Up to permutation, we can take

$$L' = L_1 \times L_2 \times \cdots \times L_d, \quad L'' = L'_1 \times L_2 \times \cdots \times L_d.$$

If L'_1 and L''_1 (which are necessarily of the same color) intersect over a point $p \in L'_1 \cap L''_1$ of Maslov index zero, we get a new one dimensional Lagrangian L_1 which is a cone over p ,

$$L_1 = \text{Cone}(p) = L'_1 \xrightarrow{p} L''_1,$$

as well as a new d -dimensional Lagrangian L on Y given by

$$(6.11) \quad L = L_1 \times L_2 \times \cdots \times L_d.$$

The Lagrangian is a cone over the intersection point \mathcal{P} of L' and L'' which is of the form

$$(6.12) \quad \mathcal{P} = (p, \text{id}_{L_2}, \dots, \text{id}_{L_d}) \in L' \cap L'',$$

and which also has Maslov index zero, $L = \text{Cone}(\mathcal{P})$.

Conversely, any L brane which is of the product form in (6.11) can be written as a complex [11]

$$(6.13) \quad L \cong L' \xrightarrow{\mathcal{P}} L''$$

with an explicit map \mathcal{P} coming from a one-dimensional intersection point in one of its factors, as in (6.12).

6.3.5.

To find the projective resolution of the $\mathcal{BE}_{\mathcal{U}}$ brane in (6.5), start by isotoping the brane, by stretching it straight along the cylinder.

Let the brane break at the two infinities of \mathcal{A} , to get the direct sum brane $\mathcal{BE}(T)$ in (6.6), on which the complex is based. To find the maps in the complex, record how the brane breaks, iterating the above construction, one one-dimensional intersection point at the time. Every intersection point of the form (6.12) translates to a specific element of the algebra A and a specific map in the complex. The result is a product of d one-dimensional complexes, which describes factors of $\mathcal{BE}_{\mathcal{U}}$, and captures almost all the terms in the differential Q_A . The remaining ones follow, up to quasi-isomorphisms, by asking that the differential closes $Q_A^2 = 0$ in the algebra A . The fact that not all terms in Q_A are geometric is a general feature of $d > 1$ theories.

In practice, it is convenient to first break the brane one of the two infinities of \mathcal{A} , and only then on the other. The branes at the intermediate stage are images, under the h^*

functor, of stable basis branes [7, 61] on \mathcal{D}_X . The stable basis branes play a similar role to that of Verma modules in category \mathcal{O} . The detailed algorithm is given in [5].

6.3.6.

As an example, take the left-handed trefoil and $L\mathfrak{g} = \mathfrak{su}_2$, which leads to the brane configuration from Figure 9. For simplicity, consider the reduced knot homology, where the unknot homology is set to be trivial. As in Heegard-Floer theory, this corresponds to erasing a component from the \mathcal{BEU} and the I_U branes, and leads to Figure 10. This also brings us back to the setting of our running example, where Y is the equivariant mirror to X , the resolution of the A_{n-1} surface singularity, with $n = 4$.

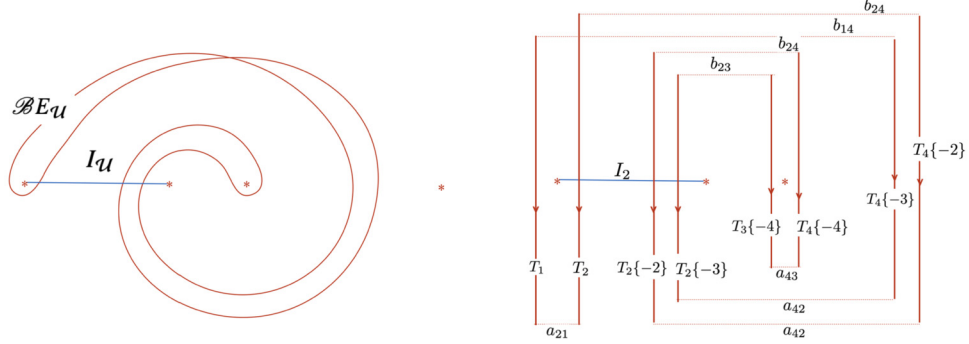

Figure 10 Resolution of the \mathcal{BEU} brane corresponding to the reduced trefoil. The axis of the cylinder \mathcal{A} is oriented vertically here; the branes do not wind around the S^1 .

The corresponding algebra $A = \bigoplus_{i,j=0}^{n-1} \text{Hom}_{\mathcal{D}_Y}^*(T_i, T_j)$ is the path algebra of an affine A_{n-1} quiver, whose nodes correspond to T_i branes. The arrows $a_{i+1,i} \in \text{Hom}_{\mathcal{D}_Y}(T_i, T_{i+1})$ and $b_{i,i+1} \in \text{Hom}_{\mathcal{D}_Y}(T_{i+1}, T_i\{1\})$ satisfy $a_{i,i-1}b_{i-1,i} = 0 = b_{i,i+1}a_{i+1,i}$, with i defined modulo n . The a 's and b 's correspond to intersections of T -branes, near one or the other infinity of \mathcal{A} ; we have suppressed their Λ -equivariant degrees.

Isotope the \mathcal{BEU} brane straight along the cylinder \mathcal{A} . Let it break into T -branes, as in Figure 10, while recording how the brane breaks, one connected sum at a time. Every connected sum of a pair of T -branes is a cone over their intersection point, at one of the two infinities of \mathcal{A} , and a specific element of the algebra A . This leads to the complex

$$\mathcal{BEU} \cong T_3\{-4\} \xrightarrow{\begin{pmatrix} a_{4,3} \\ b_{2,3} \end{pmatrix}} \begin{matrix} T_4\{-4\} \\ \oplus \\ T_2\{-3\} \end{matrix} \xrightarrow{\begin{pmatrix} b_{2,4} & 0 \\ 0 & a_{4,2} \end{pmatrix}} \begin{matrix} T_2\{-2\} \\ \oplus \\ T_4\{-3\} \end{matrix} \xrightarrow{\begin{pmatrix} a_{42} & 0 \\ 0 & b_{14} \end{pmatrix}} \begin{matrix} T_4\{-2\} \\ \oplus \\ T_1 \end{matrix} \xrightarrow{(b_{24} - a_{21})} T_2$$

which closes by the A -algebra relations.

The reduced homology of the trefoil is the cohomology of the complex $\text{hom}_A(\mathcal{B}E^\bullet, I_{\mathcal{U}}\{d\})$ in (6.9). The only non-zero contributions come from the T_2 brane, since the cup brane $I_{\mathcal{U}} = I_2$ is dual to it. All the maps evaluate to zero, as $I_{\mathcal{U}}$ brane is a simple module for A . As a consequence,

$$\text{Hom}_{\mathcal{D}_Y}(\mathcal{B}E_{\mathcal{U}}, I_{\mathcal{U}}[k]\{d\}) = H^k(\text{hom}_A(\mathcal{B}E^\bullet, I_2\{d\})),$$

equals to \mathbb{Z} only for $(k, d) = (0, 0), (2, -2), (3, -3)$, and vanishes otherwise. Here, $k = M$ is the Maslov or cohomological degree and $d = J$ the Jones grading. This is the reduced Khovanov homology of the left-handed trefoil, up to regrading: Khovanov's (i, j) gradings are related to (M, J) by $i = M + 2J + i_0$ and $j = 2J + j_0$ where $i_0 = 0$, $j_0 = d + n_+ - n_-$, where $n_+ = 0$, $n_- = 3$ are the numbers of positive and negative crossings, and $d = 1$ is the dimension of Y [2].

6.3.7.

The theory extends to non-simply-laced Lie algebras, and to Lie superalgebras $\mathfrak{gl}_{m|n}$ and $\mathfrak{sp}_{m|2n}$, as described in [5]. The algebra A corresponding to ${}^L\mathfrak{g}$ which is a Lie superalgebra, is not an ordinary associative algebra but a differential graded algebra; the projective resolutions are then in terms of twisted complexes. This section gives a method for solving the theory which is new even for ${}^L\mathfrak{g} = \mathfrak{gl}_{1|1}$, corresponding to Heegard-Floer theory. The solution differs from that in [65], in particular since our Heegard surface is $\mathcal{A} = \mathbb{R} \times S^1$, independent of the link.

Acknowledgments

This work grew out of earlier collaborations with Andrei Okounkov, which were indispensable. It includes results obtained jointly with Ivan Danilenko, Elise LePage, Yixuan Li, Michael McBreen, Miroslav Rapcak, Vivek Shende, and Peng Zhou. I am grateful to all of them for collaboration. I was supported by the NSF foundation grant PHY1820912, by the Simons Investigator Award, and by the Berkeley Center for Theoretical Physics.

References

- [1] M. Aganagic, “Knot Categorification from Mirror Symmetry, Part I: Coherent Sheaves,” arXiv:2004.14518, 2020.
- [2] M. Aganagic, “Knot Categorification from Mirror Symmetry, Part II: Lagrangians,” arXiv:2105.06039, 2021.
- [3] M. Aganagic, “Knot Categorification from Mirror Symmetry, Part III: String Theory Origin,” to appear.
- [4] M. Aganagic, I. Danilenko, Y. Li, and P. Zhou, “Homological mirror symmetry for monopole moduli spaces,” to appear.
- [5] M. Aganagic, E. LePage, and M. Rapcak, “Homological link invariants from mirror symmetry: Computations,” to appear.

- [6] M. Aganagic, M. McBreen, V. Shende, and P. Zhou, “Intertwining toric and hypertoric mirror symmetry,” to appear.
- [7] M. Aganagic and A. Okounkov, “Elliptic stable envelope,” arXiv:1604.00423v4, 2020.
- [8] J. W. Alexander, “Topological invariants of knots and links.” Transactions of the American Mathematical Society. 30 (1923): 275–306.
- [9] P. S. Aspinwall et al., “Dirichlet branes and mirror symmetry,” 681 pages, Clay Mathematics Monographs, 4 Providence, RI: AMS (2009)
- [10] D. Auroux, “A beginner’s introduction to Fukaya categories,” arXiv:1301.7056.
- [11] D. Auroux, “Fukaya categories of symmetric products and bordered Heegaard-Floer homology.” arXiv: 1001.4323; D. Auroux, “Fukaya categories and bordered Heegaard-Floer homology”, arXiv:1003.2962.
- [12] R. Bezrukavnikov, “Noncommutative Counterparts of the Springer Resolution,” arXiv:math/0604445, 2006.
- [13] R. Bezrukavnikov and D. Kaledin, “Fedosov quantization in positive characteristic,” 2005, arXiv:math/0501247.
- [14] R. Bezrukavnikov and A. Okounkov, to appear.
- [15] S. Bigelow, “A homological definition of the Jones polynomial,” Geom. & Top. Monogr. 4, 29–41, 2002. arXiv:math.GT/0201221v2.
- [16] S. Bigelow, “A homological definition of the HOMFLY polynomial,” Algebr. Geom. Topol. 7(3): 1409–1440 (2007).
- [17] T. Bridgeland, “Stability conditions on triangulated categories,” Annals of Mathematics, 166 (2007), 317–345.
- [18] T. Bridgeland, “Stability conditions and Kleinian singularities,” arXiv:math/0508257, 2020.
- [19] M. Bullimore, T. Dimofte, and D. Gaiotto, “The Coulomb Branch of 3D $\mathcal{N} = 4$ Theories,” Commun. Math. Phys. 354 (2017) no. 2, 671 [arXiv:1503.04817].
- [20] S. Cautis, J. Kamnitzer, “Knot homology via derived categories of coherent sheaves I, $sl(2)$ case,” arXiv:math/0701194.
- [21] S. Cautis and J. Kamnitzer, “Knot homology via derived categories of coherent sheaves II, sl_m case,” Inventiones Mathematicae 174 (2008), Article number 165.
- [22] S. Cecotti and C. Vafa, “Topological antitopological fusion,” Nucl. Phys. B367 (1991) 359.
- [23] J. Chuang and R. Rouquier, “Derived equivalences for symmetric groups and sl_2 -categorification,” arXiv:math/0407205, 2005.
- [24] J. Chuang and R. Rouquier, “Perverse Equivalence,” preprint, available at <https://www.math.ucla.edu/~rouquier/papers/perverse.pdf>.
- [25] L. Crane and I. Frenkel, “Four-dimensional topological field theory, Hopf categories, and the canonical bases,” J. Math. Phys. **35** (1994), 5136–5154.
- [26] I. Danilenko, *Slices of the Affine Grassmannian and Quantum Cohomology*, 2020, PhD thesis, Columbia University.

- [27] R. Dijkgraaf, H. L. Verlinde, and E. P. Verlinde, “Topological strings in $d < 1$,” Nucl. Phys. B **352** (1991), 59–86.
- [28] M. R. Douglas, “D-branes, categories and $N = 1$ supersymmetry,” J. Math. Phys. **42**, 2818 (2001).
- [29] M. R. Douglas, B. Fiol, and C. Romelsberger, “Stability and BPS branes,” JHEP **0509**, 006 (2005).
- [30] V. G. Drinfeld, “Quasi-Hopf Algebras and Knizhnik–Zamolodchikov Equations”. In: Belavin, A. A., Klimyk, A. U., Zamolodchikov, A. B. (eds), Problems of Modern Quantum Field Theory. Research Reports in Physics. Springer, Berlin, Heidelberg, (1989).
- [31] B. Dubrovin, “Geometry of 2d topological field theories.” arXiv:[hep-th/9407018](https://arxiv.org/abs/hep-th/9407018).
- [32] P. Etingof, I. Frenkel, and A. A. Kirillov, Jr., “Lectures on representation theory and Knizhnik–Zamolodchikov equations,” Math. Surveys and Monographs, vol. 58, Amer. Math. Soc., Providence, RI, 1998, 198 pp.
- [33] P. Etingof and N. Geer, “Monodromy of trigonometric KZ equations,” arXiv:[math/0611003](https://arxiv.org/abs/math/0611003).
- [34] B. Feigin and E. Frenkel, “A family of representations of affine Lie algebras,” Uspekhi Matem. Nauk, **43:5** (1988), 227–228 [English translation: Russ. Math. Surv., **43:5** (1988), 221–222].
- [35] D. Gaiotto, G. W. Moore, and E. Witten, “Algebra of the Infrared: String Field Theoretic Structures in Massive $\mathcal{N} = (2, 2)$ Field Theory In Two Dimensions,” arXiv:[1506.04087](https://arxiv.org/abs/1506.04087).
- [36] S. Galkin, V. Golyshev, and H. Iritani, “Gamma classes and quantum cohomology of Fano manifolds: Gamma conjectures,” arXiv:[1404.6407](https://arxiv.org/abs/1404.6407).
- [37] A. Givental, “Homological geometry and mirror symmetry,” Chatterji, S. D. (eds.) Proceedings of the International Congress of Mathematicians, 1994, Birkhäuser.
- [38] A. Givental, “Semisimple Frobenius structures at higher genus,” arXiv:[math/0008067v4](https://arxiv.org/abs/math/0008067v4).
- [39] K. Hori, A. Iqbal, and C. Vafa, “D-branes and mirror symmetry,” arXiv:[hep-th/0005247](https://arxiv.org/abs/hep-th/0005247).
- [40] K. Hori, S. Katz, A. Klemm, R. Pandharipande, R. Thomas, C. Vafa, R. Vakil, and E. Zaslow, “Mirror symmetry,” 2006. 929 pp.
- [41] H. Iritani, “An integral structure in quantum cohomology and mirror symmetry for toric orbifolds”, arXiv:[0903.1463](https://arxiv.org/abs/0903.1463).
- [42] V. F. R. Jones, “A polynomial invariant for knots via von Neumann algebras,” Bull. Amer. Math. Soc. **12**, 103–112.
- [43] D. Kaledin, “Derived equivalences by quantization,” arXiv:[math/0504584](https://arxiv.org/abs/math/0504584).
- [44] D. Kaledin, “Geometry and topology of symplectic resolutions,” arXiv:[math/0608143](https://arxiv.org/abs/math/0608143).
- [45] A. Kapustin and E. Witten, “Electric-Magnetic Duality And The Geometric Langlands Program,” Commun. Num. Theor. Phys. **1** (2007), arXiv:[hep-th/0604151](https://arxiv.org/abs/hep-th/0604151).
- [46] L. Katzarkov, M. Kontsevich, and T. Pantev, “Hodge theoretic aspects of mirror symmetry,” Proc. Symp. Pure Math. **78**, 87 (2008).

- [47] D. Kazhdan and G. Lusztig, “Tensor structures arising from affine Lie algebras. I–IV,” *J. Amer. Math. Soc.* 6 (1993), 905–947, 949–1011; 7 (1994), 355–381, 383–453.
- [48] M. Khovanov, “A categorification of the Jones polynomial,” *Duke Math. J.* 101 (2000), no. 3, 359–426.
- [49] M. Khovanov, “Link homology and categorification,” arXiv:[math/0605339](https://arxiv.org/abs/math/0605339).
- [50] M. Khovanov and A. D. Lauda, “A diagrammatic approach to categorification of quantum groups I,” arXiv:[0803.4121](https://arxiv.org/abs/0803.4121).
- [51] M. Khovanov and L. Rozansky, “Matrix factorizations and link homology,” arXiv:[math.QA/0401268](https://arxiv.org/abs/math.QA/0401268).
- [52] M. Khovanov and P. Seidel, “Quivers, Floer cohomology, and braid group actions,” *J. Amer. Math. Soc.* 15 (2002), no. 1, 203–271.
- [53] V. G. Knizhnik and A. B. Zamolodchikov, “Current Algebra and Wess–Zumino Model in Two-Dimensions,” *Nucl. Phys.* B247 (1984) 83.
- [54] T. Kohno, “Monodromy representations of braid groups and Yang–Baxter equations.” *Ann. Inst. Fourier* 37, 139–160 (1987).
- [55] M. Kontsevich, “Homological Algebra of Mirror Symmetry,” Chatterji, S. D. (eds) *Proceedings of the International Congress of Mathematicians, 1994*. Birkhäuser.
- [56] R. J. Lawrence, “Homology representations of braid groups,” D.Phil. Thesis, University of Oxford (June 1989).
- [57] R. J. Lawrence, “The homological approach applied to higher representations,” Harvard preprint (1990), available at <http://www.ma.huji.ac.il/~ruthel/>.
- [58] R. J. Lawrence, “A functorial approach to the one-variable Jones polynomial,” *J. Diff. Geom.* 37 (1993), 689–710.
- [59] R. Lipshitz, “A cylindrical reformulation of Heegaard Floer homology,” *Geom. Topol.*, 10:955–1097, 2006.
- [60] C. Manolescu, “Nilpotent slices, Hilbert schemes, and the Jones polynomial,” arXiv:[math/0411015](https://arxiv.org/abs/math/0411015).
- [61] D. Maulik and A. Okounkov, “Quantum groups and quantum cohomology”, 2018, arXiv:[1211.1287](https://arxiv.org/abs/1211.1287).
- [62] G. W. Moore and N. Seiberg, “Lectures on RCFT”, RU-89-32, YCTP-P13-89.
- [63] P. S. Ozsvath and Z. Szabo, “Holomorphic disks and three-manifold invariants”. *Ann. of Math.* Vol. 159 (2004), Issue 3, p 1027-1158, p 1159-1245.
- [64] P. S. Ozsvath and Z. Szabo, “Holomorphic disks, link invariants and the multi-variable Alexander polynomial”. *Algebr. Geom. Topol.* 8 (2008), 615–692.
- [65] P. S. Ozsvath and Z. Szabo, “Algebras with matchings and link Floer homology”. 2020, arXiv:[2004.07309](https://arxiv.org/abs/2004.07309).
- [66] J. A. Rasmussen, “*Floer homology and knot complements*”. PhD thesis, Harvard University, 2003.
- [67] N. Yu. Reshetikhin and V. G. Turaev, “Ribbon graphs and their invariants derived from quantum groups”. *Comm. Math. Phys.* 127 (1990), no. 1, 1–26.
- [68] R. Rouquier, “2-Kac–Moody algebras”. 2008, arXiv:[0812.5023](https://arxiv.org/abs/0812.5023).

- [69] V. Schechtman and A. Varchenko, "Arrangements of hyperplanes and Lie algebra homology". *Invent. Math.*, **106** (1991), 139–194.
- [70] V. Schechtman and A. Varchenko, "Quantum groups and homology of local systems". In *Algebraic Geometry and Analytic Geometry, ICM-90 Satellite Conference Proceedings*, pp. 182–197, Springer, 1991.
- [71] P. Seidel, "Fukaya categories and Picard–Lefschetz theory". *Zur. Lect. Adv. Math.* 10, European Mathematical Society, 2007, 292 pp.
- [72] P. Seidel and I. Smith, "A link invariant from the symplectic geometry of nilpotent slices". *Duke Math. J.* **134** (2006), no. 3, 453–514.
- [73] P. Seidel and J. P. Solomon, "Symplectic cohomology and q -intersection numbers". 2012, arXiv:[1005.5156](https://arxiv.org/abs/1005.5156).
- [74] P. Seidel and R. P. Thomas, "Braid group actions on derived categories of coherent sheaves". 2000, arXiv:[math/0001043](https://arxiv.org/abs/math/0001043).
- [75] A. Strominger, S. T. Yau, and E. Zaslow, "Mirror symmetry is T duality". *Nuclear Phys. B* **479** (1996), 243.
- [76] C. Teleman, "The structure of semi-simple field theory at higher genus". 2012, arXiv:[0712.0160](https://arxiv.org/abs/0712.0160).
- [77] R. P. Thomas, "Stability conditions and the braid group". 2006, arXiv:[math/0212214v5](https://arxiv.org/abs/math/0212214v5).
- [78] B. Webster, "Knot invariants and higher representation theory". 2015, arXiv:[1309.3796v3](https://arxiv.org/abs/1309.3796v3).
- [79] B. Webster, "Coherent sheaves and quantum Coulomb branches I: tilting bundles from integrable systems". 2019, arXiv:[1905.04623v2](https://arxiv.org/abs/1905.04623v2).
- [80] B. Webster, "Coherent sheaves and quantum Coulomb branches II: quiver gauge theories and knot homology" (to appear).
- [81] E. Witten, "Supersymmetry and Morse theory." *J. Differential Geom.* **17** (1982).
- [82] E. Witten, "Quantum field theory and the Jones polynomial". *Comm. Math. Phys.* **121** (1989), 351.
- [83] E. Witten, "On the structure of the topological phase of two-dimensional gravity." *Nuclear Phys. B* **340** (1990), 281–332.
- [84] E. Witten, "Fivebranes and knots". 2011, arXiv:[1101.3216v2](https://arxiv.org/abs/1101.3216v2).
- [85] E. Witten, "Khovanov homology and gauge theory". 2012, arXiv:[1108.3103v2](https://arxiv.org/abs/1108.3103v2).
- [86] E. Witten, "Two lectures on the Jones polynomial and Khovanov homology". 2014, arXiv:[1401.6996](https://arxiv.org/abs/1401.6996).
- [87] E. Witten, "Two lectures on gauge theory and Khovanov homology". 2017, arXiv:[1603.03854v2](https://arxiv.org/abs/1603.03854v2).

Mina Aganagic

Department of Mathematics, University of California, Berkeley

Center for Theoretical Physics, University of California, Berkeley, aganagic@berkeley.edu