

# Quantum algorithms and the power of forgetting

Andrew M. Childs, Matthew Coudron, and Amin Shiraz Gilani

Department of Computer Science, University of Maryland

Institute for Advanced Computer Studies, University of Maryland

Joint Center for Quantum Information and Computer Science, NIST/University of Maryland

## Abstract

The so-called welded tree problem provides an example of a black-box problem that can be solved exponentially faster by a quantum walk than by any classical algorithm [CCD<sup>+</sup>03]. Given the name of a special ENTRANCE vertex, a quantum walk can find another distinguished EXIT vertex using polynomially many queries, though without finding any particular path from ENTRANCE to EXIT. It has been an open problem for twenty years whether there is an efficient quantum algorithm for finding such a path, or if the path-finding problem is hard even for quantum computers. We show that a natural class of efficient quantum algorithms provably cannot find a path from ENTRANCE to EXIT. Specifically, we consider algorithms that, within each branch of their superposition, always store a set of vertex labels that form a connected subgraph including the ENTRANCE, and that only provide these vertex labels as inputs to the oracle. While this does not rule out the possibility of a quantum algorithm that efficiently finds a path, it is unclear how an algorithm could benefit by deviating from this behavior. Our no-go result suggests that, for some problems, quantum algorithms must necessarily forget the path they take to reach a solution in order to outperform classical computation.

## Contents

<b>1</b>	<b>Introduction</b>	<b>2</b>
<b>2</b>	<b>Genuine and rooted algorithms</b>	<b>5</b>
2.1	Genuine algorithms . . . . .	7
2.2	Rooted algorithms . . . . .	9
<b>3</b>	<b>Transcript states</b>	<b>9</b>
<b>4</b>	<b>Classical simulation of genuine, rooted algorithms</b>	<b>13</b>
4.1	Checking procedures . . . . .	13
4.2	Mapping addresses to vertices . . . . .	16
4.3	The classical algorithm . . . . .	19
4.4	The good, the bad, and the ugly . . . . .	20
4.5	Faithful simulation of the good part . . . . .	24
4.6	The state is mostly good . . . . .	36
<b>5</b>	<b>Hardness of classical cycle finding with a 3-color oracle</b>	<b>39</b>

# 1 Introduction

Quantum algorithms use interference of many branches of a superposition to solve problems faster than is possible classically. Shor’s factoring algorithm [Sho97] achieves a superpolynomial speedup over the best known classical algorithms by efficiently finding the period of a modular exponentiation function, and several other quantum algorithms (e.g., [Hal07, Ked06, EHKS14]) provide a speedup by similarly detecting periodic structures. While a few other examples of dramatic quantum speedup are known—notably including the simulation of quantum dynamics [Llo96]—our understanding of the capabilities of quantum algorithms remains limited. To gain more insight into the possible applications of quantum computers, we would like to better understand the kinds of problems they can solve efficiently and what features of problems they are able to exploit.

Another example of exponential quantum speedup is based on quantum analogs of random walks. Specifically, quantum walks provide an exponential speedup for the so-called welded tree problem [CCD<sup>+</sup>03]. The symmetries of this problem, and the structure of the quantum algorithm for solving it, seem fundamentally different from all preceding exponential quantum speedups. In particular, the welded tree problem provably requires polynomial “quantum depth” to solve efficiently [CM20], whereas all previously known exponential quantum speedups only require logarithmic quantum depth, including Shor’s factoring algorithm [CW00]. (The only other known computational problem exhibiting an exponential quantum speedup, yet requiring polynomial quantum depth, was recently constructed in [CCL20].)

The welded tree problem is defined on a “welded tree graph” that is formed by joining the leaves of two binary trees with a cycle that alternates between them, as shown in Figure 1. The root of one tree is designated as the ENTRANCE, and the root of the other tree is designated as the EXIT. The graph structure is provided through an oracle that gives adjacency-list access to the graph, where the vertices are labeled arbitrarily. Given the label of the ENTRANCE vertex and access to the oracle, the goal of the welded tree problem is to return the label of the EXIT vertex. On a quantum computer, this black box allows one to perform a quantum walk, whereby the graph is explored locally in superposition. Interference obtained by following many paths coherently causes the quantum walk to reach the EXIT in polynomial time. In contrast, no polynomial-time classical algorithm can efficiently find the EXIT—essentially because it cannot distinguish the welded tree graph from a large binary tree—so the quantum walk achieves exponential speedup.

While the quantum walk algorithm efficiently finds the EXIT by following exponentially many paths in superposition, it does not actually output any of those paths. Classical intuition might suggest that an efficient algorithm for finding the EXIT could be used to efficiently find a path by simply recording every intermediate state of the EXIT-finding algorithm. However, in general, the intermediate state of a quantum algorithm cannot be recorded without destroying superposition and ruining the algorithm. In other words, the welded tree problem can be viewed as a kind of multi-slit experiment that takes the well-known double-slit experiment into the high-complexity regime. This raises a natural question: Is it possible for some quantum algorithm to efficiently find a path from the ENTRANCE to the EXIT? This question already arose in the original paper on the welded tree problem [CCD<sup>+</sup>03] and has remained open since, recently being highlighted in a survey of Aaronson [Aar21].

In one attempt to solve this problem, Rosmanis studied a model of “snake walks”, which allow extended objects to move in superposition through graphs [Ros11]. The state of a snake walk is a superposition of “snakes” of adjacent vertices, rather than a superposition of individual vertices as in a standard quantum walk. While Rosmanis did not show conclusively that snake walks cannot find a path through the welded tree graph, his analysis suggests that a snake walk

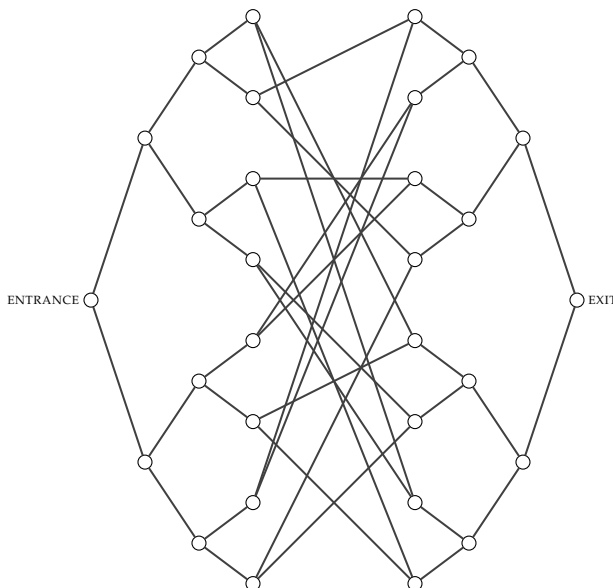

Figure 1: Example of a welded tree graph with  $n = 3$ .

algorithm is unlikely to accomplish this using only polynomially many queries to the welded tree oracle. Although this is only one particular approach, its failure supports the conjecture that it might not be possible to find a path efficiently. If such an impossibility result could be shown for general quantum algorithms, it would establish that, in order to find the solution to some computational problems, a quantum algorithm must necessarily “forget” the path it takes to that solution. While forgetting information is a common feature of quantum algorithms, which often uncompute intermediate results to facilitate interference, many algorithms are able to efficiently produce a classically verifiable certificate for the solution once they have solved the problem.<sup>1</sup> In contrast, hardness of path finding in the welded tree problem would show not only that trying to remember a path would cause one particular algorithm to fail, but in fact *no* algorithm can efficiently collect such information.

In this paper, we take a step toward showing hardness of the welded tree path-finding problem. Specifically, we show hardness under two natural assumptions that we formalize in [Section 2](#), namely that the algorithm is *genuine* and *rooted*.

First, we assume that the algorithm accesses the oracle for the input graph in a way that we call *genuine*. A genuine algorithm is essentially one that only provides meaningful vertex labels as inputs to the welded tree oracle. Both the ordinary quantum walk [[CCD<sup>+</sup>03](#)] and the snake walk [[Ros11](#)] can be implemented by genuine algorithms. It is hard to imagine how non-genuine algorithms could gain an advantage over genuine algorithms, but we leave further exploration of this topic for future work.

We also assume that the algorithm is *rooted*. Informally, a rooted algorithm is one that always maintains (i.e., remembers) a path from the ENTRANCE to every vertex appearing in its state. Note that the EXIT-finding algorithm of [[CCD<sup>+</sup>03](#)] is crucially *not* rooted. Nonetheless, it is natural to focus on rooted algorithms when considering the problem of path-finding, since a non-rooted path-finding algorithm would effectively have to detach from the ENTRANCE and later find it again. While we cannot rule out this possibility, it seems implausible. Although remembering

<sup>1</sup>For example, in Simon’s algorithm [[Sim97](#)], we learn the hidden string and can easily find collisions. In Shor’s algorithm [[Sho97](#)], the factors reveal the structure of the input number and their correctness can be easily checked.

a path to the ENTRANCE limits how quantum interference can occur, it does not eliminate interference entirely—in fact, rooted algorithms can exhibit exponential constructive and destructive interference. Furthermore, if the snake walk [Ros11] were to find a path from ENTRANCE to EXIT, the most natural way of doing so would be in a rooted fashion.

Our main result is that a genuine, rooted quantum algorithm cannot find a path from ENTRANCE to EXIT in the welded tree graph using only polynomially many queries. To establish this, we show that for any genuine, rooted quantum query algorithm  $\mathcal{A}$ , there is a classical query algorithm using at most polynomially more queries that can approximately sample from the output state of  $\mathcal{A}$  (measured in the computational basis) up to a certain error term  $|\psi_{\text{ugly}}\rangle$  (defined in Section 4.4). This error term can be intuitively described as the part of the superposition of rooted configurations that has ever encountered a cycle or the EXIT in the welded tree graph during the entire course of the algorithm. Because elements of a quantum superposition need not have a well-defined classical history, the precise definition of our error term is somewhat involved. Nonetheless, we are able to bound the sampling error of our efficient classical simulation of  $\mathcal{A}$  using an inductive argument.

We construct the classical simulation as follows. First, using exponential time and only a constant number of classical queries, the algorithm processes the circuit diagram of the genuine, rooted quantum algorithm and samples a “transcript” (defined in Section 3) that describes a computational path the quantum algorithm could have taken, neglecting the possibility of encountering a cycle or the EXIT. The classical algorithm then makes polynomially many queries to the classical oracle, in a manner prescribed by the sampled transcript, and outputs the vertices of the welded tree graph that were reached by those queries. We prove in Section 4 that this efficient classical query algorithm is almost as likely to find an ENTRANCE–EXIT path as the original genuine, rooted quantum algorithm. We do this by showing that the classical algorithm exactly simulates the part of the quantum state that does not encounter a cycle or the EXIT, and that the remaining error term,  $|\psi_{\text{ugly}}\rangle$ , is exponentially small. A major technical challenge is that our classical hardness result (shown in Section 5) does not immediately show that  $|\psi_{\text{ugly}}\rangle$  is small as it may be possible for a quantum algorithm to foil a classical simulation by computing and uncomputing a cycle, and “pretending” to have never computed it. We overcome this issue by considering the portions of the state that encounter a cycle at each step and inductively bounding their total mass.

A subtle—yet unexpectedly significant—detail in our analysis is that we consider a version of the welded tree problem in which the oracle provides a 3-coloring of the edges of the graph, instead of using a 9-coloring as in the lower bound of [CCD<sup>+</sup>03].<sup>2</sup> This alternative coloring scheme substantially reduces the complexity of the analysis in Sections 2 to 4. This is because it allows us to determine, with high probability, whether starting at the ENTRANCE and following the edges prescribed by a polynomial-length color sequence  $t$  will lead to a valid vertex of the welded tree graph, using only a constant number of classical queries to the welded tree oracle. In particular, it suffices to check whether  $t$  departs from the ENTRANCE along one of the two valid edges (which can be determined using only three queries to the oracle). This is a key property used in our argument that the transcript state (see Definition 15) can track much of the behavior of a genuine, rooted quantum algorithm while only making a small number of classical queries to the welded tree oracle.

However, our choice of the 3-coloring model comes at the cost of having to redesign the proof of classical hardness of finding the EXIT vertex in the welded tree graph. The original classical hardness proof [CCD<sup>+</sup>03] crucially considers a special type of 9-coloring with the property that,

---

<sup>2</sup>Note that the quantum walk algorithm can solve the welded tree problem using a 3-coloring, or even if it is not provided with a coloring at all [CCD<sup>+</sup>03].

starting from a valid coloring, the color of any edge can be altered arbitrarily, and only edges within distance 2 need to be re-colored to produce a valid coloring with that newly assigned edge color. This “local re-colorability” property is used at the crux of the classical hardness result, first in reducing from Game 2 to Game 3, and again implicitly in part (i) of the proof of Lemma 8 [CCD<sup>+</sup>03]. In contrast, a valid 3-coloring of the welded tree graph does not have this “local re-colorability” property: changing a single edge color might require a global change of many other edge colors to re-establish validity of the coloring. Thus we are forced to develop a modification of the classical hardness proof, given in Section 5, which may also be of independent interest.

Note that our hardness result for EXIT-finding in the 3-color model implies the hardness result for EXIT-finding in the colorless model of [CCD<sup>+</sup>03] (which is equivalent to a restricted class of locally-constructible 9-colorings), but not the other way around. This is because, a priori, the given 3-coloring could leak global information about the graph that the 9-coloring does not. On the other hand, our hardness result for EXIT-finding in the 3-color model combined with the analysis of Section 2 implies hardness of path finding for genuine, rooted algorithms in both the 3-color and 9-color models, as well as the colorless model.

While our result does not definitively rule out the possibility of an efficient quantum algorithm for finding a path from ENTRANCE to EXIT in the welded tree graph, it constrains the form that such an algorithm could take. In particular, it shows that the most natural application of a snake walk to the welded tree problem, in which the snake always remains connected to the ENTRANCE, cannot solve the problem. While it is conceivable that a snake could detach from the ENTRANCE and later expand to connect the ENTRANCE and EXIT, this seems unlikely. More generally, non-genuine and non-rooted behavior do not intuitively seem useful for solving the problem. We hope that future work will be able to make aspects of this intuition rigorous.

**Open questions** This work leaves several natural open questions. The most immediate is to remove the assumption of a rooted, genuine algorithm to show unconditional hardness of finding a path (or, alternatively, to give an efficient path-finding algorithm by exploiting non-genuine or non-rooted behavior). We also think it should be possible to show classical hardness of the general welded tree problem when the oracle provides a 3-coloring. Finally, it would be instructive to find a way of instantiating the welded tree problem in an explicit (non-black box) fashion, giving a quantum speedup in a non-oracular setting.

## 2 Genuine and rooted algorithms

In this section, we precisely define the aforementioned notion of genuine, rooted quantum query algorithms. Intuitively, an algorithm is genuine if it only allows for “meaningful” processing of vertex labels, and it is rooted if it remains “connected to the ENTRANCE” throughout its course. We begin by describing our setup and recalling the definition of the welded tree oracle.

**Definition 1** (Welded tree). *A graph  $\mathcal{G}_n$  is a welded tree of size  $n$  if it is formed by joining the  $2 \cdot 2^n$  leaves of two balanced binary trees of height  $n$  with a cycle that alternates between the two sets of leaves (as shown in Figure 1). Each vertex in  $\mathcal{G}_n$  is labeled by a  $2n$ -bit string.*

Henceforth, we refer to the input welded tree graph of size  $n$  as  $\mathcal{G}$ . We use  $\mathcal{V}_{\mathcal{G}}$  to denote the set of vertices of  $\mathcal{G}$ . Since  $\mathcal{G}$  is bipartite and each vertex  $v \in \mathcal{V}_{\mathcal{G}}$  has degree at most 3,  $\mathcal{G}$  can be edge-colored using only 3 colors [K616]. Therefore, we suppose that the edges of  $\mathcal{G}$  are colored from the set  $\mathcal{C} := \{\text{red, green, blue}\}$ . We define a classical oracle function  $\eta_{\mathcal{C}}: \{0, 1\}^{2n} \rightarrow \{0, 1\}^{2n}$

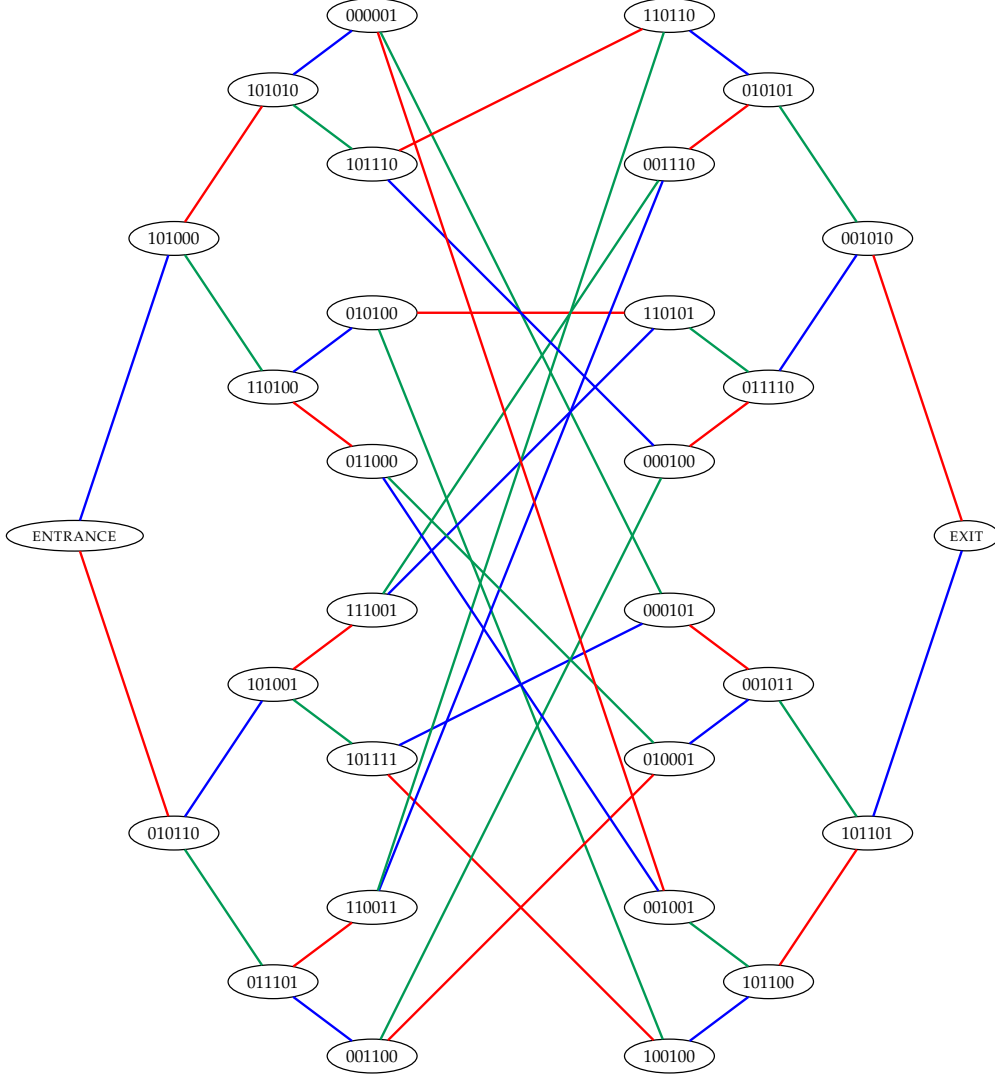

Figure 2: Example of a 3-colored labeled welded tree graph for  $n = 3$ .

that encodes the edges of color  $c \in \mathcal{C}$  in  $\mathcal{G}$ . Figure 2 shows a valid coloring and labeling of the welded tree graph from Figure 1.

**Definition 2** ( $\eta_c$ ). For any  $v \in \mathcal{V}_{\mathcal{G}}$  and  $c \in \mathcal{C}$ , let  $I_c(v)$  be the indicator variable that is 1 if the vertex labeled  $v$  has an edge colored  $c$  and 0 otherwise. If  $I_c(v) = 1$  for some  $v \in \mathcal{V}_{\mathcal{G}}$  and  $c \in \mathcal{C}$ , let  $N_c(v)$  be the label of the vertex joined to  $v$  with an edge of color  $c$ . Then

$$\eta_c(v) := \begin{cases} N_c(v) & v \in \mathcal{V}_{\mathcal{G}} \text{ and } I_c(v) = 1 \\ \text{NOEDGE} & v \in \mathcal{V}_{\mathcal{G}} \text{ and } I_c(v) = 0 \\ \text{INVALID} & v \notin \mathcal{V}_{\mathcal{G}}, \end{cases} \quad (1)$$

where NOEDGE and INVALID are special reserved strings in  $\{0,1\}^{2n} \setminus \mathcal{V}_{\mathcal{G}}$ . We also define  $\text{SpecialVertices} := \{0^{2n}, \text{ENTRANCE}, \text{EXIT}, \text{NOEDGE}, \text{INVALID}\}$ .

Since  $\mathcal{G}$  is 3-colored, for any vertex label  $v \in \mathcal{V}_{\mathcal{G}}$ ,  $I_c(v) = 0$  only if  $v \in \{\text{ENTRANCE}, \text{EXIT}\}$ . We now describe the spaces that our algorithms act on.

**Definition 3** (Vertex register and vertex space). A vertex register is a  $2n$ -qubit register that stores a vertex label. We consider quantum states that have exactly  $p(n)$  vertex registers, and refer to the  $2np(n)$ -qubit space consisting of all the vertex registers as the vertex space.

Any computational basis state in the vertex space stores  $p(n)$  vertex labels, corresponding to a subgraph of  $\mathcal{G}$ . A quantum algorithm can also store additional information using its workspace.

**Definition 4** (Workspace and workspace register). A workspace register is a single-qubit register that can store arbitrary ancillary states. We allow for arbitrarily many workspace registers, and refer to the space consisting of all workspace registers as the workspace.

## 2.1 Genuine algorithms

We now precisely describe the set of gates that we allow quantum query algorithms to employ for querying and manipulating the vertex labels in a meaningful way.

**Definition 5** (Genuine circuit). We say that a quantum circuit  $C$  is genuine if it is built from the following unitary gates.

1. Controlled-oracle query gates  $O_c$  for  $c \in \mathcal{C}$  where the control qubit is in the workspace, and  $O_c$  acts on the  $j$ th and  $k$ th vertex registers for some distinct  $j, k \in [p(n)] := \{1, \dots, p(n)\}$  as

$$O_c: |v_j\rangle|v_k\rangle \mapsto |v_j\rangle|v_k \oplus \eta_c(v_j)\rangle \quad (2)$$

where  $\eta_c$  is specified in [Definition 2](#).

Furthermore, in a genuine circuit,  $O_c$  can only be applied if  $v_k = 0^{2n}$  or  $v_k = \eta_c(v_j)$  for every  $v_j, v_k$  pair appearing in those respective registers in the superposition.

We let  $\wedge(A)$  denote a controlled- $A$  gate, so that  $\wedge(O_c)$  denotes the controlled- $O_c$  gate.

2. Controlled- $e^{i\theta T}$  rotations for any  $\theta \in [0, 2\pi)$  where the control qubit is in the workspace and the Hamiltonian  $T$  is defined, similarly to [\[CCD<sup>+</sup>03\]](#), to act on the  $j$ th and  $k$ th vertex registers for some distinct  $j, k \in [p(n)]$  as

$$T: |v_j\rangle|v_k\rangle \mapsto |v_k\rangle|v_j\rangle. \quad (3)$$

As per [part 1](#),  $\wedge(e^{i\theta T})$  denotes the controlled- $e^{i\theta T}$  gate.

3. Equality check gates  $\mathcal{E}$ , which act on the  $j$ th and  $k$ th vertex registers for some distinct  $j, k \in [p(n)]$ , and on the  $a$ th workspace register for some workspace index  $a$ , as

$$\mathcal{E}: |v_j\rangle|v_k\rangle|w_a\rangle \mapsto |v_j\rangle|v_k\rangle|w_a \oplus \delta[v_j = v_k]\rangle \quad (4)$$

where  $\delta[P]$  is 1 if  $P$  is true and 0 if  $P$  is false.

4. NOEDGE check gates  $\mathcal{N}$ , which act on the  $j$ th vertex register for some  $j \in [p(n)]$ , and on the  $a$ th workspace register for some workspace index  $a$ , as

$$\mathcal{N}: |v_j\rangle|w_a\rangle \mapsto |v_j\rangle|w_a \oplus \delta[v_j = \text{NOEDGE}]\rangle. \quad (5)$$

5. ZERO check gates  $\mathcal{Z}$ , which act on the  $j$ th vertex register for some  $j \in [p(n)]$ , and on the  $a$ th workspace register for some workspace index  $a$ , as

$$\mathcal{Z}: |v_j\rangle|w_a\rangle \mapsto |v_j\rangle|w_a \oplus \delta[v_j = 0^{2n}]\rangle. \quad (6)$$

6. Arbitrary two-qubit gates (or, equivalently, arbitrary unitary transformations) restricted to the workspace register.

We now define the notion of genuine algorithms using [Definition 5](#). Let  $O = \{O_c : c \in \mathcal{C}\}$  denote a particular randomly selected welded tree oracle, and let  $\mathcal{A}(O)$  denote a quantum algorithm that makes quantum queries to  $O$ .

**Definition 6** (Genuine algorithm). *We call a quantum query algorithm  $\mathcal{A}$  genuine if, for the given welded tree oracle  $O$ ,  $\mathcal{A}(O)$  acts on the vertex space and the workspace as follows.*

1.  $\mathcal{A}(O)$  begins with an initial state

$$|\psi_{\text{initial}}\rangle := |\text{ENTRANCE}\rangle \otimes (|0^{2n}\rangle)^{\otimes (p(n)-1)} \otimes |0\rangle_{\text{workspace}}. \quad (7)$$

2. Then, it applies a  $p(n)$ -gate genuine circuit  $C$  (as in [Definition 5](#)) on  $|\psi_{\text{initial}}\rangle$  to get the state  $|\psi_A\rangle$ .
3. Finally, it measures all the vertex registers of  $|\psi_A\rangle$  in the computational basis and outputs the corresponding vertex labels.

We focus on genuine algorithms because they are easier to analyze than fully general algorithms, but do not seem to eliminate features that would be useful in a path-finding algorithm. Genuine algorithms are only restricted in the sense that they cannot use vertex labels other than by storing them, acting on them with the input or output register of an oracle gate, performing phased swaps of the vertex label positions, and checking whether they are equal to zero or NOEDGE. Since the vertex labels are arbitrary and uncorrelated with the structure of the welded tree, it is hard to imagine how a general quantum algorithm could gain an advantage over genuine quantum algorithms by using the vertex labels in any other way.<sup>3</sup> Thus, genuine algorithms describe a natural class of strategies that should offer insight into the more general case.

We also emphasize that the only proposed algorithms for the welded tree problem (and the associated path-finding problem) are genuine. The only such algorithms we are aware of are the exit-finding algorithm of [\[CCD<sup>+</sup>03\]](#) and the snake-walk algorithm analyzed by Rosmanis [\[Ros11\]](#).

Intuitively, the EXIT-finding algorithm of [\[CCD<sup>+</sup>03\]](#) is genuine since it performs a quantum walk on the welded tree graph, and such a process does not depend on the vertex labels. More concretely, a close inspection of the EXIT-finding algorithm of [\[CCD<sup>+</sup>03\]](#) reveals that every gate in the algorithm is an allowed gate in [Definition 5](#) (even with the above minor modification). This means that the algorithm is genuine as per [Definition 6](#). (As a technical aside, note that the algorithm works with any valid coloring of the welded tree graph, so in particular, it works for our chosen 3-color model by simply limiting the set of colors in the algorithm.)

Similarly, in [\[Ros11\]](#), Rosmanis defines a quantum snake walk algorithm on a particular welded tree graph  $G$  to be a quantum walk on a corresponding “snake graph”  $G_\ell$ , which has one vertex for each distinct “snake” of length  $\ell$  in  $G$ . Here a “snake” of length  $\ell$  refers to a length- $\ell$  vector of consecutive vertices of  $G$ . Although it is more complicated to decompose this algorithm into the gates of [Definition 5](#), this can be done, showing that the snake walk algorithm is genuine. Furthermore, it is intuitive that the snake walk algorithm should not depend on the specific vertex labels simply because it is defined to be a quantum walk on  $G_n$ , a graph whose connectivity does not depend on the vertex labels of  $G$ .

---

<sup>3</sup>The proof that classical algorithms cannot efficiently find the EXIT effectively shows that classical algorithms cannot benefit from non-genuine behavior [\[CCD<sup>+</sup>03\]](#). While it seems harder to make this rigorous for quantum algorithms, similar intuition holds.



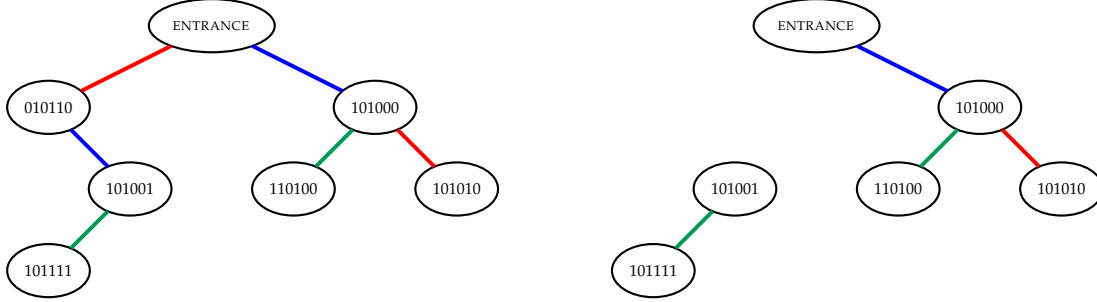

(a) Subgraph of Figure 2 corresponding to a state containing the vertex labels  $\{\text{ENTRANCE}, 010110, 101000, 101001, 101010, 101111, 110100\}$ .

(b) Subgraph of Figure 2 corresponding to a state containing the vertex labels  $\{\text{ENTRANCE}, 101000, 101001, 101010, 101111, 110100\}$ .

Figure 3: Examples of rooted and non-rooted states.

## 2.2 Rooted algorithms

We now define the notion of a rooted algorithm. Intuitively, a state in the vertex space is rooted if it corresponds to a set of labels of vertices from  $\mathcal{V}_G$  (and the NOEDGE and  $0^{2n}$  labels) that form a connected subgraph containing the ENTRANCE (neglecting the NOEDGE and  $0^{2n}$  labels, if present).

**Definition 7** (Rooted state). *We say that a computational basis state  $|\psi\rangle$  in the vertex space is rooted if ENTRANCE is stored in some vertex register of  $|\psi\rangle$  and, for any vertex label  $v$  stored in any of the vertex registers of  $|\psi\rangle$ ,*

1.  $v \in \mathcal{V}_G \cup \{0^{2n}, \text{NOEDGE}\}$ , and
2. if  $v \neq 0^{2n}$ , then there exist  $r$  vertex registers storing vertex labels  $v_{j_1}, \dots, v_{j_r}$  such that  $v_{j_1} = \text{ENTRANCE}$ ,  $v_{j_r} = v$ , and for each  $k \in [r-1]$ ,  $\eta_c(v_{j_k}) = v_{j_{k+1}}$  for some  $c \in \mathcal{C}$ .

Figure 3 shows examples of rooted and non-rooted states. We say that an algorithm is rooted if all its intermediate states are superpositions of rooted states.

**Definition 8** (Rooted algorithm). *A quantum query algorithm  $\mathcal{A}$  is rooted if, for the given welded tree oracle  $O$ , at each intermediate step of  $\mathcal{A}(O)$ , every computational basis state in the support of the vertex space of the quantum state maintained by  $\mathcal{A}$  is rooted.*

Non-rooted behavior can be useful for exploring the welded tree graph. In particular, the algorithm of [CCD<sup>+</sup>03] for finding the EXIT is not rooted, since it only maintains a single vertex (in superposition). However, a path-finding algorithm must store information about many vertices, and the value of detaching from the ENTRANCE is unclear since the algorithm must ultimately reattach. Note that the snake walk [Ros11] is initially rooted, the most natural way for it to find a path from ENTRANCE to EXIT is arguably to do so while remaining rooted, though the algorithm may become non-rooted if it is run for long enough.

## 3 Transcript states

For any genuine quantum query algorithm  $\mathcal{A}$  that makes  $p(n)$  oracle queries to the oracle  $O$  of the input welded tree  $\mathcal{G}$ , we associate a quantum state  $|\phi_{\mathcal{A}}\rangle$ , which we call the *transcript state* of  $\mathcal{A}(O)$ . As we will see in Definition 15 below, instead of storing the label of a vertex  $v$ , the transcript state  $|\phi_{\mathcal{A}}\rangle$  stores a path from the ENTRANCE to  $v$ . We refer to this path as the *address* of  $v$ , which we now define.

**Definition 9** (Vertex addresses). We say that a tuple  $t$  of colors from  $\mathcal{C}$  is an address of a vertex  $v$  of  $\mathcal{G}$  if  $v$  is reached by starting at the ENTRANCE and following the edge colors listed in  $t$ . For completeness, we assign special names ZEROADDRESS, NOEDGEADDRESS, and INVALIDADDRESS to denote the addresses of vertex labels  $0^{2^n}$ , NOEDGE, and INVALID, respectively. We denote the empty tuple by the special name EMPTYADDRESS. Let  $\text{SpecialAddresses} := \{\text{ZEROADDRESS}, \text{EMPTYADDRESS}, \text{NOEDGEADDRESS}, \text{INVALIDADDRESS}\}$ . We define

$$\text{Addresses} := \text{SpecialAddresses} \cup \bigcup_{i \in [p(n)]} \mathcal{C}^i \quad (8)$$

where  $\mathcal{C}^i$  denotes the set of all  $i$ -tuples of colors from  $\mathcal{C}$ .

Note that a given vertex can have many different associated addresses. Indeed, two addresses that differ by an even-length palindrome of colors are associated to the same vertex. Even greater multiplicity of addresses can occur because of the cycles in  $\mathcal{G}$ . We define the notion of the *address tree* to deal with the former issue, and we delay consideration of the latter issue. To define the address tree, we need to know the color  $c_*$  that does not appear at the ENTRANCE.

**Definition 10** (The missing color at the entrance). Let  $c_* \in \mathcal{C}$  be the unique color such that there is no edge of color  $c_*$  incident to the ENTRANCE in  $\mathcal{G}$ .

**Definition 11** (Address tree). The address tree  $\mathcal{T}$  (see [Figure 4](#)) is a binary tree of depth  $p(n)$  with 3 additional vertices.<sup>4</sup> Its vertices and edges are labeled by addresses and colors, respectively, as follows. The 3 additional vertices are labeled by each address in  $\text{SpecialAddresses} \setminus \{\text{EMPTYADDRESS}\}$ . The root of  $\mathcal{T}$  is labeled by EMPTYADDRESS. It is joined to the vertex labeled NOEDGEADDRESS by a directed edge of color  $c_*$ , and to 2 other vertices, each by an undirected edge of a distinct color from  $\mathcal{C} \setminus \{c_*\}$ . For each color  $c \in \mathcal{C}$ , the vertices labeled ZEROADDRESS and NOEDGEADDRESS have a directed edge colored  $c$  to the vertex labeled INVALIDADDRESS. The vertex labeled INVALIDADDRESS also has 3 self-loop edges, each of a distinct color from  $\mathcal{C}$ . Every other vertex in  $\mathcal{T}$  is joined to 3 other vertices, each by an undirected edge of a distinct color from  $\mathcal{C}$ . Every vertex  $t$  of  $\mathcal{T}$  whose label is not in  $\text{SpecialAddresses}$  is labeled by the sequence of colors that specifies the (shortest) path from EMPTYADDRESS to  $t$  in  $\mathcal{T}$ . For any vertex  $t$  of  $\mathcal{T}$ , let  $\lambda_c(t)$  be the vertex that is joined to  $t$  by an edge of color  $c$  in  $\mathcal{T}$ .

The following simple observations about the address tree  $\mathcal{T}$  may be instructive.

- Since the 3-coloring of  $\mathcal{T}$  is a valid coloring, no vertex label of  $\mathcal{T}$  contains an even-length palindrome.
- Beginning at the vertex labeled EMPTYADDRESS and traversing any sequence of colors in  $\mathcal{T}$  leads to some vertex of  $\mathcal{T}$ . Therefore, in the definition of the transcript state ([Definition 15](#)), and hence in the algorithm analyzed in [Section 4](#), the addresses that we consider are valid labels of vertices in  $\mathcal{T}$ , by construction.
- The color  $c_*$  can be computed with 2 queries to the oracle  $O$ . Therefore, the entire address tree can be computed with only 2 queries to  $O$ .

Intuitively, the transcript state  $|\phi_{\mathcal{A}}\rangle$  is the state that results from running the algorithm  $\mathcal{A}$  on the address tree  $\mathcal{T}$  instead of the actual welded tree graph  $\mathcal{G}$ . If  $\mathcal{A}$  does not explore cycles in  $\mathcal{G}$  to a significant extent, then  $|\phi_{\mathcal{A}}\rangle$  should be a good approximation of the state  $|\psi_{\mathcal{A}}\rangle$  produced by

---

<sup>4</sup>The address tree is not technically a tree, but we use this name since it contains no non-trivial cycles.

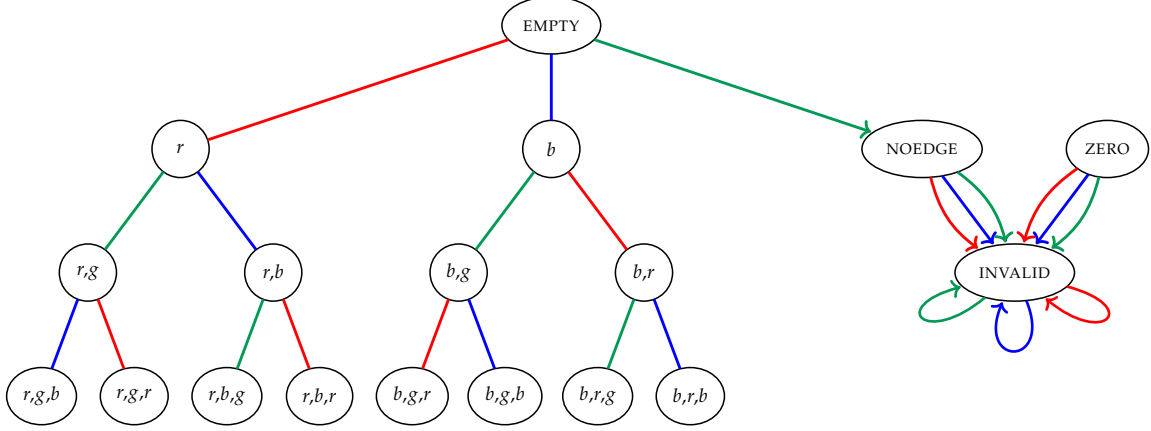

Figure 4: Address tree  $\mathcal{T}$  of depth 3 corresponding to the graph in Figure 2. For the sake of brevity, we have removed the suffix ADDRESS for all the addresses in SpecialAddresses and the tuple brackets for all the addresses not in SpecialAddresses. Notice that, for each vertex, there is an edge (either directed or undirected) of each color outgoing from each vertex in  $\mathcal{T}$ .

running  $\mathcal{A}$  on  $\mathcal{G}$ , as in Definition 6. In Section 4, we show that this is indeed the case for any genuine, rooted quantum algorithm  $\mathcal{A}$ .

Now we define a mapping  $B$  that turns addresses into strings, and another mapping  $B^{\text{inv}}$  that turns strings into addresses, such that  $B^{\text{inv}}$  is the inverse of  $B$  on the range of  $B$ . In our analysis, the registers we consider can never contain any string that is not in the range of the  $B$  mapping. Therefore, it is sufficient to define  $B^{\text{inv}}$  over the range of  $B$ . Nevertheless, we define  $B^{\text{inv}}$  over  $\{0, 1\}^{2p(n)}$  for the sake of completeness.

**Definition 12** (*B mapping*). Let  $\mathcal{V}_{\mathcal{T}}$  denote the set of labels of vertices of the address tree  $\mathcal{T}$ . Let  $S$  be a subset of  $\{0, 1\}^{2p(n)}$  of size  $|\mathcal{V}_{\mathcal{T}}|$  containing  $0^{2p(n)}$ . Let EMPTYSTRING, NOEDGESTRING, and INVALIDSTRING be any distinct fixed strings in  $S \setminus \{0^{2p(n)}\}$ . Then  $B: \mathcal{V}_{\mathcal{T}} \rightarrow S$  is a bijection mapping ZEROADDRESS to  $0^{2p(n)}$ , EMPTYADDRESS to EMPTYSTRING, NOEDGEADDRESS to NOEDGESTRING, and INVALIDADDRESS to INVALIDSTRING. We define the function  $B^{\text{inv}}: \{0, 1\}^{2p(n)} \rightarrow \mathcal{V}_{\mathcal{T}}$  as

$$B^{\text{inv}}(s) := \begin{cases} B^{-1}(s) & s \in S \\ \text{INVALIDADDRESS} & \text{otherwise.} \end{cases} \quad (9)$$

We now define analogs of the spaces introduced in Definitions 3 and 4 that our transcript state (Definition 15) lies in and that our classical simulation algorithm (Algorithm 2) acts on.

**Definition 13** (*Address register and address space*). An address register is a  $2p(n)$ -qubit register storing bit strings that are the image, under the map  $B$ , of the address of some vertex label in the address tree  $\mathcal{T}$ . We consider quantum states that have exactly  $p(n)$  address registers, and refer to the  $2p(n)^2$ -qubit space of all the address registers as the address space.

**Definition 14** (*Address workspace and address workspace register*). An address workspace register is a single-qubit register that stores arbitrary ancillary states. We allow arbitrarily many address workspace registers, and refer to the space consisting of all address workspace registers as the address workspace.

Notice the similarity between the definitions of workspace and address workspace. Indeed, we will later observe that the projection of  $|\psi_{\mathcal{A}}\rangle$  on the workspace is the same as the projection of

the transcript state on the address workspace in the subspace not containing the EXIT or a cycle. We are now ready to state the definition of the transcript state  $|\phi_A\rangle$  associated with the quantum state  $|\psi_A\rangle$ .

**Definition 15** (Transcript state). *Consider a  $p(n)$ -query genuine, rooted quantum algorithm  $A$ . Given a circuit  $C$  that implements  $A$ , acting on the vertex space and the workspace, let  $\tilde{C}$  be the quantum circuit that acts on the address space and the address workspace, obtained by the following procedure.<sup>5</sup>*

1. Determine  $c_*$  using two queries to the oracle  $O$ .
2. Replace each vertex register with an address register and each workspace register with an address workspace register. Replace the initial state used in the genuine algorithm (recall [Definition 6](#)) with the new initial state

$$|\phi_{\text{initial}}\rangle := |\text{EMPTYSTRING}\rangle \otimes \left( |0^{2p(n)}\rangle \right)^{\otimes (p(n)-1)} \otimes |0\rangle_{\text{addressworkspace}}. \quad (10)$$

In [parts 3 to 8](#) below, we describe gates that act on the address space analogously to how the gates in [Definition 5](#) act on the vertex space. For any vertex  $v \in \mathcal{V}_g$ , we write  $s_v \in \{0, 1\}^{2p(n)}$  to denote the contents of the address register corresponding to the vertex register storing  $v$ . The transcript state is produced by the unitary operation that results by replacing each vertex-space gate in the quantum algorithm  $A$  with the corresponding address-space gate defined below.

3. Replace any controlled-oracle gate in  $C$  (controlled on workspace register  $a$  and acting on vertex registers  $j$  and  $k$ ) with controlled- $\tilde{O}_c$  (controlled on address workspace register  $a$  and acting on address registers  $j$  and  $k$ ), where

$$\tilde{O}_c: |s_j\rangle|s_k\rangle \mapsto |s_j\rangle|s_k \oplus B(\lambda_c(B^{\text{inv}}(s_j)))\rangle. \quad (11)$$

4. Replace any controlled- $e^{i\theta T}$  gate in  $C$  (controlled on workspace register  $a$  and acting on vertex registers  $j$  and  $k$ ) with a controlled- $e^{i\theta \tilde{T}}$  gate (controlled on address workspace register  $a$  and acting on address registers  $j$  and  $k$ ), where

$$\tilde{T}: |s_j\rangle|s_k\rangle \mapsto |s_k\rangle|s_j\rangle. \quad (12)$$

5. Replace any equality check gate  $\mathcal{E}$  in  $C$  (controlled on vertex registers  $j$  and  $k$  and acting on workspace register  $a$ ) with  $\tilde{\mathcal{E}}$  (controlled on address registers  $j$  and  $k$  and acting on address workspace register  $a$ ), where

$$\tilde{\mathcal{E}}: |s_j\rangle|s_k\rangle|w_a\rangle \mapsto |s_j\rangle|s_k\rangle|w_a \oplus \delta[s_j = s_k]\rangle. \quad (13)$$

6. Replace any NOEDGE-check gate  $\mathcal{N}$  in  $C$  (controlled on vertex register  $j$  and acting on workspace register  $a$ ) with  $\tilde{\mathcal{N}}$  (controlled on address register  $j$  and acting on address workspace register  $a$ ), where

$$\tilde{\mathcal{N}}: |s_j\rangle|w_a\rangle \mapsto |s_j\rangle|w_a \oplus \delta[s_j = \text{NOEDGESTRING}]\rangle. \quad (14)$$

7. Replace any ZERO-check gate  $\mathcal{Z}$  in  $C$  (controlled on vertex register  $j$  and acting on workspace register  $a$ ) with  $\tilde{\mathcal{Z}}$  (controlled on address register  $j$  and acting on address workspace register  $a$ ), where

$$\tilde{\mathcal{Z}}: |s_j\rangle|w_a\rangle \mapsto |s_j\rangle|w_a \oplus \delta[s_j = 0^{2p(n)}]\rangle. \quad (15)$$

---

<sup>5</sup>Notice that the time complexity of this procedure is linear in the size of the circuit  $C$ .

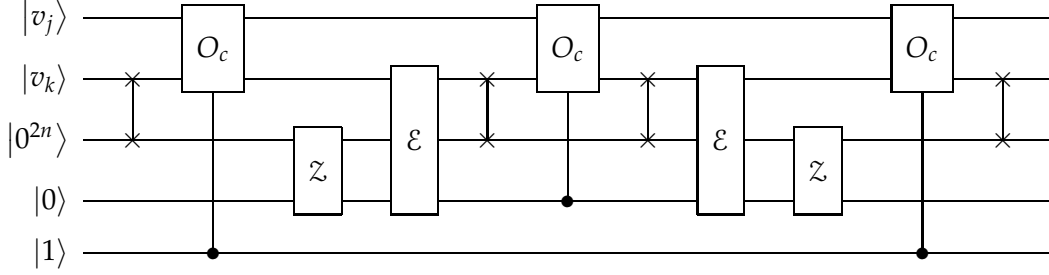

Figure 5: Circuit diagram for checking whether  $v_k \in \{0^{2n}, \eta_c(v_j)\}$ . The top three registers (i.e., those initialized with  $|v_j\rangle$ ,  $|v_k\rangle$ , and  $|0^{2n}\rangle$ , respectively) are vertex registers and the bottom two (i.e., those initialized with  $|0\rangle$  and  $|1\rangle$ , respectively) are workspace registers.

8. Leave gates acting on the workspace unchanged.

The transcript state  $|\phi_A\rangle$  is obtained by applying the circuit  $\tilde{C}$  to the string  $\text{EMPTYSTRING} = B(\text{EMPTYADDRESS})$ , together with  $p(n) - 1$  ancilla address registers storing  $0^{2p(n)} = B(\text{ZEROADDRESS})$ . In other words,

$$|\phi_A\rangle := \tilde{C}|\phi_{\text{initial}}\rangle. \quad (16)$$

Notice that whereas  $C$  updates the vertex registers by making many oracle queries to  $O$ , the circuit  $\tilde{C}$  only makes two queries to  $O$ .

## 4 Classical simulation of genuine, rooted algorithms

We now describe a classical algorithm for simulating genuine, rooted quantum algorithms. We begin in Section 4.1 by describing procedures for checking that the behavior of a quantum algorithm is genuine and rooted. While these procedures have no effect on a quantum algorithm with those properties, they enforce properties of the transcript state that are useful in our analysis. Then, in Section 4.2, we describe a mapping that sends states in the address space to states in the vertex space, which is used to describe our simulation algorithm in Section 4.3. In Section 4.4, we decompose the state into components that assist in our analysis. We show in Section 4.5 that the ‘good’ part of the state of a genuine, rooted algorithm is related, via the mapping  $L$  defined in Definition 24, to the ‘good’ part of the state of our simulation at each intermediate step. Finally, we establish in Section 4.6 (using the result of Section 5) that no genuine, rooted quantum algorithm can find an ENTRANCE–EXIT path (or a cycle) with more than exponentially small probability.

### 4.1 Checking procedures

First note that we can efficiently check whether, for an oracle query  $\wedge(O_c)$  with the input vertex register storing  $|v_j\rangle$ , the output vertex register contains  $0^{2n}$  or  $\eta_c(v_j)$ . Indeed, we can replace each oracle query gate  $O_c$  with the circuit shown in Figure 5 (where the entire circuit is controlled on the control register of  $O_c$  in the workspace), which uses a constant number of gates from Definition 5. The swap gates need not be explicitly performed, and are included only so that all the wires that a certain gate acts on are adjacent. The last workspace register is used to apply uncontrolled- $O_c$  gates. In this circuit, the center oracle gate  $O_c$  is only applied on the registers storing  $|v_j\rangle$  and  $|v_k\rangle$

if the first workspace register stores a 1, which happens only when  $v_k = 0^{2n}$  or  $v_k = \eta_c(v_j)$  by the definitions of the ZERO check gate  $\mathcal{Z}$  and the equality check gate  $\mathcal{E}$ . Since we are promised that the output register of any oracle gate satisfies [part 1 of Definition 5](#), replacing each controlled-oracle gate in any given genuine circuit  $C$  with the gadget of [Figure 5](#) does not impact the output state of  $C$ , while only increasing the circuit size by a constant factor.

*Remark 16* (Checking genuineness). Given any genuine circuit  $C$  with  $|C|$  gates, one can efficiently construct a genuine circuit  $C'$  consisting of  $O(|C|)$  gates such that  $C'$  has the same functionality as  $C$  and verifies the condition stated after [eq. \(2\) in part 1 of Definition 5](#) before applying each oracle call  $O_c$ . Therefore, we assume without loss of generality that the given genuine circuit  $C$  has built-in gadgets that verify this condition.

The consequence of [Definition 15](#) and [Remark 16](#) is a crucial observation about transcript states, which will turn out to be useful in our analysis in [Section 4](#).

**Lemma 17.** *For any given rooted genuine circuit  $C$ , any string stored in any computational basis state in the support of the address space of the state  $\tilde{C}|\phi_{\text{initial}}\rangle$  is in the range of  $B$ .*

*Proof.* Recall from [Remark 16](#) that the given genuine circuit  $C$  has built-in gadgets described by [Figure 5](#) that verify the condition asserted in [part 1 of Definition 5](#). Since we construct  $\tilde{C}$  from  $C$  by a gate-by-gate process, we apply an oracle gate  $\tilde{O}_c$  if the target register in the workspace of the gates  $\tilde{\mathcal{Z}}$  and  $\tilde{\mathcal{E}}$  just before the gate  $\wedge(\tilde{O}_c)$  (as in [Figure 5](#)) is in the state  $|1\rangle$ . Therefore, by the definition of the  $\tilde{\mathcal{Z}}$  and  $\tilde{\mathcal{E}}$  gates, the oracle gate  $\wedge(\tilde{O}_c)$  acting on address registers storing  $|s_j\rangle$  and  $|s_k\rangle$  is only applied when  $s_k = 0^{2p(n)}$  or  $s_k = B(\lambda_c(B^{\text{inv}}(s_j)))$  (and the control qubit of  $\wedge(\tilde{O}_c)$  in the address workspace is in the state  $|1\rangle$ ). Notice that all the other gates in [Definition 15](#) either do not alter the address registers at all or shuffle their positions without changing the address strings stored. It follows that no gate from [Definition 15](#) will introduce address labels that are not in the range of the  $B$  mapping defined in [Definition 12](#). Since  $|\phi_{\text{initial}}\rangle$  does not store any address labels not in the range of  $B$ , applying the circuit  $\tilde{C}$  to  $|\phi_{\text{initial}}\rangle$  will not generate address labels outside the range of  $B$ .  $\square$

We can use a similar approach to efficiently modify a given quantum query algorithm to ensure that its state is always rooted. This modification will be useful for the analysis in [Sections 4.4](#) and [4.5](#).

In particular, we claim that given a genuine, rooted algorithm associated with a circuit  $C$ , one can efficiently construct a modified genuine, rooted algorithm associated with a circuit  $C'$ , with each gate  $G$  in  $C$  replaced by a sequence of gates in  $C'$ , ensuring that  $G$  is only applied if the resulting state after applying  $G$  would have been rooted, with a polynomial overhead in circuit size and no impact on the resulting state. Recall that (controlled) oracle gates are the only genuine gates that can alter the contents of vertex registers. This means that we only need to replace  $G$  with this sequence of gates if  $G$  is an oracle gate. Moreover, by [Definition 7](#), to verify that a given state is rooted, we only need to check that the vertex registers not storing  $0^{2n}$  and NOEDGE labels form a connected subgraph of  $\mathcal{G}$  containing the ENTRANCE. We now describe a rooted algorithm that accomplishes this task and argue how it can be implemented by a genuine circuit.

First, note that at the beginning of the circuit  $C$ , one can copy the label of the ENTRANCE (which is stored in the first register of  $|\psi_{\text{initial}}\rangle$ ) to an ancilla vertex register that is not meant to be used by any of the gates that follow. This step can be implemented by a genuine algorithm by querying a valid neighbor of the ENTRANCE and then computing the ENTRANCE in this special ancilla vertex register before uncomputing this neighbor of the ENTRANCE. Similarly, we can uncompute the contents of the special ancilla vertex register at the end of our algorithm. Thus, we can make sure

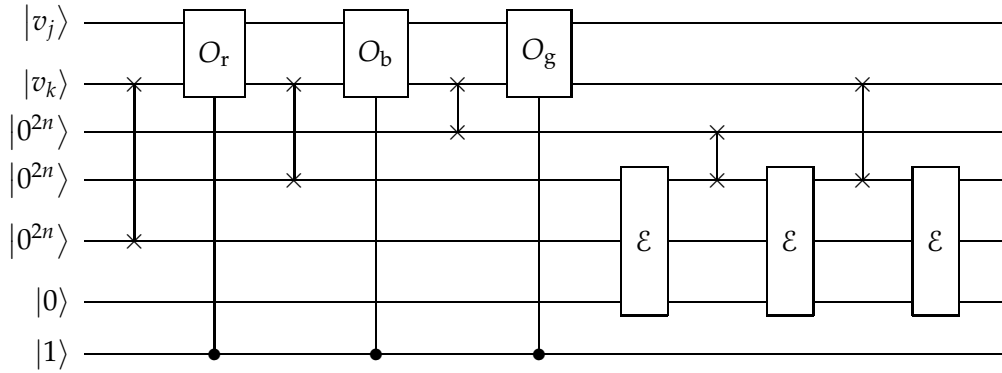

Figure 6: Circuit diagram for computing in an ancilla workspace register whether  $v_j = \eta_c(v_k)$  for some  $c \in \mathcal{C}$ . The top five registers are vertex registers and the bottom two registers are workspace registers. For compactness, we write  $O_r$ ,  $O_b$ , and  $O_g$  for  $O_{\text{red}}$ ,  $O_{\text{blue}}$ , and  $O_{\text{green}}$ , respectively.

that the ENTRANCE label is always stored in a vertex register of any computational basis state in the support of our state at any step.

Given a computational basis state consisting of  $p(n)$  vertex registers, by a standard breadth-first search procedure starting at the ENTRANCE, one can check whether the subgraph  $G$  of  $\mathcal{G}$  induced by the vertex labels stored in these registers is connected. At each step of this breadth-first search, we determine which vertex registers store the neighbors of a particular vertex  $v$ . This can be done by looping over each vertex register, checking whether it stores a neighbor of  $v$  and storing the outcome in a workspace register. Therefore, the task of checking the connectivity of  $G$  is reduced to the task of checking whether two input vertex registers store labels of vertices that are neighbors in  $\mathcal{G}$  and storing this in a workspace register.

We show a genuine circuit for this procedure in Figure 6. The swap gates and the workspace register initialized to  $|1\rangle$  have the same roles as in Figure 5. Given vertex labels  $v_j$  and  $v_k$ , we first compute each of the 3 neighbors of  $v_j$  in 3 different ancilla vertex registers. Then, we check whether any of these vertices are equal to  $v_k$  using equality check gates  $\mathcal{E}$ , and compute the output in an ancilla workspace register. By the end of this circuit, this workspace register will store 1 if and only if  $v_j$  and  $v_k$  are neighbors. Once we have used this workspace qubit to apply a controlled oracle gate, we uncompute the contents of this qubit by applying the circuit in Figure 6 backwards.

Now that we have outlined a procedure for checking rootedness of a given state, we describe a procedure for implementing each controlled oracle query gate  $O_c$  while maintaining rootedness. We first compute the output of  $O_c$  in an ancilla vertex register. Then we determine whether  $O_c$  is meant to uncompute the contents of a particular vertex register. We check this using an equality check gate applied on the ancilla vertex register and the target register of  $O_c$ . If  $O_c$  is not meant to uncompute a vertex register, then applying it cannot result in a non-rooted state. If  $O_c$  performs an uncomputation, we check rootedness of the collection of vertex registers not including the target register of  $O_c$ . We then apply  $O_c$  controlled on the output of this check and uncompute all the information we computed in ancilla vertex and workspace registers. This sequence of gates never results in a non-rooted state and does not alter the output state of a genuine, rooted algorithm. Thus we have the following.

*Remark 18 (Checking rootedness).* Given any genuine circuit  $C$  with  $|C|$  gates, one can efficiently construct a rooted genuine circuit  $C'$  consisting of  $\text{poly}(|C|)$  gates such that  $C'$  has the same functionality as  $C$  and before applying each gate  $G$ ,  $C'$  checks whether the resulting state will remain

rooted after the application of  $G$ . Therefore, we assume without loss of generality that the given rooted genuine circuit  $C$  has built-in rootedness check gadgets.

Analogous to the notion of a rooted state defined in [Definition 7](#), we define the notion of an address-rooted state as follows. Informally, a state in the address space is address rooted if, when it contains a string that encodes an address, it also contains the string that encodes its parent in  $\mathcal{T}$ .

**Definition 19** (Address-rooted state). *We say that a computational basis state  $|\phi\rangle$  in the address space is address rooted if for any string  $s$  stored in any of the registers of  $|\phi\rangle$ , whenever the vertex  $B^{\text{inv}}(s) \in \mathcal{V}_{\mathcal{T}}$  has a parent  $t \neq \text{ZEROADDRESS}$ , there exists a register of  $|\phi\rangle$  that stores the string  $B(t)$ .*

Now we show, using [Remark 18](#), that the notion of address rooted for states in the address space is analogous to the notion of rooted for states in the vertex space. This result substantially simplifies the analysis in [Section 4](#).

**Lemma 20.** *For any given rooted genuine circuit  $C$ , any computational basis state in the support of the address space of the state  $\tilde{C}|\phi_{\text{initial}}\rangle$  is address rooted.*

*Proof.* Recall from [Remark 18](#) that we assumed the given circuit has built-in rootedness check gadgets that only apply a gate  $G$  if the resulting state is guaranteed to be rooted. Since  $|\phi_{\text{initial}}\rangle$  stores the `EMPTYSTRING` label (instead of the `ENTRANCE` label stored in  $|\psi_{\text{initial}}\rangle$ ), the first step of the procedure outlined above [Remark 18](#) ensures that `EMPTYADDRESS` is always stored in some register of every computational basis state at every step of our transcript state. Note that the analog of the circuit in [Figure 6](#) in the address space (constructed as per [Definition 15](#)) checks whether the addresses corresponding to two strings are neighbors in  $\mathcal{T}$ . Thus, the analog in the address space of the above procedure to check rootedness of a given state checks whether a given computational basis state in the address space corresponds to a subtree of  $\mathcal{T}$  containing the `EMPTYSTRING` in one of its registers. Since  $\mathcal{T}$  is a tree, this check is equivalent to checking whether the given state is address rooted by [Definition 19](#).

As per the above procedure, before applying a  $\wedge(\tilde{O}_c)$  gate on a computational basis state  $|\phi\rangle$  controlled on a register storing  $s_j$  with the target register storing  $s_k$ , we first check whether it is an uncomputation (i.e.,  $s_k = B\lambda_c B^{\text{inv}}(s_j)$ ) via the  $\tilde{E}$  gate. If this check passes, we apply the  $\wedge(\tilde{O}_c)$  gate only after verifying that the resulting state (i.e.,  $|\phi\rangle$  with  $s_k$  replaced with  $0^{2p(n)}$ ) would be address rooted, analogous to the procedure preceding [Remark 18](#). Thus, the address rootedness of our state is ensured in this case. If this check fails, then we know, by the proof of [Lemma 17](#), that  $s_k = 0^{2p(n)}$ . In this case, the resulting state (i.e.  $|\phi\rangle$  with  $s_k$  replaced with  $B\lambda_c B^{\text{inv}}(s_j)$ ) corresponds to a connected sub-tree of  $\mathcal{T}$  containing the `EMPTYSTRING` (as  $|\phi\rangle$  is a connected sub-tree of  $\mathcal{T}$  containing the `EMPTYSTRING` and  $s_j$  is stored in some register of  $|\phi\rangle$ ) so will be address rooted.  $\square$

## 4.2 Mapping addresses to vertices

We now define an efficiently computable function  $L'$  that maps an address  $t$  to a corresponding vertex label  $v$ , and observe some relationships of addresses and the vertices they map to under  $L'$ . For  $t \in \{\text{ZEROADDRESS}, \text{INVALIDADDRESS}\}$ , this function simply outputs the corresponding vertex label. Otherwise, the image of  $t$  under  $L'$  is obtained by performing a sequence of oracle calls to determine the vertices reached by following edges of the colors specified by  $t$ , and outputting the vertex label reached at the end of that sequence. More precisely,  $L'(t)$  is computed as follows.



---

**Algorithm 1:** Classical query algorithm for computing  $L'(t)$ 

---

**Input:** An address  $t$   
**Output:** A vertex label  $v$

```
1 if  $t = \text{ZEROADDRESS}$  then
2   | return  $0^{2n}$ 
3 if  $t = \text{INVALIDADDRESS}$  then
4   | return  $\text{INVALID}$ 
5  $v \leftarrow \text{ENTRANCE};$ 
6 for  $i = 1 \dots |t|$  do
7   |  $v \leftarrow \eta_{t[i]}(v);$ 
8 return  $v;$ 
```

---

Here  $|t|$  denotes the length of the address  $t$  (the number of colors in its color sequence) and  $t[i]$  denotes the  $i$ th color. We now consider immediate implications of the definition of  $L'$  in [Algorithm 1](#). We begin with the following lemma, which states that any address of  $\text{ENTRANCE}$  that is not the  $\text{EMPTYADDRESS}$  encodes a cycle in  $\mathcal{G}$ .

**Lemma 21.** *Let  $t \neq \text{EMPTYADDRESS}$  be such that  $L'(t) = \text{ENTRANCE}$ . Then traversing the edge colors listed in  $t$  beginning from the  $\text{ENTRANCE}$  yields a cycle in  $\mathcal{G}$ .*

*Proof.* Since  $L'(t) = \text{ENTRANCE}$  and  $t \neq \text{EMPTYADDRESS}$ , we know that  $t \notin \text{SpecialAddresses}$ . Therefore,  $t$  can be written as a sequence of edge colors. As noted earlier, this sequence of colors does not contain any even-length palindrome. This means beginning at the  $\text{ENTRANCE}$  in  $\mathcal{G}$  and following the edge colors listed in  $t$  does not involve any backtracking. Moreover, as  $L'(t) = \text{ENTRANCE}$ , traversing this sequence of colors results in reaching the  $\text{ENTRANCE}$ . Therefore, this sequence in  $\mathcal{G}$  starting and ending at  $\text{ENTRANCE}$  forms a cycle.  $\square$

We can generalize [Lemma 21](#) to show that any two distinct addresses of any vertex label in  $\mathcal{V}_{\mathcal{G}} \cup \text{SpecialVertices}$  together encode the address of the  $\text{EXIT}$  or a cycle in  $\mathcal{G}$ .

**Lemma 22.** *Let  $t$  and  $t'$  be addresses with  $t \neq t'$  and  $L'(t) = L'(t')$ . If  $L'(t) = L'(t') \notin \text{SpecialVertices}$ , then beginning from the  $\text{ENTRANCE}$  in  $\mathcal{G}$  and following the edge colors listed in  $t$  in order and then following the edge colors listed in  $t'$  in reverse order forms a path that contains a non-trivial cycle in  $\mathcal{G}$ . Otherwise, there is a  $\tau \in \{t, t'\}$  such that beginning from the  $\text{ENTRANCE}$  in  $\mathcal{G}$  and following the edge colors listed in  $\tau$  will result in either reaching the  $\text{EXIT}$  or forming a path that contains a cycle in  $\mathcal{G}$ .*

*Proof.* Let  $v = L'(t) = L'(t')$ . We consider six cases:

1.  $v = 0^{2n}$ . By [Algorithm 1](#),  $\tau = \text{ZEROADDRESS}$  is the only address  $\tau$  such that  $L'(\tau) = 0^{2n}$ . Therefore,  $t = t' = \text{ZEROADDRESS}$ , so this case is not possible.
2.  $v = \text{ENTRANCE}$ . Since  $t \neq t'$ , either  $t \neq \text{EMPTYADDRESS}$  or  $t' \neq \text{EMPTYADDRESS}$ . In either case, the result follows from [Lemma 21](#).
3.  $v = \text{EXIT}$ . Then for both  $\tau \in \{t, t'\}$ , beginning from the  $\text{ENTRANCE}$  in  $\mathcal{G}$  and following the edge colors listed in  $\tau$  will result in reaching the  $\text{EXIT}$ .
4.  $v = \text{NOEDGE}$ . Since  $t \neq t'$ , either  $t \neq \text{NOEDGEADDRESS}$  or  $t' \neq \text{NOEDGEADDRESS}$ . Without loss of generality, let  $t \neq \text{NOEDGEADDRESS}$ . This means that  $t \notin \text{SpecialAddresses}$ , so it can be written as a non-empty sequence  $(c_1, \dots, c_{|t|})$  of colors. Let  $\tau$  be the address specified by the color sequence  $(c_1, \dots, c_{|t|-1})$ . By [Algorithm 1](#),  $\eta_{c_{|t|}}(L'(\tau)) = L'(t) = v$ . Since  $v = \text{NOEDGE}$ , we have  $L'(\tau) \in \{\text{ENTRANCE}, \text{EXIT}\}$  by [Definition 2](#). If  $L'(\tau) = \text{EXIT}$ , then following the

edge colors in  $\tau$ , and hence in  $t$ , results in reaching the EXIT, so we are done. It remains to consider  $L'(\tau) = \text{ENTRANCE}$ . It must be that  $\tau \neq \text{EMPTYSTRING}$ ; otherwise,  $t$  would be NOEDGEADDRESS. Thus, by [Lemma 21](#), following the edge colors in  $\tau$ , and hence in  $t$ , beginning from the ENTRANCE forms a cycle in  $\mathcal{G}$ .

5.  $v = \text{INVALID}$ . Since  $t \neq t'$ , either  $t \neq \text{INVALIDADDRESS}$  or  $t' \neq \text{INVALIDADDRESS}$ . Without loss of generality, let  $t \neq \text{INVALIDADDRESS}$ . Then  $t \notin \text{SpecialAddresses}$ , so it can be written as a non-empty sequence  $(c_1, \dots, c_{|t|})$  of colors. Let  $\tau$  be the address specified by the color sequence  $(c_1, \dots, c_{|t|-1})$ . By [Algorithm 1](#),  $\eta_{c_{|t|}}(L'(\tau)) = L'(t) = v$ . Since  $v = \text{INVALID}$ , we have  $L'(\tau) \in \{0^{2n}, \text{NOEDGE}, \text{INVALID}\}$  by [Definition 2](#). By [Algorithm 1](#),  $L'(\tau) = 0^{2n}$  only when  $\tau = \text{ZEROADDRESS}$ . But we know that  $\tau \neq \text{ZEROADDRESS}$ , so we cannot have  $L'(\tau) = 0^{2n}$ . If  $L'(\tau) = \text{NOEDGE}$ , then the desired result follows from [case 4](#). If  $L'(\tau) = \text{INVALID}$ , then we let  $t = \tau$  and can apply the same argument recursively. We conclude that following the edge colors in  $\tau$ , and hence in  $t$ , beginning from the ENTRANCE forms a non-trivial cycle in  $\mathcal{G}$ .
6.  $v \notin \text{SpecialVertices}$ . This means that  $t, t' \notin \text{SpecialAddresses}$ , so we can write  $t = (c_1, \dots, c_{|t|})$  and  $t' = (c'_1, \dots, c'_{|t'|})$  as non-empty sequences of colors. Let  $\tau$  be the address specified by the color sequence  $(c_1, \dots, c_{|t|}, c'_{|t'|}, \dots, c'_1)$  formed by concatenating the sequence  $t$  with the sequence  $t'$  in reverse order. Since  $v$  is a valid vertex of  $\mathcal{G}$ , following this sequence in  $\mathcal{G}$  beginning with ENTRANCE will result in reaching the ENTRANCE (via  $v$ ). That is,  $L'(\tau) = \text{ENTRANCE}$ . Moreover, as  $t$  and  $t'$  are vertex labels in the address tree  $\mathcal{T}$ , following the sequence given by  $\tau$  in  $\mathcal{T}$  beginning with the vertex labeled EMPTYADDRESS will not result in EMPTYADDRESS; otherwise,  $t = t'$ . Our desired result follows by [Lemma 21](#).

Since these cases cover all possible  $v$ , the result follows.  $\square$

The following lemma is critical for the proof of many results that lead up to [Lemma 46](#). Informally, it states if an address  $t$  does not encode an ENTRANCE–EXIT path or a cycle in  $\mathcal{G}$ , then the  $c$ -neighbor of the vertex corresponding to  $t$  in  $\mathcal{G}$  is the same as the vertex corresponding to the  $c$ -neighbor of  $t$  in  $\mathcal{T}$ .

**Lemma 23.** *Let  $v$  be any vertex label, let  $t$  be an address of  $v$ , and let  $c \in \mathcal{C}$ . Furthermore, if  $t \notin \text{SpecialAddresses}$ , suppose that following the edge colors given by  $t$  starting at the ENTRANCE does not result in reaching the EXIT or finding a cycle in  $\mathcal{G}$ . Then  $L'(\lambda_c(t)) = \eta_c(v)$ .*

*Proof.* As  $t$  is the address of  $v$ , we know that  $L'(t) = v$  by [Definition 9](#) and [Algorithm 1](#). It remains to show that  $L'(\lambda_c(t)) = \eta_c(L'(t))$ .

First, suppose  $t \in \text{SpecialAddresses}$ . Then we have four cases:

1.  $t = \text{ZEROADDRESS}$ . Then

$$L'(\lambda_c(\text{ZEROADDRESS})) = L'(\text{INVALIDADDRESS}) = \text{INVALID} \quad (17)$$

$$= \eta_c(0^{2n}) = \eta_c L'(\text{ZEROADDRESS}) \quad (18)$$

where the first step follows from [Definition 11](#), the second and fourth steps follow from [Algorithm 1](#), and the third step follows from [Definition 2](#).

2.  $t = \text{EMPTYSTRING}$ . Then

$$L'(\lambda_c(\text{EMPTYSTRING})) = L'((c)) = \eta_c(\text{ENTRANCE}) = \eta_c L'(\text{EMPTYSTRING}) \quad (19)$$

where the first step follows from [Definition 11](#), the second and fourth steps follow from [Algorithm 1](#), and the third step follows from [Definition 2](#).

3.  $t = \text{NOEDGEADDRESS}$ . This case follows by an argument analogous to [case 1](#).
4.  $t = \text{INVALIDADDRESS}$ . This case also follows by an argument analogous to [case 1](#).

Therefore, assuming  $t \in \text{SpecialAddresses}$ ,  $L'(\lambda_c(t)) = \text{INVALID} = \eta_c(L'(t))$ .

Now, suppose  $t \notin \text{SpecialAddresses}$ . This means we can write  $t$  as a sequence  $(c_1, \dots, c_{|t|})$  of colors.

We claim that  $v$  is a label of a degree-3 vertex of  $\mathcal{G}$ . For a contradiction, assume that  $v \in \text{SpecialVertices}$ . In that case, [Lemma 22](#) implies that beginning from the `ENTRANCE` in  $\mathcal{G}$  and following the edge colors listed in  $t$  will result in either reaching the `EXIT` or forming a path that contains a cycle in  $\mathcal{G}$ , which directly contradicts the hypotheses of the lemma.

Since  $v$  is a degree-3 vertex of  $\mathcal{G}$ , we have  $\eta_c(\eta_c(v)) = v$  by [Definition 5](#). Therefore,

$$L'(\lambda_c(t)) = L'(\lambda_c((c_1, \dots, c_{|t|}))) \quad (20)$$

$$= \begin{cases} L'((c_1, \dots, c_{|t|-1})) & c = c_{|t|} \\ L'((c_1, \dots, c_{|t|}, c)) & \text{otherwise} \end{cases} \quad (21)$$

$$= \begin{cases} (\eta_{c_{|t|-1}} \circ \dots \circ \eta_{c_1})(v) & c = c_{|t|} \\ (\eta_c \circ \eta_{c_{|t|}} \circ \dots \circ \eta_{c_1})(v) & \text{otherwise} \end{cases} \quad (22)$$

$$= (\eta_c \circ \eta_{c_{|t|}} \circ \dots \circ \eta_{c_1})(v) \quad (23)$$

$$= \eta_c(L'((c_1, \dots, c_{|t|}))) \quad (24)$$

$$= \eta_c(L'(t)) \quad (25)$$

where the second step follows from [Definition 11](#), the third and fifth from [Algorithm 1](#), and the fourth from an observation made above.  $\square$

### 4.3 The classical algorithm

We now describe our classical algorithm ([Algorithm 2](#)) for simulating genuine quantum algorithms. To state the algorithm, we introduce several definitions, beginning with a map based on the function  $L'$  defined in [Section 4.2](#).

**Definition 24.** For any  $m \in [p(n)]$ , the mapping  $L: (\{0, 1\}^{2p(n)})^m \rightarrow (\{0, 1\}^{2n})^m$  sends  $m$  address strings to  $m$  vertex labels by acting as  $L'B^{\text{inv}}$  on each of the  $m$  registers.

When considering the map  $L$  applied to a quantum state  $|\chi\rangle$  on both the workspace and the address space, we use the shorthand  $L|\chi\rangle$  to denote the state  $(I_{\text{workspace}} \otimes L_{\text{vertex}})|\chi\rangle$ , with the map acting as the identity on the workspace register and as  $L$  on the vertex register.

To describe and analyze [Algorithm 2](#), we consider individual gates and sequences of consecutive gates from the genuine circuit  $C$  defined in [Definition 6](#). For this purpose, we consider the following definition.

**Definition 25.** For any  $i \in [p(n)]$ , let  $C_i$  denote the  $i$ th gate of the circuit  $C$  in [Definition 6](#). For any  $i, j \in [p(n)] \cup \{0\}$  with  $i < j$ , let  $C_{i,j}$  be the subsequence of gates from the circuit  $C$  starting with the  $(i+1)$ st gate and ending with the  $j$ th gate. That is,  $C_{i,j} := C_j \cdots C_{i+1}$ . Similarly, using the circuit  $\tilde{C}$  constructed in [Definition 15](#), we define  $\tilde{C}_i$  and  $\tilde{C}_{i,j}$  for each  $i, j \in [p(n)] \cup \{0\}$  with  $i < j$ .

Note that  $C_{i,i} = I$  and  $C_{i-1,i} = C_i$  (and similarly,  $\tilde{C}_{i,i} = I$  and  $\tilde{C}_{i-1,i} = \tilde{C}_i$ ) for all  $i \in [p(n)]$ . We use these gates to define transcript states and states of the quantum algorithm for partial executions.

**Definition 26.** For each  $i \in [p(n)] \cup \{0\}$ , let

$$|\phi_{\mathcal{A}}^{(i)}\rangle := \tilde{C}_{0,i}|\phi_{\text{initial}}\rangle \quad (26)$$

be the transcript state for the quantum algorithm  $\mathcal{A}$  restricted to the first  $i$  gates of  $\tilde{C}$ . Similarly, let

$$|\psi_{\mathcal{A}}^{(i)}\rangle := C_{0,i}|\psi_{\text{initial}}\rangle \quad (27)$$

denote the state of the quantum algorithm  $\mathcal{A}$  restricted to the first  $i$  gates of  $C$ .

In particular, the state  $|\phi_{\mathcal{A}}^{(p(n))}\rangle = |\phi_{\mathcal{A}}\rangle$  is the transcript state corresponding to the quantum state  $|\psi_{\mathcal{A}}^{(p(n))}\rangle = |\psi_{\mathcal{A}}\rangle$  introduced in [Definition 6](#).

Now consider the following classical query algorithm for finding a path from the ENTRANCE to the EXIT.

---

**Algorithm 2:** Classical query algorithm  $\mathcal{C}(\mathcal{A}(O))$

---

- 1 **for**  $i \in [p(n)]$  **do**
  - 2     Given the circuit diagram  $C_{0,i}$ , compute the transcript state  $|\phi_{\mathcal{A}}^{(i)}\rangle$  as per [Definition 15](#).
  - 3     Sample a computational basis state  $|\phi^{(i)}\rangle$  in the address space at random with probability  $\|\langle \phi^{(i)} | \phi_{\mathcal{A}}^{(i)} \rangle\|^2$ .
  - 4     Compute the computational basis state  $L|\phi^{(i)}\rangle$  in the vertex space.
  - 5     **Output** the labels of the vertices in  $L|\phi^{(i)}\rangle$ .
- 

Note that when  $\mathcal{A}$  is genuine and rooted, the output of [Algorithm 2](#) must be a connected subgraph of  $\mathcal{G}$  containing the ENTRANCE. Therefore, if the output of [Algorithm 2](#) contains the EXIT, it must reveal an ENTRANCE-to-EXIT path. In the remainder of [Section 4](#), we show that the output of [Algorithm 2](#) contains the EXIT (or a cycle) with exponentially small probability.

#### 4.4 The good, the bad, and the ugly

We now define states  $|\psi_{\text{good}}^{(i)}\rangle$ ,  $|\psi_{\text{bad}}^{(i)}\rangle$ , and  $|\psi_{\text{ugly}}^{(i)}\rangle$ , which are components of the state  $|\psi_{\mathcal{A}}^{(i)}\rangle$ . Intuitively,  $|\psi_{\text{good}}^{(i)}\rangle$  represents the portion of the state of the algorithm after  $i$  steps that has never encountered the EXIT or a near-cycle (i.e., a subgraph that differs from a cycle by a single edge) at any point in its history,  $|\psi_{\text{bad}}^{(i)}\rangle$  represents the portion of the state of the algorithm after  $i$  steps that just encountered the EXIT or a near-cycle at the  $i$ th step, and  $|\psi_{\text{ugly}}^{(i)}\rangle$  combines the portions of the state of the algorithm after  $i$  steps that encountered the EXIT or a near-cycle at some point in its history. To formally define these states, we introduce the notion of good and bad states, which we define as follows.

**Definition 27.** We say that a computational basis state  $|\phi\rangle$  in the address space is  $\phi$ -bad if the subgraph corresponding to  $L|\phi\rangle$  contains the EXIT or is at most one edge away from containing a cycle. A computational basis state  $|\phi\rangle$  in the address space is  $\phi$ -good if it is not  $\phi$ -bad, i.e., if  $L|\phi\rangle$  does not contain the EXIT and is more than one edge away from containing a cycle.

Similarly, a computational basis state  $|\psi\rangle$  in the vertex space is  $\psi$ -bad if the subgraph corresponding to  $|\psi\rangle$  contains the EXIT or is at most one edge away from containing a cycle and is  $\psi$ -good if it is not  $\psi$ -bad.

Note that the map  $L$  is used to define the notion of good and bad states in the address space, but is not used for the corresponding notions in the vertex space.

The good and bad states span the good and bad subspaces, respectively.

**Definition 28.** We define the  $\phi$ -BAD subspace as

$$\phi\text{-BAD} := \text{span}\{|\phi\rangle : |\phi\rangle \text{ is a } \phi\text{-bad state}\}. \quad (28)$$

The  $\phi$ -GOOD subspace is

$$\phi\text{-GOOD} := \text{span}\{|\phi\rangle : \forall |\phi'\rangle \in \phi\text{-BAD}, \langle \phi' | \phi \rangle = 0\} = \text{span}\{|\phi\rangle : |\phi\rangle \text{ is a } \phi\text{-good state}\}. \quad (29)$$

Let  $\Pi_{\text{bad}}^\phi$  and  $\Pi_{\text{good}}^\phi$  denote the projectors onto  $\phi$ -BAD and  $\phi$ -GOOD, respectively.

The subspaces  $\psi$ -BAD and  $\psi$ -GOOD, and the projectors  $\Pi_{\text{bad}}^\psi$  and  $\Pi_{\text{good}}^\psi$ , are defined analogously.

Notice that  $\Pi_{\text{bad}}^\phi \Pi_{\text{good}}^\phi = \Pi_{\text{good}}^\phi \Pi_{\text{bad}}^\phi = 0$  and  $\Pi_{\text{bad}}^\phi + \Pi_{\text{good}}^\phi = I$ . Similarly,  $\Pi_{\text{bad}}^\psi \Pi_{\text{good}}^\psi = \Pi_{\text{good}}^\psi \Pi_{\text{bad}}^\psi = 0$  and  $\Pi_{\text{bad}}^\psi + \Pi_{\text{good}}^\psi = I$ . We now define the states  $|\psi_{\text{good}}^{(i)}\rangle$ ,  $|\psi_{\text{bad}}^{(i)}\rangle$ , and  $|\psi_{\text{ugly}}^{(i)}\rangle$  that were described informally above.

**Definition 29.** We define

$$|\phi_{\text{good}}^{(i)}\rangle := \Pi_{\text{good}}^\phi \left( |\phi_{\mathcal{A}}^{(i)}\rangle - \tilde{C}_i |\phi_{\text{ugly}}^{(i-1)}\rangle \right), \quad |\phi_{\text{bad}}^{(i)}\rangle := \Pi_{\text{bad}}^\phi \left( |\phi_{\mathcal{A}}^{(i)}\rangle - \tilde{C}_i |\phi_{\text{ugly}}^{(i-1)}\rangle \right) \quad (30)$$

where

$$|\phi_{\text{ugly}}^{(i)}\rangle := \sum_{j=1}^i \tilde{C}_{j,i} |\phi_{\text{bad}}^{(j)}\rangle. \quad (31)$$

Moreover, let  $|\phi_{\text{good}}^{(p(n))}\rangle := |\phi_{\text{good}}^{(p(n))}\rangle$  and  $|\phi_{\text{ugly}}^{(p(n))}\rangle := |\phi_{\text{ugly}}^{(p(n))}\rangle$ . For each  $i \in [p(n)]$ , we define  $|\psi_{\text{good}}^{(i)}\rangle$ ,  $|\psi_{\text{bad}}^{(i)}\rangle$ ,  $|\psi_{\text{ugly}}^{(i)}\rangle$ ,  $|\psi_{\text{good}}\rangle$ , and  $|\psi_{\text{ugly}}\rangle$  analogously (using  $C$  in lieu of  $\tilde{C}$ ).

We now observe some properties that can be deduced from [Definitions 28](#) and [29](#). We use many of these properties throughout the rest of our analysis.

**Lemma 30.** Let  $i \in [p(n)] \cup \{0\}$ . Then

1.  $\Pi_{\text{bad}}^\phi |\phi_{\text{bad}}^{(i)}\rangle = |\phi_{\text{bad}}^{(i)}\rangle$  and  $\Pi_{\text{good}}^\phi |\phi_{\text{good}}^{(i)}\rangle = |\phi_{\text{good}}^{(i)}\rangle$ ,
2.  $\Pi_{\text{bad}}^\psi |\psi_{\text{bad}}^{(i)}\rangle = |\psi_{\text{bad}}^{(i)}\rangle$  and  $\Pi_{\text{good}}^\psi |\psi_{\text{good}}^{(i)}\rangle = |\psi_{\text{good}}^{(i)}\rangle$ ,
3.  $|\phi_{\text{good}}^{(i)}\rangle$  has disjoint support from  $|\phi_{\text{bad}}^{(i)}\rangle$ ,
4.  $|\psi_{\text{good}}^{(i)}\rangle$  has disjoint support from  $|\psi_{\text{bad}}^{(i)}\rangle$ ,
5.  $|\phi_{\text{good}}^{(i)}\rangle = |\phi_{\mathcal{A}}^{(i)}\rangle - |\phi_{\text{ugly}}^{(i)}\rangle$ ,
6.  $|\psi_{\text{good}}^{(i)}\rangle = |\psi_{\mathcal{A}}^{(i)}\rangle - |\psi_{\text{ugly}}^{(i)}\rangle$ ,
7.  $\tilde{C}_i |\phi_{\text{good}}^{(i-1)}\rangle = |\phi_{\text{good}}^{(i)}\rangle + |\phi_{\text{bad}}^{(i)}\rangle$ ,
8.  $C_i |\psi_{\text{good}}^{(i-1)}\rangle = |\psi_{\text{good}}^{(i)}\rangle + |\psi_{\text{bad}}^{(i)}\rangle$ ,

9.  $\Pi_{\text{bad}}^\phi \left| \phi_{\mathcal{A}}^{(i)} \right\rangle = \left| \phi_{\text{bad}}^{(i)} \right\rangle + \Pi_{\text{bad}}^\phi \tilde{C}_i \left| \phi_{\text{ugly}}^{(i-1)} \right\rangle,$
10.  $\Pi_{\text{bad}}^\psi \left| \psi_{\mathcal{A}}^{(i)} \right\rangle = \left| \psi_{\text{bad}}^{(i)} \right\rangle + \Pi_{\text{bad}}^\psi C_i \left| \psi_{\text{ugly}}^{(i-1)} \right\rangle,$
11.  $\Pi_{\text{good}}^\phi \left| \phi_{\mathcal{A}}^{(i)} \right\rangle = \left| \phi_{\text{good}}^{(i)} \right\rangle + \Pi_{\text{good}}^\phi \tilde{C}_i \left| \phi_{\text{ugly}}^{(i-1)} \right\rangle,$  and
12.  $\Pi_{\text{good}}^\psi \left| \psi_{\mathcal{A}}^{(i)} \right\rangle = \left| \psi_{\text{good}}^{(i)} \right\rangle + \Pi_{\text{good}}^\psi C_i \left| \psi_{\text{ugly}}^{(i-1)} \right\rangle.$

*Proof.*

1. By [Definition 29](#), any computational basis state in the support of  $\left| \phi_{\text{bad}}^{(i)} \right\rangle$  is  $\phi$ -bad and any computational basis state in the support of  $\left| \phi_{\text{good}}^{(i)} \right\rangle$  is  $\phi$ -good. Then the desired statement follows from [Definition 28](#).
2. Similar to the proof of [part 1](#).
3. Since  $\Pi_{\text{bad}}^\phi$  and  $\Pi_{\text{good}}^\phi$  are orthogonal projectors, this follows from [part 1](#).
4. Similar to the proof of [part 3](#).

We prove the remaining parts by induction on  $i$ . All the statements are trivially true for  $i = 0$  by [Definitions 28](#) and [29](#). We show each of them separately for all  $i \in [p(n)]$  assuming that they are true for  $i - 1$ .

5. Note that

$$\left| \phi_{\text{good}}^{(i)} \right\rangle = \Pi_{\text{good}}^\phi \left( \left| \phi_{\mathcal{A}}^{(i)} \right\rangle - \tilde{C}_i \left| \phi_{\text{ugly}}^{(i-1)} \right\rangle \right) \quad (32)$$

$$= (I - \Pi_{\text{bad}}^\phi) \left( \left| \phi_{\mathcal{A}}^{(i)} \right\rangle - \tilde{C}_i \left| \phi_{\text{ugly}}^{(i-1)} \right\rangle \right) \quad (33)$$

$$= \left| \phi_{\mathcal{A}}^{(i)} \right\rangle - \tilde{C}_i \left| \phi_{\text{ugly}}^{(i-1)} \right\rangle - \left| \phi_{\text{bad}}^{(i)} \right\rangle \quad (34)$$

$$= \left| \phi_{\mathcal{A}}^{(i)} \right\rangle - \left| \phi_{\text{ugly}}^{(i)} \right\rangle \quad (35)$$

where we used [Definition 29](#) in all steps except for the second one, where we used [Definition 28](#).

6. Similar to the proof of [part 5](#).
7. Note that

$$\tilde{C}_i \left| \phi_{\text{good}}^{(i-1)} \right\rangle = \tilde{C}_i \left( \left| \phi_{\mathcal{A}}^{(i-1)} \right\rangle - \left| \phi_{\text{ugly}}^{(i-1)} \right\rangle \right) \quad (36)$$

$$= \left| \phi_{\mathcal{A}}^{(i)} \right\rangle - \tilde{C}_i \left| \phi_{\text{ugly}}^{(i-1)} \right\rangle \quad (37)$$

$$= \left| \phi_{\text{good}}^{(i)} \right\rangle + \left| \phi_{\text{ugly}}^{(i)} \right\rangle - \tilde{C}_i \left| \phi_{\text{ugly}}^{(i-1)} \right\rangle \quad (38)$$

$$= \left| \phi_{\text{good}}^{(i)} \right\rangle + \left| \phi_{\text{bad}}^{(i)} \right\rangle \quad (39)$$

where we used [part 5](#) in steps 1 and 3, and [Definition 29](#) in step 4.

8. Similar to the proof of [part 7](#).

9. Note that

$$\Pi_{\text{bad}}^\phi \left| \phi_{\mathcal{A}}^{(i)} \right\rangle = \Pi_{\text{bad}}^\phi \left( \left| \phi_{\text{good}}^{(i)} \right\rangle + \left| \phi_{\text{ugly}}^{(i)} \right\rangle \right) \quad (40)$$

$$= \Pi_{\text{bad}}^\phi \left| \phi_{\text{ugly}}^{(i)} \right\rangle \quad (41)$$

$$= \Pi_{\text{bad}}^\phi \left( \left| \phi_{\text{bad}}^{(i)} \right\rangle + \tilde{C}_i \left| \phi_{\text{ugly}}^{(i-1)} \right\rangle \right) \quad (42)$$

$$= \left| \phi_{\text{bad}}^{(i)} \right\rangle + \Pi_{\text{bad}}^\phi \tilde{C}_i \left| \phi_{\text{ugly}}^{(i-1)} \right\rangle \quad (43)$$

where we used [part 5](#) in step 1, [part 1](#) in steps 2 and 4, and [Definition 29](#) in step 3.

10. Similar to the proof of [part 9](#).

11. Note that

$$\Pi_{\text{good}}^\psi \left| \psi_{\mathcal{A}}^{(i)} \right\rangle = \Pi_{\text{good}}^\psi \left( \left| \phi_{\text{good}}^{(i)} \right\rangle + \left| \phi_{\text{ugly}}^{(i)} \right\rangle \right) \quad (44)$$

$$= \left| \phi_{\text{good}}^{(i)} \right\rangle + \Pi_{\text{good}}^\psi \left| \phi_{\text{ugly}}^{(i)} \right\rangle \quad (45)$$

$$= \left| \phi_{\text{good}}^{(i)} \right\rangle + \Pi_{\text{good}}^\psi \left( \left| \phi_{\text{bad}}^{(i)} \right\rangle + \tilde{C}_i \left| \phi_{\text{ugly}}^{(i-1)} \right\rangle \right) \quad (46)$$

$$= \left| \phi_{\text{good}}^{(i)} \right\rangle + \Pi_{\text{good}}^\psi \tilde{C}_i \left| \phi_{\text{ugly}}^{(i-1)} \right\rangle \quad (47)$$

where we used [part 5](#) in step 1, [part 1](#) in steps 2 and 4, and [Definition 29](#) in step 3.

12. Similar to the proof of [part 11](#).  $\square$

Based on the intuitive description of  $\left| \psi_{\text{good}}^{(i)} \right\rangle$  and  $\left| \psi_{\text{bad}}^{(i)} \right\rangle$  that we provided earlier, we anticipate that the size (as quantified by the total squared norm) of the portion of the state  $\left| \psi_{\mathcal{A}}^{(i)} \right\rangle$  that never encountered the EXIT or a near-cycle at any point in its history, and the size of the respective portions of the state  $\left| \psi_{\mathcal{A}}^{(i)} \right\rangle$  that encountered the EXIT or a cycle at the  $i$ th or earlier steps, to sum to the size of  $\left| \psi_{\mathcal{A}}^{(i)} \right\rangle$ . The following lemma formalizes this intuition.

**Lemma 31.** *Let  $i \in [p(n)] \cup \{0\}$ . Then  $\left\| \left| \psi_{\text{good}}^{(i)} \right\rangle \right\|^2 + \sum_{j \in [i]} \left\| \left| \psi_{\text{bad}}^{(j)} \right\rangle \right\|^2 = 1$ .*

*Proof.* We prove this claim by induction on  $i$ . The base case is trivial as  $\left\| \left| \psi_{\text{good}}^{(0)} \right\rangle \right\| = 1$  and  $\left\| \left| \psi_{\text{bad}}^{(0)} \right\rangle \right\| = 0$ . Now, suppose that the claim is true for some  $i$  with  $i+1 \in [p(n)]$ . Note that

$$\left\| \left| \psi_{\text{good}}^{(i)} \right\rangle \right\|^2 = \left\| \left| C_i \left| \psi_{\text{good}}^{(i)} \right\rangle \right\rangle \right\|^2 \quad (48)$$

$$= \left\| \left| \psi_{\text{good}}^{(i+1)} \right\rangle + \left| \psi_{\text{bad}}^{(i+1)} \right\rangle \right\|^2 \quad (49)$$

$$= \left\| \left| \psi_{\text{good}}^{(i+1)} \right\rangle \right\|^2 + \left\| \left| \psi_{\text{bad}}^{(i+1)} \right\rangle \right\|^2 \quad (50)$$

where we use the fact that the unitary  $C_i$  preserves the norm in the first step, and [parts 4](#) and [8](#) of [Lemma 30](#) in the second and third steps, respectively.

Therefore,

$$\left\| \left| \psi_{\text{good}}^{(i+1)} \right\rangle \right\|^2 + \sum_{j \in [i+1]} \left\| \left| \psi_{\text{bad}}^{(j)} \right\rangle \right\|^2 = \left\| \left| \psi_{\text{good}}^{(i)} \right\rangle \right\|^2 - \left\| \left| \psi_{\text{bad}}^{(i+1)} \right\rangle \right\|^2 + \sum_{j \in [i+1]} \left\| \left| \psi_{\text{bad}}^{(j)} \right\rangle \right\|^2 \quad (51)$$

$$= \left\| \left| \psi_{\text{good}}^{(i)} \right\rangle \right\|^2 + \sum_{j \in [i]} \left\| \left| \psi_{\text{bad}}^{(j)} \right\rangle \right\|^2 \quad (52)$$

$$= 1 \quad (53)$$

where the last step follows by the induction hypothesis.  $\square$

We conclude this section by strengthening the observations made in [Remark 18](#) and [Lemma 20](#) using [Lemma 30](#), which we apply in [Section 4.5](#).

**Lemma 32.** *Let  $i \in [p(n)] \cup \{0\}$ . Then*

1. *any computational basis state in the support of  $\left| \psi_{\text{good}}^{(i)} \right\rangle$  or  $\left| \psi_{\text{bad}}^{(i)} \right\rangle$  is rooted, and*
2. *any computational basis state in the support of  $\left| \phi_{\text{good}}^{(i)} \right\rangle$  or  $\left| \phi_{\text{bad}}^{(i)} \right\rangle$  is address rooted.*

*Proof.* We show [part 1](#) using [Remark 18](#), while [part 2](#) follows using [Lemma 20](#) and analogous arguments.

From [Remark 18](#), we can infer that any consecutive sequence of gates in the circuit corresponding to the given genuine, rooted algorithm will map a rooted state to a rooted state. Notice that  $\left| \psi_{\text{good}}^{(0)} \right\rangle = \left| \psi_{\text{initial}} \right\rangle$  and  $\left| \psi_{\text{bad}}^{(0)} \right\rangle = 0$ . That is,  $\left| \psi_{\text{good}}^{(0)} \right\rangle$  and  $\left| \psi_{\text{bad}}^{(0)} \right\rangle$  are rooted states by [eq. \(7\)](#). Thus, since  $C_i \left| \psi_{\text{good}}^{(i-1)} \right\rangle = \left| \psi_{\text{good}}^{(i)} \right\rangle + \left| \psi_{\text{bad}}^{(i)} \right\rangle$  by [part 8](#) of [Lemma 30](#), any computational basis state in the support of  $\left| \psi_{\text{good}}^{(i)} \right\rangle + \left| \psi_{\text{bad}}^{(i)} \right\rangle$  will be rooted for each  $i \in [p(n)]$ . But, by [part 4](#) of [Lemma 30](#),  $\left| \psi_{\text{good}}^{(i)} \right\rangle$  has disjoint support from  $\left| \psi_{\text{bad}}^{(i)} \right\rangle$ , so any computational basis state in the support of  $\left| \psi_{\text{good}}^{(i)} \right\rangle$  or in the support of  $\left| \psi_{\text{bad}}^{(i)} \right\rangle$  is rooted for each  $i \in [p(n)]$ .  $\square$

## 4.5 Faithful simulation of the good part

As any subtree of  $\mathcal{G}$  without the EXIT vertex can be embedded in  $\mathcal{T}$ , one might expect that the size of the portion of the state  $\left| \psi_{\mathcal{A}}^{(i)} \right\rangle$  that never encountered the EXIT or a near-cycle at any point in its history is the same as the size of the portion of the state  $\left| \phi_{\mathcal{A}}^{(i)} \right\rangle$  that never encountered the EXIT or a near-cycle at any point in its history. We formally show this via a sequence of lemmas that culminate in [Lemma 47](#). We restrict our attention to the good parts of the states  $\left| \psi_{\mathcal{A}}^{(i)} \right\rangle$  and  $\left| \phi_{\mathcal{A}}^{(i)} \right\rangle$  in this subsection, beginning with a useful decomposition of  $\left| \phi_{\text{good}}^{(i)} \right\rangle$ .

**Definition 33.** *We define an indexed expansion of  $\left| \phi_{\text{good}}^{(i)} \right\rangle$  in the computational basis, as follows. Write  $\left| \phi_{\text{good}}^{(i)} \right\rangle = \sum_{p,q} \alpha_{p,q}^{(i)} \left| q^{(i)} \right\rangle \left| \phi_p^{(i)} \right\rangle$ , where each  $\left| \phi_p^{(i)} \right\rangle$  denotes a computational basis state in the vertex register, each  $\left| q^{(i)} \right\rangle$  specifies a computational basis state in the workspace register, and each  $\alpha_{p,q}^{(i)}$  is an amplitude. Define  $\mathcal{P}_{\text{good}_{\mathcal{A}}}^{(i)}$  to be the set of all indices  $p$  appearing in the expansion of  $\left| \phi_{\text{good}}^{(i)} \right\rangle$  with any corresponding non-zero amplitude  $\alpha_{p,q}^{(i)}$ .*



Analogous to [Definition 29](#), we define computational basis states  $|\psi_p^{(i)}\rangle$  from  $|\phi_p^{(i)}\rangle$ , and hence from  $|\phi_{\mathcal{A}}^{(i)}\rangle$  rather than  $|\psi_{\mathcal{A}}^{(i)}\rangle$ .

**Definition 34.** For  $i \in [p(n)] \cup \{0\}$  and  $p \in \mathcal{P}_{\text{good}_{\mathcal{A}}}^{(i)}$ , let  $|\psi_p^{(i)}\rangle := L|\phi_p^{(i)}\rangle$ .

Notice that it is not immediate from this definition that  $|\psi_p^{(i)}\rangle$  is in the support of the part of the state  $|\psi_{\mathcal{A}}^{(i)}\rangle$  that is in the vertex space. However, by the end of this section, we will show that indeed this is the case.

For each  $i \in [p(n)] \cup \{0\}$  and  $p \in \mathcal{P}_{\text{good}_{\mathcal{A}}}^{(i)}$ , the state  $|\phi_p^{(i)}\rangle$  is a computational basis state in the address space, so we can write it as

$$|\phi_p^{(i)}\rangle = \bigotimes_{j \in [p(n)]} |s_j\rangle \quad (54)$$

for some strings  $s_j \in \{0, 1\}^{2p(n)}$ .

Similarly, for each  $i \in [p(n)] \cup \{0\}$  and  $p \in \mathcal{P}_{\text{good}_{\mathcal{A}}}^{(i)}$ , the state  $|\psi_p^{(i)}\rangle$  is a computational basis state in the vertex space, so we can write it as

$$|\psi_p^{(i)}\rangle = \bigotimes_{j \in [p(n)]} |v_j\rangle \quad (55)$$

for some vertex labels  $v_j \in \{0, 1\}^{2n}$ .

By the above notation and [Definition 34](#), we have that for each  $j \in [p(n)]$ ,

$$L(s_j) = v_j. \quad (56)$$

Note that  $|s_j\rangle$  and  $|v_j\rangle$  also depend on  $p$  and  $i$ . However, as  $p$  and  $i$  will be clear from context, we keep this dependence implicit to simplify notation.

In the same vein, for each  $i \in [p(n)] \cup \{0\}$  and workspace index  $q$ , the state  $|q^{(i)}\rangle$  is a computational basis state in the vertex space, so we can write it as

$$|q^{(i)}\rangle = \bigotimes_{j \in [p(n)]} |w_j\rangle. \quad (57)$$

Again we suppress the dependence on  $q$  and  $i$  for simplicity.

We now show that the mapping  $L$ , defined in [Definition 24](#), is a bijection from the set of address-rooted states in  $|\phi_{\text{good}}^{(i)}\rangle$  to the set of address-rooted states in  $L|\phi_{\text{good}}^{(i)}\rangle$ .

**Lemma 35.** Let  $i \in [p(n)]$  and  $p, p' \in \mathcal{P}_{\text{good}_{\mathcal{A}}}^{(i)}$ . Suppose that  $|\psi_p^{(i)}\rangle = |\psi_{p'}^{(i)}\rangle$ . Then  $|\phi_p^{(i)}\rangle = |\phi_{p'}^{(i)}\rangle$ .

*Proof.* Suppose, towards contradiction, that  $|\psi_p^{(i)}\rangle = |\psi_{p'}^{(i)}\rangle$  but  $|\phi_p^{(i)}\rangle \neq |\phi_{p'}^{(i)}\rangle$ . This means that there is an index  $j \in [p(n)]$  such that the string  $s_j$  stored in the  $j$ th register of  $|\phi_p^{(i)}\rangle$  is not equal to the string  $s'_j$  stored in the  $j$ th register of  $|\phi_{p'}^{(i)}\rangle$ , and yet the vertex label  $v_j$  stored in the  $j$ th register of  $|\psi_p^{(i)}\rangle$  is equal to the vertex label  $v'_j$  stored in the  $j$ th register of  $|\psi_{p'}^{(i)}\rangle$ . Consider the addresses  $t_j = B^{\text{inv}}(s_j)$  and  $t'_j = B^{\text{inv}}(s'_j)$ . We know that  $L'(t_j) = L'(t'_j) = v_j$  from [eq. \(56\)](#).

By [Lemma 17](#), we have  $s_j$  and  $s_k$  in the range of  $B$ . Recall, from [Definition 12](#), that  $B$  is a bijection and  $B^{\text{inv}} = B^{-1}$  on the range of  $B$ . Therefore,  $t_j \neq t'_j$ . Moreover, this means that we can write  $s_j = B(t_j)$  and  $s'_j = B(t'_j)$ .

We know, from [Lemma 32](#), that  $|\phi_p^{(i)}\rangle$  and  $|\phi_{p'}^{(i)}\rangle$  are address rooted. This means that for any ancestor  $\tau \neq \text{ZEROADDRESS}$  of  $t_j$  in  $\mathcal{T}$ ,  $B(\tau)$  is stored in one of the registers of  $|\phi_p^{(i)}\rangle$ . Therefore, there is a path from the vertex labeled  $\text{EMPTYADDRESS}$  and  $t_j$  in  $\mathcal{T}$  such that  $|\phi_p^{(i)}\rangle$  contains  $B(\tau)$  for all vertices  $\tau$  in this path. Let  $\tau_0 = \text{EMPTYADDRESS}, \dots, \tau_\gamma = t_j$  denote this path where  $\gamma$  is the length of this path. By [Definition 34](#),  $|\psi_p^{(i)}\rangle$  contains the vertex label  $L'(\tau_i)$  for each  $i \in [\gamma]$ . Similarly, we can deduce that there is a path  $\tau'_0 = \text{EMPTYADDRESS}, \dots, \tau'_{\gamma'} = t'_j$  in  $\mathcal{T}$ , with  $\gamma'$  denoting the length of this path, such that  $|\psi_{p'}^{(i)}\rangle = |\psi_p^{(i)}\rangle$  contains the vertex label  $L'(\tau'_i)$  for each  $i \in [\gamma']$ . Since  $t_j \neq t'_j$  and  $v_j = v'_j$ , it follows that  $|\psi_p^{(i)}\rangle$  contains two distinct paths from  $L'(\text{EMPTYADDRESS}) = \text{ENTRANCE}$  to  $L'(t_j) = L'(t'_j) = v_j$  in  $\mathcal{G}$ . Hence,  $|\psi_p^{(i)}\rangle$  contains a cycle. But this is not possible since  $p \in \mathcal{P}_{\text{good}, \mathcal{A}}^{(i)}$ . Therefore,  $|\phi_p^{(i)}\rangle \neq |\phi_{p'}^{(i)}\rangle \implies |\psi_p^{(i)}\rangle \neq |\psi_{p'}^{(i)}\rangle$ .  $\square$

The following lemma states that there is a bijective correspondence between the contents of the vertex registers of  $|\psi_{\text{good}}^{(i)}\rangle$  and the address registers of  $|\phi_{\text{good}}^{(i)}\rangle$ .

**Lemma 36.** *Let  $i \in [p(n)] \cup \{0\}$ ,  $j, k \in [p(n)]$ ,  $p \in \mathcal{P}_{\text{good}, \mathcal{A}}^{(i)}$  and  $c \in \mathcal{C}$ . Let  $|v_j\rangle$  and  $|v_k\rangle$  be the states stored in the  $j$ th and  $k$ th registers of  $|\psi_p^{(i)}\rangle$ , respectively, as in [eq. \(55\)](#). Similarly, let  $|s_j\rangle$  and  $|s_k\rangle$  be the states stored in the  $j$ th and  $k$ th registers of  $|\phi_p^{(i)}\rangle$ , respectively, as in [eq. \(54\)](#). Then*

1.  $v_j = 0^{2n} \iff s_j = 0^{2p(n)}$ ,
2.  $v_j = \text{NOEDGE} \iff s_j = \text{NOEDGESTRING}$ ,
3.  $v_j = \text{INVALID} \iff s_j = \text{INVALIDSTRING}$ ,
4.  $v_j = v_k \iff s_j = s_k$ , and
5.  $v_j = \eta_c(v_k) \iff s_j = B\lambda_c B^{\text{inv}}(s_k)$ .

*Proof.* We show each statement separately as follows.

1. First, suppose that  $v_j = 0^{2n}$ . By [eq. \(56\)](#), we know that  $L(s_j) = 0^{2n}$ . Let  $t_j = B^{\text{inv}}(s_j)$ . Then,  $L'(t_j) = 0^{2n}$ . It can be observed from [Algorithm 1](#) that  $t_j = \text{ZEROADDRESS}$  as only in that case  $L'(t_j) = 0^{2n}$ . Thus, by [Definition 12](#), it must be that  $s_j = 0^{2p(n)}$  as it is the only value of  $s_j$  for which  $B^{\text{inv}}(s_j) = \text{ZEROADDRESS}$ .

Now, suppose that  $s_j = 0^{2p(n)}$ . Then

$$v_j = L(s_j) = L' B^{\text{inv}}(0^{2p(n)}) = L'(\text{ZEROADDRESS}) = 0^{2n} \quad (58)$$

where the first step follows from [eq. \(56\)](#), the third follows from [Definition 12](#), and the fourth from [Algorithm 1](#).

2. First, suppose that  $v_j = \text{NOEDGE}$ . By eq. (56), we know that  $L(s_j) = \text{NOEDGE}$ . Let  $t_j = B^{\text{inv}}(s_j)$ . Then  $L'(t_j) = \text{NOEDGE}$ . We claim that  $t_j = \text{NOEDGEADDRESS}$ . Indeed, if  $t_j \neq \text{NOEDGEADDRESS}$ , then, as  $L'(\text{NOEDGEADDRESS}) = L'(t_j) = \text{NOEDGE}$ , we would have found the EXIT or a cycle in  $\mathcal{G}$  by Lemma 22. But that is not possible since  $p \in \mathcal{P}_{\text{good}_A}^{(i)}$ , so  $t_j = \text{NOEDGEADDRESS}$ . It follows that  $s_j = \text{NOEDGESTRING}$  since it is the only possible assignment of  $s_j$  such that  $B^{\text{inv}}(s_j) = \text{NOEDGEADDRESS}$  by Definition 12.

Now, suppose that  $s_j = \text{NOEDGESTRING}$ . Then

$$v_j = L(s_j) = L'B^{\text{inv}}(\text{NOEDGESTRING}) = L'(\text{NOEDGEADDRESS}) = \text{NOEDGE} \quad (59)$$

where the first step follows from eq. (56), the third follows from Definition 12, and the fourth from Algorithm 1.

3. First, suppose that  $v_j = \text{INVALID}$ . By eq. (56), we know that  $L(s_j) = \text{INVALID}$ . Let  $t_j = B^{\text{inv}}(s_j)$ . Then  $L'(t_j) = \text{INVALID}$ . We claim that  $t_j = \text{INVALIDADDRESS}$ . Indeed, if  $t_j \neq \text{INVALIDADDRESS}$ , then, as  $L'(\text{INVALIDADDRESS}) = L'(t_j) = \text{INVALID}$ , we would have found the EXIT or a cycle in  $\mathcal{G}$  by Lemma 22. But that is not possible since  $p \in \mathcal{P}_{\text{good}_A}^{(i)}$ , so  $t_j = \text{INVALIDADDRESS}$ . Recall from Lemma 17 that  $s_j$  is in the range of the  $B$  mapping. It follows that  $s_j = \text{NOEDGESTRING}$  since this is the only possible assignment of  $s_j$  in the range of  $B$  with  $B^{\text{inv}}(s_j) = \text{INVALIDADDRESS}$ .

Now, suppose that  $s_j = \text{INVALIDSTRING}$ . Then

$$v_j = L(s_j) = L'B^{\text{inv}}(\text{INVALIDSTRING}) = L'(\text{INVALIDADDRESS}) = \text{INVALID} \quad (60)$$

where the first step follows from eq. (56), the third follows from Definition 12, and the fourth from Algorithm 1.

4. First, suppose that  $v_j = v_k$ . From eq. (56), we can deduce that  $L(s_j) = L(s_k)$ . Let  $t_j = B^{\text{inv}}(s_j)$  and  $t_k = B^{\text{inv}}(s_k)$ . Then  $L'(t_j) = L'(t_k)$ . If  $t_j \neq t_k$ , then, by Lemma 22, the concatenation of the paths specified by the sequence of colors  $t_j$  and  $t_k$  forms a cycle, which contradicts  $p \in \mathcal{P}_{\text{good}_A}^{(i)}$ . This means that  $t_j = t_k$ . Recall from Lemma 17 that  $s_j$  and  $s_k$  are in the range of  $B$ . We know, from Definition 12, that  $B$  is a bijection and  $B^{\text{inv}} = B^{-1}$  on the range of  $B$ . Therefore,  $s_j = s_k$ .

Now suppose that  $s_j = s_k$ . Thus,  $L(s_j) = L(s_k)$ . By eq. (56), we know that  $L(s_j) = v_j$  and  $L(s_k) = v_k$ . Therefore,  $v_j = v_k$ .

5. First, suppose that  $v_j = \eta_c(v_k)$ . From eq. (56), we have  $v_j = L(s_j)$  and  $v_k = L(s_k)$ . Let  $t_j = B^{\text{inv}}(s_j)$  and  $t_k = B^{\text{inv}}(s_k)$ . Then  $v_j = L'(t_j)$  and  $v_k = L'(t_k)$ , which means that  $t_j$  and  $t_k$  are addresses of the vertices  $v_j$  and  $v_k$  respectively. By Lemma 23, it follows that  $\eta_c(v_k) = L'\lambda_c(t_k)$ . Altogether, we have  $L'(t_j) = L'\lambda_c(t_k)$ . If  $t_j \neq \lambda_c(t_k)$ , then by Lemma 22, the concatenation of the paths specified by the sequence of colors  $t_j$  and  $\lambda_c(t_k)$  forms a cycle, which contradicts  $p \in \mathcal{P}_{\text{good}_A}^{(i)}$ . This means that  $t_j = \lambda_c(t_k)$ . It follows that  $BB^{\text{inv}}(s_j) = B(t_j) = B\lambda_c(t_k)$ . Recall that  $s_j$  is in the range of  $B$  from Lemma 17. Since  $B$  is a bijection and  $B^{\text{inv}} = B^{-1}$  on the range of  $B$  from Definition 12, we can deduce that  $BB^{\text{inv}}(s_j) = s_j$ . Hence,  $s_j = B\lambda_c B^{\text{inv}}(s_k)$ .

Now suppose that  $s_j = B\lambda_c B^{\text{inv}}(s_k)$ . Then  $L(s_j) = LB\lambda_c B^{\text{inv}}(s_k) = LB\lambda_c(t_k)$ . By eq. (56) we have  $v_j = LB\lambda_c(t_k)$ . Note that  $\lambda_c B^{\text{inv}}(s_k) = \lambda_c(t_k)$  is in the domain of  $B$  since  $B^{\text{inv}}$

maps any string to the domain of  $B$  and  $\lambda_c$  preserves the domain of  $B$  by [Definitions 11 and 12](#). Therefore, as  $B$  is a bijection and  $B^{\text{inv}} = B^{-1}$  on the range of  $B$ ,  $LB\lambda_c(t_k) = L'\lambda_c(t_k)$ . Since  $t_k$  is an address of  $v_k$ , we have  $L'\lambda_c(t_k) = \eta_c(v_k)$  by [Lemma 23](#). Altogether, we have  $LB\lambda_c(t_k) = \eta_c(v_k)$ . By the deductions we made above, we can conclude that  $v_j = \eta_c(v_k)$ .  $\square$

The next lemma forms a key ingredient of [Lemma 46](#), where we essentially show that the mapping  $L$  and the gate  $C_i$  commute: applying  $L$  followed by  $C_i$  is equivalent to applying  $\tilde{C}_i$  followed by  $L$ .

**Lemma 37.** *Let  $i \in [p(n)]$ ,  $p \in \mathcal{P}_{\text{good},A}^{(i)}$  and  $q$  be any workspace index. Then  $L\tilde{C}_i \left| q^{(i-1)} \right\rangle \left| \phi_p^{(i-1)} \right\rangle = C_i \left| q^{(i-1)} \right\rangle \left| \psi_p^{(i-1)} \right\rangle$ .*

*Proof.* We prove the statement of the lemma for each of the possible gates in our gate set defined in [Definition 5](#). For any quantum state  $|\chi\rangle = \bigotimes_j |\chi_j\rangle$ , and any indices  $j_1, \dots, j_r$ , let  $|\chi\rangle_{j_1, \dots, j_r} := |\chi_{j_1}\rangle \otimes \dots \otimes |\chi_{j_r}\rangle$ .

1.  $C_i = \wedge(O_c)$  for some  $c \in \mathcal{C}$ . Let  $x, y \in [p(n)]$  denote the vertex register indices that  $O_c$  acts on, and let  $a$  denote the workspace register index of the control qubit. Recall, from [eqs. \(54\) and \(55\)](#), that  $v_x$  and  $s_x$  denote the contents of the  $x$ th vertex register of  $\left| \psi_p^{(i-1)} \right\rangle$  and the  $x$ th address register of  $\left| \phi_p^{(i-1)} \right\rangle$ , respectively. Note that  $t_x = B^{\text{inv}}(s_x)$  is an address of  $v_x$  as  $L'(t_x) = v_x$  by [eq. \(56\)](#). Then

$$LB\lambda_c B^{\text{inv}}(s_x) = L' B^{\text{inv}} B\lambda_c(t_x) = L'\lambda_c(t_x) = \eta_c(v_x) \quad (61)$$

where the first equality follows from [Definition 24](#), the second equality follows since  $B^{\text{inv}}$  is the inverse of  $B$  over the range of  $B$  in [Definition 12](#), and the third follows from [Lemma 23](#).

Note that  $|s_x\rangle$  and  $|s_y\rangle$  denote the states of the control and target registers of the oracle gate  $\tilde{O}_c$ . We argued in the proof of [Lemma 17](#) that  $\wedge(\tilde{O}_c)$  is only applied when  $s_y = 0^{2p(n)}$  or  $s_y = B\lambda_c B^{\text{inv}}(s_x)$ . Therefore,

$$L \wedge(\tilde{O}_c) \left| \phi_p^{(i-1)} \right\rangle_{x,y} \left| q^{(i-1)} \right\rangle_a = L \wedge(\tilde{O}_c) |s_x\rangle |s_y\rangle |w_a\rangle \quad (62)$$

$$= L \begin{cases} |s_x\rangle |s_y \oplus B\lambda_c B^{\text{inv}}(s_x)\rangle |w_a\rangle & s_y \in \{0^{2p(n)}, B\lambda_c B^{\text{inv}}(s_x)\} \ \& \ w_a = 1 \\ |s_x\rangle |s_y\rangle |w_a\rangle & \text{otherwise} \end{cases} \quad (63)$$

$$= L \begin{cases} |s_x\rangle |B\lambda_c B^{\text{inv}}(s_x)\rangle |w_a\rangle & s_y = 0^{2p(n)} \ \& \ w_a = 1 \\ |s_x\rangle |0^{2p(n)}\rangle |w_a\rangle & s_y = B\lambda_c B^{\text{inv}}(s_x) \ \& \ w_a = 1 \\ |s_x\rangle |s_y\rangle |w_a\rangle & \text{otherwise} \end{cases} \quad (64)$$

$$= \begin{cases} |v_x\rangle |\eta_c(v_x)\rangle |w_a\rangle & v_y = 0^{2n} \ \& \ w_a = 1 \\ |v_x\rangle |0^{2n}\rangle |w_a\rangle & v_y = \eta_c(v_x) \ \& \ w_a = 1 \\ |v_x\rangle |v_y\rangle |w_a\rangle & \text{otherwise} \end{cases} \quad (65)$$

$$= |v_x\rangle |v_y \oplus w_a \cdot \eta_c(v_x)\rangle |w_a\rangle \quad (66)$$

$$= \wedge(O_c) |v_x\rangle |v_y\rangle |w_a\rangle \quad (67)$$

$$= \wedge(O_c) \left| \psi_p^{(i-1)} \right\rangle_{x,y} \left| q^{(i-1)} \right\rangle_a \quad (68)$$

where the second equality follows from [Definition 15](#) and an observation made above; the fourth from [eq. \(56\)](#), [parts 1 and 5 of Lemma 36](#), and [eq. \(61\)](#); and the sixth from [Definition 5](#).

2.  $C_i = \wedge(e^{i\theta T})$  for some  $\theta \in [0, 2\pi)$ . Let  $x, y \in [p(n)]$  denote the vertex register indices that  $e^{i\theta T}$  acts on, and let  $a$  denote the workspace register index of the control qubit. Then

$$L \wedge(e^{i\theta T}) \left| \phi_p^{(i-1)} \right\rangle_{x,y} \left| q^{(i-1)} \right\rangle_a = L \wedge(e^{i\theta T}) |s_x\rangle |s_y\rangle |w_a\rangle \quad (69)$$

$$= L \begin{cases} \cos \theta |s_x\rangle |s_y\rangle |w_a\rangle + i \sin \theta |s_y\rangle |s_x\rangle |w_a\rangle & w_a = 1 \\ |s_x\rangle |s_y\rangle |w_a\rangle & \text{otherwise} \end{cases} \quad (70)$$

$$= \begin{cases} \cos \theta |v_x\rangle |v_y\rangle |w_a\rangle + i \sin \theta |v_y\rangle |v_x\rangle |w_a\rangle & w_a = 1 \\ |v_x\rangle |v_y\rangle |w_a\rangle & \text{otherwise} \end{cases} \quad (71)$$

$$= \wedge(e^{i\theta T}) |v_x\rangle |v_y\rangle |w_a\rangle \quad (72)$$

$$= \wedge(e^{i\theta T}) \left| \psi_p^{(i-1)} \right\rangle_{x,y} \left| q^{(i-1)} \right\rangle_a \quad (73)$$

where the second equality follows from [Definition 15](#), the third from [eq. \(56\)](#), and the fourth from [Definition 5](#).

3.  $C_i = \mathcal{E}$ . Let  $x, y \in [p(n)]$  denote the vertex register indices and  $a$  denote the workspace register index that  $\mathcal{E}$  acts on. Then

$$L \mathcal{E} \left| \phi_p^{(i-1)} \right\rangle_{x,y} \left| q^{(i-1)} \right\rangle_a = L \mathcal{E} |s_x\rangle |s_y\rangle |w_a\rangle \quad (74)$$

$$= L(|s_x\rangle |s_y\rangle) |w_a \oplus \delta[s_x = s_y]\rangle \quad (75)$$

$$= |v_x\rangle |v_y\rangle |w_a \oplus \delta[v_x = v_y]\rangle \quad (76)$$

$$= \mathcal{E} |v_x\rangle |v_y\rangle |w_a\rangle \quad (77)$$

$$= \mathcal{E} \left| \psi_p^{(i-1)} \right\rangle_{x,y} \left| q^{(i-1)} \right\rangle_a \quad (78)$$

where the second equality follows from [Definition 15](#), the third from [eq. \(56\)](#) and [part 4 of Lemma 36](#), and the fourth from [Definition 5](#).

4.  $C_i = \mathcal{N}$ . Let  $x \in [p(n)]$  denote the vertex register index and  $a$  denote the workspace register index that  $\mathcal{N}$  acts on. Then

$$L \tilde{\mathcal{N}} \left| \phi_p^{(i-1)} \right\rangle_x \left| q^{(i-1)} \right\rangle_a = L \tilde{\mathcal{N}} |s_x\rangle |w_a\rangle \quad (79)$$

$$= L(|s_x\rangle) |w_a \oplus \delta[s_x = \text{NOEDGESTRING}]\rangle \quad (80)$$

$$= |v_x\rangle |w_a \oplus \delta[v_x = \text{NOEDGE}]\rangle \quad (81)$$

$$= \mathcal{N} |v_x\rangle |w_a\rangle \quad (82)$$

$$= \mathcal{N} \left| \psi_p^{(i-1)} \right\rangle_x \left| q^{(i-1)} \right\rangle_a \quad (83)$$

where the second equality follows from [Definition 15](#), the third from [eq. \(56\)](#) and [part 2 of Lemma 36](#), and the fourth from [Definition 5](#).

5.  $C_i = \mathcal{Z}$ . Let  $x \in [p(n)]$  denote the vertex register index and  $a$  denote the workspace register

index that  $\mathcal{N}$  acts on. Then

$$L\tilde{\mathcal{Z}}\left|\phi_p^{(i-1)}\right\rangle_x\left|q^{(i-1)}\right\rangle_a = L\tilde{\mathcal{N}}|s_x\rangle|w_a\rangle \quad (84)$$

$$= L(|s_x\rangle)\left|w_a \oplus \delta[s_x = 0^{2p(n)}]\right\rangle \quad (85)$$

$$= |v_x\rangle|w_a \oplus \delta[v_x = 0^{2n}]\rangle \quad (86)$$

$$= \mathcal{Z}|v_x\rangle|w_a\rangle \quad (87)$$

$$= \mathcal{Z}\left|\psi_p^{(i-1)}\right\rangle_x\left|q^{(i-1)}\right\rangle_a \quad (88)$$

where the second equality follows from [Definition 15](#), the third from [eq. \(56\)](#) and [part 1 of Lemma 36](#), and the fourth from [Definition 5](#).

6.  $C_i$  is a gate on the workspace register. Since  $L$  acts on the address space,  $L$  and  $C_i$  commute. Moreover,  $C_i = \tilde{C}_i$  as we do not replace the gates acting on the workspace register in [Definition 15](#). Thus,

$$L\tilde{C}_i\left|\phi_p^{(i-1)}\right\rangle_x\left|q^{(i-1)}\right\rangle_a = \tilde{C}_iL\left|\phi_p^{(i-1)}\right\rangle_x\left|q^{(i-1)}\right\rangle_a = C_i\left|\psi_p^{(i-1)}\right\rangle_x\left|q^{(i-1)}\right\rangle_a. \quad (89)$$

□

Notice that the non-oracle gates in [Definition 5](#) do not produce any ‘new information’ about vertex labels. Based on this intuition, one might expect that the portion of  $\left|\psi_{\mathcal{A}}^{(i-1)}\right\rangle$  (respectively  $\left|\phi_{\mathcal{A}}^{(i-1)}\right\rangle$ ) that has never encountered the EXIT or a cycle will not encounter the EXIT or a cycle on the application of  $C_i$  (respectively  $\tilde{C}_i$ ) at the  $i$ th step. We formalize this as follows.

**Lemma 38.** *Let  $i \in [p(n)]$  and suppose that  $C_i$  is a genuine non-oracle gate. Then*

1.  $\left|\phi_{\text{good}}^{(i)}\right\rangle = \tilde{C}_i\left|\phi_{\text{good}}^{(i-1)}\right\rangle$  and
2.  $\left|\psi_{\text{good}}^{(i)}\right\rangle = C_i\left|\psi_{\text{good}}^{(i-1)}\right\rangle$ .

*Proof.* We show [part 1](#) using [part 7](#) of [Lemma 30](#). [Part 2](#) follows by an analogous argument that instead uses [part 8](#) of [Lemma 30](#).

Notice that in [Definition 5](#), the only gates that alter the vertex space are  $O_c$  gates or  $e^{i\theta T}$  gates. But the  $e^{i\theta T}$  gates only swap contents of the vertex register (without computing a new vertex label in a vertex register). In other words, genuine non-oracle gates do not introduce new vertex labels. This means that, as with  $\left|\phi_{\text{good}}^{(i-1)}\right\rangle$ , the subgraph corresponding to any computational basis state in the support of  $\tilde{C}_i\left|\phi_{\text{good}}^{(i-1)}\right\rangle$  does not contain the EXIT and is more than one edge away from containing a cycle. That is,  $\left|\phi_{\text{bad}}^{(i)}\right\rangle = 0$ . Therefore, by [part 7](#) of [Lemma 30](#), we have  $\tilde{C}_i\left|\phi_{\text{good}}^{(i-1)}\right\rangle = \left|\phi_{\text{good}}^{(i)}\right\rangle + \left|\phi_{\text{bad}}^{(i)}\right\rangle = \left|\phi_{\text{good}}^{(i)}\right\rangle$ . □

For the analysis of oracle gates, we now define a subset of  $\mathcal{P}_{\text{good}_{\mathcal{A}}}^{(i-1)}$  that contains indices corresponding to computational basis states in the address space that do not contain the EXIT or a cycle even after the application of an oracle gate at the  $i$ th step. Inspired by the decomposition in [Definition 33](#), we then define the components  $\left|\phi_{\text{great}}^{(i-1)}\right\rangle$  and  $\left|\psi_{\text{great}}^{(i-1)}\right\rangle$  of  $\left|\phi_{\mathcal{A}}^{(i-1)}\right\rangle$  and  $\left|\psi_{\mathcal{A}}^{(i-1)}\right\rangle$ , respectively.

**Definition 39.** Let  $i \in [p(n)]$ . Suppose that  $C_i = \wedge(O_c)$  for some  $c \in \mathcal{C}$ . Then, define

$$\mathcal{P}_{\text{great}_{\mathcal{A}}}^{(i-1)} := \left\{ p \in \mathcal{P}_{\text{good}_{\mathcal{A}}}^{(i-1)} : \exists p' \in \mathcal{P}_{\text{good}_{\mathcal{A}}}^{(i)} \text{ such that } \tilde{C}_i \left| \phi_p^{(i-1)} \right\rangle = \left| \phi_{p'}^{(i)} \right\rangle \right\}. \quad (90)$$

Also, let

$$\left| \phi_{\text{great}}^{(i-1)} \right\rangle := \sum_{p \in \mathcal{P}_{\text{great}_{\mathcal{A}}}^{(i-1)}} \sum_q \alpha_{p,q}^{(i-1)} \left| q^{(i-1)} \right\rangle \left| \phi_p^{(i-1)} \right\rangle, \quad \left| \psi_{\text{great}}^{(i-1)} \right\rangle := \sum_{p \in \mathcal{P}_{\text{great}_{\mathcal{A}}}^{(i-1)}} \sum_q \alpha_{p,q}^{(i-1)} \left| q^{(i-1)} \right\rangle \left| \psi_p^{(i-1)} \right\rangle. \quad (91)$$

In the following lemma, we show that the  $L$  mapping preserves the relationship between computational basis states in the support of  $\left| \phi_{\text{good}}^{(i-1)} \right\rangle$  and  $\left| \phi_{\text{good}}^{(i)} \right\rangle$ : applying the oracle gate to a computational basis state in the support of  $\left| \phi_{\text{good}}^{(i-1)} \right\rangle$  results in a computational basis state in the support of  $\left| \phi_{\text{good}}^{(i)} \right\rangle$  exactly when applying the oracle gate to a computational basis state in the support of  $L \left| \phi_{\text{good}}^{(i-1)} \right\rangle$  results in a computational basis state in the support of  $L \left| \phi_{\text{good}}^{(i)} \right\rangle$ .

**Lemma 40.** Let  $i \in [p(n)]$ ,  $p \in \mathcal{P}_{\text{good}_{\mathcal{A}}}^{(i-1)}$  and  $p' \in \mathcal{P}_{\text{good}_{\mathcal{A}}}^{(i)}$ . Suppose that  $C_i = \wedge(O_c)$  for some  $c \in \mathcal{C}$ . Then  $\tilde{C}_i \left| \phi_p^{(i-1)} \right\rangle = \left| \phi_{p'}^{(i)} \right\rangle$  if and only if  $C_i \left| \psi_p^{(i-1)} \right\rangle = \left| \psi_{p'}^{(i)} \right\rangle$ .

*Proof.* First, suppose that  $\tilde{C}_i \left| \phi_p^{(i-1)} \right\rangle = \left| \phi_{p'}^{(i)} \right\rangle$ . Then

$$C_i \left| \psi_p^{(i-1)} \right\rangle = L \tilde{C}_i \left| \phi_p^{(i-1)} \right\rangle = L \left| \phi_{p'}^{(i)} \right\rangle = \left| \psi_{p'}^{(i)} \right\rangle \quad (92)$$

where we used [part 1 of Lemma 37](#) in the first step, the above supposition in the second, and [Definition 34](#) in the last step.

Now, suppose that  $C_i \left| \psi_p^{(i-1)} \right\rangle = \left| \psi_{p'}^{(i)} \right\rangle$ . That is,  $L \tilde{C}_i \left| \phi_p^{(i-1)} \right\rangle = L \left| \phi_{p'}^{(i)} \right\rangle$  by [part 1 of Lemma 37](#) and [Definition 34](#). From [part 7 of Lemma 30](#), we know that  $\tilde{C}_i \left| \phi_{\text{good}}^{(i-1)} \right\rangle = \left| \phi_{\text{good}}^{(i)} \right\rangle + \left| \phi_{\text{bad}}^{(i)} \right\rangle$ . Thus, since  $\left| \phi_p^{(i-1)} \right\rangle$  is in the support of  $\left| \phi_{\text{good}}^{(i-1)} \right\rangle$  and  $\tilde{C}_i = \wedge(\tilde{O}_c)$  is a permutation of the computational basis states,  $\tilde{C}_i \left| \phi_p^{(i-1)} \right\rangle$  is in the support of  $\left| \phi_{\text{good}}^{(i)} \right\rangle + \left| \phi_{\text{bad}}^{(i)} \right\rangle$ . But by [part 3 of Lemma 30](#), the support of  $\left| \phi_{\text{good}}^{(i)} \right\rangle$  and  $\left| \phi_{\text{bad}}^{(i)} \right\rangle$  is disjoint, so  $\tilde{C}_i \left| \phi_p^{(i-1)} \right\rangle$  is either in the support of  $\left| \phi_{\text{good}}^{(i)} \right\rangle$  or  $\left| \phi_{\text{bad}}^{(i)} \right\rangle$ .

If  $\tilde{C}_i \left| \phi_p^{(i-1)} \right\rangle$  is in the support of  $\left| \phi_{\text{bad}}^{(i)} \right\rangle$ , then  $\Pi_{\text{bad}}^\phi \tilde{C}_i \left| \phi_p^{(i-1)} \right\rangle = \tilde{C}_i \left| \phi_p^{(i-1)} \right\rangle$  from [part 1 of Lemma 30](#). In other words, by [Definition 28](#)  $\tilde{C}_i \left| \phi_p^{(i-1)} \right\rangle$  is a  $\phi$ -bad state. On the other hand, since  $\left| \phi_{p'}^{(i)} \right\rangle$  is in the support of  $\left| \phi_{\text{good}}^{(i)} \right\rangle$ , it is a  $\phi$ -good state by [part 1 of Lemma 30](#) and [Definition 28](#). But then it is not possible for  $L \tilde{C}_i \left| \phi_p^{(i-1)} \right\rangle$  to be equal to  $L \left| \phi_{p'}^{(i)} \right\rangle$  by [Definition 27](#). It follows that  $\tilde{C}_i \left| \phi_p^{(i-1)} \right\rangle$  is in the support of  $\left| \phi_{\text{good}}^{(i)} \right\rangle$ . This means that there is a  $p'' \in \mathcal{P}_{\text{good}_{\mathcal{A}}}^{(i)}$  such that  $\left| \phi_{p''}^{(i)} \right\rangle = \tilde{C}_i \left| \phi_p^{(i-1)} \right\rangle$  so  $\left| \psi_{p''}^{(i)} \right\rangle = L \tilde{C}_i \left| \phi_p^{(i-1)} \right\rangle = L \left| \phi_{p''}^{(i)} \right\rangle = \left| \psi_{p'}^{(i)} \right\rangle$ . Therefore, by [Lemma 35](#), we have  $\left| \phi_{p'}^{(i)} \right\rangle = \left| \phi_{p''}^{(i)} \right\rangle = \tilde{C}_i \left| \phi_p^{(i-1)} \right\rangle$ , which proves the desired result.  $\square$

[Definition 39](#) and [Lemma 40](#) give rise to the following alternative definition of  $\mathcal{P}_{\text{great}_{\mathcal{A}}}^{(i-1)}$ .

**Corollary 41.** Let  $i \in p[n]$ . Suppose that  $C_i = \wedge(O_c)$  for some  $c \in \mathcal{C}$ . Then

$$\mathcal{P}_{\text{great}_A}^{(i-1)} = \left\{ p \in \mathcal{P}_{\text{good}_A}^{(i-1)} : \exists p' \in \mathcal{P}_{\text{good}_A}^{(i)} \text{ such that } C_i \left| \psi_p^{(i-1)} \right\rangle = \left| \psi_{p'}^{(i)} \right\rangle \right\}. \quad (93)$$

The next lemma provides a necessary and sufficient condition for membership in  $\mathcal{P}_{\text{great}_A}^{(i-1)}$ : for any index  $p \in \mathcal{P}_{\text{good}_A}^{(i-1)}$ , we have  $p \in \mathcal{P}_{\text{great}_A}^{(i-1)}$  exactly when the oracle gate at the  $i$ th step applied to the computational basis state associated with  $p$  in the address space results in a  $\phi$ -good state.

**Lemma 42.** Let  $i \in [p(n)]$ ,  $p \in \mathcal{P}_{\text{good}_A}^{(i-1)}$ . Suppose that  $C_i = \wedge(O_c)$  for some  $c \in \mathcal{C}$ . Then

1.  $p \in \mathcal{P}_{\text{great}_A}^{(i-1)}$  implies  $\Pi_{\text{good}}^\phi \tilde{C}_i \left| \phi_p^{(i-1)} \right\rangle = \tilde{C}_i \left| \phi_p^{(i-1)} \right\rangle$ .
2.  $p \notin \mathcal{P}_{\text{great}_A}^{(i-1)}$  implies  $\Pi_{\text{good}}^\phi \tilde{C}_i \left| \phi_p^{(i-1)} \right\rangle = 0$ .

*Proof.* We separately show [parts 1](#) and [2](#) using converse arguments.

1. Suppose that  $p \in \mathcal{P}_{\text{great}_A}^{(i-1)}$ . Then, by [Definition 39](#), there is some  $p' \in \mathcal{P}_{\text{good}_A}^{(i)}$  such that  $\tilde{C}_i \left| \phi_p^{(i-1)} \right\rangle = \left| \phi_{p'}^{(i)} \right\rangle$ . Thus, the computational basis state  $\tilde{C}_i \left| \phi_p^{(i-1)} \right\rangle$  is in the support of  $\left| \phi_{\text{good}}^{(i)} \right\rangle$  by [Definition 33](#). Therefore, by [part 1](#) of [Lemma 30](#),  $\Pi_{\text{good}}^\phi \tilde{C}_i \left| \phi_p^{(i-1)} \right\rangle = \tilde{C}_i \left| \phi_p^{(i-1)} \right\rangle$ .
2. Suppose that  $p \notin \mathcal{P}_{\text{great}_A}^{(i-1)}$ . Then, by [Definition 39](#),  $\tilde{C}_i \left| \phi_p^{(i-1)} \right\rangle \neq \left| \phi_{p'}^{(i)} \right\rangle$  for all  $p' \in \mathcal{P}_{\text{good}_A}^{(i)}$ . Since  $\left| \phi_{p'}^{(i)} \right\rangle$  and  $\tilde{C}_i \left| \phi_p^{(i-1)} \right\rangle$  are computational basis states (in the vertex space), it means that  $\langle \phi_p^{(i-1)} | \tilde{C}_i^\dagger \left| \phi_{p'}^{(i)} \right\rangle = 0$  for all  $p' \in \mathcal{P}_{\text{good}_A}^{(i)}$ . By [Definition 33](#), we know that  $\left| \phi_{\text{good}}^{(i)} \right\rangle$  is supported only on states in  $\left\{ \left| \phi_{p'}^{(i)} \right\rangle : p' \in \mathcal{P}_{\text{good}_A}^{(i)} \right\}$ . Thus,  $\tilde{C}_i \left| \phi_p^{(i-1)} \right\rangle$  is not in the support of  $\left| \phi_{\text{good}}^{(i)} \right\rangle$ . But since  $\tilde{C}_i$  is a permutation of computational basis states and  $p \in \mathcal{P}_{\text{good}_A}^{(i-1)}$ , it follows that  $\tilde{C}_i \left| \phi_p^{(i-1)} \right\rangle$  is in the support of  $\tilde{C}_i \left| \phi_{\text{good}}^{(i-1)} \right\rangle$ , which is equal to  $\left| \phi_{\text{good}}^{(i)} \right\rangle + \left| \phi_{\text{bad}}^{(i)} \right\rangle$  by [part 7](#) of [Lemma 30](#). This means that, by [part 3](#) of [Lemma 30](#),  $\tilde{C}_i \left| \phi_p^{(i-1)} \right\rangle$  is in the support of  $\left| \phi_{\text{bad}}^{(i)} \right\rangle$ . Therefore, by [part 1](#) of [Lemma 30](#),  $\Pi_{\text{bad}}^\phi \tilde{C}_i \left| \phi_p^{(i-1)} \right\rangle = \tilde{C}_i \left| \phi_p^{(i-1)} \right\rangle$ . Since  $\Pi_{\text{good}}^\phi$  and  $\Pi_{\text{bad}}^\phi$  are orthogonal projectors, we conclude that  $\Pi_{\text{good}}^\phi \tilde{C}_i \left| \phi_p^{(i-1)} \right\rangle = 0$ .  $\square$

Based on [Lemma 42](#), we derive another condition for membership in  $\mathcal{P}_{\text{great}_A}$ , which is analogous to the one in [Lemma 42](#). These conditions help us establish [Lemmas 44](#) and [45](#), respectively.

**Lemma 43.** Let  $i \in [p(n)]$ ,  $p \in \mathcal{P}_{\text{good}_A}^{(i-1)}$ . Suppose that  $C_i = \wedge(O_c)$  for some  $c \in \mathcal{C}$ . Then

1.  $p \in \mathcal{P}_{\text{great}_A}^{(i-1)}$  implies  $\Pi_{\text{good}}^\psi C_i \left| \psi_p^{(i-1)} \right\rangle = C_i \left| \psi_p^{(i-1)} \right\rangle$ .
2.  $p \notin \mathcal{P}_{\text{great}_A}^{(i-1)}$  implies  $\Pi_{\text{good}}^\psi C_i \left| \psi_p^{(i-1)} \right\rangle = 0$ .

*Proof.* We prove [parts 1](#) and [2](#) using [parts 1](#) and [2](#) of [Lemma 42](#), respectively.

1. Suppose that  $p \in \mathcal{P}_{\text{great}_A}^{(i-1)}$ . Note that  $L\tilde{C}_i \left| \phi_p^{(i-1)} \right\rangle = C_i \left| \psi_p^{(i-1)} \right\rangle$  by [Lemma 37](#). We know, by [part 1](#) of [Lemma 42](#), that  $\Pi_{\text{good}}^\phi \tilde{C}_i \left| \phi_p^{(i-1)} \right\rangle = \tilde{C}_i \left| \phi_p^{(i-1)} \right\rangle$ . Thus, by [Definition 27](#),  $\tilde{C}_i \left| \phi_p^{(i-1)} \right\rangle$  is a  $\phi$ -good state, which means that  $C_i \left| \psi_p^{(i-1)} \right\rangle$  is a  $\psi$ -good state. By [Definition 28](#), the desired statement follows.



2. Suppose that  $p \notin \mathcal{P}_{\text{great}_{\mathcal{A}}}^{(i-1)}$ . We know, by [part 2 of Lemma 42](#), that  $\Pi_{\text{good}}^\phi \tilde{C}_i \left| \phi_p^{(i-1)} \right\rangle = 0$ . Since  $\Pi_{\text{good}}^\phi$  and  $\Pi_{\text{bad}}^\phi$  are orthogonal projectors by [Definition 28](#),  $\Pi_{\text{bad}}^\phi \tilde{C}_i \left| \phi_p^{(i-1)} \right\rangle = \tilde{C}_i \left| \phi_p^{(i-1)} \right\rangle$ . Similar to [part 1](#), we can deduce that  $\tilde{C}_i \left| \phi_p^{(i-1)} \right\rangle$  is a  $\phi$ -bad state and  $L \tilde{C}_i \left| \phi_p^{(i-1)} \right\rangle = C_i \left| \psi_p^{(i-1)} \right\rangle$  is a  $\psi$ -bad state. Hence, by [Definition 28](#),  $\Pi_{\text{bad}}^\psi C_i \left| \psi_p^{(i-1)} \right\rangle = C_i \left| \psi_p^{(i-1)} \right\rangle$ , which implies the desired result.  $\square$

By the definition of  $\mathcal{P}_{\text{great}_{\mathcal{A}}}^{(i-1)}$ , there seems to be a bijective correspondence between elements of  $\mathcal{P}_{\text{great}_{\mathcal{A}}}^{(i-1)}$  and  $\mathcal{P}_{\text{good}_{\mathcal{A}}}^{(i)}$ . We make this precise by showing that the application of the oracle gate at the  $i$ th step to the state  $\left| \phi_{\text{great}}^{(i-1)} \right\rangle$ , defined in [Definition 39](#), results in the state  $\left| \phi_{\text{good}}^{(i)} \right\rangle$  using [Lemma 42](#).

**Lemma 44.** *Let  $i \in [p(n)]$  and  $c \in \mathcal{C}$ . Suppose that  $C_i = \wedge(O_c)$  for some  $c \in \mathcal{C}$ . Then  $\left| \phi_{\text{good}}^{(i)} \right\rangle = \tilde{C}_i \left| \phi_{\text{great}}^{(i-1)} \right\rangle$ .*

*Proof.* Expanding  $\tilde{C}_i \left| \phi_{\text{good}}^{(i-1)} \right\rangle$  using [Definitions 33](#) and [39](#) gives

$$\tilde{C}_i \left| \phi_{\text{good}}^{(i-1)} \right\rangle = \sum_{p \in \mathcal{P}_{\text{great}_{\mathcal{A}}}^{(i-1)}} \sum_q \alpha_{p,q}^{(i-1)} \left| q^{(i-1)} \right\rangle \tilde{C}_i \left| \phi_p^{(i-1)} \right\rangle + \sum_{\substack{p \in \mathcal{P}_{\text{good}_{\mathcal{A}}}^{(i-1)} \\ p \notin \mathcal{P}_{\text{great}_{\mathcal{A}}}^{(i-1)}}} \sum_q \alpha_{p,q}^{(i-1)} \left| q^{(i-1)} \right\rangle \tilde{C}_i \left| \phi_p^{(i-1)} \right\rangle. \quad (94)$$

Combining this with [part 7 of Lemma 30](#), we find

$$\left| \phi_{\text{good}}^{(i)} \right\rangle + \left| \phi_{\text{bad}}^{(i)} \right\rangle = \sum_{p \in \mathcal{P}_{\text{great}_{\mathcal{A}}}^{(i-1)}} \sum_q \alpha_{p,q}^{(i-1)} \left| q^{(i-1)} \right\rangle \tilde{C}_i \left| \phi_p^{(i-1)} \right\rangle + \sum_{\substack{p \in \mathcal{P}_{\text{good}_{\mathcal{A}}}^{(i-1)} \\ p \notin \mathcal{P}_{\text{great}_{\mathcal{A}}}^{(i-1)}}} \sum_q \alpha_{p,q}^{(i-1)} \left| q^{(i-1)} \right\rangle \tilde{C}_i \left| \phi_p^{(i-1)} \right\rangle. \quad (95)$$

Applying  $\Pi_{\text{good}}^\phi$  on both sides, and using [part 1 of Lemma 30](#) and [Lemma 42](#), we obtain

$$\left| \phi_{\text{good}}^{(i)} \right\rangle = \sum_{p \in \mathcal{P}_{\text{great}_{\mathcal{A}}}^{(i-1)}} \sum_q \alpha_{p,q}^{(i-1)} \left| q^{(i-1)} \right\rangle \tilde{C}_i \left| \phi_p^{(i-1)} \right\rangle = \tilde{C}_i \left| \phi_{\text{great}}^{(i-1)} \right\rangle, \quad (96)$$

where the last equality follows by [Definition 39](#).  $\square$

Next, we state and outline the proof of the vertex space analog of [Lemma 44](#) in [Lemma 45](#). Note that this lemma uses the induction hypothesis of [Lemma 46](#) as a premise since the definition of the state  $\left| \psi_{\text{great}}^{(i)} \right\rangle$  in [Definition 39](#) is not derived from the definition of  $\left| \psi_{\text{good}}^{(i)} \right\rangle$ , unlike the definition of  $\left| \phi_{\text{great}}^{(i)} \right\rangle$ , which is derived from the expansion of  $\left| \phi_{\text{good}}^{(i)} \right\rangle$  in [Definition 33](#).

**Lemma 45.** *Let  $i \in [p(n)]$  and  $c \in \mathcal{C}$ . Suppose that  $C_i = \wedge(O_c)$  for some  $c \in \mathcal{C}$  and  $L \left| \phi_{\text{good}}^{(i-1)} \right\rangle = \left| \psi_{\text{good}}^{(i-1)} \right\rangle$ . Then  $\left| \psi_{\text{good}}^{(i)} \right\rangle = C_i \left| \psi_{\text{great}}^{(i-1)} \right\rangle$ .*

*Proof.* The proof is similar to that of [Lemma 44](#), with the main difference being the use of the supposition that  $L \left| \phi_{\text{good}}^{(i-1)} \right\rangle = \left| \psi_{\text{good}}^{(i-1)} \right\rangle$  and [Corollary 41](#) along with [Definition 33](#) to establish an equation analogous to [eq. \(94\)](#). Equations analogous to [eqs. \(95\)](#) and [\(96\)](#) are derived using [part 8 of Lemma 30](#), and [part 2 of Lemma 30](#) and [Lemma 43](#), respectively.  $\square$

The above analysis helps establish the following key lemma, which states that the states  $|\phi_{\text{good}}^{(i)}\rangle$  and  $|\psi_{\text{good}}^{(i)}\rangle$  are related by the mapping  $L$ . Intuitively, the oracle  $\tilde{O}$  based on the address tree  $\mathcal{T}$  can faithfully simulate (modulo mapping  $L$ ) the portion of the state  $|\psi_{\mathcal{A}}^{(i)}\rangle$  of the algorithm  $\mathcal{A}$  that does not encounter the EXIT or a cycle.

**Lemma 46.** For all  $i \in [p(n)] \cup \{0\}$ ,  $L|\phi_{\text{good}}^{(i)}\rangle = |\psi_{\text{good}}^{(i)}\rangle$ .

*Proof.* We prove this lemma by induction on  $i$ .

For  $i = 0$ , note that

$$|\phi_{\text{good}}^{(0)}\rangle = |\phi_{\mathcal{A}}^{(0)}\rangle - |\phi_{\text{ugly}}^{(0)}\rangle = |\phi_{\mathcal{A}}^{(0)}\rangle = |\text{EMPTYSTRING}\rangle \otimes |0^{2p(n)}\rangle^{\otimes(p(n)-1)} \otimes |0\rangle_{\text{workspace}} \quad (97)$$

where the first equality follows from [part 5 of Lemma 30](#), the second equality follows from [Definition 29](#), and the last equality follows from [Definition 15](#). Similarly,

$$|\psi_{\text{good}}^{(0)}\rangle = |\psi_{\mathcal{A}}^{(0)}\rangle - |\psi_{\text{ugly}}^{(0)}\rangle = |\psi_{\mathcal{A}}^{(0)}\rangle = |\text{ENTRANCE}\rangle \otimes |0^{2n}\rangle^{\otimes(p(n)-1)} \otimes |0\rangle_{\text{workspace}} \quad (98)$$

where the first equality follows from [part 6 of Lemma 30](#), the second equality follows from [Definition 29](#), and the last equality follows from [Definition 5](#). The statement of the lemma for  $i = 0$  follows by noticing that  $L(\text{EMPTYSTRING}) = \text{ENTRANCE}$  and  $L(0^{2n}) = 0^{2p(n)}$  by [eq. \(56\)](#).

Now, assume that  $L|\phi_{\text{good}}^{(i-1)}\rangle = |\psi_{\text{good}}^{(i-1)}\rangle$  for some  $i \in [p(n)]$ . Then, we have two cases depending on  $C_i$ :

1.  $C_i$  is a genuine non-oracle gate. Then

$$L|\phi_{\text{good}}^{(i)}\rangle = L\tilde{C}_i|\phi_{\text{good}}^{(i-1)}\rangle \quad (99)$$

$$= \sum_{p \in \mathcal{P}_{\text{good}, \mathcal{A}}^{(i-1)}} \sum_q \alpha_{p,q}^{(i-1)} L\tilde{C}_i|q^{(i-1)}\rangle |\phi_p^{(i-1)}\rangle \quad (100)$$

$$= \sum_{p \in \mathcal{P}_{\text{good}, \mathcal{A}}^{(i-1)}} \sum_q \alpha_{p,q}^{(i-1)} C_i|q^{(i-1)}\rangle |\psi_p^{(i-1)}\rangle \quad (101)$$

$$= C_i|\psi_{\text{good}}^{(i-1)}\rangle \quad (102)$$

$$= |\psi_{\text{good}}^{(i)}\rangle \quad (103)$$

where the first and last steps follow from [parts 1 and 2 of Lemma 38](#), respectively; the second follows from [Definition 33](#); the third follows from [Lemma 37](#); and the fourth follows from the induction hypothesis.

2.  $C_i = \wedge(O_c)$  for some  $c \in \mathcal{C}$ . Then

$$L|\phi_{\text{good}}^{(i)}\rangle = L\tilde{C}_i|\phi_{\text{great}}^{(i-1)}\rangle \quad (104)$$

$$= \sum_{p \in \mathcal{P}_{\text{great}, \mathcal{A}}^{(i-1)}} \sum_q \alpha_{p,q}^{(i-1)} L\tilde{C}_i|q^{(i-1)}\rangle |\phi_p^{(i-1)}\rangle \quad (105)$$

$$= \sum_{p \in \mathcal{P}_{\text{great}, \mathcal{A}}^{(i-1)}} \sum_q \alpha_{p,q}^{(i-1)} C_i|q^{(i-1)}\rangle |\psi_p^{(i-1)}\rangle \quad (106)$$

$$= C_i|\psi_{\text{great}}^{(i-1)}\rangle \quad (107)$$

$$= |\psi_{\text{good}}^{(i)}\rangle \quad (108)$$

where the first step follows from [Lemma 44](#), the second and fourth follow from [Definition 39](#), the third follows from [Lemma 37](#), and the last follows from the induction hypothesis and [Lemma 45](#).  $\square$

Finally, we show the following relationship between the norms of  $|\phi_{\text{good}}^{(i)}\rangle$  and  $|\psi_{\text{good}}^{(i)}\rangle$ , which will be very useful in bounding the probability of success of Algorithm  $\mathcal{A}$  in [Section 4.6](#).

**Lemma 47.** *Let  $i \in [p(n)] \cup \{0\}$ . Then  $\| |\phi_{\text{good}}^{(i)}\rangle \| = \| |\psi_{\text{good}}^{(i)}\rangle \|$ .*

*Proof.* It is clear, by [Definition 33](#), that for  $p, p' \in \mathcal{P}_{\text{good}, \mathcal{A}}^{(i)}$  with  $p \neq p'$ ,  $|\phi_p^{(i)}\rangle \neq |\phi_{p'}^{(i)}\rangle$ . Since  $|\phi_p^{(i)}\rangle$  and  $|\phi_{p'}^{(i)}\rangle$  are computational basis states, this means that  $\langle \phi_p^{(i)} | \phi_{p'}^{(i)} \rangle = 0$  whenever  $p \neq p'$ . Notice that  $|\psi_p^{(i)}\rangle$  and  $|\psi_{p'}^{(i)}\rangle$  are in the support of  $|\psi_{\text{good}}^{(i)}\rangle$  by [Lemma 46](#). The contrapositive of [Lemma 35](#) implies that for  $p \neq p'$ ,  $|\psi_p^{(i)}\rangle \neq |\psi_{p'}^{(i)}\rangle$ , which essentially means that  $\langle \psi_p^{(i)} | \psi_{p'}^{(i)} \rangle = 0$  since  $|\psi_p^{(i)}\rangle$  and  $|\psi_{p'}^{(i)}\rangle$  are computational basis states. Combining these observations with [Lemma 46](#), we get

$$\| |\psi_{\text{good}}^{(i)}\rangle \| = \| L|\phi_{\text{good}}^{(i)}\rangle \| \quad (109)$$

$$= \left\| \sum_{p \in \mathcal{P}_{\text{good}, \mathcal{A}}^{(i)}} \sum_q \alpha_{p,q}^{(i)} |q^{(i)}\rangle |\psi_p^{(i)}\rangle \right\| \quad (110)$$

$$= \sum_{p \in \mathcal{P}_{\text{good}, \mathcal{A}}^{(i)}} \sum_q |\alpha_{p,q}^{(i)}|^2 \quad (111)$$

$$= \left\| \sum_{p \in \mathcal{P}_{\text{good}, \mathcal{A}}^{(i)}} \sum_q \alpha_{p,q}^{(i)} |q^{(i)}\rangle |\phi_p^{(i)}\rangle \right\| \quad (112)$$

$$= \| |\phi_{\text{good}}^{(i)}\rangle \| \quad (113)$$

as claimed.  $\square$

## 4.6 The state is mostly good

In the remainder of this section, we conclude that it is hard for any rooted genuine quantum algorithm to find the EXIT (and hence, an ENTRANCE–EXIT path). We achieve this goal by bounding the mass of the quantum state  $|\psi_{\mathcal{A}}\rangle$  associated with any arbitrarily chosen rooted genuine quantum algorithm  $\mathcal{A}$  that lies in the  $\psi$ -BAD subspace. We proceed by first using the result of [Section 5](#) to bound the mass of the quantum state  $|\phi_{\mathcal{A}}^{(i)}\rangle$  that lies in the  $\phi$ -BAD subspace.

**Lemma 48.** *Let  $i \in [p(n)] \cup \{0\}$ . Then  $\left\| \Pi_{\text{bad}}^{\phi} |\phi_{\mathcal{A}}^{(i)}\rangle \right\|^2 \leq 4p(n)^4 \cdot 2^{-n/3}$ .*

*Proof.* By [Definition 28](#), each computational basis state in  $\Pi_{\text{bad}}^{\phi} |\phi_{\mathcal{A}}^{(i)}\rangle$  is a  $\phi$ -bad state. Therefore, the  $i$ th step of the classical [Algorithm 2](#) outputs a computational basis state  $|\psi^{(i)}\rangle$  corresponding to a subgraph of  $\mathcal{G}$  that contains the EXIT or is at most one edge away from containing a cycle using at most  $i \leq p(n)$  queries with probability  $\left\| \Pi_{\text{bad}}^{\phi} |\phi_{\mathcal{A}}^{(i)}\rangle \right\|^2$ . In the case  $|\psi^{(i)}\rangle$  does not contain a cycle, we can run a depth-first search of length 1 on the subgraph corresponding to  $|\psi^{(i)}\rangle$  using at most  $i$  additional queries. Hence, we have found the EXIT or a cycle using at most  $2i \leq 2p(n)$  classical queries with probability  $\left\| \Pi_{\text{bad}}^{\phi} |\phi_{\mathcal{A}}^{(i)}\rangle \right\|^2$ . Noting that [Algorithm 2](#) has the form of the classical query algorithms considered by [Theorem 72](#), we see that  $\left\| \Pi_{\text{bad}}^{\phi} |\phi_{\mathcal{A}}^{(i)}\rangle \right\|^2 \leq 4p(n)^4 \cdot 2^{-n/3}$ .  $\square$

From the result of [Lemma 48](#), one might intuitively conjecture that the size of the portion of the state  $|\phi_{\mathcal{A}}^{(i)}\rangle$  after  $i$  steps that encountered the EXIT or a near-cycle at some point in its history is small. We formalize this as follows.

**Lemma 49.** *For all  $i \in [p(n)] \cup \{0\}$ ,  $\left\| \left| \phi_{\text{ugly}}^{(i)} \right\rangle \right\| \leq 2ip(n)^2 \cdot 2^{-n/6}$ .*

*Proof.* We prove the lemma by induction on  $i$ . The base case ( $i = 0$ ) is easy to observe as  $\left\| \left| \phi_{\text{ugly}}^{(0)} \right\rangle \right\| = 0$ . Now, pick any  $i \in [p(n)]$  and suppose that the lemma is true for  $i - 1$ , i.e.,  $\left\| \left| \phi_{\text{ugly}}^{(i-1)} \right\rangle \right\| \leq 2(i-1)p(n)^2 \cdot 2^{-n/6}$ . Then, by [Definitions 28](#) and [29](#) and [part 9](#) of [Lemma 30](#),

$$\left| \phi_{\text{ugly}}^{(i)} \right\rangle = \left| \phi_{\text{bad}}^{(i)} \right\rangle + \tilde{C}_i \left| \phi_{\text{ugly}}^{(i-1)} \right\rangle \quad (114)$$

$$= \left| \phi_{\text{bad}}^{(i)} \right\rangle + \Pi_{\text{bad}}^{\phi} \tilde{C}_i \left| \phi_{\text{ugly}}^{(i-1)} \right\rangle + \Pi_{\text{good}}^{\phi} \tilde{C}_i \left| \phi_{\text{ugly}}^{(i-1)} \right\rangle \quad (115)$$

$$= \Pi_{\text{bad}}^{\phi} \left| \phi_{\mathcal{A}}^{(i)} \right\rangle + \Pi_{\text{good}}^{\phi} \tilde{C}_i \left| \phi_{\text{ugly}}^{(i-1)} \right\rangle, \quad (116)$$

so we have

$$\left\| \left| \phi_{\text{ugly}}^{(i)} \right\rangle \right\| = \left\| \Pi_{\text{bad}}^{\phi} \left| \phi_{\mathcal{A}}^{(i)} \right\rangle + \Pi_{\text{good}}^{\phi} \tilde{C}_i \left| \phi_{\text{ugly}}^{(i-1)} \right\rangle \right\| \quad (117)$$

$$\leq \left\| \Pi_{\text{bad}}^{\phi} \left| \phi_{\mathcal{A}}^{(i)} \right\rangle \right\| + \left\| \Pi_{\text{good}}^{\phi} \tilde{C}_i \left| \phi_{\text{ugly}}^{(i-1)} \right\rangle \right\| \quad (118)$$

$$\leq \left\| \Pi_{\text{bad}}^{\phi} \left| \phi_{\mathcal{A}}^{(i)} \right\rangle \right\| + \left\| \left| \phi_{\text{ugly}}^{(i-1)} \right\rangle \right\| \quad (119)$$

$$= \frac{2ip(n)^2}{2^{n/6}} \quad (120)$$

where the second step follows by the triangle inequality, the third by the fact that applying a unitary  $\tilde{C}_i$  and the projector  $\Pi_{\text{good}}^\phi$  cannot increase the norm of any vector, and the fourth by [Lemma 48](#) and the induction hypothesis.  $\square$

The bound on the size of the portion of the state  $|\phi_{\mathcal{A}}^{(i)}\rangle$  after  $i$  steps that never encountered the EXIT or a near-cycle directly follows from [Lemma 49](#) as shown by the following corollary.

**Corollary 50.** *Let  $i \in [p(n)]$ . Then  $\left\| |\phi_{\text{good}}^{(i)}\rangle \right\| \geq 1 - 2ip(n)^2 \cdot 2^{-n/6}$ .*

*Proof.* Observe that

$$\left\| |\phi_{\text{good}}^{(i)}\rangle \right\| = \left\| |\phi_{\mathcal{A}}^{(i)}\rangle - |\phi_{\text{ugly}}^{(i)}\rangle \right\| \geq \left\| |\phi_{\mathcal{A}}^{(i)}\rangle \right\| - \left\| |\phi_{\text{ugly}}^{(i)}\rangle \right\| \geq 1 - \frac{2ip(n)^2}{2^{n/6}} \quad (121)$$

where the equality follows by [Definition 29](#), the first inequality is an application of the triangle inequality, and the second inequality follows by [Lemma 49](#) and the fact that  $|\phi_{\mathcal{A}}^{(i)}\rangle$  is a quantum state.  $\square$

In the next lemma, we bound the mass of the portion of the state  $|\psi_{\mathcal{A}}^{(i)}\rangle$  after  $i$  steps that encountered the EXIT or a near-cycle at some point in its history. This is a crucial lemma for our result in this section where we invoke [Lemma 47](#) to deduce a statement about the quantum state of the genuine algorithm  $\mathcal{A}$  using known properties of the state of our classical simulation of  $\mathcal{A}$ .

**Lemma 51.** *Let  $i \in [p(n)]$ . Then  $\left\| |\psi_{\text{ugly}}^{(i)}\rangle \right\|^2 \leq 4i^2p(n)^2 \cdot 2^{-n/6}$ .*

*Proof.* Observe that

$$\left\| |\psi_{\text{ugly}}^{(i)}\rangle \right\| = \left\| \sum_{j \in [i]} C_{j,i} |\psi_{\text{bad}}^{(j)}\rangle \right\| \quad (122)$$

$$\leq \sum_{j \in [i]} \left\| C_{j,i} |\psi_{\text{bad}}^{(j)}\rangle \right\| \quad (123)$$

$$= \sum_{j \in [i]} \left\| |\psi_{\text{bad}}^{(j)}\rangle \right\| \quad (124)$$

where the first step follows by [Definition 29](#), the second by triangle inequality, and the third by the fact that the unitary  $C_{j,i}$  preserves norms.

Thus, we have

$$\left\| \left| \psi_{\text{ugly}}^{(i)} \right\rangle \right\|^2 \leq \left( \sum_{j \in [i]} \left\| \left| \psi_{\text{bad}}^{(j)} \right\rangle \right\| \right)^2 \quad (125)$$

$$\leq \sum_{j \in [i]} i \left\| \left| \psi_{\text{bad}}^{(j)} \right\rangle \right\|^2 \quad (126)$$

$$= i \left( 1 - \left\| \left| \psi_{\text{good}}^{(i)} \right\rangle \right\|^2 \right) \quad (127)$$

$$= i \left( 1 - \left\| \left| \phi_{\text{good}}^{(i)} \right\rangle \right\|^2 \right) \quad (128)$$

$$\leq i \left( 1 - \left( 1 - \frac{2ip(n)^2}{2^{n/6}} \right)^2 \right) \quad (129)$$

$$\leq \frac{4i^2 p(n)^2}{2^{n/6}} \quad (130)$$

where the two equalities follow by [Lemmas 31](#) and [47](#), respectively, and the next-to-last inequality follows by [Corollary 50](#).  $\square$

We are now ready to establish our main theorem, which formally proves the hardness of finding an ENTRANCE–EXIT path for genuine, rooted quantum query algorithms.

**Theorem 52.** *No genuine, rooted quantum query algorithm for the path-finding problem can find a path from ENTRANCE to EXIT with more than exponentially small probability.*

*Proof.* Since we let  $\mathcal{A}$  be an arbitrary genuine, rooted quantum algorithm, it is sufficient to show that  $\mathcal{A}$  cannot find a path from ENTRANCE to EXIT with more than exponentially small probability. Note that, by [Definition 27](#), any computational basis state  $|\psi\rangle$  that corresponds to a subgraph that stores an ENTRANCE to EXIT path must be  $\psi$ -bad. That is, such a  $|\psi\rangle$  must be in the support of  $\Pi_{\text{bad}}^\psi |\psi_{\mathcal{A}}\rangle$  from [Definition 28](#). Recall from [Definition 6](#) that the genuine algorithm  $\mathcal{A}$  measures the state  $|\psi_{\mathcal{A}}\rangle$  and outputs the resulting set of vertices. Thus, the probability that the genuine, rooted quantum query algorithm  $\mathcal{A}$  finds an ENTRANCE to EXIT path is at most

$$\left\| \Pi_{\text{bad}}^\psi |\psi_{\mathcal{A}}\rangle \right\|^2 = \left\| \Pi_{\text{bad}}^\psi \left| \psi_{\mathcal{A}}^{(p(n))} \right\rangle \right\|^2 \quad (131)$$

$$= \left\| \Pi_{\text{bad}}^\psi \left| \psi_{\text{good}}^{(p(n))} \right\rangle + \Pi_{\text{bad}}^\psi \left| \psi_{\text{ugly}}^{(p(n))} \right\rangle \right\|^2 \quad (132)$$

$$= \left\| \Pi_{\text{bad}}^\psi \left| \psi_{\text{ugly}}^{(p(n))} \right\rangle \right\|^2 \quad (133)$$

$$\leq \left\| \left| \psi_{\text{ugly}}^{(p(n))} \right\rangle \right\|^2 \quad (134)$$

$$\leq \frac{4p(n)^4}{2^{n/6}} \quad (135)$$

where we used [Definition 29](#) in the first step, [part 6](#) of [Lemma 30](#) in the second, [part 2](#) of [Lemma 30](#) in the third, the fact that applying a projector  $\Pi_{\text{bad}}^\psi$  cannot increase the norm of any vector in the fourth step, and [Lemma 51](#) in the last.  $\square$

## 5 Hardness of classical cycle finding with a 3-color oracle

In this section, we analyze the classical query complexity of finding the EXIT or a cycle in a randomly chosen 3-colored welded tree graph of size  $n$ . More precisely, we show in [Theorem 72](#) that the probability of finding the EXIT or a cycle for a natural class of classical algorithms is exponentially small even for a welded tree graph whose vertices are permuted according to the distribution  $D_n$  specified in [Definition 60](#) below. Informally,  $D_n$  gives rise to the uniform distribution on welded tree graphs over the set that is constructed by fixing a 3-colored welded tree graph  $\mathcal{G}$  and randomizing the edges of the WELD (defined in [Definition 57](#)), making sure that the resulting graphs are valid 3-colored welded tree graphs.

The key ingredient of our analysis is [Lemma 67](#) (see also [Corollary 68](#)), which informally says that for a welded tree graph sampled according to the aforementioned distribution, it is exponentially unlikely for a certain natural class of classical algorithms (i) to get ‘close’ to the ENTRANCE or the EXIT starting on any vertex in the WELD without backtracking, or (ii) to encounter two WELD vertices that are connected by multiple ‘short’ paths. Note that statement (i) implies that it is hard for any such classical algorithm to find the EXIT whereas statement (ii) has a similar implication for finding a cycle.

An astute reader might notice the resemblance of [Lemma 67](#) with Lemma 8 of [[CCD<sup>+</sup>03](#)]. Indeed, the latter lemma shows that it is hard for any classical algorithm with access to a colorless welded tree oracle to satisfy either statement (i) or (ii) mentioned above. However, the argument of [[CCD<sup>+</sup>03](#)] is different than ours in two major ways: our proof is by induction, and we use randomness of the WELD and graph theoretic properties of any 3-coloring of a welded tree graph to argue the unlikeliness of statements (i) and (ii) while they use the hardness of guessing multiple coin tosses along with randomness of the WELD.

We begin by specifying basic notions about binary trees and welded tree graphs that facilitate proving [Lemma 55](#) and [Corollary 56](#).

**Definition 53.** Let  $T$  be a binary tree of height  $n$ . We say that a vertex of  $T$  is in column  $i$  if its distance from the root of  $T$  is  $i$ , and an edge in  $T$  is at level  $i$  if it connects a vertex in column  $i - 1$  to a vertex in column  $i$ . We extend this notion to the welded tree graphs. Precisely, a vertex of a welded tree graph  $\mathcal{G}$  is in column  $i$  if its distance from the ENTRANCE is  $i$ , and an edge in  $\mathcal{G}$  is at level  $i$  if it connects a vertex in column  $i - 1$  to a vertex in column  $i$ .

**Definition 54.** Let  $T$  be a binary tree of height  $n$ , which is edge-colored using the 3 colors in  $\mathcal{C}$ . Let  $v$  be any leaf of  $T$ , let  $j \in [n]$ , and let  $u$  be the ancestor of  $v$  in  $T$  that is distance  $j$  away from  $v$ . We define  $t_v^j$  to be the length- $j$  sequence of colors from  $v$  to  $u$ .

The following lemma formalizes the observation that the colors of edges at any level of a binary tree are close to uniformly distributed among the possible 3 colors.

**Lemma 55.** Let  $T$  be a binary tree of height  $n$  that is edge-colored using the 3 colors in  $\mathcal{C}$ . Let  $c_* \in \mathcal{C}$  denote the unique color such that there is no  $c_*$ -colored edge incident to the root of  $T$ . For each  $c \in \mathcal{C}$  and  $i \in [n]$ , let  $\gamma(c, i)$  denote the number of  $c$ -colored edges at level  $i$ . Then

$$\gamma(c, i) = \begin{cases} \lfloor 2^i/3 \rfloor & i \text{ is odd and } c = c_*, \text{ or } i \text{ is even and } c \neq c_* \\ \lceil 2^i/3 \rceil & \text{otherwise.} \end{cases} \quad (136)$$

*Proof.* We prove this lemma by induction on  $i$ . An edge is at level 1 in  $T$  if and only if it is incident to the root of  $T$ . The base case of the lemma directly follows.

Assume that this lemma is true for some  $i \in [n - 1]$ . Suppose that  $i$  is odd. Note that, for any  $c \in \mathcal{C}$ , any vertex in column  $i$  is connected to a vertex in column  $i + 1$  with a  $c$ -colored edge if and only if it is connected to a vertex in column  $i - 1$  with a  $c'$ -colored edge for  $c \neq c'$ . Thus the number of  $c$ -colored edges at level  $i + 1$  is

$$\gamma(c, i + 1) = \sum_{\substack{c' \in \mathcal{C} \\ c' \neq c}} \gamma(c', i) \quad (137)$$

$$= \begin{cases} 2 \lfloor 2^i / 3 \rfloor & c = c_* \\ \lfloor 2^i / 3 \rfloor + \lfloor 2^i / 3 \rfloor & \text{otherwise} \end{cases} \quad (138)$$

$$= \begin{cases} \lfloor 2^{i+1} / 3 \rfloor & c = c_* \\ \lfloor 2^{i+1} / 3 \rfloor & \text{otherwise.} \end{cases} \quad (139)$$

The analysis for even  $i$  is very similar.  $\square$

**Lemma 55** directly implies the following corollary, which informally states that the number of paths from a particular level  $n - j$  to the leaves of a binary tree are almost-uniformly distributed among all possible color sequences of length  $j$  that do not contain an even-length palindrome.

**Corollary 56.** *Let  $T$  be a binary tree of height  $n$ , which is edge-colored using the 3 colors in  $\mathcal{C}$ . Let  $j \in [n]$  and fix a length- $j$  sequence of colors  $t \in \mathcal{C}^j$  that does not contain an even-length palindrome. Then the number of leaves  $v$  of  $T$  satisfying  $t_v^j = t$  is at most  $\lfloor 2^{n-j+1} / 3 \rfloor$ .*

*Proof.* Let  $c \in \mathcal{C}$  be the last color appearing in the sequence  $t$ . Note that any ancestor of a leaf  $v$  of  $T$  that is distance  $j$  away from  $v$  must be in column  $n - j$  of  $T$ . For each vertex  $u$  in column  $n - j$  with some edge at level  $n - j + 1$  incident to  $u$  being  $c$ -colored, there is exactly one leaf  $v$  such that  $v$  is a descendant of  $u$  and  $t_v^j = t$ . By **Lemma 55**, there are at most  $\lfloor 2^{n-j+1} / 3 \rfloor$   $c$ -colored edges at level  $n - j + 1$ . Therefore, there are at most  $\lfloor 2^{n-j+1} / 3 \rfloor$  leaves of  $T$  satisfying  $t_v^j = t$ .  $\square$

Consider the following induced subgraphs of  $\mathcal{G}$ .

**Definition 57.** *Define  $T_L$ ,  $T_R$ , and WELD to be the induced subgraphs of  $\mathcal{G}$  on vertices in columns  $\{0, \dots, n\}$ , columns  $\{n + 1, \dots, 2n + 1\}$ , and columns  $\{n, n + 1\}$  of  $\mathcal{G}$ , respectively.*

Informally,  $T_L$  and  $T_R$  are induced subgraphs of  $\mathcal{G}$  on vertices in the left and right binary trees of  $\mathcal{G}$ , respectively, while WELD is the induced subgraph of  $\mathcal{G}$  on the leaves of the left and right binary trees of  $\mathcal{G}$ . Note that  $T_L$  and  $T_R$  are height- $n$  subtrees of  $\mathcal{G}$  rooted at ENTRANCE and EXIT, respectively. Furthermore, the vertices of  $T_L$  and  $T_R$  provide a bipartition of the vertices of  $\mathcal{G}$ , and the edges of  $T_L$ ,  $T_R$ , and WELD provide a tripartition of the edges of  $\mathcal{G}$ .

For the rest of this section, we will assume that  $n$  is a multiple of 3 for simplicity of presentation. Indeed, this assumption is without loss of generality as one can replace each  $n/3$  appearing in this section with  $\lfloor n/3 \rfloor$  or  $\lceil n/3 \rceil$  as appropriate. Next, we consider  $2^{2n/3}$  disjoint subtrees of  $T_L$  (respectively  $T_R$ ), each of which contains (as leaves)  $2^{n/3}$  leaves of  $T_L$  (respectively  $T_R$ ).

**Definition 58.** *Fix an ordering of the vertices of  $T_L$  (respectively  $T_R$ ) in column  $2n/3$ . For any  $i \in [2^{2n/3}]$ , let  $T_{L_i}$  (respectively  $T_{R_i}$ ) denote the subtree of  $T_L$  (respectively  $T_R$ ) that is a binary tree of height  $n/3$  rooted at the  $i$ th vertex in column  $2n/3$  of  $T_L$  (respectively  $T_R$ ). Moreover, let  $\mathbb{T} := \{T_{L_i}, T_{R_i} : i \in [2^{2n/3}]\}$ .*

We categorize the vertices of WELD depending on whether they belong to  $T_L$  or  $T_R$ , and on the colors of the edges joining them to non-WELD vertices.



**Definition 59.** For any leaf  $v$  of the tree  $T_L$  and any  $c \in \mathcal{C}$ , if the color of the edge connecting  $v$  with  $T_L$  in  $\mathcal{G}$  is  $c$ , then we say that  $v$  is a  $c$ -left vertex. Similarly, we define the notion of a  $c$ -right vertex for each  $c \in \mathcal{C}$ .

As an example, the vertices colored lavender and plum in Figure 7a are red-left vertices.

Next, we define permutations that map valid 3-colored welded tree graphs to valid 3-colored welded tree graphs (as we show in Lemma 61). Note that Definition 59 partitions the vertices of WELD into 6 parts. The following definition is crucial for describing a distribution of welded tree graphs that is classically ‘hard’.

**Definition 60** (Color-preserving permutations). A permutation  $\sigma$  of the vertices of WELD is a color-preserving permutation if for any vertex  $v$  of WELD, and any  $c \in \mathcal{C}$ ,  $v$  is  $c$ -left (respectively  $c$ -right) iff  $\sigma(v)$  is  $c$ -left (respectively  $c$ -right). We will sometimes refer to a color-preserving permutation  $\sigma$  as a permutation of  $\mathcal{V}_{\mathcal{G}}$  that acts as  $\sigma$  on vertices of WELD and as identity on non-WELD vertices. For any color-preserving permutation  $\sigma$ , let  $\text{WELD}^\sigma$  denote the graph obtained by applying  $\sigma$  to the vertices of WELD. For any color-preserving permutation  $\sigma$ , let  $\mathcal{G}^\sigma$  denote the graph on vertex set  $\mathcal{V}_{\mathcal{G}}$  obtained by permuting the WELD edges of  $\mathcal{G}$  according to  $\sigma$  (and leaving the rest of the graph  $\mathcal{G}$  as it is): if  $u, v$  are WELD vertices, then there is an edge of color  $c \in \mathcal{C}$  in  $\mathcal{G}$  joining vertices  $u$  and  $v$  if and only if there is an edge of color  $c$  in  $\mathcal{G}^\sigma$  joining vertices  $\sigma(u)$  and  $\sigma(v)$ ; otherwise, there is an edge of color  $c \in \mathcal{C}$  in  $\mathcal{G}$  joining vertices  $u$  and  $v$  if and only if there is an edge of color  $c$  in  $\mathcal{G}^\sigma$  joining vertices  $u$  and  $v$ . Define  $D_n$  to be the uniform distribution over all color-preserving permutations  $\sigma$ .

Note that  $\mathcal{V}_{\mathcal{G}^\sigma} = \mathcal{V}_{\mathcal{G}}$ , and the non-WELD vertices and edges of  $\mathcal{G}$  remain invariant under  $\sigma$ . Therefore, the induced subgraph of  $\mathcal{G}^\sigma$  on vertices of  $T_L$  (respectively  $T_R$ ) is  $T_L$  (respectively  $T_R$ ). Moreover,  $\text{WELD}^\sigma$  is the induced subgraph of  $\mathcal{G}^\sigma$  on vertices of WELD. Figure 7 illustrates an example of a color-preserving permutation.

For each  $c \in \mathcal{C}$ , by Lemma 55, we have at least  $\lfloor 2^n/3 \rfloor$   $c$ -left and at least  $\lfloor 2^n/3 \rfloor$   $c$ -right vertices in  $\mathcal{G}$ . Hence, there are at least  $(\lfloor 2^n/3 \rfloor!)^6$  color-preserving permutations.

We now verify that the graphs obtained by applying color-preserving permutations on  $\mathcal{G}$  are valid 3-colored welded tree graphs.

**Lemma 61.** Let  $\sigma$  be a color-preserving permutation. Then  $\mathcal{G}^\sigma$  is a valid 3-colored welded tree graph.

*Proof.* We first argue that  $\mathcal{G}^\sigma$  is a valid welded tree graph. Recall that the edges of  $\mathcal{G}$  that are not in the WELD remain invariant under  $\sigma$ . Thus, it remains to show that  $\text{WELD}^\sigma$  is a cycle alternating between the vertices in columns  $n$  and  $n+1$ . Since  $\mathcal{G}$  is a welded tree graph, WELD is a cycle on vertices denoted by  $v_1, \dots, v_{2^{n+1}}$  such that  $v_{2i-1}$  is a vertex in column  $n$  and  $v_{2i}$  is a vertex in column  $n+1$  for each  $i \in [2^n]$ , and  $v_i$  is joined to  $v_{i+1 \bmod 2^{n+1}}$  and  $v_{i-1 \bmod 2^{n+1}}$  for each  $i \in [2^{n+1}]$ . Therefore, since  $\sigma$  is color-preserving, for each  $i \in [2^n]$ ,  $\sigma(v_{2i-1})$  is a vertex in column  $n$  and  $\sigma(v_{2i})$  is a vertex in column  $n+1$ , and for each  $i \in [2^{n+1}]$ ,  $\sigma(v_i)$  is joined to  $\sigma(v_{i+1 \bmod 2^{n+1}})$  and  $\sigma(v_{i-1 \bmod 2^{n+1}})$ . It follows that  $\text{WELD}^\sigma$  is a cycle alternating between the vertices in columns  $n$  and  $n+1$ .

Now, we claim that  $\mathcal{G}^\sigma$  admits a valid 3-coloring. Let  $v$  be any vertex of WELD. Without loss of generality, assume that  $v$  is red-right. Then, as  $\mathcal{G}$  is a valid welded tree graph,  $v$  is joined to two vertices  $v_g$  and  $v_b$  of WELD with a green and a blue edge respectively (along with a vertex of  $T_R$  with a red edge). Since  $\sigma$  is color-preserving, we know that  $\sigma(v)$  is also red-right in  $\mathcal{G}$ , and is joined to a vertex  $v_r$  of  $T_R$  with a red edge. Therefore, in  $\mathcal{G}^\sigma$ ,  $\sigma(v)$  is joined to  $v_r$  with a red edge and to vertices  $\sigma(v_g)$  and  $\sigma(v_b)$  of WELD with a green and a blue edge, respectively. On the other hand, non-WELD vertices of  $\mathcal{G}$  and their adjacency lists are unchanged by  $\sigma$ . Our desired claim follows.  $\square$

Recall that Definition 2 specifies the classical oracle function  $\eta_c^\sigma$  for each  $c \in \mathcal{C}$  associated with  $\mathcal{G}^\sigma$  for the identity permutation  $\sigma$ . The following definition generalizes this by specifying the

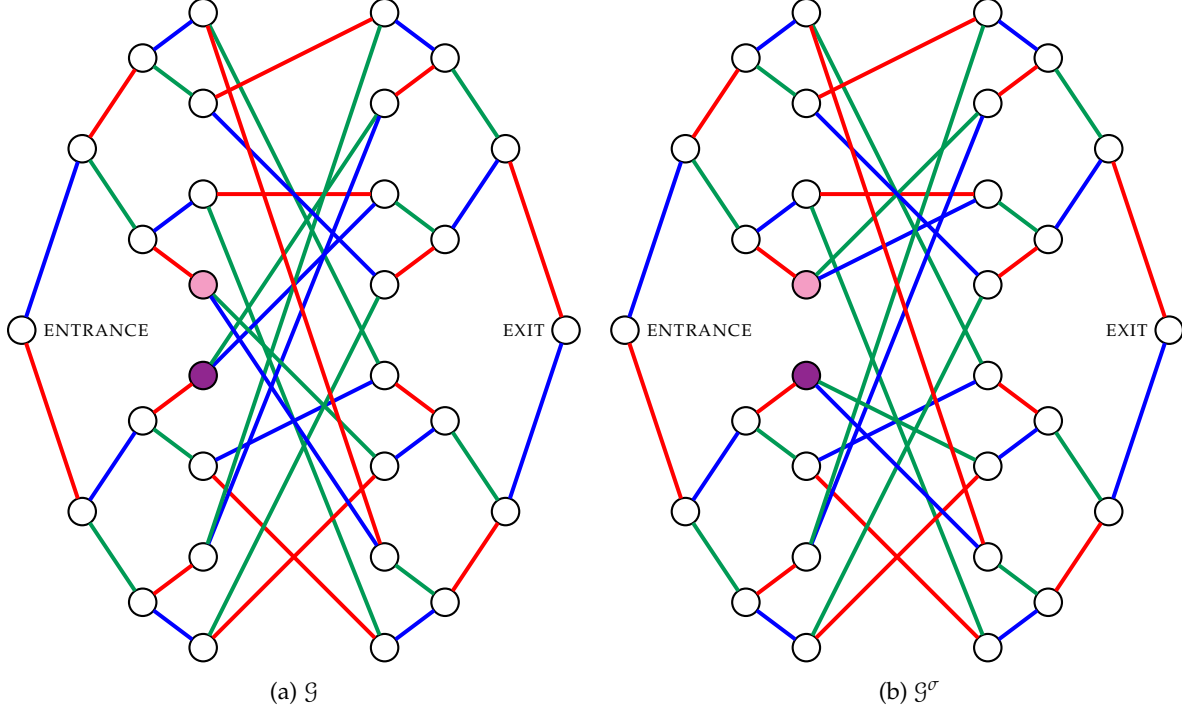

Figure 7: Example of a color-preserving permutation  $\sigma$  for the graph  $\mathcal{G}$  in Figure 2. The permutation  $\sigma$  is the identity permutation except that it maps the vertex colored lavender to the vertex colored plum. Note that the resulting graph  $\mathcal{G}^\sigma$  is a valid 3-colored welded tree graph.

classical oracle function  $\eta_c^\sigma$  for each  $c \in \mathcal{C}$  associated with  $\mathcal{G}^\sigma$  for any color-preserving permutation  $\sigma$ .

**Definition 62.** Let  $\mathcal{V}_{\mathcal{G}}$ ,  $I_c$ , and  $N_c$  for each  $c \in \mathcal{C}$ , NOEDGE, and INVALID be defined as in Definitions 1 and 2. For any color-preserving permutation  $\sigma$ , let

$$\eta_c^\sigma(v) := \begin{cases} \sigma(\eta_c(\sigma^{-1}(v))) & v, \eta_c(v) \in \mathcal{V}_{\text{WELD}} \\ \eta_c(v) & \text{otherwise} \end{cases} \quad (140)$$

where  $\mathcal{V}_{\text{WELD}}$  refers to the set of vertices of WELD.

Let  $\eta^\sigma := \{\eta_c^\sigma : c \in \mathcal{C}\}$  be the oracle corresponding to the color-preserving permutation  $\sigma$ .

We now define the notion of path-embedding in  $\mathcal{G}^\sigma$  for a sequence of colors  $t$ , which informally refers to the path resulting from beginning at the ENTRANCE and following the edge colors given by  $t$  in order.

**Definition 63 (Path-embedding).** Let  $\sigma$  be any color-preserving permutation. Let  $\ell \in [p(n)]$  and  $t \in \mathcal{C}^\ell$ . That is,  $t = (c_1, \dots, c_\ell)$  for some  $c_1, \dots, c_\ell \in \mathcal{C}$ . Then, define the path-embedding of  $t$  under the oracle  $\eta^\sigma$ , denoted by  $\eta^\sigma(t)$ , to be a length- $\ell$  tuple of vertex labels as follows. The  $j$ th element of  $\eta^\sigma(t)$  is

$$\eta^\sigma(t)_j := \begin{cases} \eta_{c_1}^\sigma(\text{ENTRANCE}) & j = 1 \\ \eta_{c_j}^\sigma(\eta^\sigma(t)_{j-1}) & \text{otherwise.} \end{cases} \quad (141)$$

We say that the path-embedding  $\eta^\sigma(t)$  encounters a vertex  $v$  if  $\eta^\sigma(t)_j = v$  for some  $j \in [\ell]$ , and that  $\eta^\sigma(t)$  encounters an edge joining vertices  $v$  and  $u$  if  $\eta^\sigma(t)_j = v$  and  $\eta^\sigma(t)_{j+1} = u$  (or the other way

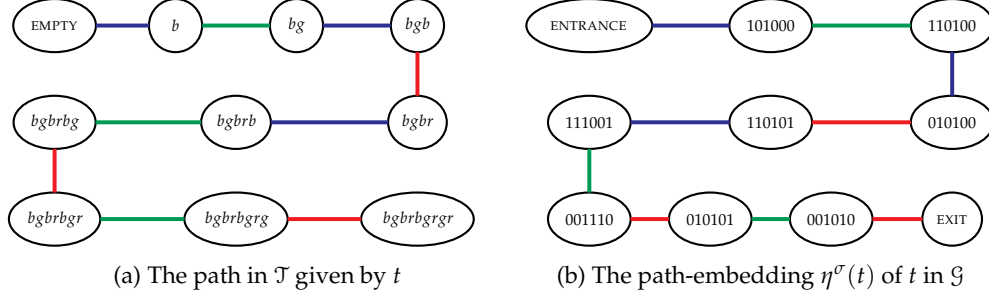

Figure 8: Example of a path-embedding for the graph  $\mathcal{G}$  in Figure 2 and the identity permutation  $\sigma$ .

around) for some  $j \in [\ell - 1]$ . Moreover,  $\eta^\sigma(t)$  encounters a cycle in  $\mathcal{G}^\sigma$  if it encounters a sequence of vertices and edges that forms a cycle in  $\mathcal{G}^\sigma$  and encounters a tree from  $\mathbb{T}$  if it encounters a leaf of this tree.

Figure 8 demonstrates an example of a path in  $\mathcal{T}$  and the corresponding path-embedding in  $\mathcal{G}$ . We restrict our attention to the color sequences that do not contain even-length palindromes. For such a sequence  $t$ , the path-embedding  $\eta^\sigma(t)$  encounters a cycle exactly when it encounters a vertex twice.

Now we describe notation for each time a certain path-embedding crosses the WELD so that we can refer to the tree from  $\mathbb{T}$  that it goes to and the WELD edge that it goes through.

**Definition 64.** Let  $\sigma$  be any color-preserving permutation and let  $t$  be any sequence of colors that does not contain even-length palindromes. We use  $T_{t,i}^\sigma \in \mathbb{T}$  to denote the  $i$ th subtree and  $e_{t,i}^\sigma$  to denote the  $i$ th edge of the WELD encountered by the path-embedding  $\eta^\sigma(t)$ .<sup>6</sup> We refer to the event of the path-embedding  $\eta^\sigma(t)$  encountering the  $i$ th edge of WELD as the  $i$ th WELD-crossing. Furthermore, let  $\ell^\sigma(t)$  denote the number of subtrees encountered by the path-embedding  $\eta^\sigma(t)$ .

Note that the number of WELD edges encountered by the path-embedding  $\eta^\sigma(t)$  is  $\ell^\sigma(t) - 1$ . For each  $i \in [\ell^\sigma(t) - 1]$ , the edge  $e_{t,i}^\sigma$  joins a vertex in  $T_{t,i}^\sigma$  to a vertex in  $T_{t,i+1}^\sigma$ . Next, we define  $\ell^\sigma(t)$  prefixes of  $t$  that are relevant for our analysis. Intuitively, for  $i \in [\ell^\sigma(t) - 1]$ , the sequence of colors  $\text{pre}_i^\sigma(t)$  refers to the prefix of  $t$  such that if we begin from the ENTRANCE and follow the edge colors given by  $\text{pre}_i^\sigma(t)$ , we will arrive at the vertex reached by the  $i$ th edge of WELD encountered by  $\eta^\sigma(t)$ .

**Definition 65.** Let  $\sigma$  be any color-preserving permutation and let  $t$  be any sequence of colors that does not contain even-length palindromes. Let  $\text{pre}_{\ell^\sigma(t)}^\sigma(t) := t$ . For each  $i \in [\ell^\sigma(t) - 1]$ , let  $\text{pre}_i^\sigma(t)$  denote the longest prefix of  $t$  such that the path-embedding  $\eta^\sigma(\text{pre}_i^\sigma(t))$  does not encounter the  $i$ th WELD-crossing.

Notice that  $\text{pre}_i^\sigma(t)$  is a sequence that begins with the color of an edge incident to ENTRANCE and ends with the color of the edge encountered by the path-embedding  $\eta^\sigma(t)$  just before the  $i$ th WELD-crossing. The following definition formalizes statements (i) and (ii) that we described intuitively at the beginning of this section.

**Definition 66.** Let  $\sigma$  be any color-preserving permutation and let  $t$  be any sequence of colors that does not contain an even-length palindrome. We say that  $t$  has small displacement if after the first WELD-crossing, the path-embedding  $\eta^\sigma(t)$  does not encounter any vertex that is distance at least  $n/3$  away from the closest vertex of WELD. We say that  $t$  is non-colliding if for any edge  $e$  joining some leaf of  $T_{t,i}^\sigma$  with some leaf of

<sup>6</sup>It is possible for  $\eta^\sigma(t)$  to encounter NOEDGE or INVALID. However, once that happens,  $\eta^\sigma(t)$  cannot further encounter any subtree from  $\mathbb{T}$ .

$T_{t,j}^\sigma$  for some  $i, j \in [\ell^\sigma(t)]$ ,  $e$  must be  $e_{t,i}^\sigma$  or  $e_{t,j}^\sigma$ . We say that  $t$  is desirable if  $t$  has small displacement and is non-colliding. We also say that  $t$  has large displacement if it does not have small displacement, that  $t$  is colliding if it is not non-colliding, and that  $t$  is undesirable if it is not desirable.

Note that, in the above definition, if  $e = e_{t,i}^\sigma$ , then  $j = i + 1$  and if  $e = e_{t,j}^\sigma$ , then  $j = i - 1$ . Thus,  $t$  being non-colliding essentially means that if there is an edge  $e$  between trees  $T_{t,i}^\sigma$  and  $T_{t,j}^\sigma$  for some  $i, j \in [\ell^\sigma(t)]$ , then  $j = i + 1$  or  $j = i - 1$ , and  $T_{t,i}^\sigma$  and  $T_{t,j}^\sigma$  are not joined by any edge other than  $e$ .

It is easy to see that for any sequence of colors  $t$  that does not contain an even-length palindrome, beginning from the ENTRANCE and following the sequence of colors specified by  $t$  will not result in reaching the EXIT if  $t$  has small displacement, and will not result in going through a cycle if  $t$  is non-colliding. The following lemma is crucial for our argument in this section, which essentially shows that any prefix of any fixed sequence of colors  $t$  is unlikely to have large displacement or be colliding (as defined in Definition 66).

**Lemma 67.** *Let  $\ell \in [p(n)]$  and  $t \in \mathcal{C}^\ell$  such that  $t$  does not contain even-length palindromes. Choose the permutation  $\sigma$  according to the distribution  $D_n$ . Then for all  $i \in [\ell^\sigma(t)]$ ,  $\text{pre}_i^\sigma(t)$  is desirable with probability at least  $1 - 4i^2 2^{-n/3}$  over the choice of  $\sigma$ .*

*Proof.* The proof is by induction on  $i$ . For the base case, note that  $\text{pre}_1^\sigma(t)$  does not encounter any edges in any tree in  $\mathbb{T}$  other than the one it first reaches. Therefore,  $\text{pre}_1^\sigma(t)$  is desirable with certainty.

Let  $i \in [\ell^\sigma(t) - 1]$ . Choose  $\sigma$  according to the distribution  $D_n$ . As the induction hypothesis, assume that  $\text{pre}_i^\sigma(t)$  is desirable with probability at least  $1 - 4i^2 2^{-n/3}$ . Our strategy is to bound the probability of  $\text{pre}_{i+1}^\sigma(t)$  having large displacement conditioned on  $\text{pre}_i^\sigma(t)$  being desirable, and then bound the probability of  $\text{pre}_{i+1}^\sigma(t)$  being colliding conditioned on  $\text{pre}_i^\sigma(t)$  being desirable and  $\text{pre}_{i+1}^\sigma(t)$  having small displacement. We begin by supposing that  $\text{pre}_i^\sigma(t)$  is desirable.

Since  $t$  (and hence  $\text{pre}_{i+1}^\sigma(t)$ ) does not contain an even-length palindrome, we know that  $e_{t,i-1}^\sigma \neq e_{t,i}^\sigma$ . By the definition of being non-colliding in Definition 66, we note that  $T_{t,i+1}^\sigma \neq T_{t,j}^\sigma$  for any  $j \in [i]$ ; otherwise, we would have  $j = i - 1$ , which would mean that the trees  $T_{t,i-1}^\sigma$  and  $T_{t,i}^\sigma$  are joined by distinct edges  $e_{t,i-1}^\sigma$  and  $e_{t,i}^\sigma$ , so  $\text{pre}_i^\sigma(t)$  would be colliding. Consider the set  $\Delta_i(t) := \{\text{color-preserving permutation } \rho : \eta^\rho(\text{pre}_i^\sigma(t)) = \eta^\sigma(\text{pre}_i^\sigma(t)) \text{ and } T_{t,i+1}^\rho \neq T_{t,j}^\rho \forall j \in [i]\}$ . We know, from above, that  $\sigma \in \Delta_i(t)$ . Moreover, for any  $\rho \in \Delta_i(t)$ ,  $\text{pre}_i^\rho(t)$  is undesirable. Since  $\sigma$  is drawn from  $D_n$ , it follows that, conditioned on  $\text{pre}_i^\sigma(t)$  being desirable,  $\sigma$  is drawn uniformly from  $\Delta_i(t)$ .

For any permutation  $\rho$  and  $j \in [\ell^\rho(t)]$ , let  $v_j^\rho$  be the vertex reached by the  $j$ th WELD-crossing with respect to the path-embedding  $\eta^\rho(t)$ . Without loss of generality, assume that  $v_i^\sigma$  is a red-right vertex.<sup>7</sup> Let  $u \neq v_i^\sigma$  be any red-right leaf of a tree  $T$  in  $\mathbb{T}$  such that  $T \neq T_{t,j}^\sigma$  for all  $j \in [i]$ . Let  $\rho$  be the color-preserving permutation that is the composition with  $\sigma$  of the permutation that maps  $u$  to  $v_i^\sigma$  (and vice versa) and is identity otherwise. Notice that  $v_i^\rho = u$  and  $T_{t,i+1}^\rho = T$ . Since the path-embeddings  $\eta^\sigma(t)$  and  $\eta^\rho(t)$  do not encounter vertices  $v_i^\sigma$  and  $u$  before the  $i$ th WELD-crossing, we have  $\eta^\rho(\text{pre}_i^\rho(t)) = \eta^\sigma(\text{pre}_i^\sigma(t))$ . Furthermore, as  $v_i^\sigma$  and  $u$  are not leaves of any tree in  $\{T_{t,j}^\sigma : j \in [i]\}$ , we have  $T_{t,j}^\rho = T_{t,j}^\sigma$  for all  $j \in [i]$ . Therefore,  $T \neq T_{t,j}^\rho$  for all  $j \in [i]$ . Hence,  $\rho \in \Delta_i(t)$ . It follows that for all red-right vertices  $u$  that are not leaves of any tree in  $\{T_{t,j}^\sigma : j \in [i]\}$ , the number of permutations  $\rho \in \Delta_i(t)$  such that  $v_i^\rho = u$  are the same. Thus, the probability, over the choice of  $\sigma$ , that  $v_i^\sigma = u$  is the same for all red-right vertices  $u$  that are not leaves of any tree in  $\{T_{t,j}^\sigma : j \in [i]\}$ .

Let  $\text{suc}_i^\sigma(t)$  be the sequence of  $n/3$  colors beginning from  $v_i^\sigma$  and reaching a vertex in column  $2n/3$  of  $T_L$  (if  $v_i^\sigma$  is a leaf in  $T_L$ ) or  $T_R$  (if  $v_i^\sigma$  is a leaf in  $T_R$ ). Note that  $\text{suc}_i^\sigma(t)$  depends on the choice

<sup>7</sup>The same argument applies for any  $c$ -right or  $c$ -left vertex for any  $c \in \mathcal{C}$ .

of  $\sigma$  as two distinct red-right vertices (for instance) can have distinct color sequences that lead to their respective ancestors in column  $2n/3$  of  $T_R$ .

Let  $\text{sub}_i^\sigma(t)$  denote the largest suffix of  $\text{pre}_{i+1}^\sigma(t)$  such that the path-embedding  $\eta^\sigma(\text{sub}_i(t))$  does not encounter the edge  $e_{t,i}^\sigma$  (if it exists). This means that  $\text{sub}_i^\sigma(t)$  is a sequence that begins with the color of the edge encountered by the path-embedding  $\eta^\sigma(t)$  just after the  $i$ th WELD-crossing and ends with the last color of  $t$  if  $i = \ell^\sigma(t) - 1$  and with the color of the edge encountered by the path-embedding  $\eta^\sigma(t)$  just before the  $(i + 1)$ st WELD-crossing otherwise. Let  $\ell_i(t)$  denote the length of  $\text{sub}_i^\sigma(t)$ . Note that, since  $\sigma \in \Delta_i(t)$ ,  $\text{sub}_i^\sigma(t)$  does not encounter any WELD edge after the  $i$ th WELD-crossing and the non-WELD edges remain invariant under  $\sigma$ , so we write it as  $\text{sub}_i(t)$ .

Let  $\text{sub}_i(t, n/3)$  denote the length- $n/3$  prefix of  $\text{sub}_i(t)$ . The sequence  $\text{sub}_i(t, n/3)$  does not exist if  $|\text{pre}_{i+1}^\sigma(t)| < |\text{pre}_i^\sigma(t)| + n/3$ . But in that case, we know that  $\text{sub}_i(t)$ , and hence  $\text{pre}_{i+1}^\sigma(t)$ , only encounter vertices that are distance less than  $n/3$  away from  $v_i$ , so  $\text{pre}_{i+1}^\sigma(t)$  has small displacement with certainty.

Now, consider the case when  $\text{sub}_i(t, n/3)$  exists. Note that, since  $\text{pre}_i^\sigma(t)$  has small displacement by the induction hypothesis,  $\text{pre}_{i+1}^\sigma(t)$  has small displacement if and only if the sequence  $\text{sub}_i(t)$  beginning from  $v_i^\sigma$  does not encounter any vertex that is distance at least  $n/3$  away from  $v_i^\sigma$ . In other words, the probability that  $\text{pre}_{i+1}^\sigma(t)$  has large displacement is equal to the probability, over the choice of  $\sigma$ , of  $\text{suc}_i^\sigma(t) = \text{sub}_i(t, n/3)$ , which we compute as follows.

We argued above that, over the choice of  $\sigma$ ,  $v_i^\sigma$  is chosen uniformly at random from the red-right leaves of the trees not in  $\{T_{t,j}^\sigma : j \in [i]\}$ . This means that the required probability is upper-bounded by the ratio of the number of red-right vertices  $v_i^\sigma$  that satisfy  $\text{suc}_i^\sigma(t) = \text{sub}_i(t, n/3)$  and the number of those that are not leaves of any tree in  $\{T_{t,j}^\sigma : j \in [i]\}$ . By [Corollary 56](#), the number of red-right leaves satisfying  $\text{suc}_i^\sigma(t) = \text{sub}_i(t, n/3)$  is at most  $\lceil 2^{2n/3+1}/3 \rceil$ . On the other hand, by [Lemma 55](#), the total number of red-right vertices that are not leaves of any tree in  $\{T_{t,j}^\sigma : j \in [i]\}$  is at least  $\lfloor 2^n/3 \rfloor - i \cdot 2^{n/3}$  as any tree in this set has  $2^{n/3}$  leaves. Therefore, assuming that  $\text{pre}_i^\sigma(t)$  is desirable, the probability of  $\text{pre}_{i+1}^\sigma(t)$  having large displacement is

$$\mathbb{P}_\sigma[E_{i+1}(\text{large displacement}) \mid E_{i+1}(\text{desirable})] = \mathbb{P}_\sigma[\text{suc}_i^\sigma(t) = \text{sub}_i(t, n/3)] \quad (142)$$

$$\leq \frac{\lceil 2^{2n/3+1}/3 \rceil}{\lfloor 2^n/3 \rfloor - i \cdot 2^{n/3}} \leq \frac{4}{2^{n/3}} \quad (143)$$

where the last inequality follows since there can be at most  $p(n)$  WELD-crossings, so  $i < \ell^\sigma(t) \leq \ell \leq p(n)$ .

Now, we bound the probability of  $\text{pre}_{i+1}^\sigma(t)$  being non-colliding conditioned on  $\text{pre}_i^\sigma(t)$  being desirable and  $\text{pre}_{i+1}^\sigma(t)$  having small displacement. Note that  $\text{pre}_{i+1}^\sigma(t)$  having small displacement implies that the path-embedding  $\eta^\sigma(\text{pre}_{i+1}^\sigma(t))$  will remain in the tree  $T_{t,i+1}^\sigma$  until the  $(i + 1)$ st WELD-crossing. Thus, by [Definition 66](#), the above probability is equal to the probability of the tree  $T_{t,i+1}^\sigma$  not having an edge with any of the trees in  $\{T_{t,j}^\sigma : j \in [i]\}$  other than the edge  $e_{t,i}^\sigma$ . Our strategy is to bound the probability of any particular leaf of a tree in  $\{T_{t,j}^\sigma : j \in [i]\}$  being a neighbor of some leaf of  $T_{t,i+1}^\sigma$  not via the edge  $e_{t,i}^\sigma$  and then apply the union bound.

Pick any leaf  $v$  of any of the trees in  $\{T_{t,j}^\sigma : j \in [i]\}$ . Let  $w$  be any neighbor of  $u$  that is a vertex of WELD $^\sigma$ . Without loss of generality, assume that  $v$  is green-left and  $w$  is red-right. First, consider the case when the edge joining  $v$  with  $w$  appears in the path-embedding  $\eta^\sigma(\text{pre}_{i+1}^\sigma(t))$ . We established above that  $T_{t,i+1}^\sigma \neq T_{t,j}^\sigma$  for any  $j \in [i]$ . Thus, if this edge is not  $e_{t,i}^\sigma$ , then  $w$  cannot be a leaf of  $T_{t,i+1}^\sigma$ . Therefore, this case does not contribute positively to the required probability.

Now, suppose that this edge does not appear in  $\eta^\sigma(\text{pre}_{i+1}^\sigma(t))$ . By essentially the same argument that established that the probability that  $v_i^\sigma = u$  is the same for all red-right vertices  $u$  that

are not leaves of any tree in  $\{T_{t,j}^\sigma : j \in [i]\}$ , the probability that  $w = u$  is the same for all red-right vertices  $u$  that are not leaves of any tree in  $\{T_{t,j}^\sigma : j \in [i]\}$ . This means that the probability of  $w$  being a leaf of  $T_{t,i+1}^\sigma$  is bounded by the ratio of the number of red-right vertices in  $T_{t,i+1}^\sigma$  and the number of vertices that are not leaves of any tree in  $\{T_{t,j}^\sigma : j \in [i]\}$ . By [Lemma 55](#), the former quantity is at most  $\lceil 2^{n/3}/3 \rceil$ . The latter quantity is at least  $\lfloor 2^n/3 \rfloor - i \cdot 2^{n/3}$  as all trees in  $\{T_{t,j}^\sigma : j \in [i]\}$  have  $2^{n/3}$  leaves. Note that the total number of vertices that are leaves of any tree in  $\{T_{t,j}^\sigma : j \in [i]\}$  is  $i \cdot 2^{n/3}$ , and each such vertex has 2 neighbors in  $\text{WELD}^\sigma$ . Hence, by the union bound, the required probability is

$$\mathbb{P}_\sigma[E_{i+1}(\text{colliding}) \mid E_i(\text{desirable}), E_{i+1}(\text{small displacement})] \leq \frac{2i \cdot 2^{n/3} \cdot \lceil 2^{n/3}/3 \rceil}{\lfloor 2^n/3 \rfloor - i \cdot 2^{n/3}} \leq \frac{4i}{2^{n/3}}. \quad (144)$$

Now notice that  $\text{pre}_{i+1}^\sigma(t)$  can only be desirable if  $\text{pre}_i^\sigma(t)$  is desirable,  $\text{pre}_{i+1}^\sigma(t)$  has large displacement, or  $\text{pre}_{i+1}^\sigma(t)$  is colliding. Hence, the probability of  $\text{pre}_j^\sigma(t)$  being desirable satisfies

$$\mathbb{P}_\sigma[E_{i+1}(\text{undesirable})] \leq \mathbb{P}_\sigma[E_i(\text{undesirable})] + \mathbb{P}_\sigma[E_{i+1}(\text{large displacement}) \mid E_i(\text{desirable})] + \mathbb{P}_\sigma[E_{i+1}(\text{colliding}) \mid E_i(\text{desirable}), E_{i+1}(\text{small displacement})] \quad (145)$$

$$\leq \frac{4i^2}{2^{n/3}} + \frac{4}{2^{n/3}} + \frac{4i}{2^{n/3}} \leq \frac{4(i+1)^2}{2^{n/3}} \quad (146)$$

where we used [eqs. \(142\)](#) and [\(144\)](#) for the second inequality. The lemma follows.  $\square$

The next corollary is sufficient to establish the classical hardness result of [Theorem 72](#), even though it is a weaker statement about a special case of [Lemma 67](#). Concretely, we show that for a fixed sequence of colors and a uniformly random color-preserving permutation  $\sigma$ , it is improbable for the corresponding path-embedding to contain the EXIT or a path that forms a cycle in  $\mathcal{G}^\sigma$ .

**Corollary 68.** *Let  $\ell \in [p(n)]$  and  $t \in \mathcal{C}^\ell$  such that  $t$  does not contain an even-length palindrome. Choose the permutation  $\sigma$  according to the distribution  $D_n$ . Then the probability that the path-embedding  $\eta^\sigma(t)$  encounters the EXIT or a cycle in  $\mathcal{G}^\sigma$  is at most  $4p(n)^2 \cdot 2^{-n/3}$ .*

*Proof.* By [Definition 66](#), if  $\eta^\sigma(t)$  encounters the EXIT, then  $t$  has large displacement, and if  $\eta^\sigma(t)$  encounters a cycle in  $\mathcal{G}^\sigma$ , then  $t$  is colliding. That is,  $t$  is undesirable if it encounters the EXIT or a cycle in  $\mathcal{G}^\sigma$ . Since  $\ell_t^\sigma \leq \ell \leq p(n)$ ,  $t$  is undesirable with probability at most  $4(\ell_t^\sigma)^2 2^{-n/3} \leq 4p(n)^2 2^{-n/3}$  over the choice of  $\sigma$  by [Lemma 67](#).  $\square$

We can extend the result of [Corollary 68](#) about polynomial-length sequences of colors to polynomial-size subtrees of the address tree  $\mathcal{T}$  (see [Definition 11](#)). For this purpose, we define the notion of subtree-embedding of subtrees of  $\mathcal{T}$ . Intuitively, the subtree-embedding of a tree  $T$  describes the subgraph of  $\mathcal{G}^\sigma$  obtained by querying the oracle  $\eta^\sigma$  according to the sequences of colors given by the vertex labels of  $T$ .

**Definition 69** (Subtree-embedding). *Let  $\sigma$  be any color-preserving permutation. Let  $\ell \in [p(n)]$  and  $t \in \mathcal{C}^\ell$ . Let  $T$  be a subtree of the address tree  $\mathcal{T}$  of size  $p(n)$  that contains the vertex labeled `EMPTYADDRESS` but does not contain vertices having labels in `SpecialAddresses`  $\setminus$  `{EMPTYADDRESS}`. For any vertex of  $T$  labeled by  $t \neq \text{EMPTYADDRESS}$ , let  $c_{|t|}$  denote the last color appearing in the sequence  $t$  and let  $\text{pre}(t)$  denote the color sequence formed by removing the last color from  $t$ . Define the subtree-embedding of  $T$*

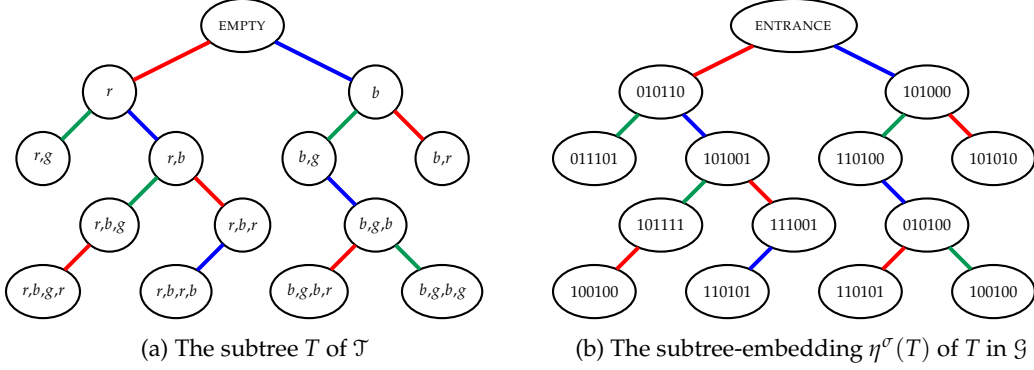

Figure 9: Example of a subtree-embedding for the graph  $\mathcal{G}$  in Figure 2 and the identity permutation  $\sigma$ .

under the oracle  $\eta^\sigma$ , denoted  $\eta^\sigma(T)$ , to be a tree isomorphic to  $T$  whose vertex labels are in  $\mathcal{V}_{\mathcal{G}}$  and specified as follows. The vertex of  $\eta^\sigma(T)$  corresponding to the vertex of  $T$  labeled by  $t$  is

$$\eta^\sigma(T)_t := \begin{cases} \text{ENTRANCE} & t = \text{EMPTYADDRESS} \\ \eta_{c|t|}^\sigma(\eta^\sigma(T)_{\text{pre}(t)}) & \text{otherwise.} \end{cases} \quad (147)$$

We say that the subtree-embedding  $\eta^\sigma(T)$  encounters the EXIT if it contains a vertex labeled EXIT and that  $\eta^\sigma(T)$  encounters a cycle if it contains two vertices having the same label.

Figure 9 illustrates an example of a subtree of  $\mathcal{T}$  and the corresponding subtree-embedding in  $\mathcal{G}$ . For any tree  $T$  specified in Definition 69, the root of  $T$  will always be EMPTYADDRESS, so the root of  $\eta^\sigma(T)$  will always be ENTRANCE. The subtree-embedding  $\eta^\sigma(T)$  of a tree  $T$  will correspond to the subgraph of  $\mathcal{G}^\sigma$  that contain vertices which can be reached by following the addresses given by vertex labels of  $T$  in  $\mathcal{G}^\sigma$  beginning at the ENTRANCE.

Next, we show that for a fixed sub-tree of  $\mathcal{T}$  and a randomly chosen color-preserving permutation  $\sigma$ , it is not possible for the corresponding subtree-embedding to contain the EXIT or a path that forms a cycle in  $\mathcal{G}^\sigma$ , except with exponentially small probability.

**Lemma 70.** *Let  $T$  be a subtree of the address tree  $\mathcal{T}$  of size  $p(n)$  that contains the vertex labeled EMPTYADDRESS but does not contain vertices having labels in  $\text{SpecialAddresses} \setminus \{\text{EMPTYADDRESS}\}$ . Let the permutation  $\sigma$  be chosen according to the distribution  $D_n$ . Then the probability that the subtree-embedding  $\eta^\sigma(T)$  encounters the EXIT or a cycle is at most  $4p(n)^4 2^{-n/3}$ .*

*Proof.* Suppose that the subtree-embedding  $\eta^\sigma(T)$  contains a vertex  $v$  labeled EXIT. Let  $t$  denote the label of the vertex of  $T$  corresponding to  $v$ . Then the path-embedding  $\eta^\sigma(t)$  encounters the EXIT. Therefore, since  $T$  has at most  $p(n)$  vertices, the probability of  $\eta^\sigma(T)$  encountering the EXIT is at most  $p(n) \cdot 4p(n)^2 2^{-n/3} = 4p(n)^3 2^{-n/3}$  by Corollary 68.

Now, suppose that the subtree-embedding  $\eta^\sigma(T)$  encounters a cycle. That is, it contains two vertices  $v_1$  and  $v_2$  having the same label. Without loss of generality, assume that the respective parents  $u_1$  and  $u_2$  of  $v_1$  and  $v_2$  in  $T$  (if they exist) do not have the same labels; otherwise, re-label  $v_1$  as  $u_1$  and  $v_2$  as  $u_2$ . Let  $t_1$  and  $t_2$  be the labels of the vertices of  $T$  corresponding to  $v_1$  and  $v_2$ , respectively. Let  $t_{1,2}$  denote the sequence resulting from the concatenation of  $t_1$  with the reverse of  $t_2$ . By our above assumption, no color can appear consecutively in  $t_{1,2}$ , so  $t_{1,2}$  does not contain an even-length palindrome. Thus, starting from the ENTRANCE and following the sequence of colors given by  $t_{1,2}$  in  $\mathcal{G}^\sigma$  will result in returning to the ENTRANCE without backtracking. This means that the path-embedding  $\eta^\sigma(t_{1,2})$  encounters a cycle in  $\mathcal{G}^\sigma$ . Therefore, since there are at most  $\binom{p(n)}{2}$

pairs of vertices of  $T$ , the probability of  $\eta^\sigma(T)$  encountering a cycle is at most  $\binom{p(n)}{2} \cdot 4p(n)^2 2^{-n/3} \leq 2p(n)^4 2^{-n/3}$  by [Corollary 68](#).

We obtain the desired result by union bounding over the probabilities specified above.  $\square$

We now establish that for a uniformly random permutation  $\sigma$  and any classical algorithm that samples from the subtrees of  $\mathcal{T}$ , we cannot hope to find the EXIT or a cycle in  $\mathcal{G}$  with more than exponentially small probability.

**Lemma 71.** *Choose the permutation  $\sigma$  according to the distribution  $D_n$ . Let  $\mathcal{S}$  be the set of subtrees of the address tree  $\mathcal{T}$  of size  $p(n)$  that contain the vertex labeled `EMPTYADDRESS` but do not contain vertices having labels in `SpecialAddresses`  $\setminus$  `{EMPTYADDRESS}`.<sup>8</sup> Let  $\mathcal{A}_{\text{classical}}$  be a classical query algorithm that samples a tree  $T$  from  $\mathcal{S}$  and computes the subtree-embedding  $\eta^\sigma(T)$ . Then, the probability that  $\mathcal{A}_{\text{classical}}$  finds the EXIT or a cycle in  $\mathcal{G}$  is at most  $4p(n)^4 2^{-n/3}$ .*

*Proof.* The algorithm  $\mathcal{A}_{\text{classical}}$  finds the EXIT if the subtree-embedding  $\eta^\sigma(T)$  contains it. On the other hand, since  $\eta^\sigma(T)$  corresponds to a connected subgraph of  $\mathcal{G}^\sigma$ ,  $\mathcal{A}_{\text{classical}}$  finds a cycle in  $\mathcal{G}^\sigma$  if there are two vertices in the tree  $\eta^\sigma(T)$  that have the same label. Therefore, this lemma is a direct consequence of [Lemma 70](#) and convexity.  $\square$

We conclude this section with our main result about the existence of a distribution for which it is hard for a natural class of classical algorithms to find the EXIT or a cycle in the welded tree graph sampled according to this distribution.

**Theorem 72.** *Let  $\mathcal{S}$  be the set of subtrees of the address tree  $\mathcal{T}$  of size  $p(n)$  that contain the vertex labeled `EMPTYADDRESS` but do not contain vertices having labels in `SpecialAddresses`  $\setminus$  `{EMPTYADDRESS}`. Then there exists a distribution  $\mathcal{D}_n$  over size- $n$  3-colored welded tree graphs  $\mathcal{G}'$  such that for any classical query algorithm  $\mathcal{A}_{\text{classical}}$  that samples a tree  $T$  from  $\mathcal{S}$  and computes the associated subtree-embedding in  $\mathcal{G}'$ , the probability that  $\mathcal{A}_{\text{classical}}$  finds the EXIT or a cycle in  $\mathcal{G}'$  is at most  $4p(n)^4 2^{-n/3}$ .*

*Proof.* Consider the distribution  $\mathcal{D}_n$  specified by the following sampling process: choose  $\sigma$  according to the distribution  $D_n$  and output  $\mathcal{G}^\sigma$ . From [Lemma 71](#), we know that  $\mathcal{D}_n$  satisfies the requirement of this theorem.  $\square$

## Acknowledgments

We thank Matt Kovacs-Deak for many helpful discussions. AMC received support from the Army Research Office (grant W911NF-20-1-0015); the National Science Foundation (grant CCF-1813814); and the Department of Energy, Office of Science, Office of Advanced Scientific Computing Research, Accelerated Research in Quantum Computing program. MC received support from the National Institute of Standards and Technology (NIST). ASG received support from the United States Educational Foundation in Pakistan and the Institute of International Education via a Fulbright scholarship.

## References

- [Aar21] Scott Aaronson. Open problems related to quantum query complexity. *ACM Transactions on Quantum Computing*, 2(4), 2021. [arXiv:2109.06917](https://arxiv.org/abs/2109.06917), [doi:10.1145/3488559](https://doi.org/10.1145/3488559).

<sup>8</sup>Recall that  $\mathcal{T}$  can be computed using 2 queries to the classical oracle  $\eta^\sigma$ .



- [CCD<sup>+</sup>03] Andrew M. Childs, Richard Cleve, Enrico Deotto, Edward Farhi, Sam Gutmann, and Daniel A. Spielman. Exponential algorithmic speedup by a quantum walk. In *Proceedings of the 35th Annual ACM Symposium on Theory of Computing*, pages 59–68, 2003. [arXiv:quant-ph/0209131](https://arxiv.org/abs/quant-ph/0209131), [doi:10.1145/780542.780552](https://doi.org/10.1145/780542.780552).
- [CCL20] Nai-Hui Chia, Kai-Min Chung, and Ching-Yi Lai. On the need for large quantum depth. In *Proceedings of the 52nd Annual ACM Symposium on Theory of Computing*, page 902–915, 2020. [arXiv:arXiv:1909.10303](https://arxiv.org/abs/1909.10303), [doi:10.1145/3357713.3384291](https://doi.org/10.1145/3357713.3384291).
- [CM20] Matthew Coudron and Sanketh Menda. Computations with greater quantum depth are strictly more powerful (relative to an oracle). In *Proceedings of the 52nd Annual ACM Symposium on Theory of Computing*, page 889–901, 2020. [arXiv:1909.10503](https://arxiv.org/abs/1909.10503), [doi:10.1145/3357713.3384269](https://doi.org/10.1145/3357713.3384269).
- [CW00] Richard Cleve and John Watrous. Fast parallel circuits for the quantum Fourier transform. In *Proceedings of the 41st IEEE Symposium on Foundations of Computer Science*, pages 526–536, 2000. [arXiv:quant-ph/0006004](https://arxiv.org/abs/quant-ph/0006004), [doi:10.1109/SFCS.2000.892140](https://doi.org/10.1109/SFCS.2000.892140).
- [EHKS14] Kirsten Eisenträger, Sean Hallgren, Alexei Kitaev, and Fang Song. A quantum algorithm for computing the unit group of an arbitrary degree number field. In *Proceedings of the 46th Annual ACM Symposium on Theory of Computing*, pages 293–302, 2014. [doi:10.1145/2591796.2591860](https://doi.org/10.1145/2591796.2591860).
- [Hal07] Sean Hallgren. Polynomial-time quantum algorithms for Pell’s equation and the principal ideal problem. *Journal of the ACM*, 54(1):4, 2007. Preliminary version in STOC 2002. [doi:10.1145/1206035.1206039](https://doi.org/10.1145/1206035.1206039).
- [Ked06] Kiran S. Kedlaya. Quantum computation of zeta functions of curves. *Computational Complexity*, 15(1):1–19, 2006. [arXiv:math.NT/0411623](https://arxiv.org/abs/math.NT/0411623), [doi:10.1007/s00037-006-0204-7](https://doi.org/10.1007/s00037-006-0204-7).
- [Kő16] Dénes Kőnig. Gráfok és alkalmazásuk a determinánsok és a halmazok elméletére. *Matematikai és Természettudományi Értesítő*, 34:104–119, 1916.
- [Llo96] Seth Lloyd. Universal quantum simulators. *Science*, 273(5278):1073–1078, 1996. [doi:10.1126/science.273.5278.1073](https://doi.org/10.1126/science.273.5278.1073).
- [Ros11] Ansis Rosmanis. Quantum snake walk on graphs. *Physical Review A*, 83(2):022304, 2011. [arXiv:1004.4054](https://arxiv.org/abs/1004.4054), [doi:10.1103/PhysRevA.83.022304](https://doi.org/10.1103/PhysRevA.83.022304).
- [Sho97] Peter W. Shor. Polynomial-time algorithms for prime factorization and discrete logarithms on a quantum computer. *SIAM Journal on Computing*, 26(5):1484–1509, 1997. Preliminary version in FOCS 1994. [arXiv:quant-ph/9508027](https://arxiv.org/abs/quant-ph/9508027), [doi:10.1137/S0097539795293172](https://doi.org/10.1137/S0097539795293172).
- [Sim97] Daniel R. Simon. On the power of quantum computation. *SIAM J. Comput.*, 26(5):1474–1483, 1997. Preliminary version in FOCS 1994. [doi:10.1137/S0097539796298637](https://doi.org/10.1137/S0097539796298637).