

STRATEGY COMPLEXITY OF THRESHOLD PAYOFF WITH APPLICATIONS TO OPTIMAL EXPECTED PAYOFF

RICHARD MAYR,* *The University of Edinburgh*

ERIC MUNDAY,** *The University of Edinburgh*

Abstract

We study countably infinite Markov decision processes (MDPs) with transition rewards. The lim sup (resp. lim inf) threshold objective is to maximize the probability that the lim sup (resp. lim inf) of the infinite sequence of transition rewards is non-negative. We establish the complete picture of the strategy complexity of these objectives, i.e., the upper and lower bounds on the memory required by ε -optimal (resp. optimal) strategies.

We then apply these results to solve two open problems from Sudderth [30, p.1 and p.11] about the strategy complexity of optimal strategies for the *expected* lim sup (resp. lim inf) payoff.

Keywords: Markov decision processes, Strategy complexity, Memory, Limsup,

Liminf

2020 Mathematics Subject Classification: Primary 90C40

Secondary 91A60

1. Introduction

Background. Countably infinite Markov decision processes (MDPs) are a standard model for dynamic systems that exhibit both stochastic and controlled behavior (see, e.g., textbooks [25, 21, 12, 26] and references therein). Some fundamental results and proof techniques for countable MDPs were established in the framework of Gambling Theory [12, 21]. See also Ornstein's seminal paper on stationary strategies [24]. Further applications include control theory [7, 1], operations research and finance [23, 3, 5, 27], artificial intelligence and machine learning [31, 28], and formal verification [17, 2, 9,

* Postal address: 10 Crichton Street, Edinburgh EH8 9AB, UK

** Postal address: 10 Crichton Street, Edinburgh EH8 9AB, UK

14, 8, 15, 11, 4]. The latter works often use countable MDPs to describe unbounded structures in computational models such as stacks/recursion, counters, queues, etc.

An MDP can be described as a directed graph where states are either random or controlled. In a random state, the next state is chosen according to a predefined probability distribution. In a controlled state, the controller can choose a distribution over all possible successor states. By fixing a strategy for the controller and an initial state, one obtains a probability space of runs of the MDP. The controller's goal is to optimize the expected value of some objective function on the runs. The amount/type of memory and randomization that ε -optimal (resp. optimal) strategies need for a given objective is called its *strategy complexity*.

lim sup and lim inf objectives. MDPs are given a reward structure by assigning a real-valued (resp. integer or rational) reward to each transition. (Alternatively, rewards can be assigned to states. The two versions can easily be encoded into each other; cf. Section 3.) Every run then induces an infinite sequence of seen transition rewards $r_0 r_1 r_2 \dots$ (also called *point payoffs* [22]). The lim sup *threshold objective* is to maximize the probability that $\limsup_{n \geq 0} r_n \geq 0$. Similarly, the lim inf threshold objective is to maximize the probability that $\liminf_{n \geq 0} r_n \geq 0$. In the special case where the transition rewards are limited to the integers, the lim sup (resp. lim inf) threshold objective corresponds to the well-studied Büchi (resp. co-Büchi) objective in formal verification [11, 10], since it suffices to see rewards ≥ 0 infinitely often (resp. to see rewards < 0 only finitely often). However, the general case of *countably infinite* MDPs with rational/real rewards is more complex. E.g., the sequence $-1/2, -1/3, -1/4 \dots$ does satisfy $\limsup \geq 0$ and $\liminf \geq 0$.

A related problem is to maximize the *expected* lim sup (resp. lim inf) of the runs. Unlike for the threshold objective, an optimal strategy to maximize the *expected* lim sup (resp. lim inf) could accept a high probability of a negative lim sup (resp. lim inf), provided that the remaining runs have a huge positive lim sup (resp. lim inf). It was shown in [30] that optimal strategies for the expected lim sup, if they exist, can be chosen as deterministic Markov. Threshold objectives and expected lim sup/lim inf objectives are closely related; see below and Sections 3 and 6.

Finite vs. Infinite MDPs. If an MDP has only finitely many transitions, then the connection of lim sup (resp. lim inf) threshold objectives to Büchi (resp. co-Büchi) objectives holds even for real-valued rewards, since only finitely many different numbers appear in the MDP. In contrast, for countably infinite MDPs, the lim sup (resp. lim inf) are strictly more general than Büchi (resp. co-Büchi); cf. Section 3. Moreover, optimal strategies need not exist (not even for much simpler objectives like reachability), ε -optimal (resp. optimal) strategies can require infinite memory, and computational problems are not defined in general, since a countable MDP need not be finitely presented [19].

Strategy Complexity. Classes of strategies are defined via the amount and type of memory used, and whether they are randomized or deterministic. Some canonical types of memory for strategies are the following: No memory (also called memoryless or positional), finite memory, a step counter (i.e., a discrete clock), and general infinite memory. Strategies using only a step counter are also called *Markov strategies* [25]. Moreover, there can be combinations of these, e.g., a step counter plus some finite general purpose memory. Other types of memory are possible, e.g., an unbounded stack or a queue, but they are less common in the literature.

The upper bound tells us that a certain amount/type of memory is sufficient for a good strategy, while the lower bound tells us what is not sufficient. By $\text{Rand}(X)$ (resp. $\text{Det}(X)$) we denote the classes of randomized (resp. deterministic) strategies that use memory of size/type X . SC denotes a step counter, and F denotes arbitrary finite memory. 1-bit is a special case of F , where only 1 bit of memory is used. Positional means that no memory is used. E.g., a lower bound $\neg\text{Rand}(\text{SC})$ means that randomized strategies that use just a step counter are not sufficient.

Our contribution. We establish the complete picture of the strategy complexity of the lim sup and lim inf threshold objectives for *countably infinite* MDPs; cf. Table 1 and Table 2. This generalizes the results on the strategy complexity of the Büchi and co-Büchi objectives in countably infinite MDPs of [16, 17]. We show upper and lower bounds on the amount/type of memory and randomization that good strategies need, where good means ε -optimal, resp. optimal when optimal strategies exist. We

then apply our results on the threshold objectives to solve two open problems from Sudderth [30, p.1 and p.11] about the strategy complexity of optimal strategies for the expected lim sup (resp. lim inf).

In Section 4 we show that ε -optimal strategies for the lim sup threshold objective require exactly a step counter plus one bit of memory, thus extending the result on Büchi objectives in [16]. Moreover, we show that optimal strategies, if they exist, can be chosen as deterministic Markov, or alternatively as positional randomized. In particular this implies that optimal strategies for the expected lim sup, if they exist, can also be chosen as positional randomized, which solves the open question in [30, p.11]; see Section 6.

In Section 5 we show that ε -optimal (resp. optimal) strategies for the lim inf threshold objective can be chosen as deterministic Markov. In the special case of finitely branching countable MDPs, even positional deterministic strategies suffice. The former result is then applied in Section 6 to show that optimal strategies for the expected lim inf, if they exist, can also be chosen as deterministic Markov, which solves the open question in [30, p.1] (where this property was shown only for MDPs with *finitely many* controlled states).

2. Preliminaries

Markov decision processes. A *probability distribution* over a countable set S is a function $f : S \rightarrow [0, 1]$ with $\sum_{s \in S} f(s) = 1$. Let $\mathcal{D}(S)$ be the set of all probability distributions over S . A *Markov decision process* (MDP) $\mathcal{M} = (S, S_{\square}, S_{\circ}, \longrightarrow, P, r)$ consists of a countable set S of *states*, which is partitioned into a set S_{\square} of *controlled states* and a set S_{\circ} of *random states*, a *transition relation* $\longrightarrow \subseteq S \times S$, and a *probability function* $P : S_{\circ} \rightarrow \mathcal{D}(S)$. We write $s \longrightarrow s'$ if $(s, s') \in \longrightarrow$, and refer to s' as a *successor* of s . We assume that every state has at least one successor. The probability function P assigns to each random state $s \in S_{\circ}$ a probability distribution $P(s)$ over its (non-empty) set of successor states. The reward function $r : (\longrightarrow) \rightarrow \mathbb{R}$ assigns rewards to transitions. (We mainly use transition-based rewards in this paper. Alternatively, one can consider state-based rewards $r : S \rightarrow \mathbb{R}$. Transition-based rewards can easily be encoded into state-based rewards and vice-versa; see Section 3.)

A *sink* in \mathcal{M} is a subset $T \subseteq S$ closed under the \longrightarrow relation, that is, $s \in T$ and $s \longrightarrow s'$ implies that $s' \in T$. An MDP is *acyclic* if the underlying directed graph (S, \longrightarrow) is acyclic, i.e., there is no directed cycle. It is *finitely branching* if every state has finitely many successors and *infinitely branching* otherwise. An MDP without controlled states ($S_\square = \emptyset$) is called a *Markov chain*.

Strategies and Probability Measures. A *run* ρ is an infinite sequence of states and transitions $s_0 e_0 s_1 e_1 \dots$ such that $e_i = (s_i, s_{i+1}) \in \longrightarrow$ for all $i \in \mathbb{N}$. Let $Runs_{\mathcal{M}} s_0$ be the set of all runs from s_0 in the MDP \mathcal{M} . A *partial run* is a finite prefix of a run. $pRuns_{\mathcal{M}} s_0$ is the set of all partial runs from s_0 and $pRuns_{\mathcal{M}}$ the set of partial runs from any state in \mathcal{M} .

We write $\rho_s(i) \stackrel{\text{def}}{=} s_i$ for the i -th state along ρ and $\rho_e(i) \stackrel{\text{def}}{=} e_i$ for the i -th transition along ρ . We sometimes write runs as $s_0 s_1 \dots$, leaving the transitions implicit. We say that a (partial) run ρ *visits* s if $s = \rho_s(i)$ for some i , and that ρ starts in s if $s = \rho_s(0)$.

A *strategy* is a function $\sigma : pRuns_{\mathcal{M}} \cdot S_\square \rightarrow \mathcal{D}(S)$ that assigns to partial runs ρs , where $s \in S_\square$, a distribution over the successors $\{s' \in S \mid s \longrightarrow s'\}$ of s . The set of all strategies in \mathcal{M} is denoted by $\Sigma_{\mathcal{M}}$ (we omit the subscript and write Σ if \mathcal{M} is clear from the context). A (partial) run $s_0 e_0 s_1 e_1 \dots$ is consistent with a strategy σ if for all i either $s_i \in S_\square$ and $\sigma(s_0 e_0 s_1 e_1 \dots s_i)(s_{i+1}) > 0$, or $s_i \in S_\circ$ and $P(s_i)(s_{i+1}) > 0$.

An MDP $\mathcal{M} = (S, S_\square, S_\circ, \longrightarrow, P, r)$, an initial state $s_0 \in S$, and a strategy σ induce a probability space in which the outcomes are runs starting in s_0 with measure $\mathcal{P}_{\mathcal{M}, s_0, \sigma}$ defined as follows. It is first defined on *cylinders*, i.e., sets of the form $s_0 e_0 s_1 e_1 \dots s_n \cdot (Runs_{\mathcal{M}} s_n)$: if $s_0 e_0 s_1 e_1 \dots s_n$ is not a partial run consistent with σ then $\mathcal{P}_{\mathcal{M}, s_0, \sigma}(s_0 e_0 s_1 e_1 \dots s_n \cdot (Runs_{\mathcal{M}} s_n)) \stackrel{\text{def}}{=} 0$. Otherwise,

$$\mathcal{P}_{\mathcal{M}, s_0, \sigma}(s_0 e_0 s_1 e_1 \dots s_n \cdot (Runs_{\mathcal{M}} s_n)) \stackrel{\text{def}}{=} \prod_{i=0}^{n-1} \bar{\sigma}(s_0 e_0 s_1 \dots s_i)(s_{i+1})$$

where $\bar{\sigma}$ is the map that extends σ by $\bar{\sigma}(ws) = P(s)$ for all partial runs $ws \in pRuns_{\mathcal{M}} \cdot S_\circ$. By Carathéodory's theorem [6], this extends uniquely to a probability measure $\mathcal{P}_{\mathcal{M}, s_0, \sigma}$ on the Borel σ -algebra \mathcal{F} of subsets of $Runs_{\mathcal{M}} s_0$. Elements of \mathcal{F} , i.e., measurable sets of runs, are called *events* or *objectives* here. For $X \in \mathcal{F}$ we will write $\bar{X} \stackrel{\text{def}}{=} Runs_{\mathcal{M}} s_0 \setminus X \in \mathcal{F}$ for its complement and $\mathcal{E}_{\mathcal{M}, s_0, \sigma}$ for the expectation wrt. $\mathcal{P}_{\mathcal{M}, s_0, \sigma}$. We drop the indices if possible without ambiguity.

LTL Notation. We need a compact formal notation to talk about the properties of runs. Thus we use the operators of the temporal logic LTL [10]. LTL formulae are interpreted over runs where $\llbracket \varphi \rrbracket^s$ denotes the set of runs starting from s that satisfy the LTL formula φ . This is a measurable set [32]. We also write $\llbracket \varphi \rrbracket$ for $\bigcup_{s \in S} \llbracket \varphi \rrbracket^s$. Where it does not cause confusion we will identify φ and $\llbracket \varphi \rrbracket$ and just write $\mathcal{P}_{\mathcal{M},s,\sigma}(\varphi)$ instead of $\mathcal{P}_{\mathcal{M},s,\sigma}(\llbracket \varphi \rrbracket^s)$.

The reachability objective of eventually visiting a set X can be expressed by the operator F (eventually), i.e., $\llbracket FX \rrbracket \stackrel{\text{def}}{=} \{\rho \mid \exists i. \rho_s(i) \in X\}$. Reaching X within at most k steps is expressed by $\llbracket F^{\leq k} X \rrbracket \stackrel{\text{def}}{=} \{\rho \mid \exists i \leq k. \rho_s(i) \in X\}$. Similarly for eventually visiting given sets of transitions. The operator G (always) is defined as $\neg F \neg$. So the safety objective of avoiding X is expressed by $G \neg X$. The operator $G^{\leq k}$ (for all times until time k) is defined as $\neg F^{\leq k} \neg$. Staying inside a given set of states X between times m and n is expressed by $\llbracket G^{[m,n]} X \rrbracket \stackrel{\text{def}}{=} \{\rho \mid \forall i \text{ s.t. } m \leq i \leq n, \rho_s(i) \in X\}$. Similarly for visiting transitions instead of states.

It is easy to express more complex objectives with these operators [19]. E.g., the Büchi objective to see a given set X infinitely often can be expressed as $GF X$, while the co-Büchi objective to see a given set X only finitely often can be expressed as $FG \neg X$.

Transience and Shift invariance. Given an MDP $\mathcal{M} = (S, S_{\square}, S_{\circ}, \longrightarrow, P, r)$, consider the objective **Transience** $\stackrel{\text{def}}{=} \bigwedge_{s \in S} FG \neg s$. That is to say, **Transience** is the objective to see no state infinitely often. An MDP \mathcal{M} is called *universally transient* [18] if **Transience** is satisfied almost surely from every state s_0 under all strategies, i.e., $\forall s_0 \forall \sigma \in \Sigma_{\mathcal{M}} \mathcal{P}_{\mathcal{M},s_0,\sigma}(\text{Transience}) = 1$. (In particular, all acyclic MDPs are universally transient, but not only these.)

An objective φ is called *shift invariant in \mathcal{M}* iff for every run $\rho' \rho$ in \mathcal{M} with some finite prefix ρ' we have $\rho' \rho \in \llbracket \varphi \rrbracket \Leftrightarrow \rho \in \llbracket \varphi \rrbracket$. An objective is called *shift invariant* if it is shift invariant in every MDP.

Strategy Classes. Strategies are in general *randomized* in the sense that they take values in $\mathcal{D}(S)$. A strategy σ is *deterministic* if $\sigma(\rho)$ is a Dirac distribution for all ρ . General strategies can be *history dependent*, while others are restricted by the size or type of memory they use; see below. We consider certain classes of strategies:

- A strategy σ is *positional* (also called *memoryless*) if its choices depend only on the current state. We may see positional strategies as functions $\sigma : S_{\square} \rightarrow \mathcal{D}(S)$. Memoryless deterministic (resp. randomized) strategies are also abbreviated as MD (resp. MR).
- A strategy σ is *finite memory* (F) if there exists a finite memory M implementing σ . (See Appendix A for a formal definition how strategies use memory.) Hence Rand(F) (resp. Det(F)) stands for finite memory randomized (resp. deterministic) strategies. They are also abbreviated as FR (resp. FD).
- A step counter strategy bases decisions only on the current state and the number of steps taken so far, i.e., it uses an unbounded integer counter that gets incremented by 1 in every step. Such strategies are also called *Markov strategies* [25]. Rand(SC) (resp. Det(SC)) stands for step counter using randomized (resp. deterministic) strategies.
- Combinations of the above are possible, e.g., Det(SC + 1-bit) stands for deterministic strategies using a step counter plus one bit of general purpose memory. (See also [17].)

Optimal and ε -optimal Strategies. Given an objective φ , the value of state s in an MDP \mathcal{M} , denoted by $\text{val}_{\mathcal{M},\varphi}(s)$, is the supremum probability of achieving φ , i.e., $\text{val}_{\mathcal{M},\varphi}(s) \stackrel{\text{def}}{=} \sup_{\sigma \in \Sigma} \mathcal{P}_{\mathcal{M},s,\sigma}(\varphi)$ where Σ is the set of all strategies. For $\varepsilon \geq 0$ and state $s \in S$, we say that a strategy is *ε -optimal* from s iff $\mathcal{P}_{\mathcal{M},s,\sigma}(\varphi) \geq \text{val}_{\mathcal{M},\varphi}(s) - \varepsilon$. A 0-optimal strategy is called *optimal*. An optimal strategy is *almost-surely winning* if $\text{val}_{\mathcal{M},\varphi}(s) = 1$. Considering a positional strategy as a function $\sigma : S_{\square} \rightarrow \mathcal{D}(S)$ and $\varepsilon \geq 0$, σ is *uniformly ε -optimal* (resp. uniformly optimal) if it is ε -optimal (resp. optimal) from *every* state $s \in S$. (A closely related concept is a *stationary* strategy, which also bases decisions only on the current state. However, some authors call a strategy “stationary ε -optimal” if it is ε -optimal from every state (i.e., uniform in our terminology), and call it “semi-stationary” if it is ε -optimal only from some fixed initial state.) For more general objectives that are defined by a measurable reward function instead of a predicate on runs, ε -optimality is defined similarly with the expectation \mathcal{E} instead of the probability \mathcal{P} .

The step counter encoded MDP. Given an MDP \mathcal{M} , we define the MDP $S(\mathcal{M})$ which has a step counter encoded into the state. This will allow us to obtain Markov strategies in \mathcal{M} from positional strategies in $S(\mathcal{M})$.

Definition 1. Let \mathcal{M} be an MDP with an initial state s_0 . We then construct the MDP $S(\mathcal{M}) \stackrel{\text{def}}{=} (S', S'_\square, S'_\circ, \longrightarrow_{S(\mathcal{M})}, P')$ as follows:

- The state space of $S(\mathcal{M})$ is $S' \stackrel{\text{def}}{=} \{(s, n) \mid s \in S \text{ and } n \in \mathbb{N}\}$. Note that S' is countable. We write s'_0 for the initial state $(s_0, 0)$.
- $S'_\square \stackrel{\text{def}}{=} \{(s, n) \in S' \mid s \in S_\square\}$ and $S'_\circ \stackrel{\text{def}}{=} S' \setminus S'_\square$.
- The set of transitions in $S(\mathcal{M})$ is

$$\longrightarrow_{S(\mathcal{M})} \stackrel{\text{def}}{=} \{((s, n), (s', n+1)) \mid (s, n), (s', n+1) \in S', s \longrightarrow_{\mathcal{M}} s'\}.$$

- $P' : S'_\circ \rightarrow \mathcal{D}(S')$ is defined such that

$$P'(s, n)(s', m) \stackrel{\text{def}}{=} \begin{cases} P(s)(s') & \text{if } (s, n) \longrightarrow_{S(\mathcal{M})} (s', m) \\ 0 & \text{otherwise} \end{cases}$$

- If \mathcal{M} has rewards, then $r((s, n) \longrightarrow_{S(\mathcal{M})} (s', n+1)) \stackrel{\text{def}}{=} r(s \longrightarrow_{\mathcal{M}} s')$.

By labeling the state with the path length from s_0 , we effectively encode a step counter into the MDP $S(\mathcal{M})$.

Lemma 1. *Let \mathcal{M} be an MDP with initial state s_0 . Let φ be an objective depending only on the sequence of seen point rewards. Then given an MD strategy σ' in $S(\mathcal{M})$ attaining $c \in [0, 1]$ for φ from $(s_0, 0)$, there exists a strategy σ attaining c for φ in \mathcal{M} from s_0 which uses the same memory as σ' plus a step counter.*

Proof. Let σ' be an MD strategy in $S(\mathcal{M})$ attaining $c \in [0, 1]$ for φ from $(s_0, 0)$. We define a strategy σ on \mathcal{M} from s_0 that uses the same memory as σ' plus a step counter. Then σ plays on \mathcal{M} exactly like σ' plays on $S(\mathcal{M})$, keeping the step counter in its memory instead of in the state. I.e., at a given state s and step counter value n , σ plays exactly as σ' plays in state (s, n) . By our construction of $S(\mathcal{M})$ and the definition of σ , the sequences of point rewards seen by σ' in runs on $S(\mathcal{M})$ coincide with the sequences of point rewards seen by σ in runs in \mathcal{M} . Hence we obtain $\mathcal{P}_{S(\mathcal{M}), (s_0, 0), \sigma'}(\varphi) = \mathcal{P}_{\mathcal{M}, s_0, \sigma}(\varphi)$. \square

The conditioned MDP. We recall the notion of the conditioned MDP \mathcal{M}_* , which will allow us to lift ε -optimal strategies to *uniformly* ε -optimal strategies. Moreover, it can be used to lift ε -optimal strategies to optimal ones in some cases.

Definition 2. ([18, Def. 12].) For an MDP $\mathcal{M} = (S, S_\square, S_\circ, \longrightarrow, P, r)$ and an objective φ that is shift invariant in \mathcal{M} , define the *conditioned version* of \mathcal{M} w.r.t. φ to be the MDP $\mathcal{M}_* = (S_*, S_{*\square}, S_{*\circ}, \longrightarrow_*, P_*)$ with

$$\begin{aligned}
 S_{*\square} &= \{s \in S_\square \mid \text{val}_{\mathcal{M}}(s) > 0\} \\
 S_{*\circ} &= \{s \in S_\circ \mid \text{val}_{\mathcal{M}}(s) > 0\} \cup \{s_\perp\} \cup \{(s, t) \in \longrightarrow \mid s \in S_\square, \text{val}_{\mathcal{M}}(s) > 0\} \\
 \longrightarrow_* &= \{(s, (s, t)) \in (S_\square \times \longrightarrow) \mid \text{val}_{\mathcal{M}}(s) > 0, s \longrightarrow t\} \cup \\
 &\quad \{(s, t) \in S_\circ \times S \mid \text{val}_{\mathcal{M}}(s) > 0, \text{val}_{\mathcal{M}}(t) > 0\} \cup \\
 &\quad \{((s, t), t) \in (\longrightarrow \times S) \mid \text{val}_{\mathcal{M}}(s) > 0, \text{val}_{\mathcal{M}}(t) > 0\} \cup \\
 &\quad \{((s, t), s_\perp) \in (\longrightarrow \times \{s_\perp\}) \mid \text{val}_{\mathcal{M}}(s) > \text{val}_{\mathcal{M}}(t)\} \cup \\
 P_*(s, t) &= P(s, t) \cdot \frac{\text{val}_{\mathcal{M}}(t)}{\text{val}_{\mathcal{M}}(s)} & P_*((s, t), t) &= \frac{\text{val}_{\mathcal{M}}(t)}{\text{val}_{\mathcal{M}}(s)} \\
 P_*((s, t), s_\perp) &= 1 - \frac{\text{val}_{\mathcal{M}}(t)}{\text{val}_{\mathcal{M}}(s)}
 \end{aligned}$$

The transition rewards are carried from \longrightarrow to \longrightarrow_* in the natural way, i.e., $r(s, (s, t)) = r((s, t), t) = r(s, t)$. Finally, we add an infinite chain of fresh states and transitions $s_\perp \rightarrow s_\perp^1 \rightarrow s_\perp^2 \rightarrow \dots$ with rewards suitably defined such that it is losing for the objective φ .

Lemma 2. ([18, Lemma 13.3 and Lemma 16].) *Let $\mathcal{M} = (S, S_\square, S_\circ, \longrightarrow, P, r)$ be an MDP, and let φ be an objective that is shift invariant in \mathcal{M} . Let $\mathcal{M}_* = (S_*, S_{*\square}, S_{*\circ}, \longrightarrow_*, P_*)$ be the conditioned version of \mathcal{M} w.r.t. φ . Let $s_0 \in S_* \cap S$. Let $\sigma \in \Sigma_{\mathcal{M}_*}$, and note that σ can be transformed to a strategy in \mathcal{M} in a natural way.*

We have $\text{val}_{\mathcal{M}}(s_0) \cdot \mathcal{P}_{\mathcal{M}_, s_0, \sigma}(\varphi) = \mathcal{P}_{\mathcal{M}, s_0, \sigma}(\varphi)$. In particular, $\text{val}_{\mathcal{M}_*}(s_0) = 1$, and, for any $\varepsilon \geq 0$, strategy σ is ε -optimal in \mathcal{M}_* if and only if it is $\varepsilon \text{val}_{\mathcal{M}}(s_0)$ -optimal in \mathcal{M} . Moreover, if \mathcal{M} is universally transient, then so is \mathcal{M}_* .*

Lemma 3. *Let $\mathcal{M} = (S, S_\square, S_\circ, \longrightarrow, P, r)$ be a countable MDP, and φ an event that is shift invariant in \mathcal{M} . Assume that from every state $s_0 \in S$ that has an almost surely winning strategy there also exists an almost surely winning deterministic positional*

(resp. randomized positional) strategy.

Then there exists a single deterministic positional (resp. randomized positional) strategy that is almost surely winning from every state in \mathcal{M} that has an almost surely winning strategy.

Proof. Let $S' \subseteq S$ be the subset of states that have an a.s. winning strategy. Pick an arbitrary state $s_0^1 \in S'$ and an a.s. winning deterministic positional (resp. randomized positional) strategy σ^1 from s_0^1 . Let $S_1 \subseteq S'$ be the set of states that σ^1 reaches with nonzero probability. Since φ is shift invariant, σ^1 must be a.s. winning from every state in S_1 . For the next round pick a state $s_0^2 \in S' \setminus S_1$ (if one exists) and an a.s. winning deterministic positional (resp. randomized positional) strategy σ^1 from s_0^2 and repeat the construction, etc.

Let σ be the deterministic positional (resp. randomized positional) strategy that plays like σ^i in all states in $S_i \setminus \bigcup_{j < i} S_j$. Since $S' = \bigcup_i S_i$ the deterministic positional (resp. randomized positional) strategy σ is a.s. winning from every state in S' . \square

Theorem 1. *Consider an objective φ that is shift invariant in every MDP. Suppose that, in every MDP (resp. in every universally transient MDP), every state that has an almost surely winning strategy for φ also has an almost surely winning positional strategy σ for φ .*

Then, in every MDP (resp. in every universally transient MDP), there exists a single positional strategy $\hat{\sigma}$ for φ that is optimal from every state that has an optimal strategy. If σ can always be chosen as deterministic, then $\hat{\sigma}$ can be chosen as deterministic.

Proof. Let $\mathcal{M} = (S, S_{\square}, S_{\circ}, \longrightarrow, P, r)$ be an MDP. Consider the conditioned version $\mathcal{M}_* = (S_*, S_{*\square}, S_{*\circ}, \longrightarrow_*, P_*)$ of \mathcal{M} w.r.t. φ , and let $\varepsilon = 0$. (Recall that 0-optimal means optimal in general, and a.s. winning in the case where the value is one.) By Lemma 2, if \mathcal{M} is universally transient then \mathcal{M}_* is universally transient. Moreover, every state that has an optimal strategy in \mathcal{M} has an a.s. winning strategy in \mathcal{M}_* and vice-versa. By applying Lemma 3 to \mathcal{M}_* we obtain a single deterministic positional (resp. randomized positional) strategy $\hat{\sigma}$ that is a.s. winning from every state in \mathcal{M}_* that has an a.s. winning strategy. By Lemma 2, the same deterministic positional (resp. randomized positional) strategy $\hat{\sigma}$ is optimal from every state in \mathcal{M} that has an optimal strategy. \square

The following Theorem 2 is a general result concerning shift invariant objectives. We use this result to lift ε -optimal upper bounds to optimal upper bounds when the two bounds coincide. Note that its preconditions are different from those of Theorem 1.

Theorem 2. ([18, Theorem 7]) *Let $\mathcal{M} = (S, S_{\square}, S_{\circ}, \longrightarrow, P, r)$ be a countable MDP, and let φ be an event that is shift invariant in \mathcal{M} . Suppose for every $s \in S$ there exist ε -optimal MD strategies for φ . Then:*

1. *There exist uniform ε -optimal MD strategies for φ .*
2. *There exists a single MD strategy that is optimal from every state that has an optimal strategy.*

Remark 1. By and large, our results are stated in terms of ε -optimal or optimal strategies from a given start state s_0 . Since all of the objectives that we consider are shift invariant, it follows that Theorem 2.1 applies everywhere. It would be very repetitive to state a second theorem after every upper bound saying that Theorem 2 applies and that therefore uniform strategies also exist. We choose therefore to save on repetitions by issuing the blanket statement that Theorem 2 applies everywhere that you would expect and the relevant uniformity results hold despite not being explicitly stated.

3. Objectives and how they are connected

The objectives. In this paper we study six objectives that are naturally presented as two sets of three objectives which are dual to each other. They are as follows.

- The $\limsup_{PP}(\geq 0)$ objective aims to maximize the probability that the \limsup of the *point* payoffs (the immediate transition rewards) is ≥ 0 , i.e., $\limsup_{PP}(\geq 0) \stackrel{\text{def}}{=} \{\rho \mid \limsup_{n \in \mathbb{N}} r(\rho_e(n)) \geq 0\}$.
- Given a monotone decreasing (w.r.t. set inclusion) sequence of sets of transitions $\{A_i\}_{i \in \mathbb{N}}$, the objective $\bigcap_{i \in \mathbb{N}} \mathbf{GF} A_i$ aims to maximize the probability that, for all i , the set A_i is visited infinitely often.
- The $\liminf_{PP}(\geq 0)$ objective aims to maximize the probability that the \liminf of the point payoffs is ≥ 0 , i.e., $\liminf_{PP}(\geq 0) \stackrel{\text{def}}{=} \{\rho \mid \liminf_{n \in \mathbb{N}} r(\rho_e(n)) \geq 0\}$.

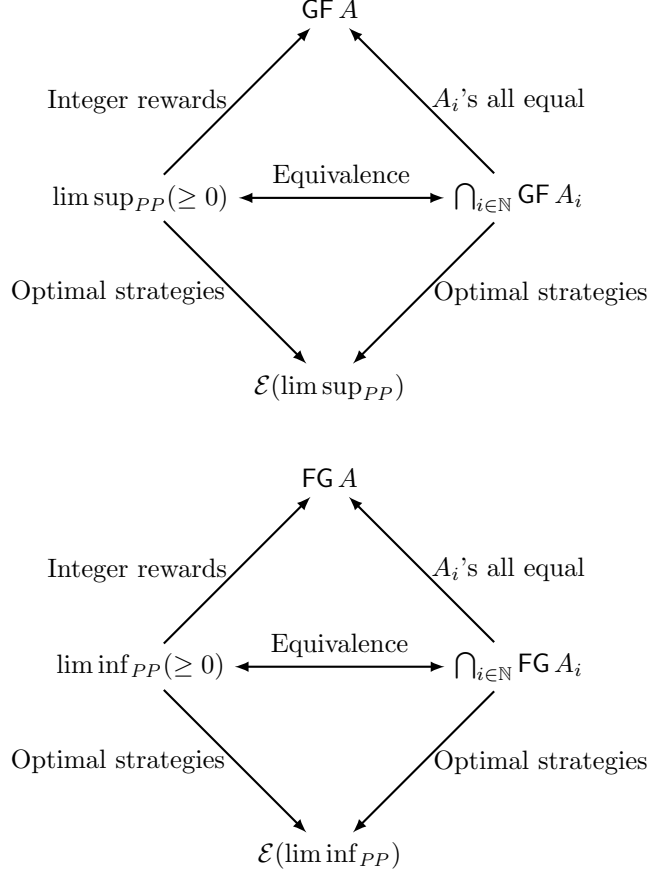

FIGURE 1: Top: Diagram illustrating how the ‘Büchi-like’ objectives relate to each other.

Bottom: Diagram illustrating how the ‘co-Büchi-like’ objectives relate to each other.

- Given a monotone decreasing sequence of sets of transitions $\{A_i\}_{i \in \mathbb{N}}$, the objective $\bigcap_{i \in \mathbb{N}} \text{FG } A_i$ aims to maximize the probability that, for all i , eventually only transitions in A_i are visited.
- The $\mathcal{E}(\text{lim sup}_{PP})$ objective aims to maximize the expectation of the lim sup of the point payoffs, i.e., for runs ρ we want to maximize $\mathcal{E}(\text{lim sup}_{n \in \mathbb{N}} r(\rho_e(n)))$.
- The $\mathcal{E}(\text{lim inf}_{PP})$ objective aims to maximize the expectation of the lim inf of the point payoffs, i.e., for runs ρ we want to maximize $\mathcal{E}(\text{lim inf}_{n \in \mathbb{N}} r(\rho_e(n)))$.

Threshold objectives. The purpose of this section is to highlight the relations between on the one hand the ‘Büchi-like’ objectives $\text{lim sup}_{PP}(\geq 0)$, $\bigcap_{i \in \mathbb{N}} \text{GF } A_i$ and

$\mathcal{E}(\limsup_{PP})$ and on the other hand the ‘co-Büchi-like’ objectives $\liminf_{PP}(\geq 0)$, $\bigcap_{i \in \mathbb{N}} \text{FG } A_i$ and $\mathcal{E}(\liminf_{PP})$. Without going into details on the upper and lower bounds of the strategy complexity for the specific objectives, we provide details on how $\limsup_{PP}(\geq 0)/\liminf_{PP}(\geq 0)$ and $\bigcap_{i \in \mathbb{N}} \text{GF } A_i/\bigcap_{i \in \mathbb{N}} \text{FG } A_i$ are respectively inter-reducible.

Remark 2. (*Intuition.*) Built into all of the above objectives is a notion of progress. In order to succeed, a strategy must strive to see better and better sets A_i (resp. better transition rewards), leaving behind those sets (or rewards) that are no longer good enough. In order to make this progress happen, there must be some sort of driving force behind the strategy. This can come either in the form of the MDP’s underlying acyclicity or universal transience, or via the strategy’s step counter, or we can create it ourselves by suitably modifying the MDP or by exploiting the finite branching degree of the MDP in order to define a function that measures the distance from the start state.

The objectives $\bigcap_{i \in \mathbb{N}} \text{GF } A_i$ and $\limsup_{PP}(\geq 0)$ are closely related, and in fact inter-reducible (cf. Lemma 4 and Lemma 5).

Lemma 4. *For every $\bigcap_{i \in \mathbb{N}} \text{GF } A_i$ objective, there exists a reward function r such that $\bigcap_{i \in \mathbb{N}} \text{GF } A_i = \limsup_{PP}(\geq 0)$ in the MDP $\mathcal{M} = (S, S_\square, S_\circ, \longrightarrow, P, r)$.*

Proof. We define the transition based reward function r such that

$$r(t) = \begin{cases} 0 & \text{if } \forall i \ t \in A_i \\ -2^{-i} & \text{if } i = \max\{i \in \mathbb{N} \mid t \in A_i\} \\ -1 & \text{otherwise} \end{cases}$$

Now we show that $\bigcap_{i \in \mathbb{N}} \text{GF } A_i = \limsup_{PP}(\geq 0)$ in \mathcal{M} .

1. Consider a run $\rho \in \bigcap_{i \in \mathbb{N}} \text{GF } A_i$. By definition, ρ always eventually visits transitions in A_i for every i . By construction of r , ρ therefore always eventually visits transitions with reward -2^{-i} for every i . I.e., $\rho \in \limsup_{PP}(\geq 0)$.
2. Consider a run $\rho \in \limsup_{PP}(\geq 0)$. By construction of r , this means that the lim sup of the seen rewards must be 0. Hence either ρ visits infinitely many

transitions with reward 0, in which case ρ visits infinitely many transitions which are in A_i for all i and thus $\rho \in \bigcap_{i \in \mathbb{N}} \text{GF } A_i$. Otherwise the sequence of rewards seen by ρ converges to 0 from below, in which case ρ must visit infinitely many transitions $t \in A_i$ for every i , and thus also $\rho \in \bigcap_{i \in \mathbb{N}} \text{GF } A_i$.

□

Lemma 5. *Let $\mathcal{M} = (S, S_{\square}, S_{\circ}, \longrightarrow, P, r)$ be a countable MDP. Given a $\limsup_{PP}(\geq 0)$ objective, there exist sets of transitions A_i with $A_{i+1} \subseteq A_i$ for all i such that $\limsup_{PP}(\geq 0) = \bigcap_{i \in \mathbb{N}} \text{GF } A_i$.*

Proof. We define the sets of transitions A_i such that $A_i \stackrel{\text{def}}{=} \{t \in \longrightarrow \mid r(t) \geq -2^{-i}\}$. The rest of the proof is very similar to Lemma 4. □

Symmetrically to the situation for $\bigcap_{i \in \mathbb{N}} \text{GF } A_i$ and $\limsup_{PP}(\geq 0)$, the objectives $\bigcap_{i \in \mathbb{N}} \text{FG } A_i$ and $\liminf_{PP}(\geq 0)$ are also inter-reducible.

Lemma 6. *For every $\bigcap_{i \in \mathbb{N}} \text{FG } A_i$ objective, there exists a reward function r such that $\bigcap_{i \in \mathbb{N}} \text{FG } A_i = \liminf_{PP}(\geq 0)$ in $\mathcal{M} = (S, S_{\square}, S_{\circ}, \longrightarrow, P, r)$.*

Proof. Almost identical to Lemma 4. □

Lemma 7. *Let $\mathcal{M}(S, S_{\square}, S_{\circ}, \longrightarrow, P, r)$ be a countable MDP. Given a $\liminf_{PP}(\geq 0)$ objective, there exist sets of transitions A_i with $A_{i+1} \subseteq A_i$ for all i such that $\liminf_{PP}(\geq 0) = \bigcap_{i \in \mathbb{N}} \text{FG } A_i$.*

Proof. Almost identical to Lemma 5. □

3.1. Relation to the expected payoff

We now show how the expected payoff objectives $\mathcal{E}(\limsup_{PP})$ and $\mathcal{E}(\liminf_{PP})$ relate to the threshold objectives.

The expected payoff objectives are more natural to define in the context of state based rewards. This is because we want to be able to refer to the value of a state and compare that value to the reward of that state itself. This is less important for the threshold objectives, since the rewards and the values are measured on two different scales as it were. Therefore, we briefly illustrate how transition based rewards and state based rewards can be encoded into each other.

Definition 3. Given an MDP $\mathcal{M} = (S, S_{\square}, S_{\circ}, \rightarrow, P, r)$ with state based rewards bounded between $+m$ and $-m$, $m \in \mathbb{R}$, we construct a modified MDP with transition based rewards $\mathcal{M}^t = (S^t, S_{\square}^t, S_{\circ}^t, \rightarrow^t, P^t, r^t)$ as follows. For every $s \in S$, we construct two new states s_{in} and s_{out} and a transition t^s with reward $r(t^s) = r(s)$. I.e. we replace every instance of



Formally, we construct two copies of S , $S_{\text{in}} \stackrel{\text{def}}{=} \{s_{\text{in}} \mid s \in S\}$ and $S_{\text{out}} \stackrel{\text{def}}{=} \{s_{\text{out}} \mid s \in S\}$. Similarly, define $S_{\square \text{in}} \stackrel{\text{def}}{=} \{s_{\text{in}} \mid s \in S_{\square}\}$, $S_{\square \text{out}} \stackrel{\text{def}}{=} \{s_{\text{out}} \mid s \in S_{\square}\}$ and $S_{\circ \text{in}} \stackrel{\text{def}}{=} S_{\text{in}} \setminus S_{\square \text{in}}$, $S_{\circ \text{out}} \stackrel{\text{def}}{=} S_{\text{out}} \setminus S_{\square \text{out}}$. This allows us to define:

- $S^t \stackrel{\text{def}}{=} S_{\text{in}} \cup S_{\text{out}}, S_{\square}^t \stackrel{\text{def}}{=} S_{\square \text{in}} \cup S_{\square \text{out}}, S_{\circ}^t \stackrel{\text{def}}{=} S_{\circ \text{in}} \cup S_{\circ \text{out}},$
- $\rightarrow^t \stackrel{\text{def}}{=} \{s_{\text{in}} \rightarrow^t s_{\text{out}} \mid s \in S\} \cup \{s_{\text{out}} \rightarrow^t s'_{\text{in}} \mid s \rightarrow s'\}$
-

$$r^t(s \rightarrow^t s') \stackrel{\text{def}}{=} \begin{cases} -m \text{ (resp. } +m) & \text{if } s \in S_{\text{out}} \\ r(s) & \text{if } s \in S_{\text{in}} \end{cases}$$

- For $s \in S_{\circ}$ and $s' \in S$, define $P^t(s_{\text{in}})(s'_{\text{out}}) \stackrel{\text{def}}{=} 1$ and $P^t(s_{\text{out}})(s'_{\text{in}}) \stackrel{\text{def}}{=} P(s)(s')$.

Note that the definitions of r^t and P^t are complete since there are no transitions from S_{in} to itself or from S_{out} to itself.

Lemma 8. *Given an MDP \mathcal{M} with state based rewards bounded between $+m$ and $-m$, $m \in \mathbb{R}$, for every optimal $\limsup_{PP}(\geq 0)$ (resp. $\liminf_{PP}(\geq 0)$) strategy σ in \mathcal{M}^t , there exists an optimal $\limsup_{PP}(\geq 0)$ (resp. $\liminf_{PP}(\geq 0)$) strategy σ' in \mathcal{M} with the same memory as σ such that $\mathcal{P}_{\mathcal{M}^t, s_{0 \text{in}}, \sigma}(\limsup_{PP}(\geq 0)) = \mathcal{P}_{\mathcal{M}, s_0, \sigma'}(\limsup_{PP}(\geq 0))$ (resp. $\mathcal{P}_{\mathcal{M}^t, s_{0 \text{in}}, \sigma}(\liminf_{PP}(\geq 0)) = \mathcal{P}_{\mathcal{M}, s_0, \sigma'}(\liminf_{PP}(\geq 0))$).*

Proof. Consider an optimal strategy σ for $\limsup_{PP}(\geq 0)$ (resp. $\liminf_{PP}(\geq 0)$) in \mathcal{M}^t . We will use σ to construct a new strategy σ' which is optimal $\limsup_{PP}(\geq 0)$ (resp. $\liminf_{PP}(\geq 0)$) in \mathcal{M} . For $s, s' \in S$, let $\sigma'(s)(s') \stackrel{\text{def}}{=} \sigma(s_{\text{out}})(s'_{\text{in}})$. Note that σ' ignores all of the actions that σ takes from an *in* state to an *out* state. This is because by construction of \mathcal{M}^t there are no decisions to be made in those cases. In the case where σ is $\text{Det}(\text{F})$ or $\text{Rand}(\text{F})$, σ' makes all of the same decisions as σ , and thus the probability of a given sequence of rewards is the same between the two strategies

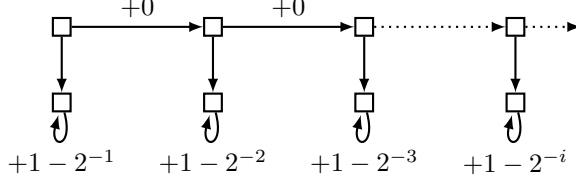
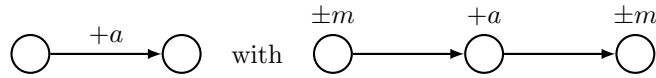

FIGURE 2: All strategies are optimal for $\liminf_{PP}(\geq 0)/\limsup_{PP}(\geq 0)$, yet there are no optimal strategies for $\mathcal{E}(\liminf_{PP})/\mathcal{E}(\limsup_{PP})$. Every threshold < 1 has an optimal strategy, yet thresholds ≥ 1 have no optimal strategies.

(modulo the buffer rewards $\pm m$ in \mathcal{M}^t). Thus the attainment of σ and σ' must be the same. In the case where σ uses a step counter in its memory, notice that path lengths in \mathcal{M}^t are doubled relative to path lengths in \mathcal{M} . However, since there is no decision to be made in alternating states, we adjust for this by making σ' 's step counter count twice as fast so that all decisions are made at even step counter values, mirroring the step counter σ uses. Hence σ and σ' must have the same attainment. \square

Remark 3. The reverse construction also clearly works. Given an MDP \mathcal{M} with transition based rewards, there exists an MDP \mathcal{M}^s with state based rewards such that for every optimal $\limsup_{PP}(\geq 0)$ (resp. $\liminf_{PP}(\geq 0)$) strategy σ in \mathcal{M}^s , there exists an optimal $\limsup_{PP}(\geq 0)$ (resp. $\liminf_{PP}(\geq 0)$) strategy σ' in \mathcal{M} .

The proof follows from a very similar construction which replaces all instances of



Theorem 3 reduces the task of finding optimal $\mathcal{E}(\limsup_{PP})$ (resp. $\mathcal{E}(\liminf_{PP})$) strategies to that of finding optimal $\limsup_{PP}(\geq 0)$ (resp. $\liminf_{PP}(\geq 0)$) strategies. This crucial result will allow us to obtain upper bound results for optimal $\mathcal{E}(\limsup_{PP})$ (resp. $\mathcal{E}(\liminf_{PP})$) for free from results on optimal $\limsup_{PP}(\geq 0)$ and $\liminf_{PP}(\geq 0)$.

Theorem 3. Let $\mathcal{M} = (S, S_{\square}, S_{\circ}, \rightarrow, P, r)$ be a countable MDP with initial state s_0 and assume that there exist optimal strategies for $\mathcal{E}(\limsup_{PP})$ (resp. $\mathcal{E}(\liminf_{PP})$). Then there exists an MDP \mathcal{M}^u with reward function u such that optimal strategies for $\limsup_{PP}(\geq 0)$ (resp. $\liminf_{PP}(\geq 0)$) in \mathcal{M}^u are optimal $\mathcal{E}(\limsup_{PP})$ (resp.

$\mathcal{E}(\liminf_{PP})$) strategies in \mathcal{M} . Therefore, the strategy complexity of optimal $\mathcal{E}(\limsup_{PP})$ (resp. $\mathcal{E}(\liminf_{PP})$) is no greater than the strategy complexity of optimal $\limsup_{PP}(\geq 0)$ (resp. $\liminf_{PP}(\geq 0)$).

Proof. For readability, we just present the proof for $\mathcal{E}(\limsup_{PP})$ here. To obtain the proof for $\mathcal{E}(\liminf_{PP})$, simply replace \limsup with \liminf and $\bigcap_{i \in \mathbb{N}} \text{GF } A_i$ with $\bigcap_{i \in \mathbb{N}} \text{FG } A_i$ and [13, Theorem 3.7.2] by [29, Lemma 5].

Let $\mathcal{M} = (S, S_{\square}, S_{\circ}, \longrightarrow, P, r)$ be a countable MDP with bounded state based rewards where optimal strategies exist for $\mathcal{E}(\limsup_{PP})$. Let σ be an optimal strategy for $\mathcal{E}(\limsup_{PP})$. Let \mathcal{M}^r be the sub-MDP of \mathcal{M} composed only of those states and transitions used by σ with positive probability. Since σ is optimal, all controlled transitions $s \rightarrow s'$ in \mathcal{M}^r are such that $\text{val}_{\mathcal{M}^r, \mathcal{E}(\limsup_{PP})}(s) = \text{val}_{\mathcal{M}^r, \mathcal{E}(\limsup_{PP})}(s')$. Hence, all strategies in \mathcal{M}^r are value preserving (aka thrifty). Let $A_i \stackrel{\text{def}}{=} \{s \in S \mid r(s) \geq \text{val}_{\mathcal{M}^r, \mathcal{E}(\limsup_{PP})}(s) - 2^{-i}\}$ for all i . By [13, Theorem 3.7.2], σ is equalizing if and only if $\mathcal{P}_{\mathcal{M}^r, s, \sigma}(\bigcap_{i \in \mathbb{N}} \text{GF } A_i) = 1$. We know that strategies are optimal if and only if they are equalizing and thrifty. I.e., $\mathcal{E}(\limsup_{PP})$ optimality in \mathcal{M}^r is equivalent to $\bigcap_{i \in \mathbb{N}} \text{GF } A_i$.

We now define a new state based reward function u as follows:

$$u(s) \stackrel{\text{def}}{=} \begin{cases} -1 & \forall i \in \mathbb{N}, s \notin A_i, \\ 0 & \forall i \in \mathbb{N}, s \in A_i, \\ -2^{-\max\{i \in \mathbb{N} \mid s \in A_i\}} & \text{otherwise} \end{cases}$$

Now we let \mathcal{M}^u be the MDP that is like \mathcal{M}^r except that it uses reward function u instead of reward function r . We claim that a strategy τ is optimal for $\mathcal{E}(\limsup_{PP})$ in \mathcal{M}^r if and only if it is optimal for $\limsup_{PP}(\geq 0)$ in \mathcal{M}^u . Notice that strategies defined on \mathcal{M}^r are also defined on \mathcal{M}^u and vice-versa, since the only difference between the two MDPs is the reward function. The claim follows immediately from the observation that runs satisfy $\limsup_{PP}(\geq 0)$ in \mathcal{M}^u if and only if they satisfy $\bigcap_{i \in \mathbb{N}} \text{GF } A_i$. Hence a strategy τ is optimal for $\limsup_{PP}(\geq 0)$ in \mathcal{M}^u if and only if it is optimal for $\bigcap_{i \in \mathbb{N}} \text{GF } A_i$ if and only if it is optimal for $\mathcal{E}(\limsup_{PP})$ in \mathcal{M}^r .

Thus, we have reduced the problem finding optimal strategies for $\mathcal{E}(\limsup_{PP})$ to the problem of finding optimal $\limsup_{PP}(\geq 0)$ strategies. \square

$\bigcap_{i \in \mathbb{N}} \text{GF } A_i$ and $\limsup_{PP}(\geq 0)$	Upper bound	Lower bound
ε -optimal strategies	Det(SC + 1-bit) 3	\neg Rand(SC) 10 and \neg Rand(F) 8
Optimal strategies	Rand(Positional) 2 or Det(SC) 1	\neg Det(F) 7

TABLE 1: Summary of strategy complexity results for $\bigcap_{i \in \mathbb{N}} \text{GF } A_i$ and $\limsup_{PP}(\geq 0)$. Note that the (infinite vs. finite) branching degree of the MDP does not affect the strategy complexity here.

Remark 4. The reduction in Theorem 3 does not work in both directions. I.e., we cannot reduce optimal $\liminf_{PP}(\geq 0)/\limsup_{PP}(\geq 0)$ to optimal $\mathcal{E}(\liminf_{PP})/\mathcal{E}(\limsup_{PP})$. Figure 2 gives an example of an MDP where optimal strategies exist for $\liminf_{PP}(\geq 0)/\limsup_{PP}(\geq 0)$, but do not exist for $\mathcal{E}(\liminf_{PP})/\mathcal{E}(\limsup_{PP})$.

4. Strategy complexity of $\bigcap_{i \in \mathbb{N}} \text{GF } A_i$ and $\limsup_{PP}(\geq 0)$

In light of Lemma 4 and Lemma 5, we present strategy complexity results on $\bigcap_{i \in \mathbb{N}} \text{GF } A_i$ and $\limsup_{PP}(\geq 0)$ together and interchangeably.

Note that positional strategies are a special case of finite-memory strategies, i.e., with only one memory mode. Thus the following lemma also allows to carry positional strategies between MDPs.

Lemma 9. *Consider an infinitely branching MDP $\mathcal{M} = (S, S_{\square}, S_{\circ}, \longrightarrow, P, r)$ and the $\limsup_{PP}(\geq 0)$ objective. There exists a corresponding binary branching MDP $\mathcal{M}' = (S', S'_{\square}, S'_{\circ}, \longrightarrow', P', r')$ with $S \subseteq S'$, $S_{\square} \subseteq S'_{\square}$, $S_{\circ} \subseteq S'_{\circ}$ such that*

1. \mathcal{M}' is acyclic (resp. universally transient) iff \mathcal{M} is acyclic (resp. universally transient).
2. The value of states is preserved, i.e.,

$$\forall s \in S \quad \text{val}_{\mathcal{M}, \limsup_{PP}(\geq 0)}(s) = \text{val}_{\mathcal{M}', \limsup_{PP}(\geq 0)}(s).$$

3. Finite memory randomized (resp. deterministic) strategies σ' in \mathcal{M}' can be carried back to \mathcal{M} . I.e., for every Rand(F) (resp. Det(F)) strategy σ' from some

$s_0 \in S$ in \mathcal{M}' there exists a corresponding strategy σ from s_0 in \mathcal{M} with the same memory and randomization such that

$$\mathcal{P}_{\mathcal{M},s_0,\sigma}(\limsup_{PP}(\geq 0)) \geq \mathcal{P}_{\mathcal{M}',s_0,\sigma'}(\limsup_{PP}(\geq 0)).$$

Proof. We construct \mathcal{M}' from \mathcal{M} by replacing every infinitely branching controlled state

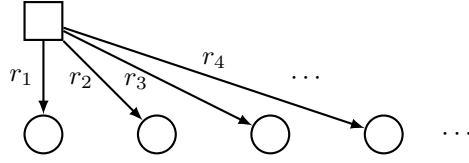

by

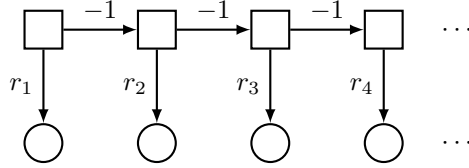

The above construction is also called the *ladder gadget*. It includes negative rewards -1 on the ladder transitions (top row) to ensure that strategies must leave the ladder eventually (since runs that stay on the ladder do not satisfy $\limsup_{PP}(\geq 0)$).

Infinitely branching random states with $x \xrightarrow{p_i} y_i$ for all $i \in \mathbb{N}$ are replaced by a gadget $x \xrightarrow{1} z_1, z_i \xrightarrow{1-p'_i} z_{i+1}, z_i \xrightarrow{p'_i} y_i$ for all $i \in \mathbb{N}$, with fresh random states z_i and suitably adjusted probabilities p'_i to ensure that the gadget is left at state y_i with probability p_i , i.e., $p'_i = p_i / (\prod_{j=1}^{i-1} (1 - p'_j))$. Almost all the new auxiliary transitions have reward -1 , except for the last step to y_i , which is given the same reward as the original transition $x \xrightarrow{p_i} y_i$.

Finally, each non-binary finite branching is replaced by a binary tree where the new auxiliary transitions have reward -1 and the last step has the original reward.

Thus \mathcal{M}' has branching degree ≤ 2 .

Item 1. follows from the fact that the auxiliary gadgets in \mathcal{M}' are acyclic.

Towards item 2., note that for every strategy in \mathcal{M}' from some state $s \in S$ there is a corresponding strategy in \mathcal{M} from s that attains *at least* as much for $\limsup_{PP}(\geq 0)$, and vice-versa. This is because runs that stay on the ladder gadget forever do not

satisfy $\limsup_{PP}(\geq 0)$ and thus the new additions in \mathcal{M}' confer no advantage. So the corresponding strategy just imitates the outcome of the branching in the other MDP.

Thus

$$\forall s \in S \text{ val}_{\mathcal{M}, \limsup_{PP}(\geq 0)}(s) = \text{val}_{\mathcal{M}', \limsup_{PP}(\geq 0)}(s).$$

Towards item 3., we show that finite memory randomized (resp. deterministic) strategies can be carried from \mathcal{M}' to \mathcal{M} with the same memory and randomization.

Let $s_0 \in S$ be the initial state and let \mathbf{M} be the finite set of memory modes used by σ' . Consider some state x in \mathcal{M} that is infinitely branching to states y_i for $i \in \mathbb{N}$, and its associated ladder gadget in \mathcal{M}' . Whenever a run in \mathcal{M}' according to σ' reaches x in some memory mode $\alpha \in \mathbf{M}$ there exists a combined probability distribution d over the set of outcomes. I.e., $d(y_i, \alpha_j)$ is the probability that we exit the gadget at state y_i in memory mode α_j . It is also possible that we do not exit the gadget at all, but in this case we do not care about the memory modes, since this run will not satisfy $\limsup_{PP}(\geq 0)$ anyway. Let $p \stackrel{\text{def}}{=} 1 - \sum_{i,j} d(y_i, \alpha_j)$ be the probability of not exiting the gadget.

We now define the corresponding strategy σ in \mathcal{M} with the same memory as σ' . Whenever σ is in state x in memory mode $\alpha \in \mathbf{M}$ then it plays as follows.

If x is a random state then $p = 0$, i.e., we will exit the gadget almost surely. Moreover, σ does not select the next state, but can only update its memory. By construction of \mathcal{M}' we will go to state y_i in \mathcal{M} with the same probability as in \mathcal{M}' . Upon arriving at some state y_i , σ will update its memory to match the distribution d , i.e., it will set its memory to mode α_j with probability $d(y_i, \alpha_j) / (\sum_j d(y_i, \alpha_j))$.

If x is a controlled state then σ selects the successor state y_i and new memory mode α_j as follows. It selects y_1 and α_1 with probability $d(y_1, \alpha_1) + p$ (special case), and otherwise selects y_i and α_j with probability $d(y_i, \alpha_j)$ (normal case). The special case is needed to obtain a distribution in case $p > 0$.

The construction for states that are finitely, but non-binary, branching in \mathcal{M} is similar but easier (since the gadget will surely be exited).

In all other states, σ does the same in \mathcal{M} as σ' in \mathcal{M}' .

We observe that σ is deterministic iff σ' is deterministic.

Finally, we observe that σ attains at least as much for the objective $\limsup_{PP}(\geq 0)$

in \mathcal{M} as σ' in \mathcal{M}' . The additionally seen rewards of -1 in the gadgets in \mathcal{M}' make no difference for $\limsup_{PP}(\geq 0)$ if the gadget is exited. The runs that stay forever in some gadget in \mathcal{M}' do not satisfy $\limsup_{PP}(\geq 0)$ anyway, and thus the different extra corresponding runs in \mathcal{M} (by the extra probability $+p$) via the special case definition above cannot do worse. All other runs in \mathcal{M}' are mimicked by runs in \mathcal{M} (w.r.t. seen states and memory modes) and the probabilities coincide. Thus $\mathcal{P}_{\mathcal{M},s_0,\sigma}(\limsup_{PP}(\geq 0)) \geq \mathcal{P}_{\mathcal{M}',s_0,\sigma'}(\limsup_{PP}(\geq 0))$. \square

Note that Lemma 9 does not hold for every other objective. E.g., even for $\liminf_{PP}(\geq 0)$ it *does* make a difference whether the MDP is finitely branching or infinitely branching [22].

4.1. Upper Bounds

We choose to present the upper bounds in terms of $\bigcap_{i \in \mathbb{N}} \text{GF } A_i$, because it is more natural. First we present the results for optimal strategies.

Theorem 4. *Let $\mathcal{M} = (S, S_{\square}, S_{\circ}, \longrightarrow, P, r)$ be a universally transient countable MDP with initial state s_0 with a $\bigcap_{i \in \mathbb{N}} \text{GF } A_i$ objective. If there exists an almost surely winning strategy from s_0 , then there also exists an almost surely winning deterministic positional strategy.*

Proof. W.l.o.g. we can assume that \mathcal{M} is finitely branching by Lemma 9. Assume furthermore that there exists an almost surely winning strategy σ' from s_0 in \mathcal{M} . Let $S' \subseteq S$ be the subset of states that are visited under σ' . By restricting \mathcal{M} to S' , we obtain a sub-MDP \mathcal{M}' where all states are almost surely winning for $\bigcap_{i \in \mathbb{N}} \text{GF } A_i$.

By construction of \mathcal{M}' , we have $\forall s \in S' \text{ val}_{\mathcal{M}', \bigcap_{i \in \mathbb{N}} \text{GF } A_i}(s) = 1$. Note that $\text{GF } A_i \subseteq \text{F } A_i$ for all i . Hence we have that $\text{val}_{\mathcal{M}', \text{F } A_i}(s) \geq \text{val}_{\mathcal{M}', \bigcap_{i \in \mathbb{N}} \text{GF } A_i}(s) = 1$ for all $s \in S'$ and all $i \in \mathbb{N}$. Let $d : S \rightarrow \mathbb{N}$ be a distance function where $d(s)$ is the length of the shortest path from s_0 to s . Let $\text{Bubble}_n(s_0) \stackrel{\text{def}}{=} \{s \in S' \mid d(s) \leq n\}$.

We inductively construct an increasing sequence of numbers $0 = n_0 < n_1 < n_2 < \dots$ and a sequence of MDPs \mathcal{M}_i for $i = 0, 1, 2, \dots$ that are derived from \mathcal{M}' by fixing choices in larger and larger finite subspaces $\text{Bubble}_{n_i}(s_0)$. These will satisfy the following properties:

- For all $i \geq 0$, \mathcal{M}_i is universally transient and all states in \mathcal{M}_i are almost surely

winning for $\bigcap_{i \in \mathbb{N}} \text{GF } A_i$.

- For all $i, j \geq 1$ we have the following.

Let $S_i \stackrel{\text{def}}{=} \text{Bubble}_{n_i}(s_0)$, $X_i \stackrel{\text{def}}{=} S_i \setminus S_{i-1}$ and let $A_i^j \stackrel{\text{def}}{=} \{(s_1 \rightarrow s_2) \in A_i \mid s_1, s_2 \in X_j\}$ be the transitions in A_i that happen completely inside the subspace X_j .

In \mathcal{M}_{i+1} , under all strategies, for all $j \leq i$, from any state $s \in S_j$ the probability of seeing a transition in A_{j+1}^{j+1} is $\geq 1/2$. (This property will hold under all strategies, because in \mathcal{M}_{i+1} the relevant choices will be fixed already.) Formally, for all $j \leq i$ we have

$$\forall \tau \forall s \in S_j \mathcal{P}_{\mathcal{M}_{i+1}, s, \tau}(\text{F } A_{j+1}^{j+1}) \geq 1/2 \quad (1)$$

In the base case $i = 0$ we have $\mathcal{M}_0 \stackrel{\text{def}}{=} \mathcal{M}'$, $n_0 \stackrel{\text{def}}{=} 0$ and $S_0 = \{s_0\}$. The first property holds by construction of $\mathcal{M}_0 = \mathcal{M}'$ and the second is vacuously true (since it assumes $i \geq 1$).

Induction step $i \rightarrow i+1$: We define \mathcal{M}_{i+1} inductively as follows.

Consider the MDP \mathcal{M}_i . Since \mathcal{M}_i (like \mathcal{M}) is finitely branching, the set S_i is finite. By induction hypothesis, all states in \mathcal{M}_i are almost surely winning for $\bigcap_{i \in \mathbb{N}} \text{GF } A_i$. Moreover, since \mathcal{M}_i (like \mathcal{M}) is universally transient, under all strategies, the set of runs which stays within a finite set forever is a null set. In particular this holds for the finite set $S_i = \bigcup_{j \leq i} X_j$. Therefore $\text{GF } A_{i+1}$ is equal to $\text{GF}(A_{i+1} \setminus \bigcup_{j \leq i} A_{i+1}^j)$ up to a null set (by universal transience) and we have $\text{GF}(A_{i+1} \setminus \bigcup_{j \leq i} A_{i+1}^j) \subseteq \text{F}(A_{i+1} \setminus \bigcup_{j \leq i} A_{i+1}^j)$. Thus every state in \mathcal{M}_i is also almost surely winning for the reachability objective $\text{F}(A_{i+1} \setminus \bigcup_{j \leq i} A_{i+1}^j)$.

In countable MDPs there exist uniform ε -optimal deterministic positional strategies for reachability [24]. Since all states in \mathcal{M}_i have value 1 for the reachability objective $\text{F}(A_{i+1} \setminus \bigcup_{j \leq i} A_{i+1}^j)$, we can pick a uniform deterministic positional strategy σ_{i+1} that is $1/4$ -optimal from every $s \in S_i$, i.e.,

$$\forall s \in S_i \mathcal{P}_{\mathcal{M}_i, s, \sigma_{i+1}}(\text{F}(A_{i+1} \setminus \bigcup_{j \leq i} A_{i+1}^j)) \geq 1 - \frac{1}{4} = \frac{3}{4}.$$

Since $\text{F} = \bigcup_{k \in \mathbb{N}} \text{F}^{\leq k}$, by continuity of measures from below we have

$$\forall s \in S_i \lim_{k \rightarrow \infty} \mathcal{P}_{\mathcal{M}_i, s, \sigma_{i+1}}(\text{F}^{\leq k}(A_{i+1} \setminus \bigcup_{j \leq i} A_{i+1}^j)) \geq \frac{3}{4}.$$

Thus for all states $s \in S_i$ there is a $k(s)$ s.t. $\mathcal{P}_{\mathcal{M}_i, s, \sigma_{i+1}}(\text{F}^{\leq k(s)}(A_{i+1} \setminus \bigcup_{j \leq i} A_{i+1}^j)) \geq 1/2$.

Since S_i is finite, $k_{i+1} \stackrel{\text{def}}{=} \max\{k(s) \mid s \in S_i\}$ is finite. Hence

$$\forall s \in S_i \mathcal{P}_{\mathcal{M}_i, s, \sigma_{i+1}}(\mathbf{F}^{\leq k_{i+1}}(A_{i+1} \setminus \cup_{j \leq i} A_{i+1}^j)) \geq 1/2.$$

Let $n_{i+1} \stackrel{\text{def}}{=} n_i + k_{i+1}$. All transitions in $A_{i+1} \setminus \cup_{j \leq i} A_{i+1}^j$ that are reachable from S_i in $\leq k_{i+1}$ steps are contained in A_{i+1}^{i+1} by the definitions of n_{i+1} , X_{i+1} and A_{i+1}^{i+1} . Thus

$$\forall s \in S_i \mathcal{P}_{\mathcal{M}_i, s, \sigma_{i+1}}(\mathbf{F} A_{i+1}^{i+1}) \geq 1/2. \quad (2)$$

We obtain \mathcal{M}_{i+1} from \mathcal{M}_i by fixing the (remaining) choices inside $S_{i+1} = \text{Bubble}_{n_{i+1}}(s_0)$ according to σ_{i+1} . From (2) and the definition of \mathcal{M}_{i+1} we obtain (1) for the case of $j = i$. The other cases of (1) where $j < i$ follow from the induction hypothesis.

\mathcal{M}_{i+1} is universally transient, since \mathcal{M}_i is universally transient. Thus only a null set of runs stays in the finite set S_{i+1} forever. Thus, since $\bigcap_{i \in \mathbb{N}} \mathbf{GF} A_i$ is shift invariant, even in \mathcal{M}_{i+1} all states are almost surely winning for $\bigcap_{i \in \mathbb{N}} \mathbf{GF} A_i$. This concludes the induction step.

Let σ^* be the deterministic positional strategy on \mathcal{M}' that is compatible with the MDPs \mathcal{M}_i for all i . I.e. σ^* plays like σ_i on X_i for all i . We'll show that σ^* is almost surely winning for $\bigcap_{i \in \mathbb{N}} \mathbf{GF} A_i$ from s_0 in \mathcal{M}' . To this end, we show that the dual objective $\neg \bigcap_{i \in \mathbb{N}} \mathbf{GF} A_i$ is a nullset under σ^* .

We know that

$$\neg \bigcap_{i \in \mathbb{N}} \mathbf{GF} A_i = \bigcup_{i \in \mathbb{N}} \mathbf{FG} \neg A_i. \quad (3)$$

By the definition of the sets A_i^j we have $\bigcup_{j \geq i} A_j^j \subseteq A_i$ and thus $\neg A_i \subseteq \bigcap_{j \geq i} \neg A_j^j$. Moreover, we cannot reach A_j^j in fewer than j steps from s_0 . Hence, for any $k \in \mathbb{N}$ we have

$$\mathbf{F}^{\leq k} \mathbf{G} \neg A_i \subseteq \mathbf{F}^{\leq k} \mathbf{G} \left(\bigcap_{j \geq i} \neg A_j^j \right) \subseteq \mathbf{G} \left(\bigcap_{j > \max\{i, k\}} \neg A_j^j \right). \quad (4)$$

Since \mathcal{M}' (like \mathcal{M}) is universally transient, only a null set of runs stays in a finite set forever, in particular each of the finite sets S_m for every $m \in \mathbb{N}$. Thus every run from s_0 must eventually reach the set X_m for each $m \in \mathbb{N}$. This holds under every strategy, and thus in particular under the strategy σ^* , i.e.,

$$\mathcal{P}_{\mathcal{M}', s_0, \sigma^*}(\bigcap_{m \in \mathbb{N}} \mathbf{F} X_m) = 1 \quad (5)$$

By the construction of σ^* , for any $i, k \in \mathbb{N}$ we obtain the following

$$\begin{aligned}
& \mathcal{P}_{\mathcal{M}', s_0, \sigma^*}(\mathbf{G}(\bigcap_{j > \max\{i, k\}} \neg A_j^j)) \\
&= \mathcal{P}_{\mathcal{M}', s_0, \sigma^*}(\mathbf{G}(\bigcap_{j > \max\{i, k\}} \neg A_j^j) \cap \bigcap_{m \in \mathbb{N}} \mathbf{F} X_m) \quad \text{by (5)} \\
&\leq \mathcal{P}_{\mathcal{M}', s_0, \sigma^*}(\bigcap_{j > \max\{i, k\}} \mathbf{F}(X_{j-1} \cap \mathbf{G} \neg A_j^j)) \quad \text{set inclusion} \\
&\leq \prod_{j > \max\{i, k\}} \max_{s \in X_{j-1}} \mathcal{P}_{\mathcal{M}', s, \sigma^*}(\mathbf{G} \neg A_j^j) \quad X_{j-1} \text{ finite} \quad (6) \\
&= \prod_{j > \max\{i, k\}} \max_{s \in X_{j-1}} \mathcal{P}_{\mathcal{M}_j, s, \sigma_j}(\neg \mathbf{F} A_j^j) \quad \text{def. } \sigma^*, \mathbf{G} \\
&\leq \prod_{j > \max\{i, k\}} 1/2 \quad \text{by (2)} \\
&= 0.
\end{aligned}$$

Hence for all $i, k \in \mathbb{N}$,

$$\begin{aligned}
& \mathcal{P}_{\mathcal{M}', s_0, \sigma^*}(\mathbf{F}\mathbf{G} \neg A_i) \\
&= \lim_{k \rightarrow \infty} \mathcal{P}_{\mathcal{M}', s_0, \sigma^*}(\mathbf{F}^{\leq k} \mathbf{G} \neg A_i) \quad \text{cont. measures} \\
&\leq \lim_{k \rightarrow \infty} \mathcal{P}_{\mathcal{M}', s_0, \sigma^*}(\mathbf{G}(\bigcap_{j > \max\{i, k\}} \neg A_j^j)) \quad \text{by (4)} \\
&= 0 \quad \text{by (6)}
\end{aligned} \tag{7}$$

Finally, we show that σ^* is almost surely winning for $\bigcap_{i \in \mathbb{N}} \mathbf{G}\mathbf{F} A_i$ from s_0 in \mathcal{M} .

$$\begin{aligned}
& \mathcal{P}_{\mathcal{M}, s_0, \sigma^*}(\bigcap_{i \in \mathbb{N}} \mathbf{G}\mathbf{F} A_i) \\
&= \mathcal{P}_{\mathcal{M}', s_0, \sigma^*}(\bigcap_{i \in \mathbb{N}} \mathbf{G}\mathbf{F} A_i) \quad \text{def. of } \mathcal{M}' \\
&= 1 - \mathcal{P}_{\mathcal{M}', s_0, \sigma^*}(\neg \bigcap_{i \in \mathbb{N}} \mathbf{G}\mathbf{F} A_i) \quad \text{duality} \\
&\geq 1 - \sum_{i \in \mathbb{N}} \mathcal{P}_{\mathcal{M}', s_0, \sigma^*}(\mathbf{F}\mathbf{G} \neg A_i) \quad \text{(3) and union bound} \\
&= 1 \quad \text{by (7)}
\end{aligned}$$

□

Corollary 1. *Consider a countable MDP \mathcal{M} with initial state s_0 and a $\bigcap_{i \in \mathbb{N}} \mathbf{G}\mathbf{F} A_i$ objective.*

1. *If \mathcal{M} is universally transient then there exists a deterministic positional strategy that is optimal from every state that has an optimal strategy, and*
2. *Otherwise, if there exists an optimal strategy from s_0 , then there also exists an optimal deterministic Markov strategy.*

Proof. Towards item 1., since \mathcal{M} is universally transient and $\bigcap_{i \in \mathbb{N}} \text{GF } A_i$ is shift invariant, it follows from Theorem 4 and Theorem 1 that there exists a single deterministic positional strategy that is optimal from every state that has an optimal strategy.

Towards item 2., consider the MDP $S(\mathcal{M})$ that is derived from \mathcal{M} by encoding the step counter from s_0 into the states; cf. Definition 1. $S(\mathcal{M})$ is trivially universally transient. We assume that there exists an optimal strategy from s_0 . Then we can use Theorem 4 on $S(\mathcal{M})$ and Lemma 1 to obtain an optimal deterministic Markov strategy from s_0 in \mathcal{M} . \square

Deterministic Markov strategies as in Corollary 1 are not the only type of ‘simple’ optimal strategies for $\bigcap_{i \in \mathbb{N}} \text{GF } A_i$. Alternatively, optimal strategies (if they exist) can be chosen as positional randomized, i.e., one can trade the step counter for randomization. We start by considering the special case of almost surely winning strategies.

Theorem 5. *Let $\mathcal{M} = (S, S_{\square}, S_{\circ}, \longrightarrow, P, r)$ be a countable MDP with initial state s_0 and a $\bigcap_{i \in \mathbb{N}} \text{GF } A_i$ objective. If there exists an almost surely winning strategy from s_0 , then there also exists an almost surely winning randomized positional strategy.*

Proof. W.l.o.g. we can assume that \mathcal{M} is finitely branching by Lemma 9. Also w.l.o.g. we can assume that every state in \mathcal{M} has an almost surely winning strategy, because otherwise it would suffice to consider a sub-MDP as follows: Consider an almost surely winning strategy σ' from s_0 in \mathcal{M} . Let $S' \subseteq S$ be the subset of states that are visited under σ' . By restricting \mathcal{M} to S' , we obtain a sub-MDP \mathcal{M}' where all states are almost surely winning for $\bigcap_{i \in \mathbb{N}} \text{GF } A_i$. It now suffices to construct an almost surely winning randomized positional strategy from s_0 in \mathcal{M}' , since the same strategy is also almost surely winning from s_0 in \mathcal{M} . Thus, in the rest of the proof we can assume that every state in \mathcal{M} has an almost surely winning strategy.

Let $d(s_1, s_2)$ be the length of the shortest path from state s_1 to state s_2 in \mathcal{M} . For every finite set of states $\hat{S} \subseteq S$ let $\text{Bubble}_n(\hat{S}) \stackrel{\text{def}}{=} \{s' \mid \exists s \in \hat{S}. d(s, s') \leq n\}$. Since \mathcal{M} is finitely branching, $\text{Bubble}_n(\hat{S})$ is finite for every finite set \hat{S} and $n \in \mathbb{N}$.

All states in \mathcal{M} are almost surely winning for $\bigcap_{i \in \mathbb{N}} \text{GF } A_i$ and $\bigcap_{i \in \mathbb{N}} \text{GF } A_i \subseteq \text{F } A_j$

for every $j \geq 1$, thus it follows that all states in \mathcal{M} are almost surely winning for $\text{F } A_j$. By [17], for every $j \geq 1$, there exists a *uniform* deterministic positional strategy τ^j (that thus does not depend on the start state) that is a.s. winning for the reachability objective $\text{F } A_j$ in \mathcal{M} , i.e.,

$$\forall s \mathcal{P}_{\mathcal{M}, s, \tau^j}(\text{F } A_j) = 1 \quad (8)$$

We inductively construct an increasing (w.r.t. set inclusion) sequence of sets of states S_i with $i = -1, 0, 1, 2, \dots$ such that $S_{-1} \stackrel{\text{def}}{=} \emptyset$, $S_0 \stackrel{\text{def}}{=} \{s_0\}$, $S_{i+1} \stackrel{\text{def}}{=} \text{Bubble}_{n_{i+1}}(S_i)$ (for $i \geq 0$ and suitably chosen numbers n_i), randomized positional strategies σ_i and MDPs $\mathcal{M}_0 \stackrel{\text{def}}{=} \mathcal{M}$ and \mathcal{M}_{i+1} derived from \mathcal{M}_i by fixing the choices according to σ_{i+1} inside S_{i+1} such that the following two properties hold:

$$\forall i \forall s \exists \sigma' \mathcal{P}_{\mathcal{M}_i, s, \sigma'}\left(\bigcap_{i \in \mathbb{N}} \text{GF } A_i\right) = 1 \quad (9)$$

i.e., all states in \mathcal{M}_i are still a.s. winning, and

$$\forall s \in S_{i-1} \mathcal{P}_{\mathcal{M}_{i-1}, s, \sigma_i}(\text{F}^{\leq n_i} A_i) \geq 1/4 \quad (10)$$

For the base case of $i = 0$ we have $S_0 = \{s_0\}$ and $\mathcal{M}_0 = \mathcal{M}$. Equation (9) holds by our assumption on \mathcal{M} and Equation (10) for $i = 0$ is vacuously true, since $S_{-1} = \emptyset$.

For the inductive step $i \rightarrow i+1$ consider \mathcal{M}_i and let $s \in S$. By the induction hypothesis and (9) there is a strategy σ' such that $\mathcal{P}_{\mathcal{M}_i, s, \sigma'}(\text{F } A_{i+1}) \geq \mathcal{P}_{\mathcal{M}_i, s, \sigma'}(\bigcap_{i \in \mathbb{N}} \text{GF } A_i) = 1$. I.e., all states in \mathcal{M}_i are a.s. winning for the reachability objective $\text{F } A_{i+1}$.

By [17] there exists a *uniform* deterministic positional strategy σ_i^{i+1} (that thus does not depend on the start state) that is a.s. winning for the reachability objective $\text{F } A_{i+1}$ in \mathcal{M}_i , i.e., $\forall s \in S \mathcal{P}_{\mathcal{M}_i, s, \sigma_i^{i+1}}(\text{F } A_{i+1}) = 1$. By continuity of measures, we have $\forall s \in S$

$$1 = \mathcal{P}_{\mathcal{M}_i, s, \sigma_i^{i+1}}(\text{F } A_{i+1}) = \mathcal{P}_{\mathcal{M}_i, s, \sigma_i^{i+1}}\left(\bigcup_{m \geq 0} \text{F}^{\leq m} A_{i+1}\right) = \lim_{m \rightarrow \infty} \mathcal{P}_{\mathcal{M}_i, s, \sigma_i^{i+1}}(\text{F}^{\leq m} A_{i+1}).$$

Thus we can pick a number $m(s) \in \mathbb{N}$ such that

$$\mathcal{P}_{\mathcal{M}_i, s, \sigma_i^{i+1}}(\text{F}^{\leq m(s)} A_{i+1}) \geq 1/2.$$

(Note that $m(s)$ does depend on the start state s , unlike the strategy σ_i^{i+1} .)

Since S_i is finite, we can pick a finite number $n_{i+1} \stackrel{\text{def}}{=} \max\{m(s) \mid s \in S_i\} \in \mathbb{N}$ and obtain

$$\forall s \in S_i \mathcal{P}_{\mathcal{M}_i, s, \sigma_i^{i+1}}(\text{F}^{\leq n_{i+1}} A_{i+1}) \geq 1/2. \quad (11)$$

We let $S_{i+1} \stackrel{\text{def}}{=} \text{Bubble}_{n_{i+1}}(S_i)$, and thus the above is attained inside S_{i+1} .

We define the randomized positional strategy σ_{i+1} on the set of states S_{i+1} of \mathcal{M}_i as follows. (Note that in \mathcal{M}_i the choices in states S_i are already fixed.) At every state s in $S_{i+1} \setminus S_i$ play like σ_i^{i+1} with some large probability p_{i+1} (to be determined) and otherwise, play like the deterministic positional strategy τ^j (from (8) above) with a small probability $(1-p_{i+1}) \cdot 2^{-j}$ for all $j \geq 1$. Since we have $p_{i+1} + (1-p_{i+1}) \sum_{j \geq 1} 2^{-j} = 1$, this is a distribution and the strategy σ_{i+1} is well defined.

Intuitively, σ_{i+1} focuses on the objective $\text{F } A_{i+1}$ with a large probability p_{i+1} , but keeps every other reachability objective $\text{F } A_j$ in sight with a nonzero probability. Note that the attainment of σ_{i+1} with respect to $\text{F}^{\leq n_{i+1}} A_{i+1}$ is a continuous function in p_{i+1} , which converges to a value $\geq 1/2$ for every start state $s \in S_i$ by (11). I.e.,

$$\forall s \in S_i \quad \lim_{p_{i+1} \rightarrow 1} \mathcal{P}_{\mathcal{M}_i, s, \sigma_{i+1}}(\text{F}^{\leq n_{i+1}} A_{i+1}) \geq 1/2.$$

From the finiteness of S_i it follows that there exists a probability $p_{i+1} < 1$ such that

$$\forall s \in S_i \quad \mathcal{P}_{\mathcal{M}_i, s, \sigma_{i+1}}(\text{F}^{\leq n_{i+1}} A_{i+1}) \geq 1/4$$

and thus we obtain (10) for $i+1$.

We obtain the MDP \mathcal{M}_{i+1} from \mathcal{M}_i by fixing all choices in $S_{i+1} \setminus S_i$ according to σ_{i+1} .

Now we show that (9) holds for \mathcal{M}_{i+1} . We construct a strategy σ' that is a.s. winning for $\bigcap_{i \in \mathbb{N}} \text{GF } A_i$ in \mathcal{M}_{i+1} from every start state. Inside S_{i+1} all choices are already fixed in \mathcal{M}_{i+1} according to strategies σ_k for $1 \leq k \leq i+1$. By definition of these σ_k , for all $j \geq 1$ at each state $s \in S_{i+1}$ the strategy τ^j is played with some positive probability $p(s, j) > 0$. Then $p^j \stackrel{\text{def}}{=} \min_{s \in S_{i+1}} p(s, j) > 0$, since S_{i+1} is finite. The strategy σ' plays in phases $j = 1, 2, 3, \dots$. In each phase j it plays like τ^j everywhere outside of S_{i+1} until A_j is reached, and then proceeds to phase $j+1$, etc. It suffices to show that in every phase j we reach A_j eventually almost surely, i.e., we'll show that

$$\forall s \quad \mathcal{P}_{\mathcal{M}_{i+1}, s, \tau^j}(\text{F } A_j) = 1 \tag{12}$$

We partition the complement of the objective $\text{F } A_j$ into two parts and show that each is a nullset. We partition $\neg \text{F } A_j$ into those runs that visit S_{i+1} infinitely often and those that don't.

$$\neg \text{F } A_j = \text{G} \neg A_j = (\text{G} \neg A_j \cap \text{GF } S_{i+1}) \uplus (\text{G} \neg A_j \cap \text{FG} \neg S_{i+1}) \tag{13}$$

For the first part of the partition, consider the strategy τ^j on \mathcal{M} . By (8) and continuity of measures, for every state s we have

$$1 = \mathcal{P}_{\mathcal{M},s,\tau^j}(\mathbf{F}A_j) = \lim_{m \rightarrow \infty} \mathcal{P}_{\mathcal{M},s,\tau^j}(\mathbf{F}^{\leq m}A_j).$$

Thus for every state s we can pick a number $m(s)$ such that $\mathcal{P}_{\mathcal{M},s,\tau^j}(\mathbf{F}^{\leq m(s)}A_j) \geq 1/2$. Let $m \stackrel{\text{def}}{=} \max_{s \in S_{i+1}} m(s)$. The number m is finite, since S_{i+1} is finite. Recall that in \mathcal{M}_{i+1} the fixed strategy inside the finite set S_{i+1} plays τ^j with some probability $\geq p^j > 0$ at each state in S_{i+1} . Outside of S_{i+1} we play τ^j with probability 1 (and thus also with probability $\geq p^j$). It follows that, for every $s' \in S_{i+1}$, we have $\mathcal{P}_{\mathcal{M}_{i+1},s',\tau^j}(\mathbf{F}^{\leq m}A_j) \geq (p^j)^m \cdot 1/2 > 0$. Therefore

$$\mathcal{P}_{\mathcal{M}_{i+1},s,\tau^j}(\mathbf{G}\neg A_j \cap \mathbf{GF}S_{i+1}) \leq (1 - (p^j)^m \cdot 1/2)^\infty = 0 \quad (14)$$

For the second part of the partition, consider an arbitrary state s' . We have

$$\mathcal{P}_{\mathcal{M}_{i+1},s',\tau^j}(\mathbf{G}\neg A_j \cap \mathbf{G}\neg S_{i+1}) = \mathcal{P}_{\mathcal{M},s',\tau^j}(\mathbf{G}\neg A_j \cap \mathbf{G}\neg S_{i+1}) \leq \mathcal{P}_{\mathcal{M},s',\tau^j}(\mathbf{G}\neg A_j) = 0 \quad (15)$$

The first equality above holds because \mathcal{M} and \mathcal{M}_{i+1} coincide outside S_{i+1} . The last equality is due to (8). Thus for all $s \in S$

$$\begin{aligned} \mathcal{P}_{\mathcal{M}_{i+1},s,\tau^j}(\mathbf{G}\neg A_j \cap \mathbf{FG}\neg S_{i+1}) &\leq \mathcal{P}_{\mathcal{M}_{i+1},s,\tau^j}(\mathbf{F}(\mathbf{G}\neg A_j \cap \mathbf{G}\neg S_{i+1})) && \text{set inclusion} \\ &\leq \sup_{s'} \mathcal{P}_{\mathcal{M}_{i+1},s',\tau^j}(\mathbf{G}\neg A_j \cap \mathbf{G}\neg S_{i+1}) && \text{def. of F} \\ &= 0 && \text{by (15)} \end{aligned} \quad (16)$$

By combining (13), (14) and (16) we obtain (12) and thus (9). This concludes the inductive construction.

Now we construct the randomized positional strategy σ that is almost surely winning for $\bigcap_{i \in \mathbb{N}} \mathbf{GF}A_i$ from s_0 in \mathcal{M} . The strategy σ plays like σ_{i+1} at all states in $S_{i+1} \setminus S_i$ for all i , i.e., it corresponds exactly to the choices that are fixed in the derived MDPs \mathcal{M}_i . We consider the dual objective $\neg \bigcap_{i \in \mathbb{N}} \mathbf{GF}A_i$ and show that it is a nullset under σ . First we note that

$$\neg \bigcap_{i \in \mathbb{N}} \mathbf{GF}A_i = \bigcup_{i \in \mathbb{N}} \mathbf{FG}\neg A_i. \quad (17)$$

We show that each part of this union $\mathbf{FG}\neg A_i$ is a nullset under σ . To this end, we partition $\mathbf{FG}\neg A_i$ into two parts:

$$\mathbf{FG}\neg A_i = ((\mathbf{FG}\neg A_i) \cap \mathbf{Transience}) \uplus ((\mathbf{FG}\neg A_i) \cap \neg \mathbf{Transience}) \quad (18)$$

where $\text{Transience} \stackrel{\text{def}}{=} \bigcap_{s \in S} \text{FG} \neg s$.

For the first part of the partition of (18), we start by considering the slightly different objective $(\text{G} \neg A_i) \cap \text{Transience}$. Let s'' be an arbitrary state in \mathcal{M} that is reachable from s_0 . Thus there exists some minimal index $k(s'')$ such that $s'' \in S_{k(s'')}$. Now consider only the set of runs $\text{Runs}_{\mathcal{M}} s''$ that start from s'' . Transient runs eventually leave every finite set forever. Thus $\text{Runs}_{\mathcal{M}} s'' \cap (\text{G} \neg A_i) \cap \text{Transience} \subseteq \text{Runs}_{\mathcal{M}} s'' \cap (\text{G} \neg A_i) \cap \bigcap_{j \geq \max(i, k(s''))} \text{F}(S_j \setminus S_{j-1})$. On the other hand, by (10) and the definition of σ we have $\forall s \in S_j$ $\mathcal{P}_{\mathcal{M}, s, \sigma}(\text{F}^{\leq n_{j+1}} A_{j+1}) \geq 1/4$. I.e., A_{j+1} is visited with probability $\geq 1/4$ inside S_{j+1} . For the infinitely many $j \geq \max(i, k(s''))$ we have the inclusion $A_i \supseteq A_j$ and thus for every state s'' we have

$$\begin{aligned} & \mathcal{P}_{\mathcal{M}, s'', \sigma}((\text{G} \neg A_i) \cap \text{Transience}) \\ & \leq \mathcal{P}_{\mathcal{M}, s'', \sigma}((\text{G} \neg A_i) \cap \bigcap_{j \geq \max(i, k(s''))} \text{F}(S_j \setminus S_{j-1})) \leq (1 - 1/4)^\infty = 0 \end{aligned}$$

Finally,

$$\mathcal{P}_{\mathcal{M}, s_0, \sigma}((\text{FG} \neg A_i) \cap \text{Transience}) \leq \sup_{s''} \mathcal{P}_{\mathcal{M}, s'', \sigma}((\text{G} \neg A_i) \cap \text{Transience}) = 0. \quad (19)$$

For the second part of the partition of (18), for some arbitrary state s , consider the event $(\text{FG} \neg A_i) \cap (\text{GF } s)$. Continuity of measures and (8) yield $1 = \mathcal{P}_{\mathcal{M}, s, \tau^i}(\text{F } A_i) = \lim_{m \rightarrow \infty} \mathcal{P}_{\mathcal{M}, s, \tau^i}(\text{F}^{\leq m} A_i)$. Thus we can pick a number $m(s)$ such that $\mathcal{P}_{\mathcal{M}, s, \tau^i}(\text{F}^{\leq m(s)} A_i) \geq 1/2$. Recall that σ plays τ^i with some probability $p^i(s') > 0$ at each state $s' \in \text{Bubble}_{m(s)}(\{s\})$ that is reachable from s in $\leq m(s)$ steps. Since \mathcal{M} is finitely branching, $\text{Bubble}_{m(s)}(\{s\})$ is finite and thus $p^i \stackrel{\text{def}}{=} \min_{s' \in \text{Bubble}_{m(s)}(\{s\})} p^i(s') > 0$. It follows that

$$q_i \stackrel{\text{def}}{=} \mathcal{P}_{\mathcal{M}, s, \sigma}(\text{F}^{\leq m(s)} A_i) \geq (p^i)^{m(s)} \cdot 1/2 > 0$$

i.e., after every visit to s we have a positive probability q_i of reaching A_i . Therefore for all states s'' we have $\mathcal{P}_{\mathcal{M}, s'', \sigma}((\text{G} \neg A_i) \cap (\text{GF } s)) \leq (1 - q_i)^\infty = 0$. Thus,

$$\mathcal{P}_{\mathcal{M}, s_0, \sigma}((\text{FG} \neg A_i) \cap (\text{GF } s)) \leq \sup_{s''} \mathcal{P}_{\mathcal{M}, s'', \sigma}((\text{G} \neg A_i) \cap (\text{GF } s)) = 0. \quad (20)$$

From the definition of Transience , a union bound and (20) we obtain

$$\begin{aligned} & \mathcal{P}_{\mathcal{M}, s_0, \sigma}((\text{FG} \neg A_i) \cap \neg \text{Transience}) = \mathcal{P}_{\mathcal{M}, s_0, \sigma}((\text{FG} \neg A_i) \cap \bigcup_{s \in S} \text{GF } s) \\ & \leq \sum_{s \in S} \mathcal{P}_{\mathcal{M}, s_0, \sigma}((\text{FG} \neg A_i) \cap \text{GF } s) = 0 \end{aligned} \quad (21)$$

Finally, we show that σ wins almost surely.

$$\begin{aligned}
& \mathcal{P}_{\mathcal{M},s_0,\sigma}(\bigcap_{i \in \mathbb{N}} \text{GF } A_i) \geq 1 - \mathcal{P}_{\mathcal{M},s_0,\sigma}(\neg \bigcap_{i \in \mathbb{N}} \text{GF } A_i) && \text{duality} \\
& = 1 - \mathcal{P}_{\mathcal{M},s_0,\sigma}(\bigcup_i \text{FG } \neg A_i) && (17) \\
& \geq 1 - \sum_i \mathcal{P}_{\mathcal{M},s_0,\sigma}(\text{FG } \neg A_i) && \text{union bound} \\
& = 1 - \sum_i \mathcal{P}_{\mathcal{M},s_0,\sigma}((\text{FG } \neg A_i) \cap \text{Transience}) && \text{case split} \\
& \quad - \sum_i \mathcal{P}_{\mathcal{M},s_0,\sigma}((\text{FG } \neg A_i) \cap \neg \text{Transience}) \\
& = 1 && (19), (21)
\end{aligned}$$

□

Corollary 2. *Consider a countable MDP \mathcal{M} and a $\bigcap_{i \in \mathbb{N}} \text{GF } A_i$ objective. There exists a single randomized positional strategy that is optimal from every state that has an optimal strategy.*

Proof. Since the objective $\bigcap_{i \in \mathbb{N}} \text{GF } A_i$ is shift invariant in every MDP, the result follows from Theorem 5 and Theorem 1. □

4.1.1. ε -optimal strategy complexity

First we show a general result about a combined objective that includes **Transience**. It generalizes the result on a combined **Transience** \cap **GFA** objective of [18, Lemma 4].

Theorem 6. *Consider a countable MDP \mathcal{M} with initial state s_0 and the objective $\varphi \stackrel{\text{def}}{=} \text{Transience} \cap \bigcap_{i \in \mathbb{N}} \text{GF } A_i$. For every $\varepsilon > 0$ there exists an ε -optimal deterministic 1-bit strategy from s_0 .*

Proof. By Lemma 9, w.l.o.g. we can assume that \mathcal{M} is finitely branching. Since \mathcal{M} is finitely branching, we can define $d : S \rightarrow \mathbb{N}$ such that $d(s) \stackrel{\text{def}}{=} \min\{|w| : w \text{ is a path from } s_0 \text{ to } s\}$. Let $\text{Bubble}_n(s_0) \stackrel{\text{def}}{=} \{t \in \rightarrow_{\mathcal{M}} \mid t = (s \rightarrow_{\mathcal{M}} s'), d(s') \leq n\}$. Since \mathcal{M} is finitely branching, $\text{Bubble}_n(s_0)$ is finite for every $n \in \mathbb{N}$.

Let $A_i^n \stackrel{\text{def}}{=} A_i \cap \text{Bubble}_n(s_0)$ and let $A_i^{>n} \stackrel{\text{def}}{=} A_i \setminus A_i^n$. (In particular, $A_i^{>0} = A_i$.)

Transient runs eventually leave every finite set forever, and in particular each of the finite sets A_x^n for every $x, n \in \mathbb{N}$. Therefore

$$\varphi = \text{Transience} \cap \bigcap_{i \in \mathbb{N}} \text{GF } A_i = \text{Transience} \cap \bigcap_{i \in \mathbb{N}} \text{GF } A_i \cap \text{F}(A_x^{>n}) \quad (22)$$

Let τ be a general ε -optimal strategy for φ from s_0 , i.e.,

$$\mathcal{P}_{\mathcal{M},s_0,\tau}(\varphi) \geq \text{val}_{\mathcal{M},\varphi}(s_0) - \varepsilon. \quad (23)$$

We now show that for a suitably chosen increasing sequence of natural numbers $0 = n_0 < n_1 < n_2 \dots$ we have

$$\mathcal{P}_{\mathcal{M},s_0,\tau} \left(\left(\bigcap_{j=1}^{\infty} \left(\mathbb{F}(A_j^{>n_{j-1}}) \cap \mathbb{F}(A_j^{n_j}) \right) \right) \cap \varphi \right) \geq \mathbf{val}_{\mathcal{M},\varphi}(s_0) - 2\varepsilon.$$

To this end, we prove by induction on i that the following property holds for all $i \geq 0$ and $\varepsilon_j \stackrel{\text{def}}{=} \varepsilon \cdot 2^{-j}$.

Induction hypothesis:

$$\mathcal{P}_{\mathcal{M},s_0,\tau} \left(\left(\bigcap_{j=1}^i \left(\mathbb{F}(A_j^{>n_{j-1}}) \cap \mathbb{F}(A_j^{n_j}) \right) \right) \cap \varphi \right) \geq \mathbf{val}_{\mathcal{M},\varphi}(s_0) - \varepsilon - \sum_{j=1}^i \varepsilon_j. \quad (24)$$

Base case: For the base case of $i = 0$, the property follows directly from (23). (Empty index sets for intersection and sum.)

Induction step from i to $i + 1$: By the induction hypothesis we have

$$\mathcal{P}_{\mathcal{M},s_0,\tau} \left(\left(\bigcap_{j=1}^i \left(\mathbb{F}(A_j^{>n_{j-1}}) \cap \mathbb{F}(A_j^{n_j}) \right) \right) \cap \varphi \right) \geq \mathbf{val}_{\mathcal{M},\varphi}(s_0) - \varepsilon - \sum_{j=1}^i \varepsilon_j.$$

Since, by (22), $\varphi = \varphi \cap \mathbb{F}(A_{i+1}^{>n_i})$, we obtain that

$$\mathcal{P}_{\mathcal{M},s_0,\tau} \left(\left(\bigcap_{j=1}^i \left(\mathbb{F}(A_j^{>n_{j-1}}) \cap \mathbb{F}(A_j^{n_j}) \right) \right) \cap \varphi \cap \mathbb{F}(A_{i+1}^{>n_i}) \right) \geq \mathbf{val}_{\mathcal{M},\varphi}(s_0) - \varepsilon - \sum_{j=1}^i \varepsilon_j.$$

We have $\mathbb{F}(A_{i+1}^{>n_i}) = \bigcup_{k \in \mathbb{N}} \mathbb{F}^{\leq k}(A_{i+1}^{>n_i}) = \bigcup_{k > n_i} \mathbb{F}^{\leq k}(A_{i+1}^{>n_i})$. Hence, by continuity of measures,

$$\begin{aligned} \lim_{n_i < k \rightarrow \infty} \mathcal{P}_{\mathcal{M},s_0,\tau} \left(\left(\bigcap_{j=1}^i \left(\mathbb{F}(A_j^{>n_{j-1}}) \cap \mathbb{F}(A_j^{n_j}) \right) \right) \cap \varphi \cap \mathbb{F}^{\leq k}(A_{i+1}^{>n_i}) \right) \\ \geq \mathbf{val}_{\mathcal{M},\varphi}(s_0) - \varepsilon - \sum_{j=1}^i \varepsilon_j. \end{aligned}$$

So there exists an $n_{i+1} > n_i$ such that

$$\begin{aligned} \mathcal{P}_{\mathcal{M},s_0,\tau} \left(\left(\bigcap_{j=1}^i \left(\mathbb{F}(A_j^{>n_{j-1}}) \cap \mathbb{F}(A_j^{n_j}) \right) \right) \cap \varphi \cap \mathbb{F}^{\leq n_{i+1}}(A_{i+1}^{>n_i}) \right) \\ \geq \mathbf{val}_{\mathcal{M}, \bigcap_{i \in \mathbb{N}} \text{GF } A_i}(s_0) - \varepsilon - \left(\sum_{j=1}^i \varepsilon_j \right) - \varepsilon_{i+1} \end{aligned}$$

I.e., we get

$$\mathcal{P}_{\mathcal{M},s_0,\tau} \left(\left(\bigcap_{j=1}^{i+1} \left(\mathbf{F}(A_j^{>n_{j-1}}) \cap \mathbf{F}(A_j^{n_j}) \right) \right) \cap \varphi \right) \geq \mathbf{val}_{\mathcal{M},\varphi}(s_0) - \varepsilon - \sum_{j=1}^{i+1} \varepsilon_j$$

which completes the induction step.

By applying continuity of measures to (24), we obtain the desired result, i.e.,

$$\begin{aligned} & \mathcal{P}_{\mathcal{M},s_0,\tau} \left(\left(\bigcap_{j=1}^{\infty} \left(\mathbf{F}(A_j^{>n_{j-1}}) \cap \mathbf{F}(A_j^{n_j}) \right) \right) \cap \varphi \right) \\ & \geq \mathbf{val}_{\mathcal{M},\varphi}(s_0) - \varepsilon - \sum_{j=1}^{\infty} \varepsilon_j \\ & = \mathbf{val}_{\mathcal{M},\varphi}(s_0) - 2\varepsilon. \end{aligned} \tag{25}$$

Let $\mathbf{Good}_i \stackrel{\text{def}}{=} A_i^{n_i}$ be those transitions inside $\text{Bubble}_{n_i}(s_0)$ which are also in A_i . Let $\mathbf{Good} \stackrel{\text{def}}{=} \bigcup_{i \in \mathbb{N}} \mathbf{Good}_i$. Due to the inclusions

$$\left(\bigcap_{j=1}^{\infty} \mathbf{F}(A_j^{>n_{j-1}}) \cap \mathbf{F}(A_j^{n_j}) \right) \cap \varphi \subseteq \mathbf{GF} \mathbf{Good} \cap \varphi \subseteq \mathbf{Transience} \cap \mathbf{GF} \mathbf{Good},$$

it follows immediately from (25) that

$$\mathcal{P}_{\mathcal{M},s_0,\tau}(\mathbf{Transience} \cap \mathbf{GF} \mathbf{Good}) \geq \mathbf{val}_{\mathcal{M},\varphi}(s_0) - 2\varepsilon. \tag{26}$$

and thus

$$\mathbf{val}_{\mathcal{M},\mathbf{Transience} \cap \mathbf{GF} \mathbf{Good}}(s_0) \geq \mathcal{P}_{\mathcal{M},s_0,\tau}(\mathbf{Transience} \cap \mathbf{GF} \mathbf{Good}) \geq \mathbf{val}_{\mathcal{M},\varphi}(s_0) - 2\varepsilon. \tag{27}$$

Claim 1. $\mathbf{Transience} \cap \mathbf{GF} \mathbf{Good} \subseteq \mathbf{Transience} \cap \bigcap_{i \in \mathbb{N}} \mathbf{GF} A_i$.

Proof. Consider a run ρ that satisfies $\mathbf{Transience} \cap \mathbf{GF} \mathbf{Good}$. In particular, ρ must visit \mathbf{Good} infinitely often. However, $\mathbf{Good} = \bigcup_{i \in \mathbb{N}} A_i^{n_i}$ where each set $A_i^{n_i}$ is finite. Since ρ must also satisfy $\mathbf{Transience}$, it can visit each of these finite sets $A_i^{n_i}$ only finitely often. Therefore, ρ must visit sets $A_i^{n_i}$ for arbitrarily large numbers i . That is, ρ satisfies $\bigcap_{i \in \mathbb{N}} \bigcup_{j \geq i} \mathbf{F} A_j^{n_j}$ and thus also $\bigcap_{i \in \mathbb{N}} \bigcup_{j \geq i} \mathbf{F} A_j$. Since the sets $\{A_i\}_{i \in \mathbb{N}}$ are a decreasing chain, each visit to A_j with $j \geq i$ is also a visit to A_i . Hence ρ also satisfies $\bigcap_{i \in \mathbb{N}} \mathbf{GF} A_i$. \square

By [18, Lemma 4], there exists an ε -optimal deterministic 1-bit strategy σ^* for $\text{Transience} \cap \text{GF Good}$ in \mathcal{M} .

$$\begin{aligned}
 & \mathcal{P}_{\mathcal{M}, s_0, \sigma^*}(\varphi) \\
 &= \mathcal{P}_{\mathcal{M}, s_0, \sigma^*}(\text{Transience} \cap \bigcap_{i \in \mathbb{N}} \text{GF } A_i) && \text{by def. of } \varphi \\
 &\geq \mathcal{P}_{\mathcal{M}, s_0, \sigma^*}(\text{Transience} \cap \text{GF Good}) && \text{Claim 1} \\
 &\geq \text{val}_{\mathcal{M}, \text{Transience} \cap \text{GF Good}}(s_0) - \varepsilon && \sigma^* \text{ is } \varepsilon\text{-opt.} \\
 &\geq \text{val}_{\mathcal{M}, \varphi}(s_0) - 3\varepsilon && \text{by (27)}
 \end{aligned}$$

Since $\varepsilon > 0$ can be made arbitrarily small, the result follows. \square

Corollary 3. *Consider a countable MDP \mathcal{M} with initial state s_0 and a $\bigcap_{i \in \mathbb{N}} \text{GF } A_i$ objective.*

1. *If \mathcal{M} is universally transient, then there exists a deterministic 1-bit strategy that is ε -optimal from s_0 .*
2. *Otherwise, there exists a $\text{Det}(\text{SC}+1\text{-bit})$ ε -optimal strategy from s_0 .*

Proof. Towards item 1., if \mathcal{M} is universally transient then, under every strategy σ , we have $\mathcal{P}_{\mathcal{M}, s_0, \sigma}(\bigcap_{i \in \mathbb{N}} \text{GF } A_i) = \mathcal{P}_{\mathcal{M}, s_0, \sigma}(\text{Transience} \cap \bigcap_{i \in \mathbb{N}} \text{GF } A_i)$ and the result follows directly from Theorem 6.

Towards item 2., consider the MDP $S(\mathcal{M})$ that is derived from \mathcal{M} by encoding the step counter from s_0 into the states; cf. Definition 1. So $S(\mathcal{M})$ is trivially universally transient. Then we can use item 1. on $S(\mathcal{M})$ to obtain a deterministic 1-bit strategy on $S(\mathcal{M})$. Finally, Lemma 1 yields an ε -optimal $\text{Det}(\text{SC}+1\text{-bit})$ strategy from s_0 in \mathcal{M} . \square

4.2. Lower Bounds

We present the lower bounds on the strategy complexity in terms of the objective $\limsup_{PP}(\geq 0)$, because it is much more intuitive to think of counterexamples with rewards rather than thinking about which transitions are labeled as belonging to which set A_i . The MDPs in this section all have transition based rewards.

We begin by presenting the results for optimal strategies.

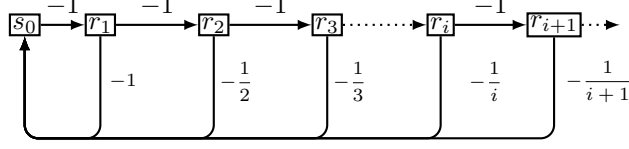

FIGURE 3: $\text{Det}(F)$ strategies are not enough for almost sure $\limsup_{PP}(\geq 0)$ in finitely branching MDPs. Note that this is very similar to [30, Example 1].

Theorem 7. *There exists a finitely branching countable MDP \mathcal{M} with rational rewards as in Figure 3 with initial state s_0 such that*

1. $\exists \hat{\sigma} \mathcal{P}_{\mathcal{M}, s_0, \hat{\sigma}}(\limsup_{PP}(\geq 0)) = 1$, i.e., the state s_0 is almost surely winning for $\limsup_{PP}(\geq 0)$.
2. For every $\text{Det}(F)$ strategy σ we have $\mathcal{P}_{\mathcal{M}, s_0, \sigma}(\limsup_{PP}(\geq 0)) = 0$.

So almost surely winning strategies, when they exist, cannot be chosen $\text{Det}(F)$.

Proof. Towards Item 1, let $\hat{\sigma}$ be the deterministic strategy that turns off the ladder (i.e., goes back to s_0) at state r_i upon visiting it for the first time and then never again thereafter. Note that $\hat{\sigma}$ uses infinite memory. Let \mathfrak{R} be the set of all runs generated by $\hat{\sigma}$. We want to show that $\mathcal{P}_{\mathcal{M}, \hat{\sigma}, s_0}(\mathfrak{R} \wedge \limsup_{PP}(\geq 0)) = 1$. Since $\hat{\sigma}$ is deterministic and all states in \mathcal{M} are controlled, we have $|\mathfrak{R}| = 1$. Therefore it suffices to show that the unique $\rho \in \mathfrak{R}$ is winning. By definition of $\hat{\sigma}$, ρ sees every reward $\frac{1}{i}$ exactly once for $i = 1, 2, 3, \dots$. Hence the lim sup of the payoffs that ρ sees is $\limsup_{i \rightarrow \infty} -\frac{1}{i} = 0$ and thus $\rho \in \limsup_{PP}(\geq 0)$ and $\mathcal{P}_{\mathcal{M}, s_0, \hat{\sigma}}(\limsup_{PP}(\geq 0)) = 1$.

Towards Item 2, let σ be a deterministic strategy with k memory modes $\{0, 1, \dots, k-1\}$. For each memory mode $m \in \{0, 1, \dots, k-1\}$, consider σ 's behavior from s_0 . Since σ is deterministic, there are only two cases. In the first case we never visit s_0 again. In the second case we deterministically take a transition $r_i \rightarrow s_0$ for some particular $i(m)$ that depends on the initial memory mode m . For runs of the first case the lim sup of the payoffs is -1 . For runs of the second case, we never visit states r_j for $j > i_{\max} \stackrel{\text{def}}{=} \max_{m \in \{0, \dots, k-1\}} i(m)$ and thus the lim sup of the payoffs is $\leq -\frac{1}{i_{\max}} < 0$. Thus no runs induced by σ satisfy $\limsup_{PP}(\geq 0)$ and $\mathcal{P}_{\mathcal{M}, \sigma, s_0}(\limsup_{PP}(\geq 0)) = 0$.

□

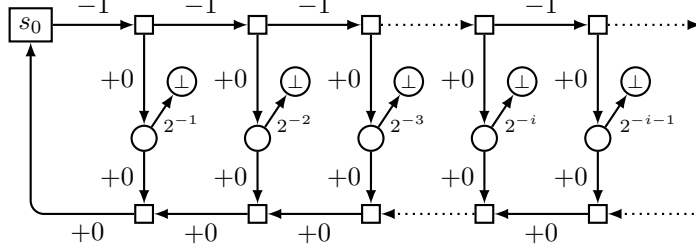

FIGURE 4: ε -optimal strategies for $\limsup_{PP}(\geq 0)$ cannot be chosen $\text{Rand}(F)$. In this example $\limsup_{PP}(\geq 0)$ and $\text{GF}\{s_0\}$ coincide.

Now we present the lower bound results for ε -optimal strategy complexity.

The $\limsup_{PP}(\geq 0)$ objective generalizes the Büchi objective $\text{GF } A$, even for integer rewards, hence the lower bounds for ε -optimal strategies for $\text{GF } A$ from [16, 19] carry over.

Theorem 8. *There exists an MDP \mathcal{M} as in Figure 4 such that $\text{val}_{\mathcal{M}, \limsup_{PP}(\geq 0)}(s_0) = 1$ and any $\text{Rand}(F)$ strategy σ is such that $\mathcal{P}_{\mathcal{M}, s_0, \sigma}(\limsup_{PP}(\geq 0)) = 0$.*

Proof. The result follows immediately from [20, 19, Proposition 2], since in \mathcal{M} , $\limsup_{PP}(\geq 0)$ and $\text{GF}\{s_0\}$ coincide by construction. \square

Theorem 9. ([16, Theorem 3]) *There exists a finitely branching countable MDP \mathcal{M} as in [16, Figure 3] with initial state s_0 and a subset of states $F \subseteq S$ where the step counter from s_0 is implicit in the current state such that*

1. $\text{val}_{\mathcal{M}, \text{GF } F}(s_0) = 1$ and
2. for every randomized Markov strategy σ , we have $\mathcal{P}_{\mathcal{M}, s_0, \sigma}(\text{GF } F) = 0$.

Definition 4. Let $\mathcal{M} = (S, S_{\square}, S_{\circ}, \longrightarrow, P, r)$ and $F \subseteq S$ be as in Theorem 9. We define transition rewards by $r : S \times S \rightarrow \mathbb{R}$ such that on \mathcal{M} the objectives $\limsup_{PP}(\geq 0)$ and $\text{GF } F$ coincide. I.e.

$$r(s \longrightarrow s') \stackrel{\text{def}}{=} \begin{cases} -1 & \text{if } s \notin F \\ +1 & \text{if } s \in F \end{cases}$$

$\bigcap_{i \in \mathbb{N}} \text{FG } A_i$ and $\liminf_{PP}(\geq 0)$		Upper bound	Lower bound
Infinitely Branching	Optimal strategies	Det(SC) 5	\neg Rand(F) 14
	ε -optimal strategies	Det(SC) 4	\neg Rand(F) 14
Finitely Branching	Optimal strategies	Det(Positional) 6	Trivial
	ε -optimal strategies	Det(Positional) 13	Trivial

TABLE 2: Summary of strategy complexity results for $\bigcap_{i \in \mathbb{N}} \text{FG } A_i$ and $\liminf_{PP}(\geq 0)$.

Theorem 10. *There exists a finitely branching countable MDP \mathcal{M} as in Definition 4 with integer rewards in $\{+1, -1\}$, initial state s_0 and the step counter from s_0 implicit in the current state such that*

1. $\text{val}_{\mathcal{M}, \limsup_{PP}(\geq 0)}(s_0) = 1$, but
2. for every randomized Markov strategy σ , we have $\mathcal{P}_{\mathcal{M}, s_0, \sigma}(\limsup_{PP}(\geq 0)) = 0$.

Proof. This follows directly from Definition 4 and Theorem 9. □

5. Strategy complexity of $\bigcap_{i \in \mathbb{N}} \text{FG } A_i$ and $\liminf_{PP}(\geq 0)$

5.1. Upper bound for $\bigcap_{i \in \mathbb{N}} \text{FG } A_i$ in infinitely branching MDPs

In order to prove the main results of this section, we use the following result on the Transience objective. Recall that, given an MDP $\mathcal{M} = (S, S_{\square}, S_{\circ}, \longrightarrow, P, r)$, $\text{Transience} \stackrel{\text{def}}{=} \bigwedge_{s \in S} \text{FG } \neg s$.

Theorem 11. ([18, Theorem 8]) *In every countable MDP there exist uniform ε -optimal MD strategies for Transience.*

Lemma 10. *Let $\mathcal{M} = (S, S_{\square}, S_{\circ}, \longrightarrow, P, r)$ be a countable MDP and $X \subseteq \longrightarrow$ a subset of the transitions. For every $\varepsilon > 0$ there exists a uniform ε -optimal MD strategy for the objective $\text{Transience} \cap \text{GX}$.*

Proof. Starting with \mathcal{M} , we construct a modified MDP \mathcal{M}' by adding a new state s_{\perp} and a self-loop $s_{\perp} \rightarrow s_{\perp}$. Moreover, all transitions of \mathcal{M} that are *not* in X are re-directed to s_{\perp} . Thus in \mathcal{M}' all runs that visit some transition $\notin X$ will eventually loop in s_{\perp} and are not transient. Hence in \mathcal{M}' we have that $\text{Transience} \cap \text{GX} = \text{Transience}$. On the other hand, all runs from states $s \in S$ that visit only transitions

in X are unaffected by the differences between \mathcal{M} and \mathcal{M}' . Therefore, for all states $s \in S$ and strategies τ from s ,

$$\mathcal{P}_{\mathcal{M},s,\tau}(\mathbf{Transience} \cap \mathbf{GX}) = \mathcal{P}_{\mathcal{M}',s,\tau}(\mathbf{Transience} \cap \mathbf{GX}) \quad (28)$$

By Theorem 11, for every $\varepsilon > 0$, there exists a uniform ε -optimal MD strategy σ for $\mathbf{Transience}$ in \mathcal{M}' . This σ is also uniform ε -optimal for $\mathbf{Transience} \cap \mathbf{GX}$ in \mathcal{M}' .

We now carry σ back to \mathcal{M} and show that it is also uniform ε -optimal for $\mathbf{Transience} \cap \mathbf{GX}$ in \mathcal{M} . Let $s_0 \in S$ be an arbitrary start state in \mathcal{M} .

$$\begin{aligned} & \mathcal{P}_{\mathcal{M},s_0,\sigma}(\mathbf{Transience} \cap \mathbf{GX}) \\ &= \mathcal{P}_{\mathcal{M}',s_0,\sigma}(\mathbf{Transience} \cap \mathbf{GX}) && (28) \\ &\geq \mathbf{val}_{\mathcal{M}',\mathbf{Transience} \cap \mathbf{GX}}(s_0) - \varepsilon && \text{uniform } \varepsilon\text{-optimality in } \mathcal{M}' \\ &= \mathbf{val}_{\mathcal{M},\mathbf{Transience} \cap \mathbf{GX}}(s_0) - \varepsilon && (28) \end{aligned}$$

□

Moreover, we need an auxiliary lemma (inspired by [18, Lemma 18]).

Lemma 11. *Let $\mathcal{M} = (S, S_{\square}, S_{\circ}, \longrightarrow, P, r)$ be a countable MDP with initial state s_0 . Let ψ be any objective which implies $\mathbf{Transience}$ and let σ be a strategy from the start state s_0 . Let $X \subseteq S$ be a finite set of states and $\delta > 0$. The following properties hold:*

1. *There is an $\ell \in \mathbb{N}$ such that $\mathcal{P}_{\mathcal{M},s_0,\sigma}(\psi \cap G^{\geq \ell}(\neg X)) \geq \mathcal{P}_{\mathcal{M},s_0,\sigma}(\psi) - \delta$.*
2. *For each $n \in \mathbb{N}$, there exists a finite set $Y \subseteq S$ such that $\mathcal{P}_{\mathcal{M},s_0,\sigma}(G^{\leq n} Y) \geq 1 - \delta$.*

Proof.

1. We know that ψ implies $\mathbf{Transience}$ and that $\mathbf{Transience} = \bigcap_{s \in S} \mathbf{FG} \neg s \subseteq \bigcap_{s \in X} \mathbf{FG} \neg s$. Therefore

$$\psi = \psi \cap \mathbf{Transience} \subseteq \psi \cap \bigcap_{s \in X} \mathbf{FG} \neg s \subseteq \psi. \quad (29)$$

This allows us to write:

$$\begin{aligned}
\psi = \psi \cap \text{Transience} &= \psi \cap \bigcap_{s \in S} \text{FG} \neg s && \text{def. of Transience} \\
&= \psi \cap \bigcap_{s \in X} \text{FG} \neg s && X \subseteq S \text{ and (29)} \\
&= \psi \cap \text{FG} \neg X && X \text{ is finite} \\
&= \psi \cap \bigcup_{k \in \mathbb{N}} \text{F}^{\leq k} \text{G} \neg X && \text{def. of F} \\
&= \psi \cap \bigcup_{k \in \mathbb{N}} \text{G}^{\geq k} \neg X && \text{F}^{\leq k} \text{G} = \text{G}^{\geq k}
\end{aligned}$$

Hence, by applying continuity of measures, we obtain that

$$\mathcal{P}_{\mathcal{M}, s_0, \sigma}(\psi) = \mathcal{P}_{\mathcal{M}, s_0, \sigma}(\psi \cap \bigcup_{k \in \mathbb{N}} \text{G}^{\geq k} \neg X) = \lim_{k \rightarrow \infty} \mathcal{P}_{\mathcal{M}, s_0, \sigma}(\psi \cap \text{G}^{\geq k} \neg X).$$

Thus, given δ , using the definition of a limit, we know that there must be an $\ell \in \mathbb{N}$ such that $\mathcal{P}_{\mathcal{M}, s_0, \sigma}(\psi \cap \text{G}^{\geq \ell} \neg X) \geq \mathcal{P}_{\mathcal{M}, s_0, \sigma}(\psi) - \delta$ as required.

2. Consider the Markov chain induced by playing σ from s_0 . In each round $i \leq n$ we cut infinite tails off the distributions such that we lose only $\leq \delta/n$ probability. Thus we remain inside some finite set of states Y_i with probability $\geq 1 - \frac{i \cdot \delta}{n}$ after the i -th round. By taking $Y \stackrel{\text{def}}{=} Y_n$, the result follows.

□

Now we show a general result about a combined objective that includes **Transience**.

Theorem 12. *Consider a countable MDP \mathcal{M} with initial state s_0 and the objective $\varphi \stackrel{\text{def}}{=} \text{Transience} \cap \bigcap_{i \in \mathbb{N}} \text{FG} A_i$. For every $\varepsilon > 0$ there exists an ε -optimal MD strategy from s_0 .*

Proof. Let σ be a general ε -optimal strategy for φ from s_0 in \mathcal{M} , i.e.

$$\mathcal{P}_{\mathcal{M}, s_0, \sigma}(\varphi) \geq \text{val}_{\mathcal{M}, \varphi}(s_0) - \varepsilon. \quad (30)$$

Let $\varepsilon_i \stackrel{\text{def}}{=} \varepsilon \cdot \frac{2^{-i}}{3}$ for $i \geq 1$. We construct a sequence of increasing natural numbers $\{n_i\}_{i \in \mathbb{N}}$ and finite sets $\{S_i\}_{i \in \mathbb{N}}$ such that the following holds:

$$\mathcal{P}_{\mathcal{M},s_0,\sigma} \left(\varphi \cap \bigcap_{i \in \mathbb{N}} (\mathbf{F}^{\leq n_i} (\mathbf{G}A_i \cap \mathbf{G}\neg S_{i-1}) \cap \mathbf{G}^{\leq n_i} S_i) \right) \geq \text{val}_{\mathcal{M},\varphi}(s_0) - 2\varepsilon \quad (31)$$

To this end, we prove by induction on k that the following property holds for $k \geq 0$.

Induction hypothesis:

$$\mathcal{P}_{\mathcal{M},s_0,\sigma} \left(\varphi \cap \bigcap_{i=1}^k (\mathbf{F}^{\leq n_i} (\mathbf{G}A_i \cap \mathbf{G}\neg S_{i-1}) \cap \mathbf{G}^{\leq n_i} S_i) \right) \geq \text{val}_{\mathcal{M},\varphi}(s_0) - \varepsilon - 3 \sum_{i=1}^k \varepsilon_i \quad (32)$$

Base case $k = 0$: Let $n_0 \stackrel{\text{def}}{=} 0$ and let $S_0 \stackrel{\text{def}}{=} \{s_0\}$ and $S_{-1} \stackrel{\text{def}}{=} \emptyset$. Then setting $k = 0$ yields empty index sets for the intersection and sum, reducing the base case to (30).

Induction step from k to $k + 1$:

Assume that for some k we have (32). To simplify the notation, let

$$V \stackrel{\text{def}}{=} \text{val}_{\mathcal{M},\varphi}(s_0) - \varepsilon - 3 \sum_{i=1}^k \varepsilon_i.$$

By definition, φ implies $\text{FG } A_{k+1}$, giving us

$$\begin{aligned} \mathcal{P}_{\mathcal{M},s_0,\sigma} \left(\varphi \cap \bigcap_{i=1}^k (\mathbf{F}^{\leq n_i} (\mathbf{G}A_i \cap \mathbf{G}\neg S_{i-1}) \cap \mathbf{G}^{\leq n_i} S_i) \right) &= \\ \mathcal{P}_{\mathcal{M},s_0,\sigma} \left(\varphi \cap \bigcap_{i=1}^k (\mathbf{F}^{\leq n_i} (\mathbf{G}A_i \cap \mathbf{G}\neg S_{i-1}) \cap \mathbf{G}^{\leq n_i} S_i) \cap \text{FG } A_{k+1} \right). \end{aligned}$$

Since φ implies **Transience**, we can instantiate Lemma 11(1) with parameters $\psi = \varphi \cap \bigcap_{i=1}^k (\mathbf{F}^{\leq n_i} (\mathbf{G}A_i \cap \mathbf{G}\neg S_{i-1}) \cap \mathbf{G}^{\leq n_i} S_i) \cap \text{FG } A_{k+1}$, $X = S_k$ and $\delta = \varepsilon_{k+1}$ to obtain an $\ell \in \mathbb{N}$ such that

$$\mathcal{P}_{\mathcal{M},s_0,\sigma} \left(\varphi \cap \bigcap_{i=1}^k (\mathbf{F}^{\leq n_i} (\mathbf{G}A_i \cap \mathbf{G}\neg S_{i-1}) \cap \mathbf{G}^{\leq n_i} S_i) \cap \text{FG } A_{k+1} \cap \mathbf{G}^{\geq \ell} \neg S_k \right) \geq V - \varepsilon_{k+1}.$$

Now we use continuity of measures and the definition of \mathbf{F} to obtain that

$$\begin{aligned} &\mathcal{P}_{\mathcal{M},s_0,\sigma} \left(\varphi \cap \bigcap_{i=1}^k (\mathbf{F}^{\leq n_i} (\mathbf{G}A_i \cap \mathbf{G}\neg S_{i-1}) \cap \mathbf{G}^{\leq n_i} S_i) \cap \text{FG } A_{k+1} \cap \mathbf{G}^{\geq \ell} \neg S_k \right) \\ &= \lim_{j \rightarrow \infty} \mathcal{P}_{\mathcal{M},s_0,\sigma} \left(\varphi \cap \bigcap_{i=1}^k (\mathbf{F}^{\leq n_i} (\mathbf{G}A_i \cap \mathbf{G}\neg S_{i-1}) \cap \mathbf{G}^{\leq n_i} S_i) \cap \mathbf{F}^{\leq j} \text{FG } A_{k+1} \cap \mathbf{G}^{\geq \ell} \neg S_k \right). \end{aligned}$$

Then, using the definition of a limit, we can choose an $m \in \mathbb{N}$ such that

$$\begin{aligned} &\mathcal{P}_{\mathcal{M},s_0,\sigma} \left(\varphi \cap \bigcap_{i=1}^k (\mathbf{F}^{\leq n_i} (\mathbf{G}A_i \cap \mathbf{G}\neg S_{i-1}) \cap \mathbf{G}^{\leq n_i} S_i) \cap \mathbf{F}^{\leq m} \text{FG } A_{k+1} \cap \mathbf{G}^{\geq \ell} \neg S_k \right) \\ &\geq V - 2\varepsilon_{k+1}. \end{aligned}$$

We know that $G^{\geq \ell}$ is equivalent to $F^{\leq \ell}G$, so $G^{\geq \ell} \neg S_k = F^{\leq \ell}G \neg S_k$. Then, setting $n_{k+1} \stackrel{\text{def}}{=} \max\{m, \ell\}$ we obtain that

$$\begin{aligned} & \mathcal{P}_{\mathcal{M}, s_0, \sigma} \left(\varphi \cap \bigcap_{i=1}^k (F^{\leq n_i} (GA_i \cap G \neg S_{i-1}) \cap G^{\leq n_i} S_i) \cap F^{\leq n_{k+1}} (GA_{k+1} \cap G \neg S_k) \right) \\ & \geq V - 2\varepsilon_{k+1}. \end{aligned}$$

Finally, we instantiate Lemma 11(2) with $n = n_{k+1}$ and $\delta = \varepsilon_{k+1}$ to obtain a finite set of states S_{k+1} such that

$$\begin{aligned} & \mathcal{P}_{\mathcal{M}, s_0, \sigma} \left(\varphi \cap \bigcap_{i=1}^k (F^{\leq n_i} (GA_i \cap G \neg S_{i-1}) \cap G^{\leq n_i} S_i) \cap \right. \\ & \quad \left. F^{\leq n_{k+1}} (GA_{k+1} \cap G \neg S_k) \cap G^{\leq n_{k+1}} S_{k+1} \right) \geq V - 3\varepsilon_{k+1} \end{aligned}$$

This yields (32) for $k + 1$, thus concluding the induction step. By using continuity of measures and the definition of the ε_i , we obtain (31) from (32).

Note that $\bigcap_{i \in \mathbb{N}} (F^{\leq n_i} (GA_i \cap G \neg S_{i-1}) \cap G^{\leq n_i} S_i)$ is equal to $\bigcap_{i \in \mathbb{N}} G^{\geq n_i} A_i \cap G^{\geq n_i} \neg S_{i-1} \cap G^{\leq n_{i+1}} S_{i+1}$. (Since $n_0 = 0$, the term $G^{\leq n_0} S_0$ holds trivially.) Hence σ also satisfies

$$\mathcal{P}_{\mathcal{M}, s_0, \sigma} \left(\varphi \cap \bigcap_{i \in \mathbb{N}} G^{\geq n_i} A_i \cap G^{\geq n_i} \neg S_{i-1} \cap G^{\leq n_{i+1}} S_{i+1} \right) \geq \text{val}_{\mathcal{M}, \varphi}(s_0) - 2\varepsilon \quad (33)$$

Let $B_i \stackrel{\text{def}}{=} \{(x \rightarrow y) \mid x, y \in S_{i+1} \setminus S_{i-1}\}$ be the set of transitions with source and target inside $S_{i+1} \setminus S_{i-1}$. Let $\text{Good}_i \stackrel{\text{def}}{=} A_i \cap B_i$ for all i and $\text{Good} \stackrel{\text{def}}{=} \bigcup_{i \in \mathbb{N}} \text{Good}_i$. Our choice of Good_i is such that $\bigcap_{i \in \mathbb{N}} G^{\geq n_i} A_i \cap G^{\geq n_i} \neg S_{i-1} \cap G^{\leq n_{i+1}} S_{i+1}$ implies $\bigcap_{i \in \mathbb{N}} G^{[n_i, n_{i+1}]}$ Good_i for all i . Furthermore, $\bigcap_{i \in \mathbb{N}} G^{[n_i, n_{i+1}]}$ $\text{Good}_i \subseteq G \text{Good}$. Hence we obtain from (33) that

$$\text{val}_{\mathcal{M}, \text{Transience} \cap G \text{Good}}(s_0) \geq \mathcal{P}_{\mathcal{M}, s_0, \sigma}(\text{Transience} \cap G \text{Good}) \geq \text{val}_{\mathcal{M}, \varphi}(s_0) - 2\varepsilon \quad (34)$$

Now we show that

$$\text{Transience} \cap G \text{Good} \subseteq \bigcap_{i \in \mathbb{N}} FG A_i \quad (35)$$

Consider any run $\rho \in \text{Transience} \cap G \text{Good}$. Since S_{i+1} is finite, B_i is finite, and thus Good_i is finite. By transience, ρ can visit each finite set Good_i only finitely often. Hence ρ stays in Good forever whilst visiting sets Good_i for ever greater i . Since $\text{Good}_i \subseteq A_i$, $\rho \in G \text{Good}$ and the sets A_i are monotone decreasing (wrt. set inclusion), it follows that ρ satisfies $\bigcap_{i \in \mathbb{N}} FG A_i$ as desired.

By Lemma 10, there exists a memoryless deterministic (MD) ε -optimal strategy σ^* from s_0 for the objective $\mathbf{Transience} \cap \mathbf{G Good}$. Now we show that σ^* is 3ε -optimal for φ .

$$\begin{aligned} \mathcal{P}_{\mathcal{M}, s_0, \sigma^*}(\varphi) &= \mathcal{P}_{\mathcal{M}, s_0, \sigma^*}(\mathbf{Transience} \cap \bigcap_{i \in \mathbb{N}} \mathbf{FG} A_i) \\ &\geq \mathcal{P}_{\mathcal{M}, s_0, \sigma^*}(\mathbf{Transience} \cap \mathbf{G Good}) \end{aligned} \quad (35)$$

$$\begin{aligned} &\geq \mathbf{val}_{\mathcal{M}, \mathbf{Transience} \cap \mathbf{G Good}}(s_0) - \varepsilon && \sigma^* \text{ is } \varepsilon\text{-optimal} \\ &\geq \mathbf{val}_{\mathcal{M}, \varphi}(s_0) - 3\varepsilon \end{aligned} \quad (34)$$

Since ε can be chosen arbitrarily small, the result follows. \square

Corollary 4. *Given an MDP \mathcal{M} and initial state s_0 , ε -optimal strategies for $\bigcap_{i \in \mathbb{N}} \mathbf{FG} A_i$ can be chosen*

1. MD if \mathcal{M} is universally transient.
2. Det(SC) otherwise.

Proof. Towards item 1., if \mathcal{M} is universally transient then (modulo a nullset under every strategy) $\bigcap_{i \in \mathbb{N}} \mathbf{FG} A_i$ coincides with $\mathbf{Transience} \cap \bigcap_{i \in \mathbb{N}} \mathbf{FG} A_i$, and thus the result follows from Theorem 12.

Towards item 2., consider the MDP $S(\mathcal{M})$ that is derived from \mathcal{M} by encoding the step counter from s_0 into the states; cf. Definition 1. $S(\mathcal{M})$ is trivially universally transient. Then item 1. yields an ε -optimal MD strategy in $S(\mathcal{M})$. Finally, Lemma 1 yields an ε -optimal Det(SC) strategy from s_0 in \mathcal{M} . \square

Corollary 5. *Given an MDP \mathcal{M} and initial state s_0 , optimal strategies for $\bigcap_{i \in \mathbb{N}} \mathbf{FG} A_i$, where they exist, can be chosen*

1. MD if \mathcal{M} is universally transient.
2. Det(SC) otherwise.

Proof. Towards item 1., assume that \mathcal{M} is universally transient. We apply Corollary 4.1 to obtain an ε -optimal MD strategy from s_0 . Since $\bigcap_{i \in \mathbb{N}} \mathbf{FG} A_i$ is a shift invariant objective, Theorem 2.2 yields an MD strategy that is optimal from every state of \mathcal{M} that has an optimal strategy.

Towards item 2., if \mathcal{M} is not universally transient, then we work in $S(\mathcal{M})$ which is universally transient and apply item 1. to obtain optimal MD strategies from every state of $S(\mathcal{M})$ that has an optimal strategy. By Lemma 1 we can translate this MD strategy on $S(\mathcal{M})$ back to a Det(SC) strategy in \mathcal{M} , which is optimal for $\bigcap_{i \in \mathbb{N}} \text{FG} A_i$ from s_0 (provided that s_0 admits any optimal strategy at all). \square

5.2. Upper bound for $\bigcap_{i \in \mathbb{N}} \text{FG} A_i$ in finitely branching MDPs

We show that, in the special case of finitely branching MDPs, MD strategies suffice for $\bigcap_{i \in \mathbb{N}} \text{FG} A_i$. First we need the following auxiliary lemma, which holds only for finitely branching MDPs.

Lemma 12. *Given a finitely branching countable MDP \mathcal{M} , a subset $T \subseteq \rightarrow$ of the transitions and a state s , we have*

$$\text{val}_{\mathcal{M}, \neg FT}(s) < 1 \Rightarrow \exists k \in \mathbb{N}. \text{val}_{\mathcal{M}, \neg F^{\leq k} T}(s) < 1$$

i.e., if it is impossible to completely avoid T then there is a bounded threshold k and a fixed nonzero chance of seeing T within $\leq k$ steps, regardless of the strategy.

Proof. It suffices to show that $\forall k \in \mathbb{N}. \text{val}_{\mathcal{M}, \neg F^{\leq k} T}(s) = 1$ implies $\text{val}_{\mathcal{M}, \neg FT}(s) = 1$. Since \mathcal{M} is finitely branching, the state s has only finitely many successors $\{s_1, \dots, s_n\}$.

Consider the case where s is a controlled state. If we had the property for all i with $1 \leq i \leq n$ there exists a $k_i \in \mathbb{N}$ such that $\text{val}_{\mathcal{M}, \neg F^{\leq k_i} T}(s_i) < 1$, then we would have $\text{val}_{\mathcal{M}, \neg F^{\leq k} T}(s) < 1$ for $k = (\max_{1 \leq i \leq n} k_i) + 1$ which contradicts our assumption. Thus there must exist an $i \in \{1, \dots, n\}$ with $\forall k \in \mathbb{N}. \text{val}_{\mathcal{M}, \neg F^{\leq k} T}(s_i) = 1$. We define a strategy σ that chooses the successor state s_i when in state s .

Similarly, if s is a random state, we must have $\forall k \in \mathbb{N}. \text{val}_{\mathcal{M}, \neg F^{\leq k} T}(s_i) = 1$ for all its successors s_i .

By using our constructed strategy σ , we obtain $\mathcal{P}_{\mathcal{M}, s, \sigma}(\neg FT) = 1$ and therefore $\text{val}_{\mathcal{M}, \neg FT}(s) = 1$ as required. \square

The following theorem is very similar to [22, Theorem 27]. Here we present a much shorter proof that uses Theorem 12.

Theorem 13. *Consider a finitely branching countable MDP $\mathcal{M} = (S, S_{\square}, S_{\circ}, \longrightarrow, P, r)$*

with initial state s_0 and a $\bigcap_{i \in \mathbb{N}} \text{FG} A_i$ objective. For every $\varepsilon > 0$ there exists an ε -optimal MD strategy from s_0 .

Proof. Let $\varepsilon > 0$. We begin by partitioning the state space into two sets, S_{safe} and $S \setminus S_{\text{safe}}$. The set S_{safe} is the subset of states which is surely winning for the safety objective of only using transitions in $\bigcap_{i \in \mathbb{N}} A_i$. Since \mathcal{M} is finitely branching, there exists a uniformly optimal MD strategy σ_{safe} for this safety objective [25, 19].

We construct a new MDP \mathcal{M}' by modifying \mathcal{M} . We create a gadget G_{safe} composed of a sequence of new controlled states x_0, x_1, x_2, \dots with transitions $x_0 \rightarrow x_1, x_1 \rightarrow x_2$, etc. Let $X \stackrel{\text{def}}{=} \bigcup_{i \in \mathbb{N}} \{x_i \rightarrow x_{i+1}\}$. We now define sets $B_i \stackrel{\text{def}}{=} A_i \cup X$. Hence any run entering G_{safe} is winning for $\bigcap_{i \in \mathbb{N}} \text{FG} B_i$. We insert G_{safe} into \mathcal{M} by replacing all incoming transitions to S_{safe} with transitions that lead to x_0 . The idea behind this construction is that when playing in \mathcal{M} , once you reach a state in S_{safe} , you can win surely by playing the optimal MD strategy σ_{safe} for safety. So we replace S_{safe} with the surely winning gadget G_{safe} . Thus

$$\text{val}_{\mathcal{M}, \bigcap_{i \in \mathbb{N}} \text{FG} A_i}(s_0) = \text{val}_{\mathcal{M}', \bigcap_{i \in \mathbb{N}} \text{FG} B_i}(s_0) \quad (36)$$

and if an ε -optimal MD strategy exists in \mathcal{M} , then there exists a corresponding one in \mathcal{M}' , and vice-versa.

In the next step we argue that under *every* strategy σ' from s_0 in \mathcal{M}' the attainment for $\bigcap_{i \in \mathbb{N}} \text{FG} B_i$ and $\text{Transience} \cap \bigcap_{i \in \mathbb{N}} \text{FG} B_i$ coincide, i.e.,

Claim 2.

$$\forall \sigma'. \mathcal{P}_{\mathcal{M}', s_0, \sigma'} \left(\bigcap_{i \in \mathbb{N}} \text{FG} B_i \right) = \mathcal{P}_{\mathcal{M}', s_0, \sigma'} \left(\text{Transience} \cap \bigcap_{i \in \mathbb{N}} \text{FG} B_i \right).$$

Proof. The \geq inequality holds trivially, since $\text{Transience} \cap \bigcap_{i \in \mathbb{N}} \text{FG} B_i \subseteq \bigcap_{i \in \mathbb{N}} \text{FG} B_i$. Towards the \leq inequality, it suffices to show that

$$\forall \sigma'. \mathcal{P}_{\mathcal{M}', s_0, \sigma'} \left(\bigcap_{i \in \mathbb{N}} \text{FG} B_i \cap \overline{\text{Transience}} \right) = 0. \quad (37)$$

Let σ' be an arbitrary strategy from s_0 in \mathcal{M}' and \mathfrak{R} be the set of all runs induced by it. For every $s \in S$, let $\mathfrak{R}_s \stackrel{\text{def}}{=} \{\rho \in \mathfrak{R} \mid \rho \text{ satisfies GF}(s)\}$ be the set of runs seeing state s infinitely often. In particular, any run $\rho \in \mathfrak{R}_s$ is not transient. Indeed,

$\overline{\text{Transience}} = \bigcup_{s \in S} \mathfrak{R}_s$. We want to show that for every state $s \in S$ and strategy σ'

$$\mathcal{P}_{\mathcal{M}', s_0, \sigma'} \left(\bigcap_{i \in \mathbb{N}} \text{FG } B_i \cap \mathfrak{R}_s \right) = 0. \quad (38)$$

Since all runs visiting a state in G_{safe} are transient, any \mathfrak{R}_s with s in G_{safe} must be empty, and thus (38) holds for these cases.

Now we consider the remaining cases of \mathfrak{R}_s where s is not in G_{safe} . Let $T \stackrel{\text{def}}{=} \{t \in \rightarrow_{\mathcal{M}'} \mid t \notin \bigcap_{i \in \mathbb{N}} B_i\} = \bigcup_{i \in \mathbb{N}} \overline{B_i}$.

We now show that $\text{val}_{\mathcal{M}', \neg FT}(s) < 1$ by assuming the opposite and deriving a contradiction. Assume that $\text{val}_{\mathcal{M}', \neg FT}(s) = 1$. The objective $\neg FT$ is a safety objective. Thus, since \mathcal{M}' is finitely branching, there exists a strategy from s that surely avoids T (always pick an optimal move) [25, 19]. (This would not hold in infinitely branching MDPs where optimal moves might not exist.) However, by construction of S_{safe} and \mathcal{M}' , this implies that s is in G_{safe} . Contradiction. Thus $\text{val}_{\mathcal{M}', \neg FT}(s) < 1$.

Since \mathcal{M}' is finitely branching, we can apply Lemma 12 and obtain that there exists a threshold k_s such that $\text{val}_{\mathcal{M}', \neg F^{\leq k_s} T}(s) < 1$. Therefore $\delta_s \stackrel{\text{def}}{=} 1 - \text{val}_{\mathcal{M}', \neg F^{\leq k_s} T}(s) > 0$. Thus, under every strategy, upon visiting s there is a chance $\geq \delta_s$ of seeing a transition in $T = \bigcup_{i \in \mathbb{N}} \overline{B_i}$ within the next $\leq k_s$ steps. Let $T^s \subseteq T$ be the subset of transitions in T that can be reached in $\leq k_s$ steps from s . Since \mathcal{M}' is finitely branching, T^s is finite. Since the sequence of sets $\{B_i\}_{i \in \mathbb{N}}$ is monotone decreasing, the sequence $\{\overline{B_i}\}_{i \in \mathbb{N}}$ is monotone increasing. Hence, for every transition $t \in T^s$, there is a minimal index i such that $t \in \overline{B_i}$. Moreover, since T^s is finite, the maximum (over $t \in T^s$) of these minimal indices is bounded, i.e., $\ell_s \stackrel{\text{def}}{=} \max_{t \in T^s} \min\{i \mid t \in T^s \text{ and } t \in \overline{B_i}\} < \infty$.

Thus, under *every* strategy, upon visiting s there is a chance $\geq \delta_s$ of seeing a transition in $\overline{B_{\ell_s}}$ within the next $\leq k_s$ steps, i.e.,

$$\forall \sigma' \mathcal{P}_{\mathcal{M}', s, \sigma'}(F^{\leq k_s} \overline{B_{\ell_s}}) \geq \delta_s > 0 \quad (39)$$

Define $\mathfrak{R}_s^i \stackrel{\text{def}}{=} \{\rho \in \mathfrak{R} \mid \rho \text{ sees } s \text{ at least } i \text{ times}\}$, so we get $\mathfrak{R}_s = \bigcap_{i \in \mathbb{N}} \mathfrak{R}_s^i$. We obtain

$$\begin{aligned}
 & \sup_{\sigma'} \mathcal{P}_{\mathcal{M}', s_0, \sigma'} \left(\bigcap_{i \in \mathbb{N}} \text{FG } B_i \cap \mathfrak{R}_s \right) \\
 & \leq \sup_{\sigma'} \mathcal{P}_{\mathcal{M}', s_0, \sigma'} (\text{FG } B_{\ell_s} \cap \mathfrak{R}_s) && \text{set inclusion} \\
 & = \sup_{\sigma'} \lim_{n \rightarrow \infty} \mathcal{P}_{\mathcal{M}', s_0, \sigma'} (\text{F}^{\leq n} \text{G } B_{\ell_s} \cap \mathfrak{R}_s) && \text{continuity of measures} \\
 & \leq \sup_{\sigma''} \mathcal{P}_{\mathcal{M}', s, \sigma''} (\text{G } B_{\ell_s} \cap \mathfrak{R}_s) && s \text{ visited after } > n \text{ steps} \\
 & = \sup_{\sigma''} \mathcal{P}_{\mathcal{M}', s, \sigma''} (\text{G } B_{\ell_s} \cap \bigcap_{i \in \mathbb{N}} \mathfrak{R}_s^i) && \text{def. of } \mathfrak{R}_s^i \\
 & = \sup_{\sigma''} \lim_{i \rightarrow \infty} \mathcal{P}_{\mathcal{M}', s, \sigma''} (\text{G } B_{\ell_s} \cap \mathfrak{R}_s^i) && \text{continuity of measures} \\
 & \leq \lim_{i \rightarrow \infty} (1 - \delta_s)^i = 0 && \text{by def. of } \mathfrak{R}_s^i \text{ and (39)}
 \end{aligned}$$

and hence (38). From this we obtain

$$\begin{aligned}
 \mathcal{P}_{\mathcal{M}', s_0, \sigma'} \left(\bigcap_{i \in \mathbb{N}} \text{FG } B_i \cap \overline{\text{Transience}} \right) &= \mathcal{P}_{\mathcal{M}', s_0, \sigma'} \left(\bigcap_{i \in \mathbb{N}} \text{FG } B_i \cap \bigcup_{s \in S} \mathfrak{R}_s \right) \\
 &\leq \sum_{s \in S} \mathcal{P}_{\mathcal{M}', s_0, \sigma'} \left(\bigcap_{i \in \mathbb{N}} \text{FG } B_i \cap \mathfrak{R}_s \right) = 0
 \end{aligned}$$

and thus (37) and Claim 2. \square

By Theorem 12, there exists an ε -optimal MD strategy $\hat{\sigma}$ from s_0 for $\text{Transience} \cap \bigcap_{i \in \mathbb{N}} \text{FG } B_i$ in \mathcal{M}' , i.e.,

$$\mathcal{P}_{\mathcal{M}', s_0, \hat{\sigma}} (\text{Transience} \cap \bigcap_{i \in \mathbb{N}} \text{FG } B_i) \geq \text{val}_{\mathcal{M}', \text{Transience} \cap \bigcap_{i \in \mathbb{N}} \text{FG } B_i} (s_0) - \varepsilon. \quad (40)$$

We construct an MD strategy σ^* in \mathcal{M} which plays like the MD strategy σ_{safe} in S_{safe} and plays like the MD strategy $\hat{\sigma}$ everywhere else.

$$\begin{aligned}
 \mathcal{P}_{\mathcal{M}, s_0, \sigma^*} \left(\bigcap_{i \in \mathbb{N}} \text{FG } A_i \right) &= \mathcal{P}_{\mathcal{M}', s_0, \hat{\sigma}} \left(\bigcap_{i \in \mathbb{N}} \text{FG } B_i \right) && \text{def. of } \mathcal{M}', \sigma^* \text{ and } \sigma_{\text{safe}} \\
 &= \mathcal{P}_{\mathcal{M}', s_0, \hat{\sigma}} (\text{Transience} \cap \bigcap_{i \in \mathbb{N}} \text{FG } B_i) && \text{by Claim 2} \\
 &\geq \text{val}_{\mathcal{M}', \text{Transience} \cap \bigcap_{i \in \mathbb{N}} \text{FG } B_i} (s_0) - \varepsilon && \text{by (40)} \\
 &= \text{val}_{\mathcal{M}', \bigcap_{i \in \mathbb{N}} \text{FG } B_i} (s_0) - \varepsilon && \text{by Claim 2} \\
 &= \text{val}_{\mathcal{M}, \bigcap_{i \in \mathbb{N}} \text{FG } A_i} (s_0) - \varepsilon && \text{by (36)}
 \end{aligned}$$

Hence σ^* is an ε -optimal MD strategy for $\bigcap_{i \in \mathbb{N}} \text{FG } A_i$ from s_0 in \mathcal{M} . \square

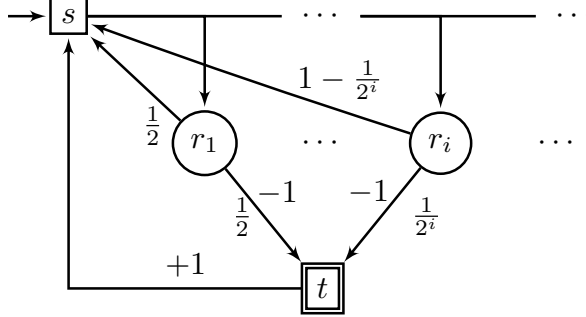

FIGURE 5: We present an infinitely branching MDP adapted from [19, Figure 3] and augmented with a reward structure. All of the edges carry reward 0 except the edges entering t that carry reward -1 and the edge from t to s carries reward $+1$. A strategy is therefore optimal for $\liminf_{PP}(\geq 0)$ if and only if it satisfies $\text{co-Büchi}(t)$ almost surely. This requires infinite memory. Note that in the context of Corollary 4, this example only works because it is not universally transient.

Corollary 6. *Given a finitely branching MDP \mathcal{M} and a $\bigcap_{i \in \mathbb{N}} \text{FGA}_i$ objective, there exists a single MD strategy that is optimal from every state that has an optimal strategy.*

Proof. Since $\bigcap_{i \in \mathbb{N}} \text{FGA}_i$ is shift invariant, the result follows from Theorem 13 and Theorem 2. \square

5.3. Lower bound

We present the lower bound for the strategy complexity in terms of $\liminf_{PP}(\geq 0)$, because reasoning about counterexamples with transition rewards is very natural.

Theorem 14. *There exists an infinitely branching MDP \mathcal{M} as in Figure 5 with initial state s such that*

- every FR strategy σ is such that $\mathcal{P}_{\mathcal{M},s,\sigma}(\liminf_{PP}(\geq 0)) = 0$
- there exists a strategy σ such that $\mathcal{P}_{\mathcal{M},s,\sigma}(\liminf_{PP}(\geq 0)) = 1$.

Hence, optimal (and even almost-surely winning) strategies and ε -optimal strategies for $\liminf_{PP}(\geq 0)$ require infinite memory.

Proof. This follows directly from [19, Theorem 4], since in Figure 5, $\liminf_{PP}(\geq 0)$ coincides with the co-Büchi objective to visit state t only finitely often. \square

	Optimal $\mathcal{E}(\limsup_{PP})$	Optimal $\mathcal{E}(\liminf_{PP})$
Finitely Branching	Rand(Positional) or Det(SC) 15 16	MD 18
Infinitely Branching	Rand(Positional) or Det(SC) 15 16	Det(SC) 17 19

TABLE 3: Strategy complexity of optimal strategies for the expected lim sup and lim inf.

6. Expected Payoff Objectives

We show how upper and lower bounds on the strategy complexity of optimal strategies for $\mathcal{E}(\limsup_{PP})$ and $\mathcal{E}(\liminf_{PP})$ follow directly from results on the $\limsup_{PP}(\geq 0)$ and $\liminf_{PP}(\geq 0)$ objectives, respectively. This allows us to solve two open problem from Sudderth [30, p.1 and p.11].

6.1. Expected lim sup

Theorem 15. *Let \mathcal{M} be a countable MDP with initial state s_0 . If an optimal strategy for $\mathcal{E}(\limsup_{PP})$ exists, then there also exists an optimal memoryless randomized (MR) strategy and an optimal deterministic Markov (Det(SC)) strategy.*

Proof. This follows from Corollaries 1 and 2 and Theorem 3. □

In [30, p.11] Sudderth poses the question whether ‘the existence of an optimal lim sup strategy at every state always implies that there exists an optimal, possibly randomized, stationary strategy’. With Theorem 15, we answer this question in the affirmative. It is worth noting that Dubins and Savage [13, Example 4, p.59] present a counterexample in the framework of finitely additive probability theory. Indeed our proof of Theorem 5 requires countably additive probability theory, since the memoryless randomized (MR) strategy is constructed as a countably infinite combination of memoryless deterministic (MD) strategies. The next theorem gives us a lower bound on the strategy complexity.

Theorem 16. *There exists a finitely branching countable MDP \mathcal{M} with rational rewards as in Figure 3 with initial state s_0 such that*

1. $\exists \hat{\sigma} \mathcal{E}_{\mathcal{M}, s_0, \hat{\sigma}}(\limsup_{PP}) = 0 = \mathbf{val}_{\mathcal{E}(\limsup_{PP})}(s_0)$, i.e., $\hat{\sigma}$ is optimal.
2. For every Det(F) strategy σ we have $\mathcal{E}_{\mathcal{M}, s_0, \sigma}(\limsup_{PP}) < 0 = \mathbf{val}_{\mathcal{E}(\limsup_{PP})}(s_0)$.

So optimal strategies, when they exist, cannot be chosen Det(F).

Proof. This follows directly from Theorem 7. \square

6.2. Expected lim inf

The following theorem solves the open question from [30, p.1, last par.] about the strategy complexity of optimal strategies for the expected lim inf.

Theorem 17. *Let \mathcal{M} be a countable (possibly infinitely branching) MDP. Optimal strategies for $\mathcal{E}(\liminf_{PP})$, when they exist, can be chosen as*

- *MD, if \mathcal{M} is universally transient.*
- *Deterministic Markov (Det(SC)) in general.*

Proof. This follows from Theorem 3 and Corollary 5. \square

Theorem 18. *Let \mathcal{M} be a countable finitely branching MDP. Optimal strategies for $\mathcal{E}(\liminf_{PP})$, when they exist, can be chosen MD.*

Proof. This follows from Theorem 3 and Corollary 6. \square

Theorem 19. *There exists an infinitely branching MDP \mathcal{M} as in Figure 5 with reward implicit in the state and initial state s such that*

- *there is an optimal strategy σ with $\mathcal{E}_{\mathcal{M},s,\sigma}(\liminf_{PP}) = 1 = \mathbf{val}_{\mathcal{E}(\liminf_{PP})}(s)$.*
- *every FR strategy σ is such that $\mathcal{E}_{\mathcal{M},s,\sigma}(\liminf_{PP}) = -1$*

Hence, optimal strategies for $\mathcal{E}(\liminf_{PP})$ require infinite memory.

Proof. This follows directly from Theorem 14. \square

7. Conclusion

Our results provide a complete picture of the strategy complexity of lim sup and lim inf threshold objectives, and the corresponding problem for optimal strategies for the expected lim sup and lim inf. They also highlight fundamental differences between the lim sup and lim inf objectives. Unlike for the lim inf case,

- The memory requirements of strategies for lim sup objectives depend on whether the transition rewards are integers or rationals/reals.

- Randomization does make a difference for limsup objectives, e.g., strategies can sometimes trade a step counter for randomization (Corollary 1 and Corollary 2).
- For limsup objectives, the memory requirements of ε -optimal strategies differ from those of optimal strategies (Table 1).
- For limsup objectives, the memory requirements of strategies do *not* depend on whether the MDP is infinitely branching or finitely branching. (Nor does it depend on a particular branching degree ≥ 2).

Finally, as shown in Section 6, the strategy complexity may depend on whether one works in the finitely additive probability theory or in the countably additive one.

References

- [1] ABBEEL, P. AND NG, A. Y. (2004). Learning first-order Markov models for control. In *Advances in Neural Information Processing Systems 17*. MIT Press pp. 1–8.
- [2] ABDULLA, P. A., CIOBANU, R., MAYR, R., SANGNIER, A. AND SPROSTON, J. (2016). Qualitative analysis of VASS-induced MDPs. In *International Conference on Foundations of Software Science and Computational Structures (FoSSaCS)*. vol. 9634.
- [3] ASHKENAZI-GOLAN, G., FLESCH, J., PREDTETCHINSKI, A. AND SOLAN, E. (2020). Reachability and safety objectives in Markov decision processes on long but finite horizons. *Journal of Optimization Theory and Applications* **185**, 945–965.
- [4] BAIER, C. AND KATOEN, J.-P. (2008). *Principles of Model Checking*. MIT Press.
- [5] BÄUERLE, N. AND RIEDER, U. (2011). *Markov Decision Processes with Applications to Finance*. Springer-Verlag Berlin Heidelberg.
- [6] BILLINGSLEY, P. (1995). *Probability and Measure*. Wiley, New York, NY. Third Edition.
- [7] BLONDEL, V. D. AND TSITSIKLIS, J. N. (2000). A survey of computational complexity results in systems and control. *Automatica* **36**, 1249–1274.
- [8] BRÁZDIL, T., BROŽEK, V., ETESSAMI, K. AND KUČERA, A. (2013). Approximating the Termination Value of One-Counter MDPs and Stochastic Games. *Information and Computation* **222**, 121–138.
- [9] BRÁZDIL, T., BROŽEK, V., ETESSAMI, K., KUČERA, A. AND WOJTCZAK, D. (2010). One-counter Markov decision processes. In *ACM-SIAM Symposium on Discrete Algorithms (SODA)*. Society for Industrial and Applied Mathematics. pp. 863–874.
- [10] CLARKE, E., GRUMBERG, O. AND PELED, D. (1999). *Model Checking*. MIT Press.

- [11] CLARKE, E. M., HENZINGER, T. A., VEITH, H. AND BLOEM, R., Eds. (2018). *Handbook of Model Checking*. Springer.
- [12] DUBINS, L. E. AND SAVAGE, L. J. (2014). *How to Gamble If You Must: Inequalities for Stochastic Processes*. Dover Publications Inc.
- [13] DUBINS, L. E., SAVAGE, L. J., SUDDERTH, W. AND GILAT, D. (2014). *How to gamble if you must: Inequalities for stochastic processes*. Courier Corporation.
- [14] ETESSAMI, K., WOJTCZAK, D. AND YANNAKAKIS, M. (2010). Quasi-birth–death processes, tree-like QBDs, probabilistic 1-counter automata, and pushdown systems. *Performance Evaluation* **67**, 837–857.
- [15] ETESSAMI, K. AND YANNAKAKIS, M. (2015). Recursive Markov decision processes and recursive stochastic games. *Journal of the ACM* **62**, 1–69.
- [16] KIEFER, S., MAYR, R., SHIRMOHAMMADI, M. AND TOTZKE, P. (2019). Büchi objectives in countable MDPs. In *ICALP*. vol. 132 of *LIPICs*. pp. 119:1–119:14. Full version at <https://arxiv.org/abs/1904.11573>.
- [17] KIEFER, S., MAYR, R., SHIRMOHAMMADI, M. AND TOTZKE, P. (2020). Strategy Complexity of Parity Objectives in Countable MDPs. In *Proc. of CONCUR*. vol. 171 of *LIPICs*. pp. 7:1–7:17.
- [18] KIEFER, S., MAYR, R., SHIRMOHAMMADI, M. AND TOTZKE, P. (2021). Transience in countable MDPs. In *Proc. of CONCUR*. vol. 203 of *LIPICs*. Full version at <https://arxiv.org/abs/2012.13739>.
- [19] KIEFER, S., MAYR, R., SHIRMOHAMMADI, M. AND WOJTCZAK, D. (2017). Parity Objectives in Countable MDPs. In *LICS*. IEEE.
- [20] KRČÁL, J. (2009). Determinacy and Optimal Strategies in Stochastic Games. *Master’s thesis*. Masaryk University, School of Informatics Brno, Czech Republic.
- [21] MAITRA, A. P. AND SUDDERTH, W. D. (1996). *Discrete Gambling and Stochastic Games*. Springer-Verlag.

- [22] MAYR, R. AND MUNDAY, E. (2021). Strategy Complexity of Mean Payoff, Total Payoff and Point Payoff Objectives in Countable MDPs. In *Proc. of CONCUR*. vol. 203 of *LIPICs*.
- [23] NOWAK, A. (2005). *Advances in dynamic games : applications to economics, finance, optimization, and stochastic control*. Birkhaeuser, Boston.
- [24] ORNSTEIN, D. (1969). On the existence of stationary optimal strategies. *Proceedings of the American Mathematical Society* **20**, 563–569.
- [25] PUTERMAN, M. L. (1994). *Markov Decision Processes: Discrete Stochastic Dynamic Programming* 1st ed. John Wiley & Sons, Inc., New York, NY, USA.
- [26] RAGHAVEN, T., FERGUSON, T., PARTHASARATHY, T. AND VRIEZE, O. (2012). *Stochastic games and related topics: in honor of Professor LS Shapley* vol. 7. Springer Science & Business Media.
- [27] SCHÄL, M. (2002). Markov decision processes in finance and dynamic options. In *Handbook of Markov Decision Processes*. Springer pp. 461–487.
- [28] SIGAUD, O. AND BUFFET, O. (2013). *Markov Decision Processes in Artificial Intelligence*. John Wiley & Sons.
- [29] SUDDERTH, W. D. (1983). Gambling problems with a limit inferior payoff. *Mathematics of Operations Research* **8**, 287–297.
- [30] SUDDERTH, W. D. (2020). Optimal Markov strategies. *Decisions in Economics and Finance* **43**, 43–54.
- [31] SUTTON, R. AND BARTO, A. (2018). *Reinforcement Learning: An Introduction*. Adaptive Computation and Machine Learning. MIT Press.
- [32] VARDI, M. (1985). Automatic verification of probabilistic concurrent finite-state programs. In *Proc. of FOCS'85*. pp. 327–338.

Appendix A. Memory and strategies

We formalize the amount of *memory* needed to implement strategies. Let \mathbf{M} be a countable set of memory modes, and let $\tau : \mathbf{M} \times S \rightarrow \mathcal{D}(\mathbf{M} \times S)$ be a function that meets the following two conditions: for all modes $\mathbf{m} \in \mathbf{M}$,

- for all controlled states $s \in S_{\square}$, the distribution $\tau(\mathbf{m}, s)$ is over $\mathbf{M} \times \{s' \mid s \rightarrow s'\}$.
- for all random states $s \in S_{\circ}$, and $s' \in S$, we have $\sum_{\mathbf{m}' \in \mathbf{M}} \tau(\mathbf{m}, s)(\mathbf{m}', s') = P(s)(s')$.

The function τ together with an initial memory mode \mathbf{m}_0 induce a strategy σ_{τ} as follows. Consider the Markov chain with the set $\mathbf{M} \times S$ of states and the probability function τ . A sequence $\rho = s_0 \cdots s_i$ corresponds to a set $H(\rho) = \{(\mathbf{m}_0, s_0) \cdots (\mathbf{m}_i, s_i) \mid \mathbf{m}_0, \dots, \mathbf{m}_i \in \mathbf{M}\}$ of runs in this Markov chain. Each $\rho s \in s_0 S^* S_{\square}$ induces a probability distribution $\mu_{\rho s} \in \mathcal{D}(\mathbf{M})$, the probability of being in state (\mathbf{m}, s) conditioned on having taken some partial run from $H(\rho s)$. We define σ_{τ} such that $\sigma_{\tau}(\rho s)(s') = \sum_{\mathbf{m}, \mathbf{m}' \in \mathbf{M}} \mu_{\rho s}(\mathbf{m}) \tau(\mathbf{m}, s)(\mathbf{m}', s')$ for all $\rho s \in S^* S_{\square}$ and all $s' \in S$.

We say that a strategy σ can be *implemented* with memory \mathbf{M} if there exist $\mathbf{m}_0 \in \mathbf{M}$ and τ such that $\sigma_{\tau} = \sigma$.