

COMPOSITION MAPS IN HEEGAARD FLOER HOMOLOGY

JESSE COHEN

ABSTRACT. We use results of Auroux [Aur10] and Zemke [Zem21a] to prove that, in the morphism spaces formulation of Heegaard Floer homology given in [LOT11], the opposite composition map agrees up to homotopy with the map on Heegaard Floer complexes induced by a pair-of-pants cobordism.

1. INTRODUCTION

Heegaard Floer homology is a suite of invariants of closed oriented 3-manifolds and cobordisms between them introduced by Peter Ozsváth and Zoltán Szabó in [OS04] (see also [OS06]). The particular variant of Heegaard Floer homology we will be concerned with is the so-called ‘hat’ version. This invariant associates to a closed oriented 3-manifold Y a graded \mathbb{F}_2 -vector space $\widehat{HF}(Y)$ and to each smooth, connected, 4-dimensional cobordism $W : Y_0 \rightarrow Y_1$ a map $\widehat{F}_W : \widehat{HF}(Y_0) \rightarrow \widehat{HF}(Y_1)$ and this assignment is functorial with respect to composition of cobordisms. The vector space $\widehat{HF}(Y)$ is the homology of a complex $\widehat{CF}(Y)$ defined as a variant of the Lagrangian-intersection Floer complex of a pair of Lagrangian tori in a Kähler manifold. Bordered Heegaard Floer homology, defined by Lipshitz–Ozsváth–Thurston in [LOT18], is a suite of invariants associated to a 3-manifold Y with parametrized boundary taking the form of homotopy types of A_∞ -modules over algebras $\mathcal{A}(\mathcal{Z})$ associated to a combinatorialization \mathcal{Z} of the boundary parametrization. In particular, if Y has one boundary component, the bordered Floer package gives us a left type- D structure $\widehat{CFD}(Y)$, which one may think of as a projective left dg-module, whose homotopy type is a smooth invariant of Y . We briefly recall the construction of this object in Section 2. These modules satisfy pairing theorems as follows: if Y_1 and Y_2 are 3-manifolds with the same connected boundary surface and $Y_{12} = -Y_1 \cup_{\partial} Y_2$ is the closed 3-manifold obtained by gluing Y_1 and Y_2 along their respective boundary parametrizations, then there is a homotopy equivalence $\widehat{CF}(Y_{12}) \simeq \text{Mor}^{\mathcal{A}}(\widehat{CFD}(Y_1), \widehat{CFD}(Y_2))$, where the right-hand side is the space of $\mathcal{A} = \mathcal{A}(-\mathcal{Z})$ -module homomorphisms $\widehat{CFD}(Y_1) \rightarrow \widehat{CFD}(Y_2)$.

1.1. Results. Our main result is the following chain-level version of an assertion of Lipshitz–Ozsváth–Thurston given in [LOT11, Section 1.5].

Theorem 1.1. *Let Y_1 , Y_2 , and Y_3 be bordered 3-manifolds, all of which have boundaries parametrized by the same surface F , and let $\mathcal{A} = \mathcal{A}(-F)$ be the algebra*

This material is based upon work supported by the National Science Foundation under Grant No. DMS-2204214 and under Grant No. DMS-1928930, while the author was in residence at the Simons Laufer Mathematical Sciences Institute (previously known as MSRI) in Berkeley, California, during the Fall 2022 semester.

associated to $-F$. Let $Y_{ij} = -Y_i \cup_{\partial} Y_j$ and consider the pair of pants cobordism $W : Y_{12} \sqcup Y_{23} \rightarrow Y_{13}$ given by

$$(1) \quad W = (\Delta \times F) \cup_{e_1 \times F} (e_1 \times Y_1) \cup_{e_2 \times F} (e_2 \times Y_2) \cup_{e_3 \times F} (e_3 \times Y_3),$$

where Δ is a triangle with edges $e_1, e_2,$ and e_3 in cyclic order. If we define $\text{Mor}^{\mathcal{A}}(Y_i, Y_j) := \text{Mor}^{\mathcal{A}}(\widehat{\text{CFD}}(Y_i), \widehat{\text{CFD}}(Y_j))$ to be the space of left \mathcal{A} -module homomorphisms $\widehat{\text{CFD}}(Y_i) \rightarrow \widehat{\text{CFD}}(Y_j)$, then the composition map $f \otimes g \mapsto g \circ f$ fits into a homotopy commutative square of the form

$$(2) \quad \begin{array}{ccc} \text{Mor}^{\mathcal{A}}(Y_1, Y_2) \otimes \text{Mor}^{\mathcal{A}}(Y_2, Y_3) & \xrightarrow{f \otimes g \mapsto g \circ f} & \text{Mor}^{\mathcal{A}}(Y_1, Y_3) \\ \simeq \downarrow & & \downarrow \simeq \\ \widehat{\text{CF}}(Y_{12}) \otimes \widehat{\text{CF}}(Y_{23}) & \xrightarrow{\widehat{f}_W} & \widehat{\text{CF}}(Y_{13}) \end{array}$$

where \widehat{f}_W is the map induced by W and the vertical maps come from the pairing theorem [LOT11, Theorem 1].

Remark. The complexes $\text{Mor}^{\mathcal{A}}(Y_i, Y_j)$ are well-defined only up to a choice of bordered Heegaard diagrams for Y_i and Y_j .

To prove this, we use a bordered Heegaard triple AT , originally defined by Auroux in [Aur10]. In particular, we prove the following.

Theorem 1.2. *Let \mathcal{H}_i be bordered Heegaard diagrams for bordered 3-manifolds Y_i for $i = 1, 2, 3$ and let \mathcal{H}_i^+ be the bordered Heegaard triple obtained by doubling the β -circles in \mathcal{H}_i by a small Hamiltonian isotopy. Then the map*

$$(3) \quad \widehat{G}_{\text{AT}} : \text{Mor}^{\mathcal{A}}(Y_1, Y_2) \otimes \text{Mor}^{\mathcal{A}}(Y_2, Y_3) \rightarrow \text{Mor}^{\mathcal{A}}(Y_1, Y_3)$$

induced by counting pseudoholomorphic triangles in $\text{AT} \cup \mathcal{H}_1^+ \cup \mathcal{H}_2^+ \cup \mathcal{H}_3^+$, identifying $\text{Mor}^{\mathcal{A}}(Y_i, Y_j)$ with $\widehat{\text{CFD}}(Y_i) \boxtimes \mathcal{A} \boxtimes \widehat{\text{CFD}}(Y_j)$, agrees up to homotopy with the composition map $f \otimes g \mapsto g \circ f$.

We then elaborate on the construction of 4-manifolds with boundary and corners from bordered Heegaard triples and show (Corollary 5.2) that the triple $\text{AT}_{1,2,3}$ represents a variant of the pair of pants cobordism described above and use this to prove Theorem 1.1 via results of Zemke [Zem21a, Zem21b].

Acknowledgments. The author would like to thank Gary Guth, Robert Lipshitz, and Maggie Miller for several helpful conversations.

2. BACKGROUND

Definition 2.1. Fix a dg-algebra \mathcal{A} over a ring \mathbb{k} . A (left) type- D structure over \mathcal{A} is a pair (N, δ_N^1) consisting of a graded \mathbb{k} -module N and a map

$$(4) \quad \delta_N^1 : N \rightarrow (\mathcal{A} \otimes N)[1]$$

satisfying the compatibility condition

$$(5) \quad (\mu_2 \otimes \mathbb{I}_N) \circ (\mathbb{I}_{\mathcal{A}} \otimes \delta_N^1) \circ \delta_N^1 + (\mu_1 \otimes \mathbb{I}_N) \circ \delta_N^1 = 0.$$

A type- D structure homomorphism is a \mathbb{k} -module map $f : N_1 \rightarrow \mathcal{A} \otimes N_2$ satisfying the equation

$$(6) \quad (\mu_2 \otimes \mathbb{I}_{N_2}) \circ (\mathbb{I}_{\mathcal{A}} \otimes f) \circ \delta_{N_1}^1 + (\mu_2 \otimes \mathbb{I}_{N_2}) \circ (\mathbb{I}_{\mathcal{A}} \otimes \delta_{N_2}^1) \circ f + (\mu_1 \otimes \mathbb{I}_{N_2}) \circ f = 0$$

and a homotopy between type- D structure homomorphisms $f, g : N_1 \rightarrow \mathcal{A} \otimes N_2$ is a \mathbb{k} -module homomorphism $h : N_1 \rightarrow (\mathcal{A} \otimes N_2)[-1]$ such that

$$(\mu_2 \otimes \mathbb{I}_{N_2}) \circ (\mathbb{I}_{\mathcal{A}} \otimes h) \circ \delta_{N_1}^1 + (\mu_2 \otimes \mathbb{I}_{N_2}) \circ (\mathbb{I}_{\mathcal{A}} \otimes \delta_{N_2}^1) \circ h + (\mu_1 \otimes \mathbb{I}_{N_2}) \circ h = f - g.$$

Example 1. Let \mathcal{A} be a dg-algebra over $\mathbb{k} = \mathbb{F}_2^k$ and M a dg-module over \mathcal{A} which is free as an \mathcal{A} -module. Fix an \mathcal{A} -basis B for M and let $N = \mathbb{k}B$. Then the restriction of the differential ∂_M to N determines a map $\delta^1 : N \rightarrow (\mathcal{A} \otimes N)[1]$ satisfying the type- D structure relation. Any dg-module homomorphism $M_1 \rightarrow M_2$ induces a corresponding map of type- D structures and the converse is true for type- D structures obtained in this manner. Similarly, homotopies of such maps are equivalent to homotopies of type- D structures.

On the other hand, if (N, δ^1) is a left type- D structure over \mathcal{A} , then $\mathcal{A} \otimes N$ is a left differential \mathcal{A} -module with differential

$$(7) \quad m_1 = (\mu_2 \otimes \mathbb{I}_N) \circ (\mathbb{I}_{\mathcal{A}} \otimes \delta^1) + \mu_1 \otimes \mathbb{I}_N$$

and module structure map $m_2 = \mu_2 \otimes \mathbb{I}_N$. As in the above example, type- D homomorphisms and homotopies induce chain homomorphisms and chain homotopies, respectively.

Definition 2.2. Given a type- D structure (N, δ^1) , recursively define maps

$$(8) \quad \delta^i : N \rightarrow (\mathcal{A}^{\otimes i} \otimes N)[i]$$

by taking $\delta^0 = \mathbb{I}_N$ and $\delta^i = (\mathbb{I}_{\mathcal{A}^{\otimes i-1}} \otimes \delta^1) \circ \delta^{i-1}$. We say that (N, δ^1) is *bounded* if, for all $x \in N$, there is an integer n such that $\delta^i(x) = 0$ for all $i \geq n$.

Definition 2.3. A *pointed matched circle* \mathcal{Z} is a quadruple (Z, \mathbf{a}, M, z) consisting of an oriented circle Z , a subset $\mathbf{a} \subset Z$ consisting of $4k$ points a_1, \dots, a_{4k} , a 2-to-1 function $M : \mathbf{a} \rightarrow [2k]$ called a *matching*, and a basepoint $z \in Z \setminus \mathbf{a}$. We require that surgering Z along the matching M yields a single circle; this ensures that the following construction is well-defined. Given a pointed matched circle \mathcal{Z} , there is an oriented surface $F(\mathcal{Z})$ obtained by attaching oriented 2-dimensional 1-handles to the points $\mathbf{a} \subset \partial D^2 \subset D^2$ according to the matching M to obtain a surface with a single boundary component, along which we glue a second disk.

We will regard each pointed matched circle $\mathcal{Z} = (Z, \mathbf{a}, M, z)$ as a contact 1-manifold and refer to intervals $\rho \subset Z$ which have ends on \mathbf{a} and do not cross z as *Reeb chords*.

Definition 2.4. A *bordered 3-manifold* Y is an oriented 3-manifold with boundary together with an orientation-preserving diffeomorphism $\phi : F(\mathcal{Z}) \rightarrow \partial Y$. Such data can be specified by a *bordered Heegaard diagram* $(\bar{\Sigma}, \boldsymbol{\alpha}, \boldsymbol{\beta}, z)$, where:

- $\bar{\Sigma}$ is a compact, oriented, surface of some genus g ,
- $\boldsymbol{\alpha} = \boldsymbol{\alpha}^a \cup \boldsymbol{\alpha}^c = \{\alpha_1^a, \dots, \alpha_{2k}^a, \alpha_1^c, \dots, \alpha_{g-k}^c\}$ is a collection of $g+k$ pairwise-disjoint curves in $\bar{\Sigma}$ consisting of $g-k$ embedded circles α_i^c in the interior of $\bar{\Sigma}$ and $2k$ arcs α_j^a with boundary on and transverse to $\partial \bar{\Sigma}$,
- $\boldsymbol{\beta} = \{\beta_1, \dots, \beta_g\}$ is a collection of g pairwise disjoint embedded circles β_i in the interior of $\bar{\Sigma}$,

- and z is a point in $\partial\bar{\Sigma} \setminus (\alpha \cap \partial\bar{\Sigma})$

such that $\bar{\Sigma} \setminus \alpha$ and $\bar{\Sigma} \setminus \beta$ are connected and any intersections of α - and β curves is transverse. Moreover, two bordered Heegaard diagrams specify the same bordered 3-manifold Y if and only if they can be related to one another by a finite sequence of Heegaard moves fixing the endpoints of the α -arcs (cf. [LOT18, Chapter 4]).

In [LOT18], Lipshitz–Ozsváth–Thurston associate to a bordered Heegaard diagram $\mathcal{H} = (\bar{\Sigma}, \alpha, \beta, z)$ for Y a left type- D structure $\widehat{CFD}(Y) := \widehat{CFD}(\mathcal{H})$, over an algebra $\mathcal{A} = \mathcal{A}(-\mathcal{Z})$ associated to the pointed matched circle \mathcal{Z} with its opposite orientation, whose homotopy type is an invariant of the bordered 3-manifold Y . We briefly recall this construction here.

Definition 2.5. Let $\mathcal{H} = (\bar{\Sigma}, \alpha, \beta, z)$ be a genus g bordered Heegaard diagram for a 3-manifold Y . A *generator* of \mathcal{H} is a g -element set $\mathbf{x} = \{x_1, \dots, x_g\}$ consisting of intersection points of α - and β -curves such that

- exactly one x_i lies (1) on each α -circle and (2) on each β -circle, and
- at most one x_i lies on each α -arc.

Denote the set of generators of \mathcal{H} by $\mathfrak{S}(\mathcal{H})$.

The \mathbb{F}_2 -vector space $X(\mathcal{H})$ spanned by $\mathfrak{S}(\mathcal{H})$ admits a left-action by the sub-algebra $\mathcal{I} \subset \mathcal{A}$ of idempotents. As a left \mathcal{A} -module, $\widehat{CFD}(\mathcal{H})$ is then defined by $\widehat{CFD}(\mathcal{H}) := \mathcal{A} \otimes_{\mathcal{I}} X(\mathcal{H})$ and it is endowed with the structure of a left differential module by taking

$$(9) \quad \partial(\mathbb{I} \otimes \mathbf{x}) = \sum_{\mathbf{y} \in \mathfrak{S}(\mathcal{H})} \sum_{B \in \pi_2(\mathbf{x}, \mathbf{y})} a_{\mathbf{x}, \mathbf{y}}^B \otimes \mathbf{y},$$

where

$$(10) \quad a_{\mathbf{x}, \mathbf{y}}^B = \sum_{\vec{\rho} \mid \text{ind}(B, \vec{\rho})=1} \#\mathcal{M}^B(\mathbf{x}, \mathbf{y}; \vec{\rho}) a(-\vec{\rho}).$$

Here, $\pi_2(\mathbf{x}, \mathbf{y})$ is the space of homology classes of Whitney disks connecting \mathbf{x} and \mathbf{y} , $\vec{\rho} = (\rho_1, \dots, \rho_n)$ is a sequence of Reeb chords in $\partial\bar{\Sigma}$, $\mathcal{M}^B(\mathbf{x}, \mathbf{y}; \vec{\rho})$ is the moduli space of pseudoholomorphic representatives of B in $\text{int}(\bar{\Sigma}) \times [0, 1] \times \mathbb{R}$ with asymptotic condition $\vec{\rho}$ at east infinity modulo translation, and $a(-\vec{\rho}) = a(-\rho_1) \cdots a(-\rho_n)$ is the product of algebra elements associated to the tuple $-\vec{\rho} = (-\rho_1, \dots, -\rho_n)$ of Reeb chords with their orientations reversed. The quantity $\text{ind}(B, \vec{\rho})$ is a Maslov-type index which guarantees that the moduli space $\mathcal{M}^B(\mathbf{x}, \mathbf{y}; \vec{\rho})$ is 0-dimensional when $\text{ind}(B, \vec{\rho}) = 1$. More generally, the moduli spaces $\mathcal{M}^B(\mathbf{x}_1, \dots, \mathbf{x}_n; \vec{\rho})$ of pseudoholomorphic n -gons in $\text{int}(\bar{\Sigma}) \times \mathbb{D}_n^2$ for $n > 2$, where \mathbb{D}_n^2 is an n -times boundary-punctured disk, is 0-dimensional whenever $\text{ind}(B, \vec{\rho}) = 0$.

In [LOT11], Lipshitz–Ozsváth–Thurston show that, for bordered 3-manifolds Y_1 and Y_2 with the same boundary, the chain complex $\text{Mor}^{\mathcal{A}}(\widehat{CFD}(Y_1), \widehat{CFD}(Y_2))$ of \mathcal{A} -module maps $\widehat{CFD}(Y_1) \rightarrow \widehat{CFD}(Y_2)$ is homotopy equivalent to the Heegaard Floer chain complex $\widehat{CF}(-Y_1 \cup_{\partial} Y_2)$. There, they considered an (α, β) -bordered Heegaard diagram $\text{AZ}(\mathcal{Z})$, first introduced by Auroux in [Aur10], associated to \mathcal{Z} and show that the bordered Floer bimodule $\widehat{CFAA}(\text{AZ}(\mathcal{Z}))$ is isomorphic, as a left-right $(\mathcal{A}(-\mathcal{Z}), \mathcal{A}(-\mathcal{Z}))$ -bimodule, to the regular bimodule ${}_{\mathcal{A}(-\mathcal{Z})}\mathcal{A}(-\mathcal{Z})_{\mathcal{A}(-\mathcal{Z})}$.

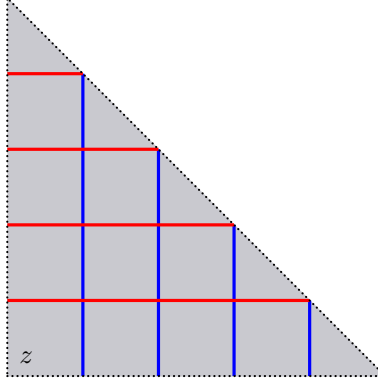

FIGURE 1. The triangle Δ_1 and the arcs which descend to the α - and β -arcs in the interpolating piece $AZ(\mathcal{Z})$ associated to the unique genus 1 pointed matched circle.

As a corollary, they then deduce that

$$(11) \quad \widehat{CF}(-Y_1 \cup_{\partial} Y_2) \simeq \overline{\widehat{CFD}(Y_1)} \boxtimes \widehat{CFAA}(AZ(\mathcal{Z})) \boxtimes \widehat{CFD}(Y_2) \\ \cong \text{Mor}^{A(-\mathcal{Z})}(\widehat{CFD}(Y_1), \widehat{CFD}(Y_2)).$$

The diagram $AZ(\mathcal{Z})$ is defined as follows: if k is the genus of the surface $F(\mathcal{Z})$ determined by \mathcal{Z} , consider the planar triangle Δ_k bounded by the coordinate axes and the line $x + y = 4k + 1$, which we will call the *diagonal* of Δ_k . Let Σ' be the quotient of Δ_k by identifying small neighborhoods of the points $(i, 4k + 1 - i)$ and $(j, 4k + 1 - j)$ in the diagonal if i and j are matched in \mathcal{Z} in such a way that the result is an orientable genus k surface with a single boundary component. If i and j are matched in \mathcal{Z} , then the disconnected subspace $\Delta_k \cap (\{x = i\} \cup \{x = j\})$ descends to a single arc β_i in Σ' and, similarly, the subspace $\Delta_k \cap (\{y = 4k + 1 - i\} \cup \{y = 4k + 1 - j\})$ descends to a single arc α_i . Let Σ be the result of attaching a 1-handle to $\partial\Sigma'$ along the 0-sphere $\{(0, 0), (4k + 1, 0)\}$ and let z be a neighborhood of the core of this 1-handle. Then $AZ(\mathcal{Z})$ is the diagram $(\Sigma, \alpha, \beta, z)$, where $\alpha = \{\alpha_i\}$ and $\beta = \{\beta_i\}$.

3. AN INTERPOLATING TRIPLE

We will consider a similarly defined bordered Heegaard triple associated to \mathcal{Z} , also due to Auroux, which we call $AT(\mathcal{Z})$. We construct $AT(\mathcal{Z})$ as follows: if, as before, k is the genus of $F(\mathcal{Z})$, consider the square \square_k in the plane bounded by the coordinate axes and the lines $x = 4k + 1$ and $y = 4k + 1$ and let Σ' be the quotient of \square_k obtained by identifying small neighborhoods of the points $(i, 4k + 1)$ and $(j, 4k + 1)$ in the segment $\square_k \cap \{y = 4k + 1\}$ if i and j are matched in \mathcal{Z} in such a way that the result is an orientable genus k surface with one boundary component. Now, if i and j are matched in \mathcal{Z} , then the disconnected subspaces

$$(12) \quad \begin{aligned} g_i &= \square_k \cap (\{-x + y = 4k + 1 - i\} \cup \{-x + y = 4k + 1 - j\}) \\ d_i &= \square_k \cap (\{x = i\} \cup \{x = j\}) \\ e_i &= \square_k \cap (\{x + y = 4k + 1 - i\} \cup \{x + y = 4k + 1 - j\}) \end{aligned}$$

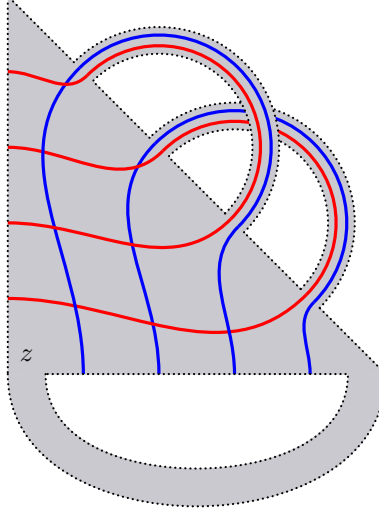

FIGURE 2. The diagram $AZ(\mathcal{Z})$ associated to the genus 1 pointed matched circle.

descend to single arcs γ'_i , δ'_i , and ε'_i , respectively, in Σ' . Now let $\overline{\Sigma}_{AT}$ be the result of attaching 1-handles to $\partial\Sigma'$ along the 0-spheres $\{(0, 0), (4k + 1, 0)\}$ and $\{(4k + 1, 0), (4k + 1, 1)\}$ and let z be a neighborhood of the core of either handle and take $AT(\mathcal{Z})$ to be the triple $(\overline{\Sigma}_{AT}, \gamma, \delta, \varepsilon, z)$, where, as before, $\gamma = \{\gamma_i\}$, $\delta = \{\delta_i\}$, and $\varepsilon = \{\varepsilon_i\}$ are given by suitably generic Hamiltonian perturbations of the arcs γ'_i , δ'_i , and ε'_i . Note that the unperturbed arcs have nongeneric triple intersections so the perturbations are strictly necessary in order for the result to be an admissible diagram in the sense of [LOT18]. We will perturb the triple intersections, in the same manner as given by Auroux in [Aur10], as shown in Figure 3. We also include in AT the data of an embedded trivalent tree z as shown in Figure 4; in the quotient AT , this tree has one leaf on each boundary component.

Since it will be convenient for us to have done so later, we will modify AT slightly by assuming that the spaces g_i and e_i are given by lines of slope $\tan(\frac{\pi}{6})$ and $\tan(\frac{5\pi}{6})$, respectively, instead of 1 and -1 . We assume these again meet the top boundary segment of \square_k at the points $(i, 4k + 1)$. If we think of these lines as the intersections of lines in \mathbb{R}^2 with \square_k , then the perturbations of the curves in AT which removes the nongeneric triple points can be realized by translations of the g - and e -lines in the plane as shown in Figure 5. This choice is motivated by the proof of Lemma 4.5.

Now let η be any one of γ , δ , or ε and let $\partial_\eta AT(\mathcal{Z})$ be the component of $\partial AT(\mathcal{Z})$ which intersects η nontrivially. Note that, by construction, the result of forgetting η and gluing a disk to Σ along $\partial_\eta AT(\mathcal{Z})$ is a copy of $AZ(\mathcal{Z})$. For $\eta, \theta \in \{\gamma, \delta, \varepsilon\}$, let $AZ_{\eta\theta}$ be the diagram obtained by deleting the collection of arcs $\zeta \in \{\gamma, \delta, \varepsilon\} \setminus \{\eta, \theta\}$ and let $\mathcal{A}_{\eta\theta} = \widehat{CFAA}(AZ_{\eta\theta})$. We recall [Aur10, Proposition 4.8] which says that the map $\mathcal{A}_{\delta\varepsilon} \otimes_{\mathbb{F}} \mathcal{A}_{\gamma\delta} \rightarrow \mathcal{A}_{\gamma\varepsilon}$ given by counting provincial holomorphic triangles in $AT(\mathcal{Z})$ coincides with multiplication under the identification of $\mathcal{A}_{\eta\theta}$ with $\mathcal{A}(\mathcal{Z})$.

Proposition 3.1 ([LOT11], Proposition 4.1). *The left-right $(\mathcal{A}(\mathcal{Z}), \mathcal{A}(\mathcal{Z}))$ -bimodule $\widehat{CFAA}(AZ_{\eta\theta})$ is isomorphic to $\mathcal{A}(\mathcal{Z})$.*

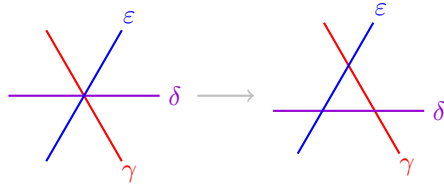

FIGURE 3. Auroux's perturbation convention for triple intersections in $AT(\mathcal{Z})$.

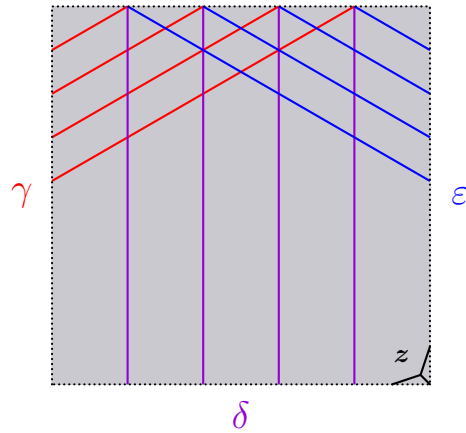

FIGURE 4. The square \square_1 and the arcs which descend to the γ -, δ -, and ε -arcs in the interpolating triple $AT(\mathcal{Z})$ associated to the unique genus 1 pointed matched circle.

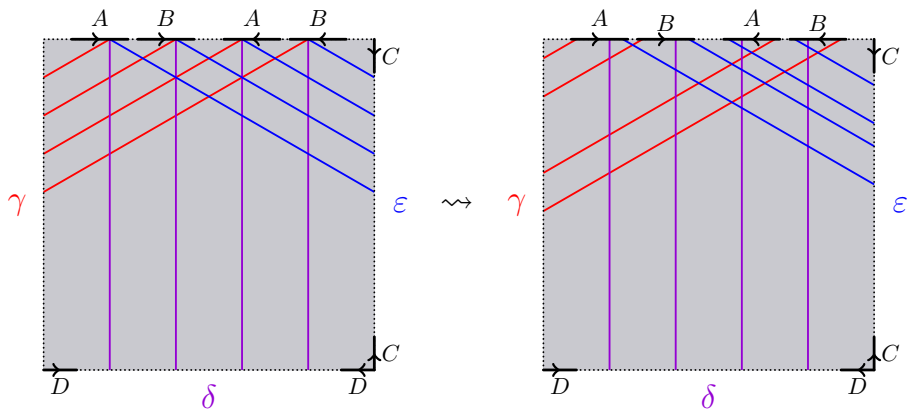

FIGURE 5. Perturbing the diagram using planar translations to obtain the triple $AT(\mathcal{Z})$ (right) associated to the genus 1 pointed matched circle. Here, we draw the segments of $\partial \square_k$ which are identified in AT as oriented black lines and label the glued pairs of segments with the same letter.

Sketch. We identify the generating set $\mathfrak{S}(\mathbf{AZ}_{\eta\theta})$ with the usual basis for $\mathcal{A}(\mathcal{Z})$ in terms of strand diagrams. A generator $\mathbf{x} \in \mathfrak{S}(\mathbf{AZ}_{\eta\theta})$ is a set of points in $\boldsymbol{\eta} \cap \boldsymbol{\theta}$. To a single intersection point $x \in \boldsymbol{\eta} \cap \boldsymbol{\theta}$, we associate a Reeb chord or smeared horizontal strand in $\mathcal{Z} = (Z, \mathbf{a}, M)$ as follows. First, draw \mathcal{Z} above the square, oriented from left to right, with the set of points \mathbf{a} identified with the boundary intersection points of $\boldsymbol{\eta}$ and $\boldsymbol{\theta}$. Next, note that there are unique segments e and g in the square passing through x and there is an unique triangular (or empty) region T_x of \square_k bounded by the segments e and g and the line $y = 4k + 1$. If T_x is empty, then x is a boundary intersection point and we associate to it the smeared horizontal strand given by the matching M . Otherwise, we associate to x the Reeb chord ρ_x in \mathcal{Z} determined by the line segment $T_x \cap \{y = 4k + 1\}$. A generator $\mathbf{x} \in \mathfrak{S}(\mathbf{AZ}_{\eta\theta})$ may therefore be identified with a set of Reeb chords and smeared horizontal strands and, hence, with a strand diagram. It is straightforward to see that this identification gives a bijection between $\mathfrak{S}(\mathbf{AZ}_{\eta\theta})$ and the usual basis for $\mathcal{A}(\mathcal{Z})$. Note also that we may identify the left- and right-idempotents of a generator \mathbf{x} with the collections of left- and right-endpoints of the segments $T_x \cap \{y = 4k + 1\}$, respectively. The identification we have given here is equivalent to the one given in [LOT11]. To recover theirs from ours, note that if T_x is nonempty, then there is an unique rectangular domain R_x in $\mathbf{AZ}_{\eta\theta}$ bounded by the leftmost segment of $\partial\square_k$, $\boldsymbol{\eta}$, and $T_x \cap \boldsymbol{\theta}$ with vertices at x and the topmost endpoint of $T_x \cap \boldsymbol{\theta}$. Drawing \mathcal{Z} oriented downward and to the left of $\mathbf{AZ}_{\eta\theta}$ so that \mathbf{a} is identified with $\boldsymbol{\eta} \cap \partial\mathbf{AZ}_{\eta\theta}$, one can verify readily that the Reeb chord in \mathcal{Z} determined by $R_x \cap \partial\mathbf{AZ}_{\eta\theta}$ is precisely ρ_x . Lastly, the diagram $\mathbf{AZ}_{\eta\theta}$ is *nice* in the sense of [SW10] so the differential on $\widehat{CF\!A\!A}(\mathbf{AZ}_{\eta\theta})$ counts only embedded rectangles, the only nontrivial A_∞ -operations are the m_2 maps, and these operations count half-strips — i.e. bigons asymptotic to Reeb chords at the boundary. It is then straightforward to identify the differential and bimodule structures on $\widehat{CF\!A\!A}(\mathbf{AZ}_{\eta\theta})$ with those on $\mathcal{A}(\mathcal{Z})$. \square

Remark. One way to think about the module actions on $\widehat{CF\!A\!A}(\mathbf{AZ}_{\eta\theta})$ is as follows. Suppose \mathbf{x} and \mathbf{y} are generators such that the collection of right-endpoints of the segments $T_{x_i} \cap \{y = 4k + 1\}$ for $x_i \in \mathbf{x} = \{x_1, \dots, x_k\}$ coincides with the collection of left-endpoints of the segments $T_{y_j} \cap \{y = 4k + 1\}$ for $y_j \in \mathbf{y} = \{y_1, \dots, y_k\}$. In this case, there is a bijection $f : [k] \rightarrow [k]$ with the property that $T_{x_i} \cap T_{y_{f(i)}}$ is precisely the common vertex of the triangles T_{x_i} and $T_{y_{f(i)}}$ when $i = j$ and empty otherwise. Note that there is an unique (possibly empty) rectangular region R_i with the property that $T_{z_i} := T_{x_i} \cup T_{y_{f(i)}} \cup R_i$ is again a triangle. The product $\mathbf{x} \cdot \mathbf{y}$ is then precisely the collection of intersection points $\mathbf{z} = \{z_1, \dots, z_k\}$. One may verify that this coincides with the usual algebra structure on $\mathcal{A}(\mathcal{Z})$ under the above identification and with the left- and right-module structures under the identification from [LOT11].

We now define the map $m : \mathcal{A}_{\delta\varepsilon} \otimes_{\mathbb{F}} \mathcal{A}_{\gamma\delta} \rightarrow \mathcal{A}_{\gamma\varepsilon}$. Let Δ be a triangle with edges e_γ , e_δ , and e_ε , ordered clockwise, and let $e_{\eta\theta}$ be the unique point in $e_\eta \cap e_\theta$. Now let $W = \text{int}(\mathbf{AT}) \times \Delta$ and fix generators $\rho \in \mathfrak{S}(\mathbf{AZ}_{\delta\varepsilon})$, $\sigma \in \mathfrak{S}(\mathbf{AZ}_{\gamma\delta})$, and $\tau \in \mathfrak{S}(\mathbf{AZ}_{\gamma\varepsilon})$. Denote by $\pi_2(\rho, \sigma, \tau)$ the collection of all homology classes of maps $(S, \partial S) \rightarrow (W, \gamma \times e_\gamma \cup \delta \times e_\delta \cup \varepsilon \times e_\varepsilon)$, where S is a Riemann surface with boundary and boundary marked points $s_{\gamma\delta}$, $s_{\delta\varepsilon}$, and $s_{\varepsilon\gamma}$ such that $s_{\gamma\delta} \mapsto \rho$, $s_{\delta\varepsilon} \mapsto \sigma$, and $s_{\varepsilon\gamma} \mapsto \tau$. As in Section 10 of [Lip06], one may pick a sufficiently nice almost complex structure J on W so that, for each $A \in \pi_2(\rho, \sigma, \tau)$, the moduli space $\mathcal{M}^A(\rho, \sigma, \tau)$

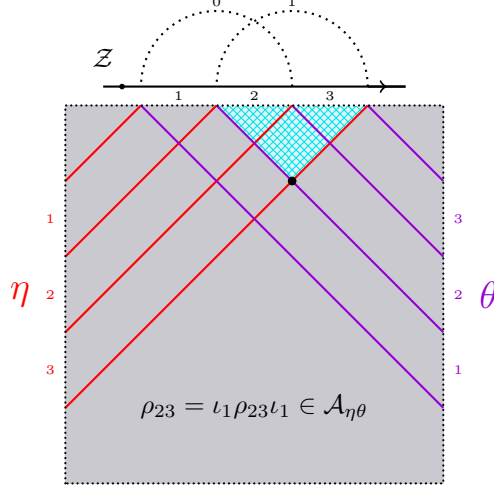

FIGURE 6. Identifying a generator $x \in \mathfrak{S}(\mathcal{AZ}_{\eta\theta})$ with the algebra element $\rho_{23} \in \mathcal{A}(\mathcal{Z})$. In $\mathcal{A}(-\mathcal{Z})$, this same generator is identified with ρ_{12} .

of embedded J -holomorphic curves $(S, \partial S) \xrightarrow{u} (W, \gamma \times e_\gamma \cup \delta \times e_\delta \cup \varepsilon \times e_\varepsilon)$ in the homology class A such that $u(s_{\gamma\delta}) = \rho$, $u(s_{\delta\varepsilon}) = \sigma$, and $u(s_{\varepsilon\gamma}) = \tau$ is a smooth manifold whose dimension is given by the Maslov index $\text{ind}(A)$ of A . We then define m on generators by

$$(13) \quad m(\rho \otimes \sigma) = \sum_{\tau \in \mathfrak{S}(\mathcal{AZ}_{\gamma\varepsilon})} \sum_{\text{ind}(A)=0} \#\mathcal{M}^A(\rho, \sigma, \tau)\tau.$$

Proposition 3.2 ([Aur10, Proposition 4.8]). *The map $m : \mathcal{A}_{\delta\varepsilon} \otimes_{\mathbb{F}} \mathcal{A}_{\gamma\delta} \rightarrow \mathcal{A}_{\gamma\varepsilon}$ coincides with the opposite multiplication map under the identification of each $\mathcal{A}_{\eta\theta}$ with $\mathcal{A}(\mathcal{Z})$.*

As noted in the introduction, we will be working over the algebra $\mathcal{A}(-\mathcal{Z})$. However, it is a standard fact that this algebra is isomorphic to $\mathcal{A}(\mathcal{Z})^{\text{op}}$. Indeed, one can identify the generators $\mathfrak{S}(\mathcal{AZ}_{\eta\theta})$ with the usual generators for $\mathcal{A}(-\mathcal{Z})$ in precisely the same way as we did for $\mathcal{A}(\mathcal{Z})$ with the sole exception that we draw \mathcal{Z} above $\mathcal{AZ}_{\eta\theta}$ oriented from right to left, rather than from left to right.

Corollary 3.3. *m coincides with the multiplication map $\mathcal{A}_{\gamma\delta} \otimes_{\mathbb{F}} \mathcal{A}_{\delta\varepsilon} \rightarrow \mathcal{A}_{\gamma\varepsilon}$ under the identification of $\mathcal{A}_{\eta\theta}$ with $\mathcal{A}(-\mathcal{Z})$.*

Remark. By construction, the map m counts only pseudoholomorphic triangles which do not meet the boundary of AT . One could instead count all rigid triangles in AT , in which case one would expect to see additional terms in m . However, Lemma 4.5 below tells us that these maps coincide. See [LOT16] for further details on pseudoholomorphic polygon maps in bordered Floer homology.

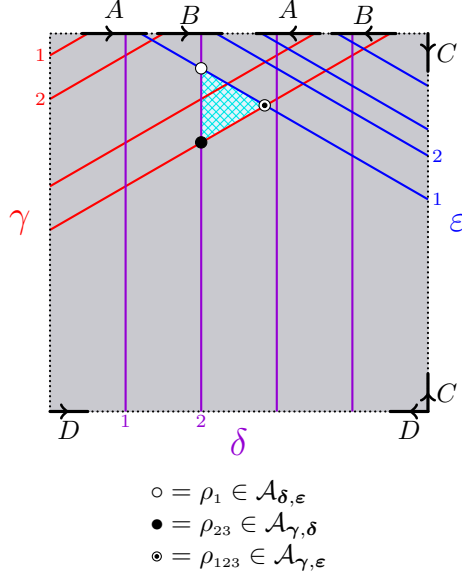

FIGURE 7. An embedded holomorphic triangle in $\text{AT}(\mathcal{Z})$ representing the multiplication $m^{\text{op}}(\rho_{23} \otimes \rho_1) = \rho_{123}$ in the algebra $\mathcal{A}(\mathcal{Z})^{\text{op}}$ or, equivalently, the multiplication $m(\rho_{12} \otimes \rho_3) = \rho_{123}$ in $\mathcal{A}(-\mathcal{Z})$, where \mathcal{Z} is the genus 1 pointed matched circle.

4. COMPOSITION AND TRIANGLE COUNTS

Definition 4.1. We say that $f \in \text{Mor}^{\mathcal{A}}(Y_1, Y_2)$ is a *basic morphism* if there are left-module generators $\mathbf{u} \in \widehat{\text{CFD}}(Y_1)$ and $\mathbf{v} \in \widehat{\text{CFD}}(Y_2)$ and an algebra element $\rho \in \mathcal{A}(-\mathcal{Z})$ such that $f(\mathbf{u}) = \rho \mathbf{v}$ and f vanishes on all other generators.

Lemma 4.1. *The set of basic morphisms forms an \mathbb{F} -basis for $\text{Mor}^{\mathcal{A}}(Y_1, Y_2)$.*

Proof. Let $\mathbf{u}_1, \dots, \mathbf{u}_m \in \widehat{\text{CFD}}(Y_1)$ and $\mathbf{v}_1, \dots, \mathbf{v}_n \in \widehat{\text{CFD}}(Y_2)$ be the generators for a given choice of bordered Heegaard diagrams for the Y_i . For $j = 1, \dots, m$, let $f_1^j, \dots, f_{s_j}^j$ be the distinct basic morphisms for which $f_i^j(\mathbf{u}_j) = \rho_{ij} \mathbf{v}_{k(i,j)}$ is nonzero. Suppose that there is a linear dependence

$$(14) \quad \sum_{i,j} c_{ij} f_i^j = 0$$

between them. For a given j , we then have a linear dependence

$$(15) \quad \sum_i c_{ij} f_i^j(\mathbf{u}_j) = \sum_i c_{ij} \rho_{ij} \mathbf{v}_{k(i,j)} = 0$$

but the $\rho_{ij} \mathbf{v}_{k(i,j)}$ are all distinct, hence \mathbb{F} -linearly independent, since the f_i^j are basic and distinct so $c_{ij} = 0$ for all i and j . Now given $g \in \text{Mor}^{\mathcal{A}}(Y_1, Y_2)$, write

$$(16) \quad g(\mathbf{u}_j) = \sum_i \sigma_{ij} \mathbf{v}_i.$$

For each i and j for which $\sigma_{ij}\mathbf{v}_i \neq 0$, one can then define a basic morphism $g_{i,j}$ by taking $g_{i,j}(\mathbf{u}_j) = \sigma_{ij}\mathbf{v}_i$ and $g_{i,j}(\mathbf{u}_k) = 0$ for $k \neq j$. We then have that

$$(17) \quad g = \sum_{i,j} g_{i,j}$$

by construction so the basic morphisms span $\text{Mor}^{\mathcal{A}}(Y_1, Y_2)$. \square

The identification

$$(18) \quad \text{Mor}^{\mathcal{A}}(Y_1, Y_2) \cong \widehat{\text{CFD}}(Y_1) \boxtimes \mathcal{A}(-\mathcal{Z}) \boxtimes \widehat{\text{CFD}}(Y_2)$$

can then be given in terms of basic morphisms as follows: suppose we have a basic morphism $f : \widehat{\text{CFD}}(Y_1) \rightarrow \widehat{\text{CFD}}(Y_2)$ defined by $f(\mathbf{u}) = \rho\mathbf{v}$, then f is sent under this isomorphism to the tensor product $\bar{\mathbf{u}} \boxtimes \rho \boxtimes \mathbf{v}$. If we have a second basic morphism $g : \widehat{\text{CFD}}(Y_2) \rightarrow \widehat{\text{CFD}}(Y_3)$ determined by $g(\mathbf{v}) = \sigma\mathbf{w}$, then the composition $g \circ f$ is given at the level of box tensor products by

$$(19) \quad (\bar{\mathbf{v}} \boxtimes \sigma \boxtimes \mathbf{w}) \circ (\bar{\mathbf{u}} \boxtimes \rho \boxtimes \mathbf{v}) = \bar{\mathbf{u}} \boxtimes \rho\sigma \boxtimes \mathbf{w},$$

so we may realize the composition map $f \otimes g \mapsto g \circ f$ explicitly in terms of the multiplication operation on $\mathcal{A}(\mathcal{Z})$ as:

$$(20) \quad \begin{aligned} & (\bar{\mathbf{u}} \boxtimes \rho \boxtimes \mathbf{v}) \otimes (\bar{\mathbf{v}} \boxtimes \sigma \boxtimes \mathbf{w}) \xrightarrow{ev} \bar{\mathbf{u}} \boxtimes \rho \boxtimes \bar{\mathbf{v}}(\mathbf{v}) \boxtimes \sigma \boxtimes \mathbf{w} \\ & = \bar{\mathbf{u}} \boxtimes \rho \boxtimes \iota_{\mathbf{v}} \boxtimes \sigma \boxtimes \mathbf{w} \xrightarrow{\cong} \bar{\mathbf{u}} \boxtimes \rho \boxtimes \sigma \boxtimes \mathbf{w} \xrightarrow{m} \bar{\mathbf{u}} \boxtimes \rho\sigma \boxtimes \mathbf{w}, \end{aligned}$$

where $ev : \widehat{\text{CFD}}(Y_2) \otimes_{\mathbb{F}} \widehat{\text{CFD}}(Y_2) \rightarrow \mathcal{A}$ is the evaluation map $\mathbf{x} \otimes h \mapsto h(\mathbf{x})$ and the map preceding $m^{\mathcal{A}}$ is given by the isomorphism $\mathcal{A} \boxtimes \mathcal{I} \boxtimes \mathcal{A} \cong \mathcal{A} \boxtimes \mathcal{A}$. Note that this penultimate step is possible because \mathbf{v} is a generator and the restriction of the evaluation map to the \mathbb{F} -vector subspace of $\widehat{\text{CFD}}(Y_2) \otimes_{\mathbb{F}} \widehat{\text{CFD}}(Y_2)$ spanned by elements of the form $\mathbf{v} \otimes \bar{\mathbf{v}}$, where \mathbf{v} is a generator as above, takes values in the subring \mathcal{I} of idempotents of $\mathcal{A}(\mathcal{Z})$.

4.1. Small perturbations. In this subsection, we show that a small perturbation of the β -circles of a bordered Heegaard diagram $\mathcal{H} = (\bar{\Sigma}, \boldsymbol{\alpha}, \boldsymbol{\beta}, z)$ induces an isomorphism of type- D modules. Let $(\bar{\Sigma}, \boldsymbol{\alpha}, \boldsymbol{\beta}, \boldsymbol{\gamma}, z)$ be a provincially admissible bordered Heegaard triple with one boundary component such that $\boldsymbol{\beta}$ and $\boldsymbol{\gamma}$ consist entirely of circles. Then $(\bar{\Sigma}, \boldsymbol{\beta}, \boldsymbol{\gamma}, z)$ is an admissible balanced sutured Heegaard diagram for the sutured 3-manifold $Y_{\beta\gamma} \setminus B^3$ with a single boundary suture. The corresponding sutured Floer complex $SFC(\bar{\Sigma}, \boldsymbol{\beta}, \boldsymbol{\gamma}, z)$ is isomorphic to the ordinary Heegaard Floer complex $\widehat{\text{CF}}(Y_{\beta\gamma})$ (cf. [Juh06, Proposition 9.1]). We may then define a type- D morphism

$$\hat{f}_{\alpha\beta\gamma} : \widehat{\text{CFD}}(Y_{\alpha\beta}) \otimes \widehat{\text{CF}}(Y_{\beta\gamma}) \rightarrow \mathcal{A} \otimes \widehat{\text{CFD}}(Y_{\alpha\gamma})$$

by

$$(21) \quad \hat{f}_{\alpha\beta\gamma}(\mathbf{x} \otimes \mathbf{y}) = \sum_{\mathbf{w} \in \mathfrak{S}(\boldsymbol{\alpha}, \boldsymbol{\gamma})} \sum_{B \in \pi_2(\mathbf{x}, \mathbf{y}, \mathbf{w})} a_{\mathbf{x}, \mathbf{y}, \mathbf{w}}^B \otimes \mathbf{w},$$

where

$$(22) \quad a_{\mathbf{x}, \mathbf{y}, \mathbf{w}}^B = \sum_{\bar{\rho} \mid \text{ind}(B, \rho) = 0} \#\mathcal{M}^B(\mathbf{x}, \mathbf{y}, \mathbf{w}; \bar{\rho}) a(-\bar{\rho}).$$

Here, $\pi_2(\mathbf{x}, \mathbf{y}, \mathbf{w})$ is the space of homology classes of Whitney triangles connecting \mathbf{x} , \mathbf{y} , and \mathbf{w} , $\mathcal{M}^B(\mathbf{x}, \mathbf{y}, \mathbf{z}; \vec{\rho})$ is the moduli space of pseudoholomorphic representatives of B with asymptotic condition $\vec{\rho}$ at east infinity, and $a(-\vec{\rho})$ is defined as before. The fact that $\widehat{f}_{\alpha\beta\gamma}$ is a morphism of type- D structures follows from a straightforward variation on the usual proof that $\partial^2 = 0$ for $\widehat{CFD}(Y)$. Alternatively, it is a special case of [LOT16, Proposition 4.29].

For β^1 a small Hamiltonian perturbation of β^0 , we will show that the map $\widehat{f}_{\alpha\beta^0\beta^1}$ induces an isomorphism $\widehat{CFD}(Y_{\alpha\beta^0}) \rightarrow \widehat{CFD}(Y_{\alpha\beta^1})$. We recall the following standard lemma [OS04, Lemma 9.10].

Lemma 4.2. *Let $F : A \rightarrow B$ be a map of \mathbb{R} -filtered groups admitting a decomposition $F = F_0 + \ell$ where F_0 is a filtration-preserving isomorphism and $\ell(\mathbf{x}) < F_0(\mathbf{x})$ for all generators \mathbf{x} . Then, if the filtration on B is bounded below, F is an isomorphism.*

We recall here the definition of the energy filtration on $\widehat{CFD}(\overline{\Sigma}, \alpha, \beta, z)$ from [LOT18, Chapter 6], assuming that $(\overline{\Sigma}, \alpha, \beta, z)$ is admissible. Choose an area form on $\overline{\Sigma}$. Given a $Spin^c$ -structure \mathfrak{s} on Y , define $\mathcal{F} : \mathfrak{S}(\overline{\Sigma}, \alpha, \beta, \mathfrak{s}) \rightarrow \mathbb{R}$ as follows: choose any generator $\mathbf{x}_0 \in \mathfrak{S}(\overline{\Sigma}, \alpha, \beta, \mathfrak{s})$ and set $\mathcal{F}(\mathbf{x}_0) = 0$. For any other generator $\mathbf{x} \in \mathfrak{S}(\overline{\Sigma}, \alpha, \beta, \mathfrak{s})$, choose $A_{\mathbf{x}_0, \mathbf{x}} \in \pi_2(\mathbf{x}_0, \mathbf{x})$ and let

$$(23) \quad \mathcal{F}(\mathbf{x}) = -\text{Area}(A_{\mathbf{x}_0, \mathbf{x}}).$$

This definition is independent of the choice of $A_{\mathbf{x}_0, \mathbf{x}}$ since $(\overline{\Sigma}, \alpha, \beta, z)$ is admissible. For an algebra element $a \in \mathcal{A}$ such that $a\mathbf{x} \neq 0$, define $\mathcal{F}(a\mathbf{x}) = \mathcal{F}(\mathbf{x})$. Then \mathcal{F} induces a filtration on $\widehat{CFD}(\overline{\Sigma}, \alpha, \beta, z)$.

Let $\mathcal{H}_{\alpha\beta} = (\overline{\Sigma}_g, \alpha, \beta^0, z)$ be an admissible genus g bordered Heegaard diagram. Provided β^1 is a sufficiently small perturbation of β^0 , we may identify $\mathbf{x} \in \mathfrak{S}(\overline{\Sigma}, \alpha, \beta^0, \mathfrak{s})$ with its ‘‘nearest neighbor’’ $\mathbf{x}^1 \in \mathfrak{S}(\overline{\Sigma}, \alpha, \beta^1, \mathfrak{s})$. This identification extends to a vector space isomorphism $\widehat{CFD}(\overline{\Sigma}, \alpha, \beta^0, z) \rightarrow \widehat{CFD}(\overline{\Sigma}, \alpha, \beta^1, z)$ — which then extends automatically to an isomorphism $\Psi_{0 \rightarrow 1}$ of type- D structures.

Note that if β^1 is a small perturbation of β^0 as above, then the homology of the complex $\widehat{CF}(\mathcal{H}_{\beta^0\beta^1})$ associated to the diagram $\mathcal{H}_{\beta^0\beta^1} = (\overline{\Sigma}_g, \beta^0, \beta^1, z)$ is given by $\widehat{HF}(\#^g S^2 \times S^1)$ since $\mathcal{H}_{\beta^0\beta^1}$ is an admissible balanced sutured Heegaard diagram for $\#^g S^2 \times S^1 \setminus B^3$.

Lemma 4.3. *Let $\Theta_{\beta^0\beta^1}^{\text{top}}$ denote the canonical top-dimensional homology class in $\widehat{HF}(\#^g S^2 \times S^1)$. Then the map $\widehat{F}_{\alpha\beta^0\beta^1}^{\text{top}} : \widehat{CFD}(\mathcal{H}_{\alpha\beta^0}) \rightarrow \mathcal{A} \otimes \widehat{CFD}(\mathcal{H}_{\alpha\beta^1})$ given by*

$$(24) \quad \mathbf{x} \mapsto \widehat{f}_{\alpha\beta^0\beta^1}(\mathbf{x} \otimes \Theta_{\beta^0\beta^1}^{\text{top}})$$

is an isomorphism of type- D structures. Moreover, this map is homotopic to the nearest point map.

Proof. Let $T_{\mathbf{x}} \in \pi_2(\mathbf{x}, \Theta_{\beta^0\beta^1}^{\text{top}}, \mathbf{x}^1)$ be the canonical smallest triangle, which has an unique holomorphic representative by the Riemann mapping theorem. Provided our perturbation is small enough, we may assume that the area of $T_{\mathbf{x}}$ is smaller than the areas of all classes in $\pi_2(\mathbf{x}, \mathbf{y})$ for any generators \mathbf{x} and \mathbf{y} in either $\mathfrak{S}(\overline{\Sigma}, \alpha, \beta^0, \mathfrak{s})$ or $\mathfrak{S}(\overline{\Sigma}, \alpha, \beta^1, \mathfrak{s})$. Moreover, we may choose the area form so that $T_{\mathbf{x}}$ is the unique triangle of minimal area connecting \mathbf{x} , \mathbf{y} , and $\Theta_{\beta^0\beta^1}^{\text{top}}$ among all $\mathbf{y} \in \mathfrak{S}(\overline{\Sigma}, \alpha, \beta^1)$. Let \mathcal{F}_0^1 be the filtration on $\widehat{CFD}(\overline{\Sigma}, \alpha, \beta^1, z)$ defined as above. Define a new

filtration \mathcal{F}^1 on $\widehat{CFD}(\overline{\Sigma}, \alpha, \beta^1, z)$ by taking $\mathcal{F}^1(\mathbf{x}^1) = \mathcal{F}_0^1(\mathbf{x}^1) - \text{Area}(T_{\mathbf{x}_0})$. As in [LOT18, Proposition 6.41], the map $\widehat{F}_{\alpha\beta^0\beta^1}^{\text{top}}$ is filtered with respect to \mathcal{F} and \mathcal{F}^1 and the filtration-preserving part of $\widehat{F}_{\alpha\beta^0\beta^1}^{\text{top}}$ is given by $\Psi_{0 \rightarrow 1}$. Note that we may promote $\widehat{F}_{\alpha\beta^0\beta^1}^{\text{top}}$ and $\Psi_{0 \rightarrow 1}$ to maps $\mathcal{A} \otimes \widehat{CFD}(\overline{\Sigma}, \alpha, \beta^0, z) \rightarrow \mathcal{A} \otimes \widehat{CFD}(\overline{\Sigma}, \alpha, \beta^1, z)$ of differential left \mathcal{A} -modules by taking $\widehat{F}_{\alpha\beta^0\beta^1}^{\text{top}}(a \otimes \mathbf{x}) = a\widehat{F}_{\alpha\beta^0\beta^1}^{\text{top}}(\mathbf{x})$ and similarly for $\Psi_{0 \rightarrow 1}$. Since $\Psi_{0 \rightarrow 1}$ is a vector space isomorphism, it follows from Lemma 4.2 that $\widehat{F}_{\alpha\beta^0\beta^1}^{\text{top}}$ is an isomorphism of differential left \mathcal{A} -modules and hence of type- D structures. One can easily adapt the argument given in [Gut22, Lemma 5.4] to show that $\widehat{F}_{\alpha\beta^0\beta^1}^{\text{top}}$ is homotopic to the nearest point map (cf. also [Lip06, Proposition 11.4]). \square

We now recall a few definitions and results about holomorphic polygons with Reeb chord asymptotics. Denote by D_n an n -gon, i.e. a disk with n labeled punctures on its boundary. Label the boundary arcs clockwise as e_0, \dots, e_{n-1} and let $p_{i,i+1}$ be the puncture between e_i and e_{i+1} . Define $\text{Conf}(D_n)$ to be the moduli space of positively-oriented complex structures on D_n up to labeling-preserving biholomorphisms. Recall that this space has a Deligne-Mumford compactification $\overline{\text{Conf}}(D_n)$ which is diffeomorphic to the associahedron and whose boundary $\partial\overline{\text{Conf}}(D_n)$ consists of trees of equivalence classes of complex structures on polygons with each edge representing a gluing of two polygons along a vertex.

Definition 4.2 ([LOT16, Definition 3.5]). For a fixed symplectic form ω_Σ on a Riemann surface Σ , an *admissible collection of almost-complex structures* is a choice of \mathbb{R} -invariant almost complex structure J on $\Sigma \times [0, 1] \times \mathbb{R}$ and a smooth family $\{J_j\}_{j \in \text{Conf}(D_n)}$ of almost complex structures on $\Sigma \times D_n$ for each $n \geq 3$ such that the following conditions hold:

- For each $j \in \text{Conf}(D_n)$, the projection $\pi_{\mathbb{D}} : \Sigma \times D_n \rightarrow D_n$ is (J_j, j) -holomorphic.
- For every $j \in \text{Conf}(D_n)$, the fibers of $\pi_{\mathbb{D}}$ are J_j -holomorphic.
- Every J_j is adjusted to the split symplectic form $\omega_\Sigma \oplus \omega_j$ on $\Sigma \times D_n$.
- Each J_j agrees with J near the punctures of D_n in the sense that every puncture has a strip-like neighborhood U in D_n such that $(\Sigma \times U, J_j|_{\Sigma \times U})$ and $(\Sigma \times [0, 1] \times (0, \infty), J)$ are biholomorphically equivalent.
- If (j_k) is a sequence in $\text{Conf}(D_n)$ converging to some point $j_\infty \in \partial\overline{\text{Conf}}(D_n)$ lying in the codimension-1 boundary stratum, i.e. a point $(j_{\infty,1}, j_{\infty,2}) \in \text{Conf}(D_{m+1}) \times \text{Conf}(D_{n-m+1})$ for some m , then the complex structures J_{j_k} converge to $J_{j_{\infty,1}} \sqcup J_{j_{\infty,2}}$ on $(\Sigma \times D_{m+1}) \sqcup (\Sigma \times D_{n-m+1})$. Convergence here is in the sense that, as $k \rightarrow \infty$, some arcs in D_{m+1} collapse and, over neighborhoods of these arcs, the complex structures J_{j_k} are obtained by inserting longer and longer necks the J_{j_k} converge in the C^∞ -topology outside of these neighborhoods. The analogous compatibility condition is required for points lying in higher codimension boundary strata.

Definition 4.3 ([LOT16, Definition 4.5]). Let $(\Sigma, \alpha, \beta^1, \dots, \beta^n, z)$ be an admissible bordered Heegaard multi-diagram in the sense of [LOT16, Definition 4.2], where α is a complete set of bordered attaching curves compatible with \mathcal{Z} . Let S be a punctured Riemann surface and $\{J_j\}_{j \in \text{Conf}(D_{n+1})}$ be an admissible collection of almost complex structures. Fix generators $\mathbf{x}^k \in \mathfrak{S}(\beta^k, \beta^{k+1})$ for $k = 1, \dots, n-1$

and $\mathbf{x}^0 \in \mathfrak{S}(\boldsymbol{\alpha}, \boldsymbol{\beta}^1)$, $\mathbf{x}^n \in \mathfrak{S}(\boldsymbol{\alpha}, \boldsymbol{\beta}^n)$, and let $q_i \in \partial D_{n+1}$ be points for $i = 1, \dots, k$. Consider maps of the form

$$(25) \quad u : (S, \partial S) \rightarrow (\Sigma \times D_{n+1}, (\boldsymbol{\alpha} \times e_0) \cup (\boldsymbol{\beta}^1 \times e_1) \cup \dots \cup (\boldsymbol{\beta}^n \times e_n))$$

such that the following hold:

- The projection map $\pi_\Sigma \circ u : S \rightarrow \Sigma$ has degree 0 at the region adjacent to the basepoint z .
- The punctures of S are mapped to the punctures $\{p_{i,i+1}\} \cup \{q_i\}$ of $D_{n+1} \setminus \{q_i\}$.
- The map u is asymptotic to $\mathbf{x}^i \times \{p_{i,i+1}\}$ at the preimage of $p_{i,i+1}$.
- u is asymptotic to $\boldsymbol{\rho}_i \times \{q_i\}$ at the punctures lying above q_i for some set $\boldsymbol{\rho}_i$ of Reeb chords in \mathcal{Z} .
- At each $q \in e_0 \setminus \{q_i\}$, the g points $(\pi_\Sigma \circ u)((\pi_{\mathbb{D}} \circ u)^{-1}(q))$ lie in g distinct α -curves. Equivalently, $\mathbf{x} \otimes a(\boldsymbol{\rho}_1) \otimes \dots \otimes a(\boldsymbol{\rho}_m)$ is nonzero, where tensor products are taken over the ring of idempotents in $\mathcal{A}(\mathcal{Z})$.

The set of maps of this type decomposes according to homology classes, the set of which we denote by $\pi_2(\mathbf{x}^n, \mathbf{x}^{n-1}, \dots, \mathbf{x}^0; \boldsymbol{\rho}_1, \dots, \boldsymbol{\rho}_m)$. For a fixed homology class $B \in \pi_2(\mathbf{x}^n, \mathbf{x}^{n-1}, \dots, \mathbf{x}^0; \boldsymbol{\rho}_1, \dots, \boldsymbol{\rho}_m)$, let

$$(26) \quad \mathcal{M}^B(\mathbf{x}^n, \mathbf{x}^{n-1}, \dots, \mathbf{x}^0; \boldsymbol{\rho}_1, \dots, \boldsymbol{\rho}_m; S)$$

denote the moduli space of pairs of the form (j, u) with $j \in \text{Conf}(D_{n+1})$ and u a J_j -holomorphic representative of B .

Lemma 4.4 ([LOT16, Lemma 4.7]). *The expected dimension of the moduli space $\mathcal{M}^B(\mathbf{x}^n, \mathbf{x}^{n-1}, \dots, \mathbf{x}^0; \boldsymbol{\rho}_1, \dots, \boldsymbol{\rho}_m; S)$ is given by $\text{ind}(B, S; \boldsymbol{\rho}_1, \dots, \boldsymbol{\rho}_m) + n - 2$, where*

$$(27) \quad \text{ind}(B, S; \boldsymbol{\rho}_1, \dots, \boldsymbol{\rho}_m) = \left(\frac{3-n}{2} \right) g - \chi(S) + 2e(B) + m,$$

where g is the genus of Σ and $e(B)$ is the Euler measure of B .

Remark. The same statement holds if the multidigraph has more than one boundary component, each of which meets exactly one set of bordered attaching curves.

The Euler measure $e(B)$ can be characterized as follows: if D is a surface with boundary and corners equipped with a metric h such that ∂D is geodesic and has right-angled corners, then $e(D)$ is $\frac{1}{2\pi}$ times the integral over D of the curvature of h . From this definition, one can see that $e(D)$ is linear with respect to disjoint union and gluing along boundary segments so, if B is a formal sum $B = \sum_i n_i D_i$ of elementary domains D_i , then $e(B) = \sum_i n_i e(D_i)$. It follows from the Gauß–Bonnet theorem that if D is a surface as above with k corners with angle $\frac{\pi}{2}$ and ℓ with angle $\frac{3\pi}{2}$, then

$$(28) \quad e(D) = \chi(D) - \frac{k}{4} + \frac{\ell}{4}.$$

In particular, for a k -gon D with convex corners, we have $e(D) = 1 - \frac{k}{4}$. Now suppose that h is instead an arbitrary metric on D and that ∂D decomposes as $\partial D = c_1 \cup \dots \cup c_k$. Parametrize each boundary segment c_i by $[0, 1]$. For each $i = 1, \dots, k$, let θ_i be the angle by which the tangent vector to ∂D turns at the i^{th} corner $c_i(0)$, i.e. π minus the interior angle of D at $c_i(0)$, and define $t_i = \frac{\theta_i}{2\pi} - \frac{1}{4}$. A

second application of the Gauß–Bonnet theorem allows us to rewrite $e(D)$ as

$$(29) \quad e(D) = \frac{1}{2\pi} \left(\int_D K dA + \sum_{i=1}^k \int_{c_i} \kappa_h ds \right) + \sum_{i=1}^k t_i,$$

where K and κ_h are the curvature and geodesic curvature of h , respectively. Therefore, if h is flat and D has geodesic boundary, we may then compute $e(D)$ by summing the contributions t_i from each corner. In particular, corners with interior angles of 60-, 90-, and 120-degrees contribute $+\frac{1}{12}$, 0, and $-\frac{1}{12}$, respectively, to the Euler measure of a flat polygon with geodesic boundary. We will use this fact momentarily.

In the case of triangles we have $n = 2$ so the dimension of the moduli space $\mathcal{M}^B(\mathbf{x}^2, \mathbf{x}^1, \mathbf{x}^0; \boldsymbol{\rho}_1, \dots, \boldsymbol{\rho}_m; S)$ is given exactly by $\text{ind}(B, S; \boldsymbol{\rho}_1, \dots, \boldsymbol{\rho}_m)$, which we may write more succinctly as

$$(30) \quad \text{ind}(B, S; \boldsymbol{\rho}_1, \dots, \boldsymbol{\rho}_m) = \frac{g}{2} - \chi(S) + 2e(B) + m.$$

Lemma 4.5. *There are no positive domains for index zero holomorphic triangles in AT meeting ∂AT and having corners cyclically ordered according to $(\gamma \cap \delta, \delta \cap \varepsilon, \gamma \cap \varepsilon)$.*

Proof. We choose a metric on AT which is flat everywhere except on the component of $\text{AT} \setminus (\gamma \cup \delta \cup \varepsilon)$ containing \mathbf{z} . Moreover we choose this metric so that every γ -, δ -, and ε -curve is geodesic and every intersection of two such curves occurs at 60 and 120 degree angles, the boundary components of AT are geodesic, and, for every $\eta \in \{\gamma, \delta, \varepsilon\}$, each η -curve meets ∂AT at the same angle: 120 degrees for the γ -curves, 90 degrees for the δ -curves, and 30 degrees for the ε -curves. To see that we can choose such a metric, note that the square \square_k inherits a metric from its inclusion into the plane which descends to a metric on AT which is flat except on the region containing \mathbf{z} . Since the boundary of \square_k is geodesic, it follows that ∂AT is geodesic. To see that every γ -, δ -, and ε -curve is geodesic and have the specified intersection angles, recall that we chose a particular modification of AT so that these curves arise from pairs g_i , d_i , and e_i of straight lines making an angle of 150 degrees, 90 degrees, and 30 degrees with the positive horizontal direction, respectively. Since the perturbations necessary to obtain the curves in AT can be achieved by planar translations of the lines in \mathbb{R}^2 corresponding to the pairs g_i and e_i , it follows that the γ -, δ -, and ε -curves are obtained as quotients of pairs of straight line segments with the same angle and hence are geodesic. The choice of angles of these segments guarantees that each of the intersections in AT occurs in one of the specified angles.

Suppose that B is a positive domain for an index zero holomorphic triangle in AT which has the above cyclic ordering on its corners and which does not meet the component of $\text{AT} \setminus (\gamma \cup \delta \cup \varepsilon)$ containing \mathbf{z} . As in the proof of [Aur10, Proposition 3.5], the Euler measure of B can be computed by summing the contributions from its corners because ∂B is geodesic: $+\frac{1}{12}$ for every corner with a 60-degree angle, 0 for every corner with a 90-degree angle, and $-\frac{1}{12}$ for every corner with a 120-degree angle. If p is an interior intersection point of two of the collections of curves in AT and B hits p at an interior point, then the local multiplicities of B in the four elementary domains meeting p are all equal so the local contribution of p to the Euler measure is zero. If B hits p at a point on the boundary which is not a corner, then B hits two of the four regions meeting at p . One of these regions meets p at a 60-degree angle and the other meets it at a 120-degree angle so the local

contributions to the Euler measure cancel. If p is a genuine corner of B , then the cyclic ordering of the corners forces one of two scenarios: either B locally hits a region with a 60-degree angle at p or B locally hits two regions with a 60-degree angle at p and one with a 120-degree angle at p . In either of these two cases, the local contribution of such a corner is $+\frac{1}{12}$.

Now, if $p \in \eta \cap \partial \text{AT}$ for some $\eta \in \{\gamma, \delta, \varepsilon\}$, then there are two cases that we need to account for. Suppose, for the moment, that B meets exactly one Reeb chord ρ in the η -boundary of AT . If p is contained in the interior of ρ , then the local multiplicities of B in the two regions meeting p are equal so the local contribution to the Euler measure is zero. Otherwise, p is an end of ρ , in which case there is a boundary intersection point q with $\partial \rho = \{p, q\}$ and the local contributions of these two corners to the Euler measure cancel since B meets p and q at complementary angles. In general, B could meet multiple boundary Reeb chords in which case the sum of the local contributions of the ends of all of the Reeb chords is zero since we can decompose this as a sum of single Reeb chord terms.

Summing over the $3g$ interior corners and all of the boundary Reeb chords of B , we see that $e(B) = \frac{g}{4}$ so, consequently, we have

$$(31) \quad \text{ind}(B, S; \rho_1, \dots, \rho_m) = g - \chi(S) + m.$$

For rigid triangles, this then tells us that $\chi(S) = g + m$ but S has at most g connected components so $\chi(S) \leq g$. Therefore, if B is a class represented by a rigid holomorphic triangle, then we must have $m = 0$, i.e. B does not meet the boundary of AT . \square

Let $\mathcal{H}_i = (\bar{\Sigma}_i, \boldsymbol{\eta}_i, \boldsymbol{\beta}_i, z)$ be admissible bordered Heegaard diagrams for Y_i , $i = 1, 2, 3$, where $\eta_i = \gamma, \delta, \varepsilon$ according to the ordering $\gamma < \delta < \varepsilon$. Let $\mathcal{H}_i^+ = (\bar{\Sigma}_i, \boldsymbol{\eta}_i, \boldsymbol{\beta}_i^0, \boldsymbol{\beta}_i^1, z)$ be the result of creating a single parallel copy of each $\boldsymbol{\beta}$ -circle and performing a finger move to create two intersection points between the resulting parallel pairs. Finally, let $\text{AT}_{1,2,3} = \text{AT}(\mathcal{H}_1, \mathcal{H}_2, \mathcal{H}_3)$ be the result of gluing \mathcal{H}_1^+ , \mathcal{H}_2^+ , and \mathcal{H}_3^+ along the γ -, δ -, and ε -boundaries of $\text{AT}(\mathcal{Z})$.

Proposition 4.6. *If \mathcal{H}_2 is admissible, the dg-bimodule homomorphism*

$$(32) \quad F_{\delta, \delta} : \mathcal{A}_{\gamma, \delta} \boxtimes \widehat{\text{CFD}}(\boldsymbol{\delta}, \boldsymbol{\beta}_2^0) \otimes \widehat{\text{CFD}}(\boldsymbol{\delta}, \boldsymbol{\beta}_2^1) \boxtimes \mathcal{A}_{\delta, \varepsilon} \rightarrow \mathcal{A}_{\gamma, \varepsilon}$$

defined by counting triangles in $\text{AT} \cup_{\delta} \mathcal{H}_2^+$ with one corner at the bottom-graded generator of $\widehat{\text{CF}}(\boldsymbol{\beta}_2^0, \boldsymbol{\beta}_2^1)$ is given up to homotopy by the map

$$(33) \quad \rho \boxtimes \mathbf{u}^0 \otimes \bar{\mathbf{v}}^1 \boxtimes \sigma \mapsto \rho \bar{\mathbf{v}}^1(\mathbf{u}^1)\sigma,$$

where we regard $\bar{\mathbf{v}}^1$ as a map from $\widehat{\text{CFD}}(\boldsymbol{\delta}, \boldsymbol{\beta}_2^1)$ to the ring of idempotents \mathcal{I} in \mathcal{A} .

Proof. By definition, we have

$$(34) \quad F_{\delta, \delta}(\rho \boxtimes \mathbf{u}^0 \otimes \bar{\mathbf{v}}^1 \boxtimes \sigma) = \sum_{\tau \in \mathfrak{S}(\text{AZ}_{\gamma, \varepsilon})} \sum_{\text{ind}(C)=0} \#\mathcal{M}^C(\rho \boxtimes \mathbf{u}^0, \bar{\mathbf{v}}^1 \boxtimes \sigma, \tau \otimes \Theta_{\beta_2^0 \beta_2^1}^{\text{bot}})\tau,$$

where C ranges over $\pi_2(\rho \boxtimes \mathbf{u}^0, \bar{\mathbf{v}}^1 \boxtimes \sigma, \tau \otimes \Theta_{\beta_2^0 \beta_2^1}^{\text{bot}})$ and $\mathcal{M}^C(\rho \boxtimes \mathbf{u}^0, \bar{\mathbf{v}}^1 \boxtimes \sigma, \tau \otimes \Theta_{\beta_2^0 \beta_2^1}^{\text{bot}})$ is the moduli space of pseudoholomorphic representatives of the class C . By the pairing theorem for triangles [LOT16, Proposition 5.35], this map is homotopic to the one given by counting rigid triangles paired with sequences of bigons. Since there are no positive domains of rigid holomorphic triangles in AT which meet

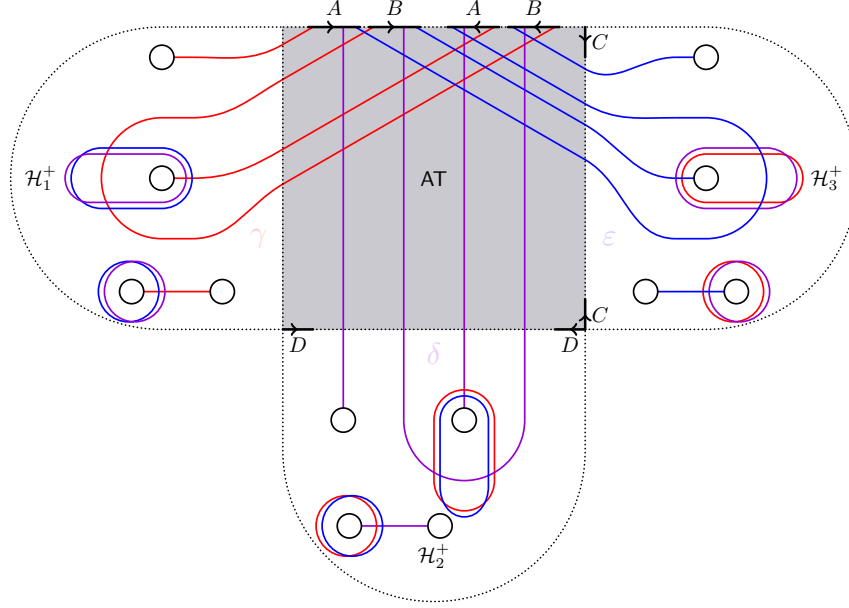
FIGURE 8. An example of an $\text{AT}_{1,2,3}$ obtained by gluing triples to $\text{AT}(\mathcal{Z})$.

the boundary by Lemma 4.5, and because \mathcal{H}_2^+ is obtained by a small Hamiltonian translation, this tells us that $F_{\delta,\delta}$ is homotopic to the map

$$(35) \quad \rho \boxtimes \mathbf{u}^0 \otimes \bar{\mathbf{v}}^1 \boxtimes \sigma \mapsto \sum_{\tau \in \mathfrak{S}(\text{AZ}_{\gamma,\varepsilon})} \sum_{\text{ind}(C)=0} \# \mathcal{M}_{\times}^C(\rho, \sigma, \tau, \mathbf{u}^0, \bar{\mathbf{v}}^1, \Theta_{\beta_2^0 \beta_2^1}^{\text{bot}}) \tau,$$

where the moduli space $\mathcal{M}_{\times}^C(\rho, \sigma, \tau, \mathbf{u}^0, \bar{\mathbf{v}}^1, \Theta_{\beta_2^0 \beta_2^1}^{\text{bot}})$ is defined by

$$(36) \quad \mathcal{M}_{\times}^C(\rho, \sigma, \tau, \mathbf{u}^0, \bar{\mathbf{v}}^1, \Theta_{\beta_2^0 \beta_2^1}^{\text{bot}}) = \bigsqcup_{A+B=C} \mathcal{M}^A(\rho, \sigma, \tau) \times \mathcal{M}^B(\mathbf{u}^0, \bar{\mathbf{v}}^1, \Theta_{\beta_2^0 \beta_2^1}^{\text{bot}}),$$

where A and B are provincial domains in AT and \mathcal{H}_2^+ , respectively. Here, $\mathcal{M}^A(\rho, \sigma, \tau)$ is the moduli space of rigid pseudoholomorphic triangles of class A from $\rho \otimes \sigma$ to τ and $\mathcal{M}^B(\mathbf{u}^0, \bar{\mathbf{v}}^1, \Theta_{\beta_2^0 \beta_2^1}^{\text{bot}})$ is the moduli space of rigid provincial triangles from $\mathbf{u}^0 \otimes \bar{\mathbf{v}}^1$ to $\Theta_{\beta_2^0 \beta_2^1}^{\text{bot}}$ representing the class B . Note that this latter moduli space is empty unless \mathbf{u}^0 and $\bar{\mathbf{v}}^1$ have the same left-idempotent ι^{01} , which is then necessarily also the right-idempotent for ρ and the left-idempotent for σ in order for $\rho \boxtimes \mathbf{u}^0 \otimes \bar{\mathbf{v}}^1 \boxtimes \sigma$ to be nonzero. Together with additivity of the embedded index for disjoint unions and the fact that the index of a class with a pseudoholomorphic representative is non-negative, this then implies that

$$(37) \quad \begin{aligned} & F_{\delta,\delta}(\rho \boxtimes \mathbf{u}^0 \otimes \bar{\mathbf{v}}^1 \boxtimes \sigma) \\ & \simeq \sum_{\tau \in \mathfrak{S}(\text{AZ}_{\gamma,\varepsilon})} \sum_{\text{ind}(A)=\text{ind}(B)=0} \# \mathcal{M}^A(\rho, \sigma, \tau) \# \mathcal{M}^B(\mathbf{u}^0, \bar{\mathbf{v}}^1, \Theta_{\beta_2^0 \beta_2^1}^{\text{bot}}) \tau. \end{aligned}$$

However, this gives us

$$(38) \quad F_{\delta,\delta}(\rho \boxtimes \mathbf{u}^0 \otimes \bar{\mathbf{v}}^1 \boxtimes \sigma) \simeq \left(\sum_{\text{ind}(B)=0} \# \mathcal{M}^B(\mathbf{u}^0, \bar{\mathbf{v}}^1, \Theta_{\beta_2^0 \beta_2^1}^{\text{bot}}) \right) \sum_{\tau \in \mathfrak{S}(\text{AZ}_{\gamma,\varepsilon})} \sum_{\text{ind}(A)=0} \# \mathcal{M}^A(\rho, \sigma, \tau) \tau,$$

and the map

$$(39) \quad \rho \otimes \sigma \mapsto \sum_{\tau \in \mathfrak{S}(\text{AZ}_{\gamma,\varepsilon})} \sum_{\text{ind}(A)=0} \# \mathcal{M}^A(\rho, \sigma, \tau) \tau$$

is precisely the multiplication map $\mathcal{A} \otimes \mathcal{A} \rightarrow \mathcal{A}$ by [Aur10, Proposition 4.8]. We then have

$$(40) \quad F_{\delta,\delta}(\rho \boxtimes \mathbf{u}^0 \otimes \bar{\mathbf{v}}^1 \boxtimes \sigma) \simeq \rho \left(\sum_B \# \mathcal{M}^B(\mathbf{u}^0, \bar{\mathbf{v}}^1, \Theta_{\beta_2^0 \beta_2^1}^{\text{bot}}) \iota^0 \iota^1 \right) \sigma,$$

where ι^0 is the left-idempotent for \mathbf{u}^0 and ι^1 is the right-idempotent for $\bar{\mathbf{v}}^1$, which we may insert at no cost since the space $\mathcal{M}^B(\mathbf{u}^0, \bar{\mathbf{v}}^1, \Theta_{\beta_2^0 \beta_2^1}^{\text{bot}})$ of provincial triangles is empty unless $\iota^0 = \iota^1 = \iota^{01}$, in which case we have $\rho\sigma = \rho\iota^{01}\sigma$. We claim that the map $L : \widehat{\text{CFD}}(\delta, \beta_2^0) \otimes \widehat{\text{CFD}}(\delta, \beta^1) \rightarrow \mathcal{A}$ given by

$$(41) \quad \mathbf{u}^0 \otimes \bar{\mathbf{v}}^1 \mapsto \sum_{\text{ind}(B)=0} \# \mathcal{M}^B(\mathbf{u}^0, \mathbf{v}^1, \Theta_{\beta_2^0 \beta_2^1}^{\text{bot}}) \iota^0 \iota^1$$

is homotopic to the perturbed evaluation map $ev \circ (\Psi_{0 \rightarrow 1} \otimes \mathbb{I})$ given on generators by

$$(42) \quad \mathbf{u}^0 \otimes \bar{\mathbf{v}}^1 \mapsto \bar{\mathbf{v}}^1(\mathbf{u}^1).$$

However, L is dual to the type- D morphism $R : \widehat{\text{CFD}}(\delta, \beta_2^0) \rightarrow \mathcal{A} \otimes \widehat{\text{CFD}}(\delta, \beta^1)$ given by

$$(43) \quad \mathbf{u}^0 \mapsto \sum_{\mathbf{v}^1 \in \mathfrak{S}(\delta, \beta_2^1)} \sum_{\text{ind}(B)=0} \# \mathcal{M}^B(\mathbf{u}^0, \Theta_{\beta_2^0 \beta_2^1}^{\text{top}}, \mathbf{v}^1) \iota^0 \iota^1 \otimes \mathbf{v}^1$$

which is filtered with respect to the filtrations \mathcal{F} and \mathcal{F}^1 defined in Lemma 4.3. As a filtered map, this has filtration preserving part given by $\Psi_{0 \rightarrow 1}$ since $\Psi_{0 \rightarrow 1}$ is a summand of R and R is a summand of $\widehat{F}_{\delta \beta_2^0 \beta_2^1}^{\text{top}}$. This implies that R is an isomorphism and the same neck-stretching argument used in [Gut22, Lemma 5.4] to show that $\widehat{F}_{\delta \beta_2^0 \beta_2^1}^{\text{top}}$ is homotopic to $\Psi_{0 \rightarrow 1}$ can be used to show that R is homotopic to $\Psi_{0 \rightarrow 1}$. Such a homotopy then induces a homotopy between the corresponding dual maps. Since the dual of $\Psi_{0 \rightarrow 1}$ is $ev \circ (\Psi_{0 \rightarrow 1} \otimes \mathbb{I})$, this proves the desired result. \square

Theorem 4.7. *Let*

$$(44) \quad \widehat{G}_{\text{AT}} : \text{Mor}^{\mathcal{A}}(Y_1, Y_2) \otimes_{\mathbb{F}} \text{Mor}^{\mathcal{A}}(Y_2, Y_3) \rightarrow \text{Mor}^{\mathcal{A}}(Y_1, Y_3)$$

be the composite

$$(45) \quad \begin{array}{ccc} \text{Mor}^{\mathcal{A}}(Y_1, Y_2) \otimes_{\mathbb{F}} \text{Mor}^{\mathcal{A}}(Y_2, Y_3) & \xrightarrow{\widehat{G}_{\text{AT}}} & \text{Mor}^{\mathcal{A}}(Y_1, Y_3) \\ \cong \downarrow & & \uparrow \cong \\ \widehat{\text{CF}}(\mathcal{H}_1 \cup \mathcal{H}_2) \otimes_{\mathbb{F}} \widehat{\text{CF}}(\mathcal{H}_2 \cup \mathcal{H}_3) & & \widehat{\text{CF}}(\mathcal{H}_1 \cup \mathcal{H}_3) \\ \text{1-handle} \downarrow & & \uparrow \text{3-handle} \\ (\widehat{\text{CF}}(\mathcal{H}_1 \cup \mathcal{H}_2) \otimes V^{\otimes g_3}) \otimes_{\mathbb{F}} (\widehat{\text{CF}}(\mathcal{H}_2 \cup \mathcal{H}_3) \otimes V^{\otimes g_1}) & \xrightarrow{\widehat{F}_{\text{AT}_{1,2,3}}} & \widehat{\text{CF}}(\mathcal{H}_1 \cup \mathcal{H}_3) \otimes V^{\otimes g_2} \end{array}$$

where we take the model $\widehat{\text{CFD}}(\mathcal{H}_i) \boxtimes \mathcal{A} \boxtimes \widehat{\text{CFD}}(\mathcal{H}_j)$ for $\widehat{\text{CF}}(\mathcal{H}_i \cup \mathcal{H}_j)$, the vertical isomorphisms are the ones described above, V is the two-dimensional model for $\widehat{\text{CF}}(S^2 \times S^1)$ given by the usual genus 1 Heegaard diagram for $S^2 \times S^1$, $\widehat{F}_{\text{AT}_{1,2,3}}$ is the map determined by the Heegaard triple $\text{AT}_{1,2,3}$, and

$$\widehat{\text{CF}}(Y) \xrightarrow{\text{1-handle}} \widehat{\text{CF}}(Y) \otimes V^{\otimes m} \cong \widehat{\text{CF}}(Y \# (S^2 \times S^1)^{\#m})$$

and

$$\widehat{\text{CF}}(Y) \otimes V^{\otimes n} \cong \widehat{\text{CF}}(Y \# (S^2 \times S^1)^{\#n}) \xrightarrow{\text{3-handle}} \widehat{\text{CF}}(Y)$$

are the usual 1-handle and 3-handle maps defined on generators by

$$\mathbf{x} \mapsto \mathbf{x} \otimes \Theta^{\text{top}}$$

and

$$(46) \quad \mathbf{y} \otimes \theta \mapsto \begin{cases} \mathbf{y} & \text{if } \theta = \Theta^{\text{bot}} \\ 0 & \text{else,} \end{cases}$$

respectively, where Θ^{bot} is the bottom-graded generator. Then \widehat{G}_{AT} agrees up to homotopy with the composition map $f \otimes g \mapsto g \circ f$.

Proof. We assume that each of the bordered Heegaard triples $\mathcal{H}_i^+ = (\overline{\Sigma}_i, \boldsymbol{\eta}, \boldsymbol{\beta}_i^0, \boldsymbol{\beta}_i^1)$ are obtained by suitable small Hamiltonian perturbations so that Lemma 4.3 applies. By construction and the pairing theorem for triangles [LOT16, Proposition 3.35], we have a decomposition $\widehat{G}_{\text{AT}} \simeq \widehat{F}_{\gamma\beta_1^1\beta_1^0}^{\text{top}} \boxtimes F_{\delta,\delta} \boxtimes \widehat{F}_{\varepsilon\beta_3^0\beta_3^1}^{\text{top}}$ under the identifications $\text{Mor}^{\mathcal{A}}(Y_i, Y_j) \cong \widehat{\text{CFD}}(Y_i) \boxtimes \mathcal{A} \boxtimes \widehat{\text{CFD}}(Y_j)$. Since the maps $\widehat{F}_{\gamma\beta_1^1\beta_1^0}^{\text{top}}$ and $\widehat{F}_{\varepsilon\beta_3^0\beta_3^1}^{\text{top}}$ are homotopic to the corresponding nearest point maps, Proposition 4.6 then tells us that \widehat{G}_{AT} is homotopic to the map given on basic morphisms by

$$(47) \quad (\bar{\mathbf{t}}^1 \boxtimes \rho \boxtimes \mathbf{u}^0) \otimes (\bar{\mathbf{v}}^1 \boxtimes \sigma \boxtimes \mathbf{w}^0) \mapsto \bar{\mathbf{t}}^0 \boxtimes \rho \bar{\mathbf{v}}^1(\mathbf{u}^1) \sigma \boxtimes \mathbf{w}^1,$$

which is precisely the composition map. \square

Corollary 4.8. *Suppose that \mathcal{H}_1 and \mathcal{H}'_1 are bordered Heegaard diagrams for a bordered 3-manifold Y_1 differing by a single bordered Heegaard move, then the square*

$$(48) \quad \begin{array}{ccc} \text{Mor}^{\mathcal{A}}(\mathcal{H}_1, \mathcal{H}_2) \otimes \text{Mor}^{\mathcal{A}}(\mathcal{H}_2, \mathcal{H}_3) & \xrightarrow{f \otimes g \mapsto g \circ f} & \text{Mor}^{\mathcal{A}}(\mathcal{H}_1, \mathcal{H}_3) \\ \simeq \downarrow & & \downarrow \simeq \\ \text{Mor}^{\mathcal{A}}(\mathcal{H}'_1, \mathcal{H}_2) \otimes \text{Mor}^{\mathcal{A}}(\mathcal{H}_2, \mathcal{H}_3) & \xrightarrow{f \otimes g \mapsto g \circ f} & \text{Mor}^{\mathcal{A}}(\mathcal{H}'_1, \mathcal{H}_3) \end{array}$$

commutes up to homotopy, where the vertical maps are given by the homotopy equivalences $\text{Mor}^A(\mathcal{H}_1, \mathcal{H}_i) \rightarrow \text{Mor}^A(\mathcal{H}'_1, \mathcal{H}_i)$ induced by the Heegaard move. The analogous statement also holds for \mathcal{H}_2 and \mathcal{H}_3 .

Proof. In the case of finger moves and handleslides, this follows from Theorem 4.7 by associativity of triangle counts. In the case of stabilizations, up to some number of finger moves and handleslides, one may assume that the stabilization is performed in a neighborhood of the basepoint, in which case the vertical maps are isomorphisms. \square

5. 4-MANIFOLDS WITH CORNERS FROM BORDERED HEEGAARD TRIPLES

Just as one may represent a 4-manifold with boundary by a closed Heegaard triple and bordered 3-manifolds may be represented using (arced) bordered Heegaard diagrams [LOT18], we may describe 4-manifolds with boundary and corners using a suitable amalgamation of the two notions.

Definition 5.1. A genus g arced bordered Heegaard triple with B boundary components is a quintuple $\mathcal{H} = (\bar{\Sigma}, \gamma, \delta, \varepsilon, \mathbf{z})$, where:

- $\bar{\Sigma}$ is a compact connected surface of genus g with boundary components $\partial_1 \bar{\Sigma}, \dots, \partial_B \bar{\Sigma}$
- each $\boldsymbol{\eta} \in \{\boldsymbol{\alpha}, \boldsymbol{\beta}, \boldsymbol{\gamma}\}$ is a pairwise disjoint collection

$$\boldsymbol{\eta} = \{\eta_1^c, \dots, \eta_{g-T_\eta}^c\} \cup \bigcup_{i=1}^B \{\eta_1^i, \dots, \eta_{2t_i^\eta}^i\},$$

where $T_\eta = \sum_{i=1}^B t_i^\eta$, consisting of embedded arcs η_j^i in $\bar{\Sigma}$ with boundary on $\partial_i \bar{\Sigma}$ and circles η_k^c in the interior of $\bar{\Sigma}$. We further impose the condition that if $t_i^\eta \neq 0$, then $t_i^\theta = 0$ for $\theta \neq \boldsymbol{\eta}$. In other words, this condition says that no two collections of curves meet the same boundary component nontrivially. For the sake of convenience, we denote the collection $\{\eta_1^c, \dots, \eta_{g-T_\eta}^c\}$ by $\boldsymbol{\eta}^c$ and the collections $\{\eta_1^i, \dots, \eta_{2t_i^\eta}^i\}$ by $\boldsymbol{\eta}^i$.

- $\mathbf{z} = (z; s_1, \dots, s_b)$ consists of an interior point $z \in \bar{\Sigma}$ disjoint from $\gamma \cup \delta \cup \varepsilon$ together with embedded arcs s_i in $\bar{\Sigma} \setminus (\gamma \cup \delta \cup \varepsilon)$ connecting z and $\partial_i \bar{\Sigma}$.

We also require that each of $\bar{\Sigma} \setminus \gamma$, $\bar{\Sigma} \setminus \delta$, and $\bar{\Sigma} \setminus \varepsilon$ is connected and that the collections γ , δ , and ε intersect pairwise transversely. Lastly, we require that each component of $\partial \bar{\Sigma}$ is met by some $\boldsymbol{\eta}$. If $\boldsymbol{\eta}^i$ is the collection of arcs meeting $\partial_i \bar{\Sigma}$ nontrivially, we will denote the induced (as in Lemma 4.4 of [LOT18]) pointed matched circle by $\mathcal{Z}_i(\mathcal{H})$ or simply by \mathcal{Z}_i when there is no risk of ambiguity.

Note that, for any two distinct collections $\boldsymbol{\eta}, \boldsymbol{\theta} \in \{\boldsymbol{\alpha}, \boldsymbol{\beta}, \boldsymbol{\gamma}\}$, forgetting the third collection, filling in the now-empty boundary components with disks, and forgetting the arcs s_{i_1}, \dots, s_{i_f} which meet the filled boundary components, yields an arced bordered Heegaard diagram $\mathcal{H}^{\boldsymbol{\eta}, \boldsymbol{\theta}} = (\bar{\Sigma}_{\boldsymbol{\eta}, \boldsymbol{\theta}}, \boldsymbol{\eta}, \boldsymbol{\theta}, \mathbf{z}_{\boldsymbol{\eta}, \boldsymbol{\theta}})$. Such a diagram determines a (strongly bordered) 3-manifold $Y_{\boldsymbol{\eta}, \boldsymbol{\theta}} = Y(\mathcal{H}^{\boldsymbol{\eta}, \boldsymbol{\theta}})$ with $B - f$ boundary components by attaching 2-handles to $\bar{\Sigma}_{\boldsymbol{\eta}, \boldsymbol{\theta}} \times [0, 1]$, analogous to [LOT15, Constructions 5.3 and 5.6]. From an arced bordered Heegaard triple \mathcal{H} , we will define a 4-manifold $X(\mathcal{H})$ with connected boundary and corners.

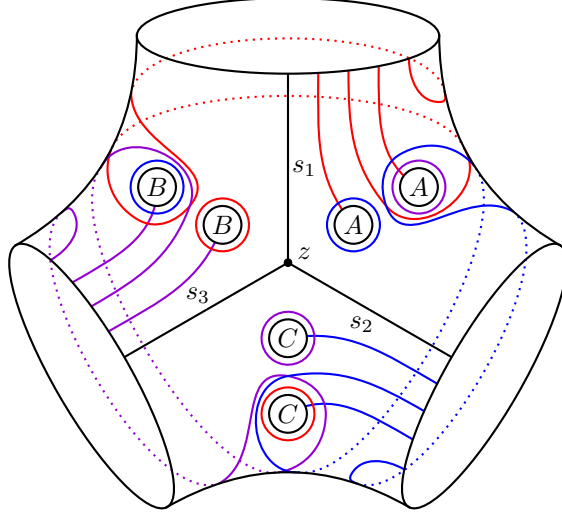
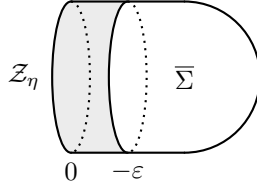

FIGURE 9. A genus 3 bordered Heegaard triple \mathcal{H} with three boundary components.

Remark. One could more generally allow bordered Heegaard triples \mathcal{H} whose arcs connect multiple boundary components, in which case $\partial X(\mathcal{H})$ is a bordered sutured 3-manifold with corners following constructions analogous to those given by Zarev in [Zar11]. However, we will not explore this construction here; we content ourselves to only consider the case $B \leq 3$.

In addition to $Y_{\eta\theta}$, the arced bordered Heegaard diagram $\mathcal{H}^{\eta,\theta}$ specifies preferred disks $\Delta_j \subset \partial_j Y_{\eta\theta}$, which are obtained as the images in $Y_{\eta\theta}$ of the “faces” of the 2-handles attached in the last step of the above construction, points $z_j \in \partial\Delta_j$ coming from the endpoints of $z_{\eta,\theta}$, and homeomorphisms of triples $\phi_i : (F(\mathcal{Z}_j), D_j, z_j) \rightarrow (\partial_j Y_{\eta\theta}, \Delta_j, z_j)$ for each $j \neq i_1, \dots, i_f$, and an isotopy class $\nu_{\eta,\theta}$ of nowhere vanishing normal vector fields to $z_{\eta,\theta}$ pointing into Δ_j at z_j . The data $(Y_{\eta\theta}, \phi_{\eta,\theta}, \nu_{\eta,\theta})$, where $\phi_{\eta,\theta} = \{\phi_j\}$ (note that this collection includes the data of the preferred disks and basepoints), is called the *strongly bordered 3-manifold* associated to $\mathcal{H}^{\eta,\theta}$. We will abbreviate this data as $Y_{\eta\theta}$.

Construction 5.1. Let $\mathcal{H} = (\bar{\Sigma}, \gamma, \delta, \varepsilon, z)$ be an (arced) bordered Heegaard triple such that each $\eta \in \{\gamma, \delta, \varepsilon\}$ meeting $\partial\bar{\Sigma}$ meets exactly one boundary component. For $\eta \in \{\gamma, \delta, \varepsilon\}$ meeting the boundary, construct a *cornered handlebody* \bar{U}_η as follows. Let $\bar{U}_0 = \bar{\Sigma} \times [0, 1]$ and let $\hat{F}_\eta = F(\mathcal{Z}_\eta) \setminus \text{int}(D_\eta^2)$, where D_η^2 is the disk with $\partial D_\eta^2 = \mathcal{Z}_\eta$ used to construct $F(\mathcal{Z}_\eta)$ from the pointed matched circle $\mathcal{Z}_\eta = (Z_\eta, \mathbf{a}_\eta, M_\eta)$. Choose a closed collar neighborhood $[-\varepsilon, 0] \times Z_\eta$ of $Z_\eta \subset \bar{\Sigma}$ such that $\{0\} \times Z_\eta$ is identified with Z_η as in the following schematic figure.



Next, choose a closed tubular neighborhood $Z_\eta \times [0, 1]$ of Z_η in \mathring{F}_η and glue \bar{U}_0 to $[-\varepsilon, 0] \times \mathring{F}_\eta$ by identifying the subsets $([-\varepsilon, 0] \times Z_\eta) \times [0, 1] \subset \bar{\Sigma} \times [0, 1]$ and $[-\varepsilon, 0] \times (Z_\eta \times [0, 1]) \subset [-\varepsilon, 0] \times F_\eta$ as in

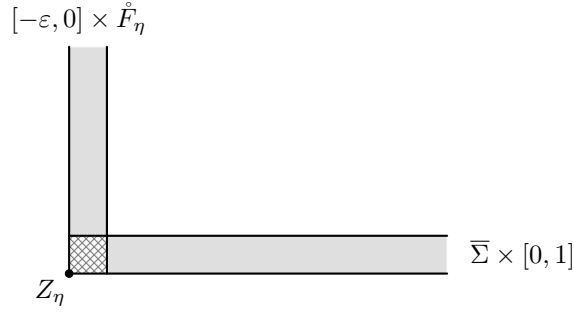

and, similarly, attach a copy of $[-\varepsilon, 0] \times D^2$ at each boundary component not met by η to obtain a new cornered 3-manifold \bar{U}_1 with two cornered boundary components, both of which are of the form $\Sigma_\eta := \mathring{F}_\eta \cup_\eta \bar{\Sigma} \cup_\partial D^2 \cup_{\partial \dots \partial} \dots \cup_\partial D^2$, where $B = \#\pi_0(\partial \bar{\Sigma})$ and each surface in this union is glued to $\bar{\Sigma}$ at a 90 degree angle. For η not meeting any boundary component, instead attach a copy of $[-\varepsilon, 0] \times D^2$ in this manner at each boundary component — in this case, the resulting cornered 3-manifold has boundary components of the form $\Sigma_\emptyset := \bar{\Sigma} \cup_\partial D^2 \cup_{\partial \dots \partial} \dots \cup_\partial D^2$. Now attach 3-dimensional 2-handles to the η -circles $\eta_i^c \times \{0\} \subset \bar{\Sigma} \times [0, 1]$ as in

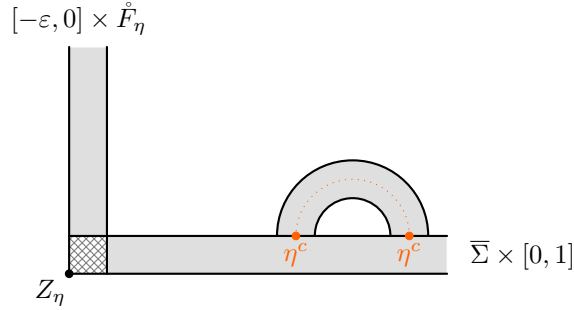

to obtain a new 3-manifold \bar{U}_2 with two boundary components: a copy of Σ_η or Σ_\emptyset meeting $\bar{\Sigma} \times \{1\}$ and a genus $2k_\eta$ surface S_η , where $4k_\eta$ is the number of points in the boundary pointed matched circle corresponding to η (which is zero if η does not meet the boundary), which meets $\bar{\Sigma} \times \{0\}$. Next, if η meets the boundary, join each η -arc $\eta_i^a \times \{0\} \subset S_\eta$ to the core of the corresponding handle in $\{-\varepsilon\} \times \mathring{F}_\eta$ to obtain a collection of closed curves and attach a 3-dimensional 2-handle along each as in the following figure. If η does not meet the boundary, instead go on immediately to the next step.

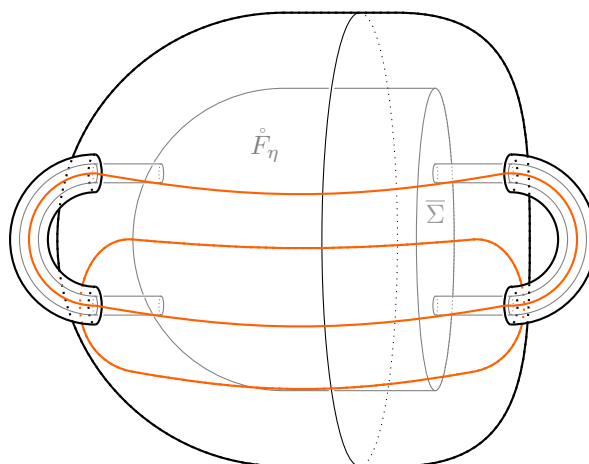

FIGURE 10. A genus 1 example of a \bar{U}_2 in the case that η does meet the boundary.

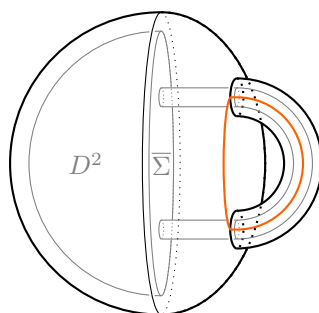
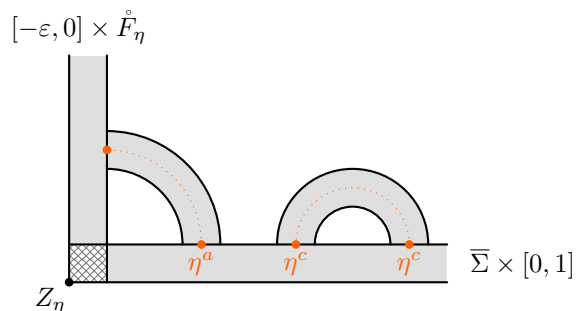
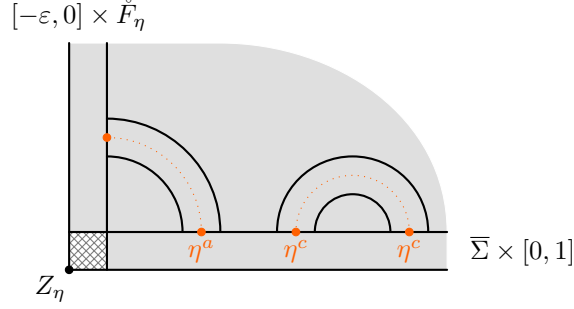

FIGURE 11. A genus 1 example of a \bar{U}_2 in the case that η does not meet the boundary.



This has the effect of replacing the boundary component S_η with an S^2 boundary component. We then define \bar{U}_η to be the result of filling this boundary component with a 3-ball as in



— the resulting space is a 3-manifold with boundary and corners, whose boundary stratum is $\partial_1 \bar{U}_\eta = \Sigma_\eta$ or $\partial_1 \bar{U}_\eta = \Sigma_\emptyset$, depending on whether or not η meets the boundary, and whose corner stratum is of the form $\partial_2 \bar{U}_\eta = S^1 \sqcup \overset{B}{\dots} \sqcup S^1$. We then define a cornered 4-manifold $X(\mathcal{H})$ by

$$(49) \quad X(\mathcal{H}) = (\bar{\Sigma} \times \Delta) \cup_{\bar{\Sigma} \times e_\gamma} (\bar{U}_\gamma \times e_\gamma) \cup_{\bar{\Sigma} \times e_\delta} (\bar{U}_\delta \times e_\delta) \cup_{\bar{\Sigma} \times e_\varepsilon} (\bar{U}_\varepsilon \times e_\varepsilon),$$

where Δ is a triangle with edges labeled clockwise as e_γ , e_δ , and e_ε , smoothing corners between the \bar{U}_η 's at the vertices $\bar{\Sigma} \times (e_\eta \cap e_\theta)$. Note that the boundary stratum $\partial_1 X(\mathcal{H})$ is connected and consists of the following two pieces. First, it contains each of the bordered 3-manifolds $Y_{\eta\theta} = Y(\mathcal{H}_{\eta\theta})$, where the diagrams $\mathcal{H}_{\eta\theta} = (\bar{\Sigma}, \eta, \theta, z)$ are the bordered Heegaard diagrams obtained from \mathcal{H} by deleting one of the collections of curves and filling the corresponding boundary component with a disk. Second, if θ and ϑ are the collections of curves not meeting the η -boundary, it contains a copy of

$$(50) \quad \text{Facet}_\eta := S^1 \times \Delta \cup_{S^1 \times e_\eta} (\mathring{F}_\eta \times e_\eta) \cup_{S^1 \times e_\theta} (D^2 \times e_\theta) \cup_{S^1 \times e_\vartheta} (D^2 \times e_\vartheta),$$

and there is one such “facet” for each η meeting $\partial \bar{\Sigma}$. These two distinguished parts of the boundary stratum meet in two copies of $F(Z_\eta)$ and one copy of S^2 . The union of these surfaces over all η meeting $\partial \bar{\Sigma}$ forms the corner stratum $\partial_2 X(\mathcal{H})$.

In the single boundary component case, one may think of $X(\mathcal{H})$ schematically as in the following figure, which represents the δ -bordered case.

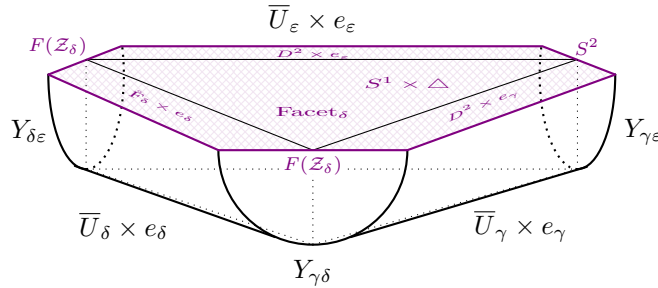

However, this representation of $X(\mathcal{H})$ may be somewhat misleading: topologically, the space Facet_η is a closed 3-dimensional regular neighborhood of the singular surface $\mathring{F}_\eta \cup_\partial D^2 \cup_\partial D^2$

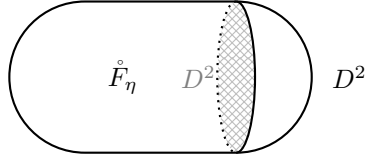

— i.e. Facet_η is a 3-dimensional pair of pants cobordism $-F(\mathcal{Z}_\eta) \sqcup F(\mathcal{Z}_\eta) \rightarrow S^2$. To see this, note that Facet_η is the result of gluing $\mathring{F}_\eta \times [0, 1]$ and two copies of $D^2 \times [0, 1]$ to $S^1 \times \Delta$ by identifying each of $\partial\mathring{F}_\eta \times [0, 1]$ and the two copies of $\partial D^2 \times [0, 1]$ with one of $S^1 \times e_\gamma$, $S^1 \times e_\delta$, and $S^1 \times e_\varepsilon$ so that $\partial\mathring{F}_\eta \times \{\frac{1}{2}\}$ and the two copies of $\partial D^2 \times \{\frac{1}{2}\}$ are identified with the circles $S^1 \times \{\text{midpoint}\}$ depicted in the following figure and smoothing corners.

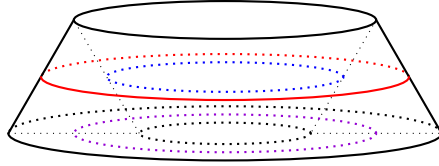

Remark. More generally, an arced bordered Heegaard n -tuple

$$(51) \quad \mathcal{H} = (\overline{\Sigma}_g, \boldsymbol{\eta}_0, \dots, \boldsymbol{\eta}_{n-1}, \boldsymbol{z})$$

with B boundary components determines a cornered 4-manifold $X(\mathcal{H})$ whose boundary stratum consists of the bordered 3-manifolds $Y_{\eta_i \eta_{i+1}}$, with indices taken modulo n , together with facets Facet_{η_i} for each i for which $\boldsymbol{\eta}_i$ intersects $\partial\overline{\Sigma}_g$ nontrivially. The constructions of $X(\mathcal{H})$ and the facets Facet_{η_i} are identical to the $n = 3$ case except that we replace the triangle Δ with a planar n -gon.

5.1. Gluing. Let $\mathcal{H} = (\overline{\Sigma}_g, \boldsymbol{\gamma}, \boldsymbol{\delta}, \boldsymbol{\varepsilon}, \boldsymbol{z})$ be an arced bordered Heegaard triple with three boundary components and let $\mathcal{H}_1 = (\overline{\Sigma}_{g_1}, \boldsymbol{\gamma}_1, \boldsymbol{\delta}_1, \boldsymbol{z}_1)$, $\mathcal{H}_2 = (\overline{\Sigma}_{g_2}, \boldsymbol{\delta}_2, \boldsymbol{\varepsilon}_2, \boldsymbol{z}_2)$, and $\mathcal{H}_3 = (\overline{\Sigma}_{g_3}, \boldsymbol{\varepsilon}_3, \boldsymbol{\gamma}_3, \boldsymbol{z}_3)$ be γ -, δ -, and ε -bordered Heegaard diagrams, respectively. Let $\mathcal{H}_{1,2,3} = \mathcal{H} \cup_\gamma \mathcal{H}_1^+ \cup_\delta \mathcal{H}_2^+ \cup_\varepsilon \mathcal{H}_3^+$ be the ordinary Heegaard triple that results from doubling the collections of curves in the \mathcal{H}_i not meeting the boundary, labeling the new circles according to whichever label does not appear in \mathcal{H}_i , and gluing them to the corresponding boundary components of \mathcal{H} , as we did in the construction of $\text{AT}_{1,2,3}$.

Proposition 5.1. *If \mathcal{H}_1 and \mathcal{H}_2 are bordered Heegaard triples sharing a common boundary matching and \mathcal{H}_2 has one boundary component, then there is a diffeomorphism $X(\mathcal{H}_1 \cup_\partial \mathcal{H}_2) \cong X(\mathcal{H}_1) \cup_{\text{Facet}} X(\mathcal{H}_2)$, where Facet is the corresponding boundary facet. In particular, the 4-manifold $X(\mathcal{H}_{1,2,3})$ is diffeomorphic to*

$$(52) \quad X(\mathcal{H}) \cup_{\text{Facet}_\gamma} X(\mathcal{H}_1^+) \cup_{\text{Facet}_\delta} X(\mathcal{H}_2^+) \cup_{\text{Facet}_\varepsilon} X(\mathcal{H}_3^+).$$

Proof. Suppose that \mathcal{H}_2 is an η -bordered Heegaard diagram. The effect of gluing \mathcal{H}_2 to the η -boundary of \mathcal{H}_1 is as follows. First, the underlying surface $\overline{\Sigma}_g$ is replaced by $\overline{\Sigma}_g \cup_\eta \overline{\Sigma}_{g_2}$ which has the effect of gluing $\overline{\Sigma}_g \times \Delta$ to $\overline{\Sigma}_{g_2} \times \Delta$ in the obvious manner. Second, gluing the η -arcs which meet the boundary along their common endpoints corresponds to gluing the 3-dimensional 2-handles along the corresponding cores of the 1-handles in \mathring{F}_η determined by the arcs. This has the effect of gluing the respective η -handlebodies along their \mathring{F}_η -boundaries. Lastly, for $\theta \neq \eta$, the respective θ -handlebodies are glued along their disk boundaries. It is

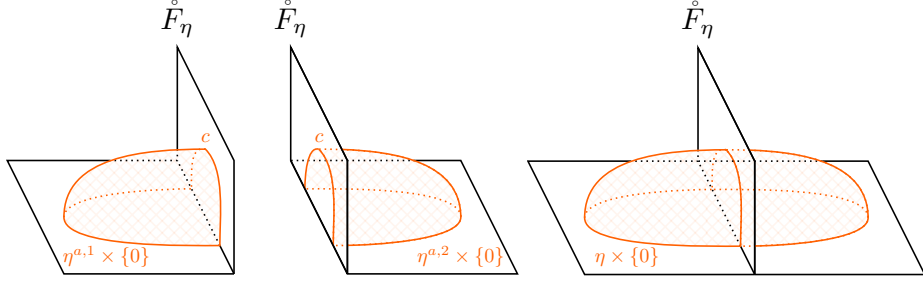

FIGURE 12. The effect of gluing bordered Heegaard triples on the 2-handles attached to matched pairs of curves of the form $\eta^a \cup_{\partial} c$, where c is the core of a 1-handle in \mathring{F}_η .

straightforward to see that these glued handlebodies are precisely the handlebodies obtained from the above construction using the glued diagram so this proves the result. \square

Corollary 5.2. *The 4-manifold $X(\text{AT}_{1,2,3})$ is diffeomorphic to the composition $W_2^{13,g_2} \circ W \circ (W_{-2}^{12,g_3} \sqcup W_{-2}^{23,g_1})$ of the pair of pants cobordism $W : Y_{12} \sqcup Y_{23} \rightarrow Y_{13}$ with the cobordisms $W_2^{ij,g_k} : Y_{ij} \rightarrow Y_{ij} \# (S^2 \times S^1)^{g_k}$ obtained by surgery on 0-framed g_k -component unlinks in Y_{ij} and their reverses $W_{-2}^{ij,g_k} : Y_{ij} \# (S^2 \times S^1)^{g_k} \rightarrow Y_{ij}$. Thus, if $W_1^{ij,g} : Y_{ij} \rightarrow Y_{ij} \# (S^2 \times S^1)^{\#g}$ and $W_3^{ij,g} : Y_{ij} \# (S^2 \times S^1)^{\#g} \rightarrow Y_{ij}$ are the usual 1-handle and 3-handle cobordisms, then $W_3^{13,g_2} \circ X(\text{AT}_{1,2,3}) \circ (W_1^{12,g_3} \sqcup W_1^{23,g_1})$ is diffeomorphic to W .*

Proof. Suppose that $\overline{\mathcal{H}} = (\overline{\Sigma}_g, \alpha, \beta, z)$ is an α -bordered Heegaard triple and let $Y = Y(\overline{\mathcal{H}})$ be the corresponding bordered 3-manifold. We claim that the cornered 4-manifold $X = X(\overline{\mathcal{H}}^+)$ determined by the triple $\mathcal{H}^+ = (\overline{\Sigma}, \alpha, \beta^0, \beta^1, z)$ obtained by doubling β is diffeomorphic to the cobordism of pairs

$$(53) \quad (-Y \sqcup Y, -\partial Y \sqcup \partial Y) \rightarrow ((S^2 \times S^1)^{\#g} \setminus B^3, S^2)$$

given by the complement of a regular neighborhood of the cornered handlebody $\overline{U}_\beta \times \{0\}$ in $Y \times [-1, 1]$. To see this, recall from [OS06, Proposition 4.3] that if $\mathcal{H}' = (\Sigma_0, \alpha', \beta', z)$ is any Heegaard diagram for a closed 3-manifold Y' and $(\Sigma_0, \alpha', \beta', \gamma, z)$ is such that γ is obtained by a small Hamiltonian translation of β' , then the 4-manifold $X_{\alpha'\beta'\gamma}$ determined by this diagram is diffeomorphic to $Y' \times [-1, 1]$ with a regular neighborhood of the handlebody $U_{\beta'} \times \{0\}$ deleted, i.e. the cobordism obtained by attaching 2-handles to a 0-framed unlink in a Euclidean ball in Y' . In particular, this is the case if $\mathcal{H}' = \mathcal{H}_0 \cup_{\partial} \mathcal{H}$ for some other α -bordered Heegaard diagram \mathcal{H}_0 . The claim then follows from the previous proposition.

The first statement now follows from Proposition 5.1 together with the observation that the surface underlying the triple AT is naturally identified with $F(\mathcal{Z})$ with three disks removed and the fact that deleting any pair of curves from AT determines a bordered Heegaard diagram for $F(\mathcal{Z}) \times I$ after filling the now-empty boundary component with a disk. The second statement then follows from the fact that the 2- and 3-handles in $W_3^{13,g_2} \circ W_2^{13,g_2}$ and the 1- and 2-handles in $(W_{-2}^{12,g_3} \sqcup W_{-2}^{23,g_1}) \circ (W_1^{12,g_3} \sqcup W_1^{23,g_1})$ cancel. \square

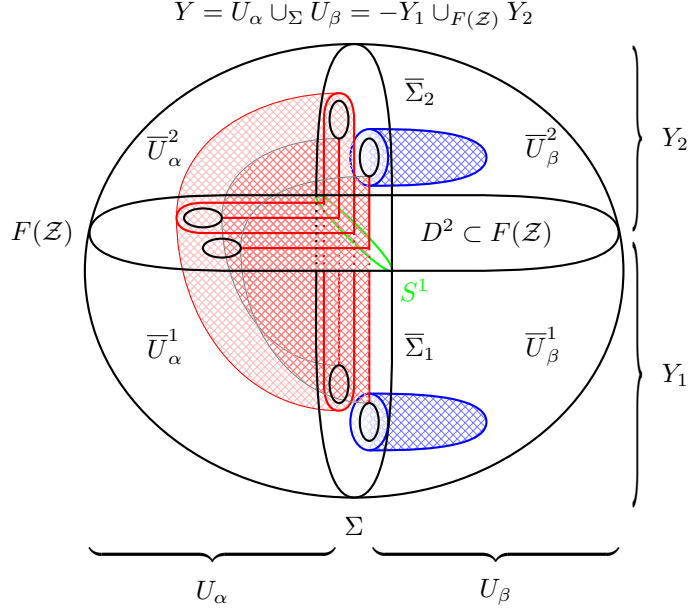

FIGURE 13. Splitting a closed 3-manifold into two handlebodies along a Heegaard surface Σ and into two bordered 3-manifolds along a surface $F(\mathcal{Z})$ transverse to the original. In each half-surface, the two small black circles are identified and, hence, such a pair represents a handle.

Another way of thinking about these results is as follows. Given a closed 3-manifold Y , we have two distinct ways of decomposing Y into 3-manifolds with boundary: we can either decompose Y as $Y = U_\alpha \cup_\Sigma U_\beta$, where U_α and U_β are handlebodies glued along a Heegaard surface Σ , or we can decompose it as $Y = -Y_1 \cup_{F(\mathcal{Z})} Y_2$, where Y_1 and Y_2 are *bordered* 3-manifolds which both have boundary parameterized by the same surface $F(\mathcal{Z})$. Here, we have chosen this second splitting to be one obtained by cutting a closed Heegaard diagram $(\Sigma, \alpha, \beta, z)$ for the decomposition $Y = U_\alpha \cup_\Sigma U_\beta$ along some circle which intersects one of the pairs of curves, giving us two bordered Heegaard diagrams with the same pointed matched circle \mathcal{Z} . In this case, the copy of the surface $F(\mathcal{Z})$ sitting inside of Y meets Σ transversely in a single separating copy of S^1 . Therefore, each Y_i decomposes as a union of two cornered handlebodies $Y_i = \bar{U}_\alpha^i \cup_{\Sigma \cap Y_i} \bar{U}_\beta^i$ and each handlebody U_η decomposes similarly as $U_\eta = \bar{U}_\eta^1 \cup_{F(\mathcal{Z}) \cap U_\eta} \bar{U}_\eta^2$. This allows us to decompose Y into four “quadrants” which are compatible with the (restrictions of) the gluings in both decompositions of Y (cf. Figure 13). These quadrants are precisely the cornered handlebodies from Construction 5.1. If we had instead started with a closed Heegaard triple $\mathcal{H} = (\Sigma, \gamma, \delta, \varepsilon, z)$, separated Σ along a circle intersecting exactly one of the sets of curves to obtain a decomposition $\Sigma = \bar{\Sigma}_1 \cup_\partial \bar{\Sigma}_2$, and glued the cornered handlebodies meeting $\bar{\Sigma}_i$ to $\bar{\Sigma}_i \times \Delta$ to obtain $X(\mathcal{H}_i)$, then the complement of the bordered 3-manifolds $Y_{\eta\theta}$ in $\partial_1 X(\mathcal{H}_i)$ is precisely the interior of

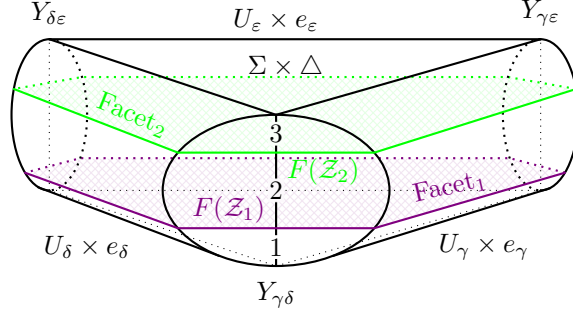

FIGURE 14. Slicing a 4-manifold with boundary obtained from a closed Heegaard triple $\mathcal{H} = (\Sigma, \gamma, \delta, \epsilon, \mathbf{z})$ along two facets. In this schematic example, the Heegaard surface Σ decomposes as $\Sigma = \bar{\Sigma}_1 \cup \bar{\Sigma}_2 \cup \bar{\Sigma}_3$ so each of the 3-manifolds $Y_{\eta\theta}$ decomposes into bordered 3-manifolds as $Y_{\eta\theta} = Y_{\eta\theta}^1 \cup_{F_1} Y_{\eta\theta}^2 \cup_{F_2} Y_{\eta\theta}^3$ and each handlebody U_η decomposes into cornered handlebodies as $U_\eta = \bar{U}_\eta^1 \cup_{F_1 \cap U_\eta} \bar{U}_\eta^2 \cup_{F_2 \cap U_\eta} \bar{U}_\eta^3$.

a facet so gluing $X(\mathcal{H}_1)$ and $X(\mathcal{H}_2)$ along their respective boundary facets yields the original 4-manifold $X(\mathcal{H})$.

6. THE MAIN THEOREM

In [Zem21a, Zem21b], Zemke extends the minus and hat versions of Heegaard Floer homology to give monoidal functors out of the monoidal category of (multi)-pointed 3-manifolds and cobordisms between them equipped with embedded ribbon graphs connecting the basepoints. Given a closed Heegaard triple $(\Sigma, \gamma, \delta, \epsilon, \mathbf{z})$, let $X_{\gamma\delta\epsilon}$ be the smooth 4-manifold with boundary $\partial X_{\gamma\delta\epsilon} = -Y_{\gamma\delta} \sqcup -Y_{\delta\epsilon} \sqcup Y_{\gamma\epsilon}$ defined by

$$(54) \quad X_{\gamma\delta\epsilon} = (\Sigma \times \Delta) \cup_{\Sigma \times e_\gamma} (U_\gamma \times e_\gamma) \cup_{\Sigma \times e_\delta} (U_\delta \times e_\delta) \cup_{\Sigma \times e_\epsilon} (U_\epsilon \times e_\epsilon),$$

i.e. the pair of pants cobordism, as in [OS04, Section 8]. In [Zem21a, Section 9], Zemke endows $X_{\gamma\delta\epsilon}$ with an embedded trivalent graph $\Gamma_{\gamma\delta\epsilon}$ as follows: let $v_0 \in \Delta$ be an interior point and define $\Gamma_0 \subset \Delta$ by attaching a straight line segment extending radially from v_0 to each of the three vertices of the triangle. Then one defines $\Gamma_{\gamma\delta\epsilon} := \mathbf{z} \times \Gamma_0$ and gives this graph a ribbon structure by cyclically ordering the edges by endowing the ends of $X_{\gamma\delta\epsilon}$ with the cyclic order $(-Y_{\gamma\delta}, -Y_{\delta\epsilon}, Y_{\gamma\epsilon})$.

Theorem 6.1 ([Zem21a, Theorem 9.1]). *Suppose that $(\Sigma, \gamma, \delta, \epsilon, \mathbf{z})$ is a closed pointed Heegaard triple. Let*

$$(55) \quad (X_{\gamma\delta\epsilon}, \Gamma_{\gamma\delta\epsilon}) : (Y_{\gamma\delta} \sqcup Y_{\delta\epsilon}, \mathbf{z} \sqcup \mathbf{z}) \rightarrow (Y_{\gamma\epsilon}, \mathbf{z})$$

be the ribbon graph cobordism described above. Then, if $\mathfrak{s} \in \text{Spin}^c(X_{\gamma\delta\epsilon})$, the graph cobordism map

$$F_{X_{\gamma\delta\epsilon}, \Gamma_{\gamma\delta\epsilon}, \mathfrak{s}}^B : CF^-(\Sigma, \gamma, \delta; \mathfrak{s}|_{Y_{\gamma\delta}}) \otimes_{\mathbb{F}[U]} CF^-(\Sigma, \delta, \epsilon; \mathfrak{s}|_{Y_{\delta\epsilon}}) \rightarrow CF^-(\Sigma, \gamma, \epsilon; \mathfrak{s}|_{Y_{\gamma\epsilon}})$$

is chain homotopic to the holomorphic triangle map $F_{\alpha, \beta, \gamma, \mathfrak{s}}^-$.

Corollary 6.2. *The hat Heegaard Floer analogue of [Zem21a, Theorem 9.1] holds.*

Theorem 6.3 ([Zem21b, Theorem 1.2]). *If $(W, \Gamma) : (Y_0, \mathbf{p}_0) \rightarrow (Y_1, \mathbf{p}_1)$ is a graph cobordism, then the graph cobordism map $\widehat{F}_{W, \Gamma} : \widehat{CF}(Y_0, \mathbf{p}_0) \rightarrow \widehat{CF}(Y_1, \mathbf{p}_1)$ is functorial with respect to composition of cobordisms and if Γ is a path connecting \mathbf{p}_0 to \mathbf{p}_1 , then $\widehat{F}_{W, \Gamma}$ is homotopic to the cobordism map defined by Ozsváth–Szabó in [OS06].*

Note that the pair of pants cobordism with its embedded ribbon graph decomposes as $(X_{\gamma\delta\varepsilon}, \Gamma_{\gamma\delta\varepsilon}) = (W_1 \cup_{Y_{12}\#Y_{23}} W_2, \Gamma_1 \cup \Gamma_2)$, where $(W_1, \Gamma_1) : Y_{12} \sqcup Y_{23} \rightarrow Y_{12}\#Y_{23}$ is the connected sum cobordism with an embedded trivalent graph Γ_1 , and $(W_2, \Gamma_2) : Y_{12}\#Y_{23} \rightarrow Y_{13}$ is the 2-handle cancellation cobordism equipped with an embedded path Γ_2 between basepoints. By [Zem21a, Proposition 8.1], the graph cobordism map $\widehat{F}_{W_1, \Gamma_1} : \widehat{CF}(Y_{12}) \otimes \widehat{CF}(Y_{23}) \rightarrow \widehat{CF}(Y_{12}\#Y_{23})$ is homotopic to Ozsváth–Szabó’s connected sum isomorphism. By the previous theorem, the map $\widehat{F}_{W_2, \Gamma_2}$ is homotopic to the map $\widehat{F}_{W_2} : \widehat{CF}(Y_{12}\#Y_{23}) \rightarrow \widehat{CF}(Y_{13})$ defined by Ozsváth–Szabó in [OS06]. With these facts in hand, we are now ready to prove Theorem 1.1.

Theorem 6.4 (Theorem 1.1). *Let Y_1, Y_2 , and Y_3 be bordered 3-manifolds, all of which have boundaries parameterized by the same surface F , and let $\mathcal{A} = \mathcal{A}(-F)$ be the algebra associated to $-F$. Let $Y_{ij} = -Y_i \cup_{\partial} Y_j$ and consider the pair of pants cobordism $W : Y_{12} \sqcup Y_{23} \rightarrow Y_{13}$. Then the composition map*

$$(56) \quad \text{Mor}^{\mathcal{A}}(Y_1, Y_2) \otimes \text{Mor}^{\mathcal{A}}(Y_2, Y_3) \rightarrow \text{Mor}^{\mathcal{A}}(Y_1, Y_3)$$

given by $f \otimes g \mapsto g \circ f$ fits into a homotopy commutative square of the form

$$(57) \quad \begin{array}{ccc} \text{Mor}^{\mathcal{A}}(Y_1, Y_2) \otimes \text{Mor}^{\mathcal{A}}(Y_2, Y_3) & \xrightarrow{f \otimes g \mapsto g \circ f} & \text{Mor}^{\mathcal{A}}(Y_1, Y_3) \\ \simeq \downarrow & & \downarrow \simeq \\ \widehat{CF}(Y_{12}) \otimes \widehat{CF}(Y_{23}) & \xrightarrow{\widehat{F}_W} & \widehat{CF}(Y_{13}) \end{array}$$

where \widehat{F}_W is the map induced by W and the vertical maps come from the pairing theorem of [LOT11].

Proof. By Corollary 6.2 and Theorem 6.3, the maps \widehat{G}_{AT} and \widehat{F}_W are homotopic. The result then follows from Theorem 4.7. \square

This immediately implies the following assertion of Lipshitz–Ozsváth–Thurston in [LOT11, Section 1.5].

Corollary 6.5. *The Yoneda composition map*

$$(58) \quad \text{Ext}(Y_1, Y_2) \otimes_{\mathbb{F}} \text{Ext}(Y_2, Y_3) \rightarrow \text{Ext}(Y_1, Y_3),$$

where $\text{Ext}(Y_i, Y_j) := \text{Ext}(\widehat{CFD}(Y_i), \widehat{CFD}(Y_j))$, coincides with the map

$$(59) \quad \widehat{F}_W : \widehat{HF}(-Y_1 \cup_{\partial} Y_2) \otimes_{\mathbb{F}} \widehat{HF}(-Y_2 \cup_{\partial} Y_3) \rightarrow \widehat{HF}(-Y_1 \cup_{\partial} Y_3)$$

induced by W .

REFERENCES

- [Aur10] Denis Auroux. Fukaya categories of symmetric products and Heegaard–Floer homology. *J. Gökova Geom. Topol.*, page 1–54, 2010. (Cited on pages 1, 2, 4, 6, 9, 15, and 18)

- [Gut22] Gary Guth. For exotic surfaces with boundary, one stabilization is not enough, 2022. (Cited on pages 13 and 18)
- [Juh06] András Juhász. Holomorphic discs and sutured manifolds. *Algebraic & Geometric Topology*, 6(3):1429–1457, oct 2006. (Cited on page 11)
- [Lip06] Robert Lipshitz. A cylindrical reformulation of Heegaard Floer homology. *Geom. Topol.*, 10:955–1096, 2006. [Paging previously given as 955–1097]. (Cited on pages 8 and 13)
- [LOT11] Robert Lipshitz, Peter Ozsváth, and Dylan Thurston. Heegaard Floer homology as morphism spaces. *Quantum Topology*, page 381–449, 2011. (Cited on pages 1, 2, 4, 6, 8, and 29)
- [LOT15] Robert Lipshitz, Peter S. Ozsváth, and Dylan P. Thurston. Bimodules in bordered Heegaard Floer homology. *Geom. Topol.*, 19(2):525–724, 2015. (Cited on page 20)
- [LOT16] Robert Lipshitz, Peter S. Ozsváth, and Dylan P. Thurston. Bordered Floer homology and the spectral sequence of a branched double cover II: the spectral sequences agree. *J. Topol.*, 9(2):607–686, 2016. (Cited on pages 9, 12, 13, 14, 16, and 19)
- [LOT18] Robert Lipshitz, Peter S. Ozsvath, and Dylan P. Thurston. Bordered Heegaard Floer homology. *Mem. Amer. Math. Soc.*, 254(1216):viii+279, 2018. (Cited on pages 1, 4, 6, 12, 13, and 20)
- [OS04] Peter Ozsváth and Zoltán Szabó. Holomorphic disks and topological invariants for closed three-manifolds. *Ann. of Math. (2)*, 159(3):1027–1158, 2004. (Cited on pages 1, 12, and 28)
- [OS06] Peter Ozsváth and Zoltán Szabó. Holomorphic triangles and invariants for smooth four-manifolds. *Adv. Math.*, 202(2):326–400, 2006. (Cited on pages 1, 26, and 29)
- [SW10] Sucharit Sarkar and Jiajun Wang. An algorithm for computing some Heegaard Floer homologies. *Annals of Mathematics*, 171(2):1213–1236, mar 2010. (Cited on page 8)
- [Zar11] Rumen Zarev. *Bordered Sutured Floer Homology*. ProQuest LLC, Ann Arbor, MI, 2011. Thesis (Ph.D.)—Columbia University. (Cited on page 21)
- [Zem21a] Ian Zemke. Duality and mapping tori in Heegaard Floer homology. *Journal of Topology*, 14(3):1027–1112, sep 2021. (Cited on pages 1, 2, 28, and 29)
- [Zem21b] Ian Zemke. A graph TQFT for hat Heegaard Floer homology. *Quantum Topology*, 12(3):439–460, sep 2021. (Cited on pages 2, 28, and 29)

DEPARTMENT OF MATHEMATICS, UNIVERSITY OF OREGON, EUGENE, OR 97403-1222, USA
 Email address: jcohen2@uoregon.edu