

# Rational verification and checking for Nash and subgame-perfect equilibria in graph games

Léonard Brice, Université Libre de Bruxelles  
Jean-François Raskin, Université Libre de Bruxelles  
Marie van den Bogaard, Université Gustave Eiffel

January 31, 2023

## Abstract

We study two natural problems about rational behaviors in multiplayer non-zero-sum sequential infinite duration games played on graphs: checking problems, that consist in deciding whether a strategy profile, defined by a Mealy machine, is rational; and rational verification, that consists in deciding whether all the rational answers to a given strategy satisfy some specification. We give the complexities of those problems for two major concepts of rationality: Nash equilibria and subgame-perfect equilibria, and for five major classes of payoff functions: parity, mean-payoff, quantitative reachability, energy, and discounted-sum.

## 1 Introduction

### 1.1 Motivations

Formal methods are essential to guarantee the correctness of safety critical computer systems. Techniques like model-checking [15] or automated theorem proving [16] are now routinely used to develop systematically hardware pieces as well as embedded control systems. Nevertheless, there are contexts in which formal methods have not yet been applied successfully large-scale. That is the case for instance of multi-agent systems, which still represent a challenge for formal verification techniques, because they are usually composed of *heterogeneous* components, ranging from traditional pieces of reactive code, to wholly autonomous robots or human users. Producing operational model abstractions for this diversity of sub-systems can be challenging, or even impossible.

While it may be inconvenient, to say the least, to produce an operational model of the behavior of a human or a complex autonomous robot, it may be easier to identify the high level objectives of those components. And taking into account those objectives is often key for reasoning about the correctness of a system that interacts with those components. Indeed, a system is usually not supposed to be correct in all circumstances, but only when agents in its environment behave in a way that concurs with their own objectives. This is why we need to develop verification frameworks that allow us to reason on correctness in the presence of rational agents: agents whose behaviors are rational with regards to their high level objectives. In *rational verification*, a system needs to enforce a property  $\varphi$ , not in all possible executions, but only in those executions in which agents of the environment behave rationally with regards to their own objectives.

Rationality is the focus point of game theory and can be formalized in several ways. For instance, rational behavior for the agents can be modeled by the notion of *Nash equilibrium* (NE) [29] in a multiplayer non-zero sum game graph [34]. NEs have been used in a few promising contributions, like in verification of non-repudiation and fair exchange protocols [26, 25, 14], or planning of self-driving cars interacting with human drivers [31], etc. Nevertheless, those works do not propose a general framework for rational verification and their contributions are rather specific to the particular application domains that they consider. There is thus a need for more systematic study of formal frameworks for rational verification. Such a study has been started recently. For instance, the authors of [22] study the automatic verification of an LTL specification in multi-agent systems that behave according to an NE, and in [13], the authors study a setting in which the environment has multiple objectives and only produces behaviors that are Pareto-optimal with regards to those objectives. This work contributes to that line of research by considering a notion of rationality formalized by *subgame-perfect equilibria* (SPEs), a refinement of NEs that is better suited to formalize rationality in sequential games, since NEs suffer from non-credible threats in such contexts (see e.g. [30]).

More precisely, we consider here two decision problems. First, in the *equilibrium checking problem*, the inputs are: (i) a multiplayer game graph, (ii) a finite state description of a (potentially infinite) set of strategy profiles for the players in the game, and (iii) a description of their objectives. The problem asks to check that all the strategy profiles in the set are NEs, or SPEs. This mathematical setting is well suited to formalize, for instance, that a high level description of a protocol, that contains nondeterminism, is such that all its implementations lead to rational behaviors of the entities participating to the protocol. This setting can be used to formalize elegantly the verification problems solved in [26, 14], for instance. Second, the *rational verification problem* takes as inputs: (i) a multiplayer game graph with a designated player called *Leader*, (ii) a finite state description of a (potentially infinite) set of strategies for Leader, (iii) a description of the objective for Leader, and (iv) a description of the objectives of all the other players. It asks whether for all possible fixed strategies  $\sigma_L$  of Leader (defined by the finite state description), for all possible rational responses of the other agents, the generated outcome satisfies Leader’s objective. That problem is well-suited to formalize the verification of correctness of a controller interacting with an environment composed of rational agents, and intending to enforce a given property.

To solve those problems, we first provide two *general constructions* that reduce those problems to simpler ones. We show that they lead to algorithms that are computationally optimal for a large variety of classes of games with objectives ranging from Boolean  $\omega$ -regular objectives, like parity objectives, to quantitative ones, like mean-payoff objectives. Several lower complexity bounds require new constructions. We now detail our technical contributions before comparing our results with the existing results in the literature.

## 1.2 Contributions

We call the general construction that we introduce to solve checking problems the *deviation game* (Definition 6): a game that simulates the parallel construction of a play compatible with the strategy profile, and of another play in which one player is deviating. Thus, the checking problems reduce to the simpler problem of deciding, given a game, whether there exists a play in which some player gets a better payoff than some other one (Corollary 1). To the best of our knowledge, there is no general polynomial-time reduction in the other direction, hence the latter problem may be strictly harder than the former, but it turns out to be sufficient to prove that all the checking problems in our five classes of games can be solved with simple

	Nash-checking		SP-checking		Nash rat. verif.		Ach. Nash rat. verif.		SP rat. verif.		Ach. SP rat. verif.	
	det.	non-det.	det.	non-det.	det.	non-det.	det.	non-det.	det.	non-det.	det.	non-det.
Parity	poly.				coNP-complete				coNP-complete			
MP	poly.				coNP-complete				coNP-complete	P <sup>NP</sup> -complete (*)		
QR	poly.				coNP-complete				PSPACE-complete			
Energy	poly.	coNP-complete (*)			undecidable, co-RE (*)				undecidable (*)			
DS	poly.				TDS-hard, RE (*)				TDS-hard, RE (*)			

Table 1: Synthesis of our results

polynomial time graph algorithms (Theorems 3, 5, 8, 11, and 15). Interestingly, there is one exception: in energy games, the checking problems are coNP-complete (Theorem 12) — and those problems are closely related to the succinct one counter automaton reachability problem.

As for rational verification, our contribution also starts with a general construction, the *product game* (Definition 7): we show that, given a game and a finite-state description of a set of Leader’s strategies, one can incorporate the memory states of that finite-state description in the arena of the game in a way that Leader is implicitly forced to follow some strategy in the set. Then, we show that the rational verification problem reduces in polynomial time to the *universal threshold problem*, a problem that is easier to study algorithmically: given a game, does every equilibrium satisfy a given specification? Furthermore, for some of the game classes that we consider, that latter problem has already been tackled, with slightly different definitions, in the literature. Interestingly, we show that there is also a reduction in the reverse direction (Corollary 2).

From that result, we build on various results of the literature to establish that rational verification problems are coNP-complete in parity games and mean-payoff games (Theorems 4 and 6), and that in quantitative reachability game, Nash rational verification is coNP-complete (Theorem 10), and subgame-perfect rational verification is PSPACE-complete (Theorem 9). By a reduction from the halting problem of counter machines, we prove the undecidability of rational verification in energy games (Theorem 13 and 14), even when Leader plays against only two players, in the case of subgame-perfect rational verification. We show that Nash rational verification is co-recursively enumerable in those games, and leave that question open for subgame-perfect rational verification — but we show that contrary to the Nash setting, SPEs may require infinite memory to enforce some payoffs (Proposition 2). In discounted-sum games, we show that Nash and subgame-perfect rational verification are at least as hard as the *target discounted-sum problem* (Theorem 16), whose decidability is a long-standing open question. Nevertheless, we prove that those problems are recursively enumerable (Theorem 17).

We also exhibit a subtlety in the definition of rational verification: if one wants to check that a strategy is such that *every* rational response satisfies the specification, then when no such response exists, the strategy will be accepted. We show that in the case of mean-payoff games, the possible absence of subgame-perfect responses of the environment to a strategy of Leader may lead to results that can be considered as counter-intuitive. We therefore propose a stronger definition of the rational verification problem, called *achaotic rational verification*, to avoid that weakness: it consists in deciding whether a strategy satisfies the specification against every response of the environment that is *as rational as it can*, using the notions of  $\varepsilon$ -NE and  $\varepsilon$ -SPE, which are quantitative relaxations of NE and SPE. We show that such a problem is P<sup>NP</sup>-complete in mean-payoff games (Theorem 7), and that in every other setting (Nash rational verification, or subgame-perfect rational verification in the four other classes of games), it coincides with rational verification, since rational responses always exist in all those cases (Proposition 1).

A synthesis of those results can be found in Table 1. Several of them are direct consequences of our general constructions, combined with results drawn from the literature; while some others required more effort and substantial original work. We highlighted the latter with a star (\*) as they form the main technical contributions of our paper.

### 1.3 Related works

During the last decade, non-zero sum multiplayer games and their applications to reactive synthesis have raised a growing attention. For an overview of the area, the reader may refer to [4, 11, 12, 19, 27], and their references.

The concept of *rational verification* appears in [23], where Gutierrez, Najib, Perelli, and Wooldridge give the complexity of several related problems. They use a definition that is slightly different from ours: their problem consists in deciding, given a game and a specification, whether all NEs (or one of them) in that game satisfy the specification, without any player representing the system (Leader in our setting). Still, as we show with Corollary 2, that problem is strongly related to ours. In [32], they also study if  $\omega$ -regular properties are enforced by NEs induced by mean-payoff objectives. The objectives considered in those paper are only  $\omega$ -regular objectives while we consider a variety of objectives including quantitative objectives. Moreover, both in [23] and in [32] only NEs are considered while our main contributions are about SPEs, that are arguably better suited for reasoning about sequential games [30], but also require substantially more complex techniques. In [18], Filiot, Gentilini, and Raskin study *Stackelberg values* of mean-payoff and discounted-sum two-player non-zero sum games, i.e. the payoff that Leader gets when the other player, *Follower*, plays the *best response* that is available with regards to his own objective. Once Leader’s strategy is defined, computing that payoff amounts to solve the rational verification problem, with one player in the environment.

In [33], and later in [34], Ummels studies SPEs in parity games. He proves that they always exist, and that deciding whether there exists an SPE in a given parity game that gives each player a payoff between two given thresholds (the *constrained existence problem*, very close to the *universal threshold problem* studied in this paper) is EXPTIME-easy and NP-hard. In [8], Brihaye, Bruyère, Goeminne, Raskin, and van den Bogaard, study the same problem in quantitative reachability games, and prove that it is PSPACE-complete.

In [20], Flesch and Predtetchinski give a general procedure to characterize SPEs. That procedure requires in general infinitely many iterations, where infinitely many two-player zero-sum of infinite size must be solved. In [5], Brice, Raskin, and van den Bogaard introduce the *negotiation function*, a tool that turns Flesch and Predtetchinski’s procedure into effective algorithms for a large class of games. In [7], they use it to close the gap left by Ummels, proving that the constrained existence problem is NP-complete in parity games, with methods that they use later in [6] to prove that the same problem is also NP-complete in mean-payoff games. An alternative procedure to solve such SPE problems is proposed in [28], where Meunier constructs a two-player zero-sum game in which one player has a winning strategy if and only if there exists an SPE satisfying the desired constraint in the input game. This technique leads to effective algorithms only for games whose payoff functions have finite codomain. Thus it cannot be used for mean-payoff, discounted sum, and quantitative reachability games studied in this paper. For parity games, this construction does not lead to optimal algorithms.

Energy objectives have also been widely studied, in connection with the study of vector additions systems with states and Petri nets. In [3], Bouyer, Fahrenberg, Larsen, Markey, and Srba show that solving two-player zero-sum energy games is in  $\text{NP} \cap \text{coNP}$ . In [35],

Velner, Chatterjee, Doyen, Henzinger, Rabinovitch, and Raskin generalize that result to energy games with multiple dimensions. In [27], Kupferman, Perelli, and Vardi study two-player zero-sum games where both players have their multi-dimensional energy objectives, and where the goal of one player is to keep her energy positive *or* to make the other player run out of energy. As for discounted-sum objectives, they are defined for instance by Zwick and Paterson in [36], again in a two-player zero-sum setting. They are strongly related to the target discounted-sum problem, which is a long-standing open problem, as shown in [2] by Boker, Henzinger, and Otop. To the best of our knowledge, no algorithmic results are known for those classes of objectives in a multiplayer non-zero sum setting.

## 1.4 Structure of the paper

In Section 2, we introduce the necessary background. In Section 3, we present our two general tools, the deviation game and the product game. In Section 4, we exploit those tools to study parity games; in Section 5, mean-payoff games; in Section 6, quantitative reachability games; in Section 7, energy games; and in section 8, discounted-sum games.

# 2 Background

## 2.1 Games

We call *graph* a finite directed graph, i.e. a pair  $(V, E)$  where  $V$  is a finite set of *vertices* and  $E \subseteq V \times V$  is a set of *edges*. For convenience, an edge  $(u, v)$  is written  $uv$ . It is called an *outgoing edge* of  $u$ , and an *ingoing edge* of  $v$ . A *path* in  $(V, E)$  is a finite or infinite sequence  $\alpha = \alpha_0\alpha_1\cdots \in V^* \cup V^\omega$  such that for every index  $k$ , we have  $\alpha_k\alpha_{k+1} \in E$ . Given a path  $\alpha$ , we write  $\text{Occ}(\alpha)$  the set of vertices that occur in  $\alpha$ , and  $\text{Inf}(\alpha)$  the set of those that occur infinitely many times in  $\alpha$ . For a given index  $k$ , we write  $\alpha_{\leq k}$ , or  $\alpha_{<k+1}$ , the finite prefix  $\alpha_0 \dots \alpha_k$ , and  $\alpha_{\geq k}$ , or  $\alpha_{>k-1}$ , the (finite or infinite) suffix  $\alpha_k\alpha_{k+1} \dots$ . A *cycle* is a finite path  $c = c_0 \dots c_n$  with  $c_n c_0 \in E$ . A finite path  $\alpha$  is *simple* if for every two indices  $k \neq \ell$ , we have  $\alpha_k \neq \alpha_\ell$ .

We call *non-initialized game* a tuple  $\mathcal{G} = (\Pi, V, (V_i)_{i \in \Pi}, E, \mu)$ , where:

- $\Pi$  is a finite set of *players*;
- $(V, E)$  is a graph, called the *arena* of  $\mathcal{G}$ , in which every vertex has at least one outgoing edge;
- $(V_i)_{i \in \Pi}$  is a partition of  $V$ , in which  $V_i$  is the set of vertices *controlled* by player  $i$ ;
- a *play* (resp. *history*) in the game  $\mathcal{G}$  is an infinite (resp. finite) path in the graph  $(V, E)$ , and the set of plays (resp. histories) in  $\mathcal{G}$  is denoted by  $\text{Plays}\mathcal{G}$  (resp.  $\text{Hist}\mathcal{G}$ );
- the *payoff function*  $\mu : \text{Plays}\mathcal{G} \rightarrow \mathbb{R}^\Pi$  maps each play  $\pi$  to the tuple  $\mu(\pi) = (\mu_i(\pi))_{i \in \Pi}$  of the players' *payoffs*.

Given a set of players  $P \subseteq \Pi$ , we often write  $V_P = \bigcup_{i \in P} V_i$ . When  $i$  is a player and when the context is clear, we write  $-i$  for the set  $\Pi \setminus \{i\}$ . A special player, called *Leader* and denoted by the symbol  $\mathbb{L}$ , is often assumed to belong to the set  $\Pi$ .

An *initialized game* is a pair  $(\mathcal{G}, v_0)$ , often written  $\mathcal{G}_{\upharpoonright v_0}$ , where  $\mathcal{G}$  is a non-initialized game and  $v_0 \in V$  is a vertex called *initial vertex*. When the context is clear, we use the word *game* for both initialized and non-initialized games.

A play (resp. history) in the initialized game  $\mathcal{G}_{\uparrow v_0}$  is a play (resp. history) that has  $v_0$  as first vertex. The set of plays (resp. histories) in  $\mathcal{G}_{\uparrow v_0}$  is denoted by  $\text{Plays}_{\mathcal{G}_{\uparrow v_0}}$  (resp.  $\text{Hist}_{\mathcal{G}_{\uparrow v_0}}$ ). We also write  $\text{Hist}_i \mathcal{G}$  (resp.  $\text{Hist}_i \mathcal{G}_{\uparrow v_0}$ ) for the set of histories in  $\mathcal{G}$  (resp.  $\mathcal{G}_{\uparrow v_0}$ ) whose last vertex is controlled by player  $i$ .

## 2.2 Notable classes of games

Hereafter, we will focus on five classes of games. Some are classes of *Boolean games*, i.e. games in which all payoffs are equal either to 0 or to 1. For such games, we say that player  $i$  *loses* the play  $\pi$  when  $\mu_i(\pi) = 0$ , and *wins* it when  $\mu_i(\pi) = 1$ . The other classes are called classes of *quantitative games*.

Parity games are Boolean games in which each player wins a play if that play satisfies some *parity condition*, a canonical encoding for  $\omega$ -regular conditions.

**Definition 1** (Parity). The game  $\mathcal{G}$  is a *parity game* if for each player  $i$ , there exists a mapping  $\kappa_i : V \rightarrow \mathbb{N}$ , called *color mapping*, such that for every play  $\pi$ , we have  $\mu_i(\pi) = 1$  if the color  $\min_{v \in \text{Inf}(\pi)} \kappa_i(v)$  is even, and  $\mu_i(\pi) = 0$  if it is odd.

Mean-payoff games are typical quantitative games: each action grants each player some *reward*, and the players seek to maximize their asymptotic average reward.

**Definition 2** (Mean-payoff). In a graph  $(V, E)$ , we define for each *reward mapping*  $r : E \rightarrow \mathbb{Q}$  the *mean-payoff function*  $\text{MP}_r : h_0 \dots h_n \mapsto \frac{1}{n} \sum_k r(h_k h_{k+1})$ . Then, we write  $\underline{\text{MP}}_r(\pi) = \liminf_n \text{MP}_r(\pi_{\leq n})$ . The game  $\mathcal{G}$  is a *mean-payoff game* if there exists a tuple  $(r_i)_{i \in \Pi}$  of reward mappings, such that for each player  $i$ , we have  $\mu_i = \underline{\text{MP}}_{r_i}$ . When the context is clear, we write  $\text{MP}_i$  for  $\text{MP}_{r_i}$ , and  $\underline{\text{MP}}_i$  for  $\underline{\text{MP}}_{r_i}$ .

Quantitative reachability games constitute a quantitative version of the classical class of reachability games: each player seeks to reach a given target as fast as possible.

**Definition 3** (Quantitative reachability). The game  $\mathcal{G}$  is a *quantitative reachability game* if for each player  $i$ , there exists a *target set*  $T_i \subseteq V$ , such that for every play  $\pi$ , we have:

$$\mu_i(\pi) = \frac{1}{1 + \inf\{n \in \mathbb{N} \mid \pi_n \in T_i\}},$$

with the conventions  $\inf \emptyset = +\infty$  and  $\frac{1}{+\infty} = 0$ .

Energy games are Boolean games, but based on a quantitative information, the *energy* of the players. Like in mean-payoff games, the players receive (positive or negative) rewards for each action, but they seek now to keep the aggregated sum of those rewards, their *energy level*, always nonnegative. That quantity symbolizes any resource that an agent could have to store, such as fuel, money, coffee, ...

**Definition 4** (Energy). In a graph  $(V, E)$ , we associate to each *reward mapping*  $r : E \rightarrow \mathbb{Z}$  the *energy level function*  $\text{EL}_r : \text{Hist}_{\mathcal{G}} \rightarrow \mathbb{N} \cup \{\perp\}$  defined by:

- $\text{EL}_r(h_0) = 0$ ;
- $\text{EL}_r(h_0 \dots h_{n+1}) = \text{EL}_r(h_0 \dots h_n) + r(h_n h_{n+1})$  if  $\text{EL}_r(h_0 \dots h_n) \neq \perp$ , and  $\text{EL}_r(h_0 \dots h_n) + r(h_n h_{n+1}) \geq 0$ ;
- $\text{EL}_r(h_0 \dots h_{n+1}) = \perp$  otherwise.

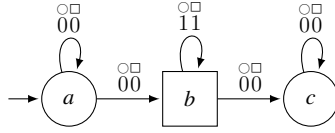

Figure 1: An example of mean-payoff game

The game  $\mathcal{G}$  is an *energy game* if there exists a tuple  $(r_i)_{i \in \Pi}$  of reward mappings such that for each  $i$  and every  $\pi$ , we have  $\mu_i(\pi) = 0$  if  $\text{EL}_{r_i}(\pi_{\leq n}) = \perp$  for some  $n$ , and  $\mu_i(\pi) = 1$  otherwise. When the context is clear, we write  $\text{EL}_i$  for  $\text{EL}_{r_i}$ .

Finally, discounted-sum games are quantitative games, where each player's payoff is obtained by summing the rewards that player obtains with some discount factor applied as the play goes along.

**Definition 5** (Discounted-sum). In a graph  $(V, E)$ , we define for each *reward mapping*  $r : E \rightarrow \mathbb{Q}$  and each rational *discount factor*  $\lambda \in (0, 1)$  the *discounted sum function*  $\text{DS}_r^\lambda : h \mapsto \sum_k \lambda^k r(h_k h_{k+1})$ . Then, we write  $\text{DS}_r^\lambda(\pi) = \lim_n \text{DS}_r^\lambda(\pi_{\leq n})$ . The game  $\mathcal{G}$  is a *discounted-sum game* if there exists a discount factor  $\lambda \in (0, 1)$  and a tuple  $(r_i)_{i \in \Pi}$  of reward mappings such that for each  $i$  and every  $\pi$ , we have  $\mu_i(\pi) = \text{DS}_{r_i}^\lambda(\pi)$ . When the context is clear, we write  $\text{DS}_i$  for  $\text{DS}_{r_i}^\lambda$ .

Every game  $\mathcal{G}$  from one of those five classes can be encoded with a finite number of bits. We write  $\|\mathcal{G}\|$  that number.

An example of mean-payoff game is given in Figure 1. That game has two players: player  $\circ$ , who controls the vertices  $a$  and  $c$ , and player  $\square$ , who controls the vertex  $b$ . The initial vertex is  $v_0 = a$ . We wrote above each edge the rewards that both players get when that edge is taken. Thus, three types of plays are possible in that game: the one that loops on the vertex  $a$  gives both players the payoff 0; the ones that loop on the vertex  $b$  give both players the payoff 1; and the ones that loop on the vertex  $c$  give both players the payoff 0.

## 2.3 Strategies

A *strategy* for player  $i$  in the initialized game  $\mathcal{G}_{\uparrow v_0}$  is a mapping  $\sigma_i : \text{Hist}_i \mathcal{G}_{\uparrow v_0} \rightarrow V$ , such that  $v\sigma_i(hv)$  is an edge of  $(V, E)$  for every  $hv$ . A history  $h$  is *compatible* with a strategy  $\sigma_i$  if and only if  $h_{k+1} = \sigma_i(h_0 \dots h_k)$  for all  $k$  such that  $h_k \in V_i$ . That definition naturally extends to plays.

A *strategy profile* for  $P \subseteq \Pi$  is a tuple  $\bar{\sigma}_P = (\sigma_i)_{i \in P}$ , where each  $\sigma_i$  is a strategy for player  $i$  in  $\mathcal{G}_{\uparrow v_0}$ . A play, or a history, is *compatible* with  $\bar{\sigma}_P$  if it is compatible with every  $\sigma_i$  for  $i \in P$ . A *complete* strategy profile, usually written  $\bar{\sigma}$ , is a strategy profile for  $\Pi$ . Exactly one play is compatible with the strategy profile  $\bar{\sigma}$ : we call it its *outcome* and write it  $\langle \bar{\sigma} \rangle$ .

When  $\bar{\tau}_P$  and  $\bar{\tau}'_Q$  are two strategy profiles with  $P \cap Q = \emptyset$ , we write  $(\bar{\tau}_P, \bar{\tau}'_Q)$  the strategy profile  $\bar{\sigma}_{P \cup Q}$  such that  $\sigma_i = \tau_i$  for  $i \in P$ , and  $\sigma_i = \tau'_i$  for  $i \in Q$ . In a strategy profile  $\bar{\sigma}_P$ , the  $\sigma_i$ 's domains are pairwise disjoint. Therefore, we can consider  $\bar{\sigma}_P$  as one function: for  $hv \in \text{Hist} \mathcal{G}_{\uparrow v_0}$  such that  $v \in \bigcup_{i \in P} V_i$ , we liberally write  $\bar{\sigma}_P(hv)$  for  $\sigma_i(hv)$  with  $i$  such that  $v \in V_i$ .

## 2.4 Equilibria and rational responses

In what follows, we study rational behaviors of players in games: we have, therefore, to define our rationality concepts. Let us start with the most classical one: *Nash equilibrium*.

The strategy profile  $\bar{\sigma}$  is a *Nash equilibrium* (resp.  $\mathbb{L}$ -fixed Nash equilibrium) — or ( $\mathbb{L}$ -fixed) *NE* for short — in  $\mathcal{G}_{\uparrow v_0}$  if for each player  $i$  (resp. each player  $i \neq \mathbb{L}$ ) and every strategy  $\sigma'_i$ , called *deviation of  $\sigma_i$* , we have  $\mu_i(\langle \sigma'_i, \bar{\sigma}_{-i} \rangle) \leq \mu_i(\langle \bar{\sigma} \rangle)$ . When  $\bar{\sigma}$  is *not* an NE (or  $\mathbb{L}$ -fixed NE), we call *profitable deviations* the deviations that do not satisfy that inequality.

As an example, in the game given in Figure 1, two types of Nash equilibria can be found: those that eventually loop on the vertex  $b$ , and therefore give both players the payoff 1; and those that loop on the vertex  $a$ , but in which player  $\circ$  has no profitable deviation, because if she goes to the vertex  $b$ , player  $\square$  threatens to go to the vertex  $c$  — and player  $\square$  has no profitable deviation, because he does never have a choice to do. However, player  $\square$ 's threat is not *credible*, since going to the vertex  $c$  would give him the payoff 0, while he could stay on the vertex  $b$  and get the payoff 1. A stronger rationality concept, that avoids that phenomenon, is the concept of *subgame-perfection*.

Let  $hv$  be a history in the game  $\mathcal{G}$ . The *subgame* of  $\mathcal{G}$  after  $hv$  is the game  $\mathcal{G}_{\uparrow hv} = (\Pi, V, (V_i)_i, E, \mu_{\uparrow hv})_{\uparrow v}$ , where  $\mu_{\uparrow hv}$  maps each play  $\pi$  to its payoff in  $\mathcal{G}$ , assuming that the history  $hv$  has already been played, i.e. to the payoff  $\mu_{\uparrow hv}(\pi) = \mu(h\pi)$ . Note that the initialized game  $\mathcal{G}_{\uparrow v_0}$  is also the subgame of  $\mathcal{G}$  after the one-vertex history  $v_0$ . If  $\sigma_i$  is a strategy in  $\mathcal{G}_{\uparrow v_0}$ , its *substrategy* after  $hv$  is the strategy  $\sigma_{i\uparrow hv}$  in  $\mathcal{G}_{\uparrow hv}$ , defined by  $\sigma_{i\uparrow hv}(h') = \sigma_i(hh')$  for every  $h' \in \text{Hist}_i \mathcal{G}_{\uparrow hv}$ .

The strategy profile  $\bar{\sigma}$  is a ( $\mathbb{L}$ -fixed) *subgame-perfect equilibrium* — or ( $\mathbb{L}$ -fixed) *SPE* for short — in  $\mathcal{G}_{\uparrow v_0}$  if and only if for every history  $h$  in  $\mathcal{G}_{\uparrow v_0}$  (resp. every history  $h$  compatible with  $\sigma_{\mathbb{L}}$ ), the strategy profile  $\bar{\sigma}_{\uparrow h}$  is a ( $\mathbb{L}$ -fixed) Nash equilibrium in the subgame  $\mathcal{G}_{\uparrow h}$ .

Nash and subgame-perfect equilibria entail two notions of rationality for the environment's responses to a strategy  $\sigma_{\mathbb{L}}$  of Leader. A *Nash response* to  $\sigma_{\mathbb{L}}$  is a strategy profile  $\bar{\sigma}_{-\mathbb{L}}$  such that the strategy profile  $\bar{\sigma} = (\sigma_{\mathbb{L}}, \bar{\sigma}_{-\mathbb{L}})$  is an  $\mathbb{L}$ -fixed NE. A *subgame-perfect response* to  $\sigma_{\mathbb{L}}$  is a strategy profile  $\bar{\sigma}_{-\mathbb{L}}$  such that  $\bar{\sigma}$  is an  $\mathbb{L}$ -fixed SPE. The set of Nash (resp. subgame-perfect) responses to  $\sigma_{\mathbb{L}}$  is written  $\text{NR}(\sigma_{\mathbb{L}})$  (resp.  $\text{SPR}(\sigma_{\mathbb{L}})$ ).

Finally, let  $\rho \in \{\text{Nash, subgame-perfect}\}$ . We then call  $\rho$ -*equilibria* the Nash equilibria when  $\rho = \text{Nash}$ , and the subgame-perfect equilibria when  $\rho = \text{subgame-perfect}$ . We will similarly talk about  $\mathbb{L}$ -fixed  $\rho$ -*equilibria*, and  $\rho$ -*responses*. We write  $\rho\text{R}(\sigma_{\mathbb{L}})$  the set of  $\rho$ -responses to a strategy  $\sigma_{\mathbb{L}}$ .

## 2.5 Mealy machines

A *multiplayer Mealy machine* on a game  $\mathcal{G}$  is a tuple  $\mathcal{M} = (Q, q_0, \Delta)$  where  $Q$  is a finite set of *states*, where  $q_0 \in Q$  is the *initial state*, and where  $\Delta \subseteq (Q \times V \times Q \times V)$  is a finite set of *transitions*, such that for every  $(p, u, q, v) \in \Delta$ , we have  $uv \in E$ , and such that for every  $p \in Q$  and  $u \in V$ , there exists a transition  $(p, u, q, v) \in \Delta$ . The specialist reader will have noted that this definition is more general than the classical one, in which it is often assumed that for each  $p$  and  $u$ , there exists exactly one such transition. Hereafter, such a Mealy machine will be called *deterministic Mealy machine*. Results about deterministic Mealy machines can be applied to *programs*, which are supposed to run deterministically; we chose to take a more general definition to capture also *protocols*, which may be given to agents who would still have some room for manoeuvre in how they apply it.

A strategy profile  $\bar{\sigma}$  in  $\mathcal{G}_{\uparrow v_0}$  is *compatible* with  $\mathcal{M}$  if there exists a mapping  $h \mapsto q_h$  that maps every history  $h$  in  $\mathcal{G}_{\uparrow v_0}$  to a state  $q_h \in Q$ , such that for every  $hv \in \text{Hist} \mathcal{G}_{\uparrow v_0}$ , we have  $(q_h, v, q_{hv}, \bar{\sigma}(hv)) \in \Delta$ . The set of strategy profiles in  $\mathcal{G}_{\uparrow v_0}$  compatible with  $\mathcal{M}$  is written  $\text{Comp}_{\uparrow v_0}(\mathcal{M})$ . If  $\mathcal{M}$  is deterministic, then there is exactly one strategy profile compatible with  $\mathcal{M}$ ; we call it a *finite-memory* strategy profile.

A *Mealy machine for player  $i$*  on a game  $\mathcal{G}$  is a tuple  $\mathcal{M} = (Q, q_0, \Delta)$  where  $Q$  is a finite



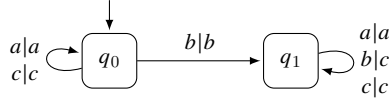

Figure 2: A deterministic multiplayer Mealy machine

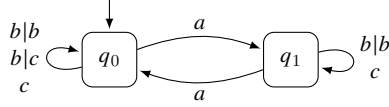

Figure 3: A non-deterministic one-player Mealy machine

set of *states*, where  $q_0 \in Q$  is the *initial state*, and where  $\Delta \subseteq (Q \times V_{-i} \times Q) \cup (Q \times V_i \times Q \times V)$  is a finite set of *transitions*, such that for every  $(p, u, q)$  or  $(p, u, q, v) \in \Delta$ , we have  $uv \in E$ , and such that for every  $p \in Q$  and  $u \in V$ , there exists a transition  $(p, u, q)$  or  $(p, u, q, v) \in \Delta$ . Again, a one-player Mealy machine is *deterministic* if for each  $p$  and  $u$ , there exists exactly one such transition.

The strategies *compatible* with  $\mathcal{M}$ , as well as *finite-memory* strategies, are defined analogously to the multiplayer case.

Every Mealy machine  $\mathcal{M}$  can be encoded with a finite number of bits. We write  $\|\mathcal{M}\|$  that number.

As an example, Figures 2 and 3 depict two Mealy machines on the game of Figure 1. Each arrow from a state  $p$  to a state  $q$  labeled  $u|v$  denotes the existence of a transition  $(p, u, q, v)$  (from the state  $p$ , the machine reads the vertex  $u$ , it switches to the state  $q$  and outputs the vertex  $v$ ). Each arrow from a state  $p$  to a state  $q$  labeled  $u$  denotes the existence of a transition  $(p, u, q)$  (from the state  $p$ , the machine reads the vertex  $u$ , it switches to the state  $q$  and outputs nothing). The first one is a deterministic multiplayer Mealy machine. The only strategy profile compatible with it can be described as follows: from the vertex  $a$ , player  $\circ$  stays in  $a$ . If she goes to the vertex  $b$ , then player  $\square$  loops once on  $b$ , and then goes to the vertex  $c$ . The second one is a machine for player  $\square$ , that is not deterministic: from the state  $q_0$ , reading the vertex  $b$ , the machine stays in  $q_0$  but it can output either  $b$  or  $c$ . The strategies that are compatible with it can be described as follows: when player  $\square$  has to play, if the vertex  $a$  was seen an odd number of times, then he stays in  $b$ ; in the opposite case, he can either stay in  $b$  or eventually go to  $c$ .

## 2.6 Decision problems

Let us now define the decision problems we are studying in this paper. The following problems are defined for each class of games  $\mathcal{C}$ , for each  $\rho \in \{\text{Nash, subgame-perfect}\}$ , and in both deterministic and non-deterministic setting.

**Problem 1** ((Deterministic)  $\rho$ -checking problem in the class  $\mathcal{C}$ ). Given a game  $\mathcal{G}_{\uparrow v_0} \in \mathcal{C}$  and a (deterministic) Mealy machine  $\mathcal{M}$  on  $\mathcal{G}$ , is every  $\bar{\sigma} \in \text{Comp}_{\uparrow v_0}(\mathcal{M})$  a  $\rho$ -equilibrium?

**Problem 2** ((Deterministic)  $\rho$ -rational verification problem in the class  $\mathcal{C}$ ). Given a game  $\mathcal{G}_{\uparrow v_0} \in \mathcal{C}$ , a threshold  $t \in \mathbb{Q}$  and a (deterministic) Mealy machine  $\mathcal{M}$  on  $\mathcal{G}$ , is every  $\mathbb{L}$ -fixed  $\rho$ -equilibrium  $\bar{\sigma}$  with  $\sigma_{\mathbb{L}} \in \text{Comp}_{\uparrow v_0}(\mathcal{M})$  such that  $\mu_{\mathbb{L}}(\langle \bar{\sigma} \rangle) > t$ ?

Note that every SPE is an NE. So, for the checking problems, a positive instance for SPEs is also a positive instance for NEs. And conversely, for rational verification problems, a positive instance for NEs is also a positive instance for SPEs.

## 2.7 A characterization of Nash equilibria

Before moving on to our results, let us end this section with a lemma that will be used often along this paper, stating that an NE outcome is a play in which no player has a payoff smaller than what they can enforce when they deviate, and when all the other players make everything they can to punish them. That is a classical result that can be found under various wordings (see for instance Theorem 1 in [5]); here, we present it under the form that will be the most useful for us hereafter.

**Lemma 1.** *In every game  $\mathcal{G}$ , the NE outcomes are exactly the plays  $\pi$  such that for each player  $i$ , for every vertex  $\pi_k \in V_i$ , there exists a strategy profile  $\bar{\tau}_{-i}^k$  from  $\pi_k$  such that  $\sup_{\tau_i} \mu_i(\pi_{<k} \langle \bar{\tau}_{-i}^k, \tau_i \rangle) \leq \mu_i(\pi)$ .*

*Proof.* Let  $\pi$  be a Nash equilibrium outcome, and let  $\bar{\sigma}$  be an NE such that  $\langle \bar{\sigma} \rangle = \pi$ : then, for each  $i$  and every  $\pi_k$ , the strategy profile  $\bar{\sigma}_{\upharpoonright \pi_{\leq k}}$  satisfies the hypothesis given above. Conversely, if such strategy profiles exist, then we can define  $\bar{\sigma}$  as the strategy profile that follows the play  $\pi$  and that, after a one-shot deviation  $\pi_{\leq k} \nu$  with  $\nu \neq \pi_{k+1}$ , follows the strategy profile  $\tau_{-i}^k$ , and any strategy for player  $i$ .  $\square$

In the next section, we present two general constructions that we will use in the rest of the paper.

## 3 General tools

### 3.1 To solve checking problems: the deviation games

Deciding the checking problems amounts to searching for a profitable deviation, either to the outcome (Nash-checking problem) or in some subgame (subgame-perfect-checking problem). That can be achieved through a new game structure, called *deviation game*, in which a play simulates two parallel plays in the original game: one in which the players have to follow the outputs of the Mealy machine, and one in which one of them is allowed to deviate from it. In that game, two fresh players will measure the payoffs of the deviating player in the original game: one, called *Adam*, is measuring the player's payoff in the non-deviating play, and the other one, called *Eve*, is measuring their payoff in the deviating one.

**Definition 6** (Deviation games). Let  $\mathcal{G}_{\upharpoonright v_0}$  be a game, and let  $\mathcal{M}$  be a multiplayer Mealy machine in  $\mathcal{G}_{\upharpoonright v_0}$ . The associated *Nash deviation game* is the game  $\text{NDev}(\mathcal{G}, \mathcal{M})_{\upharpoonright (q_0, v_0)} = (\{\mathbb{A}, \mathbb{E}\}, V', (V'_{\mathbb{A}}, V'_{\mathbb{E}}), E', \mu')$ , where:

- the players are *Adam*, written  $\mathbb{A}$ , and *Eve*, written  $\mathbb{E}$ .
- The vertex space is  $V' = \{(q_0, v_0)\} \cup (Q \times V \times \Pi) \cup (Q \times V \times \Pi \times Q \times V)$ , and Eve controls every vertex.
- The set  $E'$  contains:
  - the edge  $(q_0, v_0)(q, v, i)$  for each player  $i \in \Pi$  and each transition  $(q_0, v_0, q, v) \in \Delta$  (the player  $i$  is chosen as the deviating player);
  - the edge  $(q_0, v_0)(q, v, i, q, v')$  for each player  $i \in \Pi$ , each transition  $(q_0, v_0, q, v) \in \Delta$ , and each edge  $v_0 v' \in E$  with  $v' \neq v$  (the player  $i$  is chosen as the deviating player, and starts to deviate immediately);

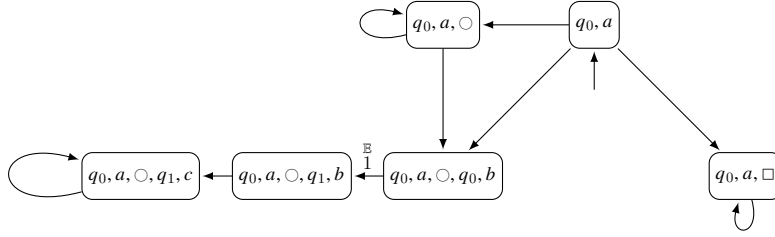

Figure 4: A Nash deviation game

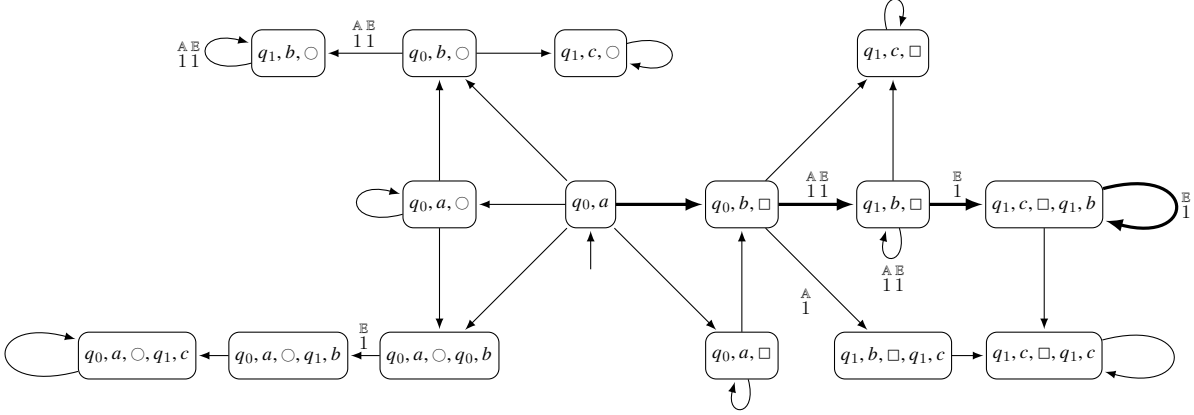

Figure 5: A subgame-perfect deviation game

- the edge  $(p, u, i)(q, v, i)$  for each  $(p, u, q, v) \in \Delta$  (player  $i$  has not started to deviate yet);
- the edge  $(p, u, i)(q, v, i, q, v')$  for each transition  $(p, u, q, v) \in \Delta$  with  $u \in V_i$  and each edge  $uv' \in E$  with  $v' \neq v$  (player  $i$  starts to deviate);
- the edge  $(p, u, i, p', u')(q, v, i, q', v')$  for every two transitions  $(p, u, q, v), (p', u', q', w) \in \Delta$  with either  $w = v'$  or  $u' \in V_i$  (player  $i$  is deviating).

- Let  $\pi$  be a play in this game, of the form:

$$\pi = (q_0, v_0)(q_1, v_1, i) \dots (q_{k-1}, v_{k-1}, i) \\ (q_k, v_k, i, q'_k, v'_k)(q_{k+1}, v_{k+1}, i, q'_{k+1}, v'_{k+1}) \dots$$

Then, we define  $\mu'_A(\pi) = \mu(v_0 \dots v_k v_{k+1} \dots)$ , and  $\mu'_E(\pi) = \mu(v_0 \dots v_k v'_{k+1} \dots)$ . When  $\pi$  has the form  $\pi = (q_0, v_0)(q_1, v_1, i)(q_2, v_2, i) \dots$ , i.e. when player  $i$  does never deviate, we define  $\mu'_A(\pi) = \mu'_E(\pi) = \mu(v_0 v_1 v_2 \dots)$ .

The *subgame-perfect deviation game*  $\text{SPDev}(\mathcal{G}, \mathcal{M})_{\uparrow(q_0, v_0)}$  is defined similarly with, additionally:

- the edge  $(p, u, i)(q, w, i)$  for each player  $i \in \Pi$ , each transition  $(p, u, q, v) \in \Delta$  and each edge  $uw \in E$  (player  $i$  has not started to deviate, and Eve is looking for a subgame in which a profitable deviation exists);
- the edge  $(q_0, v_0)(q, w, i)$  for each  $(q_0, v_0, q, v) \in \Delta$  and every  $v_0 w \in E$  (player  $i$  is chosen as the deviating player, and Eve is looking for a subgame).

As an example, if  $\mathcal{G}_{\uparrow v_0}$  is the game of Figure 1 and if  $\mathcal{M}$  is the machine given in Figure 2, then Figure 4 represents the game  $\text{NDev}(\mathcal{G}_{\uparrow v_0}, \mathcal{M})$ , and Figure 5 represents the game  $\text{SPDev}(\mathcal{G}_{\uparrow v_0}, \mathcal{M})$ . For the sake of readability, the vertices that are not accessible from  $(q_0, v_0)$  have been omitted. These games are also mean-payoff games, and the rewards are given on the figures — the rewards equal to 0 have been omitted. On Figure 5, the thick arrows highlight a play that gives a better payoff to Eve than to Adam; as we will see now, that means that the only strategy profile compatible with the machine  $\mathcal{M}$  is not an SPE. No such play can be found on the game of Figure 4, because that strategy profile is an NE. In other words, the game  $\mathcal{G}_{\uparrow v_0}$  and the machine  $\mathcal{M}$  form a positive instance of the (deterministic) Nash checking problem, but not of the (deterministic) subgame-perfect checking problem.

**Theorem 1** (App. A). *There exists a strategy profile  $\bar{\sigma} \in \text{Comp}_{\uparrow v_0}(\mathcal{M})$  that is not an NE (resp. SPE) if and only if there exists a play  $\pi$  in the game  $\text{NDev}(\mathcal{G}, \mathcal{M})_{\uparrow(q_0, v_0)}$  (resp.  $\text{SPDev}(\mathcal{G}, \mathcal{M})_{\uparrow(q_0, v_0)}$ ) such that  $\mu_{\mathbb{A}}(\pi) < \mu_{\mathbb{E}}(\pi)$ .*

In other words, the checking problems amount to solve the following problem in the deviation games.

**Problem 3** (Privilege problem in the class  $\mathcal{C}$ ). Given a game  $\mathcal{G}_{\uparrow v_0} \in \mathcal{C}$  with two players  $\mathbb{A}$  and  $\mathbb{E}$ , called *Adam* and *Eve*, is every play  $\pi$  in  $\mathcal{G}_{\uparrow v_0}$  such that  $\mu_{\mathbb{A}}(\pi) \geq \mu_{\mathbb{E}}(\pi)$ ?

Moreover, the size of the deviations games are bounded by a polynomial function of  $\|\mathcal{G}\|$  and  $\|\mathcal{M}\|$ ; and, when the game  $\mathcal{G}$  belongs to a class  $\mathcal{C}$  among the five classes defined in Section 2.2, then all deviation games that can be constructed from it also belong to the class  $\mathcal{C}$ . Hence the following.

**Corollary 1.** *Let  $\mathcal{C}$  be a class of games, among the classes of parity games, mean-payoff games, quantitative reachability games, energy games, and discounted-sum games. Then, in the class  $\mathcal{C}$ , the Nash-checking and the subgame-perfect checking problems, deterministic or not, reduce to the privilege problem.*

### 3.2 To solve rational verification: the product game

Although very intuitive, the rational verification problems are quite hard to study as they are. That is because their instances include two graph structures: a game, and a Mealy machine. However, for the environment of Leader, responding rationally to Leader's strategies that are compatible with  $\mathcal{M}$  amounts to play rationally in a greater game, in which the memory states of Leader have been incorporated in the arena.

**Definition 7** (Product game). Let  $\mathcal{G}_{\uparrow v_0}$  be a game, and let  $\mathcal{M}$  be a Mealy machine for Leader in  $\mathcal{G}$ . Their *product game* is the game  $\mathcal{G}_{\uparrow v_0} \otimes \mathcal{M} = (\Pi \cup \{\mathbb{D}\}, V', (V'_i)_i, E', \mu')$  where the player  $\mathbb{D}$ , called *Demon*, interpretes the non-deterministic choices of the machine  $\mathcal{M}$ . Formally:

- $V' = (V \times Q) \cup (V \times Q \times Q)$ ;
- $V'_{\mathbb{L}} = \emptyset$ ,  $V'_i = V_i \times Q \times Q$  for every  $i \in \Pi \setminus \{\mathbb{L}\}$ , and  $V'_{\mathbb{D}} = (V \times Q) \cup (V_{\mathbb{L}} \times Q \times Q)$ ;
- the set  $E'$  contains:
  - the edge  $(u, p)(u, p, q)$  for each transition  $(p, u, q) \in \Delta$  (with  $u \notin V_{\mathbb{L}}$ ), or  $(p, u, q, v) \in \Delta$  (with  $u \in V_{\mathbb{L}}$ );

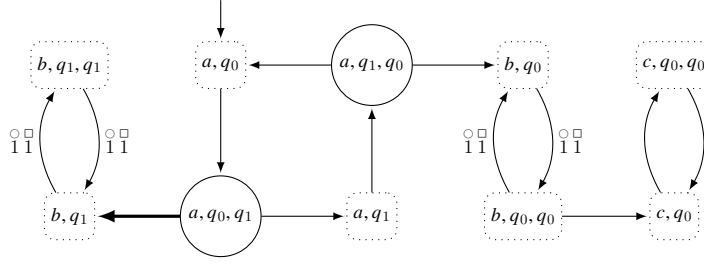

Figure 6: A product game

- the edge  $(u, p, q)(v, q)$  for each transition  $(p, u, q, v) \in \Delta$  (with  $u \in V_{\mathbb{L}}$ );
- the edge  $(u, p, q)(v, q)$  for each transition  $(p, u, q) \in \Delta$ , and each edge  $uv \in E$  (with  $u \notin V_{\mathbb{L}}$ );
- each payoff function  $\mu'_i$  maps every play  $(\pi_0, q_0)(\pi_0, q_0, q_1)(\pi_1, q_1) \dots$  to the payoff  $\mu_i(\pi)$  if  $i \neq \mathbb{D}$ , and to the payoff 0 if  $i = \mathbb{D}$ .

As an example, we have represented on Figure 6 the game  $\mathcal{G}_{\uparrow v_0} \otimes \mathcal{M}$ , when  $\mathcal{G}_{\uparrow v_0}$  is the game of Figure 1 and  $\mathcal{M}$  the machine of Figure 3. Leader is then assimilated to player  $\square$ , and Demon's vertices are represented by dotted boxes. Again, the unreachable vertices have been omitted, and we have given only the non-zero rewards. Since, from the vertex  $(a, q_0, q_1)$ , player  $\circ$  has always the possibility to go to the vertex  $(b, q_1)$  and to get the payoff 1, it can be shown that every NE and every SPE in that game gives player  $\square$  the payoff 1. As we will see now, that means that the strategies compatible with the machine  $\mathcal{M}$  guarantee the payoff 1 to player  $\square$  against Nash-rational or subgame-perfect rational responses, i.e. that  $\mathcal{G}_{\uparrow v_0}, 1$ , and  $\mathcal{M}$  form a positive instance of the Nash and subgame-perfect rational verification problems.

**Theorem 2** (App. B). *Let  $\rho \in \{\text{Nash}, \text{subgame-perfect}\}$ . Let  $\mathcal{G}_{\uparrow v_0}$  be a game, let  $\mathcal{M}$  be a Mealy machine for Leader in  $\mathcal{G}$ , and let  $t \in \mathbb{Q}$ . Then, every  $\rho$ -response  $\bar{\sigma}_{-\mathbb{L}}$  to every strategy  $\sigma_{\mathbb{L}} \in \text{Comp}_{\uparrow v_0}(\mathcal{M})$  satisfies  $\mu_{\mathbb{L}}(\langle \bar{\sigma} \rangle) > t$  if and only if every  $\rho$ -equilibrium  $\bar{\tau}$  in the game  $\mathcal{G}_{\uparrow v_0} \otimes \mathcal{M}$  satisfies  $\mu'_{\mathbb{L}}(\langle \bar{\tau} \rangle) > t$ .*

Thus, we find the following problem, simpler in its wording and already studied in various settings in the literature:

**Problem 4** ( $\rho$ -universal threshold problem in the class  $\mathcal{C}$ ). Given a game  $\mathcal{G}_{\uparrow v_0} \in \mathcal{C}$ , a player  $i \in \Pi$ , and a threshold  $t \in \mathbb{Q}$ , is every  $\rho$ -equilibrium  $\bar{\sigma}$  in  $\mathcal{G}_{\uparrow v_0}$  such that  $\mu_i(\langle \bar{\sigma} \rangle) > t$ ?

Moreover, the size of the product game is bounded by a polynomial function of  $\|\mathcal{G}\|$  and  $\|\mathcal{M}\|$ ; and when the game  $\mathcal{G}$  belongs to a class  $\mathcal{C}$  of games among the five classes defined in Section 2.2, then all deviation games that can be constructed from it also belong to the class  $\mathcal{C}$ . Hence the following.

**Corollary 2.** *Let  $\mathcal{C}$  be a class among the classes of parity games, mean-payoff games, quantitative reachability games, energy games, and discounted-sum games. Then, in the class  $\mathcal{C}$ , for a given  $\rho \in \{\text{Nash}, \text{subgame-perfect}\}$ , the three following problems are reducible to each other in polynomial time:*

- the  $\rho$ -universal threshold problem;
- the  $\rho$ -rational verification problem;

- *the deterministic  $\rho$ -rational verification problem.*

*Proof.* • *The deterministic  $\rho$ -rational verification problem reduces to the  $\rho$ -rational verification problem, because a non-deterministic Mealy machine is a Mealy machine.*

- *The  $\rho$ -universal threshold problem reduces to the deterministic  $\rho$ -rational verification problem.*

Let  $\mathcal{G}_{\uparrow v_0}$ ,  $i$  and  $t$  form an instance of the  $\rho$ -universal threshold problem. We define the game  $\mathcal{G}'_{\uparrow v_0}$  as equal to the game  $\mathcal{G}_{\uparrow v_0}$ , where a Leader has been added to the set of players, but controls no vertex. We define the payoff function  $\mu_{\mathbb{L}} = \mu_i$ . Thus, if  $\mathcal{G}$  belongs to the class  $\mathcal{C}$ , so does  $\mathcal{G}'$ . We define  $\mathcal{M}$  as the one-state deterministic Mealy machine on  $\mathcal{G}'$  that never outputs anything.

Then, a strategy profile  $\bar{\sigma}$  in  $\mathcal{G}'_{\uparrow v_0}$  is an  $\mathbb{L}$ -fixed  $\rho$ -equilibrium, if and only if it is an  $\mathbb{L}$ -fixed  $\rho$ -equilibrium with  $\sigma_{\mathbb{L}} \in \text{Comp}_{\uparrow v_0}(\mathcal{M})$ , if and only if the strategy profile  $\bar{\sigma}_{-\mathbb{L}}$  is a  $\rho$ -equilibrium in the game  $\mathcal{G}_{\uparrow v_0}$ . As a consequence  $\mathcal{G}_{\uparrow v_0}$ ,  $i$ , and  $t$  form a positive instance of the  $\rho$ -universal threshold problem, if and only if  $\mathcal{G}'_{\uparrow v_0}$ ,  $\mathcal{M}$ , and  $t$  form a positive instance of the deterministic  $\rho$ -rational verification problem. Moreover, the latter can be constructed from the former in polynomial time.

- *The  $\rho$ -rational verification problem reduces to the  $\rho$ -universal threshold problem.*

By Theorem 2, and since the product game  $\mathcal{G}_{\uparrow v_0} \otimes \mathcal{M}$  can be constructed from  $\mathcal{G}_{\uparrow v_0}$  and  $\mathcal{M}$  in polynomial time.  $\square$

While Corollary 1 states the existence of a reduction in one direction, this corollary says that the three mentioned problems are inter-reducible. Thus, it will enable us to provide upper, but also lower bounds to the rational verification problems.

## 4 Parity games

Let us now apply those general constructions to our first class of games, and the easiest to study: parity games.

### 4.1 Checking problems

By Corollary 1, in parity games, the checking problems reduce to the privilege problem, which consists in finding a play in a given game that satisfies a parity condition and that falsify another. That can be done in polynomial time.

**Theorem 3.** *In the class of parity games, the Nash-checking and the subgame-perfect checking problems, deterministic or not, can be decided in polynomial time.*

*Proof.* By Corollary 1, those four problems reduce to the privilege problem. Let  $\mathcal{G}_{\uparrow v_0}$  be a parity game in which there exists a play  $\pi$  such that  $\mu_{\mathbb{A}}(\pi) < \mu_{\mathbb{B}}(\pi)$ . Then, we have  $\mu_{\mathbb{A}}(\pi) = 0$ , and  $\mu_{\mathbb{B}}(\pi) = 1$ . Therefore, there exist two vertices  $u, v \in \text{Inf}(\pi)$ , such that  $\kappa_{\mathbb{A}}(u)$  is odd,  $\kappa_{\mathbb{B}}(v)$  is even, and there exists a path from  $u$  to  $v$  and a path from  $v$  to  $u$  that both traverse only vertices  $w$  such that  $\kappa_{\mathbb{A}}(w) \geq \kappa_{\mathbb{A}}(w)$  and  $\kappa_{\mathbb{B}}(w) \geq \kappa_{\mathbb{B}}(w)$ . Conversely, if such vertices  $u$  and  $v$  exist, then there exists a play  $\pi$  satisfying  $\mu_{\mathbb{A}}(\pi) < \mu_{\mathbb{B}}(\pi)$ . The existence of such vertices can be checked in polynomial time.  $\square$

## 4.2 Rational verification

As for rational verification problems, they reduce by Corollary 2 to universal threshold problems, which are subproblems of problems already studied in [33], [34], and later in [7]. In a nutshell, those problems belong to the class  $\text{coNP}$ , because when there exists a NE or SPE outcome that makes some player  $i$  lose, there exists one that has a simple form, and that can be guessed in polynomial time. The lower bounds can be obtained by a slight adaptation on a reduction from  $\text{COSAT}$  that was already presented in [33].

**Theorem 4** (App. C). *In the class of parity games, the Nash rational and the subgame-perfect rational verification problems, deterministic or not, are  $\text{coNP}$ -complete.*

## 5 Mean-payoff games

While parity objectives constitute a core class in the study of qualitative objectives, mean-payoff objectives occupy a similar place among quantitative objectives.

### 5.1 Checking problems

As in parity games, Corollary 1 enables us to solve the checking problems in polynomial time, since the privilege problem itself reduces to the search of a negative cycle.

**Theorem 5.** *In the class of mean-payoff games, the Nash-checking and the subgame-perfect checking problems, deterministic or not, can be decided in polynomial time.*

*Proof.* By Corollary 1, those four problems reduce to the privilege problem. Let  $\mathcal{G}_{\uparrow v_0}$  be a mean-payoff game. If every simple cycle  $c$  accessible from  $v_0$  is such that  $\text{MP}_{\mathbb{A}}(c) \geq \text{MP}_{\mathbb{B}}(c)$ , then we also have  $\mu_{\mathbb{A}}(\pi) \geq \mu_{\mathbb{B}}(\pi)$  for every play  $\pi$ ; conversely, if there is a simple cycle  $c$  accessible from  $v_0$  such that  $\text{MP}_{\mathbb{A}}(c) < \text{MP}_{\mathbb{B}}(c)$ , then there is a play  $\pi$  in  $\mathcal{G}_{\uparrow v_0}$  such that  $\mu_{\mathbb{A}}(\pi) < \mu_{\mathbb{B}}(\pi)$  — a play that reaches that cycle and loops there forever. Such a cycle can also be seen as a negative cycle for the reward function  $r = r_{\mathbb{A}} - r_{\mathbb{B}}$ . Note that the equality  $\underline{\text{MP}}_r(\pi) = \underline{\text{MP}}_{\mathbb{A}}(\pi) - \underline{\text{MP}}_{\mathbb{B}}(\pi)$  does not hold for every play  $\pi$  (because the limit inferior and the additive inverse do not commute in general), but it does when  $\pi$  has the form  $c^\omega$ .

Thus, an algorithm that solves the privilege problem in polynomial time consists in searching for such a negative cycle, using Bellman-Ford's algorithm.  $\square$

### 5.2 Rational verification

Again, the reduction to universal threshold problems enables to apply results and methods that already exist in the literature.

**Theorem 6** (App. D). *In the class of mean-payoff games, the Nash rational and the subgame-perfect rational verification problems, deterministic or not, are  $\text{coNP}$ -complete.*

### 5.3 The temptation of chaos

It is worth noting here that the definition we gave of rational verification entails, in the case of mean-payoff games, results that may be considered as counter-intuitive. For instance, consider the game of Figure 7, where Leader owns no vertex, and consider the only (vacuous) strategy available for Leader. Does that strategy guarantee a payoff greater than 1?

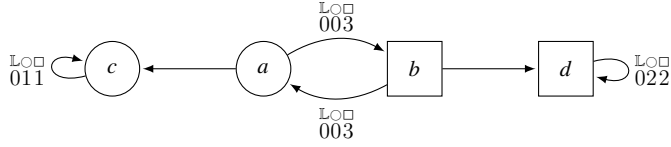

Figure 7: The temptation of chaos: an illustration

Intuitively, it does not, since Leader always receives the payoff 0. But still, that strategy, that game, and that threshold form a positive instance of subgame-perfect rational verification, because no  $\mathbb{L}$ -fixed SPE exists in that game (see [5]). More generally, the definition we give of rational verification considers that a *good* strategy for Prover is a strategy such that for every response of the environment that is rational, the generated outcome observes some specification. But a strategy is then good, in that sense, if *no* rational response of the environment exists, which can occur in mean-payoff games.

## 5.4 Achaotic rational verification: a definition

To avoid such phenomena, we introduce an alternative definition of rational verification, *achaotic rational verification*: a good strategy for Leader will be a strategy that guarantees the specification (here, always a threshold for Leader’s payoff) against every response of the environment that is *as rational as possible*. To define that new problem, we need to define quantitative relaxations to the notions of NEs and SPEs.

Let  $\mathcal{G}_{\uparrow v_0}$  be a game and let  $\varepsilon \geq 0$ . The strategy profile  $\bar{\sigma}$  is an  $\varepsilon$ -NE (resp.  $\mathbb{L}$ -fixed  $\varepsilon$ -NE) in  $\mathcal{G}_{\uparrow v_0}$  if and only if for each player  $i$  (resp. each  $i \neq \mathbb{L}$ ) and for every strategy  $\sigma'_i$ , called *deviation of  $\sigma_i$* , we have the inequality  $\mu_i(\langle \sigma'_i, \bar{\sigma}_{-i} \rangle) \leq \mu_i(\langle \bar{\sigma} \rangle) + \varepsilon$ . The strategy profile  $\bar{\sigma}$  is an ( $\mathbb{L}$ -fixed)  $\varepsilon$ -SPE in  $\mathcal{G}_{\uparrow v_0}$  if and only if for every history  $h$  in  $\mathcal{G}_{\uparrow v_0}$  (resp. every history  $h$  compatible with  $\bar{\sigma}_{-\mathbb{L}}$ ), the strategy profile  $\bar{\sigma}_{\uparrow h}$  is a ( $\mathbb{L}$ -fixed)  $\varepsilon$ -NE in the subgame  $\mathcal{G}_{\uparrow h}$ .

Now, let  $\sigma_{\mathbb{L}}$  be a strategy for Leader in a game  $\mathcal{G}_{\uparrow v_0}$ , and let  $\varepsilon \geq 0$ . An  $\varepsilon$ -Nash response (resp.  $\varepsilon$ -subgame-perfect response) to  $\sigma_{\mathbb{L}}$  is a strategy profile  $\bar{\sigma}_{-\mathbb{L}}$  such that the strategy profile  $\bar{\sigma} = (\sigma_{\mathbb{L}}, \bar{\sigma}_{-\mathbb{L}})$  is an  $\mathbb{L}$ -fixed  $\varepsilon$ -NE (resp.  $\mathbb{L}$ -fixed  $\varepsilon$ -SPE). The set of  $\varepsilon$ -Nash (resp.  $\varepsilon$ -subgame-perfect, resp.  $\varepsilon\rho$ ) responses to  $\sigma_{\mathbb{L}}$  is denoted by  $\varepsilon\text{NR}(\sigma_{\mathbb{L}})$  (resp.  $\varepsilon\text{SPR}(\sigma_{\mathbb{L}})$ , resp.  $\varepsilon\rho\text{R}(\sigma_{\mathbb{L}})$ ).

Note that 0-NEs coincide with NEs, 0-SPEs with SPEs, and so on: those notions are generalizations of the notions we have studied so far. We can now define our new decision problem.

**Problem 5** (Achaotic (deterministic)  $\rho$ -rational verification in the class  $\mathcal{C}$ ). Given a game  $\mathcal{G}_{\uparrow v_0} \in \mathcal{C}$ , a threshold  $t \in \mathbb{Q}$ , and a Mealy machine (resp. a deterministic Mealy machine)  $\mathcal{M}$  on  $\mathcal{G}$ , does there exist  $\varepsilon \geq 0$  satisfying:

- $\varepsilon\rho\text{R}(\sigma_{\mathbb{L}}) \neq \emptyset$  for some strategy  $\sigma_{\mathbb{L}} \in \text{Comp}_{\uparrow v_0}(\mathcal{M})$ ;
- and  $\mu_{\mathbb{L}}(\langle \sigma_{\mathbb{L}}, \bar{\sigma}_{-\mathbb{L}} \rangle) > t$  for every strategy  $\sigma_{\mathbb{L}} \in \text{Comp}_{\uparrow v_0}(\mathcal{M})$ , and for every response  $\bar{\sigma}_{-\mathbb{L}} \in \varepsilon\rho\text{R}(\sigma_{\mathbb{L}})$ ?

Intuitively: is there a level of rationality that is achievable for the environment, and that enforce the specification?



## 5.5 Coincidence with rational verification in other settings

Among all the problems we are studying here, the temptation of chaos is a phenomenon that affects only one case: subgame-perfect rational verification in mean-payoff games. In every other cases, the rational verification problems are equivalent to their achaotic versions, because Nash responses and subgame-perfect responses are guaranteed to exist.

**Proposition 1** (App. E). *Let  $\mathcal{C}$  be a class of games, among the classes of parity games, quantitative reachability games, energy games, and discounted-sum games.*

*Let  $\rho \in \{\text{Nash}, \text{subgame-perfect}\}$ . Then, the positive instances of the achaotic  $\rho$ -rational verification problem in  $\mathcal{C}$  are exactly the positive instances of the  $\rho$ -rational verification problem. Similarly, the positive instances of the achaotic Nash-rational verification problem in mean-payoff games are exactly the positive instances of the  $\rho$ -rational verification problem.*

## 5.6 Complexity

Now, an optimal algorithm for achaotic subgame-perfect rational verification in mean-payoff games requires the following technical lemma: there exists a least  $\varepsilon$  such that  $\varepsilon$ -SPEs exist, and it can be written with a polynomially bounded number of bits. To prove that, we need to use the notion of *negotiation function*, defined in [5]: a function from vertex labellings to vertex labellings whose least  $\varepsilon$ -fixed point (i.e., the least vertex labelling  $\lambda$  that is a fixed point of that function up to  $\varepsilon$ ) characterizes  $\varepsilon$ -SPEs. Our result can be obtained by revisiting a proof of [6], that was designed to bound the number of bits required to write that least  $\varepsilon$ -fixed point, for a fixed  $\varepsilon$ .

**Lemma 2** (App. F). *There exists a polynomial  $P_1$  such that in every mean-payoff game  $\mathcal{G}_{\uparrow v_0}$ , there exists  $\varepsilon_{\min}$  with  $\|\varepsilon_{\min}\| \leq P_1(\|\mathcal{G}\|)$  such that  $\varepsilon_{\min}$ -SPEs exist in  $\mathcal{G}_{\uparrow v_0}$ , and  $\varepsilon$ -SPEs, for every  $\varepsilon < \varepsilon_{\min}$ , do not.*

We are now equipped to prove the following theorem.

**Theorem 7** (App. G). *In the class of mean-payoff games, the achaotic subgame-perfect rational verification problem, deterministic or not, is  $\text{P}^{\text{NP}}$ -complete.*

*Proof sketch.* Using Lemma 2 and the same arguments as in the proof of Theorem 2, those two problems are interreducible with the following one: given a game  $\mathcal{G}_{\uparrow v_0}$  and a threshold  $t \in \mathbb{Q}$ , does every  $\varepsilon_{\min}$ -SPE  $\bar{\sigma}$  in  $\mathcal{G}_{\uparrow v_0}$  satisfy  $\mu_{\mathbb{L}}(\langle \bar{\sigma} \rangle) > t$ ? Let us prove that that problem is  $\text{P}^{\text{NP}}$ -complete.

- *Easiness.* By [6], there is an NP algorithm deciding, given  $\varepsilon$  and  $\mathcal{G}_{\uparrow v_0}$ , whether there is an  $\varepsilon$ -SPE in  $\mathcal{G}_{\uparrow v_0}$ , i.e. whether  $\varepsilon \geq \varepsilon_{\min}$ . We know, moreover, that  $\varepsilon_{\min} \leq 2 \max_i \max_{uv} |r_i(uv)|$ . Using Lemma 2, a dichotomic search can thus compute  $\varepsilon_{\min}$  using polynomially many calls to that algorithm. Then, one last call can decide whether there exists an  $\varepsilon_{\min}$ -SPE  $\bar{\sigma}$  such that  $\mu_i(\langle \bar{\sigma} \rangle) \leq t$ .
- *Hardness.* We proceed by reduction from the following  $\text{P}^{\text{NP}}$ -complete problem: given a Boolean formula  $\varphi$  in conjunctive normal form over the ordered variables  $x_1, \dots, x_n$ , is the lexicographically first valuation  $v_{\min}$  satisfying  $\varphi$  such that  $v_{\min}(x_n) = 1$ ? Let us write  $\varphi = \bigwedge_{j=1}^p C_j$ . We construct a game  $\mathcal{G}_{\uparrow a}$ , with a player called *Witness* and written  $\mathbb{W}$ , in which there exists an  $\varepsilon_{\min}$ -SPE  $\bar{\sigma}$  such that  $\mu_{\mathbb{W}}(\langle \bar{\sigma} \rangle) \leq 0$  if and only if  $\varphi$  is satisfiable and  $v_{\min}(x_n) = 1$ . That game, depicted in Figure 8, has  $2n + p + 4$  players: the literal players  $x_1, \neg x_1, \dots, x_n, \neg x_n$ ; the clause players  $C_1, \dots, C_p$ ; the player *Solver*,

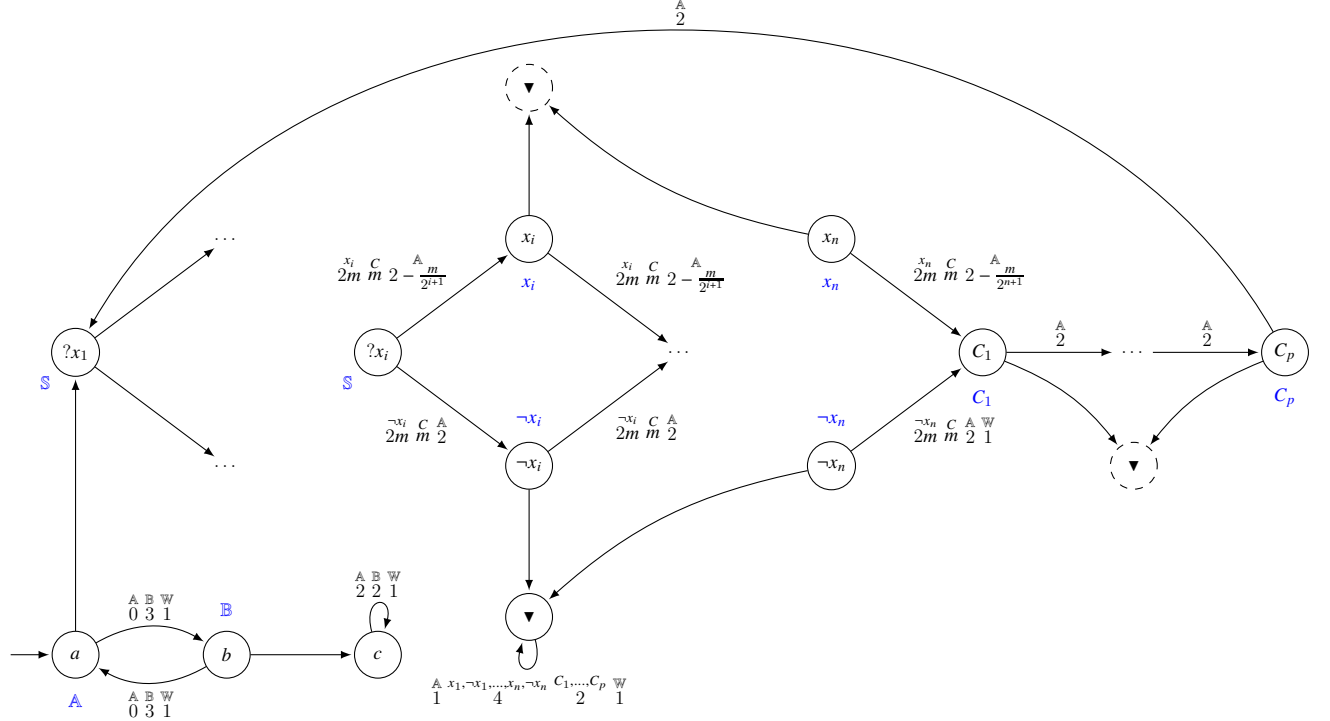

Figure 8: The game  $\mathcal{G}_{\uparrow a}$

written  $\mathbb{S}$ ; the player *Witness*, written  $\mathbb{W}$ ; the player *Alice*, written  $\mathbb{A}$ ; and the player *Bob*, written  $\mathbb{B}$ . It contains  $3n + p + 4$  vertices:

- the initial vertex  $v_0 = a$ , controlled by Alice;
- two vertices  $b$  and  $c$ , controlled by Bob;
- for each variable  $x_i$ , a vertex  $?x_i \in V_{\mathbb{S}}$ , a vertex  $x_i \in V_{x_i}$ , and a vertex  $\neg x_i \in V_{\neg x_i}$ ;
- for each clause  $C_j$ , a vertex  $C_j \in V_{C_j}$ ;
- a sink vertex  $\blacktriangledown$  (drawn three times on Figure 8 for convenience);

which are connected by the following edges (unmentioned rewards are equal to 0, and we write  $m = 2n + p$ ):

- from the vertex  $a$  to the vertex  $b$  and from the vertex  $b$  to the vertex  $a$ , two edges that give Alice the reward 0, Bob the reward 3, and Witness the reward 1;
- from  $a$  to  $?x_1$  and from  $b$  to  $c$ , an edge;
- from  $c$  to itself, an edge giving both Alice and Bob the reward 2, and giving Witness the reward 1;
- from each  $?x_i$  to  $\neg x_i$  and from  $\neg x_i$  to  $?x_{i+1}$  (or to  $C_1$  if  $i = n$ ), an edge giving:
  - \* the reward  $2m$  to  $\neg x_i$ ,
  - \* the reward  $m$  to every player  $C_j$  such that the clause  $C_j$  contains the literal  $\neg x_i$ ,
  - \* the reward 2 to Alice;
  - \* and if  $i = n$ , the reward 1 to Witness;

- from each  $?x_i$  to  $x_i$  and from  $x_i$  to  $?x_{i+1}$  (or to  $C_1$  if  $i = n$ ), an edge giving:
  - \* the reward  $2m$  to  $x_i$ ,
  - \* the reward  $m$  to every player  $C_j$  such that the clause  $C_j$  contains the literal  $x_i$ ,
  - \* and the reward  $2 - \frac{m}{2^{i+1}}$  to Alice;
- from each  $C_j$  to  $C_{j+1}$  (or  $?x_1$  if  $j = p$ ), an edge giving the reward 2 to Alice;
- from the sink vertex  $\blacktriangledown$  to itself, an edge giving the reward 1 to Alice, the reward 2 to each clause player, the reward 4 to each literal player, and 1 to Witness.

This game is based on the classical example of mean-payoff game in which SPEs do not exist, already presented in Section 5.3. In the latter, from the vertex  $a$ , Alice can access a simple sink vertex, where Bob and her both get the payoff 1. Here, they access instead to a region where the choices of Solver define a valuation of  $x_1, \dots, x_n$  — unless one of the literal players chooses to go to the sink vertex  $\blacktriangledown$ , which will be a profitable deviation if Solver makes inconsistent choices (one literal and, later, its negation). That valuation  $v$  defines Alice’s payoff  $\mu_A(\pi) = 2 - \sum_{i=1}^n \frac{v(x_i)}{2^i}$ , and therefore defines how much deviating and reaching the vertex  $c$  is profitable for her. Consequently, as we show in the complete version of this proof, the valuation  $v_{\min}$  is the binary encoding of the quantity  $\varepsilon_{\min}$ , and there is an  $\varepsilon_{\min}$ -SPE in which Witness gets the payoff 0 or less if and only if  $v_{\min}(x_n) = 1$ .  $\square$

## 6 Quantitative reachability

Again, Corollaries 1 and 2 enable us to solve the problems we are interested in; readily in the case of checking problems and subgame-perfect rational verification, and with some further work in the case of Nash rational verification.

### 6.1 Checking problems

**Theorem 8.** *In quantitative reachability games, the Nash-checking and the subgame-perfect checking problems, deterministic or not, can be decided in polynomial time.*

*Proof.* By Corollary 1, those four problems reduce to the privilege problem. In a quantitative reachability game, a play in which Adam’s payoff is strictly smaller than Eve’s one is a play that reaches Eve’s target set without traversing Adam’s one. The existence of such a play can be decided by polynomial time classical graph search algorithms.  $\square$

### 6.2 Subgame-perfect rational verification

**Theorem 9.** *In quantitative reachability games, the subgame-perfect rational verification problem, deterministic or not, is PSPACE-complete.*

*Proof.* It has been proved in [8] that the complement of the universal threshold problem was PSPACE-complete<sup>1</sup>. The result follows by Corollary 2.  $\square$

---

<sup>1</sup>Again, the problem studied in that paper was more general, but the lower bound still holds by a slight adaptation of the proof.

## 6.3 Nash rational verification

Negative instances of the Nash rational verification problem can be recognized by guessing an NE outcome, and checking it using Lemma 1; hence that problem is  $\text{coNP}$ -easy. The matching lower bound can be established by reduction from the problem  $\text{COSAT}$ .

**Theorem 10** (App. H). *In quantitative reachability games, the Nash rational verification problem, deterministic or not, is  $\text{coNP}$ -complete.*

## 7 Energy games

We now move to classes that were less studied in multiplayer non-zero sum settings so far: first, energy objectives.

### 7.1 Checking problems

Energy games are the only one of our five classes in which the checking problems cannot be solved in polynomial time (unless  $\text{P} = \text{NP}$ ); except the simplest of them, the deterministic Nash-checking problem. Indeed, only one play must be compared to potential profitable deviations: the outcome deterministically generated by the Mealy machine.

**Theorem 11** (App. I). *In energy games, the deterministic Nash-checking problem can be decided in polynomial time.*

In the other cases, either the non-determinacy or the need to study subgames entails a  $\text{coNP}$  lower bound, that we can prove by reduction from the problem  $\text{SUBSETSUM}$ . The matching upper bound can be obtained by an algorithm that searches for configurations (a vertex, a state of the memory and an energy vector) from which a profitable deviation exists, and that is accessible from the initial configuration. We can then use the fact that reachability in 1-dimensional vector addition systems with states is  $\text{NP}$ -easy — see [24].

**Theorem 12** (App. J). *In energy games, the Nash-checking, the subgame-perfect-checking, and the deterministic subgame-perfect-checking problems are  $\text{coNP}$ -complete.*

### 7.2 Nash rational verification

Rational verification problems are undecidable in this class, as we will show by reduction from the halting problem of two-counter machines — the reader who is not familiar with two-counter machines may refer to Appendix K. However, Nash rational verification is co-recursively enumerable.

**Theorem 13** (App. L). *In energy games, the Nash rational verification problem, deterministic or not, is undecidable and co-recursively enumerable.*

*Proof sketch.* We prove here that the Nash universal threshold problem is undecidable and co-recursively enumerable. The theorem will follow by Corollary 2.

- *Undecidability.* We show undecidability by reduction from the halting problem of a two-counter machine.

Let  $\mathcal{K}$  be a two-counter machine. We define an energy game  $\mathcal{G}_{\uparrow q_0^1}$  with five players — players  $C_1^\top$ ,  $C_1^\perp$ ,  $C_2^\top$ ,  $C_2^\perp$ , and  $\mathbb{W}$ , called *Witness* — by assembling the gadgets presented

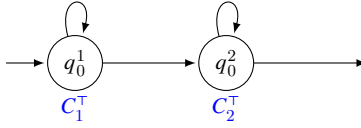

Figure 9: Gadget for the initial state



Figure 10: Gadget for the final state

in Figures 9, 10, 11, and 12 — the rewards that are not presented are equal to 0, and the players controlling relevant vertices are written in blue. For each state of  $\mathcal{K}$ , we define from one to two vertices, plus the additional vertex  $\blacktriangle$ . Then, a play in  $\mathcal{G}_{\uparrow v_0}$  that does not reach the vertex  $\blacktriangle$  simulates a sequence of transitions of  $\mathcal{K}$ , that can be a valid run or not: at each step, the counter  $C_i$  is captured by the energy level of player  $C_i^\top$ , always equal to the energy level of player  $C_i^\perp$ .

For each counter  $C_i$ , the player  $C_i^\perp$  will have a profitable deviation if that play fakes a test to 0, by going to the vertex  $\blacktriangle$ ; and the player  $C_i^\top$  will lose, and therefore have a profitable deviation by staying in  $q_0^i$  if it fakes a positive test. Thus, as shown in the complete version of this proof, every NE outcome in the game  $\mathcal{G}_{\uparrow q_0^1}$  is won by Witness if and only if the machine  $\mathcal{K}$  does not terminate. As a consequence, the halting problem of two-counter machines reduces to the Nash universal threshold problem in energy games, which is therefore undecidable.

- *Co-recursive enumerability.* As shown in the complete version of this proof, in an energy game  $\mathcal{G}_{\uparrow v_0}$ , if there exists an NE that makes some player  $i$  lose, then there exists a finite-memory one. Thus, a semi-algorithm that recognizes the negative instances of the universal threshold problem consists in enumerating the deterministic multiplayer Mealy machines on  $\mathcal{G}_{\uparrow v_0}$ , and for each of them, to check (by diagonalization):
  - whether the only strategy profile compatible with it is an NE: that is the deterministic Nash-checking problem, decidable (in polynomial time) by Theorem 11;
  - whether that strategy profile makes player  $i$  lose: that is recursively enumerable, by constructing step by step its outcome and computing the energy levels on the fly.

We have a negative instance of the universal threshold problem if and only if at least one Mealy machine satisfies those two conditions. The Nash universal threshold problem is therefore co-recursively enumerable.  $\square$

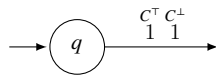

Figure 11: Gadget for incrementations of counter  $C \in \{C_1, C_2\}$

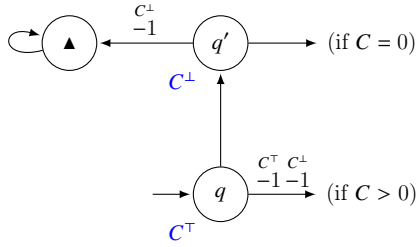

Figure 12: Gadget for tests of counter  $C$

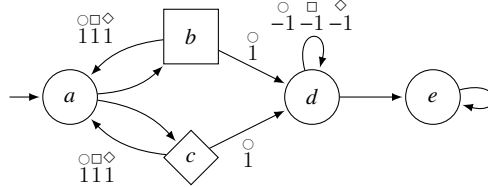

Figure 13: A game where infinite memory is necessary to make player  $\square$  lose

### 7.3 Subgame-perfect rational verification

In the subgame-perfect setting, the previous construction could also prove undecidability. But we choose to present a refinement of it, that proves a stronger result.

**Theorem 14** (App. M). *In energy games, the subgame-perfect rational verification problem, deterministic or not, is undecidable, even when Leader plays against only two players.*

Again, the proof shows that, in particular, that problem is not recursively enumerable in energy games. It might still be the case that it is co-recursively enumerable. If finite memory was sufficient for an SPE to make any player  $i$  lose, when that is possible, as in the case of NEs, then it would again imply co-recursive enumerability. Unfortunately, one cannot follow this approach, because such a statement is false.

**Proposition 2** (App. N). *In the energy game presented in Figure 13, there exists an SPE that makes player  $\square$  lose, but no finite memory SPE can achieve that result.*

## 8 Discounted-sum games

Finally, let us end with discounted-sum objectives. While Corollary 1 suffices to provide an efficient algorithm for checking problems, we will not be able to state more than recursive enumerability for rational verification.

### 8.1 Checking problems

As in mean-payoff games, the privilege problem, and therefore the checking problems, can be solved in polynomial time by a Bellman-Ford-like algorithm.

**Theorem 15** (App. O). *In discounted-sum games, the Nash-checking and the subgame-perfect checking problems, deterministic or not, can be decided in polynomial time.*

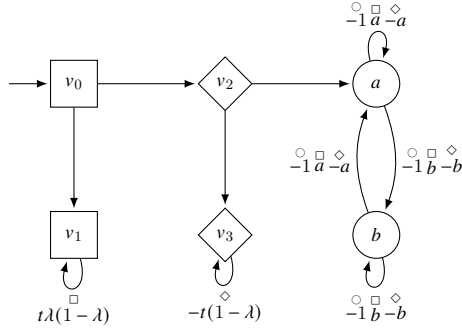

Figure 14: A game constructed from an instance of TDS

## 8.2 Rational verification

First, let us define the following decision problem.

**Problem 6** (Target discounted-sum problem). Given four quantities  $\lambda, a, b, t \in \mathbb{Q}$  with  $0 < \lambda < 1$ , is there a sequence  $(u_n)_{n \in \mathbb{N}} \in \{a, b\}^\omega$  such that  $\sum_{n \in \mathbb{N}} u_n \lambda^n = t$ ?

Although it is a quite natural problem that appears in many different fields, the target discounted-sum problem — or TDS problem for short — turns out to be surprisingly hard to solve, and its decidability status is still open. The interested reader may refer to [2] for more details. The following theorem shows that rational verification problems are at least as difficult.

**Theorem 16.** *The TDS problem reduces to the complements of the (deterministic) Nash rational and subgame-perfect rational verification problems in discounted-sum games.*

*Proof.* We present here a reduction to the complements of the Nash universal and subgame-perfect universal threshold problems; the existence of reductions to the complements of rational verification problems follows by Corollary 2.

Let  $a, b, t \in \mathbb{Q}$ , let  $\lambda \in \mathbb{Q} \cap (0, 1)$ , and let  $\mathcal{G}_{\uparrow v_0}$  be the discounted-sum of Figure 14, with discount factor  $\lambda$ . In that game, there exists an NE  $\bar{\sigma}$  with  $\mu_\circ(\langle \bar{\sigma} \rangle) < 0$ , if and only if there exists an SPE  $\bar{\sigma}$  with  $\mu_\circ(\langle \bar{\sigma} \rangle) < 0$ , if and only if  $a, b, t$ , and  $\lambda$  form a positive instance of the TDS problem.

Indeed, if such an NE or SPE exists, it necessarily reaches the vertex  $a$ . But then, player  $\square$  must get at least the payoff  $\mu_\square(v_0 v_1^\omega) = t\lambda^2$ , and player  $\diamond$  the payoff  $\mu_\diamond(v_0 v_2 v_3^\omega) = -t\lambda^2$ , otherwise they would have a profitable deviation. If such a play exists, then we have a positive instance of the TDS problem.

Conversely, from a positive instance of the TDS problem, one can construct a play from  $v_0$  in which player  $\circ$  gets the payoff  $\frac{\lambda^2}{1-\lambda}$  and both  $\square$  and  $\diamond$  get the payoff  $t\lambda^2$ , and none of them has a profitable deviation in any subgame.  $\square$

The previous theorem suggests that finding algorithms solving those problems is a very ambitious objective, since it would result in an algorithm solving the TDS problem, whose decidability is a long-standing open question. However, in the sequel, we will show that like the TDS problem, the rational verification problems are recursively enumerable.

The key idea is the following: a property of discounted-sum objectives is that when a play gives to some player a payoff that is strictly smaller than another, that can be seen on finite prefixes of those plays. Therefore, although strategy profiles are in general infinite objects that exist in uncountable number, profitable deviations can be found by analyzing their behaviors on a finite (but unbounded) number of histories.

**Theorem 17** (App. P). *In discounted-sum games, the Nash rational and the subgame-perfect rational verification problems, deterministic or not, are recursively enumerable.*

## References

- [1] Henrik Björklund, Sven Sandberg, and Sergei G. Vorobyov. Memoryless determinacy of parity and mean payoff games: a simple proof. *Theor. Comput. Sci.*, 310(1-3):365–378, 2004. doi:10.1016/S0304-3975(03)00427-4.
- [2] Udi Boker, Thomas A. Henzinger, and Jan Otop. The target discounted-sum problem. In *30th Annual ACM/IEEE Symposium on Logic in Computer Science, LICS 2015, Kyoto, Japan, July 6-10, 2015*, pages 750–761. IEEE Computer Society, 2015. doi:10.1109/LICS.2015.74.
- [3] Patricia Bouyer, Ulrich Fahrenberg, Kim Guldstrand Larsen, Nicolas Markey, and Jiri Srba. Infinite runs in weighted timed automata with energy constraints. In Franck Cassez and Claude Jard, editors, *Formal Modeling and Analysis of Timed Systems, 6th International Conference, FORMATS 2008, Saint Malo, France, September 15-17, 2008. Proceedings*, volume 5215 of *Lecture Notes in Computer Science*, pages 33–47. Springer, 2008. doi:10.1007/978-3-540-85778-5\\_4.
- [4] Romain Brenguier, Lorenzo Clemente, Paul Hunter, Guillermo A. Pérez, Mickael Randour, Jean-François Raskin, Ocan Sankur, and Mathieu Sassolas. Non-zero sum games for reactive synthesis. In *Language and Automata Theory and Applications - 10th International Conference, LATA 2016, Prague, Czech Republic, March 14-18, 2016, Proceedings*, volume 9618 of *Lecture Notes in Computer Science*, pages 3–23. Springer, 2016.
- [5] Léonard Brice, Jean-François Raskin, and Marie van den Bogaard. Subgame-perfect equilibria in mean-payoff games. In Serge Haddad and Daniele Varacca, editors, *32nd International Conference on Concurrency Theory, CONCUR 2021, August 24-27, 2021, Virtual Conference*, volume 203 of *LIPICs*, pages 8:1–8:17. Schloss Dagstuhl - Leibniz-Zentrum für Informatik, 2021. doi:10.4230/LIPICs.CONCUR.2021.8.
- [6] Léonard Brice, Jean-François Raskin, and Marie van den Bogaard. The complexity of spes in mean-payoff games. In Mikolaj Bojanczyk, Emanuela Merelli, and David P. Woodruff, editors, *49th International Colloquium on Automata, Languages, and Programming, ICALP 2022, July 4-8, 2022, Paris, France*, volume 229 of *LIPICs*, pages 116:1–116:20. Schloss Dagstuhl - Leibniz-Zentrum für Informatik, 2022. doi:10.4230/LIPICs.ICALP.2022.116.
- [7] Léonard Brice, Jean-François Raskin, and Marie van den Bogaard. On the complexity of spes in parity games. In Florin Manea and Alex Simpson, editors, *30th EACSL Annual Conference on Computer Science Logic, CSL 2022, February 14-19, 2022, Göttingen, Germany (Virtual Conference)*, volume 216 of *LIPICs*, pages 10:1–10:17. Schloss Dagstuhl - Leibniz-Zentrum für Informatik, 2022. doi:10.4230/LIPICs.CSL.2022.10.
- [8] Thomas Brihaye, Véronique Bruyère, Aline Goeminne, Jean-François Raskin, and Marie van den Bogaard. The complexity of subgame perfect equilibria in quantitative reachability games. In Wan J. Fokkink and Rob van Glabbeek, editors, *30th International Conference on Concurrency Theory, CONCUR 2019, August 27-30, 2019, Amsterdam*,



- the Netherlands*, volume 140 of *LIPICs*, pages 13:1–13:16. Schloss Dagstuhl - Leibniz-Zentrum für Informatik, 2019. doi:10.4230/LIPICs.CONCUR.2019.13.
- [9] Thomas Brihaye, Véronique Bruyère, Noémie Meunier, and Jean-François Raskin. Weak subgame perfect equilibria and their application to quantitative reachability. In *24th EACSL Annual Conference on Computer Science Logic, CSL 2015, September 7-10, 2015, Berlin, Germany*, volume 41 of *LIPICs*, pages 504–518. Schloss Dagstuhl - Leibniz-Zentrum für Informatik, 2015.
- [10] Thomas Brihaye, Julie De Pril, and Sven Schewe. Multiplayer cost games with simple nash equilibria. In Sergei N. Artëmov and Anil Nerode, editors, *Logical Foundations of Computer Science, International Symposium, LFCS 2013, San Diego, CA, USA, January 6-8, 2013. Proceedings*, volume 7734 of *Lecture Notes in Computer Science*, pages 59–73. Springer, 2013. doi:10.1007/978-3-642-35722-0\_5.
- [11] Véronique Bruyère. Computer aided synthesis: A game-theoretic approach. In *Developments in Language Theory - 21st International Conference, DLT 2017, Liège, Belgium, August 7-11, 2017, Proceedings*, volume 10396 of *Lecture Notes in Computer Science*, pages 3–35. Springer, 2017.
- [12] Véronique Bruyère. Synthesis of equilibria in infinite-duration games on graphs. *ACM SIGLOG News*, 8(2):4–29, 2021. doi:10.1145/3467001.3467003.
- [13] Véronique Bruyère, Jean-François Raskin, and Clément Tamines. Pareto-rational verification. In Bartek Klin, Slawomir Lasota, and Anca Muscholl, editors, *33rd International Conference on Concurrency Theory, CONCUR 2022, September 12-16, 2022, Warsaw, Poland*, volume 243 of *LIPICs*, pages 33:1–33:20. Schloss Dagstuhl - Leibniz-Zentrum für Informatik, 2022. doi:10.4230/LIPICs.CONCUR.2022.33.
- [14] Krishnendu Chatterjee and Vishwanath Raman. Synthesizing protocols for digital contract signing. In Viktor Kuncak and Andrey Rybalchenko, editors, *Verification, Model Checking, and Abstract Interpretation - 13th International Conference, VMCAI 2012, Philadelphia, PA, USA, January 22-24, 2012. Proceedings*, volume 7148 of *Lecture Notes in Computer Science*, pages 152–168. Springer, 2012. doi:10.1007/978-3-642-27940-9\_11.
- [15] Edmund M. Clarke, Thomas A. Henzinger, Helmut Veith, and Roderick Bloem, editors. *Handbook of Model Checking*. Springer, 2018. doi:10.1007/978-3-319-10575-8.
- [16] Gabriel Ebner, Sebastian Ullrich, Jared Roesch, Jeremy Avigad, and Leonardo de Moura. A metaprogramming framework for formal verification. *Proc. ACM Program. Lang.*, 1(ICFP):34:1–34:29, 2017. doi:10.1145/3110278.
- [17] E. Allen Emerson, Charanjit S. Jutla, and A. Prasad Sistla. On model-checking for fragments of  $\mu$ -calculus. In Costas Courcoubetis, editor, *Computer Aided Verification, 5th International Conference, CAV '93, Elounda, Greece, June 28 - July 1, 1993, Proceedings*, volume 697 of *Lecture Notes in Computer Science*, pages 385–396. Springer, 1993. doi:10.1007/3-540-56922-7\_32.
- [18] Emmanuel Filiot, Raffaella Gentilini, and Jean-François Raskin. The Adversarial Stackelberg Value in Quantitative Games. In Artur Czumaj, Anuj Dawar, and Emanuela Merelli, editors, *47th International Colloquium*

- on Automata, Languages, and Programming (ICALP 2020), volume 168 of *Leibniz International Proceedings in Informatics (LIPIcs)*, pages 127:1–127:18, Dagstuhl, Germany, 2020. Schloss Dagstuhl–Leibniz-Zentrum für Informatik. URL: <https://drops.dagstuhl.de/opus/volltexte/2020/12534>, doi:10.4230/LIPIcs.ICALP.2020.127.
- [19] Dana Fisman, Orna Kupferman, and Yoad Lustig. Rational synthesis. In Javier Esparza and Rupak Majumdar, editors, *Tools and Algorithms for the Construction and Analysis of Systems, 16th International Conference, TACAS 2010, Held as Part of the Joint European Conferences on Theory and Practice of Software, ETAPS 2010, Paphos, Cyprus, March 20-28, 2010. Proceedings*, volume 6015 of *Lecture Notes in Computer Science*, pages 190–204. Springer, 2010. doi:10.1007/978-3-642-12002-2\\_16.
- [20] János Flesch and Arkadi Predtetchinski. A characterization of subgame-perfect equilibrium plays in borel games of perfect information. *Math. Oper. Res.*, 42(4):1162–1179, 2017. doi:10.1287/moor.2016.0843.
- [21] Erich Grädel and Michael Ummels. Solution Concepts and Algorithms for Infinite Multiplayer Games. In Krzysztof Apt and Robert van Rooij, editors, *New Perspectives on Games and Interaction*, volume 4 of *Texts in Logic and Games*, pages 151–178. Amsterdam University Press, 2008. URL: <http://www.logic.rwth-aachen.de/~ummels/knaw07.pdf>.
- [22] Julian Gutierrez, Muhammad Najib, Giuseppe Perelli, and Michael J. Wooldridge. Automated temporal equilibrium analysis: Verification and synthesis of multi-player games. *Artif. Intell.*, 287:103353, 2020. doi:10.1016/j.artint.2020.103353.
- [23] Julian Gutierrez, Muhammad Najib, Giuseppe Perelli, and Michael J. Wooldridge. On the complexity of rational verification. *CoRR*, abs/2207.02637, 2022. arXiv:2207.02637, doi:10.48550/arXiv.2207.02637.
- [24] Christoph Haase, Stephan Kreutzer, Joël Ouaknine, and James Worrell. Reachability in succinct and parametric one-counter automata. In Mario Bravetti and Gianluigi Zavattaro, editors, *CONCUR 2009 - Concurrency Theory, 20th International Conference, CONCUR 2009, Bologna, Italy, September 1-4, 2009. Proceedings*, volume 5710 of *Lecture Notes in Computer Science*, pages 369–383. Springer, 2009. doi:10.1007/978-3-642-04081-8\\_25.
- [25] Steve Kremer and Jean-François Raskin. A game-based verification of non-repudiation and fair exchange protocols. In Kim Guldstrand Larsen and Mogens Nielsen, editors, *CONCUR 2001 - Concurrency Theory, 12th International Conference, Aalborg, Denmark, August 20-25, 2001, Proceedings*, volume 2154 of *Lecture Notes in Computer Science*, pages 551–565. Springer, 2001. doi:10.1007/3-540-44685-0\\_37.
- [26] Steve Kremer and Jean-François Raskin. A game-based verification of non-repudiation and fair exchange protocols. *J. Comput. Secur.*, 11(3):399–430, 2003. URL: <http://content.iospress.com/articles/journal-of-computer-security/jcs185>.
- [27] Orna Kupferman, Giuseppe Perelli, and Moshe Y. Vardi. Synthesis with rational environments. *Ann. Math. Artif. Intell.*, 78(1):3–20, 2016. doi:10.1007/s10472-016-9508-8.
- [28] Noémie Meunier. *Multi-Player Quantitative Games: Equilibria and Algorithms*. PhD thesis, Université de Mons, 2016.

- [29] John F. Nash. Equilibrium points in  $n$ -person games. In *PNAS*, volume 36, pages 48–49. National Academy of Sciences, 1950.
- [30] Martin J. Osborne. *An introduction to game theory*. Oxford Univ. Press, 2004.
- [31] Dorsa Sadigh, Shankar Sastry, Sanjit A. Seshia, and Anca D. Dragan. Planning for autonomous cars that leverage effects on human actions. In David Hsu, Nancy M. Amato, Spring Berman, and Sam Ade Jacobs, editors, *Robotics: Science and Systems XII, University of Michigan, Ann Arbor, Michigan, USA, June 18 - June 22, 2016*, 2016. URL: <http://www.roboticsproceedings.org/rss12/p29.html>, doi:10.15607/RSS.2016.XII.029.
- [32] Thomas Steeples, Julian Gutierrez, and Michael J. Wooldridge. Mean-payoff games with  $\omega$ -regular specifications. In Frank Dignum, Alessio Lomuscio, Ulle Endriss, and Ann Nowé, editors, *AAMAS '21: 20th International Conference on Autonomous Agents and Multiagent Systems, Virtual Event, United Kingdom, May 3-7, 2021*, pages 1272–1280. ACM, 2021. URL: <https://www.ifaamas.org/Proceedings/aamas2021/pdfs/p1272.pdf>, doi:10.5555/3463952.3464099.
- [33] Michael Ummels. Rational Behaviour and Strategy Construction in Infinite Multiplayer Games. Diploma thesis, RWTH Aachen, 2005. URL: <http://www.logic.rwth-aachen.de/~ummels/diplom.pdf>.
- [34] Michael Ummels. The complexity of nash equilibria in infinite multiplayer games. In Roberto M. Amadio, editor, *Foundations of Software Science and Computational Structures, 11th International Conference, FOSSACS 2008, Held as Part of the Joint European Conferences on Theory and Practice of Software, ETAPS 2008, Budapest, Hungary, March 29 - April 6, 2008. Proceedings*, volume 4962 of *Lecture Notes in Computer Science*, pages 20–34. Springer, 2008. doi:10.1007/978-3-540-78499-9\_3.
- [35] Yaron Velner, Krishnendu Chatterjee, Laurent Doyen, Thomas A. Henzinger, Alexander Moshe Rabinovich, and Jean-François Raskin. The complexity of multi-mean-payoff and multi-energy games. *Inf. Comput.*, 241:177–196, 2015.
- [36] Uri Zwick and Mike Paterson. *The complexity of mean payoff games*, volume 959, pages 1–10. Springer, 04 2006. doi:10.1007/BFb0030814.

## A Proof of Theorem 1

**Theorem 1.** *There exists a strategy profile  $\bar{\sigma} \in \text{Comp}_{\uparrow v_0}(\mathcal{M})$  that is not an NE (resp. SPE) if and only if there exists a play  $\pi$  in the game  $\text{NDev}(\mathcal{G}, \mathcal{M})_{\uparrow(q_0, v_0)}$  (resp.  $\text{SPDev}(\mathcal{G}, \mathcal{M})_{\uparrow(q_0, v_0)}$ ) such that  $\mu_{\mathbb{A}}(\pi) < \mu_{\mathbb{E}}(\pi)$ .*

*Proof.* We present first the proof for SPEs.

- If there exists  $\bar{\sigma} \in \text{Comp}_{\uparrow v_0}(\mathcal{M})$  that is not an SPE, then there exists a play  $\pi$  in  $\text{SPDev}(\mathcal{G}, \mathcal{M})_{\uparrow(q_0, v_0)}$  such that  $\mu_{\mathbb{A}}(\pi) < \mu_{\mathbb{E}}(\pi)$ .

If  $\bar{\sigma}$  is not an SPE, then there exists a history  $hv = h_0 \dots h_{n-1}v$ , a player  $i$ , and a play  $\chi'$  compatible with  $\bar{\sigma}_{-i \uparrow hv}$  such that if  $\chi = \langle \bar{\sigma}_{\uparrow hv} \rangle$ , then we have  $\mu_i(h\chi) < \mu_i(h\chi')$ .

Without loss of generality, we can assume  $v \in V_i$  and  $\chi_1 \neq \chi'_1$ . Then, there exists a play:

$$\begin{aligned} \pi = & (q_0, h_0)(q_1, h_1, i) \dots (q_n, v, i)(q_{n+1}, \chi_1, i, q'_{n+1}, \chi'_1) \\ & (q_{n+2}, \chi_2, i, q'_{n+2}, \chi'_2) \dots \end{aligned}$$

in  $\text{SPDev}(\mathcal{G}, \mathcal{M})_{\uparrow(q_0, v_0)}$  such that  $\mu_{\mathbb{A}}(\pi) < \mu_{\mathbb{B}}(\pi)$ .

- *If there exists such a play in  $\text{SPDev}(\mathcal{G}_{\uparrow v_0}, \mathcal{M})$ , then there exists  $\bar{\sigma} \in \text{Comp}_{\uparrow v_0}(\mathcal{M})$  that is not an SPE.*

If such a play exists, then it has the form:

$$\begin{aligned} \pi = & (q_0, h_0)(q_1, h_1, i) \dots (q_{n-1}, h_{n-1}, i)(q_n, \chi_0, i) \\ & (q_{n+1}, \chi_1, i, q'_{n+1}, \chi'_1)(q_{n+2}, \chi_2, i, q'_{n+2}, \chi'_2) \dots \end{aligned}$$

where  $\mu_i(h\chi) < \mu_i(h\chi')$  (with  $\chi'_0 = \chi_0$ ). Then, there exists a strategy profile  $\bar{\sigma} \in \text{Comp}_{\uparrow v_0}(\mathcal{M})$  such that  $\chi = \langle \bar{\sigma}_{\uparrow h\chi_0} \rangle$ , and  $\chi'$  is compatible with  $\bar{\sigma}_{-i \uparrow h\chi_0}$ . That strategy profile is therefore not an SPE.

The proof for NEs follows the same structure, with histories  $hv$  that are compatible with a strategy  $\bar{\sigma} \in \text{Comp}_{\uparrow v_0}(\mathcal{M})$ .  $\square$

## B Proof of Theorem 2

**Theorem 2.** *Let  $\rho \in \{\text{Nash}, \text{subgame-perfect}\}$ . Let  $\mathcal{G}_{\uparrow v_0}$  be a game, let  $\mathcal{M}$  be a Mealy machine for Leader in  $\mathcal{G}$ , and let  $t \in \mathbb{Q}$ . Then, every  $\rho$ -response  $\bar{\sigma}_{-\mathbb{L}}$  to every strategy  $\sigma_{\mathbb{L}} \in \text{Comp}_{\uparrow v_0}(\mathcal{M})$  satisfies  $\mu_{\mathbb{L}}(\langle \bar{\sigma} \rangle) > t$  if and only if every  $\rho$ -equilibrium  $\bar{\tau}$  in the game  $\mathcal{G}_{\uparrow v_0} \otimes \mathcal{M}$  satisfies  $\mu'_{\mathbb{L}}(\langle \bar{\tau} \rangle) > t$ .*

*Proof.* We present first the proof when  $\rho = \text{subgame-perfect}$ ; again, the proof for  $\rho = \text{Nash}$  follows the same structure.

- *If for every  $\sigma_{\mathbb{L}} \in \text{Comp}_{\uparrow v_0}(\mathcal{M})$  and every response  $\bar{\sigma}_{-\mathbb{L}} \in \text{SPR}(\sigma_{\mathbb{L}})$ , we have  $\mu_{\mathbb{L}}(\langle \bar{\sigma} \rangle) > t$ , then every SPE  $\bar{\tau}$  in  $\mathcal{G}_{\uparrow v_0} \otimes \mathcal{M}$  satisfies  $\mu'_{\mathbb{L}}(\langle \bar{\tau} \rangle) > t$ .*

Let  $\bar{\tau}$  be an SPE in the game  $\mathcal{G}_{\uparrow v_0} \otimes \mathcal{M}$ . Let us define a strategy profile  $\bar{\sigma}$  in  $\mathcal{G}_{\uparrow v_0}$  as follows: for every history  $h = h_0 \dots h_n$  in  $\mathcal{G}_{\uparrow v_0}$ , let  $H = (h_0, q_0)(h_0, q_0, q_1) \dots (h_n, q_{n-1}, q_n)$  be the unique history of that form in  $\mathcal{G}_{\uparrow v_0} \otimes \mathcal{M}$  such that:

$$(h_k, q_k, q_{k+1}) = \tau_{\mathbb{D}}((h_0, q_0) \dots (h_k, q_k))$$

for each  $k$ , and let  $(v, q_n) = \bar{\tau}(H)$ . Then, we define  $\bar{\sigma}(h) = v$ .

Since the only edges available for Demon in the game  $\mathcal{G}_{\uparrow v_0} \otimes \mathcal{M}$  are those that are compatible with  $\mathcal{M}$ , we have  $\sigma_{\mathbb{L}} \in \text{Comp}_{\uparrow v_0}(\mathcal{M})$ . Moreover, the strategy profile  $\bar{\sigma}$  is an  $\mathbb{L}$ -fixed SPE: let  $h = h_0 \dots h_n$  be a history from  $v_0$  that is compatible with  $\sigma_{\mathbb{L}}$ , let  $i \in \Pi \setminus \{\mathbb{L}\}$  and let  $\sigma'_i$  be a deviation of  $\sigma_i$ . We want to prove that  $\mu_i(\langle \bar{\sigma}_{-i \uparrow h}, \sigma'_{i \uparrow h} \rangle) \leq \mu_i(\langle \bar{\sigma}_{\uparrow h} \rangle)$ . Then, let us define the history  $H$  as above, and let  $\tau'_i$  be the strategy that simulates  $\sigma'_i$  in the game  $\mathcal{G}_{\uparrow v_0} \otimes \mathcal{M}$ , i.e. that maps each history of the form  $H(v_1, q_n)(v_1, q_n, q_{n+1}) \dots (v_k, q_{n+k-1}, q_{n+k})$  to the vertex  $(\sigma'_i(hv_1 \dots v_k), q_{n+k})$ . Since the strategy profile  $\bar{\tau}$  is an SPE, we have  $\mu'_i(H_{<2n+1} \langle \bar{\tau}_{-i \uparrow H}, \tau'_{i \uparrow H} \rangle) \leq \mu'_i(H_{<2n+1} \langle \bar{\tau}_{\uparrow H} \rangle)$ , and therefore  $\mu_i(h_{<n} \langle \bar{\sigma}_{-i \uparrow h}, \sigma'_{i \uparrow h} \rangle) \leq \mu_i(h_{<n} \langle \bar{\sigma}_{\uparrow h} \rangle)$ .

Thus, the strategy  $\bar{\sigma}$  is an  $\mathbb{L}$ -fixed SPE that satisfies  $\sigma_{\mathbb{L}} \in \text{Comp}_{\uparrow v_0}(\mathcal{M})$ . By hypothesis, it comes that we have  $\mu_{\mathbb{L}}(\langle \bar{\sigma} \rangle) > t$ , and therefore  $\mu'_{\mathbb{L}}(\langle \bar{\tau} \rangle) > t$ .

- If every SPE  $\bar{\tau}$  in  $\mathcal{G}_{\uparrow v_0} \otimes \mathcal{M}$  satisfies  $\mu'_{\mathbb{L}}(\langle \bar{\tau} \rangle) > t$ , then for every  $\sigma_{\mathbb{L}} \in \text{Comp}_{\uparrow v_0}(\mathcal{M})$  and every response  $\bar{\sigma}_{-i} \in \text{SPR}(\sigma_{\mathbb{L}})$ , we have  $\mu_{\mathbb{L}}(\langle \bar{\sigma} \rangle) > t$ .

Indeed, let  $\bar{\sigma}$  be an  $\mathbb{L}$ -fixed SPE in  $\mathcal{G}_{\uparrow v_0}$  with  $\sigma_{\mathbb{L}} \in \text{Comp}_{\uparrow v_0}(\mathcal{M})$ . We write  $h \mapsto q_h$  the mapping establishing the compatibility of the strategy  $\sigma_{\mathbb{L}}$  with the machine  $\mathcal{M}$ , as defined in Section 2.5. Let us define a strategy profile  $\bar{\tau}$  in  $\mathcal{G}_{\uparrow v_0} \otimes \mathcal{M}$  as follows: for every history  $H = (h_0, q_0)(h_0, q_0, q_1) \dots (h_n, q_{n-1})$ , we define  $\bar{\tau}(H) = (h_n, q_{n-1}, q_{h_0 \dots h_n})$ . For every history  $H = (h_0, q_0) \dots (h_n, q_{n-1}, q_n)$ , we define  $\bar{\tau}(H) = (\bar{\sigma}(h_0 \dots h_n), q_n)$ .

Then, the strategy profile  $\bar{\tau}$  is an SPE: let  $H = H_0 \dots H_m$  be a history in  $\mathcal{G}_{\uparrow v_0} \otimes \mathcal{M}$ , let  $i$  be a player and let  $\tau'_i$  be a deviation of  $\tau_i$ . If  $i = \mathbb{L}$ , then we have  $\mu'_i(H_{< m} \langle \bar{\tau}_{-i \uparrow H}, \tau'_{i \uparrow H} \rangle) \leq \mu'_i(H_{< m} \langle \bar{\tau}_{\uparrow H} \rangle)$ , because Leader does not control any vertex in  $\mathcal{G}_{\uparrow v_0} \otimes \mathcal{M}$ , hence actually  $\tau'_i = \tau_i$ . Likewise if  $i = \mathbb{D}$ , because Demon gets the payoff 0 in every play. Now, if  $i \neq \mathbb{D}, \mathbb{L}$ , let us consider without loss of generality that  $H$  has the form  $H = (h_0, q_0)(h_0, q_0, q_1) \dots (h_n, q_n)$  (if the last vertex is controlled by Demon, it can be removed). Let  $(\pi_0, q_n)(\pi_0, q_n, q_{n+1})(\pi_1, q_{n+1}) \dots = \langle \bar{\tau}_{-i \uparrow H}, \tau'_{i \uparrow H} \rangle$ . The play  $\pi = \pi_0 \pi_1 \dots$  is compatible with the strategy profile  $\bar{\sigma}_{-i \uparrow h}$ . Therefore, since  $\bar{\sigma}$  is an  $\mathbb{L}$ -fixed SPE, we have  $\mu_i(h_{< n} \pi) \leq \mu_i(h_{< n} \langle \bar{\sigma}_{\uparrow h} \rangle)$ , i.e.  $\mu'_i(H_{< 2n+1} \langle \bar{\tau}_{-i \uparrow H}, \tau'_{i \uparrow H} \rangle) \leq \mu'_i(H_{< 2n+1} \langle \bar{\tau}_{\uparrow H} \rangle)$ .

Thus, the strategy profile  $\bar{\tau}$  is an SPE: by hypothesis, it comes that  $\mu'_{\mathbb{L}}(\langle \bar{\tau} \rangle) > t$ , and therefore  $\mu_{\mathbb{L}}(\langle \bar{\sigma} \rangle) > t$ .  $\square$

## C Proof of Theorem 4

**Theorem 4.** *In the class of parity games, the Nash rational and the subgame-perfect rational verification problems, deterministic or not, are coNP-complete.*

*Proof.* • *Subgame-perfect rational verification.*

In [7], a problem that was more general than the complement of the subgame-perfect universal threshold problem in parity games was proved to be NP-complete. In our setting, the upper bound is therefore already established. As for the lower bound, we need to present a slight modification of the reduction that was given in the aforementioned paper, itself inspired from the construction provided in [33]. Let  $\varphi = \bigwedge_{j=1}^p C_j$  be a formula of the propositional logic, over the variables  $x_1, \dots, x_n$ . We define the parity game  $\mathcal{G}_{\uparrow C_1}^{\varphi}$  as follows:

- the players are the variables  $x_1, \dots, x_n$ , their negations, the player *Solver*, denoted by  $\mathbb{S}$ , and the player *Witness*, denoted by  $\mathbb{W}$ ;
- the vertices controlled by Solver are all the clauses  $C_j$ , and the sink vertex  $\blacktriangledown$ ;
- the vertices controlled by player  $\ell = \pm x_i$  are the pairs  $(C_j, L)$ , where  $\ell$  is a literal of  $C_j$ ;
- Witness controls no vertices;
- there are edges from each clause vertex  $C_j$  to all the vertices  $(C_j, \ell)$ ; from each pair vertex  $(C_j, \ell)$  to the vertex  $C_{j+1}$ , and to the sink vertex  $\blacktriangledown$ ; and from the sink vertex  $\blacktriangledown$  to itself;
- for Solver, every vertex has the color  $\kappa_{\mathbb{S}}(v) = 2$ , except the vertex  $\blacktriangledown$ , which has color 1; for Witness, every vertex has the color  $\kappa_{\mathbb{W}}(v) = 1$ , except the vertex  $\blacktriangledown$ , which has color 2; for each literal player  $\ell$ , every vertex has the color  $\kappa_{\ell}(v) = 2$ , except the vertices of the form  $(C, \bar{\ell})$ , that have the color 1.

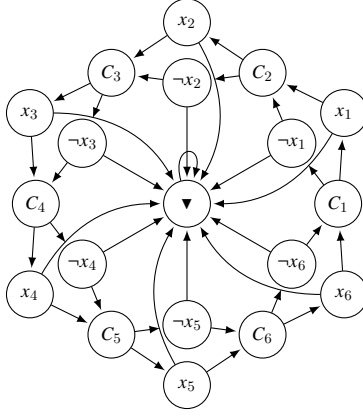

Figure 15: The game  $\mathcal{G}^\varphi$ .

The arena of the game  $\mathcal{G}^\varphi$ , when  $\varphi$  is the tautology  $\bigwedge_{j=1}^6 (x_j \vee \neg x_j)$ , is given by Figure 15. Intuitively: from the vertex  $C_j$ , Solver chooses which literal  $\ell$  of  $C_j$  will be satisfied by the valuation she tries to construct. Then, from the vertex  $(C_j, \ell)$ , player  $\ell$  may go to the vertex  $\blacktriangledown$  and win; if she does not, then Solver has to make her win, which means that she cannot choose the literal  $\bar{\ell}$  for another clause (at least not infinitely often). Solver wins (and Witness loses) if and only if the vertex  $\blacktriangledown$  is never reached. As proved in [7], there exists an SPE that is won by Solver in this game if and only if the formula  $\varphi$  is satisfiable; that is, *every* SPE is won by Witness if and only if  $\varphi$  is *not* satisfiable. Consequently, the subgame-perfect universal threshold problem in parity game is coNP-complete. The coNP-completeness of the subgame-perfect rational verification problem follows by Corollary 2.

- *Nash rational verification.*

By Corollary 2, the Nash rational verification problem in parity games is coNP-complete if and only if the Nash universal threshold problem is.

That problem is coNP-hard by the same reduction as above: in the game  $\mathcal{G}^\varphi$ , we can show that every NE outcome is an SPE outcome (for example using Theorem 1 of [7]).

By Lemma 1, the NE outcomes in a parity game are exactly the plays  $\pi$  such that, for each player  $j$  such that  $\mu_j(\pi) = 0$ , for each vertex  $v \in \text{Occ}(\pi) \cap V_j$ , there exists a strategy profile  $\bar{\sigma}_{-j}$  from  $v$  such that for every strategy  $\sigma_j$ , we have  $\mu_j(\langle \bar{\sigma}_{-j}, \sigma_j \rangle) = 0$ . Deciding the existence of such a strategy profile is an  $\text{NP} \cap \text{coNP}$ -easy problem — see for example [17].

Moreover, according to [7] again, if there exists such a play  $\pi$  satisfying  $\mu_i(\pi) \leq t$  for a given player  $i$  and a given threshold  $t$ , there exists one of the form  $hc^\omega$ , where the lengths of  $h$  and  $c$  are bounded by a polynomial function of the size of  $\mathcal{G}$ . Therefore, an NP algorithm that recognizes a negative instance of the Nash universal threshold problem is the following: first, guess such a play  $hc^\omega$ , a set  $W \subseteq V$ , and for each  $v \in W$ , a certificate of the fact that from  $v$ , there exists a strategy profile that prevents the player controlling  $v$  to get the payoff 1 (since that problem is  $\text{NP} \cap \text{coNP}$ -easy, and therefore NP-easy, such a certificate exists, has polynomial size and can be checked in polynomial time). Then, in polynomial time, check those certificates, check that  $\mu_i(hc^\omega) \leq t$ , and check that the players controlling vertices of  $W$  are the only players who lose along  $hc^\omega$ .  $\square$

## D Proof of Theorem 6

**Theorem 6.** *In the class of mean-payoff games, the Nash rational and the subgame-perfect rational verification problems, deterministic or not, are coNP-complete.*

*Proof.* • *Lower bounds*

The NP-hardness of Nash and subgame-perfect universal threshold problems can be shown by the same proof as for parity games: given a formula  $\varphi$ , the game  $\mathcal{G}^\varphi$ , defined in the proof of Theorem 4, can be transformed into a mean-payoff game as follows: when the color of a vertex  $v$  for a given player  $i$  is 2, the reward granted to player  $i$  on each edge leading to  $v$  is defined as equal to 1. When that color is 1, that reward is defined as equal to 0. Thus, we can prove that, again, Witness gets a payoff greater than 0 in every SPE in that game if and only if  $\varphi$  is not satisfiable.

- *Subgame-perfect rational verification.*

By [6], the complement of the universal threshold problem is NP-easy. The coNP-completeness of the rational verification problem comes by Corollary 2.

- *Nash rational verification*

By [6], Theorem 38 given a mean-payoff game  $\mathcal{G}$ , a player  $i$ , a threshold  $t$ , and a vertex labelling  $\lambda : V \rightarrow \mathbb{Q} \cup \{\pm\infty\}$ , deciding the existence of a play  $\pi$  such that  $\mu_i(\pi) \leq t$ , and such that  $\mu_j(\pi) \geq \lambda(\pi_k)$  for each player  $j$  and every vertex  $\pi_k \in V_j$ , is NP-easy. Let us define  $\lambda_1$  that maps each vertex  $v$  to the value  $\inf_{\bar{\sigma}_{-j}} \sup_{\sigma_j} \mu_j(\langle \bar{\sigma}_{-j}, \sigma_j \rangle)$ , where  $j$  is the player controlling  $v$ .

Since memoryless strategies are optimal in two-player zero-sum mean-payoff games (see for instance [1]), the value  $\lambda_1(v)$  is the payoff of player  $j$  in a cycle of  $\mathcal{G}$ , and can therefore be written with a number of bits that is polynomial in  $\|\mathcal{G}\|$ . Therefore, there exists a polynomial  $P$  such that  $\lambda_1$  can be encoded using at most  $P(\|\mathcal{G}\|)$  bits.

Thus, a non-deterministic polynomial algorithm that recognizes negative instances of the Nash universal threshold problem consists in guessing:

- a requirement  $\lambda$ , of size at most  $P(\|\mathcal{G}\|)$ ,
- a memoryless strategy profile  $\bar{\tau}_{-j}^v$  from  $v$  for each  $j$  and  $v \in V_j$ ,
- and a certificate of the existence of a play  $\pi$  satisfying the aforementioned properties,

and then in checking, deterministically, that that certificate is valid and that each strategy profile  $\tau_{-j}^v$  is such that for each strategy  $\tau_j$ , we have  $\mu_j(\langle \bar{\tau}_{-j}^v, \tau_j \rangle) \leq \lambda(v)$ , i.e. that  $\lambda \geq \lambda_1$  — and therefore, by Lemma 1, that  $\pi$  is an NE outcome.  $\square$

## E Proof of Proposition 1

**Proposition 1.** *Let  $\mathcal{C}$  be a class of games, among the classes of parity games, quantitative reachability games, energy games, and discounted-sum games.*

*Let  $\rho \in \{\text{Nash}, \text{subgame-perfect}\}$ . Then, the positive instances of the achaotic  $\rho$ -rational verification problem in  $\mathcal{C}$  are exactly the positive instances of the  $\rho$ -rational verification problem. Similarly, the positive instances of the achaotic Nash-rational verification problem in mean-payoff games are exactly the positive instances of the  $\rho$ -rational verification problem.*

*Proof.* This proposition is a consequence of the following fact: in both of the settings given above, in every game  $\mathcal{G}_{\uparrow v_0}$  of the studied class, for every Mealy machine  $\mathcal{M}$  for Leader, there exists a strategy  $\sigma_{\mathbb{L}} \in \text{Comp}_{\uparrow v_0}(\mathcal{M})$  that admits a  $\rho$ -response.

Indeed, by Theorem 2, there exists a strategy  $\sigma_{\mathbb{L}} \in \text{Comp}_{\uparrow v_0}(\mathcal{M})$  that admits a  $\rho$ -response if and only if there exists a  $\rho$ -equilibrium in  $\mathcal{G}_{\uparrow v_0} \otimes \mathcal{M}$ .

- In the first case, it is always true: in the four mentioned classes, SPEs are always guaranteed to exist — and therefore so are NEs. Indeed, if  $\mathcal{C}$  is the class of parity games or energy games, then  $\mathcal{G}_{\uparrow v_0}$ , and therefore  $\mathcal{G}_{\uparrow v_0} \otimes \mathcal{M}$ , is a Boolean game with Borel winning conditions. By [21], every such game contains an SPE. If  $\mathcal{C}$  is the class of quantitative reachability games or discounted-sum games, then  $\mathcal{G}_{\uparrow v_0}$ , and therefore  $\mathcal{G}_{\uparrow v_0} \otimes \mathcal{M}$ , is a game with payoff functions that are continuous for the canonical distance on infinite words. By [9], every such game contains an SPE.
- In the second case, it is also always true as well: SPEs may not exist in mean-payoff games, but NEs always do — see for example [10].

Therefore, in all those settings, if the game  $\mathcal{G}_{\uparrow v_0}$  and the Mealy machine  $\mathcal{M}$  are such that  $\mu_{\mathbb{L}}(\langle \bar{\sigma} \rangle) > t$  for every  $\sigma_{\mathbb{L}} \in \text{Comp}_{\uparrow v_0}(\mathcal{M})$  and all  $\bar{\sigma}_{-\mathbb{L}} \in \rho\text{R}(\sigma_{\mathbb{L}})$ , i.e. if we have a positive instance of the  $\rho$ -rational verification problem, then  $\varepsilon = 0$  is such that  $0\rho\text{R}(\sigma_{\mathbb{L}}) \neq \emptyset$  for some  $\sigma_{\mathbb{L}} \in \text{Comp}_{\uparrow v_0}(\mathcal{M})$ , and simultaneously such that  $\mu_{\mathbb{L}}(\langle \bar{\sigma} \rangle) > t$  for every  $\sigma_{\mathbb{L}} \in \text{Comp}_{\uparrow v_0}(\mathcal{M})$  and all  $\bar{\sigma}_{-\mathbb{L}} \in 0\rho\text{R}(\sigma_{\mathbb{L}})$  — i.e., we have a positive instance of the achaotic  $\rho$ -rational verification problem.

Conversely, if we have a positive instance of the achaotic  $\rho$ -rational verification problem, i.e. if there exists  $\varepsilon \geq 0$  such that  $\varepsilon\rho\text{R}(\sigma_{\mathbb{L}}) \neq \emptyset$  for some  $\sigma_{\mathbb{L}} \in \text{Comp}_{\uparrow v_0}(\mathcal{M})$ , and simultaneously such that  $\mu_{\mathbb{L}}(\langle \bar{\sigma} \rangle) > t$  for every  $\sigma_{\mathbb{L}} \in \text{Comp}_{\uparrow v_0}(\mathcal{M})$  and all  $\bar{\sigma}_{-\mathbb{L}} \in \varepsilon\rho\text{R}(\sigma_{\mathbb{L}})$ , then it is also the case of 0, since  $0\rho$ -responses are  $\varepsilon\rho$ -responses; hence we have  $\mu_{\mathbb{L}}(\langle \bar{\sigma} \rangle) > t$  for every  $\sigma_{\mathbb{L}} \in \text{Comp}_{\uparrow v_0}(\mathcal{M})$  and all  $\bar{\sigma}_{-\mathbb{L}} \in \rho\text{R}(\sigma_{\mathbb{L}})$ , i.e. we have a positive instance of the  $\rho$ -rational verification problem.  $\square$

## F Proof of Lemma 2

**Lemma 2.** *There exists a polynomial  $P_1$  such that in every mean-payoff game  $\mathcal{G}_{\uparrow v_0}$ , there exists  $\varepsilon_{\min}$  with  $\|\varepsilon_{\min}\| \leq P_1(\|\mathcal{G}\|)$  such that  $\varepsilon_{\min}$ -SPEs exist in  $\mathcal{G}_{\uparrow v_0}$ , and  $\varepsilon$ -SPEs, for every  $\varepsilon < \varepsilon_{\min}$ , do not.*

*Proof.* First, let us show that  $\varepsilon_{\min}$  exists. According to [5],  $\varepsilon$ -SPEs are characterized by a mapping called *negotiation function*, that maps each *requirement*, i.e. each vertex labelling  $\lambda : V \rightarrow \mathbb{R} \cup \{\pm\infty\}$ , to a requirement  $\text{nego}(\lambda) \geq \lambda$ . The same article defines  $\lambda$ -consistent plays as plays  $\pi$  satisfying  $\mu_i(\pi) \geq \lambda(v)$  for each player  $i$  and each vertex  $v \in V_i$ , and shows that each play is a  $\delta$ -SPE outcome if and only if it is  $\lambda$ -consistent for some requirement  $\lambda$  that is a  $\delta$ -fixed point of the negotiation function, i.e. that satisfies  $\text{nego}(\lambda)(v) \leq \lambda(v) + \delta$  for each  $v$ . Moreover, it proves that for every  $\delta \geq 0$ , we can define a least  $\delta$ -fixed point  $\lambda_{\delta}$  of the negotiation function, which satisfies  $\lambda_{\delta}(v_0) \neq +\infty$  if and only if  $\delta$ -SPEs exist.

Let us now define  $\varepsilon = \inf\{\delta \geq 0 \mid \delta\text{-SPEs in } \mathcal{G}_{\uparrow v_0} \text{ exist}\}$ . We only need to show that  $\varepsilon$  is also such that  $\varepsilon$ -SPEs exist, or in other words, that  $\lambda_{\varepsilon}(v_0) \neq +\infty$ . Let us note that for every  $\delta, \delta'$  with  $\delta \leq \delta'$ , the requirement  $\lambda_{\delta}$  is a  $\delta'$ -fixed point of the negotiation function, and therefore satisfies  $\lambda_{\delta} \geq \lambda_{\delta'}$ .



Let us now define the requirement  $\lambda : v \mapsto \sup_{\delta > \varepsilon} \lambda_\delta(v)$ . For each  $v$  and every  $\delta > \varepsilon$ , we have  $\text{nego}(\lambda_\delta)(v) \leq \lambda_\delta(v) - \delta$ ; since according to [5], the negotiation function is Scott-continuous, we have  $\text{nego}(\lambda)(v) \leq \lambda(v) - \varepsilon$ , i.e.  $\lambda$  is an  $\varepsilon$ -fixed point of the negotiation function, and therefore  $\lambda = \lambda_\varepsilon$ . Since  $\lambda(v_0) = \sup_\delta \lambda_\delta(v_0) \neq +\infty$ , we obtain that  $\varepsilon$ -SPEs exist in  $\mathcal{G}_{\uparrow v_0}$ , and therefore that  $\varepsilon_{\min} = \varepsilon$ .

Now, it has been shown in [6], in the proof of Theorem 1, that one can define for every  $\lambda$  a finite union of polyhedra  $X_\lambda \subseteq \mathbb{R}^{V \times \Pi}$ , where each of those polyhedra is defined by a set of inequations either of the form  $x_{vi} \geq \lambda(w)$  or of size bounded by a polynomial function of  $\|\mathcal{G}\|$ , and such that for each  $i \in \Pi$  and  $v \in V_i$ , we have  $\text{nego}(\lambda)(v) = \min \{x_{vi} \mid \bar{x} \in X_\lambda\}$ .

Let us now define the set  $Y = \{(\lambda, \bar{x}) \mid \bar{x} \in X_\lambda\} \subseteq \mathbb{R}^V \times \mathbb{R}^{V \times \Pi}$ . The set  $Y$  is itself a finite union of polyhedra defined by the same inequations than  $X_\lambda$ , or by inequations of bounded size (those of the form  $x_{vi} \geq \lambda(w)$ , where  $\lambda(w)$  is no longer a constant but a coordinate of  $(\lambda, \bar{x})$ ). Let us also define the mapping:

$$f : \begin{cases} Y & \rightarrow & \mathbb{R} \\ (\lambda, \bar{x}) & \mapsto & \max_{i \in \Pi, v \in V_i} (x_{vi} - \lambda(v)) \end{cases} \cdot$$

Then, we have:

$$\varepsilon_{\min} = \min_{(\lambda, \bar{x})} f(\lambda, \bar{x}),$$

and since  $f$  is a piecewise linear mapping on a finite union of polyhedra that has a minimum, that minimum is reached on a vertex  $(\lambda, \bar{x})$  of one of those polyhedra. By Corollary 1 of [6], such a vertex has coordinates bounded by a polynomial of the maximal size of the inequations defining the polyhedron to which it belongs, i.e. by a polynomial of  $\|\mathcal{G}\|$ . Therefore, that is also the case of  $f(\lambda, \bar{x}) = \varepsilon_{\min}$ .  $\square$

## G Proof of Theorem 7

**Theorem 7.** *In the class of mean-payoff games, the achaotic subgame-perfect rational verification problem, deterministic or not, is  $\text{P}^{\text{NP}}$ -complete.*

*Proof.* Using Lemma 2 and the same arguments as in the proof of Theorem 2, those two problems reduce to the following problem, and conversely: given a game  $\mathcal{G}_{\uparrow v_0}$  and a threshold  $t \in \mathbb{Q}$ , does every  $\varepsilon_{\min}$ -SPE  $\bar{\sigma}$  in  $\mathcal{G}_{\uparrow v_0}$  satisfy  $\mu_{\mathbb{L}}(\langle \bar{\sigma} \rangle) > t$ ? Let us prove that that problem is  $\text{P}^{\text{NP}}$ -complete.

- *Easiness.*

By [6], there is an NP algorithm that decides, given  $\varepsilon$  and  $\mathcal{G}_{\uparrow v_0}$ , whether there exists an  $\varepsilon$ -SPE in  $\mathcal{G}_{\uparrow v_0}$ , i.e. whether  $\varepsilon \geq \varepsilon_{\min}$ . Using Lemma 2, a dichotomous search can therefore compute  $\varepsilon_{\min}$  by a polynomial number of calls to that algorithm. Then, one last call to that same algorithm can decide whether there exists an  $\varepsilon_{\min}$ -SPE  $\bar{\sigma}$  such that  $\mu_i(\langle \bar{\sigma} \rangle) \leq t$ .

- *Hardness.*

We proceed by reduction from the following  $\text{P}^{\text{NP}}$ -complete problem: given a Boolean formula  $\varphi$  in conjunctive normal form over the ordered variables  $x_1, \dots, x_n$ , is the lexicographically first valuation  $v_{\min}$  satisfying  $\varphi$  such that  $v_{\min}(x_n) = 1$ ? Let us write  $\varphi = \bigwedge_{j=1}^p C_j$ . We construct a game  $\mathcal{G}_{\uparrow a}$ , with a player called *Witness* and written  $\mathbb{W}$ , in which there exists an  $\varepsilon_{\min}$ -SPE  $\bar{\sigma}$  such that  $\mu_{\mathbb{W}}(\langle \bar{\sigma} \rangle) \leq 0$  if and only if  $\varphi$  is satisfiable

and  $v_{\min}(x_n) = 1$ . That game, depicted in Figure 8, has  $2n + p + 4$  players: the literal players  $x_1, \neg x_1, \dots, x_n, \neg x_n$ ; the clause players  $C_1, \dots, C_p$ ; the player *Solver*, written  $\mathbb{S}$ ; the player *Witness*, written  $\mathbb{W}$ ; the player *Alice*, written  $\mathbb{A}$ ; and the player *Bob*, written  $\mathbb{B}$ . It contains  $3n + p + 4$  vertices:

- the initial vertex  $v_0 = a$ , controlled by Alice;
- two vertices  $b$  and  $c$ , controlled by Bob;
- for each variable  $x_i$ , a vertex  $?x_i \in V_{\mathbb{S}}$ , a vertex  $x_i \in V_{x_i}$ , and a vertex  $\neg x_i \in V_{\neg x_i}$ ;
- for each clause  $C_j$ , a vertex  $C_j \in V_{C_j}$ ;
- a sink vertex  $\blacktriangledown$  (drawn three times on Figure 8 for convenience).

which are connected by the following edges (unmentioned rewards are equal to 0, and we write  $m = 2n + p$ ):

- from the vertex  $a$  to the vertex  $b$  and from the vertex  $b$  to the vertex  $a$ , two edges that give Alice the reward 0, Bob the reward 3, and Witness the reward 1;
- from  $a$  to  $?x_1$  and from  $b$  to  $c$ , an edge;
- from  $c$  to itself, an edge giving both Alice and Bob the reward 2, and giving Witness the reward 1;
- from each  $?x_i$  to  $\neg x_i$  and from  $\neg x_i$  to  $?x_{i+1}$  (or to  $C_1$  if  $i = n$ ), an edge giving:
  - \* the reward  $2m$  to  $\neg x_i$ ,
  - \* the reward  $m$  to every player  $C_j$  such that the clause  $C_j$  contains the literal  $\neg x_i$ ,
  - \* the reward 2 to Alice;
  - \* and if  $i = n$ , the reward 1 to Witness;
- from each  $?x_i$  to  $x_i$  and from  $x_i$  to  $?x_{i+1}$  (or to  $C_1$  if  $i = n$ ), an edge giving:
  - \* the reward  $2m$  to  $x_i$ ,
  - \* the reward  $m$  to every player  $C_j$  such that the clause  $C_j$  contains the literal  $x_i$ ,
  - \* and the reward  $2 - \frac{m}{2^{i+1}}$  to Alice;
- from each  $C_j$  to  $C_{j+1}$  (or  $?x_1$  if  $j = p$ ), an edge giving the reward 2 to Alice;
- from the sink vertex  $\blacktriangledown$  to itself, an edge giving the reward 1 to Alice, the reward 2 to each clause player, the reward 4 to each literal player, and 1 to Witness.

Let us now present the correspondence between  $\varepsilon$ -SPEs and valuations satisfying  $\varphi$ .

- *The strategy profile  $\bar{\sigma}_v$ .*

Let  $v$  be a valuation satisfying  $\varphi$ . We define the memoryless strategy profile  $\bar{\sigma}_v$  as follows: from the vertex  $a$ , Alice always goes to  $?x_1$ ; from the vertex  $b$ , Bob always goes to  $c$ ; from each vertex  $?x_i$ , Solver always goes to  $x_i$  if  $v(x_i) = 1$ , and to  $\neg x_i$  otherwise; from their vertices, the clause players and the literal players that are satisfied by  $v$  do never go to the vertex  $\blacktriangledown$ ; and the literal players that are not satisfied by  $v$  do whenever they have the opportunity.

Such a strategy profile is an  $\varepsilon$ -SPE, where  $\varepsilon = \sum_{i=1}^n \frac{v(x_i)}{2^i}$ . Indeed, Solver's payoff is constant, and Witness does not control any vertex, hence they have no profitable

deviation. In every subgame where they have actions to choose, all the clause players get at least the payoff 2, since at least one of their literals is satisfied (and therefore the corresponding vertex is visited at each turn). Similarly, from the vertex he controls, each literal player gets the payoff 4, either because he is satisfied by  $\nu$  or by going to the vertex  $\blacktriangledown$ ; they have therefore no profitable deviation. As for Bob, in every subgame where he has an action to choose, he gets the payoff 2, and cannot get a better one, since Alice always plans to go to  $?x_1$ . Let us now focus on Alice. From the vertex  $a$ , the only one that she controls, she could get the payoff 2 by going to  $b$ . By going to the vertex  $?x_1$ , she gets the payoff:

$$\begin{aligned} & \frac{1}{2n+p} \left( \sum_{i=1}^n 2 \left( 2 - (2n+p) \frac{\nu(x_i)}{2^{i+1}} \right) + 2p \right) \\ & = 2 - \sum_{i=1}^n \frac{\nu(x_i)}{2^i} = 2 - \varepsilon, \end{aligned}$$

hence  $\bar{\sigma}_\nu$  is an  $\varepsilon$ -SPE, and is not a  $\delta$ -SPE for any  $\delta < \varepsilon$ .

– *The valuation  $\nu_{\bar{\sigma}}$ .*

Let  $\bar{\sigma}$  be a 1-SPE such that the play  $\pi = \langle \bar{\sigma} \rangle$  traverses the vertex  $?x_1$ , but does never reach the vertex  $\blacktriangledown$ . We define the valuation  $\nu_{\bar{\sigma}}$  by  $\nu_{\bar{\sigma}}(x_i) = 1$  if and only if  $\pi$  traverses the vertex  $x_i$ .

Let us note that for every vertex  $x_i$  that is traversed by  $\pi$ , the player  $x_i$  can deviate and go to the vertex  $\blacktriangledown$ , where he can get the payoff 4. Since  $\bar{\sigma}$  is a 1-SPE, we have therefore  $\mu_{x_i}(\pi) \geq 3$ , and therefore  $\mu_{\neg x_i}(\pi) \leq 1$ . As a consequence, the vertices  $x_i$  and  $\neg x_i$  cannot both be traversed; and if the vertex  $\neg x_i$  is traversed, then we have  $\nu_{\bar{\sigma}}(x_i) = 0$ .

Let us prove that the valuation  $\nu_{\bar{\sigma}}$  satisfies  $\varphi$ . Let us consider a clause  $C_j$  of  $\varphi$ . Since the vertex  $C_j$  is visited (infinitely often), there is a deviation available for player  $C_j$  that grants her the payoff 2. Since  $\bar{\sigma}$  is a 1-SPE, we have  $\mu_{C_j}(\pi) \geq 1$ . Therefore, there is at least one literal  $\ell$  of  $C_j$  such that the vertex  $\ell$  is visited by  $\pi$ , i.e. such that  $\nu_{\bar{\sigma}}$  satisfies  $\ell$ . Consequently, the valuation  $\nu_{\bar{\sigma}}$  satisfies  $C_j$ , and therefore  $\varphi$ .

Moreover, since the play  $\pi$  does never traverse both  $x_i$  and  $\neg x_i$  for any  $i$ , it grants Alice the payoff:

$$\begin{aligned} & \frac{1}{2n+p} \left( \sum_{i=1}^n 2 \left( 2 - (2n+p) \frac{\nu_{\bar{\sigma}}(x_i)}{2^{i+1}} \right) + 2p \right) \\ & = 2 - \sum_{i=1}^n \frac{\nu_{\bar{\sigma}}(x_i)}{2^i}. \end{aligned}$$

Therefore, if  $\nu_{\min}$  is the least valuation satisfying  $\varphi$ , then we have  $\varepsilon_{\min} = \sum_{i=1}^n \frac{\nu_{\min}(x_i)}{2^i}$ . Indeed, the strategy profile  $\bar{\sigma}_{\nu_{\min}}$  is a  $\sum_{i=1}^n \frac{\nu_{\min}(x_i)}{2^i}$ -SPE, and we can prove that there is no  $\varepsilon$ -SPE with  $\varepsilon < \sum_{i=1}^n \frac{\nu_{\min}(x_i)}{2^i}$ : if  $\bar{\sigma}$  is an  $\varepsilon$ -SPE with  $\varepsilon < 1$ , then necessarily, there exist infinitely many integers  $k$  such that  $\sigma_{\mathbb{A}}((ab)^k a) = ?x_1$ , because otherwise each play  $\langle \bar{\sigma}_{\uparrow (ab)^k a} \rangle$  would either end in the vertex  $c$  (and then Bob would have a deviation profitable by more than 1 by refusing to go to  $c$ ), or would be equal to  $(ab)^\omega$  (and

then Alice would have a deviation profitable by more than 1 by going to  $?x_1$ ). Then, for each such  $k \neq 0$ , we have  $\sigma_{\mathbb{B}}((ab)^k) = c$  (if Bob does not go to  $c$ , then he gets only the payoff 1, while by going to  $c$ , he gets the payoff 2). Therefore, if we choose some  $k$  such that  $\sigma_{\mathbb{A}}((ab)^k a) = ?x_1$ , we also have  $\mu_{\mathbb{A}}(\langle \bar{\sigma}_{\uparrow(ab)^k ab} \rangle) = 2$ . Since  $\bar{\sigma}$  is an  $\varepsilon$ -SPE with  $\varepsilon < 1$ , we have therefore  $\mu_{\mathbb{A}}(\langle \bar{\sigma}_{\uparrow(ab)^k a} \rangle) > 1$ , which means that the play  $\langle \bar{\sigma}_{\uparrow(ab)^k a} \rangle$  does never reach the vertex  $\blacktriangledown$ . Then, the strategy profile  $\bar{\sigma}_{\uparrow(ab)^k a}$  is a 1-SPE such that the play  $\langle \bar{\sigma}_{\uparrow(ab)^k a} \rangle$  traverses the vertex  $?x_1$ , but does never reach the vertex  $\blacktriangledown$ : the valuation  $v_{\bar{\sigma}_{\uparrow(ab)^k a}}$  is defined, satisfies the formula  $\varphi$ , and is such that:

$$\mu_{\mathbb{A}}(\langle \bar{\sigma}_{\uparrow(ab)^k a} \rangle) = 2 - \sum_{i=1}^n \frac{v_{\bar{\sigma}_{\uparrow(ab)^k a}}(x_i)}{2^i}.$$

By going to the vertex  $b$  instead of  $?x_1$ , Alice has therefore a deviation that is profitable by  $\sum_{i=1}^n \frac{v_{\bar{\sigma}_{\uparrow(ab)^k a}}(x_i)}{2^i}$ . Moreover, since the valuation  $v_{\bar{\sigma}_{\uparrow(ab)^k a}}$  satisfies  $\varphi$ , it is lexicographically greater than or equal to  $v_{\min}$ , hence the inequality:

$$\sum_{i=1}^n \frac{v_{\bar{\sigma}_{\uparrow(ab)^k a}}(x_i)}{2^i} \geq \sum_{i=1}^n \frac{v_{\min}(x_i)}{2^i},$$

and therefore  $\varepsilon \geq \sum_{i=1}^n \frac{v_{\min}(x_i)}{2^i}$ , as desired.

We can now conclude that there exists an  $\varepsilon_{\min}$ -SPE  $\bar{\sigma}$  in this game such that  $\mu_{\mathbb{W}}(\langle \bar{\sigma} \rangle) \leq 0$  if and only if  $v_{\min}(x_n) = 1$ :

- if there exists such an  $\varepsilon_{\min}$ -SPE, then necessarily the play  $\langle \bar{\sigma} \rangle$  visits infinitely often the vertex  $x_n$  (every other play gives Witness a positive payoff). Therefore, the valuation  $v_{\min} = v_{\bar{\sigma}}$  is such that  $v_{\min}(x_n) = 1$ .
- Conversely, if  $v_{\min}(x_n) = 1$ , then the  $\varepsilon_{\min}$ -SPE  $\bar{\sigma}_{v_{\min}}$  traverses the vertex  $?x_1$  and does never traverse  $\neg x_n$ , nor reach the vertex  $\blacktriangledown$ ; it grants therefore Witness the payoff 0.  $\square$

## H Proof of Theorem 10

**Theorem 10.** *In quantitative reachability games, the Nash rational verification problem, deterministic or not, is coNP-complete.*

*Proof.* We prove here that the Nash universal threshold problem is coNP-complete. The theorem will follow by Corollary 2.

- *Hardness.*

Let us proceed by reduction from the NP-complete problem SAT to the complement of the Nash universal threshold problem. Let  $\varphi = \bigwedge_{j=1}^p C_j$  be a formula from the propositional logic in conjunctive normal form, over the variables  $x_1, \dots, x_n$ . We wish to define a quantitative reachability game  $\mathcal{G}_{\uparrow v_0}$ , a player  $i$  and a threshold  $t$ , such that the formula  $\varphi$  is satisfiable if and only if there exists an NE  $\bar{\sigma}$  satisfying  $\mu_i(\langle \bar{\sigma} \rangle) \leq t$ .

Let  $\mathcal{G}_{\uparrow v_0}$  be the  $p+1$ -player game presented in Figure 16. Its players are *Solver*, written  $\mathbb{S}$ , and the clauses  $C_1, \dots, C_p$ . When it is a relevant information, the player controlling

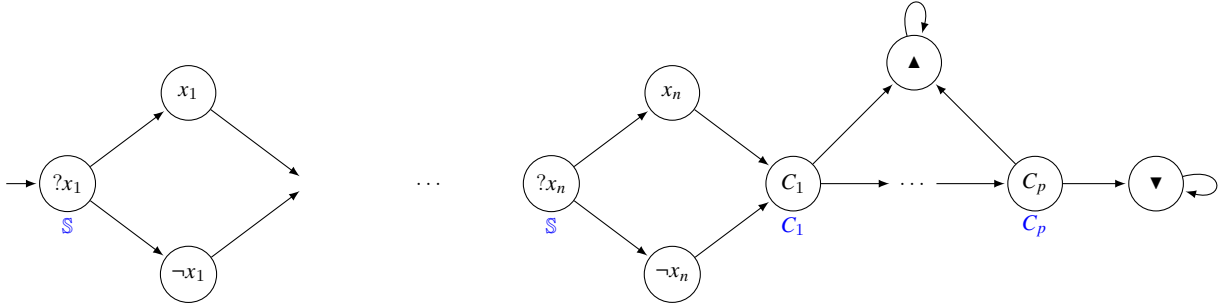

Figure 16: The game  $\mathcal{G}_{\uparrow?x_1}$

a vertex is written in blue. The target set of Solver is  $\{\blacktriangle\}$ , and the target set of each clause player  $C_j$  is  $\{\blacktriangle\} \cup \{\ell \mid \ell \text{ is a literal of } C_j\}$ .

Finally, we define  $t = 0$  and  $i = \mathbb{S}$ . That construction can be made in polynomial time: let us now prove that there exists an NE  $\bar{\sigma}$  satisfying  $\mu_{\mathbb{S}}(\langle \bar{\sigma} \rangle) = 0$  if and only if the formula  $\varphi$  is satisfiable.

- *If there exists such an NE  $\bar{\sigma}$ .*

Then, let  $\pi = \langle \bar{\sigma} \rangle$ , and let us define the valuation  $\nu$  that maps each variable  $x$  to 1 if  $\pi$  traverses the vertex  $x$ , and to 0 otherwise.

Let  $C_j$  be a clause of  $\varphi$ . Since  $\mu_{\mathbb{S}}(\langle \bar{\sigma} \rangle) = 0$ , necessarily, the play  $\pi$  traverses the vertex  $C_j$ , and does not reach the vertex  $\blacktriangle$ . Therefore, if going to  $\blacktriangle$  is not a profitable deviation for player  $C_j$ , it means that a vertex of her target set has already been visited before. In other words, there is at least one literal  $\ell$  of  $C_j$  such that the vertex  $\ell$  is traversed by  $\pi$ . If it is a positive literal  $\ell = x$ , then we have  $\nu(x) = 1$  and it is satisfied. If it is a negative literal  $\ell = \neg x$ , then the vertex  $x$  is not visited, hence  $\nu(x) = 0$ , and  $\ell$  is also satisfied, hence  $C_j$  is satisfied, hence  $\varphi$  is satisfied by  $\nu$ .

- *If  $\varphi$  is satisfiable.*

Let  $\nu$  be a valuation that satisfies it. Let us define the strategy profile  $\bar{\sigma}$  as follows: after every history of the form  $h?x$ , we have  $\sigma_{\mathbb{S}}(h?x) = x$  if  $\nu(x) = 1$ , and  $\sigma_{\mathbb{S}}(h?x) = \neg x$  otherwise. Then, for every history of the form  $hC_j$ , we have  $\sigma_{C_j}(hC_j) = C_{j+1}$ , or  $\sigma_{C_j}(hC_j) = \blacktriangledown$  if  $j = p$ .

Thus, we have  $\mu_{\mathbb{S}}(\langle \bar{\sigma} \rangle) = 0$ , as desired. Let us now prove that  $\bar{\sigma}$  is an NE. Since no clause player plans to go to  $\blacktriangle$  after any history, Solver does not have any profitable deviation. Let now  $C_j$  be a clause player: since the clause  $C_j$  is satisfied by  $\nu$ , one of its literals is satisfied — let us write it  $\ell$ . Then, the vertex  $\ell$ , which belongs to the target set of player  $C_j$ , is traversed by the play  $\langle \bar{\sigma} \rangle$  before it reaches a vertex controlled by player  $C_j$ ; hence that player has no profitable deviation either. The strategy profile  $\bar{\sigma}$  is an NE satisfying  $\mu_{\mathbb{S}}(\langle \bar{\sigma} \rangle) = 0$ .

- *Easiness.*

Let  $n = \text{card}V$  and  $p = \text{card}\Pi$ .

A non-deterministic algorithm that decides this problem in polynomial time operates as follows: first, for each player  $j$  and each vertex  $u \in V_j$ , compute the value  $\lambda(u) = \inf_{\bar{\sigma}_{-j}} \sup_{\sigma_j} \mu_j(\langle \bar{\sigma} \rangle)$ , the best payoff that player  $j$  can enforce from  $u$ , or in other words (by Martin's theorem) the worst payoff the other players can force player  $j$  to get. That

can be achieved by a classical fixed-point algorithm: first, for each  $v \in V$ , initialize  $\lambda_0(v) = 1$  if  $v \in T_j$  and  $\lambda_0(v) = 0$  otherwise. Then, for each  $k$  and each  $v$ , define:

$$\lambda_{k+1}(v) = \begin{cases} \max_{vw \in E} \frac{1}{1 + \frac{1}{\lambda_k(w)}} & \text{if } v \in V_j \\ \min_{vw \in E} \frac{1}{1 + \frac{1}{\lambda_k(w)}} & \text{otherwise.} \end{cases}$$

Compute that sequence until  $\lambda_k = \lambda_{k+1}$ : then, we have  $\lambda(u) = \lambda_k(u)$ . Since for each  $k$  and  $v$ , we have  $\lambda_k(v) \in \{0, \frac{1}{n}, \frac{1}{n-1}, \dots, 1\}$ , that computation requires at most  $\text{card}V$  iterations, and can therefore be done in deterministic polynomial time.

Once that computation is done, the Nash rational verification problem reduces, by Lemma 1, to deciding whether there exists a play  $\pi$  in  $\mathcal{G}_{\uparrow v_0}$  such that  $\mu_i(\langle \bar{\sigma} \rangle) \leq t$ , and that for each player  $j$  and each vertex  $\pi_k \in V_j$ , we have either  $\text{Occ}(\pi_{<k}) \cap T_j \neq \emptyset$  (player  $j$  has already reached their target set) or  $\mu_j(\pi_{\geq k}) \geq \lambda(\pi_k)$ . If such a play exists, there exists one that is a lasso  $hc^\omega$  where  $|h| \leq 2np + n$  and  $c$  is a simple cycle.

Indeed, let  $\pi$  be such a play. For each  $k$ , let  $P_k$  be the set of the players for which a constraint must be satisfied at step  $k$  — i.e., the set of players  $j$  such that, for some  $\ell \leq k$ , we have  $\pi_\ell \in V_j$  and  $\lambda(\pi_\ell) \neq 0$ . Then, since for every  $v$ , we have  $\lambda(v) \in \{0, \frac{1}{n}, \frac{1}{n-1}, \dots, 1\}$ , once a constraint appears for some player  $j$ , it must be satisfied within at most  $n$  steps — in other words, if  $j \in P_k$ , then  $j \notin P_\ell$  for  $\ell \geq k+n$ . Therefore, let us consider the prefix  $\pi_{\leq 2np+n}$ : necessarily, there are indices  $k < \ell \leq 2np + n$  such that  $\pi_k = \pi_\ell$  and  $P_k = \dots = P_\ell = \emptyset$ . Let us, moreover, choose  $k$  and  $\ell$  such that the cycle  $\pi_{k+1} \dots \pi_\ell$  is a simple cycle (if it is not the case, we can increase  $k$  and decrease  $\ell$ ). And then, the play  $\chi = \pi_{\leq k}(\pi_{k+1} \dots \pi_\ell)^\omega$  is also an NE play satisfying  $\mu_i(\chi) \leq t$ .

As a consequence, at this step, the algorithm can guess non-deterministically such a lasso, and then check in polynomial time that player  $i$  gets a payoff smaller than or equal to  $t$ , and that all the constraints are correctly satisfied.  $\square$

## I Proof of Theorem 11

**Theorem 11.** *In energy games, the deterministic Nash-checking problem can be decided in polynomial time.*

*Proof.* Given an energy game  $\mathcal{G}_{\uparrow v_0}$  and a deterministic multiplayer Mealy machine  $\mathcal{M}$ , the unique strategy profile  $\bar{\sigma} \in \text{Comp}_{\uparrow v_0}(\mathcal{M})$  is not an NE if and only if these two conditions are satisfied for some player  $i$ :

- $\mu_i(\langle \bar{\sigma} \rangle) = 0$ ;
- there exists a play  $\pi$  compatible with  $\bar{\sigma}_{-i}$  such that  $\mu_i(\pi) = 1$ .

The first condition can be checked in polynomial time, since the play  $\langle \bar{\sigma} \rangle$  is a lasso whose size is bounded by a polynomial function of  $\|\mathcal{M}\|$ . The second condition is satisfied if and only if there exists a play giving player  $i$  the payoff 1 in the one-player game:

$$\mathcal{G}' = (\{i\}, V \times Q, (V \times Q), E', \mu'),$$

where  $\mu' : (\pi_0, q_0)(\pi_1, q_1) \dots \mapsto \mu_i(\pi)$ , and  $E'$  contains the transitions  $(u, p)(v, q)$  such that either  $(p, u, q, v) \in \Delta$ , or  $u \in V_i$  and there exists  $v'$  such that  $(p, u, q, v') \in \Delta$ . Checking the existence of such a play can be done in polynomial time according to Theorem 7 in [3].  $\square$

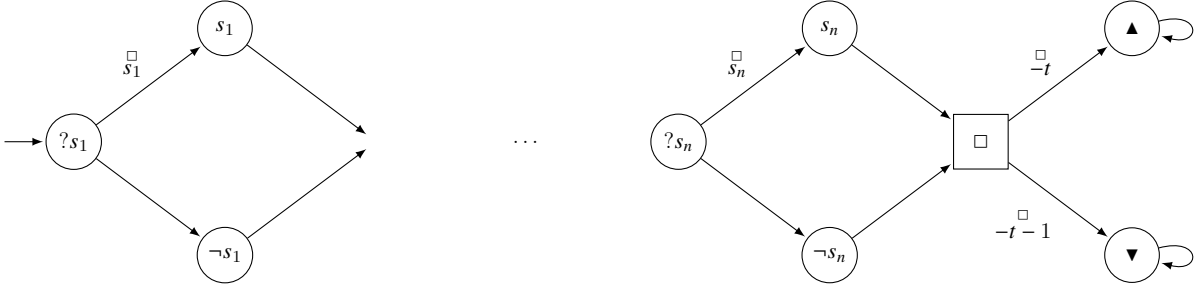

Figure 17: The game  $\mathcal{G}_{\uparrow ?s_1}$

## J Proof of Theorem 12

**Theorem 12.** *In energy games, the Nash-checking, the subgame-perfect-checking, and the deterministic subgame-perfect-checking problems are coNP-complete.*

*Proof.* • *Hardness.*

Let us proceed by reduction from the NP-complete problem SUBSETSUM. Let  $\rho \in \{\text{Nash, subgame-perfect}\}$ . Let  $S = \{s_1, \dots, s_n\} \subseteq \mathbb{N}$  and let  $t \in \mathbb{N}$ . We want to construct an energy game  $\mathcal{G}_{\uparrow v_0}$  and a multiplayer Mealy machine  $\mathcal{M}$ , such there exists a strategy profile  $\bar{\sigma} \in \text{Comp}_{\uparrow v_0}(\mathcal{M})$  that is not a  $\rho$ -equilibrium if and only if there exists a subset  $S' \subseteq S$  such that  $\sum_{s \in S'} s = t$ .

Let  $\mathcal{G}_{\uparrow v_0}$  be the two-player game presented in Figure 17, with two players, player  $\circ$  and player  $\square$ . Once again, all the rewards that are not written, and in particular all player  $\circ$ 's rewards, are equal to 0.

- Let us first use this game to prove the coNP-hardness of the Nash-checking problem: let us define  $\mathcal{M}$  as the one-state non-deterministic machine that enables all the actions for both players.

Assume that there exists a subset  $S' \subseteq S$  such that  $\sum_{s \in S'} s = t$ . Then, let us consider the strategy profile  $\bar{\sigma}$  defined by  $\sigma_{\square}(h\square) = \blacktriangledown$  and  $\sigma_{\circ}(h?s_i) = s_i$  if  $s_i \in S'$ , and  $\sigma_{\circ}(h?s_i) = \neg s_i$  otherwise, for every  $h$  and  $i$ . That strategy profile is compatible with  $\mathcal{M}$ , and it is not an NE, since player  $\square$  has exactly the energy level  $t$  when he reaches the vertex  $\square$ , and therefore loses by going to  $\blacktriangledown$  while he could win by going to  $\blacktriangle$ .

Conversely, assume that there is a strategy profile  $\bar{\sigma}$  compatible with  $\mathcal{M}$  that is not an NE. Let  $\pi = \langle \bar{\sigma} \rangle$ . Since player  $\circ$  cannot lose in  $\mathcal{G}$ , the player who has a profitable deviation is player  $\square$ . Since player  $\square$  controls only the vertex  $\square$ , that can appear only once along  $\pi$ , the only possibility is that player  $\square$  loses the play  $\pi = \pi_{\leq 2n} \square \blacktriangledown^\omega$  but wins the play  $\pi_{\leq 2n} \square \blacktriangle^\omega$ . That means that  $\text{EL}_{\square}(\pi_{\leq 2n} \square) = t$ . Therefore, if  $S' = \{s \in S \mid \text{the vertex } s \text{ appears in } \pi\}$ , we have  $\sum_{s \in S'} s = t$ .

Thus, the subset-sum problem reduces in polynomial time to the complement of the Nash-checking problem, which is therefore coNP-hard.

- Let us now use the same game to prove that the deterministic subgame-perfect-checking problem, and therefore the subgame-perfect-checking problem, are coNP-hard. Let us define  $\mathcal{M}$  as a one-state deterministic machine that defines arbitrarily the actions of player  $\circ$  and that forces player  $\square$ , from the vertex  $\square$ , to go to the vertex  $\blacktriangledown$ . Let  $\bar{\sigma}$  be the unique strategy profile compatible with  $\mathcal{M}$ .

Then, if there exists a subset  $S' \subseteq S$  such that  $\sum_{s \in S'} s = t$ , we can define the history  $h = h_0 \dots h_{2n}$  with  $h_{2i+1} = s_i$  if  $s_i \in S'$  and  $h_{2i+1} = \neg s_i$  otherwise. Then, we have  $\text{EL}_\square(h) = t$ , hence in the subgame  $\mathcal{G}_{\upharpoonright h}$ , player  $\square$  loses by going to  $\blacktriangledown$ , while he could win by going to  $\blacktriangle$ , hence  $\bar{\sigma}$  is not an SPE.

Conversely, if  $\bar{\sigma}$  is not an SPE, then let  $h$  be such that  $\bar{\sigma}_{\upharpoonright h}$  is not an NE. Necessarily, the player who has a profitable deviation is player  $\square$ . Thus, without loss of generality, we can assume that  $h$  ends in the vertex  $\square$ . Then, if we define  $S' = \{s \mid s \text{ appears along } h\}$ , we have  $\sum_{s \in S'} s = t$ .

Thus, the problem SUBSETSUM reduces in polynomial time to the complement of the deterministic subgame-perfect-checking problem, which is therefore coNP-hard.

- *Easiness.*

Let  $i \in \Pi$ . Let us consider the graph  $G_i$ , whose vertex set is  $V \times Q$ , and whose edges are partitioned into *green edges*, i.e. the edges  $(u, p)(v, q)$  with  $(p, u, q, v) \in \Delta$ , and the *red edges*, i.e. the edges  $(u, p)(v, q)$  with  $(p, u, q, w) \in \Delta$  for some  $w \neq v$ , with  $uv \in E$  and  $u \in V_i$ . We define the reward function  $r : (u, p)(v, q) \mapsto r_i(uv)$ . That graph may be seen as the product game  $\mathcal{G}_{\upharpoonright v_0} \otimes \mathcal{M}$ , but where  $\mathcal{M}$  is a multiplayer Mealy machine, hence Demon controls all the vertices.

There exists a strategy profile  $\bar{\sigma} \in \text{Comp}_{\upharpoonright v_0}(\mathcal{M})$  in which player  $i$  has a profitable deviation in some subgame (resp. in which player  $i$  has a profitable deviation) if and only if in the graph  $G_i$ , there exists a finite path  $p$  (resp. a path  $p$  made of green edges) from the vertex  $(v_0, q_0)$  to a vertex  $(v, q)$  with  $\text{EL}_r = n$ , and if from  $(v, q)$  with energy  $n$ , there exist a path  $(v, q)\pi$  that uses only green edges and that is lost by player  $i$ , and a path  $(v, q)\pi'$  that can use all edges and that is won by player  $i$ , with  $\pi_0 \neq \pi'_0$ .

A non-deterministic algorithm that recognizes negatives instances of the subgame-perfect-checking problem (resp. the Nash-checking problem) in polynomial time is therefore the following one: first, for each player  $i$ , for each vertex  $w$  of the graph  $G_i$ , compute in deterministic polynomial time, using the algorithm provided by [3]:

- the least integer  $a(w)$  such that there exists a winning infinite path  $\pi'$  starting from  $w$  with energy  $a(w)$ ;
- the greatest integer  $b(w)$  such that there exists a losing infinite path  $\pi$  starting from  $w$  with energy  $b(w)$  using only green edges.

Then, use the NP algorithm provided by [24] to decide whether there exists a vertex  $(v, q)$  in  $G_i$  and two edges  $(v, q)w \neq (v, q)w'$ , such that from the vertex  $(v_0, q_0)$ , one can reach  $(v, q)$  (resp. one can reach  $(v, q)$  using only green edges) with energy level  $n$  satisfying  $n + r((v, q)w) \leq b(w)$  and  $n + r((v, q)w') \geq a(w)$ .  $\square$

## K Two-counter machines

A *two-counter machine* is a tuple  $\mathcal{K} = (Q, q_0, q_f, \Delta_{C_1^+}, \Delta_{C_2^+}, \Delta_{C_1^-}, \Delta_{C_2^-})$ , where  $Q$  is a finite set of *states*, where  $q_0 \in Q$  is the *initial state* and  $q_f$  is the *final state*, and where  $\Delta_{C_1^+}, \Delta_{C_2^+} \in Q \times Q$  are the sets of *incremental transitions*, and  $\Delta_{C_1^-}, \Delta_{C_2^-} \subseteq Q \times Q \times Q$  are the sets of *test transitions*, such that every state  $q \in Q \setminus \{q_f\}$  admits exactly one outgoing transition (either incremental or test), and such that the state  $q_f$  admits none. For each *counter*  $C \in \{C_1, C_2\}$ ,



Figure 18: A machine that halts on  $(0, 0)$

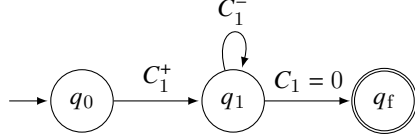
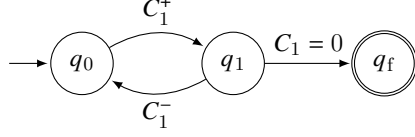

Figure 19: A machine that does not halt on  $(0, 0)$



we define the *interpretation* of  $C$  as the function  $\hat{C} : q_0 Q^* \rightarrow \mathbb{N}$  defined by  $\hat{C}(q_0) = 0$ , and  $\hat{C}(q_0 \dots q_n) = \hat{C}(q_0 \dots q_{n-1}) + 1$  if  $(q_{n-1}, q_n) \in \Delta_{C^+}$ ,  $\hat{C}(q_0 \dots q_n) = \hat{C}(q_0 \dots q_{n-1}) - 1$  if  $(q_{n-1}, q_n, q) \in \Delta_{C^-}$  for some  $q$ , and  $\hat{C}(q_0 \dots q_n) = \hat{C}(q_0 \dots q_{n-1})$  otherwise. A *run* of  $\mathcal{K}$  is a sequence  $\eta_0 \eta_1 \dots$ , either infinite or ending with  $q_f$ , such that for every index  $k$ , we have either  $(\eta_k, \eta_{k+1}) \in \Delta_{C^+}$ , or  $(\eta_k, \eta_{k+1}, q) \in \Delta_{C^-}$  for some  $q$  and  $\hat{C}(\eta_0 \dots \eta_k) > 0$ , or  $(\eta_k, q, \eta_{k+1}) \in \Delta_{C^-}$  for some  $q$  and  $\hat{C}(\eta_0 \dots \eta_k) = 0$ , for some  $C \in \{C_1, C_2\}$ . Note that each two-counter machine admits exactly one run. A machine *halts* if that unique run is finite. The halting problem of a two-counter machine is undecidable, and in particular not co-recursively enumerable.

Figures 18 and 19 present two examples of two-counter machines. The arrow with the label  $C_1^+$  from  $q_0$  to  $q_1$  indicates a transition  $(q_0, q_1) \in \Delta_{C_1^+}$ . The arrows with the label  $C_1^-$  from  $q_1$  to itself and with the label  $C_1 = 0$  from  $q_1$  to  $q_f$  indicate a transition  $(q_1, q_1, q_f) \in \Delta_{C_1^-}$ .

## L Proof of Theorem 13

**Theorem 13.** *In energy games, the Nash rational verification problem, deterministic or not, is undecidable and co-recursively enumerable.*

*Proof.* We prove here that the Nash universal threshold problem is undecidable and co-recursively enumerable. The theorem will follow by Corollary 2.

- *Undecidability.*

We show undecidability by reduction from the halting problem of a two-counter machine.

Let  $\mathcal{K}$  be a two-counter machine. We define an energy game  $\mathcal{G}_{\uparrow q_0^1}$  with five players — players  $C_1^T, C_1^\perp, C_2^T, C_2^\perp$ , and  $\mathbb{W}$ , called *Witness* — by assembling the gadgets presented in Figures 9, 10, 11, and 12 — the rewards that are not presented are equal to 0, and the players controlling relevant vertices are written in blue. For each state of  $\mathcal{K}$ , we define from one to two vertices, plus the additional vertex  $\blacktriangle$ . Then, a play in  $\mathcal{G}_{\uparrow v_0}$  that

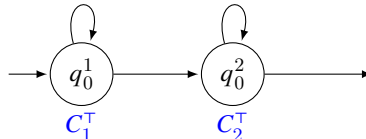

Figure 20: Gadget for the initial state

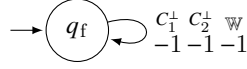

Figure 21: Gadget for the final state

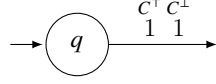

Figure 22: Gadget for incrementations of counter  $C \in \{C_1, C_2\}$

does not reach the vertex  $\blacktriangle$  simulates a sequence of transitions of  $\mathcal{K}$ , that can be a valid run or not: at each step, the counter  $C_i$  is captured by the energy level of player  $C_i^\top$ , always equal to the energy level of player  $C_i^\perp$ . Let us now prove that the game  $\mathcal{G}_{\uparrow q_0^1}$  admits an NE where Witness loses if and only if the machine  $\mathcal{K}$  terminates.

– *If such an NE exists.*

Then, let us write it  $\bar{\sigma}$ , and let  $\pi = \langle \bar{\sigma} \rangle$ . Since  $\pi$  is lost by Witness, the play  $\pi$  reaches the vertex  $q_f$ , and therefore simulates a terminating sequence of transitions of  $\mathcal{K}$  (note that one transition may be represented by several edges). We must now prove that that run is valid, i.e. that tests are simulated correctly.

Let us assume that at some point along the play  $\pi$ , from a vertex  $q$ , player  $C_i^\top$ , with  $i \in \{1, 2\}$ , does not take the edge to the vertex  $q'$  while her energy level is zero. Then, she loses, hence she has a profitable deviation at the beginning of the play, by looping on the vertex  $q_0^i$ .

Let us now assume that she goes to the vertex  $q'$ , while her energy is positive. Then, player  $C_i^\perp$ 's energy is also positive: he can go to the vertex  $\blacktriangle$  and win. That would be a profitable deviation, since, as the play  $\pi$  reaches the vertex  $q_f$ , it is lost by player  $C_i^\perp$ .

Therefore, the play  $\pi$  does not fake any test, and simulates correctly the machine  $\mathcal{K}$ , which terminates.

– *If the machine  $\mathcal{K}$  terminates.*

Then, let us define a strategy profile  $\bar{\sigma}$  in  $\mathcal{G}_{\uparrow q_0^1}$  as follows: in tests of counter  $C$ , player  $C^\top$  goes to  $q'$  if and only if her energy level is positive; from  $q'$ , player  $C^\perp$  never goes to the vertex  $\blacktriangle$ . Let  $\pi = \langle \bar{\sigma} \rangle$ : since tests are simulated correctly, the play  $\pi$  simulates the run of  $\mathcal{K}$ , and therefore reaches the vertex  $q_f$ . It is therefore lost by Witness,  $C_1^\perp$  and  $C_2^\perp$ .

Witness has no profitable deviation, since he does not control any vertex. The only vertices controlled by each player  $C^\perp$  are the vertices of the form  $q'$ . Those

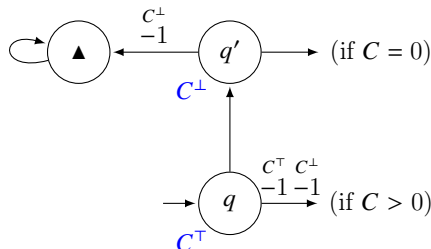

Figure 23: Gadget for tests of counter  $C$

vertices are reached only when player  $C^\top$ 's, and therefore player  $C^\perp$ 's energy level is zero. Then, deviating and going to the vertex  $\blacktriangle$  is not profitable for player  $C^\perp$ , since it makes him immediately lose. The strategy profile  $\bar{\sigma}$  is therefore an NE, lost by Witness.

Every NE outcome in the game  $\mathcal{G}_{\uparrow q_0^1}$  is won by Witness if and only if the machine  $\mathcal{K}$  does not terminate. Therefore, the halting problem of two-counter machines reduces to the Nash universal threshold problem in energy games, which is therefore undecidable.

- *Co-recursive enumerability.*

First let us prove that in an energy game  $\mathcal{G}_{\uparrow v_0}$ , if there exists an NE that makes some player  $i$  lose, then there exists a finite-memory one.

Indeed, in such a case, let  $\pi = \langle \bar{\sigma} \rangle$ . By Dickson's lemma, there exist two indices  $m$  and  $n$ , with  $m < n$ , such that  $\pi_m = \pi_n$  and such that for every player  $j$  that does not lose the play  $\pi$ , we have  $\text{EL}_j(\pi_{\leq m}) \leq \text{EL}_j(\pi_{\leq n})$ . Moreover, we can chose  $m$  great enough to have  $\text{EL}_j(\pi_{\leq m}) = \perp$  for every player  $j$  that loses the play  $\pi$ . Thus, the players winning the play  $\pi$  are exactly the players winning the play  $\chi = \pi_{< m} (\pi_m \dots \pi_{n-1})^\omega$ .

Now, let  $k \leq n$ , and let  $j$  be the player controlling the vertex  $\pi_k$ . If  $j$  is a player who loses the play  $\pi$ , then since  $\bar{\sigma}$  is an NE, the strategy profile  $\bar{\sigma}_{\uparrow \pi_{\leq k}}$  is a strategy profile against which player  $j$  cannot win. It is known (see for example [3], Lemma 10) that memoryless strategies are sufficient to falsify an energy objective. Therefore, let  $\bar{\tau}_{-j}^k$  be a memoryless strategy profile, from the vertex  $\pi_k$ , against which player  $j$  cannot win. Let  $\tau_j^k$  be an arbitrary memoryless strategy. If  $j$  is not a player who loses the play  $\pi$ , then we define  $\bar{\tau}^k$  as an arbitrary memoryless strategy profile.

Let  $\mathcal{M}$  be the deterministic Mealy machine defined as follows: it has  $2n$  states, namely  $q_0, \dots, q_{n-1}$  and  $q'_0, \dots, q'_{n-1}$ . From each state  $q_k$ , the transition reading the vertex  $\pi_k$  leads to the state  $q_{k+1}$  (or  $q_m$  if  $k = n - 1$ ), and outputs the vertex  $\pi_{k+1}$  (or  $\pi_m$  if  $k = n - 1$ ). The transition reading any other vertex  $v$  (if  $k \geq 1$ ) leads to the state  $q'_k$  and outputs the vertex  $\bar{\tau}^{k-1}(\pi_{< k} v)$ . From the state  $q'_k$ , the transition reading each vertex  $v$  leads to  $q'_k$ , and outputs the vertex  $\bar{\tau}^{k-1}(hv)$ , for any history  $h$  (since  $\bar{\tau}^{k-1}$  is memoryless). Thus, the only strategy profile compatible with the machine  $\mathcal{M}$  is the strategy profile that follows the play  $\chi$ , and that punishes any player who deviates by following the memoryless strategy profile  $\bar{\tau}^k$ . That strategy profile is finite-memory, and is lost by player  $i$ , as desired.

Thus, a semi-algorithm that recognizes the negative instances of the universal threshold problem consists in enumerating the deterministic multiplayer Mealy machines on  $\mathcal{G}_{\uparrow v_0}$ , and for each of them, to check (by diagonalization):

- whether the only strategy profile compatible with it is an NE: that is the deterministic Nash-checking problem, decidable (in polynomial time) by Theorem 11;
- whether that strategy profile makes player  $i$  lose: that is recursively enumerable, by constructing step by step its outcome and computing the energy levels on the fly.

We have a negative instance of the universal threshold problem if and only if at least one Mealy machine satisfies those two conditions. The Nash universal threshold problem is therefore co-recursively enumerable.  $\square$

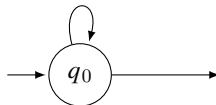

Figure 24: Gadget for the initial state

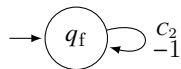

Figure 25: Gadget for the final state

## M Proof of Theorem 14

**Theorem 14.** *In energy games, the subgame-perfect rational verification problem, deterministic or not, is undecidable, even when Leader plays against only two players.*

*Proof.* We prove first the undecidability of the subgame-perfect universal threshold problem with two players. We proceed by reduction from the halting problem of a two-counter machine.

Let  $\mathcal{K}$  be a two-counter machine. We define an energy game  $\mathcal{G}_{\uparrow q_0}$  with two players, player  $C_1$  and player  $C_2$ , by assembling the gadgets presented in Figures 24, 25, 26, 27, and 28 — the rewards that are not presented are equal to 0, the round vertices are those controlled by player  $C_1$ , and the square ones are those controlled by player  $C_2$ . For each state of the machine  $\mathcal{K}$ , we define from one to three vertices, plus six additional vertices, written  $a$ ,  $b$ ,  $c$ ,  $\blacktriangle$ ,  $\blacktriangledown$ , and  $\blacktriangledown_1$ .

Then, a play in  $\mathcal{G}$  that does not reach one of the sink vertices  $\blacktriangle$ ,  $\blacktriangledown$ , or  $\blacktriangledown_1$  simulates a sequence of transitions of the machine  $\mathcal{K}$ , that can be a run or not: at each step, the counter  $C$  is captured by the energy level of player  $C$ . Let us now prove that the game  $\mathcal{G}_{\uparrow q_0}$  admits an SPE where player  $C_2$  loses if and only if the machine  $\mathcal{K}$  terminates.

- *If such an SPE exists.*

Then, let us write it  $\bar{\sigma}$ , and let  $\pi = \langle \bar{\sigma} \rangle$ . Since  $\pi$  is lost by player  $C_2$ , there are *a priori* three possibilities:

- *The play  $\pi$  reaches the vertex  $\blacktriangledown$ .* Then, player  $C_1$  loses, and has therefore a profitable deviation by looping on  $\pi_0 = q_0$ , which is impossible.
- *The play  $\pi$  is a spurious simulation of  $\mathcal{K}$ :* player  $C_1$  makes player  $C_2$  lose by going to the vertex  $q'''$ , in a test of counter  $C_2$ , when player  $C_2$ 's energy is equal to 0. Then, player  $C_2$  has a profitable deviation by going to  $b$ : there, player  $C_1$  cannot go to the vertex  $\blacktriangledown$ , because it would make her lose, while she can win by going to the vertex  $c$ ; indeed, from there, player  $C_2$  cannot go to the vertex  $\blacktriangledown_1$  because it would make him lose, since he has no more energy, while he can go to the vertex  $\blacktriangle$  and win — and let player  $C_1$  win. Therefore, that case is also impossible.

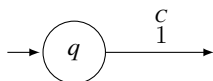

Figure 26: Gadget for incrementations of counter  $C \in \{C_1, C_2\}$

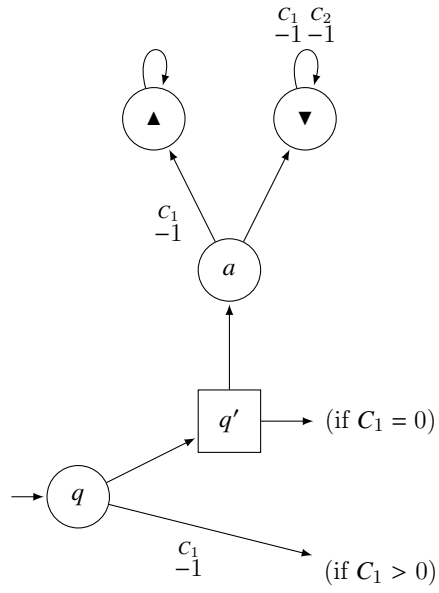

Figure 27: Gadget for tests of counter  $C_1$

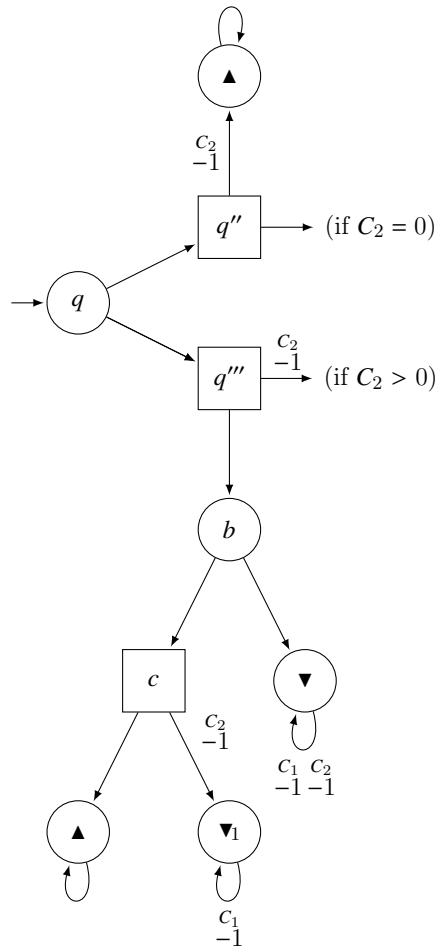

Figure 28: Gadget for tests of counter  $C_2$

- *The play  $\pi$  reaches the vertex  $q_f$ .* Then, it simulates a correct run of the machine  $\mathcal{K}$ , that reaches the state  $q_f$ . Indeed, we have already shown that  $\pi$  cannot fake a test of  $C_2$  above 0. It cannot fake a test of  $C_1$  above 0 either, because then, player  $C_1$  would lose, while she can win by looping on  $q_0$ . It cannot fake a test of  $C_2$  to 0, because then, from the vertex  $q''$ , if player  $C_2$ 's energy is greater than 0, he has a profitable deviation by going to the vertex  $\blacktriangle$ . Finally, it cannot fake a test of  $C_1$  to 0, because then, from the vertex  $q'$ , if player  $C_1$ 's energy is greater than 0, player  $C_2$  has a profitable deviation by going to  $a$ , from where player  $C_1$  cannot go to the vertex  $\blacktriangledown$ , because it would make her lose while she can win by going to  $\blacktriangle$ . Therefore, the machine  $\mathcal{K}$  terminates.

- *If the machine  $\mathcal{K}$  terminates.*

Then, let us define a strategy profile  $\bar{\sigma}$  in  $\mathcal{G}_{\uparrow q_0}$  as follows:

- in tests of counter  $C_1$ , player  $C_1$  goes to  $q'$  if and only if her energy level is zero or  $\perp$ ; from  $q'$ , player  $C_2$  goes to the vertex  $a$  if and only if player  $C_1$ 's energy level is positive;
- in tests of counter  $C_2$ , player  $C_1$  goes to  $q''$  if and only if the energy level of player  $C_2$  is zero or  $\perp$ ; from  $q''$ , player  $C_2$  goes to the vertex  $\blacktriangle$  if and only if his energy level is positive, and from  $q'''$ , he goes to  $b$  if and only if it is zero or  $\perp$ ;
- from the vertex  $a$ , player  $C_1$  goes to the vertex  $\blacktriangledown$  if and only if her energy level is zero or  $\perp$ ;
- from the vertex  $b$ , player  $C_1$  goes to the vertex  $\blacktriangledown$  if and only if the energy level of player  $C_2$  is positive;
- from the vertex  $c$ , player  $C_2$  goes to the vertex  $\blacktriangledown_1$  if and only if his energy level is positive.

Let us show that  $\bar{\sigma}$  is an SPE. Let  $hv$  be a history from the vertex  $q_0$ : let us prove that  $\bar{\sigma}_{\uparrow hv}$  is an NE.

- *If  $v$  is a vertex of the form  $q$ .*

Then, the play  $\langle \bar{\sigma}_{\uparrow hv} \rangle$  simulates the correct run of the machine  $\mathcal{K}$  from  $q$  when the counters are initialized to  $EL_{C_1}(hv)$  and  $EL_{C_2}(hv)$  (if one of those energy levels is  $\perp$ , then it simulates the correct run of  $\mathcal{K}$  where that counter is locked to 0) Therefore, player  $C_1$  wins (or has already lost), hence she cannot have a profitable deviation. As for player  $C_2$ , he cannot have a profitable deviation from a vertex of the form  $q'$ : when such a vertex is reached, player  $C_1$ 's energy is zero or  $\perp$ , hence if player  $C_2$  chooses to go to  $a$ , player  $C_1$  will go to  $\blacktriangledown$  and he will lose. He cannot have a profitable deviation from a vertex of the form  $q''$  either: when such a vertex is reached, he has a zero or  $\perp$  energy level, hence if he chooses to go to the vertex  $\blacktriangle$ , he loses. Finally, he cannot have a profitable deviation from a vertex of the form  $q'''$ : when such a vertex is reached, he has a positive energy level, hence if he goes to the vertex  $b$ , player  $C_1$  will go to the vertex  $\blacktriangledown$  and he will lose.

- *If  $v$  is a vertex of the form  $q'$ .*

Then, if player  $C_1$ 's energy level is positive, player  $C_2$  goes to  $a$ , then player  $C_1$  goes to  $\blacktriangle$ , and both player  $C_1$  and  $C_2$  win — and have therefore no profitable deviation. Otherwise, the substrategy profile  $\bar{\sigma}_{\uparrow hv}$  simulates a correct run of  $\mathcal{K}$ , and we can use the same arguments as in the previous point.

– If  $v$  is a vertex of the form  $q''$ .

Then, if player  $C_2$ 's energy level is positive, he goes to  $\blacktriangle$  and wins — and no player has a profitable deviation. Otherwise, the substrategy profile  $\bar{\sigma}_{\uparrow hv}$  simulates a correct run of  $\mathcal{K}$ , and we can use the same arguments than in the first point.

– If  $v$  is a vertex of the form  $q'''$ .

Then, if player  $C_2$ 's energy level is zero or  $\perp$ , player  $C_2$  goes to  $b$ , then player  $C_1$  goes to  $c$ , and finally player  $C_2$  goes to  $\blacktriangle$ , and both player  $C_1$  and  $C_2$  win — they have therefore no profitable deviation. Otherwise, the substrategy profile  $\bar{\sigma}_{\uparrow hv}$  simulates a correct run of  $\mathcal{K}$ , and we can use the same arguments than in the first point.

– If  $v = a$ .

Then, either player  $C_1$  has a positive energy level, and then she goes to  $\blacktriangle$  and wins, or she has a zero or  $\perp$  energy level, and then she cannot win.

– If  $v = b$ .

Then, either player  $C_2$  has a zero or  $\perp$  energy level, and then the play ends in  $\blacktriangle$  and both players win (or have already lost), or he has a positive energy level, and then player  $C_1$  cannot win, since player  $C_2$  plans to go to  $\blacktriangledown_1$ .

– If  $v = c$ .

Then, either  $C_2$  has a positive energy level, and he goes to  $\blacktriangledown_1$  and wins, or he has a zero energy level, and he goes to  $\blacktriangle$  and wins, or he has already lost.

– If  $v = \blacktriangledown, \blacktriangledown_1, q_f$  or  $\blacktriangle$ , then the proof is immediate.

Therefore, the strategy profile  $\bar{\sigma}$  is an SPE, that simulates the run of the machine  $\mathcal{K}$ . That run terminates, hence the play  $\langle \bar{\sigma} \rangle$  reaches the vertex  $q_f$ , and is lost by player  $C_2$ .

Thus, the halting problem of two-counter machines reduces to the subgame-perfect universal threshold problem in energy games with two-players, which is therefore undecidable. That same problem reduces, by adding a Leader controlling no vertex, to the deterministic subgame-perfect rational verification problem in energy games where Leader plays against two players. Consequently, that problem is itself undecidable.  $\square$

## N Proof of Proposition 2

**Proposition 2.** *In the energy game presented in Figure 13, there exists an SPE that makes player  $\square$  lose, but no finite memory SPE can achieve that result.*

*Proof.* Consider the strategy profile  $\bar{\sigma}$  defined by  $\langle \bar{\sigma} \rangle = acdde^\omega$ , by  $\langle \bar{\sigma}_{\uparrow hca} \rangle = abd^{\text{EL}\circ(hcabd)}e^\omega$  for every history  $hca$ , by  $\langle \bar{\sigma}_{\uparrow hba} \rangle = acd^{\text{EL}\circ(hbacd)}e^\omega$  for every history  $hba$ , and by  $\langle \bar{\sigma}_{\uparrow hd} \rangle = d^{\text{EL}\circ(hd)}e^\omega$  for every history  $hd$ .

Intuitively: in every subgame, player  $\circ$  makes player  $\square$  and player  $\diamond$  lose. But to do so, she needs one of those players to cooperate with her: for example, in the main subgame  $\mathcal{G}_{\uparrow a}$ , she wants to make player  $\square$  lose, and to do so, she traverses the vertex  $c$  to go to the vertex  $d$ . But then, player  $\diamond$  may deviate, and go back to the vertex  $a$ . Then, player  $\diamond$  has to be punished: and to do so, player  $\circ$  must go to the vertex  $d$  through the vertex  $b$ , with player  $\square$ 's cooperation. . . and so on. Once the vertex  $d$  is reached (which will eventually be

the case in every subgame), player  $\circ$ 's energy level is equal to player  $\square$ 's and player  $\diamond$ 's one, plus 1. Thus, to make those players lose without losing herself, player  $\circ$  loops on the vertex  $d$  exactly the right number of times, before going to the vertex  $e$ .

Thus, the strategy profile  $\bar{\sigma}$  is an SPE in which player  $\square$  loses — but it is not a finite memory SPE. Let now  $\bar{\tau}$  be a finite memory SPE in  $\mathcal{G}_{\uparrow a}$ , compatible with a deterministic Mealy machine  $\mathcal{M}$ , and let us assume that  $\mu_{\square}(\langle \bar{\tau} \rangle) = 0$ . Since, by hypothesis, we have  $\mu_{\square}(\langle \bar{\tau} \rangle) = 0$  (and therefore  $\mu_{\diamond}(\langle \bar{\tau} \rangle) = 0$ , since players  $\square$  and  $\diamond$  always receive the same rewards), we also have, by induction and because  $\bar{\tau}$  is an SPE, the equality  $\mu_{\square}(\langle \bar{\tau}_{\uparrow ha} \rangle) = \mu_{\diamond}(\langle \bar{\tau}_{\uparrow ha} \rangle) = 0$  for every history  $h$  that is compatible with  $\sigma_{\circ}$ .

Let now  $n$  be the number of states of the machine  $\mathcal{M}$ , and let us consider a history  $ha$  with  $|h| = 2n$  (and therefore  $\text{EL}_{\circ}(ha) = \text{EL}_{\square}(ha) = \text{EL}_{\diamond}(ha) = n$ ). By the previous proposition, we know that  $\mu_{\square}(\langle \bar{\tau}_{\uparrow ha} \rangle) = \mu_{\diamond}(\langle \bar{\tau}_{\uparrow ha} \rangle) = 0$ , i.e. that the play  $\langle \bar{\tau}_{\uparrow ha} \rangle$  reaches the vertex  $d$ , and takes the edge  $dd$  more than  $n$  times. Since the machine  $\mathcal{M}$  has only  $n$  states, it means that that play actually loops on the vertex  $d$  infinitely often, and is therefore also lost by player  $\circ$ . Then, player  $\circ$  has a profitable deviation in that subgame, by going to the vertex  $e$ : contradiction.

There exists an SPE that makes player  $\square$  lose in that game, but no finite-memory one.  $\square$

## O Proof of Theorem 15

**Theorem 15.** *In discounted-sum games, the Nash-checking and the subgame-perfect checking problems, deterministic or not, can be decided in polynomial time.*

*Proof.* By Corollary 1, those four problems reduce to the privilege problem.

Let  $\mathcal{G}_{\uparrow v_0}$  be a discounted-sum game. Let  $r$  be the reward function defined by  $r(uv) = r_{\mathbb{E}}(uv) - r_{\mathbb{A}}(uv)$  for each edge  $uv$ . Then, a play  $\pi$  in  $\mathcal{G}_{\uparrow v_0}$  satisfies  $\mu_{\mathbb{E}}(\pi) > \mu_{\mathbb{A}}(\pi)$  if and only if it satisfies  $\text{DS}_r^\lambda(\pi) > 0$ .

If such a play exists, then there exists one that has the form  $hc^\omega$ , with  $|h|, |c| \leq n$ , where  $n$  is the number of vertices in  $\mathcal{G}$ . Indeed, let  $\pi$  be a play with  $\text{DS}_r^\lambda(\pi) > 0$ . Let  $k$  be the smaller index such that the vertex  $\pi_k$  appears again in  $\pi_{>k}$ , and let  $\ell$  be the index of the second occurrence of  $\pi_k$  along  $\pi$ . If we have  $\text{DS}_r^\lambda(\pi_{\leq k}(\pi_k \dots \pi_\ell)^\omega) > 0$ , then we can take  $h = \pi_{\leq k}$  and  $c = \pi_{k+1} \dots \pi_\ell$ . Otherwise, we can remove the sequence of  $\pi_k \dots \pi_\ell$  and start again with the play  $\pi' = \pi_0 \dots \pi_k \pi_{\ell+1} \dots$ . The procedure is necessarily finite since  $\text{DS}_r^\lambda(\pi) > 0$ .

Therefore, such a play exists if and only if there exists a vertex  $v$  that can be reached from  $v_0$  in  $k \leq n$  steps with discounted sum  $x$ , and that can be reached from itself in  $\ell \leq n$  steps with discounted sum  $y$ , with  $x$  and  $y$  such that:

$$x + \frac{y\lambda^k}{1 - \lambda^\ell} > 0.$$

The existence of such a vertex can be checked in polynomial time by Bellman-Ford's algorithm.  $\square$

## P Proof of Theorem 17

**Theorem 17.** *In discounted-sum games, the Nash rational and the subgame-perfect rational verification problems, deterministic or not, are recursively enumerable.*



*Proof.* We present here a semi-algorithm that recognizes positive instances of the subgame-perfect universal (resp. Nash universal) threshold problem. The result will follow by Corollary 2.

Given a discounted-sum game  $\mathcal{G}_{\uparrow v_0}$  with discount factor  $\lambda$ , a player  $i$  and a threshold  $t$ , we give an algorithm that stops if and only if there exists no SPE (resp. NE)  $\bar{\sigma}$  in  $\mathcal{G}_{\uparrow v_0}$  with  $\mu_i(\langle \bar{\sigma} \rangle) < t$ . But first, let us give a preliminary result that will justify the correctness of our result.

- *Preliminary result:* For every play  $\pi$ , each player  $j$  and every index  $n$ , we have:

$$\mu_j(\pi) \in \left[ \text{DS}_j(\pi_{\leq n}) - M\lambda^n, \text{DS}_j(\pi_{\leq n}) + M\lambda^n \right],$$

where:

$$M = \frac{1}{1 - \lambda} \max_{uv \in E} \max_{j \in \Pi} |r_j(uv)|$$

is a bound on the payoff (in absolute value) of every player.

Let us proceed by induction on  $n$ . When  $n = 0$ , for every play  $\pi$  starting from  $v_0$  and each player  $j$ , we have:

$$\begin{aligned} \mu_j(\pi) &= \sum_k r_j(\pi_k \pi_{k+1}) \lambda^k \\ &\leq \sum_k \lambda^k \max_{uv \in E} \max_{j \in \Pi} |r_j(uv)| = M \end{aligned}$$

and symmetrically  $\mu_j(\pi) \geq -M$ , which is the desired interval since  $\text{DS}_i(\pi_0) = 0$ .

Now, if the desired property is true for  $n \geq 0$ , let us prove that it is true for  $n+1$ . Let  $v\pi$  be a play. By induction hypothesis, we have  $\mu_j(\pi) \in \left[ \text{DS}_j(\pi_{\leq n}) - M\lambda^n, \text{DS}_j(\pi_{\leq n}) + M\lambda^n \right]$ . Hence:

$$\begin{aligned} \mu_j(v\pi) &= r_j(v\pi_0) + \sum_k r_j(\pi_k \pi_{k+1}) \lambda^{k+1} \\ &= r_j(v\pi_0) + \lambda \mu_j(\pi) \\ &\in \left[ r_j(v\pi_0) + \lambda \text{DS}_j(\pi_{\leq n}) - M\lambda^{n+1}, \right. \\ &\quad \left. r_j(v\pi_0) + \lambda \text{DS}_j(\pi_{\leq n}) + M\lambda^{n+1} \right] \\ &= \left[ \text{DS}_j(v_0 \pi_{\leq n}) - M\lambda^{n+1}, \text{DS}_j(v_0 \pi_{\leq n}) + M\lambda^{n+1} \right], \end{aligned}$$

as desired.

- *Algorithm.*

Let  $(h^{(n)})_{n \in \mathbb{N}}$  be a recursive enumeration of the nonempty histories in  $\mathcal{G}_{\uparrow v_0}$  by increasing order of lengths (we can, for example, order histories of the same length with the lexicographic order induced by some arbitrary order on vertices).

Now, let  $T$  be the infinite tree whose nodes of depth  $n+1$  are all possible  $n$ -uples:

$$\left( \bar{\sigma}(h^{(0)}), \dots, \bar{\sigma}(h^{(n)}) \right),$$

and where the children of the node  $\left( \bar{\sigma}(h^{(0)}), \dots, \bar{\sigma}(h^{(n)}) \right)$  are the nodes of the form:

$$\left( \bar{\sigma}(h^{(0)}), \dots, \bar{\sigma}(h^{(n)}), \bar{\sigma}(h^{(n+1)}) \right).$$

Thus, every node partially defines a complete strategy profile  $\bar{\sigma}$ , and every infinite branch entirely defines it — and every complete strategy profile is defined by an infinite branch.

A node  $(\bar{\sigma}(h^{(0)}), \dots, \bar{\sigma}(h^{(n)}))$  is called *subgame-irrational* if there exist two indices  $\ell, m \leq n$ , with  $|h^{(\ell)}| = |h^{(m)}| = p$ , an index  $k \leq p$  and a player  $j$  such that:

- we have  $h_{\leq k}^{(\ell)} = h_{\leq k}^{(m)}$ ;
- the history  $h_{\geq k}^{(\ell)}$  is compatible with the strategy profile  $\bar{\sigma}_{\upharpoonright h_{\leq k}^{(\ell)}}$ , as partially defined there;
- the history  $h_{\geq k}^{(m)}$  is compatible with the strategy profile  $\bar{\sigma}_{-j \upharpoonright h_{\leq k}^{(m)}}$ ;
- and finally, we have:

$$DS_j \left( h_{\geq k}^{(m)} \right) - DS_j \left( h_{\geq k}^{(\ell)} \right) > 2M\lambda^{p-k-1}.$$

The same node is called *Nash-irrational* if, moreover, the history  $h_{\leq k}^{(\ell)}$  is compatible with  $\bar{\sigma}$ , as defined so far in the branch.

The same node is called *off-topic* if we have:

$$DS_i(h) > t - M\lambda^{|h|-1},$$

where  $h$  is the longest history that is compatible with  $\bar{\sigma}$  as defined so far.

Our algorithm consists in constructing the tree  $T'$ , obtained from the tree  $T$  by cutting every branch after the first subgame-irrational (resp. irrational) or off-topic node, and terminating once that construction is finished.

- *Correctness.*

Let us consider a complete strategy profile  $\bar{\sigma}$ . Using the preliminary result, we know that we have  $\mu_i(\langle \bar{\sigma} \rangle) \leq t$  if and only if the corresponding branch contains no off-topic node.

Let us now assume that that branch contains a subgame-irrational (resp. Nash-irrational) node  $(\bar{\sigma}(h^{(0)}), \dots, \bar{\sigma}(h^{(n)}))$ . Let us use the notations  $k, \ell, m, p$  and  $j$  from the definition of subgame-irrationality (resp. Nash-irrationality). Let us define  $\pi = \langle \bar{\sigma}_{\upharpoonright h_{\leq k}^{(\ell)}} \rangle$ : note that the history  $h_{\geq k}^{(\ell)}$  is a prefix of length  $p - k$  of the play  $\pi$ . Similarly, let us extend the history  $h_{\geq k}^{(m)}$  into a play  $\pi'$ , compatible with the strategy profile  $\bar{\sigma}_{-j \upharpoonright h_{\leq k}^{(m)}}$ . By the preliminary result, the inequality:

$$DS_j \left( h_{\geq k}^{(m)} \right) - DS_j \left( h_{\geq k}^{(\ell)} \right) > 2M\lambda^{p-k-1}$$

implies  $\mu_j(\pi') > \mu_j(\pi)$ , and therefore the strategy profile  $\bar{\sigma}$  is not an SPE (resp. not an NE, since the history  $h_{\leq k}^{(\ell)}$  is compatible with  $\bar{\sigma}$ ).

Conversely, if  $\bar{\sigma}$  is not an SPE (resp. NE), then there exists a history  $h\nu$  (resp. a history  $h\nu$  compatible with  $\bar{\sigma}$ ), a player  $j$  and a strategy  $\sigma'_j$  such that we have:

$$\mu_j(\langle \bar{\sigma}_{\upharpoonright h\nu} \rangle) < \mu_j(\langle \bar{\sigma}_{-j \upharpoonright h\nu}, \sigma'_{j \upharpoonright h\nu} \rangle).$$

Then, let  $\pi = \langle \bar{\sigma}_{\uparrow hv} \rangle$ , and let  $\pi' = \langle \bar{\sigma}_{-j \uparrow hv}, \sigma'_{j \uparrow hv} \rangle$ : since  $\mu_j(\pi) < \mu_j(\pi')$ , by the preliminary result, there exists an index  $q$  such that:

$$\text{DS}_j(\pi_{\leq q}) + M\lambda^q < \text{DS}_j(\pi'_{\leq q}) - M\lambda^q.$$

Let now  $\ell$  and  $m$  be the indices such that  $h^{(\ell)} = h\pi_{\leq q}$ , and  $h^{(m)} = h\pi'_{\leq q}$ . Let  $p = |h^{(\ell)}| = |h^{(m)}|$ , and let  $k = |h|$ . Then, we have  $\text{DS}_j(h_{\geq k}^{(m)}) - \text{DS}_j(h_{\geq k}^{(\ell)}) > 2M\lambda^{p-k-1}$ : along the branch corresponding to  $\bar{\sigma}$ , the node of depth  $\max\{\ell, m\}$  is subgame-irrational (resp. Nash-irrational).

As a consequence, the game  $\mathcal{G}_{\uparrow v_0}$ , the player  $i$  and the threshold  $t$  form a positive instance of the subgame-perfect universal (resp. Nash universal) threshold problem if and only if every branch of the tree  $T$  contains either a subgame-irrational (resp. a Nash-irrational) or an off-topic node; i.e., by Kőnig's Lemma, if and only if the tree  $T'$  is finite; i.e., if and only if our algorithm terminates.  $\square$