

Noncommutative Fibrations via Positive Maps and Bimodules

Edwin J. Beggs James E. Blake

Swansea University Department of Mathematics

Abstract

We construct a Leray-Serre spectral sequence for fibrations for de Rham cohomology on noncommutative algebras. The fibrations are bimodules with zero-curvature extendable bimodule connections satisfying an additional condition. By the KSGNS construction, completely positive maps between C*-algebras correspond to Hilbert C*-bimodules. We give examples of fibrations on group algebras and matrix algebras.

1 Introduction

In classical topology (see [18]), a locally trivial fibration is a map $\pi : E \rightarrow B$ where E is called the total space and B the base space. The fibre F of the fibration is identified with each $\pi^{-1}\{b\}$ in a continuous manner. A fibration π is called locally trivial if B has a cover by open sets such that $\pi^{-1}U \cong F \times U$ where π is projection to the second coordinate and \cong means homeomorphism. The homeomorphisms $\pi^{-1}U \cong F \times U$ and $\pi^{-1}V \cong F \times V$ in the cover are patched together on the intersection $U \cap W$ by transition functions $\pi^{-1}U \supset F \times (U \cap W) \xrightarrow{\phi_{UV}} F \times (U \cap W) \subset \pi^{-1}W$ which are homeomorphisms and obey $\pi \circ \phi_{UV} = \pi$. Given a fibration, there is a spectral sequence called the Leray-Serre spectral sequence with second page entry (p, q) given by $H^p(B, H^q(F))$ which converges to $H^{p+q}(E)$. We give more background on spectral sequences and their convergence later. For a noncommutative version of fibrations where spaces are replaced by algebras with differential calculi, take B to be an algebra of functions on a hypothetical base space of a fibration, and A as the algebra corresponding to the total space. Since switching from spaces to algebras reverses the direction of functions, a noncommutative fibration now goes from B to A . In [2] a definition of such a noncommutative fibration is given, and its Serre spectral sequence is defined. Differential fibrations were later extended using sheaves in [5] as a class of differential graded algebra maps $B \rightarrow A$, and a generalisation of the Leray-Serre spectral sequence was constructed, which converges to the cohomology of A with coefficients in the bimodule.

In the following, we regard certain B - A bimodules equipped with a zero-curvature bimodule connection as morphisms and show they behave like differential fibrations, and construct from these a Leray-Serre spectral sequence converging to the cohomology of A with coefficients in a bimodule.

The KSGNS construction gives a correspondence between bimodules with an inner product and completely positive maps, and from this correspondence each bimodule differential fibration (when equipped with the additional data of an inner product and a choice of an element of the bimodule) gives rise to a completely positive map, which may or may not be an algebra map. Under certain additional conditions discussed later (the existence of a connection on the bimodule with a certain property), this positive map can be shown to be differentiable.

The existence of algebra maps between two given algebras is by no means guaranteed, so a definition of a differential fibration in terms of the more plentiful bimodules (or completely positive maps) allows for a wider range of examples. In order to get a full theory of fibrations and cofibrations corresponding to the topological theory, it is very possible that we will have to use the more general picture of completely positive maps rather than just algebra maps.

Our first example of a bimodule differential fibration is between group algebras $\mathbb{C}G \rightarrow \mathbb{C}X$ for a subgroup $G \subset X$. This happens to give a differentiable algebra map, and so could also have been calculated using existing theory.

Our second example is a bimodule differential fibration between matrix algebras $M_2(\mathbb{C}) \rightarrow M_3(\mathbb{C})$. The bimodule from this example gives a differentiable map which is completely positive but not an algebra map.

2 Background

2.1 Spectral Sequences

A spectral sequence (E_r, d_r) is a series of two-dimensional lattices E_r called pages with page r having entry $E_r^{p,q}$ in position $(p, q) \in \mathbb{Z}^2$ and differentials $d_r : E_r^{p,q} \rightarrow E_r^{p+r, q+1-r}$ satisfying $d_r^2 = 0$. Conventionally the p -axis is drawn horizontally and the q -axis is drawn vertically. In the case we consider, only the top-right quadrant $(p, q \geq 0)$ of page 0 is allowed to have nonzero entries. The differentials d_r on the r th page go to the right by r entries and down by $r - 1$. Seeing as the differentials square to zero, it is possible to take their cohomology. The $(r + 1)$ th page is defined as the cohomology of the r th page. Figure 1 is an image [17] illustrating what a spectral sequence looks like on pages $r = 0, 1, 2, 3$.

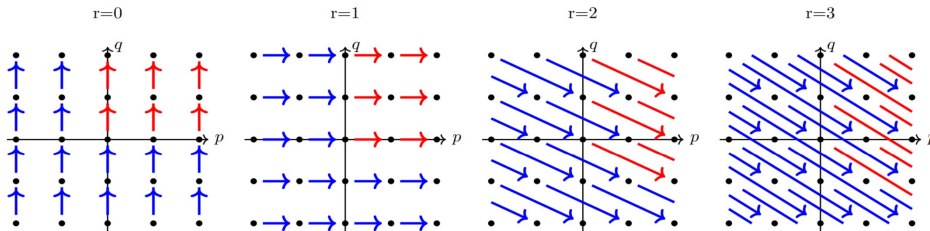

Figure 1: Illustration of successive pages of a spectral sequence [17]

A spectral sequence is said to converge if there is some fixed page after which all subsequent pages are the same. After taking cohomology no longer changes a spectral sequence,

we say that the sequence has stabilised, and denote position (p, q) on the stable pages as $E_\infty^{p,q}$.

The spectral sequence used in this paper is a variant of the Leray-Serre spectral sequence, which arises from a filtration.

Definition 2.1. For a cochain complex C^n of vector spaces with linear differential $d : C^n \rightarrow C^{n+1}$ satisfying $d^2 = 0$, we say that the sequence of subspaces $F^m C \subset C$ for $m \geq 0$ are a decreasing filtration of C if the following three conditions are satisfied.

1. $dF^m C \subset F^m C$ for all $m \geq 0$.
2. $F^{m+1} C \subset F^m C$ for all $m \geq 0$.
3. $F^0 C = C$ and $F^m C^n := F^m C \cap C^n = \{0\}$ for all $m > n$.

Given such a filtration, [11] says that the spectral sequence with first page $E_1^{p,q} = H^{p+q}(\frac{F^p C}{F^{p+1} C})$ converges to $H^*(C, d)$ in the sense that $H^k(C, d) = \bigoplus_{p+q=k} E_\infty^{p,q}$. This can

be read off the stabilised sequence as the direct sum along the north-west to south-east diagonals.

2.2 Bimodules and Connections

The idea of a bimodule connection was introduced in [7], [8] and [16] and used in [9], [12]. It was used to construct connections on tensor products in [6].

Definition 2.2. A calculus on an (associative) algebra A is an A -bimodule Ω_A^1 satisfying $\Omega_A^1 = \text{span}\{a'da \mid a, a' \in A\}$ for some linear map $d : A \rightarrow \Omega_A^1$ with $d(ab) = adb + da.b$.

We call the calculus connected if $\ker d = \mathbb{K}.1$, where \mathbb{K} is the field of scalars of A (in all our examples $\mathbb{K} = \mathbb{C}$). There is a linear map $\wedge : \Omega^p \otimes \Omega^q \rightarrow \Omega^{p+q}$, and every element of the higher calculi Ω^n is a wedge product of elements of Ω^1 . The map d , called an exterior derivative, can be extended to $d : \Omega^n \rightarrow \Omega^{n+1}$ by $d(\xi \wedge \eta) = d\xi \wedge \eta + (-1)^{|\xi|} \xi \wedge d\eta$ and satisfies $d^2 = 0$.

Definition 2.3. Suppose B and A are algebras with calculi Ω_B^1 and Ω_A^1 respectively. A right bimodule connection (∇_E, σ_E) on a B - A bimodule E consists of two components. Firstly, a linear map $\nabla_E : E \rightarrow E \otimes_A \Omega_A^1$ called a right connection, satisfying $\nabla_E(e.b) = \nabla_E(e).b + e \otimes db$ for $e \in E, b \in B$. Secondly, a linear bimodule map $\sigma_E : \Omega_B^1 \otimes_B E \rightarrow E \otimes_A \Omega_A^1$ called a generalised braiding, satisfying $\nabla_E(be) = \sigma_E(db \otimes e) + b\nabla_E(e)$ for $e \in E, b \in B$.

A right connection ∇_E is called flat if its curvature $R_E = (\text{id} \otimes d + \nabla_E \wedge \text{id})\nabla_E : E \rightarrow E \otimes_A \Omega_A^2$ is zero. The curvature R_E is always a right module map.

The bimodule map σ_E is said to be extendable [3] to higher calculi if it extends to a map $\sigma_E : \Omega_B^n \otimes_B E \rightarrow E \otimes_A \Omega_A^n$ by the formula $\sigma_E(\xi \wedge \eta \otimes e) = (\sigma_E \wedge \text{id})(\xi \otimes \sigma_E(\eta \otimes e))$. Extendability can also be written as $(\text{id} \otimes \wedge)(\sigma_E \otimes \text{id})(\text{id} \otimes \sigma_E) = \sigma_E(\wedge \otimes \text{id})$.

Definition 2.4. [3] Every first order calculus Ω^1 on A has a 'maximal prolongation' Ω_{max} to an exterior algebra, where for every relation $\sum_i a_i \cdot db_i = \sum_j dr_j \cdot s_j$ in Ω^1 for $a_i, b_i, r_j, s_j \in A$ we impose the relation $\sum_i da_i \wedge db_i = \sum_j dr_j \wedge ds_j$ in Ω_{max}^2 . This is extended to higher forms, but no new relations are added.

Proposition 2.5. [3] If A and B are equipped with maximal prolongation calculi for their higher calculi and if the curvature R_E is also a left module map, then extendability of σ_E is automatic.

There are a few results which are proven in [3] for left connections but which we need to prove now for right connections, and the following is one such result.

Lemma 2.6. Let E be a B - A bimodule with extendable right bimodule connection (∇_E, σ_E) . The connection ∇_E extends to higher calculi as

$$\nabla_E^{[n]} = \text{id} \otimes d + \nabla_E \wedge \text{id} : E \otimes_A \Omega_A^n \rightarrow E \otimes_A \Omega_A^{n+1} \quad (1)$$

Proof. To show this is well-defined over the tensor-product \otimes_A , we check that $\nabla_E^{[n]}(ea \otimes \eta) = \nabla_E^{[n]}(e \otimes a\eta)$. We then have the following two equations.

$$\begin{aligned} (\text{id} \otimes d)(ea \otimes \eta) + (\nabla_E \wedge \text{id})(ea \otimes \eta) &= ea \otimes d\eta + \nabla_E(e)a \wedge \eta + e \otimes da \wedge \eta, \\ (\text{id} \otimes d)(e \otimes a\eta) + (\nabla_E \wedge \text{id})(e \otimes a\eta) &= e \otimes da \wedge \eta + e \otimes a \wedge d\eta + \nabla_E(e) \wedge a\eta \end{aligned}$$

As $ea \otimes d\eta = e \otimes a \wedge d\eta$ and $\nabla_E(e) \wedge a\eta = \nabla_E(e)a \wedge \eta$, we see that $\nabla_E^{[n]}(ea \otimes \eta) = \nabla_E^{[n]}(e \otimes a\eta)$, giving the required result. \square

Lemma 2.7. Let E be a B - A bimodule with extendable right bimodule connection (∇_E, σ_E) . Then $\nabla_E^{[n+1]} \circ \nabla_E^{[n]} = R_E \wedge \text{id} : E \otimes_A \Omega_A^n \rightarrow E \otimes_A \Omega_A^{n+2}$, where $R_E = (\text{id} \otimes d + \nabla_E \wedge \text{id})\nabla_E : E \rightarrow E \otimes_A \Omega_A^2$ is the curvature of ∇_E .

Proof. Writing out $\nabla_E^{[n+1]} \circ \nabla_E^{[n]}$ in string diagrams and then expanding $d \wedge$ and using associativity of \wedge gives Figure 2, which gives the desired result. \square

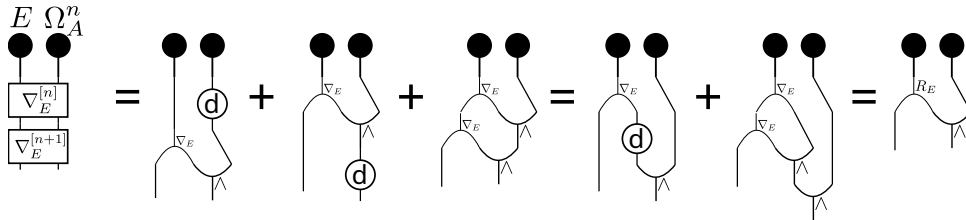

Figure 2: Diagrammatic proof that $\nabla_E^{[n+1]} \circ \nabla_E^{[n]} = R_E \wedge \text{id}$

The following lemma is a mirrored version of the one on page 304 of [3].

Lemma 2.8. Let E be a B - A bimodule with extendable right bimodule connection (∇_E, σ_E) whose curvature R_E is a left module map. Then

$$\nabla_E^{[n]} \circ \sigma_E = \sigma_E(d \otimes \text{id}) + (-1)^n(\sigma_E \wedge \text{id})(\text{id} \otimes \nabla_E) : \Omega_B^n \otimes_B E \rightarrow E \otimes_A \Omega_A^{n+1}. \quad (2)$$

Proof. Recall that the curvature $R_E = \nabla_E^{[1]} \circ \nabla_E = (\text{id} \otimes d + \nabla_E \wedge \text{id})\nabla_E$ is always a right module map.

(1) First we show the $n = 1$ case. For $b \in B$, $e \in E$, if we write $\nabla_E(e) = f \otimes \xi$, then:

$$\begin{aligned} R_E(be) &= (\text{id} \otimes d + \nabla_E \wedge \text{id})\nabla_E(be) = (\text{id} \otimes d + \nabla_E \wedge \text{id})(bf \otimes \xi + \sigma_E(db \otimes e)) \\ &= \nabla_E(bf) \wedge \xi + bf \otimes d\xi + \nabla_E^{[1]}\sigma_E(db \otimes e) \\ &= b.\nabla_E(f) \wedge \xi + \sigma_E(db \otimes f) \wedge \xi + bf \otimes d\xi + \nabla_E^{[1]}\sigma_E(db \otimes e) \\ &= b.R_E(e) + \sigma_E(db \otimes f) \wedge \xi + \nabla_E^{[1]}\sigma_E(db \otimes e) \end{aligned}$$

However, the fact that R_E is a left module map means this reduces to:

$$0 = \sigma_E(db \otimes f) \wedge \xi + \nabla_E^{[1]}\sigma_E(db \otimes e)$$

We use this to calculate for a general 1-form $\eta = cdb$ (summation omitted):

$$\begin{aligned} \sigma_E(cdb \otimes f) \wedge \xi + \nabla_E^{[1]}\sigma_E(cdb \otimes e) \wedge \xi &= c\sigma_E(db \otimes f) + \nabla_E^{[1]}(c\sigma_E(db \otimes e)) \\ &= c(\sigma_E(db \otimes f) \wedge \xi + \nabla_E^{[1]}\sigma_E(db \otimes e)) + (\sigma_E \wedge \text{id})(dc \otimes \sigma_E(db \otimes e)) \\ &= 0 + (\sigma_E \wedge \text{id})(dc \otimes \sigma_E(db \otimes e)) = \sigma_E(dc \wedge db \otimes e) = \sigma_E(d(cdb) \otimes e) \end{aligned}$$

where we have used that $0 = \sigma_E(db \otimes f) + \nabla_E^{[1]}\sigma_E(db \otimes e)$ and then the extendability of σ_E . Re-arranging this, we get:

$$\begin{aligned} \nabla_E^{[1]}\sigma_E(\eta \otimes e) &= \sigma_E(d\eta \otimes e) - \sigma_E(\eta \otimes f) \wedge \xi \\ &= \sigma_E(d \otimes \text{id})(\eta \otimes e) + (-1)^1(\sigma_E \wedge \text{id})(\text{id} \otimes \nabla_E)(\eta \otimes e) \end{aligned}$$

This shows the $\nabla_E^{[1]}\sigma_E$ case.

(2) Next we suppose the formula holds for $\nabla_E^{[n]}\sigma$ and use induction to show it for $n + 1$. Suppose $\eta, \xi \in \Omega_B^1$ and $e \in E$. Expressing $\nabla_E^{[n+1]}\sigma_E(\eta \wedge \xi \otimes e)$ in string diagrams in Figure 3, we use extendability of σ_E , then the formula for $\nabla_E^{[n+1]}$, then the Leibniz rule on \wedge , then recognise the formula for $\nabla_E^{[n]}$, then use the induction assumption, then use associativity of \wedge , then recognise the formula for $\nabla_E^{[n]}$, then use the induction assumption again, then finally we re-arrange using the Leibniz rule for \wedge and associativity of \wedge and extendability of σ . Hence $\nabla_E^{[n+1]} \circ \sigma_E = \sigma_E(d \otimes \text{id}) + (-1)^n(\sigma_E \wedge \text{id})(\text{id} \otimes \nabla_E)$. \square

In particular, if $R_E = 0$ then the composition $\nabla_E^{[n+1]} \circ \nabla_E^{[n]} = R_E \wedge \text{id}$ vanishes, making the flat connection ∇_E a cochain differential. We use this later to give a filtration.

2.3 Positive Maps and the KSGNS Construction

Recall that a positive element of a C^* -algebra A is one of the form a^*a for some $a \in A$. A linear map $\phi : B \rightarrow A$ between C^* -algebras is called positive if it sends positive elements to positive elements. It is called completely positive if all maps $M_n(B) \rightarrow M_n(A)$ for all $n \geq 2$ given by applying ϕ to each entry, e.g. $\begin{pmatrix} b_1 & b_2 \\ b_3 & b_4 \end{pmatrix} \rightarrow \begin{pmatrix} \phi(b_1) & \phi(b_2) \\ \phi(b_3) & \phi(b_4) \end{pmatrix}$, are also positive. Every $*$ -algebra map is completely positive, and so are all positive linear functions $B \rightarrow \mathbb{C}$. The KSGNS theorem (see [11] for reference) gives a correspondence between bimodules and completely positive maps. Let A and B be C^* -algebras, and E a Hilbert B - A

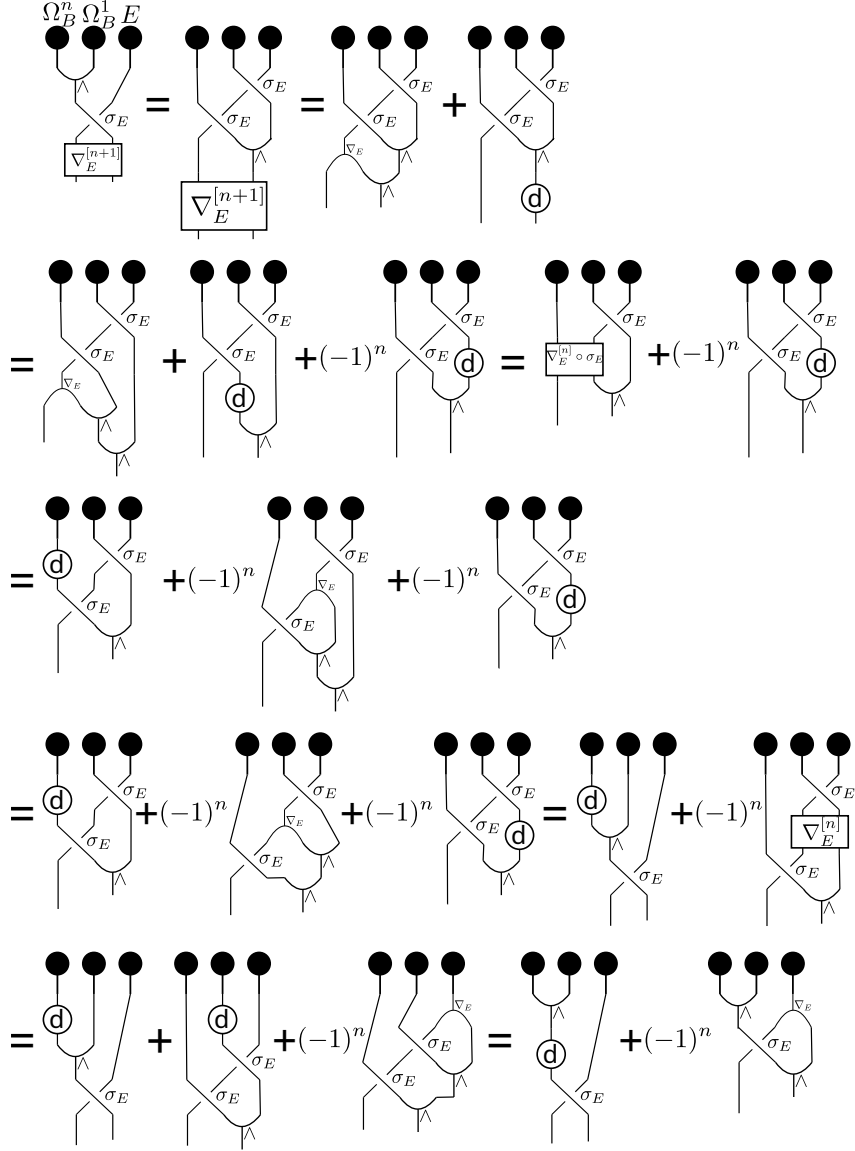

Figure 3: Induction step in proof that $\nabla_E^{[n+1]} \circ \sigma_E = \sigma_E(d \otimes \text{id}) + (-1)^n(\sigma_E \wedge \text{id})(\text{id} \otimes \nabla_E)$

bimodule with inner product $\langle \cdot, \cdot \rangle : \overline{E} \otimes_B E \rightarrow A$. We write here \overline{E} for the conjugate module of E as defined as in [4], which has elements $\overline{e} \in \overline{E}$ for each $e \in E$ and satisfies $\lambda \overline{e} = \overline{\lambda^* e}$ for scalars $\lambda \in \mathbb{C}$, and has A - B bimodule structure given by $a \overline{e} = \overline{ea^*}$ and $\overline{e} b = \overline{b^* e}$ for $a \in A$, $b \in B$, $e \in E$.

A right connection ∇_E is said to preserve an inner product $\langle \cdot, \cdot \rangle : \overline{E} \otimes_B E \rightarrow A$ on E if $d \langle \overline{e}_1, e_2 \rangle = \langle \overline{e}_1, \nabla_E(e_2)_{(1)} \rangle \nabla_E(e_2)_{(2)} + \nabla_E(e_1)_{(2)}^* \langle \nabla_E(e_1)_{(1)}, e_2 \rangle$ for all $e_1, e_2 \in E$, using a form of Sweedler notation $\nabla_E(e) = \sum \nabla_E(e)_{(1)} \otimes \nabla_E(e)_{(2)}$ for tensor products. Given a right connection ∇_E on E , there is a left connection $\nabla_{\overline{E}}$ on \overline{E} given by $\nabla_{\overline{E}}(\overline{e}) = \nabla_E(e)_{(2)}^* \otimes \overline{\nabla_E(e)_{(1)}}$. We use this notation to write the metric preservation in string diagrams in Figure 4.

By one side of the KSGNS theorem, every map $\phi : B \rightarrow A$ of the form $\phi(b) = \langle \overline{e}, be \rangle$ for some $e \in E$ is completely positive. By the other side of the KSGNS theorem, for a completely positive map $\phi : B \rightarrow A$ between unital C^* -algebras, there is a Hilbert B - A

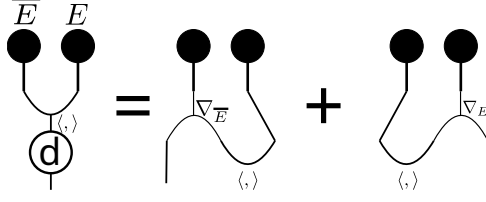

Figure 4: Illustration of the metric preservation equation

bimodule E and an $e_0 \in E$ such that $\phi(b) = \langle \bar{e}_0, be_0 \rangle$. The KSGNS construction gives a process to construct this bimodule, whereby we take the B - A bimodule $B \otimes A$ with actions given by multiplication, equipped with inner product $\langle \cdot, \cdot \rangle : \overline{B \otimes A} \otimes_B B \otimes A \rightarrow A$ given by $\langle \overline{b \otimes a}, b' \otimes a' \rangle = a^* \phi(b^* b') a'$, then quotient by all zero-length elements with respect to this inner product, then take a completion.

Proposition 2.9. [3] *Suppose that A is a unital dense $*$ -subalgebra of a C^* -algebra, (E, ∇_E, σ_E) a right B - A bimodule connection which is extendable with curvature R_E a bimodule map and $\langle \cdot, \cdot \rangle : \overline{E} \otimes_B E \rightarrow A$ a semi-inner product A -module structure preserved by ∇_E . If $e \in E$ obeys $\nabla_E(e) = 0$ then $\phi : \Omega_B \rightarrow \Omega_A$, $\phi(\xi) = (\langle \cdot, \cdot \rangle \otimes \text{id})(\overline{E} \otimes \sigma_E(\xi \otimes e))$ is a cochain map, i.e. $d \circ \phi = \phi \circ d$.*

3 Theory: Fibrations (Right-handed Version)

In [5] there is a form of differential fibration defined as follows. If we have an algebra map $\pi : B \rightarrow A$ which extends to a map of differential graded algebras, then differential forms of degree p in the base and q in the fibre can be defined as a quotient $\frac{\pi^* \Omega_B^p \wedge \Omega_A^q}{\pi^* \Omega_B^{p+1} \wedge \Omega_A^{q-1}}$. In this paper we take a similar approach, but representing such forms by a quotient that doesn't require an algebra map. This comes at the cost of now needing a bimodule with a bimodule connection, but since Hilbert C^* -bimodules with inner products correspond via the KSGNS construction to completely positive maps, and every $*$ -algebra map is also a completely positive map, this constitutes a generalisation. We start by defining the filtration.

Proposition 3.1. *Let E be a B - A bimodule with extendable zero-curvature right bimodule connection (∇_E, σ_E) . For $m \leq n$, the cochain complex $C^n = E \otimes_A \Omega_A^n$ with differential $d_C := \nabla_E^{[n]} : C^n \rightarrow C^{n+1}$ gives the following filtration.*

$$F^m C^n = \text{im}(\sigma_E \wedge \text{id}) : \Omega_B^m \otimes_B E \otimes_A \Omega_A^{n-m} \rightarrow E \otimes_A \Omega_A^n \quad (3)$$

Proof. (1) *The first property we need for a filtration is $d_C F^m C \subset F^m C$ for all $m \geq 0$. This means showing $\nabla_E^{[n]} F^m(E \otimes_A \Omega_A^n) \subset \bigoplus_{n' \geq 0} F^m(E \otimes_A \Omega_A^{n'})$.*

In the calculations in Figure 5 we start with $\nabla_E^{[n]}(\sigma_E \wedge \text{id})$, then use the fact that $\nabla_E^{[n]} = \text{id} \otimes d + \nabla_E \wedge \text{id}$, then use associativity of \wedge and expand $d \wedge$, then recognise the formula for $\nabla_E^{[m]}$, then use the formula $\nabla_E^{[m]} \circ \sigma_E = \sigma_E(d \otimes \text{id}) + (-1)^m(\sigma_E \wedge \text{id})(\text{id} \otimes \nabla_E)$ we showed earlier, then use associativity of \wedge , then recognise the formula for $\nabla_E^{[n-m]}$.

This is in $F^{m+1} C^{n+1} + F^m C^{m+1}$. However, as we will show in the next step, the filtration is decreasing, so as required, it is contained in $F^m C$.

(2) The second property we need for a filtration is $F^{m+1}C \subset F^m C$ for all $m \geq 0$. In a differential calculus (as opposed to a more general differential graded algebra), elements of the higher calculi can all be decomposed into wedge products of elements of Ω^1 , and so $\Omega_B^{m+1} = \Omega_B^m \wedge \Omega_B^1$. Let $\xi \in \Omega_B^m$, $\eta \in \Omega_B^1$, $e \in E$, $\kappa \in \Omega_A^{n-m-1}$. Then $\xi \wedge \eta \otimes e \otimes \kappa \in \Omega_B^{m+1} \otimes_B E \otimes \Omega_A^{n-m-1}$, so the map $\sigma_E \wedge \text{id}$ takes it to $E \otimes_A \Omega_A^n$, and the image of all such things is $F^{m+1}C^n$. We have the string diagram Figure 6 for $(\text{id} \otimes \wedge)(\sigma \otimes \text{id})(\wedge \otimes \text{id} \otimes \text{id})(\xi \otimes \eta \otimes e \otimes \kappa)$, where we use that σ_E is extendable and that \wedge is associative. This shows that $F^{m+1}C^n$ lies in $\text{im}(\sigma_E \wedge \text{id}) : \Omega_B^m \otimes_B E \otimes_A \Omega_A^{n-m} \rightarrow E \otimes_A \Omega_A^n$, i.e. in $F^m C^n$, and hence that the filtration is decreasing in m .

(3) The third property we need is $F^0 C = C$.

$$F^0 C^n = \text{im}(\sigma_E \wedge \text{id}) : B \otimes_B E \otimes_A \Omega_A^n \rightarrow E \otimes_A \Omega_A^n$$

Recalling that $\sigma_E(1 \otimes e) = e \otimes 1$ when $m = 0$, the set $F^0 C^n$ consists of elements $b.e \otimes \xi$, which gives all of C^n .

(4) The final property we need is $F^m C^n := F^m C \cap C^n = \{0\}$ for all $m > n$. This holds because for $m > n$, we have $\Omega^{n-m} = 0$, giving $F^m C^n = \text{im}(\sigma_E \wedge \text{id}) : 0 \rightarrow C^n$, which has zero intersection with C^n . \square

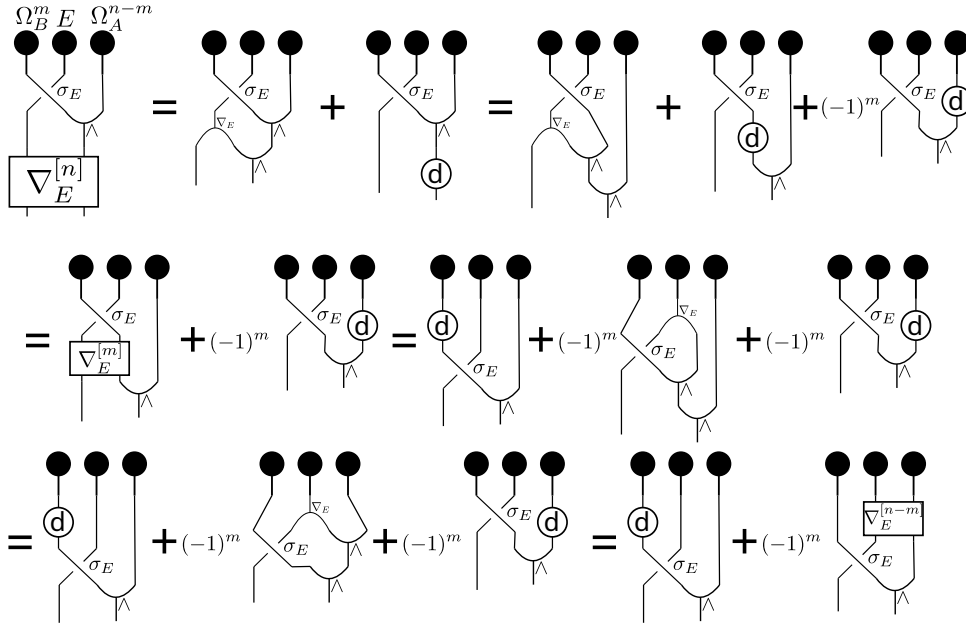

Figure 5: Proof that $d_C F^m C \subset F^m C$

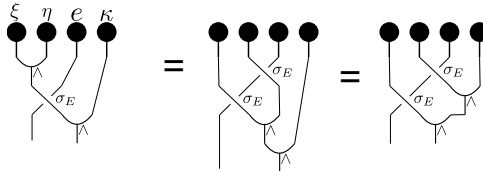

Figure 6: Proof the filtration is decreasing

Definition 3.2. Using the above filtration, we define differential forms with coefficients in E of degree p in the fibre and q in the base as the following quotient.

$$M_{p,q} := \frac{F^p C^{p+q}}{F^{p+1} C^{p+q}} = \frac{\sigma_E(\Omega_B^p \otimes_B E) \wedge \Omega_A^q}{\sigma_E(\Omega_B^{p+1} \otimes_B E) \wedge \Omega_A^{q-1}} \quad (4)$$

From these we denote forms with coefficients in E of degree q in the fibre only as follows.

$$N_q := M_{0,q} = \frac{C^q}{F^1 C^q} = \frac{E \otimes_A \Omega_A^q}{\sigma_E(\Omega_B^1 \otimes_B E) \wedge \Omega_A^{q-1}} \quad (5)$$

Proposition 3.3. Let E be a B - A bimodule with extendable zero-curvature right bimodule connection (∇_E, σ_E) , with $M_{p,q}$ and N_q as above. Then there is a well-defined surjective linear map

$$g : \Omega_B^p \otimes_B N_q \rightarrow M_{p,q}, \quad g(\xi \otimes [e \otimes \eta]) = [(\sigma_E \wedge \text{id})(\xi \otimes e \otimes \eta)]. \quad (6)$$

Proof. Surjectivity follows from the definition of the map, so we only need to show that g is well-defined on equivalence classes, i.e. that if $[e \otimes \eta] = 0$ then we also have $[(\sigma_E \wedge \text{id})(\xi \otimes e \otimes \eta)] = 0$. By definition, we have $[e \otimes \eta] = 0 \in N_q$ if and only if $e \otimes \eta = (\sigma_E \wedge \text{id})(\xi' \otimes f \otimes \eta')$ for some $\xi' \in \Omega_B^1$, $f \in E$, $\eta' \in \Omega_A^{q-1}$ (summation implicit). Thus, using associativity of \wedge and then extendability of σ , we can re-write $g(\xi \otimes [e \otimes \eta])$ as in Figure 7.

We can see that this lies in $\text{im}(\sigma_E \wedge \text{id}) : \Omega_B^{p+1} \otimes_B E \otimes_A \Omega_A^{q-1} \rightarrow E \otimes_A \Omega_A^{p+q}$, and hence has equivalence class zero in $M_{p,q}$. \square

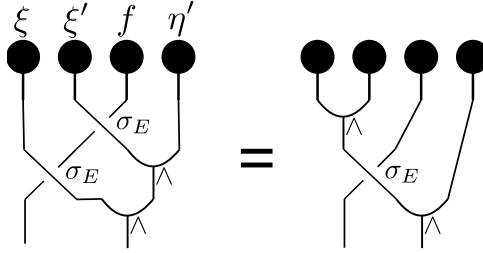

Figure 7: Re-writing $g(\xi \otimes [e \otimes \eta])$

Definition 3.4. We say that a B - A bimodule E with extendable zero-curvature right bimodule connection (∇_E, σ_E) is a (bimodule) differential fibration if g is an isomorphism for all $p, q \geq 0$ and if for all p the calculi Ω_B^p are flat as right modules.

Recall that flatness of Ω_B^p as a right B -module means that given a short exact sequence of left B -modules and left B -module maps

$$0 \longrightarrow E_1 \xrightarrow{\phi_1} E_1 \xrightarrow{\phi_2} E_1 \longrightarrow 0,$$

the following sequence of left B -modules and left B -module maps is also short exact.

$$0 \longrightarrow \Omega_B^p \otimes_B E_1 \xrightarrow{\text{id} \otimes \phi_1} \Omega_B^p \otimes_B E_2 \xrightarrow{\text{id} \otimes \phi_2} \Omega_B^p \otimes_B E_3 \longrightarrow 0.$$

If Ω_B^p is finitely generated projective, then flatness is automatic.

In the remaining part of this theory section, we show that given such a bimodule differential fibration, we can construct a Leray-Serre spectral sequence.

Lemma 3.5. *Suppose that we have a differential fibration (E, ∇_E) , so $g : \Omega_B^p \otimes_B N_q \rightarrow M_{p,q}$ is an isomorphism and Ω_B^p (for all p) are flat as right modules. We then have the following cochain complex on M with differential on $M_{p,q}$ given by $[\nabla_E^{[p+q]}]$, whose cohomology we denote as $\hat{H}^q(M_{p,q})$.*

$$\dots \xrightarrow{d} M_{p,q-1} \xrightarrow{d} M_{p,q} \xrightarrow{d} M_{p,q+1} \xrightarrow{d} \dots$$

We then have an isomorphism $\Omega_B^p \otimes_B \hat{H}^q(M_{0,q}) \rightarrow \hat{H}^q(M_{p,q})$ given by:

$$\xi \otimes [[e \otimes \eta]] \rightarrow [[\sigma_E(\xi \otimes e) \wedge \eta]]$$

We write $\hat{H}^q(N) := \hat{H}^q(M_{0,q})$.

Proof. (1) *Firstly, we show that the following diagram commutes:*

$$\begin{array}{ccc} \Omega_B^p \otimes_B N_q & \xrightarrow{(-1)^p \text{id} \otimes [\nabla_E^{[q]}}} & \Omega_B^p \otimes_B N_{q+1} \\ \downarrow g & & \downarrow g \\ M_{p,q} & \xrightarrow{[\nabla_E^{[p+q]}}} & M_{p,q+1} \end{array}$$

Earlier, in the proof that we have a filtration, we calculated (in diagram form) that $\nabla_E^{[p+q]}(\sigma_E \wedge \text{id}) = \sigma_E(d \otimes \text{id}) \wedge \text{id} + (-1)^p(\sigma_E \wedge \text{id})(\text{id} \otimes \nabla_E^{[q]})$. However, the term $\sigma_E(d \otimes \text{id}) \wedge \text{id}$ has equivalence class zero in $M_{p,q+1}$, so taking equivalence classes gives $[\nabla_E^{[p+q]} \circ g] = (-1)^p[(\sigma_E \wedge \text{id})(\text{id} \otimes \nabla_E^{[q]})]$.

Going the other way around the diagram also gives $g((-1)^p \text{id} \otimes [\nabla_E^{[q]}) = (-1)^p[(\sigma_E \wedge \text{id})(\text{id} \otimes \nabla_E^{[q]})]$, so the diagram commutes.

(2) *Secondly, we need to show the map $\Omega_B^p \otimes_B \hat{H}^q(N_q) \rightarrow \hat{H}^q(M_{p,q})$ given by $\xi \otimes [[e \otimes \eta]] \rightarrow [[\sigma_E(\xi \otimes e) \wedge \eta]]$ is an isomorphism.*

Define $Z_{p,q} := \text{im}(d) : M_{p,q-1} \rightarrow M_{p,q}$ and $K_{p,q} = \ker(d) : M_{p,q} \rightarrow M_{p,q+1}$, so $\hat{H}^{p+q}(M_{p,q}) = \frac{K_{p,q}}{Z_{p,q}}$. The differential $d : M_{0,q} \rightarrow M_{0,q+1}$ is a left B -module map by $[\nabla_E^{[q]}(b.e \otimes \eta)] = [\nabla_E^{[q]}(b.e \otimes \eta)] = [b.e \otimes d\eta] + [\nabla_E(b.e) \wedge \eta] = [b.e \otimes d\eta] + [\sigma_E(db \otimes e) \wedge \eta] + [b\nabla_E(e) \wedge \eta] = [b(\text{id} \otimes d + \nabla_E \wedge \text{id})(e \otimes \eta)] = [b\nabla_E^{[q]}(e \otimes \eta)]$. Hence there is an exact sequence of left B -modules:

$$0 \longrightarrow K_{0,q} \xrightarrow{\text{inc}} M_{0,q} \xrightarrow{d} Z_{0,q+1} \longrightarrow 0$$

Tensoring with the flat right module Ω_B^p gives another exact sequence:

$$0 \longrightarrow \Omega_B^p \otimes_B K_{0,q} \xrightarrow{\text{id} \otimes \text{inc}} \Omega_B^p \otimes_B M_{0,q} \xrightarrow{\text{id} \otimes d} \Omega_B^p \otimes_B Z_{0,q+1} \longrightarrow 0$$

Applying g to the elements of this sequence, the first part of the proof tells us that the following diagram commutes.

$$\begin{array}{ccccccc} 0 & \longrightarrow & \Omega_B^p \otimes_B K_{0,q} & \xrightarrow{\text{id} \otimes \text{inc}} & \Omega_B^p \otimes_B M_{0,q} & \xrightarrow{\text{id} \otimes d} & \Omega_B^p \otimes_B Z_{0,q+1} \longrightarrow 0 \\ & & \downarrow g & & \downarrow g & & \downarrow g \\ & & M_{p,q} & \xrightarrow{\text{id}} & M_{p,q} & \xrightarrow{(-1)^p d} & M_{p,q+1} \end{array}$$

Note that the middle instance of g is an isomorphism, while the first and third are merely injective. It follows from this diagram that $Z_{p,q+1} \cong \Omega_B^p \otimes_B Z_{0,q+1}$ and $K_{p,q+1} \cong \Omega_B^p \otimes_B K_{0,q+1}$. Hence $Z_{p,q} \cong \Omega_B^p \otimes_B Z_{0,q}$ and $K_{p,q} \cong \Omega_B^p \otimes_B K_{0,q}$. By definition of $\hat{H}^q(N) = \frac{K_{0,q}}{Z_{0,q}}$, we have another short exact sequence:

$$0 \longrightarrow Z_{0,q} \xrightarrow{\text{inc}} K_{0,q} \longrightarrow \hat{H}^q(N) \longrightarrow 0$$

Tensoring with the flat right module Ω_B^p then gives exact sequence:

$$0 \longrightarrow \Omega_B^p \otimes_B Z_{0,q} \xrightarrow{\text{id} \otimes \text{inc}} \Omega_B^p \otimes_B K_{0,q} \longrightarrow \Omega_B^p \otimes_B \hat{H}^q(N) \longrightarrow 0$$

Therefore $\Omega_B^p \otimes_B \hat{H}^q(N) \cong \frac{\Omega_B^p \otimes_B K_{0,q}}{\Omega_B^p \otimes_B Z_{0,q}} \cong \frac{K_{p,q}}{Z_{p,q}} = \hat{H}^{p+q}(M_{p,q})$, which is the isomorphism we wanted to show. \square

Proposition 3.6. *There is a zero-curvature left connection $\nabla_q : \hat{H}^q(N) \rightarrow \Omega_B^1 \otimes_B \hat{H}^q(N)$,*

$$\nabla_q([[e \otimes \xi]]) = \eta \otimes [[f \otimes \kappa]] \quad (7)$$

where $\nabla_E^{[q]}(e \otimes \xi) = \sigma_E(\eta \otimes f) \wedge \kappa \in \sigma_E(\Omega_B^1 \otimes E) \wedge \Omega_A^q \subset E \otimes_A \Omega_A^{q+1}$, with summation implicit.

Proof. We need to show that the map ∇_q is well-defined, satisfies the left Leibniz rule, and has zero curvature.

(1) Firstly, we show that the map is well-defined. We have $\nabla_E^{[q]}(e \otimes \xi) = \sigma_E(\eta \otimes f) \wedge \kappa \in E \otimes_A \Omega_A^{q+1}$, on account of the fact that $[[e \otimes \xi]] \in H^q(N) = \frac{\ker[\nabla_E^{[q]}]}{\text{im}[\nabla_E^{[q-1]}]}$, so $[\nabla_E^{[q]}(e \otimes \xi)] = [0] \in N_{q+1} = \frac{E \otimes_A \Omega_A^{q+1}}{\sigma_E(\Omega_B^1 \otimes_B E) \wedge \Omega_A^q}$, from which it follows that $\nabla_E^{[q]}(e \otimes \xi) = \sigma_E(\eta \otimes f) \wedge \kappa \in \sigma_E(\Omega_B^1 \otimes E) \wedge \Omega_A^q$. Hence by the isomorphism g , we have $\eta \otimes [f \otimes \kappa] \in \Omega_B^1 \otimes_B N_q$, from which it follows that $\eta \otimes [[f \otimes \kappa]] \in \Omega_B^1 \otimes_B \hat{H}^q(N)$, so the map ends up in the right space.

(2) Next, we show that ∇_q satisfies the left Leibniz rule $\nabla_q(b \cdot [[e \otimes \xi]]) = db \otimes [[e \otimes \xi]] + b \nabla_q([[e \otimes \xi]])$ for all $b \in B$. We calculate

$$\begin{aligned} \nabla_E^{[q]}(be \otimes \xi) &= (\text{id} \otimes d + \nabla_E \wedge \text{id})(be \otimes \xi) = be \otimes d\xi + \nabla_E(be) \wedge \xi \\ &= be \otimes d\xi + \sigma_E(db \otimes e) \wedge \xi + b \nabla_E(e) \wedge \xi \\ &= \sigma_E(db \otimes e) \wedge \xi + b \nabla_E^{[q]}(e \otimes \xi) \end{aligned}$$

Taking equivalence classes and using the isomorphism g gives the desired result.

(3) Lastly, we show that the curvature, $R_q = (d \otimes \text{id} - \text{id} \wedge \nabla_q) \nabla_q$ vanishes.

Denoting $\nabla_E^{[q]}(f \otimes \kappa) = \sigma_E(\eta' \otimes f') \wedge \kappa'$, we have:

$$\begin{aligned} R_q([[e \otimes \xi]]) &= d\eta \otimes [[f \otimes \kappa]] + \eta \wedge \nabla_q([[f \otimes \kappa]]) \\ &= d\eta \otimes [[f \otimes \kappa]] + \eta \wedge \eta' \otimes [[f' \otimes \kappa']] \end{aligned}$$

To show this vanishes, we want to show $d\eta \otimes [f \otimes \kappa] + \eta \wedge \eta' \otimes [f' \otimes \kappa'] = 0$.

As the curvature R_E vanishes, we have:

$$0 = \nabla_E^{[q+1]} \circ \nabla_E^{[q]}(e \otimes \xi) = \nabla_E^{[q+1]}(\sigma_E(\eta \otimes f) \wedge \kappa)$$

$$= (d \otimes \text{id} + \text{id} \wedge \nabla_E)(\sigma_E(\eta \otimes f) \wedge \kappa)$$

Taking equivalence classes and using the isomorphism g , we get

$$\begin{aligned} 0 &= (d \otimes \text{id} + \text{id} \wedge \nabla_E)(\eta \otimes [f \otimes \kappa]) \\ &= d\eta \otimes [f \otimes \kappa] + \eta \wedge \nabla_E([f \otimes \kappa]) \\ &= d\eta \otimes [f \otimes \kappa] + \eta \wedge \eta' \otimes [f' \otimes \kappa'] \end{aligned}$$

as required. Hence $R_q = 0$. \square

Equipping $\hat{H}^q(N)$ with a zero-curvature connection makes it a sheaf [2], which means we can do sheaf cohomology with coefficients in $\hat{H}^q(N)$. By the above results, there is a spectral sequence for the filtration, which has first page $E_1^{p,q} = H^{p+q}(M_{p,q}) \cong H^{p+q}(\Omega_B^p \otimes_B N_q) = \Omega_B^p \otimes_B \hat{H}^q(N)$, and second page position (p, q) given by $H^p(B, \hat{H}^q(N), \nabla_q)$, and which converges to $H(A, E, \nabla_E)$ in the sense described in the background section.

Recall that the sheaf cohomology group $H^p(B, \hat{H}^q(N), \nabla_q)$ is defined as the cohomology at $\Omega_{\text{CG}}^p \otimes_{\text{CG}} \hat{H}^q(N)$ in the following sequence (which is not necessarily exact).

$$0 \longrightarrow \hat{H}^q(N) \xrightarrow{\nabla_q} \Omega_{\text{CG}}^1 \otimes_{\text{CG}} \hat{H}^q(N) \xrightarrow{\nabla_q^{[1]}} \Omega_{\text{CG}}^2 \otimes_{\text{CG}} \hat{H}^q(N) \xrightarrow{\nabla_q^{[2]}} \dots$$

4 Theory: Fibrations (Left-handed Version)

By symmetry of modules, this construction can be mirrored to use an A - B bimodule E with an extendable zero-curvature left bimodule connection (∇_E, σ_E) , where $\nabla_E : E \rightarrow \Omega_A^1 \otimes_A E$ and $\sigma_E : E \otimes_B \Omega_B^1 \rightarrow \Omega_A^1 \otimes_A E$. In this case, zero curvature means $R_E = (d \otimes \text{id} - \text{id} \wedge \nabla_E)\nabla_E = 0$. The bimodule connection satisfies

$$\nabla_E^{[n]} \sigma_E = (\text{id} \wedge \sigma_E)(\nabla_E \otimes \text{id}) + \sigma_E(\text{id} \otimes \text{id}) : E \otimes_B \Omega_B^n \rightarrow \Omega_A^{n+1} \otimes_A E.$$

The cochain complex $C^n = \Omega_A^n \otimes_A E$ with differential $C^n \rightarrow C^{n+1}$ given by $d_C = \nabla_E^{[n]} = \text{id} \otimes d + (-1)^n \nabla_E \wedge \text{id}$ has a filtration $F^m C^n = \text{im}(\text{id} \wedge \sigma_E) : \Omega_A^{n-m} \otimes_A E \otimes_B \Omega_B^m \rightarrow \Omega_A^n \otimes_A E$. The quotients for the fibre are given as follows.

$$\begin{aligned} M_{p,q} &:= \frac{F^p C^{p+q}}{F^{p+1} C^{p+q}} = \frac{\Omega_A^q \wedge \sigma_E(E \otimes_B \Omega_B^p)}{\Omega_A^{q-1} \wedge \sigma_E(E \otimes_B \Omega_B^{p+1})} \\ N_q &:= M_{0,q} = \frac{C^q}{F^1 C^q} = \frac{\Omega_A^q \otimes_A E}{\Omega_A^{q-1} \wedge \sigma_E(E \otimes_B \Omega_B^1)}, \end{aligned}$$

There is then a well-defined map $g : N_q \otimes_B \Omega_B^p \rightarrow M_{p,q}$ given by $g([\eta \otimes e] \otimes \xi) = [(\text{id} \wedge \sigma)(\eta \otimes e \otimes \xi)]$ which extends to cohomology.

We say that E is a differential fibration if g is an isomorphism for all $p, q \geq 0$ and if the calculi Ω_B^p are flat as left modules for all $p \geq 0$

On the cohomology we have the following a zero-curvature right connection.

$$\nabla_q : \hat{H}^q(N) \rightarrow \hat{H}^q(N) \otimes_B \Omega_B^1, \quad \nabla_q([\xi \otimes e]) = [[\kappa \otimes f]] \otimes \eta,$$

where $\nabla_E^{[q]}(\xi \otimes e) = \kappa \wedge \sigma_E(f \otimes \eta) \in \Omega_A^q \wedge \sigma_E(E \otimes_B \Omega_B^1) \subset \Omega_A^{q+1} \otimes_A E$ with summation implicit. Assuming that we have a differential fibration, there is then a spectral sequence converging to $H(A, E, \nabla_E)$ with first page position (p, q) given by $E_1^{p,q} = \hat{H}^q(N) \otimes_B \Omega_B^p$ and second page position (p, q) given by $H^p(B, \hat{H}^q(N), \nabla_q)$.

5 Example: Group Algebras

The group algebra $\mathbb{C}X$ of a finite group X has general elements of the form $\sum_{x \in X} \lambda_x x$, where $\lambda_x \in \mathbb{C}$, and the elements of X give a basis of the algebra. $\mathbb{C}X$ is in general not commutative unless X is commutative.

For a right representation V of X , a surjective map $\omega : \mathbb{C}X \rightarrow V$ satisfying $\omega(xy) = \omega(x) \triangleleft y + \omega(y)$ for $x, y \in X$ is called a cocycle. This rule allows the calculation of ω on any element of X as a product of generators, and implies that $\omega(x^{-1}) = -\omega(x) \triangleleft x^{-1}$ and $\omega(1) = 0$. By results in [13], left covariant calculi on $\mathbb{C}X$ are classified by cocycles, and are given by $\Omega_{\mathbb{C}X}^1 = \Lambda_{\mathbb{C}X}^1 \otimes \mathbb{C}X$ with exterior derivative $dx = x\omega(x)$, right action $(v \otimes x).y = v \otimes xy$ and left action $x.(v \otimes y) = v \triangleleft x^{-1} \otimes xy$. In the following we abbreviate the calculus as $\Omega_{\mathbb{C}X}^1 = \Lambda_{\mathbb{C}X}^1 \cdot \mathbb{C}X$. The calculus is connected if and only if $\omega(x) \neq 0$ for all $x \in X \setminus \{0\}$, and in which case $H_{dR}(\mathbb{C}X) = \Lambda_{\mathbb{C}X}$.

Lemma 5.1. *If X is a finite group with calculus given by a right representation V and a cocycle $\omega : \mathbb{C}X \rightarrow V$, then for a subgroup $G \subset X$ the subspace $W \subset V$ spanned by $\omega(g)$ for all $g \in G$ then W is a right representation of G , and there exists a complement W^\perp which is also right representation of G .*

Proof. *The cocycle condition $\omega(x) \triangleleft y = \omega(xy) - \omega(y)$ defines a right action on W , which gives a calculus on $\mathbb{C}G$. Since G is a finite group, the representation V has an invariant inner product $\bar{V} \otimes V \rightarrow \mathbb{C}$ (invariant meaning $\langle \bar{v} \triangleleft g, v \triangleleft g \rangle = \langle \bar{v}, v \rangle$), from which it follows that $V = W \oplus W^\perp$, where W^\perp is the perpendicular complement of W . The vector space W^\perp is then also a representation of G . \square*

The restriction of ω to a cocycle $\mathbb{C}G \rightarrow W$ gives a calculus on the subgroup G .

Proposition 5.2. *If for the higher calculi on $\mathbb{C}X$ we assume that $d(V) = 0$, then the wedge product \wedge is antisymmetric on invariant elements $\Lambda_{\mathbb{C}X}$.*

Proof. *Since $v \triangleleft x = x^{-1}vx$, it follows that $x(v \triangleleft x) = vx$. Applying d to this and using the assumption that $d(V) = 0$ gives $dx \wedge (v \triangleleft x) = -v \wedge dx$. But then $v \wedge \omega(x) = v \wedge (x^{-1}dx) = (vx^{-1}) \wedge dx = x^{-1}(v \triangleleft x^{-1}) \wedge dx = -x^{-1}dx \wedge v = -\omega(x) \wedge v$. Since the images $\omega(x)$ span V , this proves the result. \square*

Now we look at fibrations. Suppose G is a finite subgroup of a group X , and take $A = \mathbb{C}X$, $B = \mathbb{C}G$ as in the discussion of fibrations earlier. Equip $\mathbb{C}X$ with calculus as above for $\Lambda_{\mathbb{C}X}^1 = V$ and some cocycle $\omega : \mathbb{C}X \rightarrow V$ for some right representation V of $\mathbb{C}X$. For the higher calculi on $\mathbb{C}X$ take maximal prolongation plus the assumption $d(V) = 0$. For the calculus on $\mathbb{C}G$ take $\Lambda_{\mathbb{C}G}^1 = W = \omega(\mathbb{C}G)$ with cocycle the restriction of ω to $\mathbb{C}G$, and maximal prolongation for the higher calculi.

Proposition 5.3. *A $\mathbb{C}G$ - $\mathbb{C}X$ bimodule is given by $E = \mathbb{C}X$ with left and right actions given by multiplication, and when the algebras are equipped with the calculi above there is a zero-curvature extendable right bimodule connection on E given by (∇_E, σ_E) , where $\nabla_E : \mathbb{C}X \rightarrow \mathbb{C}X \otimes_{\mathbb{C}X} \Omega_{\mathbb{C}X}^1$ is given by $\nabla_E(x) = 1 \otimes dx$, and the bimodule map $\sigma_E : \Omega_{\mathbb{C}G}^1 \otimes_{\mathbb{C}G} \mathbb{C}X \rightarrow \mathbb{C}X \otimes_{\mathbb{C}X} \Omega_{\mathbb{C}X}^1$ is given by $\sigma_E(dg \otimes x) = 1 \otimes dg.x$.*

Proof. The connection satisfies the condition $\nabla_E(gx) = \sigma_E(\text{dg} \otimes x) + g\nabla_E(x)$ required to be a bimodule connection, since $\sigma_E(\text{dg} \otimes x) = 1 \otimes (\text{d}(gx) - gdx) = 1 \otimes \text{dg}.x$. The curvature is zero because d has zero curvature. The connection is extendable as $\sigma_E(\xi \otimes x) = 1 \otimes \xi.x$ for all $\xi \in \Omega_{\mathbb{C}G}^n$. \square

Proposition 5.4. Equip $A = \mathbb{C}X$, $B = \mathbb{C}G$ with calculi as above, the B - A bimodule $E = \mathbb{C}X$ with actions given by multiplication. The right bimodule connection (∇_E, σ_E) as above, given by $\nabla_E(x) = 1 \otimes dx$ and $\sigma_E(\text{dg} \otimes x) = 1 \otimes \text{dg}.x$, is a differential fibration. The fibres are $N_q \cong (W^\perp)^{\wedge q}.\mathbb{C}X$, on which a differential $\text{d} : N_q \rightarrow N_{q+1}$ is given by

$$\text{d}(\xi.x) = (-1)^{|\xi|} \xi \wedge \pi^\perp(\omega(x) \triangleleft x^{-1}).x \quad (8)$$

for $\xi \in (W^\perp)^{\wedge q}$ and $x \in X$, and where we write π^\perp for the projection $V \rightarrow W^\perp$ which has kernel W . The differential $\nabla_q : \hat{H}^q(N) \rightarrow \Omega_{\mathbb{C}G}^1 \otimes_{\mathbb{C}G} \hat{H}^q(N)$ is given by

$$\nabla_q([\xi.x]) = \pi(\omega(x) \triangleleft x^{-1}) \otimes [\xi.x]. \quad (9)$$

The fibration E gives rise to a spectral sequence converging to $H(\mathbb{C}X, E, \nabla_E) \cong H_{\text{dR}}(\mathbb{C}X)$ with second page position (p, q) given by $H^p(\mathbb{C}G, \hat{H}^q(N), \nabla_q)$

Proof. (1) Firstly we show that E is a differential fibration. The calculi $\Omega_B^p = \Omega_{\mathbb{C}G}^p$ are finitely generated projective for all $p \geq 0$ and therefore flat as modules, and the bimodule connection has zero curvature and is extendable. Lastly we need to show that the map $g : \Omega_{\mathbb{C}G}^p \otimes_{\mathbb{C}G} M_{0,q} \rightarrow M_{p,q}$ given by $g(\xi \otimes [e \otimes \eta]) = [(\sigma_E \wedge \text{id})(\xi \otimes e \otimes \eta)] = [e \otimes \xi \wedge \eta]$ is an isomorphism. Using the fact that $x\xi = x\xi x^{-1}x = (\xi \triangleleft x^{-1})x$ to move all elements of the group to the right, and then the fact that $V = W \oplus W^\perp$, we calculate:

$$M_{p,q} = \frac{\sigma_E(\Omega_{\mathbb{C}X}^p \otimes_{\mathbb{C}X} E) \wedge \Omega_{\mathbb{C}G}^q}{\sigma_E(\Omega_{\mathbb{C}X}^{p+1} \otimes_{\mathbb{C}X} E) \wedge \Omega_{\mathbb{C}G}^{q-1}} = \frac{W^{\wedge p} \wedge V^{\wedge q}}{W^{\wedge p+1} \wedge V^{\wedge q-1}}.\mathbb{C}X \cong W^{\wedge p} \otimes (W^\perp)^{\wedge q}.\mathbb{C}X.$$

The above isomorphism sends $[w_{i_1} \wedge \cdots \wedge w_{i_p} \wedge v_{j_1} \wedge \cdots \wedge v_{j_q}] \rightarrow w_{i_1} \wedge \cdots \wedge w_{i_p} \wedge v_{j_1} \wedge \cdots \wedge v_{j_q}$ where the w_{i_k} are basis elements of W and the v_{i_k} are basis elements of V . The map g sending $W^{\wedge p} \otimes (W^\perp)^{\wedge q} \in \Omega_{\mathbb{C}G}^p \otimes_{\mathbb{C}X} M_{0,q}$ to $W^{\wedge p} \otimes (W^\perp)^{\wedge q} \in M_{p,q}$ then is an isomorphism.

(2) The fibres are $N_q \cong \frac{\Omega_{\mathbb{C}X}^q}{\Omega_{\mathbb{C}G}^1 \wedge \Omega_{\mathbb{C}X}^{q-1}} \cong (W^\perp)^{\wedge q}.\mathbb{C}X$. The differential $\text{d} : N_q \rightarrow N_{q+1}$ is given by $\text{d}(\xi.x) = (-1)^q [\xi \wedge dx]$ for $\xi \in (W^\perp)^{\wedge q}$ and $x \in X$, but we can use the fact that $dx = (\omega(x) \triangleleft x^{-1}).x$ to write the differential on N_q as $\text{d}(\xi.x) = (-1)^{|\xi|} \xi \wedge \pi^\perp(\omega(x) \triangleleft x^{-1}).x$. The cohomology of the fibre is then $\hat{H}^q(N) = \frac{\ker \text{d} : N^{q-1} \rightarrow N^q}{\text{im} \text{d} : N^{q-1} \rightarrow N^q}$, using this differential. The differential $\nabla_q : \hat{H}^q(N) \rightarrow \Omega_{\mathbb{C}G}^1 \otimes_{\mathbb{C}G} \hat{H}^q(N)$ on the cohomology groups is given by

$$\nabla_q([\xi \otimes x]) = g^{-1}([\pi(\omega(x) \triangleleft x^{-1}) \wedge \xi.x]) = \pi(\omega(x) \triangleleft x^{-1}) \otimes [\xi.x]. \quad \square$$

Group algebras are C^* -algebras, with a $*$ -map given by $(\lambda_x x)^* = \lambda_x^* x^{-1}$ and extended linearly. The bimodule E has an inner product $\langle \cdot, \cdot \rangle : \bar{E} \otimes_{\mathbb{C}G} E \rightarrow \mathbb{C}X$ given by $\langle \bar{x}, y \rangle = x^* y = x^{-1} y$, and the Leibniz rule shows that ∇_E preserves this inner product. On a C^* -algebra with an inner product we can use the KSGNS construction to obtain positive maps. The kernel of ∇_E consists of $\mathbb{C}.e$, and so the positive map we get via the KSGNS construction is $\langle \bar{e}, ge \rangle = g$. This is just the inclusion map, which is an algebra map. Lastly, we do a full calculation of the spectral sequence for the example of S_3 and its subgroup generated by the cycle $u = (1, 2)$.

Example 5.5. Let $X = S_3$, denote transpositions as $u = (12)$ and $v = (23)$, and then define a subgroup $G = \{e, u\} \subset S_3$. An example of a right representation of X is given by $V = \mathbb{C}^2$ with right action $(v_1, v_2) \triangleleft x = (v_1, v_2)\rho(x)$ for the homomorphism $\rho : S_3 \rightarrow \text{End}(V)$ given by $\rho(u) = \begin{pmatrix} 1 & 0 \\ 0 & -1 \end{pmatrix}$ and $\rho(v) = \frac{1}{2} \begin{pmatrix} -1 & \sqrt{3} \\ \sqrt{3} & 1 \end{pmatrix}$. To define a calculus on $X = \mathbb{C}S_3$ (and therefore by restriction a calculus on G) we need a cocycle $\omega : S_3 \rightarrow \mathbb{C}^2$ satisfying $\omega(xy) = \omega(x)\rho(y) + \omega(y)$. For the cocycle to be a well-defined linear map, we need to be able to apply ω to the three relations of S_3 , which are $u^2 = e$, $v^2 = e$, and $uvu = vuv$. If we write $\omega(v) = (a, b)$ and $\omega(u) = (c, d)$, we have the following.

(1) Recalling that $\omega(e) = 0$, the relation $u^2 = e$ gives:

$$0 = \omega(u^2) = \omega(u)\rho(u) + \omega(u) = (c, d)\begin{pmatrix} 1 & 0 \\ 0 & -1 \end{pmatrix} + (c, d) = (c, -d) + (c, d) = (2c, 0).$$

Hence $c = 0$. We can normalise to get $d = 1$ so that $\omega(u) = (0, 1)$.

(2) The relation $v^2 = e$ gives:

$$\begin{aligned} 0 = \omega(v^2) &= \omega(v)\rho(v) + \omega(v) = \omega(v)(\rho(v) + I_2) = (a, b)\frac{1}{2} \begin{pmatrix} 1 & \sqrt{3} \\ \sqrt{3} & 3 \end{pmatrix} \\ &= \frac{1}{2}(a + \sqrt{3}b, \sqrt{3}a + 3b) \end{aligned}$$

Both equations arising from this give that $a = -\sqrt{3}b$. We already normalised when defining $\omega(u)$, so we simply have b as a free parameter, giving $\omega(v) = (-\sqrt{3}b, b)$.

(3) Finally we have the relation $uvu = vuv$. We calculate:

$$\begin{aligned} \omega(uvu) &= \omega(u) + \omega(uv)\rho(u) = \omega(u) + \omega(v)\rho(u) + \omega(u)\rho(v)\rho(u) \\ &= (0, 1) + (-\sqrt{3}b, b)\begin{pmatrix} 1 & 0 \\ 0 & -1 \end{pmatrix} + (0, 1)\frac{1}{2} \begin{pmatrix} -1 & \sqrt{3} \\ \sqrt{3} & 1 \end{pmatrix} \begin{pmatrix} 1 & 0 \\ 0 & -1 \end{pmatrix} \\ &= (0, 1) + (-\sqrt{3}b, -b) + \left(\frac{1}{2}\sqrt{3}, -\frac{1}{2}\right) = \left(\frac{1}{2}\sqrt{3} - \sqrt{3}b, \frac{1}{2} - b\right). \end{aligned}$$

Flipping u and v in the above, we calculate:

$$\begin{aligned} \omega(vuv) &= \omega(v) + \omega(vu)\rho(v) = \omega(v) + \omega(u)\rho(v) + \omega(v)\rho(u)\rho(v) \\ &= (-\sqrt{3}b, b) + (0, 1)\frac{1}{2} \begin{pmatrix} -1 & \sqrt{3} \\ \sqrt{3} & 1 \end{pmatrix} + (-\sqrt{3}b, b)\frac{1}{2} \begin{pmatrix} 1 & 0 \\ 0 & -1 \end{pmatrix} \begin{pmatrix} -1 & \sqrt{3} \\ \sqrt{3} & 1 \end{pmatrix} \\ &= (-\sqrt{3}b, b) + \left(\frac{1}{2}\sqrt{3}, \frac{1}{2}\right) + (0, -2b) = \left(\frac{1}{2}\sqrt{3} - \sqrt{3}b, \frac{1}{2} - b\right). \end{aligned}$$

This shows that the equality $\omega(uvu) = \omega(vuv)$ follows automatically once we assume that $0 = \omega(u^2) = \omega(v^2)$, and hence we get no new restrictions on b as a result of this relation. This gives a 1-parameter family of 2D calculi on $\mathbb{C}X$, with Λ^1 generated by $e_u = \omega(u) = (0, 1)$ and $e_v = \omega(v) = b(-\sqrt{3}, 1)$, where $b \in \mathbb{C}$ is a free parameter. Take the calculus on $\mathbb{C}G$ to be the vector space W generated by e_u , so $\Omega_{\mathbb{C}G}^0 = \mathbb{C}\{1, u\}$ and $\Omega_{\mathbb{C}G}^1 = \omega(u)\mathbb{C}\{1, u\}$.

We now calculate the de Rham cohomology. As long as $b \neq \frac{1}{2}$, this ω doesn't send any elements of X other than e to zero, the calculus on $\mathbb{C}X$ is connected, and hence has de Rham cohomology $H_{dR}(\mathbb{C}X) = \Lambda_{\mathbb{C}X}$. This gives $H_{dR}^0(\mathbb{C}X) \cong \mathbb{C}$ and $H_{dR}^1(\mathbb{C}X) \cong \mathbb{C} \oplus \mathbb{C}$, while $H_{dR}^2(\mathbb{C}X)$ is a quotient of $\mathbb{C}^2 \wedge \mathbb{C}^2$. Since the wedge product is antisymmetric under the assumption $dV = 0$, a basis of this is given by $\omega(u) \wedge \omega(v)$, and $H_{dR}^2(\mathbb{C}X) \cong \mathbb{C}$.

We now calculate the Leray-Serre spectral sequence explicitly for this example, where $E = A = \mathbb{C}X$, $B = \mathbb{C}G$ for $X = S_3$ and G the subgroup generated by the cycle $u = (12)$. As $\omega(u) = (0, 1)$ is a basis of W , it follows that $(1, 0)$ is a basis of W^\perp , and hence $\pi^\perp(x, y) = (x, 0)$.

From the formula above that $N_q \cong (W^\perp)^{\wedge q} \cdot \mathbb{C}X$, we have $N_0 \cong \mathbb{C}X$ and $N_1 \cong (1, 0) \cdot \mathbb{C}X$. All the other N_q are zero, since $W^{\wedge 2}$ and $(W^\perp)^{\wedge 2}$ are zero, seeing as W and W^\perp are 1-dimensional and the wedge product is antisymmetric on V .

The one non-trivial differential is therefore $d : N_0 \rightarrow N_1$, given by $dx = \pi^\perp(\omega(x) \triangleleft x^{-1}) \cdot x$. The kernel of $d : N_0 \rightarrow N_1$ is two-dimensional with basis elements e and u . The reason that the identity element e lies in the kernel is because $\omega(e) = 0$, while u is in the kernel because $\omega(u) \triangleleft u^{-1} = \omega(u) \rho^{-1}(u) = (0, 1) \begin{pmatrix} 1 & 0 \\ 0 & -1 \end{pmatrix}^{-1} = (0, -1)$, which is sent by π^\perp to zero. The image of $d : N_0 \rightarrow N_1$ is four-dimensional with basis elements $(1, 0) \cdot v$, $(1, 0) \cdot uv$, $(1, 0) \cdot vu$, $(1, 0) \cdot uvu$.

Hence $H^0(N)$ is two-dimensional with basis elements $[e]$ and $[u]$, while $H^1(N)$ is two-dimensional with basis $[(1, 0) \cdot e]$ and $[(1, 0) \cdot u]$.

The differential $\nabla_0 : \hat{H}^0(N) \rightarrow \Omega_B^1 \otimes_B \hat{H}^0(N)$ is given on basis elements by $\nabla_0(e) = \pi(\omega(e) \triangleleft e^{-1}) \otimes [e] = 0$ and $\nabla_0(u) = \pi(\omega(u) \triangleleft u^{-1}) \otimes [u] = (0, -1) \otimes [u]$.

The differential $\nabla_0 : \hat{H}^1(N) \rightarrow \Omega_B^1 \otimes_B \hat{H}^1(N)$ is given on basis elements by $\nabla_1([(1, 0) \cdot e]) = \pi(\omega(e) \triangleleft e^{-1}) \otimes [(0, 1) \cdot e] = 0$ and $\nabla_1([(0, 1) \cdot u]) = \pi(\omega(u) \triangleleft u^{-1}) \otimes [(0, 1) \cdot u] = (0, -1) \otimes [(0, 1) \cdot u]$.

Hence ∇_0 has kernel spanned by $[e]$ and image spanned by $(0, 1) \cdot [u]$, while ∇_1 has kernel spanned by $[(0, 1) \cdot e]$ and image spanned by $(0, 1) \otimes [(0, 1) \cdot u]$.

Seeing as $\Omega_{\mathbb{C}X}^p = 0$ for $p \geq 2$ and $\hat{H}^q(N) = 0$ for $q \geq 2$, the sequences for the cohomology are the following two.

$$\begin{aligned} 0 &\longrightarrow \hat{H}^0(N) \xrightarrow{\nabla_0} \Omega_{\mathbb{C}G}^1 \otimes_{\mathbb{C}G} \hat{H}^0(N) \longrightarrow 0 \\ 0 &\longrightarrow \hat{H}^1(N) \xrightarrow{\nabla_1} \Omega_{\mathbb{C}G}^1 \otimes_{\mathbb{C}G} \hat{H}^1(N) \longrightarrow 0 \end{aligned}$$

$H^0(B, \hat{H}^0(N), \nabla_0)$ is the cohomology at $\hat{H}^0(N)$, which is $\frac{\ker(\nabla_0)}{\text{im}(0)} \cong \langle [e] \rangle_{\text{span}} \cong \mathbb{C}$.

$H^1(B, \hat{H}^0(N), \nabla_0)$ is the cohomology at $\Omega_{\mathbb{C}G}^1 \otimes_{\mathbb{C}G} \hat{H}^0(N)$, which is $\frac{\Omega_{\mathbb{C}G}^1 \otimes_{\mathbb{C}G} \hat{H}^1(N)}{\text{im}(\nabla_0)} \cong \langle (0, 1) \otimes [e] \rangle_{\text{span}} \cong \mathbb{C}$.

$H^0(B, \hat{H}^1(N), \nabla_1)$ is the cohomology at $\hat{H}^1(N)$, which is $\frac{\ker(\nabla_1)}{\text{im}(0)} \cong \langle [(0, 1) \cdot e] \rangle_{\text{span}} \cong \mathbb{C}$.

$H^1(B, \hat{H}^1(N), \nabla_1)$ is the cohomology at $\Omega_{\mathbb{C}G}^1 \otimes_{\mathbb{C}G} \hat{H}^1(N)$, which is $\frac{\Omega_{\mathbb{C}G}^1 \otimes_{\mathbb{C}G}}{\text{im}\nabla_1} \cong \langle (1, 0) \otimes [(1, 0) \cdot e] \rangle_{\text{span}} \cong \mathbb{C}$.

Page 2 of the Leray-Serre spectral sequence has entries $E_2^{p,q} = H^p(\mathbb{C}G, \hat{H}^q(N), \nabla_q)$, with $E_2^{0,0}, E_2^{0,1}, E_2^{1,0}, E_2^{1,1}$ as its nonvanishing entries. This is stable already, and hence the nontrivial cohomology groups are the following direct sums along diagonals.

$$\begin{aligned} H^0(\mathbb{C}S_3, E, \nabla_E) &\cong H^0(B, \hat{H}^0(N), \nabla_0) \cong \mathbb{C} \\ H^1(\mathbb{C}S_3, E, \nabla_E) &\cong H^1(B, \hat{H}^0(N), \nabla_0) \oplus H^0(B, \hat{H}^1(N), \nabla_1) \cong \mathbb{C} \oplus \mathbb{C} \\ H^2(\mathbb{C}S_3, E, \nabla_E) &\cong H^1(B, \hat{H}^1(N), \nabla_1) \cong \mathbb{C} \end{aligned}$$

This is the same as the de Rham cohomology $H_{dR}(\mathbb{C}X)$ that we calculated earlier. \diamond

Note that in [14], a different calculus on S_3 is obtained by using the same right action ρ but on the representation $V = M_2(\mathbb{C})$ instead of $V = \mathbb{C}^2$.

6 Example: Matrices

In [3] an inner calculus on the matrix algebra $M_2(\mathbb{C})$ is given by $db = [\theta', b] = \theta'b - b\theta'$ for $b \in M_2(\mathbb{C})$ and inner element $\theta' = E_{12}s' + E_{21}t'$, where s' and t' are central (i.e. they commute with any algebra element). The maximal prolongation calculus has the relation $s' \wedge t' = t' \wedge s'$.

We extend this idea to $M_3(\mathbb{C})$, giving it an inner calculus by $\theta = E_{12}s + E_{21}t + E_{33}u$ for central elements s, t, u . The differential $d : M_3(\mathbb{C}) \rightarrow \Omega_{M_3(\mathbb{C})}^1$ is then given by $da = [\theta, a] = [E_{12}, a]s + [E_{21}, a]t + [E_{33}, a]u$, which on a general matrix in $M_3(\mathbb{C})$ is the following.

$$d\begin{pmatrix} a & b & c \\ d & e & f \\ g & h & i \end{pmatrix} = \begin{pmatrix} d & e-a & f \\ 0 & -d & 0 \\ 0 & -g & 0 \end{pmatrix}s + \begin{pmatrix} -b & 0 & 0 \\ a-e & b & c \\ -h & 0 & 0 \end{pmatrix}t + \begin{pmatrix} 0 & 0 & -c \\ 0 & 0 & -f \\ g & h & 0 \end{pmatrix}u \quad (10)$$

From this we can see that $dE_{33} = 0$, which means the calculus is not connected, since a connected calculus needs $\ker d = \mathbb{C}I_3$.

For a higher order inner calculus, the differential is given by $d\xi = \theta \wedge \xi - (-1)^{|\xi|}\xi \wedge \theta$ for the inner element θ . For example, since $|u| = 1$, we have $du = \theta \wedge u + u \wedge \theta$, and similarly for s and t .

Proposition 6.1. *Equipping $M_3(\mathbb{C})$ with higher order inner calculus for the inner element $\theta = E_{12}s + E_{21}t + E_{33}u$ necessitates that $s \wedge t = t \wedge s = u \wedge u$.*

Proof. *As the calculus is inner, the differential is given by $da = \theta a - a\theta$. If we apply the differential twice to an element $a \in M_3(\mathbb{C})$, we get $d^2a = \theta \wedge (\theta a - a\theta) - (\theta a - a\theta) \wedge \theta = \theta \wedge \theta a - \theta \wedge a\theta + \theta \wedge a\theta - a\theta \wedge \theta = \theta \wedge \theta a - a\theta \wedge \theta = [\theta \wedge \theta, a]$. For d to be well-defined as a differential we need d^2a to vanish, so $\theta \wedge \theta$ needs to be central so that its commutator with anything vanishes. We calculate $\theta \wedge \theta = (E_{12}s + E_{21}t + E_{33}u) \wedge (E_{12}s + E_{21}t + E_{33}u) = E_{11}s \wedge t + E_{22}t \wedge s + E_{33}u \wedge u$. The only central elements of $M_3(\mathbb{C})$ are multiples of I_3 , and hence for $\theta \wedge \theta$ to be central we require $s \wedge t = t \wedge s = u \wedge u$. \square*

Although the additional assumptions that $u \wedge t = t \wedge u$ and $u \wedge s = s \wedge u$ are not mandatory, we make these as well so that all the generators of the calculi commute. Based on a private communication [10], these extra assumptions bring the growth of the calculi down from exponential to polynomial. With these additional assumptions, the derivatives of the calculi's basis elements are $ds = 2s \wedge \theta$, $dt = 2t \wedge \theta$ and $du = 2u \wedge \theta$. For $A = M_3(\mathbb{C})$ and $B = M_2(\mathbb{C})$, an example of a B - A bimodule is given by $E = M_{2,3}(\mathbb{C})$.

Proposition 6.2. *Suppose we equip A with inner calculus as above given by inner element $\theta = E_{12}s + E_{21}t + E_{33}u$. Then a right zero-curvature connection $\nabla_E : E \rightarrow E \otimes_A \Omega_A^1$ satisfying $\nabla_E(e_0) = 0$ for $e_0 = \begin{pmatrix} 2 & 0 & 0 \\ 0 & 2 & 0 \end{pmatrix}$ is well-defined and takes the form $\nabla_E(e_0 a) = e_0 \otimes da$. This connection becomes an extendable bimodule connection by the bimodule map $\sigma_E : \Omega_B^1 \otimes_B E \rightarrow E \otimes_A \Omega_A^1$ given by $\sigma_E(d\begin{pmatrix} a & b \\ c & d \end{pmatrix} \otimes e_0) = e_0 \otimes d\begin{pmatrix} a & b & 0 \\ c & d & 0 \\ 0 & 0 & 0 \end{pmatrix}$, which satisfies $\sigma_E(s' \otimes e_0) = e_0 \otimes s$ and $\sigma_E(t' \otimes e_0) = e_0 \otimes t$.*

Proof. (1) *First we show well-definedness of ∇_E . Observing that $e_0 \cdot \begin{pmatrix} 0 & 0 & 0 \\ 0 & 0 & 0 \\ g & h & i \end{pmatrix} = \begin{pmatrix} 0 & 0 & 0 \\ 0 & 0 & 0 \\ 0 & 0 & 0 \end{pmatrix} \in E$, the image of this under the linear map ∇_E must be zero, meaning that the differential must satisfy $e_0 \otimes d\begin{pmatrix} 0 & 0 & 0 \\ 0 & 0 & 0 \\ g & h & i \end{pmatrix} = 0 \in E \otimes_A \Omega_A^1$. Note that this wouldn't be true in the universal calculus. We calculate using the differential above that $e_0 \otimes dE_{3i} = e_0 \otimes (0 + 0 +$*

$[E_{33}, E_{3i}]u = \begin{pmatrix} 2 & 0 & 0 \\ 0 & 2 & 0 \end{pmatrix} \otimes (E_{3i} - \delta_{i,3}E_{3,3})u = \begin{pmatrix} 2 & 0 & 0 \\ 0 & 2 & 0 \end{pmatrix} (E_{3i} - \delta_{i,3}E_{3,3}) \otimes u = 0$, seeing as nonzero entries of $(E_{3i} - \delta_{i,3}E_{3,3})$ can only lie in the third row, and thus ∇_E is well-defined.

(2) Secondly, we calculate ∇_E . We can see that every element of E is of the form $e_0.a$, since $e_0.M_3(\mathbb{C}) = M_{2,3}(\mathbb{C}) = E$. Therefore, using the Leibniz rule and the assumption $\nabla_E(e_0) = 0$, we calculate the connection as $\nabla_E(e_0a) = \nabla_E(e_0).a + e_0 \otimes da = e_0 \otimes da$.

(3) Thirdly, the map σ_E satisfies $\sigma_E(db \otimes e_0) = \nabla_E(be_0) - b\nabla_E(e_0)$. But $\nabla_E(e_0) = 0$, so $\sigma_E(d\begin{pmatrix} a & b \\ c & d \end{pmatrix} \otimes e_0) = \nabla_E(\begin{pmatrix} a & b \\ c & d \end{pmatrix} e_0) = \nabla_E(e_0 \begin{pmatrix} a & b & 0 \\ c & d & 0 \\ 0 & 0 & 0 \end{pmatrix}) = e_0 \otimes d\begin{pmatrix} a & b & 0 \\ c & d & 0 \\ 0 & 0 & 0 \end{pmatrix}$ as required.

(4) Next, we show $\sigma_E(s' \otimes e_0) = e_0 \otimes s$ and $\sigma_E(t' \otimes e_0) = e_0 \otimes t$. In the calculus on B , we have $dE_{21} = [E_{12}, E_{21}]s' + [E_{21}, E_{21}]t' = \begin{pmatrix} 1 & 0 \\ 0 & -1 \end{pmatrix} s'$, and likewise on the calculus on A . Therefore, using the fact that σ_E is a bimodule map and that s' is central and also the formula above for σ_E ,

$$\begin{aligned} \begin{pmatrix} 1 & 0 \\ 0 & -1 \end{pmatrix} \sigma_E(s' \otimes e_0) &= \sigma_E(s' \begin{pmatrix} 1 & 0 \\ 0 & -1 \end{pmatrix} \otimes e_0) = \sigma_E(dE_{21} \otimes e_0) \\ &= e_0 \otimes d\begin{pmatrix} 0 & 0 & 0 \\ 1 & 0 & 0 \\ 0 & 0 & 0 \end{pmatrix} = e_0 \otimes \begin{pmatrix} 1 & 0 & 0 \\ 0 & -1 & 0 \\ 0 & 0 & 0 \end{pmatrix} s = \begin{pmatrix} 1 & 0 \\ 0 & -1 \end{pmatrix} e_0 \otimes s. \end{aligned}$$

However, as $\begin{pmatrix} 1 & 0 \\ 0 & -1 \end{pmatrix}$ is invertible, this implies $\sigma_E(s' \otimes e_0) = e_0 \otimes s$. The result $\sigma_E(t' \otimes e_0) = e_0 \otimes t$ follows similarly by considering $dE_{12} = [E_{12}, E_{12}]s' + [E_{21}, E_{12}]t' = \begin{pmatrix} -1 & 0 \\ 0 & 1 \end{pmatrix} t'$.

(5) Lastly, we show extendability. Since $B = M_2(\mathbb{C})$ is equipped with maximal prolongation calculus, Corollary 5.3 of [1] says that every zero-curvature bimodule connection is extendable. \square

Next we show that with this bimodule and connection we do indeed get a fibration.

Proposition 6.3. *Suppose $B = M_2(\mathbb{C})$ and $A = M_3(\mathbb{C})$ are equipped with the above calculi. Then the B - A bimodule $E = M_{2,3}(\mathbb{C})$ with the bimodule connection (∇_E, σ_E) from earlier gives a differential fibration, and thus a spectral sequence converging to $H(A, E, \nabla_E) = H(M_3(\mathbb{C}), M_{2,3}(\mathbb{C}), \nabla_E)$.*

Proof. For all $p \geq 0$ the calculi $\Omega_B^p = \Omega_{M_2(\mathbb{C})}^p$ are finitely generated projective and hence flat as modules. The bimodule connection (∇_E, σ_E) satisfies the requirements of having zero curvature and being extendable. The last property we need to show is therefore that the map $g : \Omega_B^p \otimes_B M_{0,q} \rightarrow M_{p,q}$ given by $g(\xi \otimes [e \otimes \eta]) = [(\sigma_E \wedge \text{id})(\xi \otimes e \otimes \eta)]$ is an isomorphism.

Since $E = e_0.M_3(\mathbb{C})$, the forms on $M_3(\mathbb{C})$ of degree p in the fibre and q in the base are given by the quotient

$$M_{p,q} = \frac{\sigma_E(\Omega_B^p \otimes_B E) \wedge \Omega_A^q}{\sigma_E(\Omega_B^{p+1} \otimes_B E) \wedge \Omega_A^{q-1}} \cong \frac{\sigma_E(\Omega_{M_2(\mathbb{C})}^p \otimes_{M_2(\mathbb{C})} e_0) \wedge \Omega_{M_3(\mathbb{C})}^q}{\sigma_E(\Omega_{M_2(\mathbb{C})}^{p+1} \otimes_{M_2(\mathbb{C})} e_0) \wedge \Omega_{M_3(\mathbb{C})}^{q-1}}.$$

Everything in the numerator is of the form $(s \text{ or } t)^{\wedge(p+q-k)} \wedge u^{\wedge k}.M_3(\mathbb{C})$ for some $0 \leq k \leq q$, while everything in the denominator is of the form $(s \text{ or } t)^{\wedge(p+q-k+1)} \wedge u^{\wedge(k-1)}.M_3(\mathbb{C})$ for $0 \leq k \leq q$. Since $u \wedge u = s \wedge t$, it follows that if an element of the numerator has $k \geq 2$ then it lies in the denominator. But if an element of the numerator has $k < q$ then it has to lie in the denominator. Therefore $M_{p,q} = 0$ for $q \geq 2$, and (omitting to write the equivalence classes) a basis of $M_{p,0}$ is given by $e_0 \otimes s^{\wedge r} \wedge t^{\wedge(p-r)}$ for some $0 \leq r \leq p$, while a basis of $M_{p,1}$ is given by $e_0 \otimes s^{\wedge r} \wedge t^{\wedge(p-r)} \wedge u$.

In the case $q = 0$, the map g is given on basis elements as

$$(s')^{\wedge r} \wedge (t')^{\wedge(p-r)} \otimes e_0 \longmapsto e_0 \otimes s^{\wedge r} \wedge t^{\wedge(p-r)}.$$

The map g here is an isomorphism, since it just re-arranges the order of the tensor product and re-labels s' and t' , which introduces no new relations.

Similarly in the case $q = 1$, the map g is given on basis elements as

$$(s')^{\wedge r} \wedge (t')^{\wedge(p-r)} \otimes e_0 \otimes u \longmapsto e_0 \otimes s^{\wedge r} \wedge t^{\wedge(p-r)} \wedge u,$$

which is an isomorphism. □

Next we calculate this limit of the spectral sequence.

Proposition 6.4. *The nonzero cohomology groups of A with coefficients in E can be calculated via the Leray-Serre spectral sequence as $H^0(A, E, \nabla_E) \cong \mathbb{C}$, $H^1(A, E, \nabla_E) \cong \mathbb{C}^6$, $H^2(A, E, \nabla_E) \cong \mathbb{C}^5$.*

Proof. (1) *The space N_0 is isomorphic to $e_0.A$, which has six-dimensional vector space basis $e_0.E_{ij}$ for $1 \leq i \leq 2$ and $1 \leq j \leq 3$ (i.e. excluding the bottom row). The space N_1 is isomorphic to $e_0.A \otimes u$, which has six-dimensional vector space basis $e_0.E_{ij} \otimes u$ for $1 \leq i \leq 2$ and $1 \leq j \leq 3$. Since we showed earlier that $M_{p,q} = 0$ for $q \geq 2$, this means that all the $N_i = M_{0,i} = 0$ for $i \geq 2$.*

(2) *The differential $d : N_0 \rightarrow N_1$ and is given by $d([e_0.E_{ij}]) = [\nabla_E(e_0.E_{ij})] = [e_0 \otimes dE_{ij}] = [e_0.[E_{33}, E_{ij}] \otimes u]$. The kernel has four-dimensional basis $[e_0.E_{11}]$, $[e_0.E_{12}]$, $[e_0.E_{21}]$, $[e_0.E_{22}]$. The image has two-dimensional basis $[e_0.E_{13} \otimes u]$ and $[e_0.E_{23} \otimes u]$.*

(3) *Consequently $\hat{H}^0(N)$ is four-dimensional with basis elements $[[e_0.E_{11}]]$, $[[e_0.E_{12}]]$, $[[e_0.E_{21}]]$, $[[e_0.E_{22}]]$. Also $\hat{H}^1(N)$ is four-dimensional with basis elements $[[e_0.E_{11} \otimes u]]$, $[[e_0.E_{12} \otimes u]]$, $[[e_0.E_{21} \otimes u]]$, $[[e_0.E_{22} \otimes u]]$.*

(4) *Next we calculate $\nabla_0 : \hat{H}^0(N) \rightarrow \Omega_B^1 \otimes_B \hat{H}^0(N)$ on the basis elements of $\hat{H}^0(N)$. For $1 \leq i, j \leq 2$ we have $\nabla_0([[e_0.E_{ij}]]) = g^{-1}([[e_0 \otimes dE_{ij}]])$. We calculate*

$$\begin{aligned} \nabla_0(e_0.E_{12}) &= g^{-1}([[e_0 \otimes (E_{22} - E_{11})t]]) = t' \otimes [[e_0.(E_{22} - E_{11})]], \\ \nabla_0(e_0.E_{21}) &= s' \otimes [[e_0.(E_{11} - E_{22})]], \\ \nabla_0(e_0.E_{11}) &= -s' \otimes [[e_0.E_{12}]] + t' \otimes [[e_0.E_{21}]] = -\nabla_0(e_0.E_{22}). \end{aligned}$$

Hence ∇_0 has one-dimensional kernel with basis $[[e_0.(E_{11} + E_{22})]]$, and three-dimensional image with basis elements $t' \otimes [[e_0.(E_{22} - E_{11})]]$, $s' \otimes [[e_0.(E_{11} - E_{22})]]$, $t' \otimes [[e_0.E_{21}]] - s' \otimes [[e_0.E_{12}]]$.

(5) *Next we calculate $\nabla_1 : \hat{H}^1(N) \rightarrow \Omega_B^1 \otimes_B \hat{H}^1(N)$ on the basis elements of $\hat{H}^1(N)$. For $1 \leq i, j \leq 2$, we have*

$$\begin{aligned} \nabla_E^{[1]}(e_0.E_{ij} \otimes u) &= \nabla_E(e_0.E_{ij}) \wedge u + e_0.E_{ij} \otimes du = e_0 \otimes [\theta, E_{ij}] \wedge u + 2e_0.E_{ij} \otimes \theta \wedge u \\ &= e_0 \otimes \left((E_{12}E_{ij} + E_{ij}E_{12})s + (E_{21}E_{ij} + E_{ij}E_{21})t \right) \wedge u \\ &= \sigma_E(s' \otimes e_0.(E_{12}E_{ij} + E_{ij}E_{12})) \wedge u + \sigma_E(t' \otimes e_0.(E_{21}E_{ij} + E_{ij}E_{21})) \wedge u. \end{aligned}$$

Consequently,

$$\nabla_1([[e_0.E_{ij} \otimes u]]) = s' \otimes [[e_0.(E_{12}E_{ij} + E_{ij}E_{12}) \otimes u]] + t' \otimes [[e_0.(E_{21}E_{ij} + E_{ij}E_{21}) \otimes u]].$$

Using this, we calculate $\nabla_1([[e_0.E_{12} \otimes u]]) = t' \otimes [[e_0 \otimes u]]$ and $\nabla_1([[e_0.E_{21} \otimes u]]) = s' \otimes [[e_0 \otimes u]]$ and $\nabla_1([[e_0.E_{11} \otimes u]]) = s' \otimes [[e_0.E_{12} \otimes u]] + t' \otimes [[e_0.E_{21} \otimes u]] = \nabla_1([[e_0.E_{22} \otimes u]])$. Hence the kernel of ∇_1 has one-dimensional basis $[[e_0.(E_{11} - E_{22}) \otimes u]]$, while the image has three-dimensional basis $t' \otimes [[e_0 \otimes u]]$, $s' \otimes [[e_0 \otimes u]]$, $s' \otimes [[e_0.E_{12} \otimes u]] + t' \otimes [[e_0.E_{21} \otimes u]]$.

(6) Next we work out the quotients for cohomology.

(i) Firstly, $H^0(B, \hat{H}^0(N), \nabla_0) \cong \frac{\ker(\nabla_0)}{\text{im}(0)} \cong \mathbb{C}$.

(ii) Secondly, $H^1(B, \hat{H}^0(N), \nabla_0) \cong \frac{\Omega_B^1 \otimes \hat{H}^0(N)}{\text{im}(\nabla_0)}$. Seeing as Ω_B^1 is a free module with two basis elements and $\hat{H}^0(N)$ is four-dimensional, the vector space $\Omega_B^1 \otimes_B \hat{H}^0(N)$ is eight-dimensional. The quotient is therefore five dimensional, and an example of a basis of $\frac{\Omega_B^1 \otimes \hat{H}^0(N)}{\text{im}(\nabla_0)}$ is given by $[s' \otimes [[e_0.E_{11}]]]$, $[s' \otimes [[e_0.E_{12}]]]$, $[s' \otimes [[e_0.E_{21}]]]$, $[t' \otimes [[e_0.E_{11}]]]$, $[t' \otimes [[e_0.E_{12}]]]$. Hence $H^1(B, \hat{H}^0(N), \nabla_0) \cong \mathbb{C}^5$.

(iii) Thirdly, $H^0(B, \hat{H}^1(N), \nabla_1) \cong \frac{\ker(\nabla_1)}{\text{im}(0)} \cong \mathbb{C}$.

(iv) Lastly, $H^1(B, \hat{H}^1(N), \nabla_1) \cong \frac{\Omega_B^1 \otimes_B \hat{H}^1(N)}{\text{im}(\nabla_1)}$. Seeing as Ω_B^1 is a free module with two basis elements and $\hat{H}^1(N)$ is four-dimensional, the vector space $\Omega_B^1 \otimes_B \hat{H}^1(N)$ is eight-dimensional. Taking the quotient by the three-dimensional $\text{im}(\nabla_1)$ gives a five-dimensional vector space. Hence $H^1(B, \hat{H}^1(N), \nabla_1) \cong \mathbb{C}^5$.

(7) Page 2 of the Leray-Serre spectral sequence has entries $E_2^{p,q} = H^p(B, \hat{H}^q(N), \nabla_q)$, with $E_2^{0,0}, E_2^{0,1}, E_2^{1,0}, E_2^{1,1}$ as its nonvanishing entries. This is stable already, and hence the nontrivial cohomology groups are the following direct sums along diagonals.

$$\begin{aligned} H^0(A, E, \nabla_E) &\cong H^0(B, \hat{H}^0(N), \nabla_0) \cong \mathbb{C} \\ H^1(A, E, \nabla_E) &\cong H^1(B, \hat{H}^0(N), \nabla_0) \oplus H^0(B, \hat{H}^1(N), \nabla_1) \cong \mathbb{C}^5 \oplus \mathbb{C} \cong \mathbb{C}^6 \\ H^2(A, E, \nabla_E) &\cong H^1(B, \hat{H}^1(N), \nabla_1) \cong \mathbb{C}^5. \end{aligned}$$

□

The bimodule E has inner product $\langle, \rangle : \bar{E} \otimes_B E \rightarrow A$ given by $\langle \bar{x}, y \rangle = x^*y$, where $*$ is the conjugate transpose map. As matrix algebras are C^* -algebras, the KSGNS construction says that the map $\phi : B \rightarrow A$ given by $\phi(b) = \langle \bar{e}_0, be_0 \rangle$ is completely positive. For $e_0 = \begin{pmatrix} 2 & 0 & 0 \\ 0 & 2 & 0 \end{pmatrix}$ then ϕ is not an algebra map, seeing as $\phi(I_2) = 4I_3 \neq I_3$, and algebra maps have to send the identity to the identity.

Moreover, $\nabla_E(e_0) = 0$, so for ϕ to be a cochain map we just need metric preservation, which holds because of the following. Recall that for the right connection ∇_E on E , we have $\nabla_E(e_0a) = e_0 \otimes da$, which gives a corresponding left connection $\nabla_{\bar{E}}$ on \bar{E} given by $\nabla_{\bar{E}}(\bar{e}_0\bar{a}) = da^* \otimes \bar{e}_0$, and that the inner product on E is given by $\langle \bar{x}, y \rangle = x^{-1}y$. Then:

$$\begin{aligned} da_1^* \langle \bar{e}_0, e_0a_2 \rangle + \langle \bar{e}_0a_1, e_0 \rangle da_2 &= da_1^* . e_0^* e_0 a_2 + a_1^* e_0^* e_0 da_2 = 4da_1^* . a_2 + 4a_1^* da_2 \\ &= 4da_1^* a_2 = da_1^* e_0^* e_0 a_2 = d \langle \bar{e}_0a_1, e_0a_2 \rangle. \end{aligned}$$

Thus by Proposition 2.9, ϕ is a completely positive cochain map, but not an algebra map.

7 Bibliography

In the following Bibliography the websites listed were last accessed in January 2023, at which time they were all current.

References

- [1] G. Alhamzi, E.J. Beggs, Differentiating the State Evaluation Map from Matrices to Functions on Projective Space, 10.48550/ARXIV.2210.07033
- [2] E.J. Beggs and T. Brzeziński, The Serre spectral sequence of a noncommutative fibration for de Rham cohomology, *Acta Math.* 195 (2005) 155–196
- [3] E.J. Beggs and S. Majid, *Quantum Riemannian Geometry*, ISBN 978-3-030-30293-1, Springer, 2020
- [4] E.J. Beggs and S. Majid, Bar categories and star operations, *Algebras and Representation Theory*, 12 (2009) 103–152
- [5] E.J. Beggs and I. Masmali, A Leray spectral sequence for noncommutative differential fibrations, *Int. J. Geom. Methods Mod. Phys.* 10 (2013) 1350015 (17pp.)
- [6] K. Bresser, F. Müller-Hoissen, A. Dimakis and A. Sitarz, Noncommutative geometry of finite groups. *J. Phys. A*, 29 (1996) 2705–2735
- [7] M. Dubois-Violette and P.W. Michor, Connections on central bimodules in noncommutative differential geometry, *J. Geom. Phys.* 20 (1996) 218–232
- [8] M. Dubois-Violette and T. Masson, On the first-order operators in bimodules, *Lett. Math. Phys.* 37 (1996) 467–474
- [9] G. Fiore and J. Madore, Leibniz rules and reality conditions, *Eur. Phys. J. C Part. Fields* 17 (2000) 359–366
- [10] T. Ivanova, personal communication, 2022
- [11] E.C. Lance, *Hilbert C^* -modules, A toolkit for operator algebraists*, LMS. Lecture Note Series 210, CUP. 1995
- [12] J. Madore, *An introduction to noncommutative differential geometry and its physical applications*, LMS Lecture Note Series, 257, CUP 1999
- [13] S. Majid, Classification of bicovariant differential calculi, *J. Geom. Phys.* 25 (1998) 119–140
- [14] S. Majid and W-Q. Tao, Generalised noncommutative geometry on finite groups and Hopf quivers, *J. Noncom. Geom.* 13 (2019) 1055–1116
- [15] J. McCleary, *A User’s Guide to Spectral Sequences*, 2nd ed., Cambridge University Press, 2001
- [16] J. Mourad, Linear connections in noncommutative geometry, *Class. Quant. Grav.* 12 (1995) 965–974
- [17] L.penguu, Own work image, CC BY-SA 4.0, <https://commons.wikimedia.org/w/index.php?curid=110078656>

- [18] E.H. Spanier, Algebraic Topology, Springer Science & Business Media, 2012, ISBN 9781468493221