

CONTACT HOMOLOGY COMPUTATIONS FOR SINGULAR LEGENDRIANS

MARTIN BÄCKE

ABSTRACT. The Chekanov–Eliashberg dg-algebra is an algebraic invariant of Legendrian submanifolds of contact manifolds, whose definition recently has been extended to singular Legendrians. We describe a way of constructing simpler, finitely generated models of this algebra for singular Legendrian knots in \mathbb{R}^3 . This yields many new examples of Legendrians for which the cohomology of the Chekanov–Eliashberg algebra can be computed, including the infinite families of the Legendrian θ -graph and its generalizations, and the standard A_n -Legendrians. Along the way, we compute the cohomology of the Chekanov–Eliashberg algebra in the boundary of a Weinstein surface, also known as the internal algebra of Ekholm–Ng. This finishes the proof of the Bourgeois–Ekholm–Eliashberg surgery formula in dimension two, which was missing from the literature.

CONTENTS

1. Introduction	1
Outline	2
1.1. Chekanov–Eliashberg algebras in the boundary of a Weinstein surface	2
1.2. Chekanov–Eliashberg algebras for singular Legendrians	3
Acknowledgments	5
2. Chekanov–Eliashberg algebras for smooth Legendrians	5
2.1. Smooth Chekanov–Eliashberg algebras and wrapped Floer cohomology	5
2.2. The surgery formula for surfaces	9
3. Chekanov–Eliashberg algebras for singular Legendrians	13
3.1. Chekanov–Eliashberg algebras for singular Legendrians	13
3.2. The singular algebra in \mathbb{R}^3	15
3.3. Weinstein isotopy and invariance	16
3.4. Reidemeister moves and the Ng resolution	17
4. Stopped subalgebras	19
4.1. Bordered Legendrians	19
4.2. Stopped subalgebras	20
4.3. Bordered Legendrians from opening up singular Legendrians	24
5. Examples and computations	26
5.1. Rainbow connected sums	27
5.2. Finite dimensional models	28
5.3. Infinite dimensional models	32
References	34

1. INTRODUCTION

The Chekanov–Eliashberg dg-algebra is an invariant of Legendrian submanifolds of contact manifolds. In recent years, its definition has been extended to singular Legendrian skeleta of Weinstein hypersurfaces. This was first done combinatorially by An–Bae in [AB20] for singular Legendrians in \mathbb{R}^3 , and given a geometric-analytic generalization by Asplund–Ekholm in [AE22] to skeleta of Weinstein hypersurfaces in the boundary of a general Weinstein manifold. For a singular Legendrian Λ ,

which is the skeleton of some Weinstein hypersurface V , living in the ideal contact boundary of some Weinstein manifold W , we denote this algebra by $CE^*(\Lambda; V_0; W)$, where V_0 is the subcritical part of V . Through the surgery formula [AE22, Theorem 1.1], this algebra corresponds to the partially wrapped Floer cohomology of the Weinstein sector obtained by stopping the manifold at the hypersurface V . When Λ is smooth, $CE^*(\Lambda; V_0; W)$ is quasi-isomorphic to the Chekanov–Eliashberg algebra with based loop space coefficients [AE22, Theorem 1.2]. In \mathbb{R}^3 , this dg-algebra is also quasi-isomorphic to the more classical Chekanov–Eliashberg algebra with non-central coefficients in $\mathbb{Z}[t, t^{-1}]$.

In this paper, we describe a way of constructing simpler models of the Chekanov–Eliashberg algebra for singular Legendrians in \mathbb{R}^3 , and obtain many new examples in which the cohomology can be computed. These include the infinite families of the θ -Legendrian and its generalizations, and the standard A_n -Legendrians. There is also an infinite class of singular Legendrians for which this method produces finite dimensional models.

The algebra $CE^*(\Lambda; V_0; W)$ contains the Chekanov–Eliashberg algebra $CE^*(\partial\Lambda; V_0)$ of the attaching spheres $\partial\Lambda \subset \partial V_0$ as a dg-subalgebra. We compute the cohomology and minimal model of this subalgebra when $\dim V = 2$, where it is also known as the internal algebra of Ekholm–Ng. This finishes the proof of the Bourgeois–Ekholm–Eliashberg surgery formula in dimension two, which previously was not considered in the literature. In contrast to the situation in higher dimensions, the surgery map for surfaces fails to be an A_∞ -isomorphism while it still is a quasi-isomorphism.

Outline. In the remaining part of Section 1, we state our main results. Section 2 and Section 3 are mainly a review of basic definitions and results about Chekanov–Eliashberg algebras and singular Legendrians. The exception is Section 2.2, which deals with the surgery formula for Weinstein surfaces. In Section 4, we prove our main results. Finally, in Section 5 we give examples of how one can apply these results to compute the cohomology of the Chekanov–Eliashberg algebra.

1.1. Chekanov–Eliashberg algebras in the boundary of a Weinstein surface. Let V be a compact Weinstein surface and let $\partial\Lambda \subset \partial V$ be an embedding which is a 0-dimensional Legendrian, partitioned into two-point spheres and one-point stops. The Reeb chords are counter-clockwise arcs with endpoints on $\partial\Lambda$. We fix a base point in $\partial V \setminus \partial\Lambda$ for each component of ∂V and denote the chords as c_{ij}^p , where i is the starting point, j is the endpoint, and p is the number of times the chord passes through the base point. See Figure 1. The Chekanov–Eliashberg algebra $CE^*(\partial\Lambda; V)$

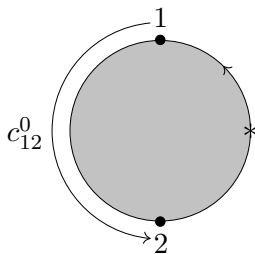

FIGURE 1. The Chekanov–Eliashberg algebra in the boundary of a disk.

is then an infinitely generated semi-free unital dg-algebra over the ground field \mathbf{k} , whose underlying associate algebra is the path algebra of the quiver with one vertex for each sphere and stop of $\partial\Lambda$, and the Reeb chords as arrows. The results in this paper can be shown to hold over any field \mathbf{k} , but in order to avoid worrying about signs, our computations will be carried out in the case $\mathbf{k} = \mathbb{Z}_2$. However, the results remain true in all characteristics. The differential is given by $\partial = \partial_0 + \partial_{-1}$, where

$$\partial_0(c_{ij}^p) = \sum \pm c_{kj}^p c_{ik}^{p-l}$$

with the sum taken over all k and l for which the chords on the right hand side exist, and $\partial_{-1}(c_{ij}^p) = e_k$ if c_{ij}^p is a chord with $i = j$, $p = 1$, and which lives in the boundary of a disk, where e_k is the idempotent corresponding to the sphere or stop containing i , and $\partial_{-1}(c_{ij}^p) = 0$ otherwise. The differential comes from a count of pseudo-holomorphic curves as usual, see Proposition 2.8.

We attach Weinstein handles at the spheres and half-handles at the stops to obtain a Weinstein sector $V_{\partial\Lambda}$. Let $C \subset V_{\partial\Lambda}$ be the co-cores of the handles and half-handles, and let $CW^*(C; V_{\partial\Lambda})$ be the partially wrapped Floer cohomology of C . The following theorem combines the surgery formula for smooth Legendrians by Bourgeois–Ekholm–Eliashberg and the surgery formula for singular Legendrians by Asplund–Ekholm. In this paper we prove the case when $\dim V_{\partial\Lambda} = 2$, which previously was not treated.

Theorem 1.1 (Theorem 2.7). *There is an A_∞ -quasi-isomorphism*

$$CW^*(C; V_{\partial\Lambda}) \xrightarrow{\sim} CE^*(\partial\Lambda; V).$$

A proof of the surgery formula in higher dimensions has appeared in [EL17, Appendix B][Ekh19], and there the map is an A_∞ -isomorphism. In the two-dimensional case, all Reeb chords are degenerate, which prevents the map from being a chain level isomorphism. We prove that it is a quasi-isomorphism by explicitly computing the cohomology of both sides. As noted in [AE22, Example 7.3], when $\partial\Lambda$ consists entirely of one-point stops, the two-dimensional case follows from computations done in [EL19, Corollary 11].

Using the surgery formula, one can then also describe the higher operations of the minimal model of $CE^*(\partial\Lambda; V)$. We call a word in $CE^*(\partial\Lambda; V)$ *unconcatable* if there are no adjacent Reeb chords in the word whose respective starting point and endpoint coincide. We call a chord *short* if it is not the concatenation of any other two chords. Finally, we call a word $c_k \dots c_1$ of Reeb chords (of which none is an idempotent) a *disk sequence* if all adjacent chords in the word have respective starting points and endpoints which coincide, and if when concatenating the chords of the word into a single chord, one obtains a chord of the form c_i^1 which bounds a disk in V . For two short chords c_2 and c_1 we define their concatenation $c_2 * c_1$ as the geometric concatenation to a Reeb chord, if it makes sense, and as 0 otherwise.

Theorem 1.2. *Let $\partial\Lambda$ be a 0-dimensional Legendrian in the boundary of a Weinstein surface V and suppose that no co-core in C is null-homotopic. As a vector space, $H^*CE(\partial\Lambda; V)$ has a basis consisting of the unconcatable words of short chords. The A_∞ -operations μ_k of the minimal model structure on $H^*CE(\partial\Lambda; V)$ act as follows. The multiplication is associative and unital, and determined by the relations*

$$\mu_2(c_2 \otimes c_1) = \partial_{-1}(c_2 * c_1)$$

for any short chords c_2 and c_1 , neither of which is an idempotent. The higher operations are for $k \geq 3$ given by

$$\begin{aligned} \mu_k(c_k \otimes \dots \otimes c_1 c) &= c, \\ \mu_k(cc_k \otimes \dots \otimes c_1) &= c, \end{aligned}$$

on all tensor products of words of the form $c_k \otimes \dots \otimes c_1 c$ and $cc_k \otimes \dots \otimes c_1$ such that $c_k \dots c_1$ is a disk sequence, and $c_1 c$ and cc_k are unconcatable, and vanish on all other words. The chord c is also allowed to be an idempotent.

On the other hand, if $\partial\Lambda$ contains a 0-sphere $\partial\Pi$ for which C_Π is null-homotopic, then there is a quasi-isomorphism $CE^*(\partial\Lambda \setminus \partial\Pi; V_{\partial\Pi}) \xrightarrow{\sim} CE^*(\partial\Lambda; V)$.

1.2. Chekanov–Eliashberg algebras for singular Legendrians. We here state our main result. Let V be a Weinstein hypersurface in \mathbb{R}^3 with singular Legendrian skeleton Λ . Recall that a Weinstein hypersurface is a hypersurface $V \subset (\mathbb{R}^3, \ker(dz - ydx))$ such that there exists a contact form $e^f(dz - ydx)$ that restricts to a Liouville form on V that is compatible with a Weinstein

structure. In [Eli18, Section 2], it was shown that the skeleton of a Weinstein hypersurface is independent on the choice of contact form (as long as the restriction is Liouville). We assume that the skeleton is smooth away from the subcritical part $V_0 \subset V$, where the latter is a union of balls. Further we assume that the skeleton consists of the cone of a finite number of points in the boundary of V_0 . We let $\partial\Lambda \subset \partial V_0$ be the attaching spheres in the handle decomposition of V . The Chekanov–Eliashberg algebra $CE^*(\Lambda; V_0; \mathbb{R}^4)$ is, as an associative algebra, isomorphic to the path algebra over \mathbf{k} of the quiver with one idempotent for each top handle of V , one arrow for each Reeb chord of Λ in \mathbb{R} , and one arrow for each Reeb chord of $\partial\Lambda$ in ∂V_0 . Note that the algebra is infinitely generated. The differential is defined by counting pseudo-holomorphic curves in the symplectization. In \mathbb{R}^3 , it can be explicitly computed by counting admissible disks in the Lagrangian projection [AE22, Section 7.1], similarly to in the classical definition due to Chekanov [Che02].

Our main theorem states that for each singular Legendrian Λ , there is a so-called *bordered* or *open* Legendrian Λ^\bullet in the sense of [Siv11, ABS22a, ABS22b, ABK22], with Chekanov–Eliashberg algebra quasi-isomorphic to that of Λ . We call Λ^\bullet the *resolution* of Λ ; see Definition 4.17. We need

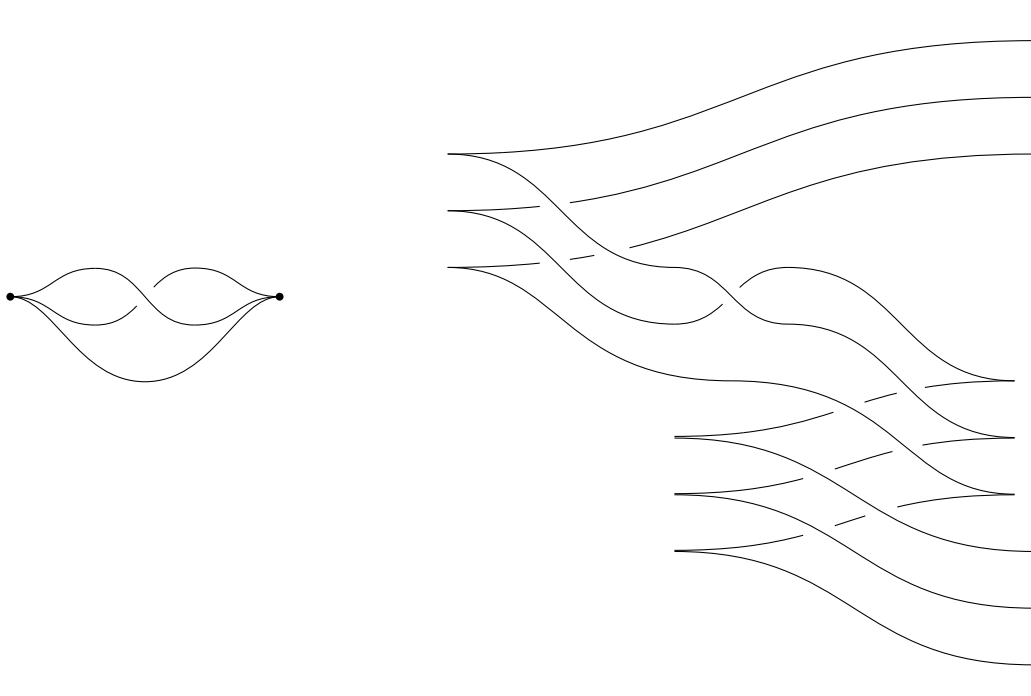

FIGURE 2. To the left is the front projection of a singular Legendrian Λ and to the right is its bordered Legendrian resolution Λ^\bullet .

to warn the reader Λ^\bullet is not canonically defined up to compactly supported Legendrian isotopy. Despite this, however, we can associate an invariant $CE^*(\Lambda^\bullet; \mathbb{R}^4)$ to Λ^\bullet which is quasi-isomorphic to the Chekanov–Eliashberg algebra of Λ . In the front projection, Λ^\bullet is constructed by first moving Λ by an isotopy into a position such that the singularities all have the same x -coordinate, and the rest of the Legendrian lies to the right of the singularities. We then replace each singularity with a negative half-twist as in Figure 2. It is immaterial in which order the twists are performed, and if the ends of the twists go above or below the Legendrian.

Theorem 1.3 (Theorem 4.19). *Let $\Lambda \subset \mathbb{R}^3$ be a singular Legendrian. There is a quasi-isomorphism*

$$CE^*(\Lambda; V_0; \mathbb{R}^4) \cong CE^*(\Lambda^\bullet; \mathbb{R}^4).$$

The Chekanov–Eliashberg algebra of Λ^\bullet has one generator for each crossing and right cusp in the front, and the differential is given by counting disks, just as for ordinary compact Legendrians. In particular, $CE^*(\Lambda^\bullet; \mathbb{R}^4)$ is finitely generated.

If Λ only has one singularity, and the rest of Λ lies to the left of the singularity in the front projection, there is a related construction which gives an even simpler bordered Legendrian Λ° , which we call the *opening* of Λ ; see Definition 4.16. In the front, Λ° is obtained from Λ by removing the singularity and separating the strands, as in Figure 3.

Theorem 1.4 (Theorem 4.21). *Let $\Lambda \subset \mathbb{R}^3$ be a singular Legendrian with only one singularity, such that the rest of Λ lies to the left of the singularity in the front projection. Then there is a quasi-isomorphism*

$$CE^*(\Lambda; V_0; \mathbb{R}^4) \cong CE^*(\Lambda^\circ; \mathbb{R}^4).$$

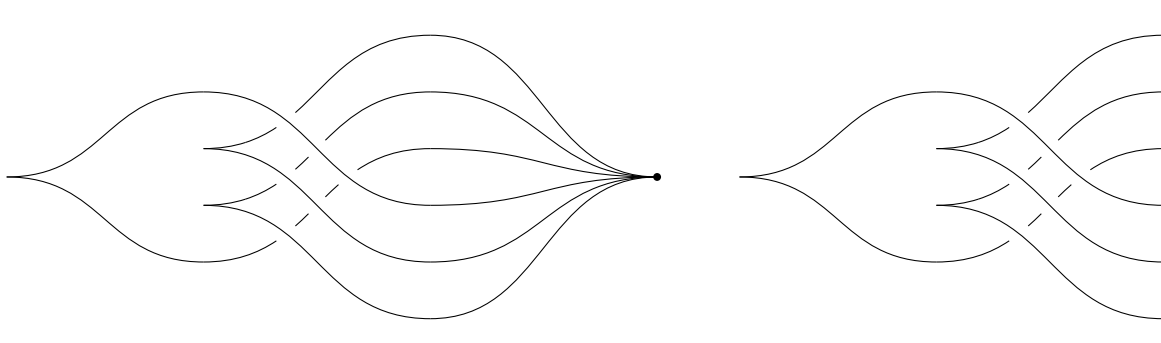

FIGURE 3. To the left is the front projection of a singular Legendrian Λ and to the right is its bordered Legendrian opening Λ° .

In Section 5 we explore a number of examples where the Chekanov–Eliashberg algebra of Λ° is simple enough to allow one to compute the minimal A_∞ -model.

Acknowledgments. This paper is based on the author’s bachelor and master theses, which were supervised by Georgios Dimitroglou Rizell. The author would like to express his gratitude to him for introducing him to this research area, many helpful discussions, and for his careful reading of earlier drafts of this paper. The author is supported by the grant KAW 2021.0300 from the Knut and Alice Wallenberg Foundation.

2. CHEKANOV–ELIASHBERG ALGEBRAS FOR SMOOTH LEGENDRIANS

In this section, we first give a brief overview of the construction of the Chekanov–Eliashberg algebra for smooth Legendrians, the wrapped Floer cohomology, and the surgery and cobordism maps. This material follows [BEE12, EL17], where details can be found. We then compute the cohomology of the Chekanov–Eliashberg algebra in the boundary of a surface, which finishes the proof of the surgery formula in dimension two.

2.1. Smooth Chekanov–Eliashberg algebras and wrapped Floer cohomology. Let W be a Weinstein $2n$ -manifold, with subcritical part W_0 , and let Λ be a smooth Legendrian link of $(n-1)$ -spheres living in the ideal contact boundary ∂W of W . Write W_Λ for the Weinstein manifold obtained by attaching critical Weinstein n -handles to W at Λ , and C for the co-cores of the handles. We refer to [CE12] for details.

2.1.1. *The Chekanov–Eliashberg algebra.* The Chekanov–Eliashberg algebra $CE^*(\Lambda; W)$ of Λ is the semi-free dg-algebra generated by the Reeb chords of Λ , with one idempotent for each component of Λ . We use cohomological grading and define the degree of a chord c of Λ to be $|c| = -\text{CZ}(c) + 1$, where $\text{CZ}(c)$ is the Conley–Zehnder index. The differential ∂c is given by counting rigid (modulo translations along the \mathbb{R} -coordinate) pseudo-holomorphic disks in the symplectization $\mathbb{R} \times \partial\Lambda$ of $\partial\Lambda$, taking c as input, which is the asymptotic Reeb chord at the positive end, and outputting a word $c_k \dots c_1$ of chords, which are the asymptotics at the negative end. The disks are allowed to have anchors in W . An anchor in W is an interior puncture of the disk with a Reeb orbit asymptotic at the negative end, along with an embedding of a rigid pseudo-holomorphic punctured Riemann sphere $\mathbb{C} \rightarrow W$, such that the puncture of the Riemann sphere converges the same Reeb orbit as the interior puncture of the disk. It follows from the dimension formula in [CEL10] that $|\partial| = 1$. To see that $\partial^2 = 0$ one uses a standard SFT-compactness argument by studying the 1-dimensional moduli spaces of disks taking c as input and sees that they split at infinity into two-level buildings of rigid disks corresponding to terms of ∂^2 . See [EL17, Ekh19] for details.

2.1.2. *Wrapped Floer cohomology.* The wrapped Floer cohomology of the co-cores C , denoted by $CW^*(C; W_\Lambda)$, is an A_∞ -algebra whose underlying module is freely generated by the Reeb chords of the Legendrian ∂C in the ideal contact boundary ∂W_Λ , along with one self-intersection point for each component of C . We here use the version of the wrapped Floer cohomology without Hamiltonian from [EL17, Appendix B]. The self-intersections arise from choosing a system of parallel copies of C , see [EL17, Section 3.3]. The A_∞ -operations μ_k are defined as follows. Write $\mu_k = \mu'_k + \mu''_k$ where μ' are the self-intersection point terms and μ'' are the Reeb chord terms. We define μ' on a word $a_k \dots a_1$ of generators of $CW^*(C; W_\Lambda)$ by counting rigid pseudo-holomorphic disks in W_Λ with boundary on C taking $a_k \dots a_1$ as input and outputting one intersection point. We call these disks *filling disks*. Here the disk has positive asymptotics at the Reeb chords a_i . Strictly speaking, the count is performed for a perturbation of C which gives rise to a single self-intersection in the interior of each component of C . If C is embedded, then these are the only self-intersection points. We define μ'' by counting *partial holomorphic buildings*. These are buildings consisting of one *primary disk* in $\mathbb{R} \times \partial W_\Lambda$ with boundary on $\mathbb{R} \times \partial C$ with some number of positive and negative punctures. The primary disk must have at least two negative Reeb chord asymptotics (if it is a single strip, then it is not of correct dimension). We call one of the negative punctures of the primary disk the *distinguished puncture* and consider it to be the output of the building. For each of the other negative punctures, the building also has a *secondary disk* in W_Λ which has boundary on C , with one puncture of the secondary disk converging to the corresponding output of the primary disk. For a word $a_k \dots a_1$ of generators of $CW^*(C; W_\Lambda)$ we then define $\mu''_k(a_k \dots a_1)$ by counting rigid (modulo translation along the \mathbb{R} -coordinate for the primary disk) partial holomorphic buildings, which have $a_k \dots a_1$ as input, i.e. positive asymptotics, when going counter-clockwise the around the entire building, starting at the distinguished puncture.

2.1.3. *The surgery and cobordism maps.* The Chekanov–Eliashberg algebra and the wrapped Floer cohomology are related by the surgery formula of Bourgeois–Ekholm–Eliashberg [BEE12] and Ekholm–Lekili [EL17].

Theorem 2.1 ([BEE12, EL17]). *There is an A_∞ -quasi-isomorphism*

$$\Phi_\Lambda : CW^*(C; W_\Lambda) \xrightarrow{\simeq} CE^*(\Lambda; W).$$

Proof. For $n > 1$, this is [EL17, Theorem 2]. For $n = 1$, it is a special case of Theorem 2.7 \square

The surgery map Φ_Λ is defined by considering the Weinstein cobordism $W_\Lambda^\circ = (\mathbb{R} \times \partial W)_\Lambda$, obtained by attaching Weinstein n -handles to the symplectization $\mathbb{R} \times \partial W$ at Λ , where Λ is viewed as living in the positive end of the $\mathbb{R} \times \partial W$. The ends of the cobordism are then $\partial_+ W_\Lambda^\circ = \partial W_\Lambda$ and

$\partial_- W_\Lambda^\circ = \partial\Lambda$. Each map

$$\Phi_\Lambda^k : CW^*(C; W_\Lambda)^{\otimes k} \rightarrow CE^*(\Lambda; W) \quad k > 0$$

of the A_∞ -homomorphism Φ_Λ is then defined by counting rigid pseudo-holomorphic cobordism disks in W_Λ° , as in Figure 4. For details, see [EL17].

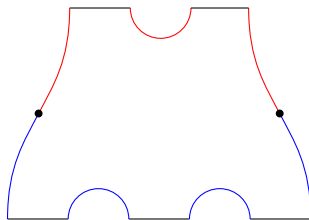

FIGURE 4. Example of a disk contributing to the output of Φ_Λ^2 . The black segments are boundary punctures converging to Reeb chords of Λ and ∂C . The red and blue segments are mapped to C and L respectively. The black dots are mapped to $C \cap L$.

Remark 2.2. Though not explicitly stated, it is clear from the proof given in [EL17] that when $n > 1$, the map is in fact an A_∞ -isomorphism, at least when restricted to the generators below any fixed action level. (The final map is defined as a limit of such maps.) This is not true when $n = 1$, the problem being that the low dimension makes all Reeb chords degenerate. However, it is still true that the map is a quasi-isomorphism, which we prove in Section 2.2.

There is a closely related result which we will call the cobordism formula. Consider a subset Π of the attaching spheres in Λ , and the Chekanov–Eliashberg algebra of $CE(\Lambda \setminus \Pi; W_\Pi)$ of the remaining part of Λ after attaching handles at $\Pi \subset \Lambda$. Note that $\Lambda \setminus \Pi$ is considered as a Legendrian inside the boundary of the Weinstein manifold W_Π .

Theorem 2.3. [BEE12, Theorem 5.1 when $n > 1$] *Let Π be a subset of the spheres in Λ . Then there is a dg-algebra morphism*

$$\Psi_\Pi : CE^*(\Lambda \setminus \Pi; W_\Pi) \rightarrow CE^*(\Lambda; W)$$

which is a quasi-isomorphism onto the subalgebra $CE^(\Lambda; W)[\Lambda \setminus \Pi, \Lambda \setminus \Pi]$, consisting of all word of Reeb chords whose initial and terminal vertices are both contained in $\Lambda \setminus \Pi$.*

Note that this theorem is true for all $n > 0$. To define Ψ_Π , we perform the same handle attachment on $\mathbb{R} \times \partial W$ as in the construction of the surgery map, but this time only for the subset Π of components of Λ . This results in a cobordism ∂W_Π° , with $\partial^+ W_\Pi^\circ = \partial W_\Pi$ and $\partial_- W_\Pi^\circ = \partial W$. We define an exact Lagrangian cobordism $L = \bigcup_{i \in I} L_i$ inside W_Π° , by letting $L_i = \Lambda_i \times [0, 1]$ for $\Lambda_i \in \Lambda \setminus \Pi$ and $L_i = \Lambda_i \times [0, 1] \cup L_{\Lambda_i}$ for $\Lambda_i \in \Pi$, where L_{Λ_i} is the core of the handle attached at Λ_i . We have $\partial_- L \subset \partial^- W_\Pi^\circ$ and $\partial_+ L = \Lambda \setminus \Pi \subset \partial^+ W_\Pi^\circ$. We then define

$$\Psi_\Pi : CE^*(\Lambda \setminus \Pi; W_\Pi) \rightarrow CE^*(\Lambda; W).$$

to be the standard Symplectic Field Theory cobordism map as defined in e.g [EGH00, Ekh08]. Its action on a chord $c \in CE^*(\Lambda \setminus \Pi; W_\Pi)$ is given by counting pseudo-holomorphic disks in W_Π° with boundary on L , taking c as input and which outputs a word in $CE^*(\Lambda; W)$.

A complete proof of Theorem 2.3 has yet to appear in the literature, but the proof sketched in [BEE12] is similar to the proof of Theorem 2.1 which is worked out in detail in [EL17, Appendix B][Ekh19]. It can also be reduced to Theorem 2.1 using the following proposition.

Proposition 2.4. *Up to homotopy, the following diagram of chain complexes commutes,*

$$\begin{array}{ccc} CW^*(C \setminus C_\Pi; W_\Lambda) & \xleftarrow{\iota} & CW^*(C; W_\Lambda) \\ \Phi_{\Lambda \setminus \Pi} \downarrow & & \downarrow \Phi_\Lambda \\ CE^*(\Lambda \setminus \Pi; W_\Pi) & \xrightarrow{\Psi_\Pi} & CE^*(\Lambda; W), \end{array}$$

where ι is the inclusion of generators.

Note again that this is true for all $n > 0$.

Proof. Each term of $\Phi_\Lambda \circ \iota$ corresponds to a disk in W_Λ° with boundary on L and $C \setminus C_\Pi$, and each term of $\Psi_\Pi \circ \Phi_{\Lambda \setminus \Pi}$ corresponds to a building consisting of one disk in $W_{\Lambda \setminus \Pi}^\circ$ with boundary on L and $C \setminus C_\Pi$ and several disks in W_Π° with boundary on L . These are in one-to-one correspondence by a standard SFT-stretching and gluing argument. More specifically, we stretch the neck around the contact type hypersurface ∂W_Π inside W_Λ where the latter cobordism is obtained by first attaching the handles in Π and then attaching the handles in $\Lambda \setminus \Pi$. \square

Proof of Theorem 2.3. It is clear by construction of the wrapped Floer complex that the inclusion $\iota : CW^*(C \setminus C_\Pi; W_\Lambda) \rightarrow CW^*(C; W_\Lambda)$ is an isomorphism onto the subcomplex of all chords without endpoints on the co-cores C_Π that correspond to the attaching spheres in Π . The surgery maps in Proposition 2.4 are quasi-isomorphisms by Theorem 2.1 and will send any chord with endpoints on a given pair of co-cores to a sum of words of Reeb chords whose initial and terminal vertices both are located on the corresponding attaching spheres of Λ . It thus follows that Ψ_Π is a quasi-isomorphism onto $CE^*(\Lambda; W)[\Lambda \setminus \Pi, \Lambda \setminus \Pi]$. \square

2.1.4. *Removal of Legendrians with exact idempotents.* The following is an algebraic lemma which we will make use of several times in the subsequent sections.

Lemma 2.5. *Let A be a semi-free dg-algebra, whose underlying associative algebra is the path algebra of a quiver Q with vertices Q_0 (the idempotents of A) and arrows Q_1 (the generators over the idempotent ring). Suppose that there for a vertex $i \in Q_0$ exists an element $a \in Q_1$ that satisfies $\partial a = e_i$, where e_i is the idempotent of i , such that a does not occur the differential of any other arrow. Let I be the ideal generated by all arrows with source or target on i . Then the projection*

$$A \rightarrow A/I$$

is a quasi-isomorphism.

Proof. Since A is an algebra over the idempotent ring, the differential will preserve the source and target of words. Therefore, I is a chain complex, and we have a short exact sequence

$$0 \rightarrow I \rightarrow A \rightarrow A/I \rightarrow 0,$$

of chain complexes. Let ∂ be the differential on I . There is a double complex structure $\partial = \bar{\partial}_a + \partial_a$, where ∂_a acts as ∂ on a and vanishes on all other arrows, and $\bar{\partial}_a = \partial - \partial_a$. If one considers the spectral sequence arising from this double complex with the ∂_a -cohomology on the first page, one sees that it vanishes. The complex I is thus exact and the result then follows by considering the long exact sequence in cohomology. \square

Remark 2.6. The special case in which we will use this is when $A = CE^*(\Lambda \cup \Pi; W)$ for some Legendrians Λ and Π , and there is a Reeb chord a such that $\partial a = e_\Pi$, which does not occur in the differential. Then A/I is isomorphic to $CE^*(\Lambda; W)$, and we thus have a quasi-isomorphism $CE^*(\Lambda \cup \Pi; W) \xrightarrow{\sim} CE^*(\Lambda; W)$.

2.2. The surgery formula for surfaces. As mentioned above, when $n = 1$, i.e. when the contact manifold is one-dimensional, one cannot perturb the Legendrian so that all Reeb chords are non-degenerate. It turns out that the bijection of the generators needed in the argument for the proof of Theorem 2.1 when $n > 1$ in [EL17] does not hold. It is therefore necessary to consider the cohomology of the algebras in more detail. In order to stay consistent with the next section, we here switch notation and denote the Weinstein manifold as V and the Legendrian in ∂V as $\partial\Lambda$.

We will also allow the Legendrian to consist of stops as well as 0-spheres. In this dimension that means that $\partial\Lambda$ is a finite set of points in ∂V that is partitioned into two-point 0-spheres and one-point stops. We then get a Weinstein sector $V_{\partial\Lambda}$ by attaching Weinstein 1-handles at the 0-spheres and half-handles at the stops. The stops should be thought of as singular Legendrian skeleta of 'degenerate' one-point Weinstein hypersurfaces in ∂V . Through their respective surgery formulas, the singular and smooth Chekanov–Eliashberg algebras correspond to wrapped and partially wrapped Floer cohomology, respectively. In higher dimensions they require separate treatments, the singular one being defined in terms of the smooth one. However, when $n = 1$ the theory for the 'singular' stops and the 'smooth' 0-spheres is essentially the same, and we will prove the surgery formula as one theorem. Write $CE^*(\partial\Lambda; V)$ for the Chekanov–Eliashberg algebra of $\partial\Lambda$ and $CW^*(C; V_{\partial\Lambda})$ for the partially wrapped Floer cohomology of the co-cores C produced by the surgery.

Theorem 2.7. *Let V be a Weinstein surface and $\partial\Lambda$ an embedded collection of 0-spheres and points, as described above. There is an A_∞ -quasi-isomorphism*

$$\Phi_{\partial\Lambda} : CW^*(C; V_{\partial\Lambda}) \xrightarrow{\sim} CE^*(\partial\Lambda; V).$$

To prove this, we begin by giving a combinatorial description of $CE^*(\partial\Lambda; V)$. The manifold V is a surface, so ∂V is a disjoint union of copies of \mathbb{S}^1 . There is one idempotent for each 0-sphere and stop. For each component of ∂V we pick a base point not in $\partial\Lambda$ and write c_{ij}^p for the Reeb chord which starts at $i \in \partial\Lambda$, ends at $j \in \partial\Lambda$, and passes through the base point p times.

Proposition 2.8. *Let $n = 1$. For a chord c_{ij}^p , let*

$$\partial_0(c_{ij}^p) = \sum \pm c_{kj}^p c_{ik}^{p-l}$$

with the sum taken over all k and l for which the chords on the right hand side exist. Let $\partial_{-1}(c_{ij}^p) = e_k$ if c_{ij}^p is a chord with $i = j$, $p = 1$, and which lives in the boundary of a simply connected component of V , where e_k is the corresponding idempotent of the component of i , and let $\partial_{-1}(c_{ij}^p) = 0$ otherwise. The differential ∂ of $CE^(\partial\Lambda; V)$ is then given by $\partial = \partial_0 + \partial_{-1}$.*

Proof. The terms ∂_0 and ∂_{-1} correspond to unanchored and anchored symplectization disks respectively, illustrated in Figure 5. Having more than one slit in the symplectization disk would result in it being non-rigid, and if an internal puncture were to wind more than once around the boundary, the anchor at the puncture would be non-rigid, as it would need to have a branch point. \square

Note that ∂_0 is action preserving, while ∂_{-1} is strictly action decreasing, and that $\partial_0^2 = \partial_{-1}^2 = \partial_0 \circ \partial_{-1} = \partial_{-1} \circ \partial_0 = 0$. We will compute the ∂_0 -cohomology of $CE^*(\partial\Lambda; V)$, for which we need some additional terminology.

Definition 2.9. Given two Reeb chords c_{ik}^p and c_{kj}^q of $\partial\Lambda$ whose endpoint and starting point agree, their *concatenation* is

$$c_{kj}^q * c_{ik}^p := c_{ij}^{p+q}.$$

A chord is called *short* if it is not the concatenation of any other chords. We also consider the idempotents to be short chords. Let $\mathbf{c} = c_{i_m j_m}^{p_m} \dots c_{i_1 j_1}^{p_1} \in A$ be a word of chords and let l_1, \dots, l_k be the subsequence $1, \dots, m-1$ of all l_h such that $j_{l_h} \neq i_{l_h+1}$. The *total concatenation*, \mathbf{c}_{tc} , of \mathbf{c} is the word

$$\mathbf{c}_{\text{tc}} := (c_{i_m j_m}^{p_m} * \dots * c_{i_{l_k+1} j_{l_k+1}}^{p_{l_k+1}}) \dots (c_{i_{l_1+1} j_{l_1+1}}^{p_{l_1+1}} * \dots * c_{i_{l_h} j_{l_h}}^{p_{l_h}}) \dots (c_{i_1 j_1}^{p_1} * \dots * c_{i_1 j_1}^{p_1})$$

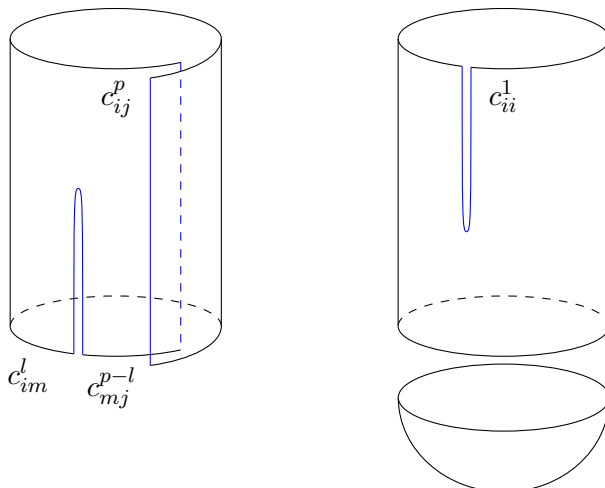

FIGURE 5. The two types of symplectization disks contributing to ∂ , with the unanchored disk to the right and the anchored disk to the left. The blue parts are the boundary segments of the disk which map to $\partial\Lambda \times \mathbb{R}$.

i.e. the word obtained by concatenating all adjacent chords in \mathbf{c} whose respective starting point and endpoint agree. The *total splitting*, \mathbf{c}_{ts} , of \mathbf{c} is the unique word consisting only of short chords such that $(\mathbf{c}_{\text{ts}})_{\text{tc}} = \mathbf{c}_{\text{tc}}$, i.e. the word obtained by splitting the chords of \mathbf{c} into two whenever they pass a point of $\partial\Lambda$. A word \mathbf{c} is called *unconcatable* if $\mathbf{c} = \mathbf{c}_{\text{tc}}$.

Lemma 2.10. *The residue classes of the unconcatable words which only consist of short chords, i.e. words \mathbf{c} with $\mathbf{c} = \mathbf{c}_{\text{tc}} = \mathbf{c}_{\text{ts}}$, form a basis of $H^*(CE(\partial\Lambda; V), \partial_0)$.*

Proof. Let \mathbf{c} be a word in $CE^*(\partial\Lambda; V)$, and let $C(\mathbf{c})$ be span of all words \mathbf{c}' such that $\mathbf{c}'_{\text{tc}} = \mathbf{c}_{\text{tc}}$. This subspace is ∂_0 -invariant. Let k be the number of concatenation points of \mathbf{c}_{ts} and note that $k = 0$ if and only if \mathbf{c} is an unconcatable word of short chords. In this case, ∂_0 vanishes on $C(\mathbf{c})$. On the other hand, if $k > 0$, then one can readily compute that $C(\mathbf{c})$ is as a chain complex isomorphic to the tensor product of k copies of the exact complex

$$0 \longrightarrow \mathbf{k} \xrightarrow{\sim} \mathbf{k} \longrightarrow 0$$

and since we are working over a field, it then follows from the Künneth formula that $C(\mathbf{c})$ itself is exact. The result follows. \square

We next compute the cohomology of $CW^*(C; V_{\partial\Lambda})$.

Lemma 2.11. *Suppose that $n = 1$ and let C' be the set of all null-homotopic components of C . By null-homotopy we mean a contraction of the component keeping the endpoints in $\partial V_{\partial\Lambda}$. Then the inclusion,*

$$CW^*(C \setminus C'; V_{\partial\Lambda}) \rightarrow CW^*(C; V_{\partial\Lambda})$$

is a quasi-isomorphism, and moreover, μ_1 vanishes on $CW^(C \setminus C'; V_{\partial\Lambda})$.*

Proof. If a component is null-homotopic, it will together with some segment of the boundary form a contractible loop, which bounds some simply connected subset of $V_{\partial\Lambda}$. This boundary segment is a Reeb chord c of ∂C . There is then by the Riemann mapping theorem a unique holomorphic disk which takes c as input, and by definition of the differential this disk will output the self-intersection point corresponding to the null-homotopic component. The self-intersection points act as idempotents in $CW^*(C; V_{\partial\Lambda})$, so it follows that the inclusion is a quasi-isomorphism.

To show that μ_1 vanishes on $CW^*(C \setminus C'; V_{\partial\Lambda})$, we first note that there are no intersection points between the different cores, while the differential vanishes on the idempotents (which can be though

of as the unique self-intersection points of a small push off). If there is a Reeb chord c such that $\mu'_1(c) \neq 0$, then c must begin and end at the same component. Since the output is non-zero, there will be a filling disk taking c as input which outputs an intersection point. This filling disk then gives rise to a null-homotopy of the component at which c has its endpoints. On the other hand, if $\mu''_1(c) \neq 0$, there will be a partial holomorphic building taking c as input, which outputs some Reeb chord. In order for the primary disk of this building to be rigid, it must have one positive puncture and two negative punctures. The building must therefore have a secondary filling disk with a single puncture meeting one of the two negative punctures of the primary disk. This disk then induces a null-homotopy of one of the components which the input has an endpoint on. \square

We now have everything we need to prove the surgery formula.

Proof of Theorem 2.7. Recall that an A_∞ -morphism consists of an infinite sequence of morphisms $\Phi_{\partial\Lambda}^i$. This sequence of maps was defined in [EL17] by counting cobordism disks. Since an A_∞ -morphism is a quasi-isomorphism if and only if the chain map $\Phi_{\partial\Lambda}^1$ is a quasi-isomorphism of complexes, we will in the following restrict our attention to this map and denote it by $\Phi_{\partial\Lambda}$ for simplicity. We define the *action* of a chord in the boundary of V , $V_{\partial\Lambda}$, or $V_{\partial\Lambda}^\circ$ to be the integral of the contact form along the chord. We define the *limit action* of a chord to be the limit of its action when the handles and half-handles are shrunk. Chords at different stages of the shrinking process can be canonically identified, so this is well-defined. It follows from Stokes' theorem that this limit action is a filtration with respect to the differentials of $CW^*(C; V_{\partial\Lambda})$ and $CE^*(\partial\Lambda; V)$, and that $\Phi_{\partial\Lambda}$ is filtration preserving.

We write $\Phi_{\partial\Lambda} = \Phi'_{\partial\Lambda} + \Phi''_{\partial\Lambda}$, where for each chord $c \in CW^*(C; V_{\partial\Lambda})$, the term $\Phi_{\partial\Lambda}(c)'$ consists of the words in $\Phi_{\partial\Lambda}(c)$ of limit action equal to that of c , and $\Phi''_{\partial\Lambda}(c)$ consists of the words of strictly lower limit action. Again by Stokes' theorem, $\Phi'_{\partial\Lambda}$ and $\Phi''_{\partial\Lambda}$ are the parts of $\Phi_{\partial\Lambda}$ corresponding to unanchored and anchored cobordism disks respectively.

We will view $\Phi'_{\partial\Lambda}$ as going between the chain complexes $CW^*(C; V_{\partial\Lambda})$ and $CE^*(\partial\Lambda; V)$ equipped with the limit action preserving part of their differentials. This limit action preserving part vanishes for $CW^*(C; V_{\partial\Lambda})$ and for $CE^*(\partial\Lambda; V)$ it is the differential ∂_0 from above. We will show that with respect to these differentials, $\Phi'_{\partial\Lambda}$ is a quasi-isomorphism.

Let $u : D^2 \setminus \{z_1, \dots, z_k\} \rightarrow V_\Lambda^\circ$ be a rigid unanchored cobordism disk, as in the definition of $\Phi_{\partial\Lambda}$. We claim that no interior points of $D^2 \setminus \{z_1, \dots, z_k\}$ get mapped to L . This is indeed the case: The curve u will be a branched cover and the rigidity of u implies that there are no branch points. The preimage $u^{-1}|_{\text{int}D^2}(L)$ of the curve will thus be a smoothly embedded curve in D^2 , which will then either be a closed loop, or have endpoints at two of the negative punctures, as illustrated in Figure 6. The first situation is impossible as u has no critical points and thus is a

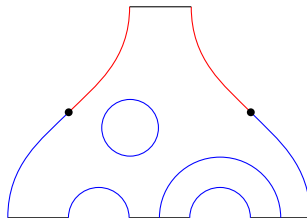

FIGURE 6. The preimage of L under $u|_{\text{int}D^2}$ will be a smooth curve whose components are either closed or have endpoints at two negative punctures.

locally injective immersion. The second situation is also impossible. This is because the half-annulus region in Figure 6 bounded by the preimage curve and the boundary will have negative area by Stokes' theorem. Thus, u cannot map any interior points to L .

We can therefore consider u as a map to the surface $\tilde{V}_{\partial\Lambda}^\circ$ obtained from 'opening up' $V_{\partial\Lambda}^\circ$ along L and inserting two boundary components. (Topologically this is the same as removing a small open

neighborhood of L .) The universal cover of $\tilde{V}_{\partial\Lambda}^\circ$ is a disjoint union of surfaces as illustrated in the center of Figure 7, either continuing indefinitely, or ending at a half-handle as to the left or right in the figure. Chords of C correspond to segments of the upper component of the boundary, and unconcatable words of short chords of Λ correspond to segments of the bottom component of the boundary, shown in the aforementioned image. It thus follows from the Riemann mapping theorem that $\Phi'_{\partial\Lambda}$ is a bijection from the set of Reeb chords on C onto the set of unconcatable words of short chords, and is hence a quasi-isomorphism by Lemma 2.10.

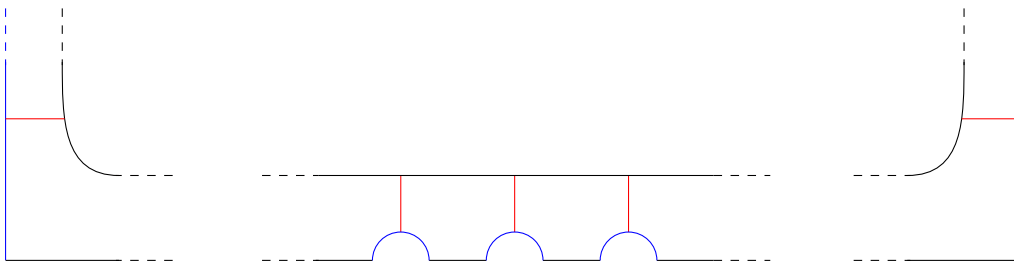

FIGURE 7. The universal cover of $\tilde{V}_{\partial\Lambda}^\circ$ consists of a disjoint union of surfaces as in the center, either continuing indefinitely, or stopping at half-handle as to the left and right.

Finally, we consider the mapping cone $\text{Cone}(\Phi_{\partial\Lambda})$ of $\Phi_{\partial\Lambda}$. Since $\Phi_{\partial\Lambda}$ preserves the filtration, $\text{Cone}(\Phi_{\partial\Lambda})$ inherits the limit action filtration. Considering the spectral sequence arising from this filtration, one sees that the first page is isomorphic to $\text{Cone}(\Phi'_{\partial\Lambda})$. Since $\Phi'_{\partial\Lambda}$ is a quasi-isomorphism, the spectral sequence vanishes on the second page, making $\Phi_{\partial\Lambda}$ a quasi-isomorphism. \square

Using the above, we can now prove Theorem 1.2 from the introduction.

Proof of Theorem 1.2. The assumption that no co-core is null-homotopic guarantees that ∂ vanishes on the short chords and hence they are all cycles. If we then consider the inclusion of the chain complex of the unconcatable words of short chords into $CE^*(\partial\Lambda; V)$, this is by Lemma 2.10 a quasi-isomorphism on the action preserving level, and the differential is action decreasing, so it follows that it is a quasi-isomorphism onto the full chain complex (consider the mapping cone of the inclusion, filter by action, and take the spectral sequence of this filtration). This shows that the unconcatable words of short chords form a basis of $H^*CE(\partial\Lambda; V)$.

The multiplication is induced by the multiplication on $CE^*(\partial\Lambda; V)$, and comes from the cycle $\partial(c_2 * c_1) = c_2c_1 + \partial_{-1}(c_2 * c_1)$. Since the differential of $CW^*(C; V_{\partial\Lambda})$ is zero in view of Lemma 2.11 (by the assumption that no co-cores are null-homotopic) the higher operations can be obtained using Theorem 2.1. They have been described combinatorially in [HKK17], and are also easy to see in our setup. If one takes a filling disk and shrinks the handles, its input and output will converge to a word whose total concatenation goes once around the boundary of V . When the number of inputs of a partial holomorphic building is greater than two, the symplectization disk can only have one positive puncture, as it would otherwise be non-rigid. There exists such a rigid unanchored symplectization disk taking a chord c as input and outputting a word c_2c_1 if and only if $c = c_2 * c_1$. Since any handle attachment results in a space not homeomorphic to a disk, the symplectization disks do not have any anchors. Taken together, these observations give the desired result. See Figure 8.

Finally, the last statement follows from Lemma 2.11 and Proposition 2.4 combined with the fact that the horizontal arrows in Proposition 2.4 are quasi-isomorphisms by Theorem 2.1. \square

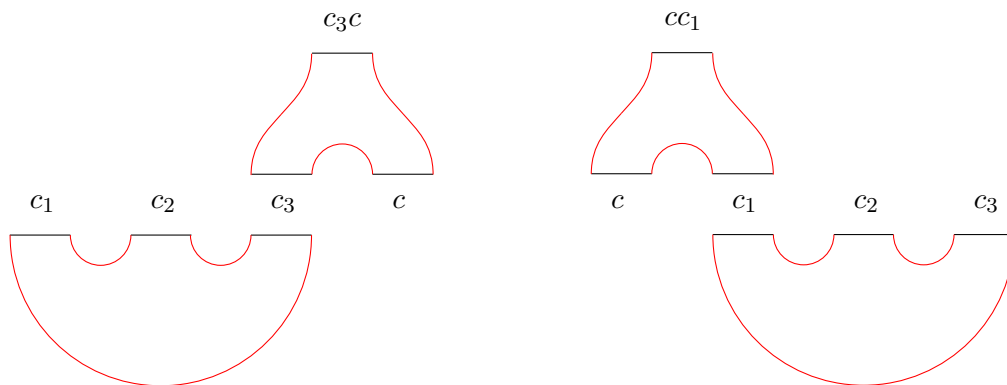
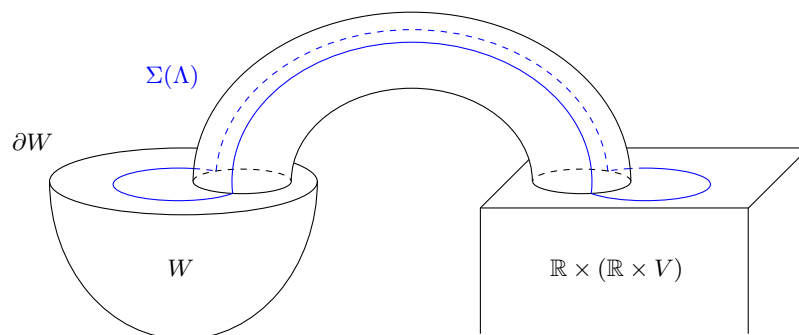

FIGURE 8. The partial holomorphic buildings contributing to the higher operations.

3. CHEKANOV–ELIASHBERG ALGEBRAS FOR SINGULAR LEGENDRIANS

In this section, we give an overview of the Asplund–Ekholm construction of the Chekanov–Eliashberg dg-algebra for singular Legendrians, and how to compute it in \mathbb{R}^3 using the combinatorial description by An–Bae [AB20]. The definition immediately gives singular versions of the surgery and cobordism maps for smooth Legendrians. We also review the singular Legendrian Reidemeister moves and the Ng resolution.

3.1. Chekanov–Eliashberg algebras for singular Legendrians. This material follows [AE22], to which we refer for details. Let W be a $2n$ -dimensional Weinstein manifold, and let $V \subset \partial W$ be a $(2n - 2)$ -dimensional Weinstein hypersurface. We will also allow the case $W = B^{2n} \setminus \text{pt}$ for some $\text{pt} \in \partial B^{2n} = S^{2n-1}$. The latter corresponds to the Weinstein manifold with a stop at a point in the boundary, and $\partial W = \mathbb{R}^{2n+1}$ can be identified with the standard contact vector space, i.e. the standard contact Darboux ball. We denote the singular Legendrian skeleton of V as Λ , and write V_0 for the subcritical part of V and $\partial\Lambda \subset \partial V_0$ for the Legendrian attaching spheres in the handle decomposition of V . We construct a cobordism W_V^0 as follows. Let $D_\epsilon^*[-1, 1]$ be an ϵ -disk subbundle of $T^*[-1, 1]$. Then W_V^0 is obtained by attaching the handle $V_0 \times D_\epsilon^*[-1, 1]$ to $W \sqcup (\mathbb{R} \times (\mathbb{R} \times V))$ along $V_0 \times D_\epsilon^*[-1, 1] |_{\{-1, 1\}} \subset \partial W \sqcup (\mathbb{R} \times V)$. We have $\partial_- W_V^0 = \mathbb{R} \times V$. We construct a smooth Legendrian link Σ of n -spheres in ∂W_V^0 by joining the two copies of the top strata $\Lambda \setminus V_0$ in ∂W and $\mathbb{R} \times V$ across the handle by $\partial\Lambda \times [-1, 1]$, as shown in Figure 9. For each Legendrian handle Π in Λ we denote the corresponding Legendrian attaching sphere by $\Sigma(\Pi) \subset \Sigma$.

FIGURE 9. The cobordism W_V^0 in the Asplund–Ekholm construction.

Definition 3.1 ([AE22, Definition 3.2]). The *singular Chekanov–Eliashberg dg-algebra* of Λ in ∂W , denoted by $CE^*(\Lambda; V_0; W)$, is the ordinary smooth Chekanov–Eliashberg algebra as in Section 2.1 of Σ in ∂W_V^0 , i.e.

$$CE^*(\Lambda; V_0; W) := CE^*(\Sigma; W_V^0).$$

Lemma 3.2 ([AE22]). *The Chekanov–Eliashberg algebra $CE^*(\Lambda; V_0; W)$ contains $CE^*(\partial\Lambda; V_0)$ as a dg-subalgebra.*

Proof. See [AE22, Section 3.3]. □

The definition immediately gives an analogue of the surgery formula for singular Legendrians. We write $W_V := W_{V, \Sigma}^0$ for the Weinstein manifold obtained by handle attachment to W_V^0 to along Σ , and denote the co-cores of W_V as C .

Theorem 3.3 ([AE22, Theorem 1.1]). *There is an A_∞ -quasi-isomorphism*

$$CE^*(\Lambda; V_0; W) \xrightarrow{\sim} CW^*(C; W_V).$$

Proof. Follows from Theorem 2.1 and the definition of $CE^*(\Lambda; V_0; W)$. □

This surgery formula is the same as the one in [EL17, Conjecture 3] [Syl19]. The wrapped Floer cohomology of W_V , can equivalently be thought of as the partially wrapped Floer cohomology of W stopped at V .

Remark 3.4. A smooth Legendrian Λ can be considered as a singular Legendrian with a single top handle, and the singular Chekanov–Eliashberg algebra is then quasi-isomorphic to the Chekanov–Eliashberg algebra with based loop space coefficients, see [AE22, Theorem 1.2, Section 4].

We will also consider a relative version of the algebra.

Definition 3.5. Let $\Pi \subset \Lambda$ be a subset of the Legendrian cores of the top handles of V . Let $W_{V, \Sigma(\Pi)}^0$ be the cobordism obtained by handle attachment along $\Sigma(\Pi)$ in W_V^0 . The Chekanov–Eliashberg algebra of $\Lambda \setminus \Pi$ *relative* Π is

$$CE^*(\Lambda \setminus \Pi; V_{0, \partial\Pi}; W) := CE^*(\Sigma \setminus \Sigma_\Pi; W_{V, \Sigma_\Pi}^0).$$

This is a slightly different and less general construction than in [AE22, Section 6.1]. However, since there are no Reeb chords in the negative part of $\partial W_{V, \Sigma(\Pi)}^0$ that corresponds to $V \times \mathbb{R}$, and no pseudo-holomorphic curves can enter there ([AE22, Lemma 3.5]), it results in an isomorphic algebra. This definition gives an analogue of the cobordism map.

Theorem 3.6. *There is a dg-algebra morphism*

$$CE^*(\Lambda \setminus \Pi; V_{0, \partial\Pi}; W) \rightarrow CE^*(\Lambda; V_0; W)$$

which is a quasi-isomorphism onto $CE^(\Lambda; V_0; W)[\Lambda \setminus \Pi, \Lambda \setminus \Pi]$.*

Proof. Follows from Theorem 2.3 and the definition of $CE^*(\Lambda; V_0; W)$ and $CE^*(\Lambda \setminus \Pi; V_{0, \partial\Pi}; W)$. □

As suggested by the notation, there is also a relative version of Lemma 3.2.

Lemma 3.7 ([AE22]). *The Chekanov–Eliashberg algebra $CE^*(\Lambda \setminus \Pi; V_{0, \partial\Pi}; W)$ contains $CE^*(\partial\Lambda \setminus \partial\Pi; V_{0, \partial\Pi})$ as a dg-subalgebra.*

Proof. See [AE22, Section 3.3]. □

Asplund–Ekholm give a surgery presentation of this algebra. Since Theorem 2.3 fails to be an isomorphism for $n = 2$ this case needs to be treated separately.

Lemma 3.8 ([AE22, Proposition 6.2]). *For $n > 2$, the algebra $CE^*(\Lambda \setminus \Pi; V_0, \partial\Pi; W)$ is generated by composable words of Reeb chords of Λ in ∂W and $\partial\Lambda$ in V_0 , without an endpoint on Π or $\partial\Pi$. The subalgebra $CE^*(\partial\Lambda \setminus \partial\Pi; V_0, \partial\Pi)$ is generated by composable words of Reeb chords of $\partial\Lambda$ in V_0 , without endpoints on $\partial\Pi$. For $n = 2$, the algebra is quasi-isomorphic to the algebra described above, and isomorphic to the algebra generated by composable words of Reeb chords of Λ in ∂W and $\partial\Lambda \setminus \partial\Pi$ in $V_0, \partial\Pi$, without an endpoint on Π .*

3.2. The singular algebra in \mathbb{R}^3 . In [AE22, Section 7.1], Asplund–Ekholm show that in \mathbb{R}^3 , their invariant is isomorphic to the combinatorial version by An–Bae in [AB20]. We will use this below, and give a brief summary of the method.

Let $V \subset \mathbb{R}^3$ be a Weinstein hypersurface and let $\pi : \mathbb{R}^3 \rightarrow \mathbb{R}^2$, $(x, y, z) \rightarrow (x, y)$ be the Lagrangian projection. We assume that V is in generic position so that $\pi|_{V_0}$ is an embedding and let $\mathbb{R}^{2,\circ} := (\mathbb{R}^2 \setminus \pi(V_0)) \sqcup_{\partial V_0} (\partial V_0 \times (-\infty, 0])$, i.e. the surface obtained by cutting out the image of the subcritical part of the hypersurface and attaching the negative end of the symplectization of ∂V_0 instead. The image $\tilde{\Lambda} := \pi(\Lambda \setminus (\Lambda \cap V_0))$ of the cores of the top handles of V forms an exact Lagrangian, with negative end $\partial\Lambda$ in $\partial_- \mathbb{R}^{2,\circ} \cong \partial V_0$.

We can then consider the version of the Legendrian dg-algebra $CE^*(\tilde{\Lambda}; \mathbb{R} \times \mathbb{R}^{2,\circ})$ as described by An–Bae [AB20]. It is generated by double points of $\tilde{\Lambda}$ and Reeb chords of $\partial\Lambda$, and its differential is given by counting disks in $\mathbb{R}^{2,\circ}$ with boundary on $\tilde{\Lambda}$, whose punctures converge to either a double point or to a chord in the boundary, similarly to in the classical Chekanov–Eliashberg algebra of smooth knots in \mathbb{R}^3 .

The grading is easiest to compute in the front projection. Let S be the subset of Λ consisting of all singularities along with the points which are cusps in the front (i.e. the points with y -coordinate zero). We choose a *Maslov potential* $m : \Lambda \setminus S \rightarrow \mathbb{Z}$, such that m is locally constant on $\Lambda \setminus S$, and increases with one when we pass an up cusp and decreases with one when we pass a down cusp. The degree of Reeb chord a of Λ with starting point a^- and endpoint a^+ then has grading $|a| = -m(a^+) + m(a^-)$. The chords of c_{ij}^p of Λ are graded by $|c_{ij}^p| = q + 1 + (-m(j) + m(i))$, where q is the number of times c_{ij}^p passes through the z -axis in the front (or equivalently, the y -axis in the Lagrangian projection).

Proposition 3.9. *There is an isomorphism of dg-algebras,*

$$CE^*(\tilde{\Lambda}; \mathbb{R} \times \mathbb{R}^{2,\circ}) \cong CE^*(\Lambda; V_0; \mathbb{R}^4)$$

Proof. This is a special case of [AE22, Lemma 7.1]. □

We give an example of how to compute the algebra. It is adapted from [AB20, Section 4.6.2].

Example 3.10. Let Λ be the singular Legendrian illustrated in Figure 10. It has six Reeb chords a_1, a_2, b, c_1, c_2 , and d , and an infinite number of chords t_{ij}^p of $\partial\Lambda$. We label the points of $\partial\Lambda$ as 1, 2, 3, 4, going counter-clockwise from the top. Giving the strands of the front projections Maslov potentials as shown in Figure 10, we get the degrees

$$\begin{aligned} |a_1| &= -1, & |c_1| &= -1, \\ |a_2| &= -1, & |c_2| &= 1, & |t_{ij}^p| &= -2p + 1. \\ |b| &= -1, & |d| &= 0, \end{aligned}$$

Counting the disks in the Lagrangian projection we get the differential,

$$\begin{aligned} \partial a_1 &= c_1 c_2 t_{12}^0 + t_{12}^0 + e_1, & \partial c_1 &= 0, \\ \partial a_2 &= d c_2 c_1 + t_{23}^0 c_1 + d + e_2, & \partial c_2 &= 0, \\ \partial b &= d t_{34}^0 + e_2, & \partial d &= 0, \end{aligned}$$

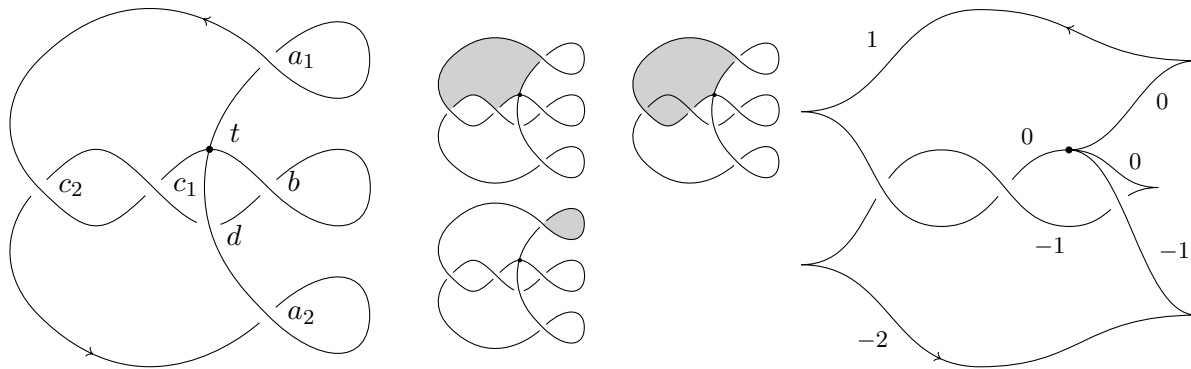

FIGURE 10. To the left is the Lagrangian projection of a singular Legendrian Λ . In the center are the disks contributing to ∂a_1 . To the right is the front projection, with a choice of Maslov potential.

and as before

$$\partial t_{ij}^p = \sum_{k,l} t_{kj}^{p-l} t_{ik}^l.$$

The disks contributing to ∂a_1 are illustrated in the Figure 10.

3.3. Weinstein isotopy and invariance. There are two notions of isotopy of V . The first is *Weinstein isotopy*, which is a smooth isotopy (not necessarily preserving the contact distribution) of V through Weinstein hypersurfaces, see [Eli18]. For a generic Weinstein isotopy, the skeleton undergoes an isotopy, together with handle-slides and introduction and contraction of handles. See Figure 12. The second notion is that of *Legendrian isotopy* of a Weinstein skeleton, which is an ambient contact isotopy of this singular Legendrian. In particular, a Legendrian isotopy of a Weinstein skeleton induces a Weinstein isotopy of the corresponding thickening, preserving the handle decomposition. Recall that any Weinstein hypersurface has a naturally defined skeleton that is independent of the contact form; see [Eli18, Section 2]. The important difference between these notions is that the quasi-isomorphism type of $CE^*(\Lambda; V_0; W)$ is invariant under Legendrian isotopy, but not Weinstein isotopy.

Theorem 3.11 (Asplund–Ekholm [AE22]). *The Chekanov–Eliashberg algebra $CE^*(\Lambda; V_0; W)$ is up to quasi-isomorphism invariant under Legendrian isotopy of Λ .*

Proof. See [AE22, Section 2.1]. Legendrian isotopies of V induce Legendrian isotopies of the link Σ in the definition of $CE^*(\Lambda; V_0; W)$, so the result follows from the isotopy invariance of the Chekanov–Eliashberg algebra for smooth Legendrians. \square

Remark 3.12. For $\partial W = \mathbb{R}^3$, An–Bae have introduced the stronger notion of *generalized stable tame isomorphism* and shown that two singular Legendrian knots in \mathbb{R}^3 are Legendrian isotopic if and only if their Chekanov–Eliashberg algebras are generalized stable tame isomorphic [AB20, Theorem 5.1].

Below we will explore several concrete examples of how invariance fails for Weinstein isotopies. Also see [AE22, Examples 7.4 and 7.5]. A Weinstein isotopy will typically alter the handle decomposition of W_V . Since the co-cores C generate the wrapped Fukaya category $\mathcal{W}(W_V)$ [CDGG17, GPS18] one expects the category $\text{Perf}(CE^*(\Lambda; V_0; W))$ of perfect complexes of dg-modules, i.e. semi-free dg-modules over $CE^*(\Lambda; V_0; W)$, to be invariant up to quasi-equivalence under Weinstein isotopy. See also [AE22, Remark 1.5].

When $\partial W = \mathbb{R}^3$, one can see that the algebra changes in a predictable way when performing a handle contraction.

Corollary 3.13. *Let $V \subset \mathbb{R}^3$ be a Weinstein hypersurface with skeleton Λ and let $V' \subset \mathbb{R}^3$ be a Weinstein isotopic hypersurface with skeleton Λ' , obtained by performing a Legendrian isotopy and contracting a single handle Π of V as in Figure 12. Then there is a dg-algebra morphism*

$$CE^*(\Lambda'; V'_0; \mathbb{R}^4) \rightarrow CE^*(\Lambda; V_0; \mathbb{R}^4)$$

which is a quasi-isomorphism onto $CE^(\Lambda; V_0; \mathbb{R}^4)[\Lambda \setminus \Pi, \Lambda \setminus \Pi]$.*

Proof. By Theorem 3.11, Legendrian isotopy preserves the quasi-isomorphism type, so we need only consider the handle contraction. It follows from Proposition 3.9 and Lemma 3.8 that $CE^*(\Lambda'; V'_0; \mathbb{R}^4)$ is isomorphic to the relative algebra $CE^*(\Lambda \setminus \Pi; V_{0, \partial \Pi}; \mathbb{R}^4)$, and by Theorem 3.6 there is a dg-algebra morphism $CE^*(\Lambda \setminus \Pi; V_{0, \partial \Pi}; \mathbb{R}^4) \rightarrow CE^*(\Lambda; V_0; \mathbb{R}^4)$ which is a quasi-isomorphism onto $CE^*(\Lambda; V_0; \mathbb{R}^4)[\Lambda \setminus \Pi, \Lambda \setminus \Pi]$. The result follows. \square

3.4. Reidemeister moves and the Ng resolution. In \mathbb{R}^3 , there are versions of the Reidemeister moves for singular Legendrians, extending the moves for smooth Legendrians introduced in [Sa92].

Proposition 3.14 ([BI09]). *Two singular Legendrians in \mathbb{R}^3 are Legendrian isotopic (after deforming the angles of the strands at the singular points) if and only if their front diagrams are related by a sequence of planar isotopies and singular Legendrian Reidemeister moves as shown in Figure 11.*

Proof. See [BI09, Section 4]. \square

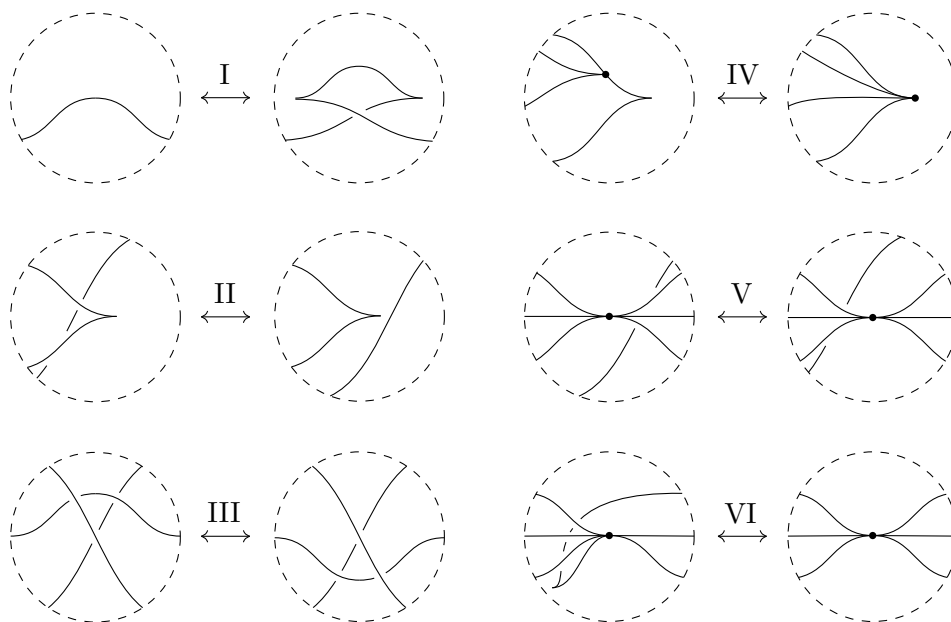

FIGURE 11. The singular Legendrian Reidemeister moves, introduced in [BI09]. Reflections of these moves, with the crossings adjusted accordingly, are also allowed. In the moves involving singularities, any number of strands are allowed.

Remark 3.15. The set of moves in Figure 11 is not minimal; IV is a special case of VI.

There is an analogous result for Weinstein isotopies.

Proposition 3.16. *Two singular Legendrians in \mathbb{R}^3 have Weinstein isotopic thickenings if and only if their front diagrams are related by a sequence of planar isotopies, singular Legendrian Reidemeister moves as shown in Figure 11, and Weinstein handle introductions and contractions as shown in Figure 12.*

Remark 3.17. The set of moves in Figure 12 is not minimal either; any one of the three types of moves can be obtained from any other by composing with Legendrian isotopies.

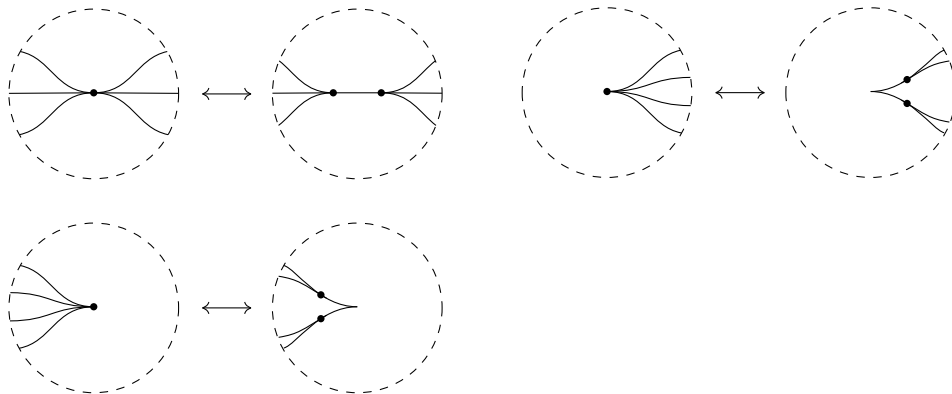

FIGURE 12. Introduction and contraction of Weinstein handles. The singularities can have any valency, including zero.

Proof. We first prove that the moves applied to the skeleton can be realized by a Weinstein isotopy of the thickening. Consider a small deformation of a singular Legendrian Λ^0 with thickening V^0 by one of the moves in Figure 12 to produce a singular Legendrian Λ^1 . A sufficiently small thickening may be assumed to be Weinstein for the restriction λ^0 of the standard contact form $dz - ydx$ (see [CE12, Lemma 12.1]). One can readily find a smooth deformation $\lambda^1 = \lambda^0 + dh_t$ of the Liouville form of the thickening V^0 of the original skeleton that induces a family of Weinstein structures that connects Λ^0 to Λ^1 . We can now deform V^0 to V^1 simply by adding the function h_t to its z -coordinate.

We now conversely show that a generic Weinstein isotopy can be assumed to induce a deformation of the skeleton that can be realized by the moves. For a Weinstein isotopy (V^t, λ^t, ϕ^t) for which ϕ^t remains Morse, one can readily deform the skeleton so that it is induced by an ambient contact isotopy. One can perform an explicit deformation near the 0-skeleton to ensure that there is an ambient contact isotopy that induces that deformation. One can then deform the remaining part of the skeleton by using the standard result that a Legendrian isotopy is induced by an ambient contact isotopy (see [Gei08]). Such deformations are induced by the Reidemeister moves.

A generic Weinstein isotopy consists of generic times when ϕ^t remains Morse, together with a finite number of singular moments that are handle-slides, or births or deaths. Note that both these singular moments can be realized by the moves from Figure 12 together with a Legendrian isotopy. The statement follows from this. \square

Since one typically computes the Chekanov–Eliashberg algebra in the Lagrangian projection but constructs isotopies in the front projection, it is useful to be able to go back and forth between them. This is done using the so called Ng resolution, which was introduced by Ng for smooth Legendrians in [Ng03] and generalized to singular Legendrians by An–Bae–Su in [ABS22a].

Definition 3.18. Let $\Lambda \subset \mathbb{R}^3$ be a singular Legendrian. The *Ng resolution* of Λ is the singular Legendrian whose Lagrangian projection (up to an isotopy of \mathbb{R}^2 which corrects the areas bounded by the different regions in the projections and the angles of the strands at the singular points) is obtained by performing the operations illustrated in Figure 13 to the front diagram of Λ .

Proposition 3.19 ([ABS22a]). *The Ng resolution is well defined in the sense that, after a planar isotopy, the Lagrangian projection indeed lifts to a Legendrian. Moreover, every singular Legendrian in \mathbb{R}^3 is Legendrian isotopic to its Ng resolution after deforming the angles at the singularities.*

Proof. This is [ABS22a, Lemma 2.2.16]. \square

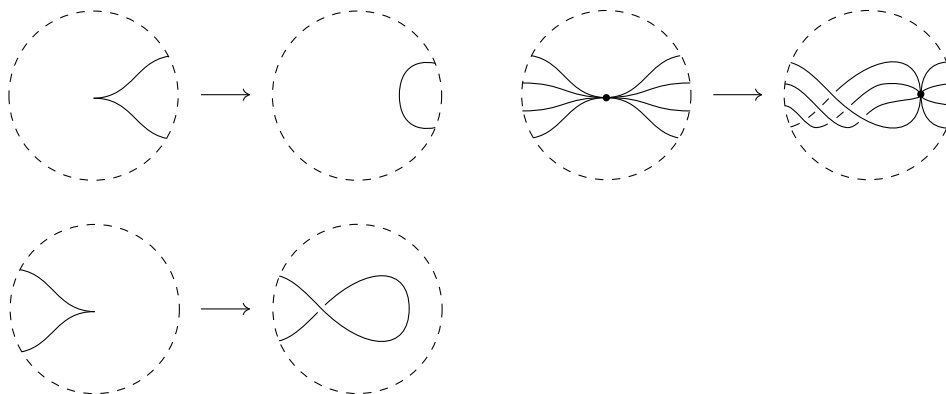

FIGURE 13. Obtaining the Lagrangian projection of an isotopic Legendrian from the front projection. In the operation to the upper right, the singularity is allowed to have any valency, and the operation consists of performing a twist of the strands to left of the singularity.

4. STOPPED SUBALGEBRAS

In this section we prove our main result, which provides simplified models of the singular Chekanov–Eliashberg algebra in \mathbb{R}^3 .

4.1. Bordered Legendrians. We will be working with bordered Legendrians, of which we here give an overview. A more detailed account of this topic can be found in [ABS22a].

Definition 4.1. A *bordered Legendrian* in \mathbb{R}^3 is a subset $\Gamma \subset \mathbb{R}^3$ of the form $\Gamma = \Lambda \cap \{x \in \mathbb{R}^3 : |x| \leq M\}$ where Λ is a proper embedding of a singular Legendrian skeleton of a Weinstein hypersector $V \subset \mathbb{R}^3$ such that for $|x| \geq M$, each point of Λ has y -coordinate equal to 0 (possibly with finitely many two-valent singularities). If Λ does not have any singularities inside $\{x \in \mathbb{R}^3 : |x| \leq M\}$ we call Γ *smooth* and otherwise we say that Γ is *singular*. If $\{x \in \mathbb{R}^3 : x = -M\} \cap \Gamma = \emptyset$ or $\{x \in \mathbb{R}^3 : x = M\} \cap \Gamma = \emptyset$ we say that Γ has no *left ends* or *right ends*, respectively.

Definition 4.2. Let Γ be a bordered Legendrian with no left ends. Let Λ' be the singular Legendrian obtained by closing up the left ends of Γ into a singularity consisting of a single 0-cell, as shown to the left in Figure 14. Let V' be the thickening of Λ' to a Weinstein surface with skeleton Λ' . The *bordered Chekanov–Eliashberg algebra* of Γ , denoted by $CE^*(\Gamma; V_0; \mathbb{R}^4)$, is the unital dg-subalgebra of the Chekanov–Eliashberg algebra $CE^*(\Lambda'; V'_0; \mathbb{R}^4)$ generated by all chords which through the Ng resolution correspond to crossings in the front of Γ , and the chords of $\partial\Lambda'$ which belong to singularities of Γ .

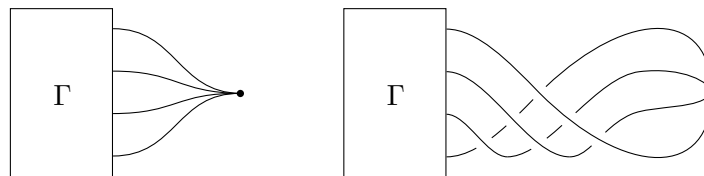

FIGURE 14. The closure Λ' of Λ , illustrated in the front projection to the left and the Lagrangian projection to the right.

Lemma 4.3. *The algebra $CE^*(\Gamma; V_0; \mathbb{R}^4)$ is well-defined in the sense that it is closed under the differential.*

Proof. Using the Ng resolution, one sees that the chords of Λ' which are excluded from $CE^*(\Gamma; V_0; \mathbb{R}^4)$ are all of higher action than the ones included, and can therefore not occur in the differential of any chord in $CE^*(\Gamma; V_0; \mathbb{R}^4)$. The chords of $\partial\Lambda'$ at the singularity in Figure 14 can not occur in the differential as no disks contributing to the differential of $CE^*(\Gamma; V_0; \mathbb{R}^4)$ can cross the twist to the right in Figure 14. \square

This algebra was first introduced in [Siv11] for smooth bordered Legendrians and generalized to singular bordered Legendrians in [ABS22a]. In [ABS22a], it is shown that $CE^*(\Gamma; V_0; \mathbb{R}^4)$ is invariant up to quasi-isomorphism under Legendrian isotopy of Γ , by which we mean an isotopy of Λ which is constant outside $\{x \in \mathbb{R}^3 : |x| < M\}$.

Theorem 4.4 ([ABS22a, Theorem 3.3.15]). *The dg-algebra $CE^*(\Gamma; V_0; \mathbb{R}^4)$ is up to quasi-isomorphism invariant under Legendrian isotopy of Λ supported in some fixed compact subset.*

Proof. See [ABS22a, Theorem 3.3.15]. \square

Definition 4.5. Let Γ be a bordered Legendrian. The *reflection* of Γ is the bordered Legendrian $*\Gamma$ whose front is the horizontal reflection of the front of Γ .

Lemma 4.6. *Let Γ be a bordered Legendrian. Let Λ be a Legendrian whose front contains Γ as a tangle, along with a positive or negative half-twist as illustrated to the left in Figure 15. Then the operations in Figure 15 preserve the Legendrian isotopy type of Λ .*

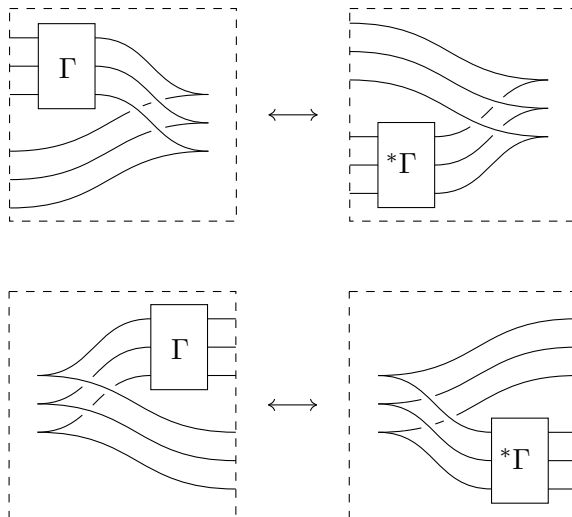

FIGURE 15. Pushing Γ through the cusp of a half-twist.

Remark 4.7. Note that Γ need not have the same number of left ends as right ends, or may lack left or right ends altogether.

Proof. We perform Reidemeister moves and push the left cusps, right cusps, crossings, and singularities of Γ through the half-twist, as shown in Figure 16. Doing this turns left cusps into right cusps and vice versa, flips the singularities, and reverses the order, so we get the bordered Legendrian $*\Gamma$ on the other side. See the proof of [Ng01, Lemma 5.1.4] for a similar construction. \square

4.2. Stopped subalgebras. Let Λ be the singular Legendrian skeleton of some Weinstein hypersurface $V \subset \mathbb{R}^3$.

Definition 4.8. If there are two values $x_0 < x_1$ such that all singularities of Λ have x -coordinates equal to either x_0 or x_1 and all other points of Λ have x -coordinates in the interval (x_0, x_1) we say

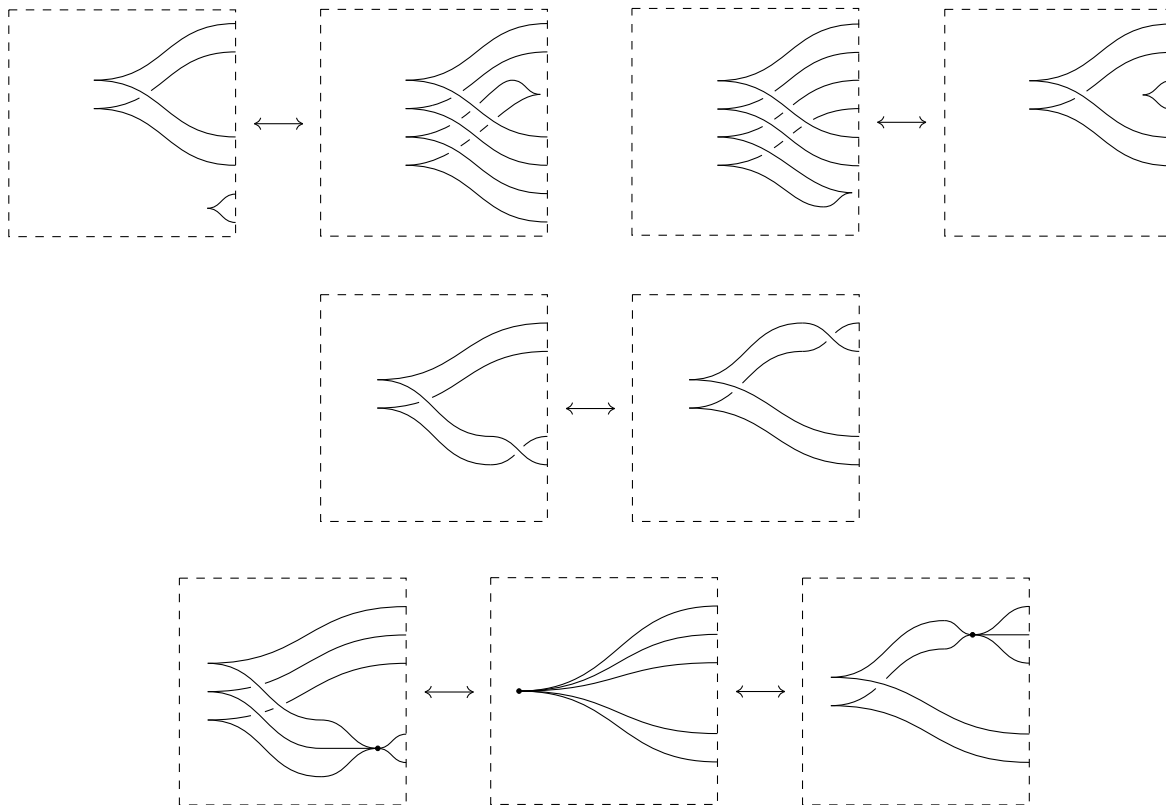
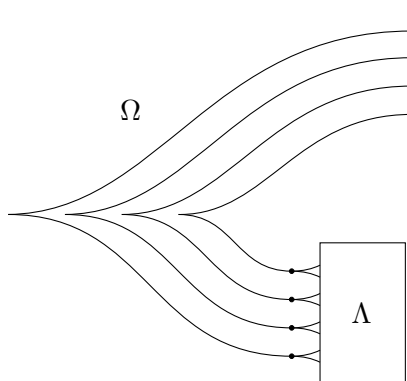

FIGURE 16. Pushing cusps, crossings, and singularities through a half-twist.

that Λ has *all singularities to the sides*. We call the singularities with x -coordinate equal to x_0 *left singularities* and those with x -coordinate equal to x_1 *right singularities*.

Every singular Legendrian in \mathbb{R}^3 is isotopic to a Legendrian with all singularities to the sides and we now assume that Λ is in such a position. We construct a bordered Legendrian $\Lambda \cup \Omega$ by attaching one strand Ω_i to each left singularity of Λ , numbering from bottom to top, as shown in Figure 17. Note that $\partial\Lambda$ consists of two-point spheres and $\partial\Omega$ of one-point stops. The bordered Legendrian

FIGURE 17. Adding strands $\Omega = \Omega_1 \cup \Omega_2 \cup \dots \cup \Omega_k$ to Λ . There are no Reeb chords of $\Lambda \cup \Omega$ with endpoints on Ω .

$\Lambda \cup \Omega$ has the property that there are no Reeb chords of $\Lambda \cup \Omega$ with an endpoint on Ω in the algebra $CE^*(\Lambda \cup \Omega; V_0; \mathbb{R}^4)$. Note however that there are Reeb chords of $\partial\Lambda \cup \partial\Omega$ with endpoints on $\partial\Omega$.

Definition 4.9. The *stopped subalgebra* of $CE^*(\Lambda \cup \Omega; V_0; \mathbb{R}^4)$, denoted by $CE^*(\Lambda; V_{0, \partial\Omega}; \mathbb{R}^4)$, is the unital dg-subalgebra generated by all chords of Λ , and the chords of $\partial\Lambda$ which do not pass through $\partial\Omega$.

Lemma 4.10. *The stopped subalgebra is a subcomplex, and hence itself a unital dg-algebra.*

Proof. By Proposition 2.8, the differential of a chord of $\partial\Lambda \cup \partial\Omega$ which does not pass through or has endpoints on $\partial\Omega$, will not contain any chords which pass through $\partial\Omega$ have endpoints on $\partial\Omega$. For the chords of Λ this can be seen using the Ng resolution. \square

If the base points of ∂V_0 are placed near $\partial\Omega$ then the chords of $\partial\Lambda$ which do not pass through $\partial\Omega$ are precisely the chords of the form c_{ij}^0 . In particular, $CE^*(\Lambda \cup \Pi; V_0; W)$ is finitely generated. Note that $CE^*(\Lambda; V_{0, \partial\Omega}; W)$ also embeds as subalgebra of $CE^*(\Lambda; V_0; W)$.

The motivation for the notation comes from considering $CE^*(\Lambda; V_{0, \partial\Omega}; W)$ as being a version of the relative algebra of Section 3.1, but where $\Sigma(\Sigma)$ is a non-compact stop at which we attach a ‘non-compact half-handle’, as shown in Figure 18. We do not give the full details of the geometric

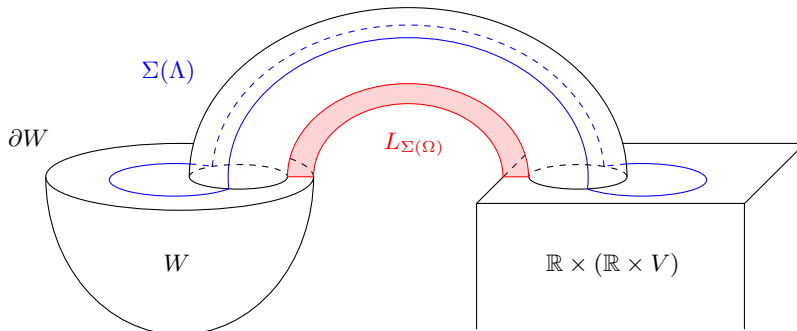

FIGURE 18. The cobordism $W_{V, \Sigma(\Omega)}^0$, where $L_{\Sigma(\Omega)}$ is the core of the half-handle attached at $\Sigma(\Omega)$.

construction, but note that attaching the non-compact half-handle corresponds to putting a stop diffeomorphic to a Legendrian arc in the boundary of the Weinstein cobordism W_V^0 .

Lemma 4.11. *The canonical inclusion*

$$CE^*(\Lambda; V_{0, \partial\Omega}; \mathbb{R}^4) \hookrightarrow CE^*(\Lambda \cup \Omega; V_0; \mathbb{R}^4)$$

is a quasi-isomorphism onto $CE^(\Lambda \cup \Omega; V_0; \mathbb{R}^4)[\Lambda, \Lambda]$.*

Remark 4.12. Note that this lemma says something different than Theorem 3.6, the reason being that $V_{0, \partial\Omega}$ is a Weinstein hypersector and not a hypersurface.

Proof. We will use an argument similar to that in the proof of Theorem 2.7. We filter $CE^*(\Lambda \cup \Omega; V_0; \mathbb{R}^4)$ by Reeb chord action and let $\tilde{\partial}$ be the action preserving component of the differential ∂ . Since ∂ is strictly action decreasing on chords of Λ , $\tilde{\partial}$ will act as ∂_0 from Proposition 2.8 on chords of $\partial\Lambda \cup \partial\Omega$ and vanish on chords of $\Lambda \cup \Omega$. Let

$$\tilde{\iota} : (CE^*(\Lambda; V_{0, \partial\Omega}; \mathbb{R}^4), \tilde{\partial}) \rightarrow (CE^*(\Lambda \cup \Omega; V_0; \mathbb{R}^4), \tilde{\partial})$$

be the inclusion considered as going between the same algebras as ι but with $\tilde{\partial}$ as differential. It follows from Lemma 2.10 that the inclusion

$$(CE^*(\partial\Lambda; V_{0, \partial\Omega}; \mathbb{R}^4), \partial_0) \hookrightarrow (CE^*(\partial\Lambda \cup \partial\Omega; V_0; \mathbb{R}^4), \partial_0)$$

is a quasi-isomorphism onto $(CE^*(\Lambda \cup \Omega; V_0; \mathbb{R}^4), \partial_0)[\Lambda, \Lambda]$. Since $\tilde{\iota}$ simply extends this inclusion by the identity on the remaining generators, it follows that the whole inclusion $\tilde{\iota}$ is a quasi-isomorphism

onto $(CE^*(\Lambda \cup \Omega; V_0; \mathbb{R}^4)[\Lambda, \Lambda], \tilde{\partial})$. If we consider the mapping cone of ι we see that the first page of the spectral sequence arising from the action filtration of the cone is isomorphic to the mapping cone of $\tilde{\iota}$. Consequently, the sequence vanishes on the second page and ι is a quasi-isomorphism onto $CE^*(\Lambda \cup \Omega; V_0; \mathbb{R}^4)[\Lambda, \Lambda]$. \square

Lemma 4.13. *There is a quasi-isomorphism*

$$CE^*(\Lambda \cup \Omega; V_0; \mathbb{R}^4) \rightarrow CE^*(\Lambda; V_0; \mathbb{R}^4),$$

and moreover, the restriction of this quasi-isomorphism to $CE^*(\Lambda \cup \Omega; V_0; \mathbb{R}^4)[\Lambda, \Lambda]$ is also a quasi-isomorphism.

Proof. First, we order the strands of Ω as $\Omega_1, \dots, \Omega_k$ going from top to bottom. By applying Lemma 4.6 twice we can perform an isotopy of $\Lambda \cup \Omega$ to get a bordered Legendrian of the form shown in Figure 19. This isotopy introduces one Reeb chord generator a_{ij} from Ω_i to Ω_j for each

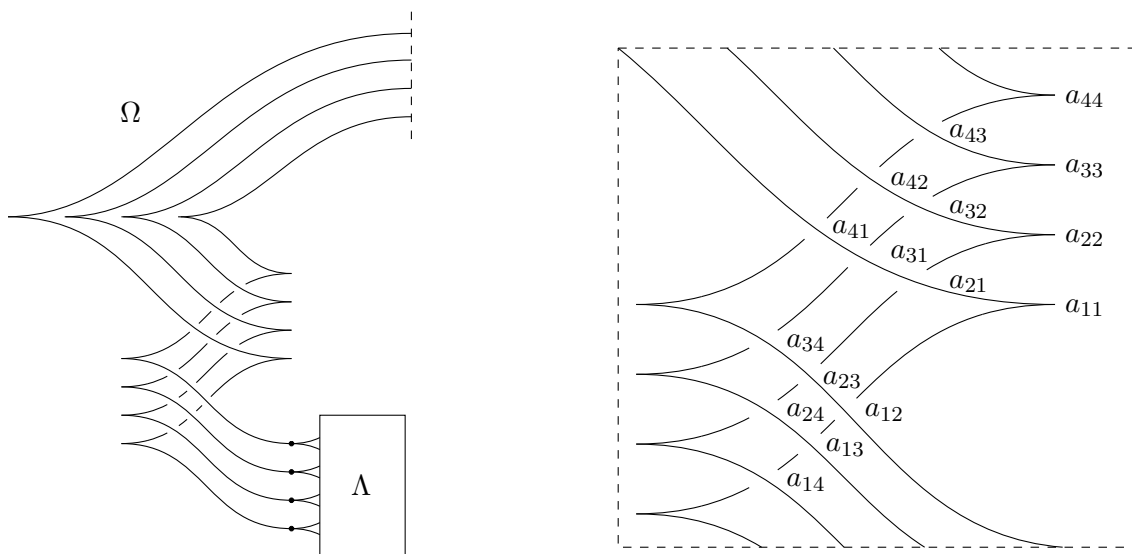

FIGURE 19. The bordered Legendrian $\Lambda \cup \Omega$ after a Legendrian isotopy which introduces Reeb chords from Ω to itself.

pair $1 \leq i, j \leq k$. The differential acts on these by $\partial a_{ij} = \pm \delta_{ij} e_i + \sum_{m>i} \pm a_{mj} a_{im}$, where e_i is the idempotent corresponding to Ω_i . In particular, we have $\partial a_{kk} = \pm e_k$. Moreover, a_{kk} does not occur in the differential of any other chords. By Lemma 2.5, there is then a quasi-isomorphism

$$CE^*(\Lambda \cup \Omega; V_0; \mathbb{R}^4) \xrightarrow{\sim} CE^*(\Lambda \cup \Omega_1 \cup \dots \cup \Omega_{k-1}; V_0; \mathbb{R}^4).$$

By induction we then get the desired quasi-isomorphism $CE^*(\Lambda \cup \Omega; V_0; \mathbb{R}^4) \xrightarrow{\sim} CE^*(\Lambda; V_0; \mathbb{R}^4)$. By construction (see the proof of Lemma 2.5) all words with an endpoint on Ω are sent to zero. As a chain complex, $CE^*(\Lambda \cup \Omega; V_0; \mathbb{R}^4)$ splits into a direct sum of the subcomplex $CE^*(\Lambda \cup \Omega; V_0; \mathbb{R}^4)[\Lambda, \Lambda]$ and the subcomplex of words with an endpoint on Ω . This implies that the restriction to $CE^*(\Lambda \cup \Omega; V_0; \mathbb{R}^4)[\Lambda, \Lambda]$ is also a quasi-isomorphism. \square

Combining these results, we get that the stopped subalgebra is quasi-isomorphic to the Chekanov–Eliashberg algebra of Λ .

Theorem 4.14. *Let $\Lambda \subset \mathbb{R}^3$ be a singular Legendrian. Then the canonical inclusion*

$$CE^*(\Lambda; V_{0, \partial \Omega}; \mathbb{R}^4) \hookrightarrow CE^*(\Lambda; V_0; \mathbb{R}^4)$$

is a quasi-isomorphism.

Proof. Composing the maps Lemma 4.11 and Lemma 4.13 we get a quasi-isomorphism,

$$CE^*(\Lambda; V_{0, \partial\Omega}; \mathbb{R}^4) \xrightarrow{\sim} CE^*(\Lambda \cup \Omega; V_0; \mathbb{R}^4)[\Lambda, \Lambda] \xrightarrow{\sim} CE^*(\Lambda; V_0; \mathbb{R}^4),$$

and it is clear from the construction of these maps that the composition is the canonical inclusion. \square

Remark 4.15. To simplify the exposition, we have only considered the case when we attach one strand Ω_i at each left singularity. However, one can equally well attach them only at a subset of the left singularities. If one does this and lets Ω be the union of the strands attached at this subset, one can in the same way define the stopped subalgebra by excluding the chords of $\partial\Lambda$ passing through the $\partial\Omega$. Then Lemma 4.11, Lemma 4.13, and Theorem 4.14 all remain true, and the proofs are the same.

4.3. Bordered Legendrians from opening up singular Legendrians. The stopped subalgebra can be realized as the Chekanov–Eliashberg algebra of a bordered Legendrian. This allows us to exploit the isotopy invariance and further simplify the algebra.

Definition 4.16. Let $\Lambda \subset \mathbb{R}^3$ be a singular Legendrian with all singularities to the sides. The *opening* of Λ is the smooth bordered Legendrian Λ° obtained by removing the singularities of Λ and separating the strands, as shown in Figure 21. Given a left or right singularity t of Λ , we define

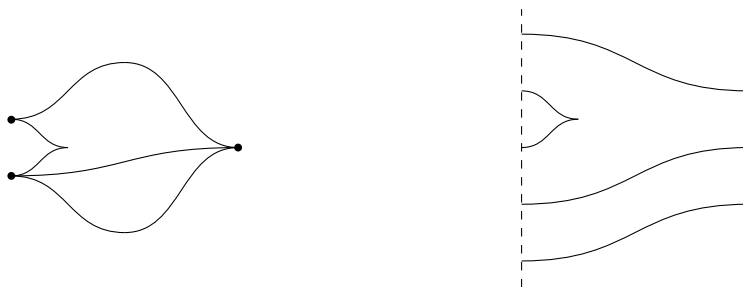

FIGURE 20. The front projection of a singular Legendrian Λ and its opening Λ° .

$\Lambda^{\circ,t}$ to be the (possibly singular) bordered Legendrian obtained by opening only at t .

Definition 4.17. Let $\Lambda \subset \mathbb{R}^3$ be a singular Legendrian with all singularities to the sides. The *resolution* of Λ is the smooth bordered Legendrian Λ^\bullet constructed as shown in Figure 21. It is obtained from the opening Λ° by performing a negative half-twist of the ends corresponding to each left singularity of Λ , and a positive half twist followed by a negative half-twist of the ends corresponding to each right singularity, in such a way that no new chords are introduced between ends corresponding to different singularities. It does not matter in which order the twists are performed, or if they go up or down. Given a left or right singularity t of Λ we define $\Lambda^{\bullet,t}$ to be the (possibly singular) bordered Legendrian obtained by resolving only at t .

Remark 4.18. Note that due to the choices involved in the definition, the resolution Λ^\bullet is not canonically defined up to Legendrian isotopy. However, for any two different models of Λ^\bullet there is a canonical identification of their respective Reeb chords. The Chekanov–Eliashberg algebra $CE^*(\Lambda^\bullet; \mathbb{R}^4)$ is thus well-defined up to isomorphism.

Theorem 4.19. *Let $\Lambda \subset \mathbb{R}^3$ be a singular Legendrian with all singularities to the sides. Then there is a quasi-isomorphism*

$$CE^*(\Lambda; V_0; \mathbb{R}^4) \cong CE^*(\Lambda^\bullet; \mathbb{R}^4).$$

Moreover, if t is an arbitrary singularity of Λ there is a quasi-isomorphism

$$CE^*(\Lambda; V_0; \mathbb{R}^4) \cong CE^*(\Lambda^{\bullet,t}; V_0^{\bullet,t}; \mathbb{R}^4).$$

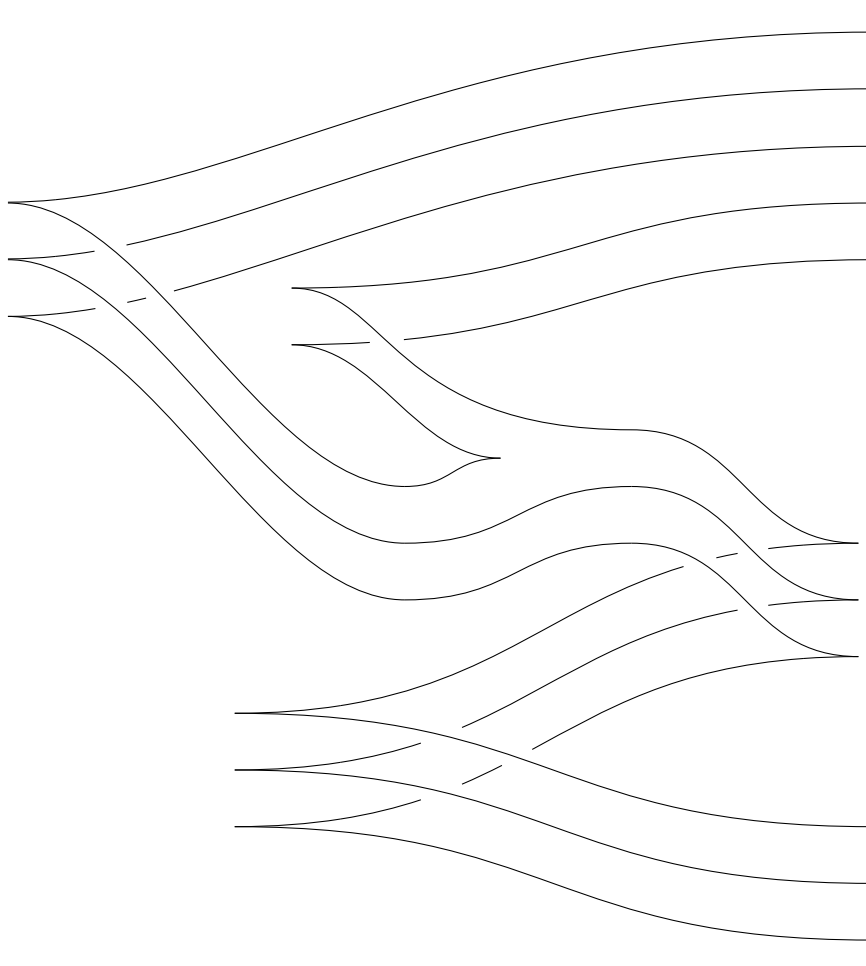

FIGURE 21. The front projection of the resolution Λ^\bullet of the Legendrian Λ in Figure 20.

Proof. We prove the first quasi-isomorphism; the proof of the second is similar in light of Remark 4.15. By performing a positive half twist at each right singularity of Λ , using Reidemeister VI moves, we can obtain a Legendrian Λ' with only left singularities such that $(\Lambda')^\bullet = \Lambda^\bullet$. Since Λ and Λ' are Legendrian isotopic by construction, we get a quasi-isomorphism

$$CE^*(\Lambda; V_0; \mathbb{R}^4) \cong CE^*(\Lambda'; V_0; \mathbb{R}^4).$$

It is thus sufficient to prove the theorem assuming that Λ only has left singularities.

For each left singularity t of valency n of Λ the stopped subalgebra $CE^*(\Lambda; V_0, \partial\Omega; \mathbb{R}^4)$ has one Reeb chord generator t_{ij}^0 for each $1 \leq i < j \leq n$, labeling counter-clockwise from a base point placed to the left. The differential acts by

$$\partial t_{ij}^0 = \sum_{i < k < j} \pm t_{kj}^0 t_{ik}^0.$$

Looking at the corresponding negative half-twist in Λ^\bullet one sees that there is one Reeb chord generator a_{ij} for each $1 \leq i < j \leq n$, using the same labeling of the strands as for the points of $\partial\Lambda$. The differential applied to these chords are given by

$$\partial a_{ij} = \sum_{i < k < j} \pm a_{ik} a_{kj},$$

so the canonical identification of generators, mapping a_{ij} to t_{ij}^0 , is a unital isomorphism of algebras. Using the Ng resolution to compute the differential it is clear that this is compatible with the differential, and we thus have a dg-algebra isomorphism

$$CE^*(\Lambda; V_{0,\partial\Omega}; \mathbb{R}^4) \cong CE^*(\Lambda^\bullet; \mathbb{R}^4).$$

The result finally follows from Theorem 4.14. \square

Remark 4.20. Any singular Legendrian can be moved by a Legendrian isotopy into a position with all singularities to the sides, so Theorem 4.19 produces finitely generated models for all singular Legendrians in \mathbb{R}^3 . The algebra $CE^*(\Lambda^\bullet; \mathbb{R}^4)$ will depend up to quasi-isomorphism on the choice of isotopy.

Theorem 4.21. *Let $\Lambda \subset \mathbb{R}^3$ be a singular Legendrian and let t be an arbitrary right singularity of Λ . Then there is an isotopy*

$$\Lambda^{\bullet,t} \sim \Lambda^{\circ,t}$$

and in particular, there are then quasi-isomorphisms

$$CE^*(\Lambda; V_0; \mathbb{R}^4) \cong CE^*(\Lambda^{\bullet,t}; \mathbb{R}^4) \cong CE^*(\Lambda^{\circ,t}; \mathbb{R}^4).$$

Proof. The resolution $\Lambda^{\bullet,t}$ is obtained from $\Lambda^{\circ,t}$ by performing two half-twists. By applying Lemma 4.6 (with $\Gamma = \Lambda^{\circ,t}$) we get an isotopy $\Lambda^{\bullet,t} \sim (*\Lambda)^{\bullet,t}$. Doing this again (with $\Gamma = *(\Lambda^{\circ,t})$) we obtain an isotopy $(*\Lambda)^{\bullet,t} \sim \Lambda^{\circ,t}$. Compare Figure 17 and Figure 19. The result then follows by Theorem 4.19. \square

It is important to note that the above theorem is not true if one opens at more than one right singularity, as it is then not possible to perform the isotopy.

5. EXAMPLES AND COMPUTATIONS

We here give a number of examples of how the results in the previous sections can be used to compute the cohomology and minimal model of the Chekanov–Eliashberg algebra.

Example 5.1. Let Λ be the standard Legendrian unknot with a single top handle, illustrated in Figure 22. The opening of Λ lacks Reeb chords, so its Chekanov–Eliashberg algebra is isomorphic to

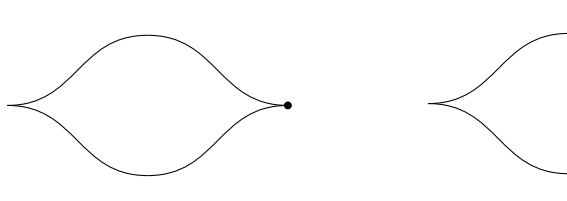

FIGURE 22. The front projection of the standard Legendrian unknot Λ with a single top handle, and its opening Λ° .

the ground field \mathbf{k} . Theorem 4.21 then says that there is a quasi-isomorphism $CE^*(\Lambda; V_0; \mathbb{R}^4) \cong \mathbf{k}$. This has been shown in [AE22, Example 7.4] using other methods. The result is expected in light of the surgery formula, as the corresponding co-core consists of a single section in $W_V \cong T^*\mathbb{R}^2$ whose wrapped Floer cohomology is generated by a single self-intersection point, see [AE22, Section 1.1].

5.1. Rainbow connected sums. There is a way of connecting two singular Legendrians so that the Chekanov–Eliashberg algebra of the resulting Legendrian is quasi-isomorphic to the direct product of the Chekanov–Eliashberg algebras of the initial Legendrians.

Definition 5.2. Let Λ^1 and Λ^2 be two unlinked singular Legendrians in \mathbb{R}^3 , such that Λ^1 and Λ^2 both have k left singularities. The *rainbow connected sum* of Λ^1 and Λ^2 is the Legendrian $\Lambda^1 \# \Lambda^2$ obtained by connecting Λ^1 and Λ^2 by k handles Π as in Figure 23.

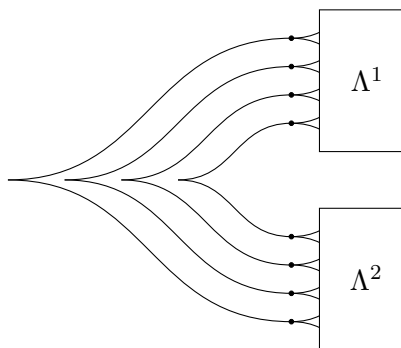

FIGURE 23. The Rainbow connected sum of two singular Legendrians Λ^1 and Λ^2 in the front, with $k = 4$.

Remark 5.3. In particular, if one connects Λ^1 and Λ^2 with only one handle in some arbitrary way, the resulting Legendrian will always be isotopic to a rainbow connected sum of two Legendrians isotopic to Λ^1 and Λ^2 .

Proposition 5.4. *There is a quasi-isomorphism*

$$CE^*(\Lambda^1 \# \Lambda^2; V_0^1 \cup V_0^2; \mathbb{R}^4) \xrightarrow{\sim} CE^*(\Lambda^1; V_0^1; \mathbb{R}^4) \times CE^*(\Lambda^2; V_0^2; \mathbb{R}^4)$$

where ‘ \times ’ denotes the direct product of dg-algebras.

Proof. Similarly to in the proof of Lemma 4.13, one can perform an isotopy of $\Lambda^1 \# \Lambda^2$ introducing chords as in Figure 19 and use Lemma 2.5 to successively remove the handles in Π . We then obtain a quasi-isomorphism $CE^*(\Lambda^1 \# \Lambda^2; V_0; \mathbb{R}^4) \xrightarrow{\sim} CE^*(\Lambda^1 \cup \Lambda^2; V_0^1 \cup V_0^2; \mathbb{R}^4)$, and since Λ^1 and Λ^2 are unlinked there is a natural isomorphism $CE^*(\Lambda^1 \cup \Lambda^2; V_0^1 \cup V_0^2; \mathbb{R}^4) \cong CE^*(\Lambda^1; V_0^1; \mathbb{R}^4) \times CE^*(\Lambda^2; V_0^2; \mathbb{R}^4)$. \square

Using this, we can compute the cohomology of the handcuff graph.

Example 5.5. Let Λ be the singular Legendrian illustrated in Figure 24, obtained by connecting two unknots with a single handle. As noted in Remark 5.3, Λ is isotopic to a rainbow connected

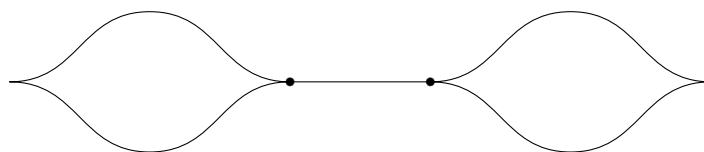

FIGURE 24. The front projection of two unlinked unknots connected by a handle.

sum of two unknots. By Proposition 5.4 and Example 5.1 we then have

$$CE^*(\Lambda; V_0; \mathbb{R}^4) \cong \mathbf{k} \times \mathbf{k}.$$

This result was expected by An–Bae in [AB20, Section 8].

5.2. Finite dimensional models. We here construct an infinite class of Legendrians for which Theorem 4.21 gives finite dimensional models.

Definition 5.6. A *handle permutation of order n* is a word $\sigma = \sigma_1\sigma_2\dots\sigma_n$ of elements $\sigma_i \in \{1, 2, \dots, n\}$ such that each $k \in \{1, 2, \dots, n\}$ appears precisely two times in σ . We write $\sigma(i^-)$ and $\sigma(i^+)$ for the unique numbers such that $\sigma_{\sigma(i^-)} = \sigma_{\sigma(i^+)} = i$ and $\sigma(i^-) < \sigma(i^+)$. If two handle permutations are related by a permutation (i.e. relabeling) of $\{1, 2, \dots, n\}$ we consider them to be equivalent.

Definition 5.7. Let the *standard unknot of size l* be the standard unknot scaled so that the distance between its horizontal tangencies is l . Given a handle permutation σ of order n , we define Λ_σ° to be the smooth bordered Legendrian consisting of n strands $\Lambda_1^\circ, \dots, \Lambda_n^\circ$ such that each strand Λ_i° is a copy of the right half of the standard unknot of size $\sigma(i^+) - \sigma(i^-)$ translated so that the upper and lower ends of Λ_i° have the respective front coordinates $(0, \sigma(i^+))$ and $(0, \sigma(i^-))$. We then define Λ_σ to be the unique singular Legendrian with opening Λ_σ° such that Λ_σ only has one singularity, and call it the *permutation Legendrian* of σ . We denote by V_σ the Weinstein thickening of Λ_σ .

The algebra $CE^*(\Lambda_\sigma^\circ; \mathbb{R}^4)$ has n idempotents and one Reeb chords generator a_{ij} from i to j for each pair i and j such that $\sigma(i^-) < \sigma(j^-) < \sigma(i^+) < \sigma(j^+)$. If one gives the handles the same Maslov potential (under the canonical identification by translation and rescaling) then $|a_{ij}| = 1$ for all i and j . The differential is given by

$$\partial a_{ij} = \sum \pm a_{kj} a_{ik}$$

where the sum is taken over all $1 < k < n$ for which the chords a_{kj} and a_{ik} exist, i.e. all k such that $\sigma(i^-) < \sigma(k^-) < \sigma(i^+) < \sigma(k^+)$ and $\sigma(k^-) < \sigma(j^-) < \sigma(k^+) < \sigma(j^+)$. The finite dimensionality implies that the cohomology can be readily computed.

Example 5.8. Let $n > 0$ and let σ be the handle permutation of order n given by $\sigma(i^-) = i$ and $\sigma(i^+) = 2i$. We call $\Lambda_A^n := \Lambda_\sigma$ the *standard A_n -Legendrian*. The algebra $CE^*(\Lambda_A^{n,\circ}; \mathbb{R}^4)$ has one

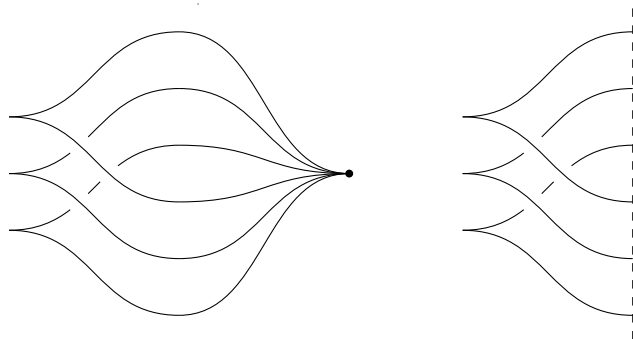

FIGURE 25. The front projection of the standard A_n -Legendrian Λ_A^n and its opening $\Lambda_A^{n,\circ}$.

generator a_{ij} for each $1 \leq i < j \leq n$, with

$$\partial a_{ij} = \sum_{i < k < j} \pm a_{kj} a_{ik}.$$

Proposition 5.9. *The minimal model of $CE^*(\Lambda_A^n; V_{A,0}^n; \mathbb{R}^4)$ is isomorphic to the path algebra of the A_n -quiver*

$$\bullet \xrightarrow{\alpha_1} \bullet \xrightarrow{\alpha_2} \bullet \xrightarrow{\alpha_3} \dots \xrightarrow{\alpha_{n-1}} \bullet \xrightarrow{\alpha_{n-2}} \bullet$$

bound by the relations $\alpha_{i+1}\alpha_i = 0$ for $1 \leq i \leq n-2$, without any higher operations.

Proof. The differential of $CE^*(\Lambda_A^{n,\circ}; \mathbb{R}^4)$ is essentially the same differential as ∂_0 in Section 2.2 and one can use the same argument as in Lemma 2.10 to see that the cohomology is generated by the residues of the chords of the form $a_{i,i+1}$ for $1 \leq i < n$, with zero multiplication. The cohomology is thus isomorphic to the path algebra. There is a dg-algebra quasi-isomorphism $CE^*(\Lambda_A^{n,\circ}; \mathbb{R}^4) \rightarrow H^*CE(\Lambda_A^{n,\circ}; \mathbb{R}^4)$ given by $a_{i,i+1} \mapsto [a_{i,i+1}]$ and $a_{ij} \mapsto 0$ for $j - i > 1$, which shows that this indeed is the minimal model of $CE^*(\Lambda_A^{n,\circ}; \mathbb{R}^4)$, and then by Theorem 4.21 also the minimal model of $CE^*(\Lambda_A^n; V_{A,0}^n; \mathbb{R}^4)$ \square

Partial computations of this example were done by An–Bae in [AB20, Section 8], where they expected this result. These computations are related to the computations using the technology of microlocal sheaf theory; see Nadler’s computations for the A_n -arboreal Legendrian from [Nad17].

As a geometric application, we can use this computation to obstruct the existence of certain isotopies, compare [Mis03].

Corollary 5.10. *A Legendrian isotopy from Λ_A^n to itself cannot produce a non-trivial permutation of the handles.*

Proof. An isotopy from Λ_A^n to itself permuting the handles induces an algebra automorphism of $H^*CE(\Lambda_A^n; V_{A,0}^n; \mathbb{R}^4)$ permuting the corresponding idempotents in the same way, and no non-trivial permutations of the idempotents of $H^*CE(\Lambda_A^n; V_{A,0}^n; \mathbb{R}^4)$ can be produced by an algebra automorphism. \square

5.2.1. *Mutations.* Consider an abstract Weinstein surface V such that V_0 is connected and let $\partial\Lambda \subset V_0$ be the critical attaching spheres. By fixing a base point in ∂V_0 and following the Reeb flow around ∂V_0 we get a handle permutation σ such that V and V_σ are isomorphic as Weinstein manifolds and there is an embedding $V \hookrightarrow \mathbb{R}^3$ whose image is V_σ . The handle permutation σ depends on the base point and will in general result in non-Legendrian isotopic V_σ . However, given a fixed handle decomposition, σ is unique up to cyclic permutations and V_σ is unique up to Weinstein isotopy.

Definition 5.11. Let σ be a handle permutation of order n and let $k \in \mathbb{Z}$. The *shift of σ by k* is the permutation

$$\sigma[k] := \sigma_{1-k} \dots \sigma_{i-k} \dots \sigma_{n-k},$$

counting mod n in the indices.

Proposition 5.12. *Let σ be a handle permutation of order n and let $k \in \mathbb{Z}$. There is a Weinstein isotopy*

$$V_\sigma \sim V_{\sigma[k]}.$$

Proof. It is sufficient to show this for $k = 1$. The isotopy is illustrated in Figure 26 and is performed as follows. We relabel so that $\sigma_{2n} = n$ and give the ends of the handles Λ_i of V_σ the labeling i^\pm where $i = 1, \dots, n$, as specified in Definition 5.6. In the first step, we perform a Weinstein isotopy introducing a handle with a right cusp as in Proposition 3.16, which splits the singularity in two singularities such that an end i^\pm belongs to the lower singularity if $\sigma(i^\pm) \leq \sigma(n^-)$ and to the upper singularity if $\sigma(i^\pm) > \sigma(n^-)$. In the second and third steps, we perform Reidemeister IV moves at the ends n^- and n^+ which moves the handle Λ_n into a position slightly below the introduced handle, obtaining the Legendrian in the fourth picture in Figure 26. This Legendrian can be obtained from $V_{\sigma[1]}$ by an analogous Weinstein isotopy, as shown in the two last pictures of the figure. We thus have $V_\sigma \sim V_{\sigma[1]}$. \square

Viewing the Chekanov–Eliashberg algebras as path algebras, the quiver of $CE^*(\Lambda_{\sigma[1]}^\circ; \mathbb{R}^4)$ can be obtained from that of $CE^*(\Lambda_\sigma^\circ; \mathbb{R}^4)$ by flipping all arrows with target on the vertex corresponding to the σ_{2n} -th handle. The isotopy can therefore be viewed as geometric realization of the Bernstein–Gelfand–Ponomarev reflection functors [BGP73].

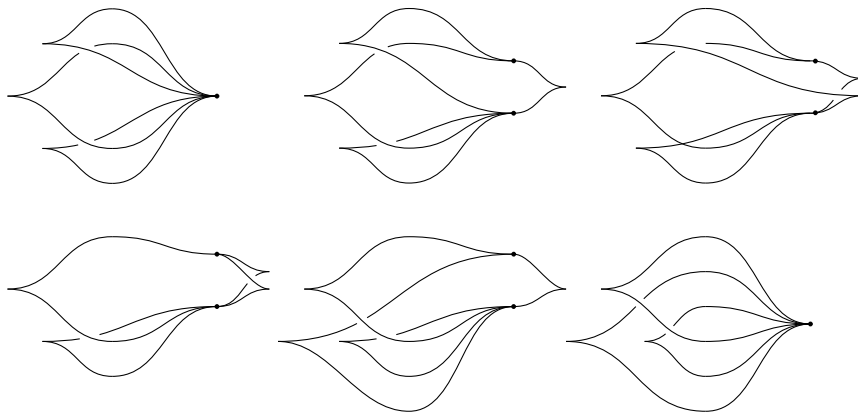

FIGURE 26. A Weinstein isotopy between the permutation Legendrians Λ_{121323} and Λ_{312132} . The figure should be read from left to right and top to bottom.

Example 5.13. Consider the handle permutation $\sigma = 121323$. The openings of Λ_σ and the shifts

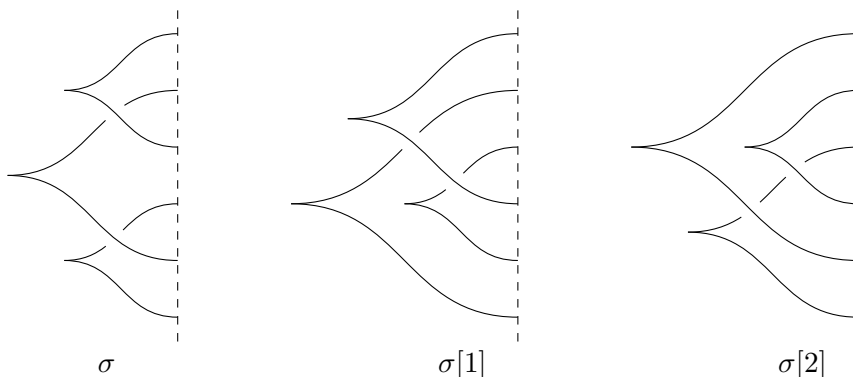

FIGURE 27. The openings of the three Legendrians obtained by shifting $\sigma = 121323$.

$\Lambda_{\sigma[1]}$ and $\Lambda_{\sigma[2]}$ are illustrated in Figure 27. The Chekanov–Eliashberg algebras of the openings of all three have vanishing differential and are isomorphic to the respective path algebras of the following quivers:

$$\bullet \longrightarrow \bullet \longrightarrow \bullet, \quad \bullet \longrightarrow \bullet \longleftarrow \bullet, \quad \bullet \longleftarrow \bullet \longrightarrow \bullet.$$

The Weinstein isotopies in Proposition 5.12 are, however, not all Weinstein isotopies which exist between the permutation Legendrians, as the following example shows.

Example 5.14. Let $n > 1$ and let σ the handle permutation of order n , given by

$$\begin{aligned} \sigma(1^-) &= 1, & \sigma(i^-) &= 2i - 2, & \sigma(n^-) &= 2n - 2, \\ \sigma(1^+) &= 3, & \sigma(i^+) &= 2i + 1, & \sigma(n^+) &= 2n, \end{aligned}$$

for $i \neq 1, n$. The permutation Legendrian $\Lambda_{A'}^n := \Lambda_\sigma$ and its opening are illustrated in Figure 28. The Chekanov–Eliashberg algebra of $\Lambda_{A'}^{n, \circ}$ has differential zero and is isomorphic to the path algebra of the A_n -quiver

$$\bullet \xrightarrow{\alpha_1} \bullet \xrightarrow{\alpha_2} \bullet \xrightarrow{\alpha_3} \dots \xrightarrow{\alpha_{n-1}} \bullet \xrightarrow{\alpha_{n-2}} \bullet$$

without any relations. We expect that this Weinstein surface can be naturally realized a Milnor fiber of the A_n -singularity in the boundary of B^4 , see [GPS18, Corollary 1.17][Nad17].

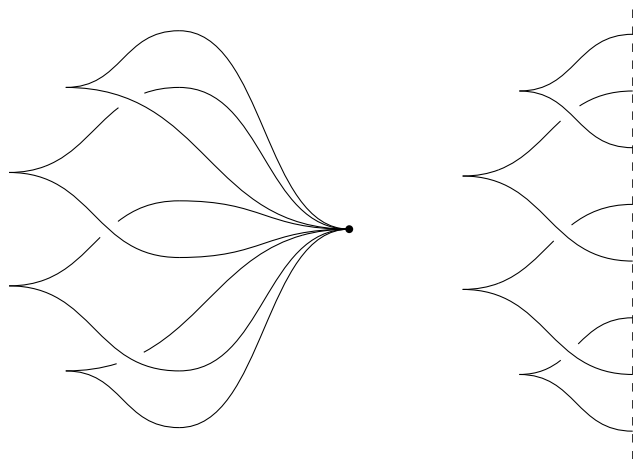

FIGURE 28. The front projection of the Legendrian $\Lambda_{A'}^n$ and its opening $\Lambda_{A'}^{n,\circ}$.

Proposition 5.15. *There is a Weinstein isotopy,*

$$V_A^n \sim V_{A'}^n.$$

Proof. The isotopy is illustrated in Figure 29 for $n = 4$. The procedure is the same for all n . The first

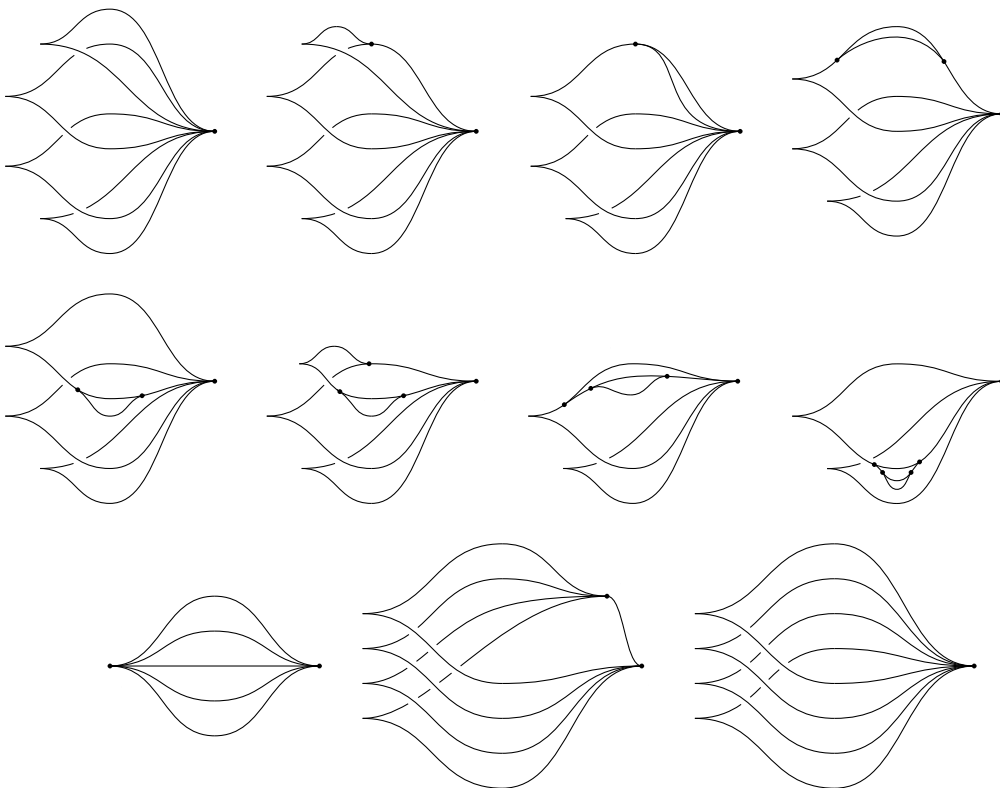

FIGURE 29. A Weinstein isotopy between V_A^n and $V_{A'}^n$ for $n = 4$. The figure should be read from left to right and top to bottom.

step is a Weinstein handle introduction as in Proposition 3.16. The second step is a Reidemeister VI move. The third step is another handle introduction. The fourth step is an application of Lemma 4.6. The fifth, sixth, and seventh steps are performed in the same way as the first four: by

introducing a handle, performing a Reidemeister VI move, introducing another handle, and then applying Lemma 4.6. By repeating this procedure for each handle and then performing a series of Weinstein handle contractions one then obtains the Legendrian in the ninth picture. The second to last step is then a Reidemeister IV move, followed by another application of Lemma 4.6, and the final step is a Weinstein handle contraction. \square

Examples 5.8 and 5.13 demonstrate that the Chekanov–Eliashberg algebra can undergo significant changes under Weinstein isotopy. Recall that this corresponds to different choices of generators of the partially wrapped Fukaya category obtained by stopping at the Weinstein surface. It is interesting to note that the path algebra of the A_n -quiver with all quadratic relations quotiented out is the Koszul dual of the path algebra of the same quiver without relations. We intend to investigate bifurcations of the Chekanov–Eliashberg algebra under Weinstein isotopy further in the future.

5.3. Infinite dimensional models. In addition to the permutation Legendrians, there are several families of singular Legendrians with infinite dimensional models for which the cohomology can be computed.

Example 5.16. Let $n > 1$ and let Λ_θ^n be the singular Legendrian with one right singularity and one left singularity such that when opening Λ_θ^n at both singularities one obtains a bordered Legendrian consisting of n strands without cusps, crossings, or singularities. It is illustrated for $n = 4$ in Figure 30. We call Λ_θ^n the θ_n -Legendrian. From the proof of Proposition 5.15 we see that Λ_θ^n is

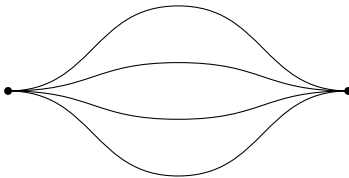

FIGURE 30. The front projection of the Legendrian Λ_θ^n for $n = 4$.

Weinstein isotopic to Λ_A^{n-1} and $\Lambda_{A'}^{n-1}$.

Proposition 5.17. *The minimal model of $CE^*(\Lambda_\theta^n; V_{\theta,0}^n; \mathbb{R}^4)$ is isomorphic to the A_∞ -algebra whose underlying module is the path algebra of the quiver with one vertex for each $i \in \mathbb{Z}_n$ and one arrow α_i from i to $i + 1$ for each i , with all compositions quotiented out, and whose A_∞ -operations μ_k act by*

$$\mu_n(\alpha_{i+n-1} \otimes \dots \otimes \alpha_{i+1} \otimes \alpha_i) = \varepsilon_i$$

for each $i \in \mathbb{Z}_n$, and vanish on all other words.

Proof. By Theorem 4.21, we have a quasi-isomorphism

$$CE^*(\Lambda; V_0; \mathbb{R}^4) \cong CE^*((\Lambda_\theta^n)^{\circ,t}; V_0; \mathbb{R}^4),$$

where t is the right singularity. The algebra $CE^*((\Lambda_\theta^n)^{\circ,t}; V_0; \mathbb{R}^4)$ is isomorphic to its internal algebra, i.e. the Chekanov–Eliashberg algebra of n one-point stops in the boundary of the disk. The result then follows from Theorem 1.2. \square

We thus have a third, non-formal representative of the Chekanov–Eliashberg algebras of the Weinstein isotopy class of Λ_A^n and $\Lambda_{A'}^n$.

Remark 5.18. Geometrically, the fact that Λ_θ^n and the n -point stop have quasi-isomorphic Chekanov–Eliashberg algebras can be explained by noting that Λ_θ^n is the (T^*D^1, T^*S^0) -stabilization of the n -point stop. This stabilization construction is a special case of the product construction defined in [Eli18, Section 3.2], and for which Ganatra–Pardon–Shende [GPS18] have constructed a Künneth embedding of the corresponding partially wrapped Fukaya categories. In light of Theorem 3.3, one

therefore expects there to be a Künneth formula for Chekanov–Eliashberg algebras, from which the above quasi-isomorphism would follow.

Similarly to in Example 5.8, we can use the above computation to obstruct certain isotopies.

Corollary 5.19. *There exists a Legendrian isotopy from Λ_0^n to itself realizing a given permutation of the handles if and only if the permutation is cyclic.*

Proof. The only permutations of the idempotents of the minimal model in Proposition 5.17 which can be realized by an algebra automorphism are the cyclic ones. This implies that there are no isotopies of Λ producing non-cyclic permutations of the handles. The cyclic permutations are easy to produce using the Reidemeister moves. \square

Example 5.20. Let $n > 0$. We construct a singular Legendrian Λ_{cyc}^n as follows. First, we consider

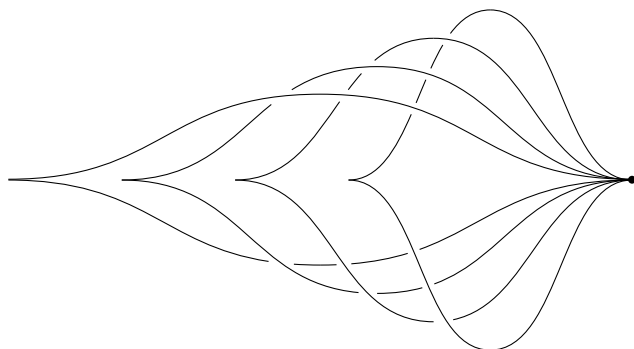

FIGURE 31. The singular Legendrian Λ_{cyc}^n , defined as the union of n unknots successively more squeezed in the x -direction and stretched in the z -direction.

a standard unknot with a single top handle and with the singularity and right cusp placed at the origin in \mathbb{R}^3 . We construct a second unknot by applying a transformation of the form $(x, z) \rightarrow (x/M, Mz)$ for some $M > 1$ to the front diagram of the first unknot. We construct a third unknot by applying the same transformation to the second unknot, and continue like this until we have n unknots. Then Λ_{cyc}^n is defined to be the union of these unknots, see Figure 31.

Proposition 5.21. *The minimal model of $CE^*(\Lambda_{\text{cyc}}^n; V_{\text{cyc},0}^n; \mathbb{R}^4)$ is isomorphic to the path algebra of the quiver with n vertices $1, \dots, n$ and one arrow from i to j for each ordered pair $(i, j) \in \{1, \dots, n\}^2$ such that $i \neq j$.*

Proof. For each ordered pair (i, j) of distinct components of Λ_{cyc}^n , there is one Reeb chord a_{ij} from i to j . If one gives the handles the same Maslov potential then each a_{ij} has degree zero, and the differential thus vanishes. The result then follows by Theorem 4.21. \square

Proposition 5.22. *The Legendrian Λ_{cyc}^n is not Weinstein isotopic to any permutation Legendrian.*

Proof. As noted in [AE22, Remark 1.5], the Hochschild homology of the singular Chekanov–Eliashberg algebra is a Weinstein isotopy invariant. The Hochschild homology is derived invariant, and in particular, invariant under quasi-isomorphism. Recall that the Hochschild homology in degree 0 of an associate algebra A is the quotient $A/\text{Span}\{ab - ba \mid a, b \in A\}$. Since $CE^*(\Lambda_{\text{cyc}}^n; \mathbb{R}^4)$ is the path algebra of a cyclic quiver this implies that $HH_0(CE^*(\Lambda_{\text{cyc}}^n; \mathbb{R}^4))$ is infinite dimensional (a linearly independent infinite subset is given by e.g. $\{[(a_{21}a_{12})^i] \mid i \in \mathbb{N}\}$). On the other hand, for any permutation Legendrian Λ_σ , the algebra $CE^*(\Lambda_\sigma; \mathbb{R}^4)$ is a semi-free finite dimensional dg-algebra and therefore homologically smooth and compact, see [KS09, Section 8]. By [KS09, Proposition 8.10], it then follows that the Hochschild homology of $CE^*(\Lambda_\sigma; \mathbb{R}^4)$ is finite dimensional. Thus, such a Weinstein isotopy cannot exist. \square

Example 5.23. Let $n > 1$ and let $\Lambda_{\theta'}^n$ be the Legendrian illustrated in Figure 32.

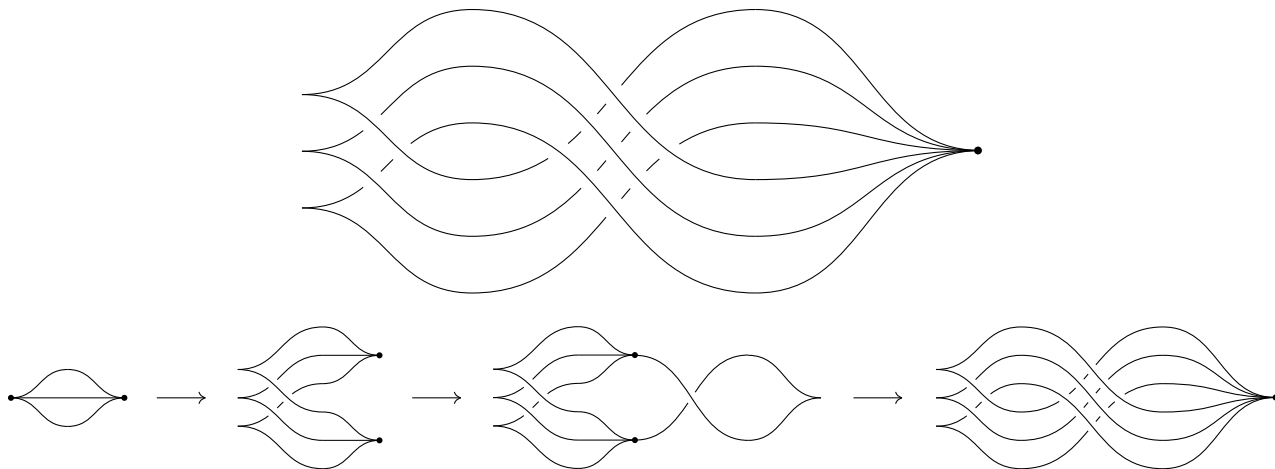

FIGURE 32. The front projection the singular Legendrian knot $\Lambda_{\theta'}^n$ for $n = 3$, and its construction from Λ_{θ}^n .

It is obtained from the Legendrian Λ_{θ}^n from Example 5.16 by performing a Legendrian isotopy using Lemma 4.6 so that we get two right singularities, and then attaching and contracting a handle with core Π , as shown in the figure.

Proposition 5.24. *There is a quasi-isomorphism*

$$CE^*(\Lambda_{\theta'}^n; V_{\theta',0}^n; \mathbb{R}^4) \cong CE^*(\Lambda_{\theta}^n; V_{\theta,0}^n; \mathbb{R}^4).$$

Proof. The Reeb chord corresponding to the right cusp of Π in Figure 32 has differential $\pm e_{\Pi}$. The result then follows by Lemma 2.5 and Corollary 3.13 \square

Remark 5.25. This provides an alternative proof for a result by Etgü–Lekili. Let $CE^*(\partial\Omega; D_2)$ be the Chekanov–Eliashberg algebra of n one-point stops in the boundary of the disk D^2 . In [EL19, Theorem 12], it was shown that the inclusion of the dg-subalgebra of all chords c_{ij}^p with $p \leq 1$ into $CE^*(\partial\Omega; D_2)$ is a quasi-isomorphism. This subalgebra is isomorphic to $CE^*(\Lambda_{\theta'}^n; \mathbb{R}^4)$. The chords with $p = 0$ correspond to the chords in the triangle shape to the left in Figure 32, and the chords with $p = 1$ to the chords in the diamond shape in the center. Using Theorem 4.21 we thus recover [EL19, Theorem 12].

REFERENCES

- [AB20] Byung Hee An and Youngjin Bae. A Chekanov–Eliashberg algebra for Legendrian graphs. *J. Topol.*, 13(2):777–869, 2020.
- [ABK22] Byung Hee An, Youngjin Bae, and Tamás Kálmán. Ruling invariants for Legendrian graphs. *J. Symplectic Geom.*, 20(1):49–97, 2022.
- [ABS22a] Byung Hee An, Youngjin Bae, and Tao Su. Augmentations and ruling polynomials for Legendrian graphs. *Algebr. Geom. Topol.*, 22(5):2079–2185, 2022.
- [ABS22b] Byung Hee An, Youngjin Bae, and Tao Su. Augmentations are sheaves for Legendrian graphs. *J. Symplectic Geom.*, 20(2):259–416, 2022.
- [AE22] Johan Asplund and Tobias Ekholm. Chekanov–Eliashberg dg-algebras for singular Legendrians. *J. Symplectic Geom.*, 20(3):509–559, 2022.
- [BEE12] Frédéric Bourgeois, Tobias Ekholm, and Yasha Eliashberg. Effect of Legendrian surgery. *Geom. Topol.*, 16(1):301–389, 2012. With an appendix by Sheel Ganatra and Maksim Maydanskiy.
- [BGF73] Joseph Bernšteĭn, Israel M. Gel’fand, and Vladimir Ponomarev. Coxeter functors, and Gabriel’s theorem. *Uspehi Mat. Nauk*, 28(2(170)):19–33, 1973.

- [BI09] Sebastian Baader and Masaharu Ishikawa. Legendrian graphs and quasipositive diagrams. *Ann. Fac. Sci. Toulouse Math. (6)*, 18(2):285–305, 2009.
- [CDGG17] Baptiste Chantraine, Georgios Dimitroglou Rizell, Paolo Ghiggini, and Roman Golovko. Geometric generation of the wrapped Fukaya category of Weinstein manifolds and sectors. *arXiv e-prints*, page arXiv:1712.09126, December 2017.
- [CE12] Kai Cieliebak and Yakov Eliashberg. *From Stein to Weinstein and back*, volume 59 of *American Mathematical Society Colloquium Publications*. American Mathematical Society, Providence, RI, 2012. Symplectic geometry of affine complex manifolds.
- [CEL10] Kai Cieliebak, Tobias Ekholm, and Janko Latschev. Compactness for holomorphic curves with switching Lagrangian boundary conditions. *J. Symplectic Geom.*, 8(3):267–298, 2010.
- [Che02] Yuri Chekanov. Differential algebra of Legendrian links. *Invent. Math.*, 150(3):441–483, 2002.
- [EGH00] Yakov Eliashberg, Alexander Givental, and Helmut Hofer. Introduction to symplectic field theory. Number Special Volume, Part II, pages 560–673. 2000. GAFA 2000 (Tel Aviv, 1999).
- [Ekh08] Tobias Ekholm. Rational symplectic field theory over \mathbb{Z}_2 for exact Lagrangian cobordisms. *J. Eur. Math. Soc. (JEMS)*, 10(3):641–704, 2008.
- [Ekh19] Tobias Ekholm. Holomorphic curves for Legendrian surgery. *arXiv e-prints*, page arXiv:1906.07228, June 2019.
- [EL17] Tobias Ekholm and Yanki Lekili. Duality between Lagrangian and Legendrian invariants. *arXiv e-prints*, page arXiv:1701.01284, January 2017.
- [EL19] Tolga Etgü and Yanki Lekili. Fukaya categories of plumbings and multiplicative preprojective algebras. *Quantum Topol.*, 10(4):777–813, 2019.
- [Eli18] Yakov Eliashberg. Weinstein manifolds revisited. In *Modern geometry: a celebration of the work of Simon Donaldson*, volume 99 of *Proc. Sympos. Pure Math.*, pages 59–82. Amer. Math. Soc., Providence, RI, 2018.
- [Gei08] Hansjörg Geiges. *An introduction to contact topology*, volume 109 of *Cambridge Studies in Advanced Mathematics*. Cambridge University Press, Cambridge, 2008.
- [GPS18] Sheel Ganatra, John Pardon, and Vivek Shende. Sectorial descent for wrapped Fukaya categories. *arXiv e-prints*, page arXiv:1809.03427, September 2018.
- [HKK17] Fabian Haiden, Ludmil Katzarkov, and Maxim Kontsevich. Flat surfaces and stability structures. *Publ. Math. Inst. Hautes Études Sci.*, 126:247–318, 2017.
- [KS09] Maxim Kontsevich and Yan Soibelman. Notes on A_∞ -algebras, A_∞ -categories and non-commutative geometry. In *Homological mirror symmetry*, volume 757 of *Lecture Notes in Phys.*, pages 153–219. Springer, Berlin, 2009.
- [Mis03] Nikolai Mishachev. The N -copy of a topologically trivial Legendrian knot. *J. Symplectic Geom.*, 1(4):659–682, 2003.
- [Nad17] David Nadler. Arboreal singularities. *Geom. Topol.*, 21(2):1231–1274, 2017.
- [Ng01] Lenhard Lee Ng. *Invariants of Legendrian links*. ProQuest LLC, Ann Arbor, MI, 2001. Thesis (Ph.D.)—Massachusetts Institute of Technology.
- [Ng03] Lenhard Ng. Computable Legendrian invariants. *Topology*, 42(1):55–82, 2003.
- [Sa92] Jacek Świątkowski. On the isotopy of Legendrian knots. *Ann. Global Anal. Geom.*, 10(3):195–207, 1992.
- [Siv11] Steven Sivek. A bordered Chekanov-Eliashberg algebra. *J. Topol.*, 4(1):73–104, 2011.
- [Syl19] Zachary Sylvan. On partially wrapped Fukaya categories. *J. Topol.*, 12(2):372–441, 2019.

DEPARTMENT OF MATHEMATICS, UPPSALA UNIVERSITY, BOX 480, 751 06 UPPSALA, SWEDEN

Email address: martin.backe@math.uu.se