

Triangle Percolation on the Grid

Igor Araujo* Bryce Frederickson† Robert A. Krueger‡
 Bernard Lidický§ Tyrrell B. McAllister¶ Florian Pfender||
 Sam Spiro** Eric Nathan Stucky††

March 28, 2023

Abstract

We consider a geometric percolation process partially motivated by recent work of Hejda and Kala. Specifically, we start with an initial set $X \subseteq \mathbb{Z}^2$, and then iteratively check whether there exists a triangle $T \subseteq \mathbb{R}^2$ with its vertices in \mathbb{Z}^2 such that T contains exactly four points of \mathbb{Z}^2 and exactly three points of X . In this case, we add the missing lattice point of T to X , and we repeat until no such triangle exists. We study the limit sets S , the sets stable under this process, including determining their possible densities and some of their structure.

*Department of Mathematics, University of Illinois at Urbana-Champaign, Urbana, IL. Email: igoraa2@illinois.edu. Research partially supported by UIUC Campus Research Board RB 22000.

†Department of Mathematics, Emory University, Atlanta, GA, E-mail: bfrede4@emory.edu.

‡Department of Mathematics, University of Illinois at Urbana-Champaign, Urbana, IL. Email: rak5@illinois.edu. Research supported the NSF Graduate Research Fellowship Program Grant No. DGE 21-4675.

§Department of Mathematics, Iowa State University, Ames, IA. E-mail: lidicky@iastate.edu. Research of this author is supported in part by NSF grant DMS-2152490 and Scott Hanna fellowship.

¶Department of Mathematics and Statistics, University of Wyoming, Laramie, WY. E-mail: tmcallis@uwyo.edu.

||Department of Mathematical and Statistical Sciences, University of Colorado Denver. E-mail: Florian.Pfender@ucdenver.edu. Research is partially supported by NSF grant DMS-2152498.

**Department of Mathematics, Rutgers University, Piscataway, NJ. Email: sas703@scarletmail.rutgers.edu. Research supported by the NSF Mathematical Sciences Postdoctoral Research Fellowships Program under Grant DMS-2202730.

††E-mail: stuck127@umn.edu. Research partially supported by Czech Science Foundation grant 21-00420M, administered through Charles University, Faculty of Mathematics and Physics, Department of Algebra.

1 Introduction

We study subsets S of the integer lattice \mathbb{Z}^2 that are *stable* with respect to a family of point configurations in the following sense: if S contains all but one point of a configuration in the family, then S contains the entire configuration. The configurations that we consider are of the form $\Delta \cap \mathbb{Z}^2$ where $\Delta \subseteq \mathbb{R}^2$ is a lattice triangle, that is, the convex hull in \mathbb{R}^2 of three non-collinear points in \mathbb{Z}^2 . Such a triangle is determined by the set of integer-lattice points that it contains. Accordingly, we abuse terminology a bit and call a subset $T \subseteq \mathbb{Z}^2$ a *triangle* when T is the set of integer-lattice points in some lattice triangle $\Delta \subseteq \mathbb{R}^2$. Thus, in our terminology, the triangle T is a finite set containing at least three points. We call T a *minimal* triangle if T contains exactly four points. Our interest in this paper is the subsets $S \subseteq \mathbb{Z}^2$ that are stable with respect to minimal triangles. This interest is motivated from two different directions.

First, one can pose this problem in the language of cellular automata or bootstrap percolation. Starting with any initial set $X \subseteq \mathbb{Z}^2$, whenever there is a minimal triangle with exactly three of its four points in our set, we add the missing point to our set. The stable sets are precisely the sets that arise as the limit of this process for some initial set X . The minimal triangles that define this percolation are simple structures, but they allow for long-distance effects to occur in just one step of the process, because the triangles may be extremely thin (see Figure 10). This is different from many of the other percolation rules that have been considered, as most are rather local in effect.

Another inspiration for studying stable sets (in fact, our original motivation) are certain recent developments in the theory of integral universal quadratic forms. Blomer and Kala [2] describe a method for producing bounds on the number of variables required for a quadratic form to be universal over the ring of integers \mathcal{O}_K of a totally real number field K . The primary novelty in their work is to obtain data from the semigroup of totally positive integers \mathcal{O}_K^+ , which is analogous to \mathbb{N} in this setting. In particular, \mathcal{O}_K^+ has a canonical set of generators called *indecomposable* elements.

While attempting to refine this data and improve the bounds available to this method, Hejda and Kala [4] obtained the remarkable result that the *abstract* isomorphism type of \mathcal{O}_K^+ already suffices to determine K when K is a quadratic field extension. The argument in their proof can be reframed as follows: the generators come with a natural linear order $(\dots, x_{-1}, x_0, x_1, \dots)$ such that there is a relation of the form $x_{i-1} + x_{i+1} = c_i x_i$ for all i . Once any two consecutive points are fixed, the other points become fixed one at a time by successively applying these relations. Of course, once all points are fixed then all possible relations are determined; in this sense, all relations among the generators of \mathcal{O}^+ are determined by “local” ones.

For number fields of higher rank, the indecomposable elements of \mathcal{O}^+ are much more elusive, and not much is known about the relations (see, for instance, [3, 5, 6]). Nonetheless, it is natural to wonder if there is an abstract Hejda–Kala type argument showing that only some initial data and the “local” relations could determine the entire semigroup structure of \mathcal{O}^+ . However, we may run into a combinatorial obstruction: at each stage it must be possible to determine at least one additional point from those which have already been determined. In \mathbb{R}^1 it is obvious that this obstruction does not arise, but higher dimensions are less clear; our stable sets may be understood roughly as a worst-case analysis of such obstructions in two dimensions.

1.1 Definitions and results

As mentioned above, we call a subset $T \subseteq \mathbb{Z}^2$ a *triangle* if T is the set of integer-lattice points in the convex hull Δ in \mathbb{R}^2 of three noncollinear points in \mathbb{Z}^2 . Such a triangle T uniquely determines Δ (which is a triangle in the conventional sense) so we may speak of the area, vertices, boundary points, and interior points of T . The triangle T is *unimodular* if the vertices are an affine basis of the lattice \mathbb{Z}^2 over \mathbb{Z} . Equivalently, the unimodular triangles are the triangles that have area $1/2$. Pick's formula $A = i + b/2 - 1$ expresses the area A of T in terms of the number b of lattice points on its boundary and the number i of lattice points in its interior. From this relation, unimodular triangles are easily recognized as precisely the triangles that contain exactly 3 points. A *minimal* triangle is a triangle that contains exactly 4 points. A minimal triangle is either a *border* or an *internal* triangle, depending on whether the fourth point (in addition to the vertices) appears on the boundary or the interior of the triangle. From Pick's formula, the border triangles are precisely the triangles of area 1, and every internal triangle has area $3/2$ (though some triangles of area $3/2$ are not internal triangles).

A unimodular transformation of \mathbb{Z}^2 is an affine-linear bijection from \mathbb{Z}^2 to \mathbb{Z}^2 . Equivalently, the unimodular transformations of \mathbb{Z}^2 are the maps of the form $x \mapsto Mx + b$, where M is a 2×2 matrix with integer entries and determinant ± 1 , and $b \in \mathbb{Z}^2$. Note that unimodular transformations also preserve the number of lattice points on a line segment. Thus unimodular transformations preserve the property of a triangle's being unimodular, border, or internal, respectively.

Let S be a subset of \mathbb{Z}^2 . We say that S is *B-stable* if no border triangle has exactly three of its points in S . We call S *I-stable* if no internal triangle has exactly three of its points in S . Finally, we call S *BI-stable* if S is both B-stable and I-stable. Since \mathbb{Z}^2 itself is BI-stable, we say that a proper subset S of \mathbb{Z}^2 is a *maximal* B/I/BI-stable set if S is B/I/BI-stable and no B/I/BI-stable proper subset of \mathbb{Z}^2 properly contains S .

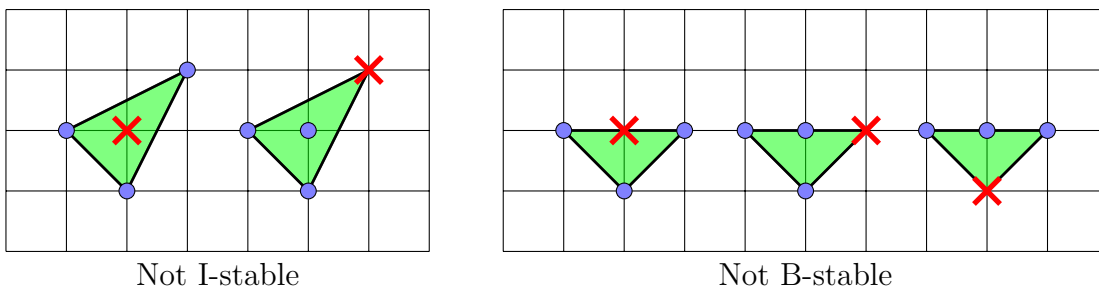

Figure 1: Configurations that are not stable. Specifically, if a set contains only the three blue points in one of the minimal triangles but not the red cross in that triangle, then that triangle demonstrates that the set is not stable in the indicated sense.

Roughly speaking, our results fall into two categories: Results regarding the possible densities of B/I/BI-stable sets, and results regarding the existence and uniqueness of B/I/BI-stable subsets that satisfy various conditions, such as maximality or the presence of particular point-configurations.

Our first two theorems summarize our results on the densities of stable sets. We define the

(upper) density of a subset $X \subseteq \mathbb{Z}^2$ to be

$$\bar{\delta}(X) := \limsup_{n \rightarrow \infty} \frac{|X \cap [-n, n]^2|}{|[-n, n]^2|},$$

where, here and throughout, $[a, b]$ denotes the interval of integers $\{i \in \mathbb{Z} : a \leq i \leq b\}$. While $\bar{\delta}(X)$ is a fairly natural way to define the density of a subset $X \subseteq \mathbb{Z}^2$, it is not always true that $\bar{\delta}(\varphi(X)) = \bar{\delta}(X)$ for every unimodular transformation φ . However, this property does hold if X is periodic in two independent directions, which will be the case for most of the subsets $X \subseteq \mathbb{Z}^2$ that we consider. Our first theorem gives the possible values of these densities for stable sets (periodic or aperiodic).

Theorem 1.1. *Let $S \subsetneq \mathbb{Z}^2$.*

- (a) *If S is B-stable, then $\bar{\delta}(S) \leq 1/4$. Moreover, for every $\delta \leq 1/4$, there exists a BI-stable set S with $\bar{\delta}(S) = \delta$; for instance, every subset of $2\mathbb{Z}^2$ is BI-stable.*
- (b) *If S is I-stable, then $\bar{\delta}(S) \leq 1/2$. Moreover, for every $\delta \leq 1/2$, there exists an I-stable set S with $\bar{\delta}(S) = \delta$; for instance, every subset of $\mathbb{Z} \times 2\mathbb{Z}$ is I-stable.*

The two upper bounds in Theorem 1.1 are proved in Propositions 3.5 and 4.12, respectively. The BI-stability of $2\mathbb{Z}^2$ and its subsets is Corollary 2.2, and the I-stability of $\mathbb{Z} \times 2\mathbb{Z}$ and its subsets is Corollary 4.3.

For B-stable sets (and in particular for BI-stable sets), the upper bound in Theorem 1.1 is attained by $2\mathbb{Z}^2$. Our next theorem shows that any stable set that is “structurally far” from $2\mathbb{Z}^2$ must have a significantly lower density. That is, the maximally dense construction for B-stable sets is “stable” in the sense commonly used in extremal combinatorics. In order to state this result precisely, we define the (lower) consecutive density $\underline{\gamma}(X)$ of a set $X \subseteq \mathbb{Z}^2$ as follows: Let $\Gamma(X)$ denote the set of points $(x, y) \in X$ such that $(x + 1, y) \in X$, and let

$$\underline{\gamma}(X) := \liminf_{n \rightarrow \infty} \frac{|\Gamma(X) \cap [-n, n]^2|}{|[-n, n]^2|}.$$

Thus, the consecutive density provides one measure of the “distance” between a set $X \subseteq \mathbb{Z}^2$ and $2\mathbb{Z}^2$. We show that, for B-stable proper subsets $S \subsetneq \mathbb{Z}^2$, if $\underline{\gamma}(S)$ is large, then $\bar{\delta}(S)$ must be correspondingly smaller than the maximum given by Theorem 1.1. The following is proved in Section 3.1.

Theorem 1.2. *If $S \subsetneq \mathbb{Z}^2$ is B-stable (in particular, if S is BI-stable), then $\underline{\gamma}(S) \leq 1/9$ and $\bar{\delta}(S) \leq (1 - \underline{\gamma}(S))/4$. Moreover, there is a BI-stable sets S with $\underline{\gamma}(S) = 1/9$ and $\bar{\delta}(S) = 2/9$, and a BI-stable set S' with $\underline{\gamma}(S') = 0$ and $\bar{\delta}(S') = 1/4$.*

We remark that no analogous result is possible for I-stable sets. For example, there exist two very different I-stable sets I_2 and $J_{1/2}$ that both have the maximum possible density $1/2$. (See Constructions 4.1 and 4.4 below for the definitions of I_2 and $J_{1/2}$, respectively.)

Our next two theorems summarize our results regarding the existence and uniqueness of stable sets under various conditions. The next theorem shows that, if a stable set S contains certain small configurations, then S must be one of a very few different sets. For the definitions of the sets $J_{1/4}$ and $J_{1/2}$ referred to in the theorem, see Construction 4.4 and Figure 6 below.

Theorem 1.3. *Let $S \subseteq \mathbb{Z}^2$.*

- (a) *If S is B-stable and contains any three points of a border triangle, then $S = \mathbb{Z}^2$.*
- (b) *If S is BI-stable and contains any three points of a minimal triangle, then $S = \mathbb{Z}^2$.*
- (c) *If S is I-stable and contains any three points of an internal triangle, then, up to a unimodular transformation, S is one of $J_{1/4}$, $J_{1/2}$, or \mathbb{Z}^2 .*

Parts (a) and (b) of Theorem 1.3 are proved in Proposition 3.1, while Part (c) follows from Corollary 4.10. Note that, in particular, if S contains a unimodular triangle, then S meets all of the “contains any three points . . .” conditions in Theorem 1.3.

Our final theorem summarizes our results regarding maximal stable sets. The first two parts of this theorem show that the study of stable sets reduces to the study of maximal stable sets.

Theorem 1.4.

- (a) *If S is a proper B/BI-stable subset of \mathbb{Z}^2 , then every subset of S is B/BI-stable (of the same stability type).*
- (b) *If S is an I-stable subset of \mathbb{Z}^2 that is not, up to unimodular transformation, either $J_{1/4}$, $J_{1/2}$, or \mathbb{Z}^2 , then every subset of S is I-stable.*
- (c) *Every proper B/I/BI-stable subset of \mathbb{Z}^2 is contained in a maximal B/I/BI-stable set (of the same stability type).*
- (d) *There exist non-periodic maximal B/I/BI-stable sets.*

Part (a) of Theorem 1.4 is proved in Corollary 3.2. Part (b) follows from Corollary 4.11. Part (c) is proved in Proposition 5.3, and Part (d) is proved in Propositions 5.4 and 5.5.

This paper is organized as follows. In Sections 2, 3, and 4 we consider BI-stable, B-stable, and I-stable sets respectively. In Section 5 we study maximal stable sets. We conclude with some open problems in Section 6.

2 BI-stable Sets

In this section we give several constructions of BI-stable sets. Here and throughout, we use the standard notations

$$nX := \{nx : x \in X\}, \quad X + Y := \{x + y : x \in X \text{ and } y \in Y\}, \quad X + z := X + \{z\},$$

for integers $n \in \mathbb{Z}$, subsets $X, Y \subseteq \mathbb{Z}^2$, and points $z \in \mathbb{Z}^2$. We will also write $[n]$ for the interval $[1, n] = \{1, \dots, n\}$ of integers.

Our first construction is the set $n\mathbb{Z}^2$; see Figure 2 for the case $n = 2$.

Proposition 2.1. *Let $n \geq 2$. Every minimal triangle intersects $n\mathbb{Z}^2$ in at most 2 points. In particular, every subset of $n\mathbb{Z}^2$ is BI-stable.*

Proof. The line segment between any two points of $n\mathbb{Z}^2$ contains at least $n+1 \geq 3$ lattice points including the endpoints, so any triangle containing at least three points of $n\mathbb{Z}^2$ will contain at least $2n+1 > 4$ lattice points and thus cannot be a border or internal triangle. \square

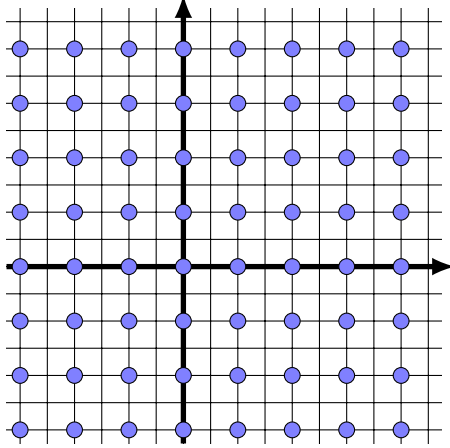

Figure 2: The blue points denote $2\mathbb{Z}^2$, a BI-stable set of density $1/4$.

With this lemma we can prove the existence statement of Theorem 1.1(a) for BI-stable sets with small density.

Corollary 2.2. *For every $\delta \leq 1/4$, there exists a set $S \subseteq 2\mathbb{Z}^2$ with $\bar{\delta}(S) = \delta$ that is BI-stable (and hence also B-stable and I-stable).*

Proof. Let $X^{(0)} := \emptyset$, and iteratively define $X^{(n)} \subseteq 2\mathbb{Z}^2 \cap [-n, n]^2$ to be any set containing $X^{(n-1)}$ and which has exactly $\min\{\lfloor \delta(2n+1)^2 \rfloor, |2\mathbb{Z}^2 \cap [-n, n]^2|\}$ points of $2\mathbb{Z}^2$. Let $S := \bigcup_{i \geq 0} X^{(i)}$. By construction we have $\bar{\delta}(S) = \delta$. Since S is a subset of $2\mathbb{Z}^2$, S is BI-stable by Proposition 2.1. \square

We know of no other maximal BI-stable sets with upper density $1/4$ besides $2\mathbb{Z}^2$ and its unimodular transforms; see Question 6.1 for more on this. In fact, Theorem 1.2 shows that any BI-stable set that is “far” from $2\mathbb{Z}^2$ (in a certain precise sense) has density strictly smaller than $1/4$. The following gives an example of a BI-stable set that is “far” from $2\mathbb{Z}^2$ and which still has a relatively large density of $2/9$. See Figure 3 for an illustration.

Construction 2.3. Let $S_{2/9}^* := \{(0, 0), (1, 0)\}$ and $S_{2/9} = S_{2/9}^* + 3\mathbb{Z}^2$.

Proposition 2.4. *The set $S_{2/9}$ is BI-stable with $\bar{\delta}(S_{2/9}) = 2/9$.*

Proof. First, recall that the area of a triangle with vertices (a_1, a_2) , (b_1, b_2) , and (c_1, c_2) is

$$\frac{1}{2} \det \begin{bmatrix} b_1 - a_1 & b_2 - a_2 \\ c_1 - a_1 & c_2 - a_2 \end{bmatrix}.$$

When these vertices are in $S_{2/9}$, the second column of this matrix is a multiple of 3, and thus the area of any such triangle is a multiple of $3/2$.

Thus $S_{2/9}$ contains neither any unimodular triangle nor the vertices of any border triangle. Therefore, it intersects any border triangle in at most 2 points and so is B-stable.

Moreover, by the pigeonhole principle, among any three points in $S_{2/9}$ there must be at least two points that are in the same equivalence class modulo $3\mathbb{Z}^2$. These two points have at least two additional lattice points on the line segment joining them. Therefore, $S_{2/9}$ does not contain the vertices of any internal triangle. As noted before, $S_{2/9}$ also does not contain a unimodular triangle, and thus $S_{2/9}$ intersects any internal triangle in at most 2 points. Therefore, $S_{2/9}$ is also I-stable. \square

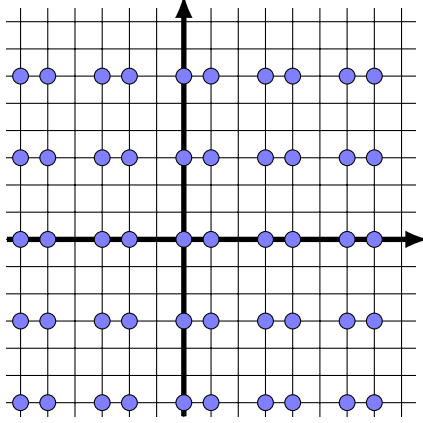

Figure 3: The blue points are from $S_{2/9}$, a BI-stable set of density $2/9$ defined in Construction 2.3.

The proofs in this section showed that the relevant sets S are BI-stable by using a stronger property, namely that S contains at most two points of any minimal triangle. This is not a coincidence; as we shall soon see (Proposition 3.1(b) below), this property is equivalent to BI-stability for proper subsets of the integer lattice.

3 B-stable Sets

In this section we establish our bounds on B-stable sets, namely that $\bar{\delta}(S) \leq 1/4$ whenever $S \subsetneq \mathbb{Z}^2$ is a B-stable set. Our most important structural result towards this end is the following.

Proposition 3.1. *Let $S \subsetneq \mathbb{Z}^2$. Then S is:*

- (a) *B-stable if and only if S contains at most 2 points from any border triangle, and*
- (b) *BI-stable if and only if S contains at most 2 points from any minimal triangle.*

Proof. We begin with part (a). Evidently, if S contains at most 2 points from any border triangle, then by definition S is B-stable. Conversely, assume that S is B-stable but contains at least 3 points from a border triangle, which implies S contains all 4 points of this border triangle. Applying a unimodular transformation to S , we may assume without loss of generality that this triangle is $\{(0, 0), (1, 0), (2, 0), (0, 1)\}$. Observe that, for each $t \in \mathbb{Z}$, each of the border triangles $\{(0, 0), (1, 0), (2, 0), (t, 1)\}$ intersects S in at least three points, and so the B-stability of S implies that S contains every point of the form $(t, 1)$. Thus, S intersects each of the triangles $\{(0, 1), (1, 1), (2, 1), (t, 2)\}$ in at least three points, and hence contains every point of the form $(t, 2)$. Iterating this procedure, both up and down \mathbb{Z}^2 , we conclude that $S = \mathbb{Z}^2$, completing the proof of part (a).

We will show that part (b) follows from part (a). As before, containing at most two points from any minimal triangle immediately implies BI-stability. Conversely, if $S \subsetneq \mathbb{Z}^2$ is BI-stable, then S contains at most 2 points from any border triangle by part (a); if S contains at least 3 points from an internal triangle, then S contains that internal triangle. Applying a unimodular transformation, we may assume without loss of generality that this triangle has

points $\{(0, 0), (1, 0), (-1, -1), (0, 1)\}$. But then this triangle contains 3 points $(0, 0), (1, 0), (0, 1)$ from a border triangle, a contradiction. \square

Corollary 3.2. *If $S \subsetneq \mathbb{Z}^2$ is a B-stable set, then any subset of S is also B-stable. Similarly, if $S \subsetneq \mathbb{Z}^2$ is a BI-stable set, then any subset of S is also BI-stable.*

Corollary 3.2 follows immediately from Proposition 3.1 and yields a large supply of examples. We note that the situation for I-stable sets is somewhat more complicated (see Corollary 4.10).

With Proposition 3.1 we can also quickly derive the following.

Lemma 3.3. *If $S \subsetneq \mathbb{Z}^2$ is B-stable, then $|S \cap ([3] \times [2])| \leq 2$.*

Proof. Let $S \subsetneq \mathbb{Z}^2$ be B-stable. If S contains at least three points of $[3] \times [2]$, then without loss of generality we can assume it contains at least two points from the set $X := \{(1, 1), (2, 1), (3, 1)\}$. If S contains X , then S contains three points of a border triangle, contradicting Proposition 3.1. Otherwise, S contains two points of X and some point of the form $(x, 2)$, and so again X contains three points of a border triangle. \square

From this result, it follows that $\bar{\delta}(S) \leq 1/3$ for any B-stable set $S \subsetneq \mathbb{Z}^2$. To see this, note first that any translate of S is also B-stable, and therefore S contains at most two points of any translate of $[3] \times [2]$. Now cover $[-n, n]^2$ by $\lceil \frac{2n+1}{3} \rceil^2$ translates of $[3] \times [2]$. By the previous lemma we know that S contains at most a third of the points from each of these translates, giving the bound.

We prove the optimal bound $\bar{\delta}(S) \leq 1/4$ similarly, using the following more subtle replacement of Lemma 3.3.

Lemma 3.4. *If $S \subsetneq \mathbb{Z}^2$ is B-stable, then $|S \cap [6]^2| \leq 9$.*

We provide two proofs of this result. The first uses a computer search, the code for which may be found in the supplementary files. For this we simply exhaustively checked that all B-stable subsets of $[6]^2$ are either $[6]^2$ or have at most 9 points. However, we also give a human-readable proof, which can be found in the appendix.

We now prove our main result for this section, which together with Corollary 2.2 completes the proof of Theorem 1.1(a).

Proposition 3.5. *If $S \subsetneq \mathbb{Z}^2$ is B-stable, then $\bar{\delta}(S) \leq 1/4$.*

Proof. Cover $[-n, n]^2$ by $\lceil \frac{2n+1}{6} \rceil^2$ pairwise disjoint translates of $[6] \times [6]$. By Lemma 3.4, each of these translates contains at most 9 points of S , for a total of at most

$$9 \left\lceil \frac{2n+1}{6} \right\rceil^2 \leq 9 \left(\frac{2n+1}{6} + \frac{5}{6} \right)^2 = \frac{1}{4}((2n+1)^2 + 20n + 35)$$

points in $S \cap [-n, n]^2$. \square

Remark 3.6. The $[6] \times [6]$ translates used in the proof of Proposition 3.5 are the smallest translates that are able to prove the theorem this way. Indeed, for every $a < 6$ and every b , at least one of the B-stable sets $2\mathbb{Z}^2$ or $S_{2/9}$ from Construction 2.3 has more than $1/4$ of the points in $[0, a-1] \times [0, b]$.

3.1 Consecutive pairs in B-stable sets

Here we prove Theorem 1.2, which roughly says that if a B-stable set has many consecutive pairs, then its density cannot be close to the maximum of $1/4$. For this we need two lemmas concerning $\Gamma(S)$, which we recall is the set of points $(x, y) \in S$ such that $(x + 1, y) \in S$.

Lemma 3.7. *Let $S \subsetneq \mathbb{Z}^2$ be a B-stable set. Then $|\Gamma(S) \cap [3]^2| \leq 1$.*

Proof. Suppose $(x, y) \in \Gamma(S) \cap [3]^2$, which means $(x, y), (x + 1, y) \in S$. Checking all the cases, we easily see that any additional point (x', y') with $|x - x'| \leq 2$ and $|y - y'| \leq 2$ other than $(x - 2, y)$ is in a border triangle with (x, y) and $(x + 1, y)$, so $(x', y') \notin S$ by Proposition 3.1, and thus $(x', y') \notin \Gamma(S)$. Finally, $(x - 2, y) \notin \Gamma(S)$ since $(x - 1, y) \notin S$. \square

We obtained the next result by computer search, similar to Lemma 3.4. The code we used may be found in the supplementary files.

Lemma 3.8. *Let $S \subsetneq \mathbb{Z}^2$ be a B-stable set. If $\Gamma(S) \cap ([6] \times [12]) \neq \emptyset$, then*

$$|S \cap ([6] \times [12])| \leq 16.$$

We note that Lemma 3.4 implies that for any $S \subsetneq \mathbb{Z}^2$ which is B-stable, $|S \cap ([6] \times [12])| \leq 18$, so Lemma 3.4 says we have a stronger bound provided $\Gamma(S) \cap ([6] \times [12]) \neq \emptyset$. We can now prove Theorem 1.2.

Proof of Theorem 1.2. Let $S \subsetneq \mathbb{Z}^2$ be B-stable. To prove that $\underline{\gamma}(S) \leq 1/9$, we use a similar argument as in the proof of Proposition 3.5. Cover $[-n, n]^2$ by $\lceil \frac{2n+1}{3} \rceil^2$ translates of $[3]^2$, each of which contains at most one point of $\Gamma(S)$ by Lemma 3.7. This implies the desired result.

Now we prove that $\bar{\delta}(S) \leq \frac{1}{4}(1 - \underline{\gamma}(S))$. Let $\varepsilon > 0$, and choose n large enough such that

$$|\Gamma(S) \cap [-n, n]^2| \geq (\underline{\gamma}(S) - \varepsilon)(2n + 1)^2 \geq (\underline{\gamma}(S) - \varepsilon)4n^2. \quad (1)$$

Call a translate of $[6] \times [12]$ *deficient* if it contains a point in $\Gamma(S)$. By Lemma 3.8, such a deficient translate contains at most 16 points in S . Since $[6] \times [12]$ can be covered by 8 translates of $[3]^2$, we have by Lemma 3.7 that every translate of $[6] \times [12]$ contains at most 8 points in $\Gamma(S)$.

Cover $[-n, n]^2$ with $2 \lceil \frac{2n+1}{12} \rceil^2$ translates of $[6] \times [12]$. Using (1), this implies that there are at least $\frac{1}{2}(\underline{\gamma}(S) - \varepsilon)n^2$ deficient translates among these. Therefore,

$$\begin{aligned} |S \cap [-n, n]^2| &\leq 18 \times 2 \left\lceil \frac{2n+1}{12} \right\rceil^2 - 2 \times \frac{1}{2}(\underline{\gamma}(S) - \varepsilon)n^2 \\ &\leq (1 - \underline{\gamma}(S) + \varepsilon)n^2 + 12n + 36 \\ &< \frac{1}{4}(1 - \underline{\gamma}(S) + \varepsilon)(2n + 1)^2 + 12n + 36. \end{aligned}$$

Since $\varepsilon > 0$ was chosen arbitrarily, this shows that $\bar{\delta}(S) \leq (1 - \underline{\gamma}(S))\frac{1}{4}$.

The bound $\underline{\gamma}(S) \leq 1/9$ is best possible, as exhibited by $S_{2/9}$ from Construction 2.3. Similarly the bounds on $\bar{\delta}(S)$ are best possible when $\underline{\gamma}(S) \in \{0, 1/9\}$ by considering $2\mathbb{Z}^2$ and $S_{2/9}$, respectively. \square

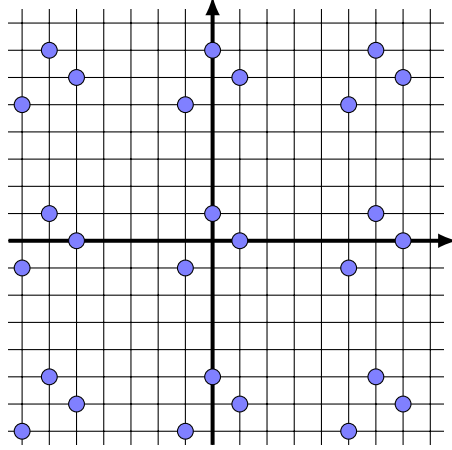

Figure 4: The blue points are from $B_{1/12}$, a B-stable set of density $1/12$ that is not I-stable. See Construction 3.11.

Remark 3.9. As with Remark 3.6, the $[6] \times [12]$ translates used in the proof of Theorem 1.2 are the smallest translates which work for this purpose. Indeed, by Remark 3.6 such an $[a] \times [b]$ window should have a and b divisible by 6, but there are B-stable sets $S \subseteq [6] \times [6]$ with $\Gamma(S) \neq \emptyset$ and $|S| = 9$, as shown in Figure 13.

Remark 3.10. We do not expect the bound $\bar{\delta}(X) \leq (1 - \underline{\gamma}(X))\frac{1}{4}$ for B-stable $X \subsetneq \mathbb{Z}^2$ to be sharp for all values of $\underline{\gamma}(X)$. In fact, we can not rule out that having even a single consecutive pair in X decreases its density by a fixed constant; see Question 6.2.

3.2 B-stability without BI-stability

Most of the constructions of B-stable sets that we know of are also BI-stable. However, the following gives an example of a set of positive density which is B-stable but not BI-stable.

Construction 3.11. Let $B_{1/12}^* := \{(1, 0), (0, 1), (-1, -1)\}$ and $B_{1/12} := B_{1/12}^* + 6\mathbb{Z}^2$; see Figure 4.

Proposition 3.12. *The set $B_{1/12}$ is B-stable, but not I-stable, with $\bar{\delta}(B_{1/12}) = 1/12$.*

Proof. First note that $B_{1/12}$ is not I-stable, since $B_{1/12}^*$ are the three vertices of an internal triangle, but $B_{1/12}$ does not contain the fourth point, $(0, 0)$. It is easy to check that $\bar{\delta}(B_{1/12}) = 3/36 = 1/12$.

To check that $B_{1/12}$ is B-stable, we let x, y , and z be three points in $B_{1/12}$ and prove that they are not contained in the same border triangle. To do this, it suffices to confirm they are not all consecutive lattice points in any line, and also that they do not form a triangle of area 1 or $1/2$.

By way of contradiction, suppose first that x, y and z are collinear and consecutive. In particular this means that, without loss of generality, $x + y = 2z$. Since $(1, 0)$, $(0, 1)$, and $(-1, -1)$ do not satisfy this relation in any permutation, x, y , and z cannot all be distinct mod $6\mathbb{Z}^2$. But if, say, x and y are equal mod $6\mathbb{Z}^2$, there are at least 5 lattice points on the line between them; only one of these could be z and hence x, y , and z are not consecutive.

Suppose instead that x , y , and z are vertices of a triangle. The area of that triangle is, up to sign, half the determinant of the matrix with columns $y - x$ and $z - x$. Thus, we need to show that this determinant is never ± 1 or ± 2 . If any two points are equal mod $6\mathbb{Z}^2$ then this determinant is divisible by 6. Otherwise, modulo 6, this determinant (up to sign) is

$$\det \begin{bmatrix} 2 & 1 \\ 1 & 2 \end{bmatrix} = 3 \pmod{6}.$$

Thus the determinant is not ± 1 or ± 2 , so x , y , and z are not contained together in any border triangle. \square

4 I-stable Sets

We start our analysis of I-stable sets by giving a construction which achieves upper density $1/2$.

Construction 4.1. For $n \geq 1$, let $I_n := \mathbb{Z} \times (n\mathbb{Z})$. See Figure 5 for I_2 .

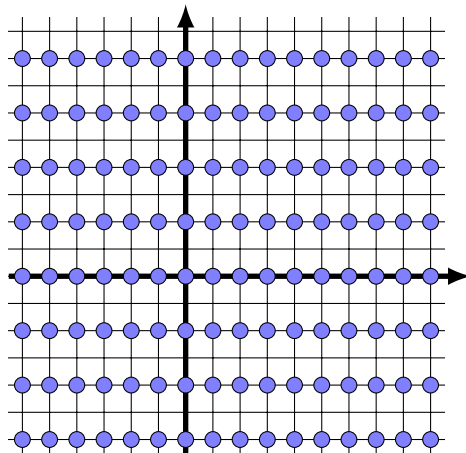

Figure 5: The I-stable set I_2 from Construction 4.1.

Lemma 4.2. *If $n \neq 1, 3$, then every internal triangle intersects I_n in at most two points.*

Proof. From Pick's theorem, it is easy to see that every three points of an internal triangle have a convex hull of area $1/2$ or $3/2$. We also recall that the area of the convex hull of $(0, 0)$, (a, b) and (c, d) is

$$\frac{1}{2} \begin{vmatrix} a & b \\ c & d \end{vmatrix} = \frac{ad - bc}{2}.$$

Thus the area of the convex hull of any three points of I_n is an integral multiple of $\frac{n}{2}$. Since $n \neq 1, 3$, we conclude that no internal triangle intersects three points of I_n . \square

Since every subset of I_n also intersects every internal triangle in at most two points, we conclude that every subset of I_n is I-stable, which gives the following corollary.

Corollary 4.3. *For every $\delta \leq 1/2$, there exists an I-stable set I with $\bar{\delta}(I) = \delta$.*

We now work towards proving that every I-stable set has density at most $1/2$. The analogue of Proposition 3.1 for I-stable sets does not hold, and in particular there exist I-stable sets that contain a unimodular triangle. However, these sets turn out to be highly structured. For this we need the following constructions.

Construction 4.4. Let $J_{1/4}^* := \{(0, 0), (1, 0), (0, 1), (-1, -1)\}$. Define $J_{1/4} := J_{1/4}^* + 4\mathbb{Z}^2$ and $J_{1/2} := J_{1/4} \cup (J_{1/4} + (2, 2))$. See Figure 6.

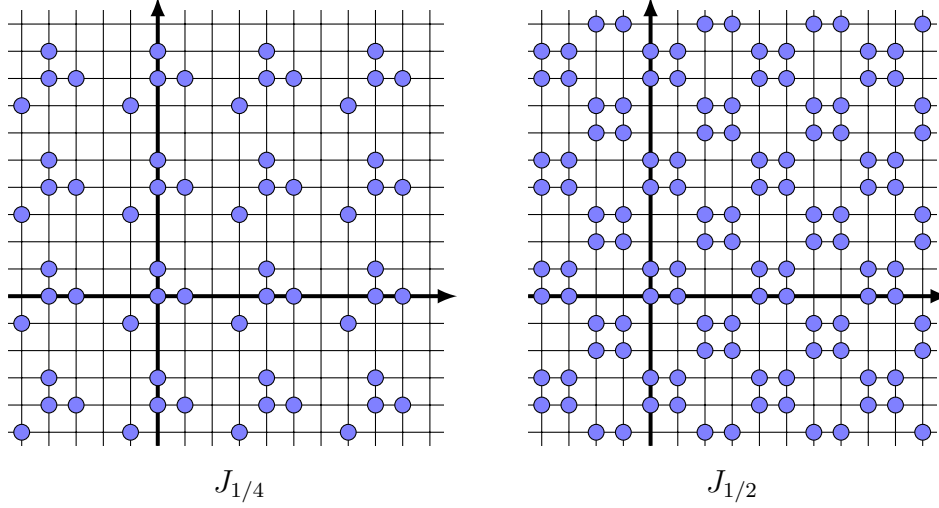

Figure 6: The I-stable sets $J_{1/4}$ and $J_{1/2}$ from Construction 4.4.

The following lemmas show that I-stable sets containing a unimodular triangle must contain some unimodular transformation of $J_{1/4}$; containing any other point in addition to $J_{1/4}$ forces the containment of a unimodular transformation of $J_{1/2}$; and containing any other point in addition to $J_{1/2}$ forces the I-stable set to be the entire grid \mathbb{Z}^2 .

Lemma 4.5. *Let S be an I-stable set containing $\{(0, 0), (0, 1), (1, 0)\}$. Then $J_{1/4} \subseteq S$.*

Proof. Let S be the intersection of all I-stable sets that contain $\{(0, 0), (0, 1), (1, 0)\}$. Since an intersection of I-stable sets is I-stable, S is an I-stable set, and so S is minimal under inclusion among the I-stable sets containing $\{(0, 0), (0, 1), (1, 0)\}$. Note that $(-1, -1) \in S$ since S contains the other three points of the internal triangle $J_{1/4}^*$, so $J_{1/4}^* \subseteq S$.

By the minimality of S , if a unimodular map U fixes $J_{1/4}^*$, then U also fixes S . Note that the unimodular maps

$$x \mapsto \begin{bmatrix} 0 & -1 \\ 1 & -1 \end{bmatrix} x \quad \text{and} \quad x \mapsto \begin{bmatrix} -1 & 1 \\ -1 & 0 \end{bmatrix} x$$

fix $J_{1/4}^*$ and map $J_{1/4}^* + (4, 0)$ to $J_{1/4}^* + (0, 4)$ and $J_{1/4}^* + (-4, -4)$, respectively. Thus if we show that S contains $J_{1/4}^* + (4, 0)$, then S must contain $J_{1/4}^* + (0, 4)$ and $J_{1/4}^* + (-4, -4)$. By similar reasoning, S must contain $J_{1/4}^* + (0, 4) + (-4, -4) = J_{1/4}^* + (-4, 0)$ and $J_{1/4}^* + (4, 0) + (-4, -4) = J_{1/4}^* + (0, -4)$, and thus S contains $J_{1/4}$.

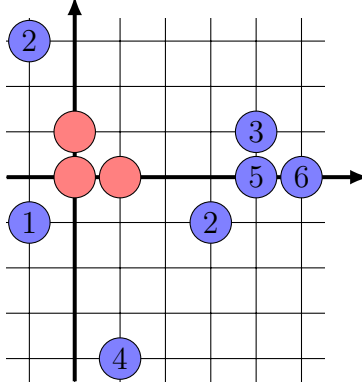

Figure 7: An I-stable set S containing $\{(0,0), (0,1), (1,0)\}$ (in red) must contain $J_{1/4}^*$ and $J_{1/4}^* + (4,0)$. The points are labeled according to the order in which their membership in S is demonstrated in the proof of Lemma 4.5.

To show that S contains $J_{1/4}^* + (4,0)$, we compute as follows (see Figure 7):

$$\begin{aligned}
(0,0), (1,0), (0,1) \in S &\implies (-1,-1) \in S, \\
(0,0), (1,0), (0,1) \in S &\implies (3,-1), (-1,3) \in S, \\
(0,0), (1,0), (-1,-1) \in S &\implies (4,1) \in S, \\
(0,0), (0,1), (-1,3) \in S &\implies (1,-4) \in S, \\
(1,-4), (3,-1), (4,1) \in S &\implies (4,0) \in S, \\
(3,-1), (4,1), (4,0) \in S &\implies (5,0) \in S. \quad \square
\end{aligned}$$

This lemma already shows that any I-stable set containing a unimodular triangle contains $J_{1/4}$, since any unimodular triangle is the image of $\{(0,0), (0,1), (1,0)\}$ under some unimodular transformation. The following lemma with $J_{1/2}$ appears more modest, but see Corollary 4.10 for the analogous conclusion.

Lemma 4.6. *Let S be an I-stable set containing $\{(0,0), (0,1), (1,0), (1,1)\}$. Then $J_{1/2} \subseteq S$.*

Proof. We immediately have that $J_{1/4} \subseteq S$ by Lemma 4.5. In addition, $J_{1/4}^* + (2,2) \subseteq S$ because

$$\begin{aligned}
(0,0), (1,0), (1,1) \in S &\implies (2,3) \in S, \\
(0,0), (0,1), (1,1) \in S &\implies (3,2) \in S, \\
(1,0), (0,1), (1,1) \in S &\implies (2,2) \in S.
\end{aligned}$$

Thus, again by Lemma 4.5, we have that $J_{1/4} + (2,2) = J_{1/4}^* + (2,2) + 4\mathbb{Z}^2 \subseteq S$. \square

We prove below that $J_{1/4}$ and $J_{1/2}$ are in fact I-stable. The case analyses in these proofs will make frequent use of the following elementary lemma. Given vectors $a, b \in \mathbb{Z}^2$, we write $\det(a, b)$ for the determinant of the 2×2 matrix with first column a and second b .

Lemma 4.7. *Let $\{a, b, c, d\} \subseteq \mathbb{Z}^2$ be an internal triangle, and let $a_0 \equiv a$, $b_0 \equiv b$, $c_0 \equiv c$, and $d_0 \equiv d$, modulo $4\mathbb{Z}^2$. Then $a_0 + b_0 + c_0 + d_0 \equiv 0 \pmod{4\mathbb{Z}^2}$ and $\det(b_0 - a_0, c_0 - a_0) \equiv \pm 1 \pmod{4}$.*

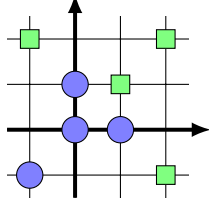

Figure 8: Blue circles indicate the points in $[-1, 2]^2 \cap J_{1/4}$. Green squares indicate the points in $[-1, 2]^2 \cap J_{1/2} \setminus J_{1/4}$.

Note that the points a_0, b_0, c_0, d_0 in Lemma 4.7 are not necessarily *uniformly* translated copies of a, b, c, d , so they may no longer form a minimal triangle.

Proof of Lemma 4.7. Let $T := \{a, b, c, d\}$. It is not difficult to show that for any internal triangle, the lattice points that it contains are its centroid and its vertices. If, without loss of generality, a is the centroid of T , then $3a = b + c + d$, and so $a_0 + b_0 + c_0 + d_0 \equiv a + b + c + d \equiv 0 \pmod{4\mathbb{Z}^2}$.

To prove the second claim, note that, modulo 4, $\det(b_0 - a_0, c_0 - a_0) \equiv \det(b - a, c - a) \in \{\pm 1, \pm 3\}$ since if a, b, c form a unimodular triangle, then the determinant is ± 1 , and otherwise, a, b, c are the vertices of T so the determinant is ± 3 . \square

We now prove that $J_{1/4}$ and $J_{1/2}$ are stable.

Proposition 4.8. *The set $J_{1/4}$ is I-stable with $\bar{\delta}(J_{1/4}) = 1/4$.*

Proof. Let T be an internal triangle that intersects $J_{1/4}$ in at least three points a, b , and c . We show that the fourth point d of T is in $J_{1/4}$.

By construction, the points a, b, c are respectively congruent modulo $4\mathbb{Z}^2$ to points a_0, b_0, c_0 in $J_{1/4}^*$. By Lemma 4.7, the points a_0, b_0, c_0 are pairwise distinct and d is congruent to a point d_0 in $[-1, 2]^2$ that satisfies the congruence $a_0 + b_0 + c_0 + d_0 \equiv 0 \pmod{4\mathbb{Z}^2}$. By checking each of the four subsets of $J_{1/4}^*$ that may equal $\{a_0, b_0, c_0\}$, one finds in each case that this congruence forces $d_0 \in J_{1/4}^*$, and so $d \in J_{1/4}$, as desired. \square

Proposition 4.9. *The set $J_{1/2}$ is I-stable with $\bar{\delta}(J_{1/2}) = 1/2$.*

Proof. Let T be an internal triangle that intersects $J_{1/2}$ in at least three points a, b , and c , and let d be the fourth point of T . Let a_0, b_0, c_0, d_0 be the points in $[-1, 2]^2$ that are congruent to a, b, c, d , respectively, modulo $4\mathbb{Z}^2$.

By rotating T by 90 degrees about the rational point $(\frac{1}{2}, \frac{1}{2})$ some integer number of times, and then adding the vector $(2, 2)$ if necessary, we may assume without loss of generality that $a_0 = (0, 0)$. If $b_0, c_0 \in [-1, 2]^2 \cap J_{1/4}$, then the claim follows from Proposition 4.8, so assume without loss of generality that $c_0 \in X \cap J_{1/2} \setminus J_{1/4}$; see Figure 8.

If $b_0 \in [-1, 2]^2 \cap J_{1/4}$, then, after reflecting about the line $x = y$ if necessary, we have that $b_0 \in \{(1, 0), (-1, -1)\}$. If $b_0 = (1, 0)$, then the condition that $\det(b_0, c_0) \equiv \pm 1 \pmod{4}$ forces $c_0 \in \{(2, -1), (1, 1)\}$, while if $b_0 = (-1, -1)$, then (after reflecting about the line $x = y$ if necessary), we likewise have that $c_0 = (2, -1)$.

On the other hand, if $b_0 \in [-1, 2]^2 \cap J_{1/2} \setminus J_{1/4}$, then, up to reflection about the line $x = y$, we have that $b_0 \in \{(1, 1), (2, 2), (2, -1)\}$. However, $b_0 = (2, 2)$ is impossible because no value

of $c_0 \in [-1, 2]^2 \cap J_{1/2} \setminus J_{1/4}$ satisfies $\det((2, 2), c_0) \equiv \pm 1 \pmod{4}$, so in fact $b_0 \in \{(1, 1), (2, -1)\}$ in this case. If $b_0 = (1, 1)$, then, up to reflection about the line $x = y$, $c_0 = (2, -1)$, while if $b_0 = (2, -1)$, then $c_0 \in \{(1, 1), (-1, 2)\}$.

In summary, the following table gives the possible values of b_0, c_0 that we must consider, together with the corresponding values of d_0 forced by the condition that $a_0 + b_0 + c_0 + d_0 \equiv 0 \pmod{4\mathbb{Z}^2}$.

b_0	c_0	d_0
(1, 0)	(2, -1)	(1, 1)
(1, 0)	(1, 1)	(2, -1)
(-1, -1)	(2, -1)	(-1, 2)
(1, 1)	(2, -1)	(1, 0)
(2, -1)	(1, 1)	(1, 0)
(2, -1)	(-1, 2)	(-1, -1)

In each case, we find that $d_0 \in [-1, 2]^2 \cap J_{1/2}$, so that $d \in J_{1/2}$, as required. □

As an aside, this last result implies that there are two very different I-stable sets S with $\bar{\delta}(S) = 1/2$, namely $J_{1/2}$ and I_2 . This is quite far from the situation for B-stable and BI-stable sets, where the only stable sets that we know of which achieve the maximum value $\bar{\delta}(S) = 1/4$ are subsets of $2\mathbb{Z}^2$ (see Question 6.1).

Combining all of these results gives the following.

Corollary 4.10. *Let S be an I-stable set.*

- (a) *If S contains a unimodular triangle, then S contains a unimodular transformation of $J_{1/4}$.*
- (b) *If S properly contains $J_{1/4}$, then S contains a unimodular transformation of $J_{1/2}$.*
- (c) *If S properly contains $J_{1/2}$, then $S = \mathbb{Z}^2$.*

In particular, the only I-stable sets which contain a unimodular triangle are unimodular transformations of $J_{1/4}$, unimodular transformations of $J_{1/2}$, and \mathbb{Z}^2 .

Proof. Observe that $J_{1/4}$ and $J_{1/2}$ are I-stable by Propositions 4.8 and 4.9, respectively. By Lemma 4.5, any I-stable set containing a unimodular triangle contains a unimodular transformation of $J_{1/4}$.

We show that if S is an I-stable set containing both $J_{1/4}$ and also a point not in $J_{1/4}$, then S contains a unimodular transformation of $J_{1/2}$. Up to translation and reflection, we may assume that S contains some (x, y) with $0 \leq x \leq y \leq 3$ not in $J_{1/4}$, so there are 7 points to consider. We split these into three cases (see Figure 9).

Case I: S contains $(1, 3)$. If $(1, 3) \in S$, then S contains $\{(0, 4), (1, 3), (0, 5), (1, 4)\}$, which is the image of $\{(0, 0), (1, 0), (0, 1), (1, 1)\}$ under a unimodular transformation. This is the bottom left picture in Figure 9.

Case II: S contains $(1, 2)$, $(0, 2)$ or $(0, 3)$. If $(1, 2) \in S$, then since $(0, 1), (3, 3) \in S$, we have $(0, 2) \in S$. If $(0, 2) \in S$, then since $(1, 0), (-1, 3) \in S$, we have $(0, 3) \in S$. If $(0, 3) \in S$, then S contains $\{(-1, 3), (0, 3), (0, 4), (1, 4)\}$, which is the image of $\{(0, 0), (1, 0), (0, 1), (1, 1)\}$ under a unimodular transformation. This is the bottom middle picture in Figure 9.

Case III: S contains $(2, 3)$, $(2, 2)$, or $(1, 1)$. If $(2, 3) \in S$, then since $(0, 1), (3, 3) \in S$, we have $(2, 2) \in S$. If $(2, 2) \in S$, then since $(0, 1), (1, 0) \in S$, we have $(1, 1) \in S$. If $(1, 1) \in S$, then S contains $\{(0, 0), (1, 0), (0, 1), (1, 1)\}$. This is the bottom right picture in Figure 9.

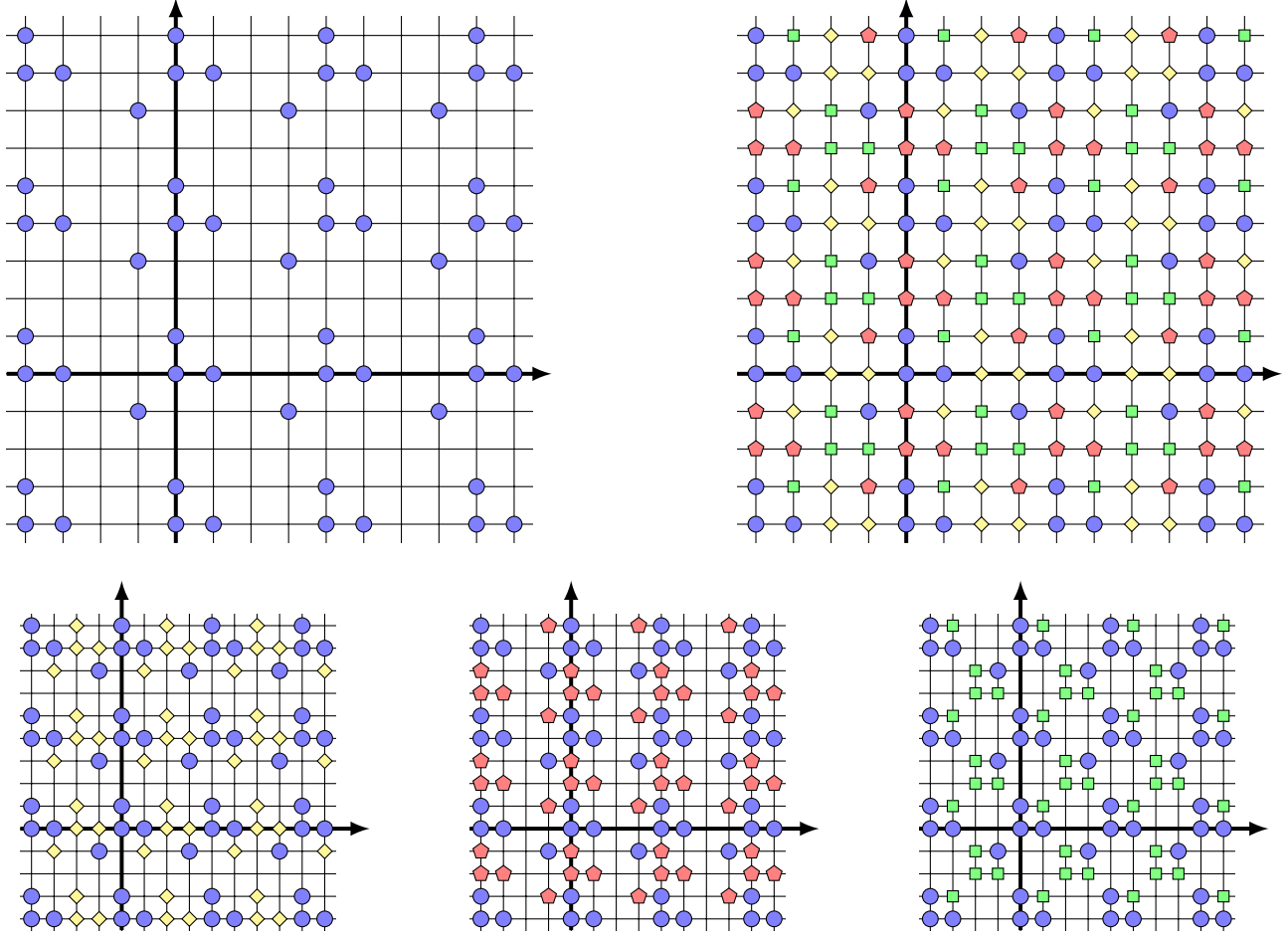

Figure 9: Adding a yellow diamond point to the top left picture will generate all yellow diamond points, given in the bottom left picture, and so on for each color/shape. Thus, the only proper I-stable supersets of $J_{1/4}$ are the three in the second row, which are unimodular transformations of $J_{1/2}$.

In any of these cases, S must contain a unimodular transformation of $J_{1/2}$ by Lemma 4.6.

Finally, we show that if S is an I-stable set containing $J_{1/2}$ and also some point not in $J_{1/2}$, then $S = \mathbb{Z}^2$. Up to translation and rotation, we may assume that $(2, 0) \in S$. Then

$$\begin{aligned}
 (1, 0), (2, -1), (2, 0) \in S &\implies (3, 1) \in S, \\
 (1, 0), (2, 2), (3, 1) \in S &\implies (2, 1) \in S, \\
 (2, -1), (4, 0), (3, 1) \in S &\implies (3, 0) \in S.
 \end{aligned}$$

Thus, since S contains $\{(2, 0), (3, 0), (2, 1), (3, 1)\}$, we have that S contains $J_{1/2} + (2, 0) = \mathbb{Z}^2 \setminus J_{1/2}$. We conclude that $S = \mathbb{Z}^2$ by Lemma 4.6. \square

We summarize these structural observations in the following corollary.

Corollary 4.11. *A set $S \subsetneq \mathbb{Z}^2$ is I-stable if and only if we have one of the following:*

- (a) S is a unimodular transformation of $J_{1/4}$;

(b) S is a unimodular transformation of $J_{1/2}$;

(c) S contains at most 2 points from every internal triangle.

Proof. By Proposition 4.8 and Proposition 4.9, S is I-stable in cases (a) and (b); case (c) is immediate.

Conversely, if $S \subsetneq \mathbb{Z}^2$ is I-stable and contains at least 3 points from an internal triangle, then S contains an internal triangle, and thereby contains a unimodular triangle. By Corollary 4.3, S is a unimodular transformation of $J_{1/4}$ or $J_{1/2}$. \square

We now prove our main density result for this section, which together with Corollary 4.3 completes the proof of Theorem 1.1(b). (We recall that (a) was proven in Section 3.)

Proposition 4.12. *If $S \subsetneq \mathbb{Z}^2$ is I-stable, then $\bar{\delta}(S) \leq 1/2$.*

Proof. By Corollary 4.10, if S contains a unimodular triangle then it is a unimodular transformation of $J_{1/4}$, $J_{1/2}$, or \mathbb{Z}^2 ; since $S \neq \mathbb{Z}^2$, we have $\bar{\delta}(S) \leq 1/2$. If S does not contain a unimodular triangle, then S intersects every 2×2 square in at most 2 points. Tiling \mathbb{Z}^2 by 2×2 squares, we have $\bar{\delta}(S) \leq 1/2$. \square

5 Maximal Stable sets

Up to this point we have established a number of structural results about stable sets. Corollary 3.2 states that every subset of a B-stable set $S \subsetneq \mathbb{Z}^2$ is B-stable and every subset of a BI-stable set $S \subseteq \mathbb{Z}^2$ is BI-stable. Similarly, from Corollary 4.11, every subset of an I-stable set S is I-stable, unless S is a unimodular transformation of $J_{1/4}$, $J_{1/2}$, or \mathbb{Z}^2 (see Figure 9). In view of this, classifying all stable sets is equivalent to classifying all *maximal stable sets*, that is, stable sets $S \subsetneq \mathbb{Z}^2$ such that S and \mathbb{Z}^2 are the only stable sets containing S . In this section we consider some constructions that are maximal stable and give some nonconstructive existence results.

We begin with I-stable sets. We recall that $I_n := \mathbb{Z} \times (n\mathbb{Z})$ is I-stable for every $n \neq 1, 3$ by Lemma 4.2.

Proposition 5.1. *Let $I_n := \mathbb{Z} \times (n\mathbb{Z})$. Then I_n is maximal I-stable if and only if either $n = 9$ or n is a prime number other than 3.*

Proof. If $n \geq 2$ is composite and not 9, then we can write $n = pq$ with $p \neq 1, 3$ and $q > 1$. As $I_{pq} \subseteq I_p$, we have that I_n is not a maximal I-stable set in this case. Also, I_3 is not I-stable (see Figure 11). It suffices to prove then that I_n is maximal I-stable for prime $n \neq 3$ and for $n = 9$.

Consider the set X consisting of I_n with an extra added point, which we may assume to be of the form $(0, a)$ with $1 \leq a \leq n - 1$ without loss of generality. We claim that the only I-stable set containing X is \mathbb{Z}^2 . Let us first assume $n \neq 3$ is a prime number. Since $\gcd(a, p) = 1$, there are integers $t_1, t_2 > 0$ such that $pt_1 - at_2 = 1$. Hence, the area of the triangle with vertices $(t_1, 0), (t_1 - t_2, p), (0, a)$ is

$$\frac{1}{2} \det \begin{bmatrix} -t_2 & p \\ -t_1 & a \end{bmatrix} = \frac{pt_1 - at_2}{2} = \frac{1}{2},$$

which implies that $\{(t_1, 0), (t_1 - t_2, p), (0, a)\}$ is a unimodular triangle with all vertices in X (see Figure 10). Because n is prime and thus not divisible by 4, every unimodular transformation

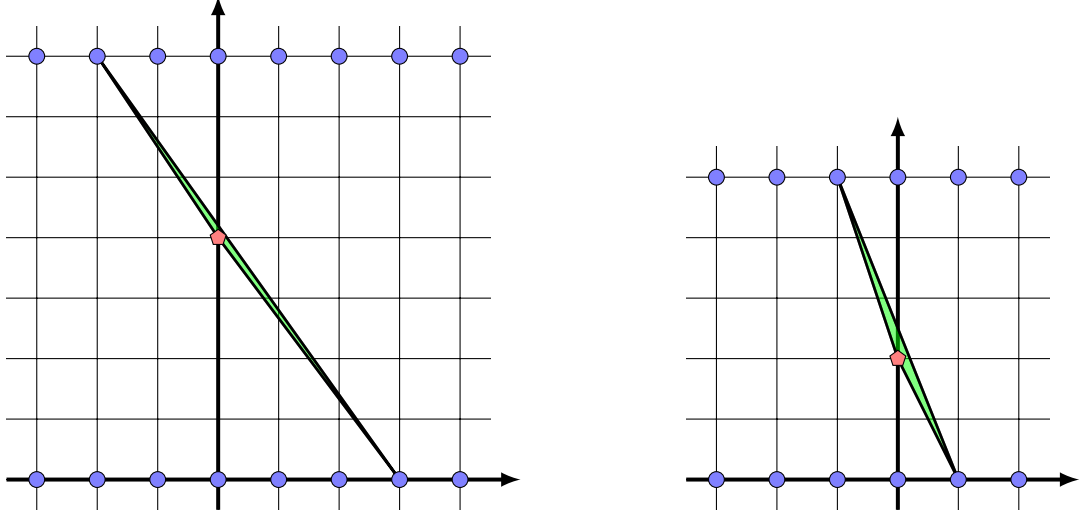

Figure 10: The sets $I_7 \cup \{(0, 4)\}$ and $I_5 \cup \{(0, 2)\}$ contain a unimodular triangle.

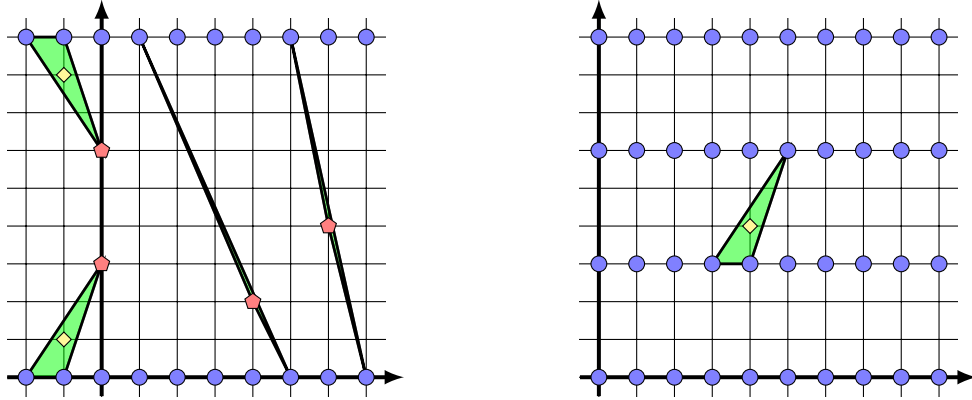

Figure 11: I_9 is maximal I-stable, but I_3 is not I-stable. The addition of the red pentagonal points to I_9 either creates a unimodular triangle or the three vertices of an internal triangle, which forces a unimodular triangle.

of $J_{1/4}$ and $J_{1/2}$ fails to contain I_n (see Figure 9 for the only unimodular transformation of $J_{1/4}$ and the two unimodular transformations of $J_{1/2}$ up to rotation and translation), we conclude by Corollary 4.10 that the only I-stable set containing X is \mathbb{Z}^2 .

Let us now assume $n = 9$. The previous argument yields the desired result whenever the additional point $(0, a)$ has $\gcd(a, 9) = 1$. If $a \in \{3, 6\}$, X contains 3 points of an internal triangle, which forces a unimodular triangle (see Figure 11), and we can conclude this case as before. \square

We recall $S_{2/9} := \{(0, 0), (1, 0)\} + 3\mathbb{Z}^2$ from Construction 2.3.

Proposition 5.2. *The set $S_{2/9}$ is maximal B-stable, maximal I-stable, and maximal BI-stable.*

Proof. By Proposition 2.4, we know that $S_{2/9}$ is BI-stable. Let X be the set obtained after adding one extra point to $S_{2/9}$. Then either X contains a unimodular triangle or has 5 points in a row. By Proposition 3.1, the only B-stable set containing X is \mathbb{Z}^2 . Therefore, $S_{2/9}$ is maximal B-stable and maximal BI-stable.

Furthermore, every I-stable set containing X also contains a unimodular triangle (see Figure 12). As every unimodular transformation of $J_{1/4}$ and $J_{1/2}$ fails to contain the set $S_{2/9}$ (see Figure 9 for the only unimodular transformation of $J_{1/4}$ and the two unimodular transformations of $J_{1/2}$ up to rotation and translation), we conclude by Corollary 4.10 that the only I-stable set containing X is \mathbb{Z}^2 . \square

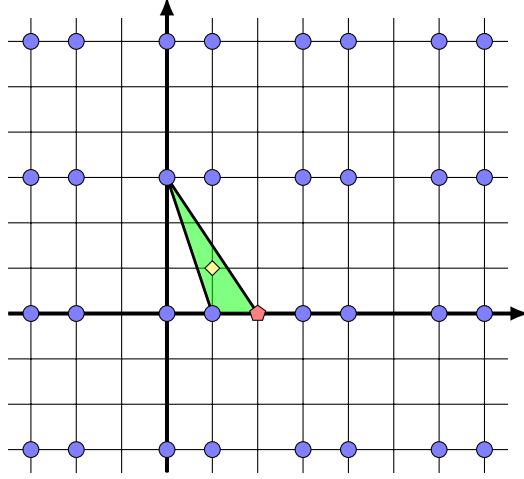

Figure 12: The set $S_{2/9}$ is a maximal I-stable set. The addition of the yellow diamond point creates a unimodular triangle, and the addition of the red pentagonal point forces such a yellow diamond point.

All of the constructions we considered in this paper are *periodic*, i.e. of the form $X + k\mathbb{Z}^2$ for some finite set X and positive integer k . Although we have not explicitly constructed a (maximal) aperiodic stable set, it follows from Zorn's Lemma that such sets must exist as well. For this, we need a simple lemma.

Proposition 5.3. *Let $S \subsetneq \mathbb{Z}^2$ be B/I/BI-stable. Then there exists a maximal B/I/BI-stable set (of the same stability type as S) that contains S .*

Proof. We give the proof for I-stable sets. The reasoning is nearly identical for B-stable and BI-stable sets.

Let Σ be the collection of all *proper* I-stable subsets of \mathbb{Z}^2 containing S . Then Σ is nonempty since $S \in \Sigma$. Let $\mathcal{C} \subseteq \Sigma$ be a chain with respect to inclusion, and let $\overline{S} = \bigcup_{T \in \mathcal{C}} T$.

We claim that \overline{S} is I-stable. Suppose it is not. Then there exist four distinct points $x_1, x_2, x_3, y \in \mathbb{Z}^2$ forming an internal triangle, with $x_1, x_2, x_3 \in \overline{S}$ and $y \notin \overline{S}$. For each $i = 1, 2, 3$, let $T_i \in \mathcal{C}$ contain x_i . Since \mathcal{C} is a chain, we may assume $T_1 \subseteq T_2 \subseteq T_3$ without loss of generality, which means that $x_1, x_2, x_3 \in T_3$. But y cannot be in T_3 since $y \notin \overline{S}$, contradicting I-stability of T_3 .

Next, we show that \overline{S} is a proper subset of \mathbb{Z}^2 . If not, then by the same reasoning as in the previous paragraph, some $T \in \mathcal{C}$ must contain every point in $[4]^2$. Since T is I-stable, we have that $T = \mathbb{Z}^2$ by Corollary 4.11 (or Proposition 3.1 for B-stable and BI-stable sets), contradicting that T is a proper subset of \mathbb{Z}^2 .

Thus, $\overline{S} \in \Sigma$ is an upper bound of \mathcal{C} . By Zorn's lemma, Σ contains a maximal element. \square

Now we can now give a nonconstructive proof that there exist maximal aperiodic stable sets.

Proposition 5.4. *There exists a maximal I-stable set $S \subseteq \mathbb{Z}^2$ that is not periodic.*

Proof. Let $S_0 = \{(x, 0) : x \geq 10\} \cup \{(0, y) : y \geq 10\}$. The set S_0 is I-stable since any triangle with vertices in S_0 has area at least 5. By Proposition 5.3, S_0 is contained in a maximal I-stable set S . Suppose that S is periodic. Then the intersection of S with the x -axis $\{(x, 0) : x \in \mathbb{Z}\}$ is periodic. Since the infinite ray $\{(x, 0) : x \in \mathbb{Z}, x \geq 10\}$ is in this periodic intersection, all of $\{(x, 0) : x \in \mathbb{Z}\}$ is S . Likewise, S contains the entire y -axis $\{(0, y) : y \in \mathbb{Z}\}$. Thus, S contains the three points $(0, 0), (-1, 0), (0, -1)$ and hence, by I-stability, $(1, 1) \in S$. Now $\{(0, 0), (1, 0), (0, 1), (1, 1)\} \subseteq S$, so by Lemma 4.6, S contains $J_{1/2}$. But $J_{1/2}$ is maximal I-stable by Corollary 4.10 and does not contain the set $\{(x, 0) : x \in \mathbb{Z}\} \cup \{(0, y) : y \in \mathbb{Z}\} \subseteq S$, which is a contradiction. Thus S is an aperiodic maximal I-stable set. \square

Proposition 5.5. *There exists a maximal B-stable set $S \subseteq \mathbb{Z}^2$ that is not periodic. There also exists a maximal BI-stable set $S \subseteq \mathbb{Z}^2$ that is not periodic.*

Proof. Let $X \subseteq \mathbb{Z}$ be any set of integers satisfying the following conditions:

- (1) X contains no three consecutive integers,
- (2) $X \cup \{x\}$ contains three consecutive integers for all $x \in \mathbb{Z} \setminus X$, and
- (3) X is not periodic.

Such a set can be constructed as follows. Let $0.b_1b_2 \dots$ be the binary expansion of any irrational number in $(0, 1)$. Define $x_0 := 1$ and iteratively $x_{i+1} := x_i + 2 + b_i$. Take $X' := \{x_i\}_{i \geq 0} \cup \{x_i + 1\}_{i: b_i=1}$ and set $X := X' \cup (-X')$. It is straightforward to check that this set has the desired properties.

Let $S_0 := X \times \{0\} \subseteq \mathbb{Z}^2$. By Condition (1), S_0 intersects each border triangle in at most two points, so it is a B-stable proper subset of \mathbb{Z}^2 . By Proposition 5.3, there exists some $S \supseteq S_0$ that is maximal B-stable. Observe that $S \cap (\mathbb{Z} \times \{0\}) = X$, as otherwise S would contain three consecutive integers by Condition (2), which by Proposition 3.1 would imply $S = \mathbb{Z}^2$. Finally, S is not periodic because X is not periodic by Condition (3).

For a maximal BI-stable set, we apply Proposition 5.3 to obtain $S \supseteq S_0$ that is maximal BI-stable, and the rest of the argument is unchanged. \square

6 Concluding Remarks and Maximal Stable Sets

In this paper we defined $S \subseteq \mathbb{Z}^2$ to be B/I/BI-stable if there exists no border/internal/minimal triangle (respectively) on four points that intersects S in exactly three points. There are many ways one could generalize these notions. When considering the number-theoretic motivation, work in \mathbb{Z}^2 is related to degree-3 number fields. To handle higher-degree fields, it is natural to consider a notion of stability with respect to minimal simplices in \mathbb{Z}^d . However, the classification of simplices in \mathbb{Z}^d containing $d + 2$ points is considerably more complicated when $d \geq 3$ than when $d = 2$. For example, there exist infinitely many tetrahedra in \mathbb{Z}^3 , not equivalent up to

unimodular transformation, containing exactly five points, including eight tetrahedra containing one interior point [1, Table 1].

As discussed in Section 5, understanding stable sets is equivalent to understanding maximal stable sets. As such, many of our open problems center around such sets. For example, we showed that any B-stable set $S \subsetneq \mathbb{Z}^2$ has $\bar{\delta}(S) \leq 1/4$, and that this is tight by considering $S = 2\mathbb{Z}^2$. The following asks if this is essentially the only such set with this property.

Question 6.1. *Does there exist a set $S \subsetneq \mathbb{Z}^2$ that is maximal B-stable with $\bar{\delta}(S) = 1/4$ and that is not equal to a unimodular transformation of $2\mathbb{Z}^2$?*

A negative answer to this question would also imply a negative answer to the analogous question for BI-stable sets. Here the condition that S be maximal is essential, as otherwise one can just consider $2\mathbb{Z}^2$ after deleting a point. A related question is the following.

Question 6.2. *What is the largest value of $\bar{\delta}(S)$ for B-stable $S \subsetneq \mathbb{Z}^2$ if S contains $(0, 0)$ and $(1, 0)$?*

The set $S_{2/9}$ shows that $\bar{\delta}(S) = 2/9$ is achievable, and Proposition 3.5 implies $\bar{\delta}(S) \leq 1/4$. If this latter bound were tight, then this would imply a positive answer to Question 6.1, and any proof showing $\bar{\delta}(S) = 1/4$ is not possible might give insight into proving that Question 6.1 has a negative answer.

It would be interesting if one could construct a stable set S with positive density that is not periodic.

Question 6.3. *Does there exist an aperiodic set $S \subseteq \mathbb{Z}^2$ with $\bar{\delta}(S) > 0$ that is maximal B/I/BI-stable?*

We note that if either $\bar{\delta}(S) = 0$ or S is periodic, then $\bar{\delta}(\varphi(S)) = \bar{\delta}(S)$ for any unimodular transformation φ . As such, a negative answer to this question would imply that $\bar{\delta}(S)$ is an “intrinsically geometric” property of maximal stable sets. The maximality condition in Question 6.3 is critical, as $2\mathbb{Z}^2$ minus a point trivially satisfies all of the other conditions. Similarly, Propositions 5.4 and 5.5 show that we can find such sets if one drops the requirement $\bar{\delta}(S) > 0$.

7 Acknowledgements

This work was started at the 2022 Graduate Research Workshop in Combinatorics, which was supported in part by NSF grant 1953985 and a generous award from the Combinatorics Foundation.

References

- [1] M. Blanco and F. Santos. Lattice 3-polytopes with few lattice points. *SIAM J. Discrete Math.*, 30(2):669–686, 2016. doi:10.1137/15M1014450.
- [2] V. Blomer and V. Kala. Number fields without n -ary universal quadratic forms. *Math. Proc. Cambridge Philos. Soc.*, 159(2):239–252, 2015. doi:10.1017/S030500411500033X.

- [3] H. Brunotte. Zur Zerlegung totalpositiver Zahlen in Ordnungen totalreeller algebraischer Zahlkörper. *Arch. Math. (Basel)*, 41(6):502–503, 1983. doi:10.1007/BF01198578.
- [4] T. Hejda and V. Kala. Additive structure of totally positive quadratic integers. *Manuscripta Math.*, 163(1-2):263–278, 2020. doi:10.1007/s00229-019-01143-8.
- [5] V. Kala and M. Tinková. Universal quadratic forms, small norms, and traces in families of number fields. *Int. Math. Res. Not.*, 2022. doi:10.1093/imrn/rnac073.
- [6] J. Krásenský, M. Tinková, and K. Zemková. There are no universal ternary quadratic forms over biquadratic fields. *Proc. Edinb. Math. Soc. (2)*, 63(3):861–912, 2020. doi:10.1017/s001309152000022x.

A Computer-assisted proofs

In this appendix, we discuss the Python code for a program that proves Lemma 3.4 and Lemma 3.8, and classifies the sets considered in Remark 3.9. This code can be found in the supplementary files. For a computer-free proof of Lemma 3.4, see Appendix B.

The code enumerates all B-stable subsets of a given set of points using a depth-first search. First we set up some helpful functions, including the main recursive step. Then we give the three applications. Lemma 3.4 states every B-stable set $S \subsetneq \mathbb{Z}^2$ has $|S \cap ([6] \times [6])| \leq 9$ and Remark 3.9 describes all B-stable sets $S \subseteq [6]^2$ with $\Gamma(S) \neq \emptyset$ and $|S| = 9$ up to rotation and reflection; the code completes this calculation in only a few seconds on a personal computer. Lemma 3.8 states that every B-stable set $S \subsetneq \mathbb{Z}^2$ with $\Gamma(S) \cap ([6] \times [12]) \neq \emptyset$ has $|S \cap ([6] \times [12])| \leq 16$; this takes longer to calculate, about 6 minutes on the same hardware.

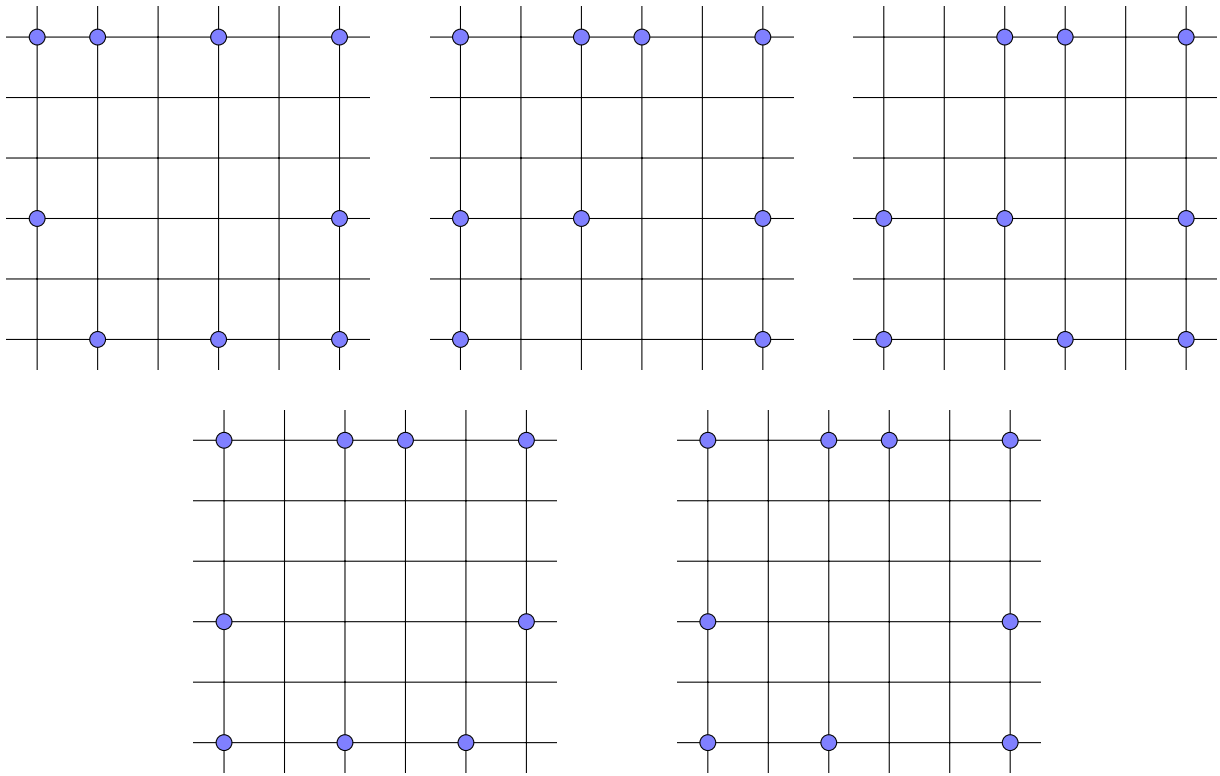

Figure 13: All B-stable sets $S \subseteq [6]^2$ with $\Gamma(S) \neq \emptyset$ and $|S| = 9$, up to reflection and rotation.

B Computer-free proof of Lemma 3.4

In this Appendix, we prove Lemma 3.4, namely that every B-stable set $S \subsetneq \mathbb{Z}^2$ intersects $[6]^2$ in at most 9 points, without computer aid. A proof along similar lines should be possible for Lemma 3.8, but we do not provide one here.

First, we show that it is enough to prove the following.

Lemma B.1. *Let $S \subsetneq \mathbb{Z}^2$ be a B-stable set. If $S \cap [6]^2$ contains a pair of points (x, y) and $(x + 1, y)$, then $|S \cap [6]^2| \leq 9$.*

Lemma B.2. *If $S \subsetneq \mathbb{Z}^2$ is B-stable, $S \cap [6]^2$ has no pair of points at distance 1 and $S \cap [6]^2$ contains two points at distance $\sqrt{2}$, then $|S \cap [6]^2| \leq 9$.*

Proof of Lemma 3.4. Assume that $S \subsetneq \mathbb{Z}^2$ is a B-stable set and $|S \cap [6]^2| > 9$. Then, by Lemma B.1 applied to S and a 90-degree rotation of S , we have that $S \cap [6]^2$ contains no pair of points at distance 1. Thus, by Lemma B.2, $S \cap [6]^2$ contains no pair of points at distance $\sqrt{2}$. This implies that every translate of $[2] \times [2]$ intersects S in at most one point, contradicting the fact that $|S \cap [6]^2| > 9$. \square

B.1 Proof of Lemma B.1

Let $T = S \cap [6]^2$. If such T contains a pair of horizontally consecutive points in the 2nd, 3rd, 4th, or 5th rows of $[6]^2$, then T contains at most 8 points (see Figure 14). We may assume this is not the case, and by symmetry that T also contains no pair of vertically consecutive points in the middle four columns.

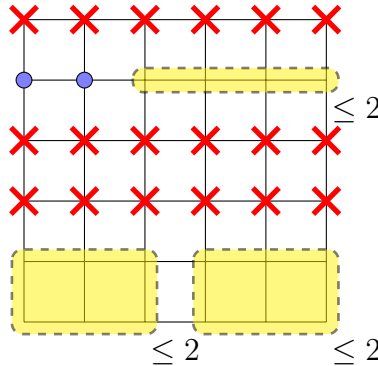

Figure 14: Possible sets in which $S \cap [6]^2$ contains a pair of points at distance 1 in the 2nd, 3rd, 4th, or 5th row. Points marked with a red X cannot be included in S , or else $S = \mathbb{Z}$.

Now without loss of generality, the top row of $[6]^2$ contains a consecutive pair from T . Then as we can see from Figure 15, T contains at most 4 points from row 6, no points from rows 5 and 4, and at most 6 points total from rows 1, 2, and 3, and hence $|T| \leq 10$. Thus either $|T| \leq 9$ already, or the top row must contain exactly 4 points of T , and in particular, we can assume without loss of generality that either $(1, 6), (2, 6) \in T, (5, 6), (6, 6) \in T$, or $(1, 6), (3, 6), (4, 6), (6, 6) \in T$.

We will break these into further cases depending on which 2 points appear in the ‘middle 2×3 window’ with coordinates $\{3, 4\} \times \{1, 2, 3\}$, see Figure 16 for all 15 possibilities.

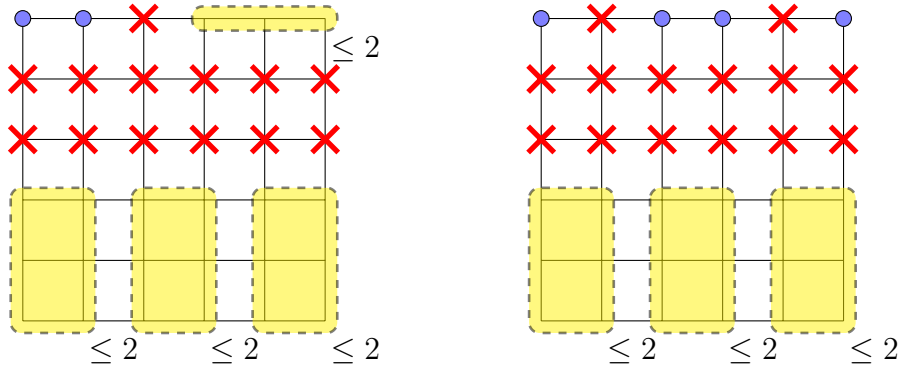

Figure 15: Possible sets with two points at distance 1 on the 1st row of a 6×6 window.

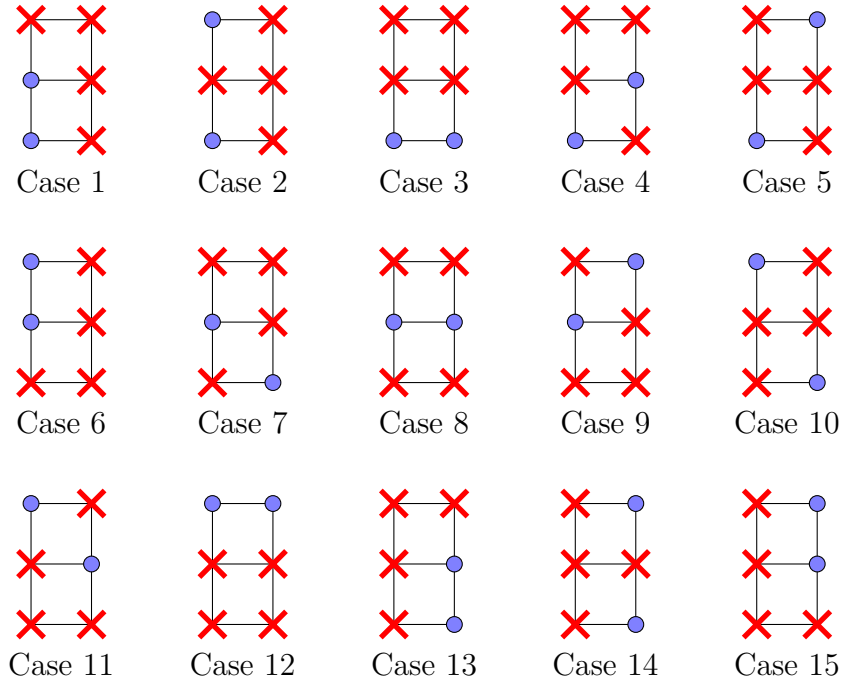

Figure 16: All possible configuration of 2 points in a 2×3 window.

From now on, we will refer to each possibility as the label included in Figure 16. By our assumption on consecutive points in middle rows and columns, we can immediately rule out cases 1, 6, 8, 12, 13, and 15. Moreover in case 3, regardless of the configuration in the top row, we can have at most 4 points in the last three rows for a total of at most 8.

The configuration $(1, 6), (3, 6), (4, 6), (6, 6) \in T$ is then relatively straightforward. In cases 5, 9, 10, and 11, T has three points of a unimodular triangle. In cases 2, 4, 7, and 14, T has three points of a border triangle.

Finally, we handle the configuration $(1, 6), (2, 6) \in T$, which by symmetry, covers the configuration $(5, 6), (6, 6) \in T$ as well. In cases 10 and 11, there are three points of a unimodular triangle. In cases 2 and 7, there are three points of a border triangle. We deal with the remaining cases of 4, 5, 9, and 14 in the following.

In cases 4, 5, and 9, we rule out new points that will create either unimodular or border

triangle with the points in T . A quick check shows that T has at most 9 points in these cases, as seen in the following.

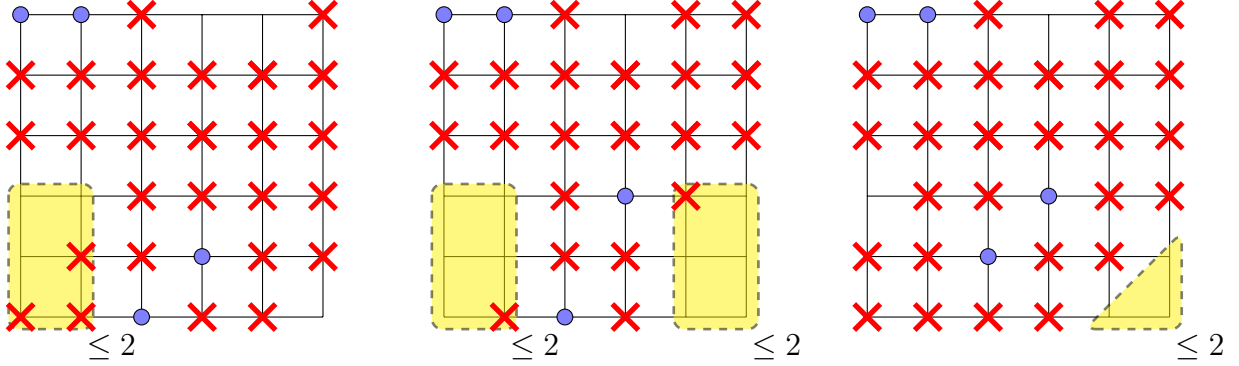

For case 14, we will need a slightly more detailed analysis. For this, we introduce a new labeling system in pictures that will help the case checking later on.

The points $(2, 6)$ and $(4, 3)$ are labeled 1 and 2 in the following figure. They form a border triangle with the bottom-right point $(6, 1)$, which forbids $(6, 1)$ from being in T . We notate this in the picture with a red 1, 2 label over that point. Further, the points $(4, 1)$ and $(4, 3)$ make it impossible to have both points $(6, 2)$ and $(6, 3)$ from the ‘right 2×3 window’ $\{5, 6\} \times [3]$. We conclude that there is at most one point from T in that 2×3 window. Thus we conclude that in this last case, as in all others, T has at most 9 points.

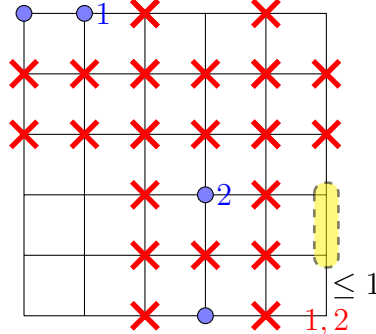

B.2 Proof of Lemma B.2

We now assume that S has no points at distance 1 but has points at distance $\sqrt{2}$.

Throughout this argument, in the grid $[k]^2$, the *main diagonal* is the set of k lattice points (x, y) for which $x - y = 0$; the *main antidiagonal* is the set of points for which $x + y = k$. Similarly, the d^{th} *diagonals* are the sets of $2(k - d)$ lattice points in $[k]$ with $x - y = \pm d$; and the d^{th} *antidiagonals* are the ones with $x + y = k \pm d$.

We will make use of the following Claim (see Figure 17).

Claim B.3. *If S has no points at distance 1, then an upper or lower triangular part of the grid $[k]^2$ can contain at most 3 points when $k = 3$, and at most 6 points when $k = 5$. The only configurations achieving equality are shown in Figure 18. Moreover, when $k = 4$, if we further assume there are no points at distance $\sqrt{2}$ on the main diagonal or antidiagonal, there are at most 3 points on such a triangular grid.*

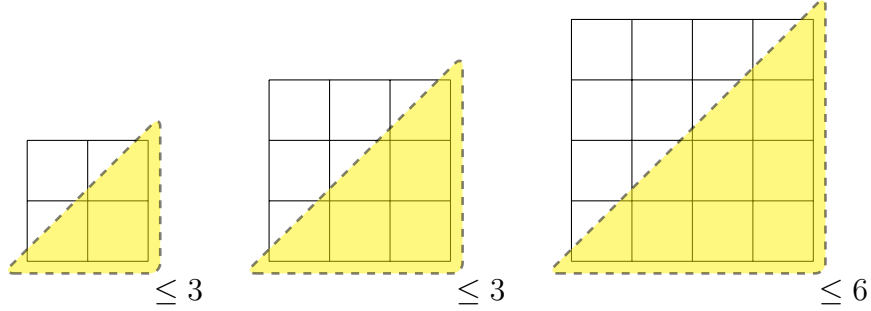

Figure 17: Claim B.3: The upper or lower triangular part of the grid $[k]^2$ can contain at most 3 points when $k = 3, 4$, and at most 6 points when $k = 5$. Moreover, for $k = 3$ and $k = 5$, the only configurations achieving equality are shown below.

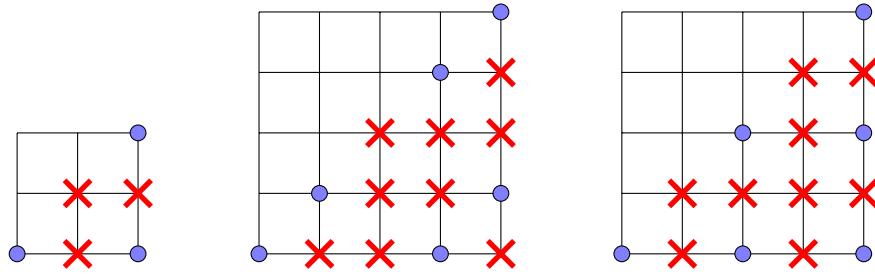

Figure 18: The “optimal” equality cases in Claim B.3.

Proof. In each of the cases, let $[k]_L = \{(x, y) \in \mathbb{Z}^2 : 1 \leq y \leq x \leq k\}$, and $T = S \cap [k]_L$. The proofs for the upper triangular part are immediate by symmetry.

For $k = 3$, note that $T \cap [2]_L$ either contains at most one point or is $\{(1, 1), (2, 2)\}$. Now condition on the number t_3 of points in the last column, which is at most 2 because of the distance 1 restriction. If $t_3 = 0$, then clearly $|T| \leq 2$. If $t_3 = 1$, then regardless of which point of the last column is in T , it forms three points of a border triangle with $(1, 1)$ and $(2, 2)$, and hence $|T| \leq 2$. Finally, if $t_3 = 2$, then the second column must be empty and so either the $(1, 1)$ is not in T and $|T| = 2$, or it is, in which case we have the first $k = 3$ case in Figure 18.

For $k = 4$, we break $[4]_L$ into the last column and $[3]_L$. We condition on the number t_4 of points of T in the last column, which is at most 2 because of the distance 1 restriction. If $t_4 = 0$ then all points of T are in $[3]_L$, so as before $|T| \leq 3$. If $t_4 = 1$ then there can be at most one point of T in the third column, and the extra non-diagonal assumption in this $k = 4$ case implies that there is at most one point of T in $[2]_L$, for a total of $|T| \leq 3$. Finally, if $t_4 = 2$ then we conclude as in Figure 19:

For $k = 5$, we cover $[5]_L$ by three pieces: the triangle $[3]_L$, the “top triangle” and “the square”:

We condition on the number of points t_s in the square, which is at most 2 because of the distance 1 condition. The cases $t_s = 0$ and $t_s = 1$ can be handled simultaneously. In both, $|T| \leq 5$ unless one triangle has 3 points of T and the other has at least 2 points of T distinct from the first triangle. Without loss of generality, suppose $T \cap [3]_L$ has 3 points; this implies it must have the optimal $k = 3$ configuration, and hence $(3, 3) \in T$. But then the top triangle must have two additional points of T , that is, three points of T as well, yielding the same

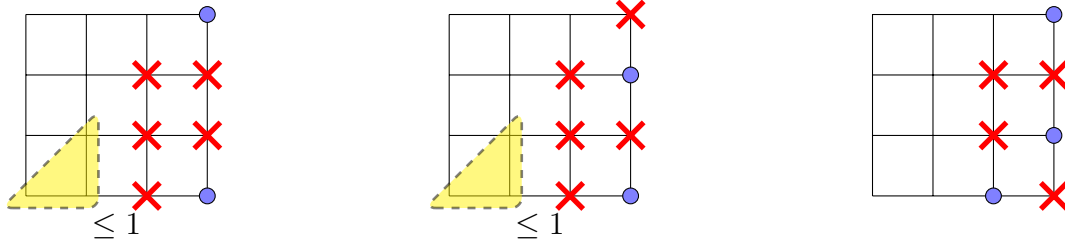

Figure 19: The three possible locations of two points in the last column. In the first two cases, the entire third column is forbidden by the distance 1 and non-diagonal assumptions, so there is only at most one other point in T . In the last case, the same argument holds unless $(3, 1) \in T$, but then each point in $[2]_L$ is forbidden because of triangles they form with it and $(4, 2)$.

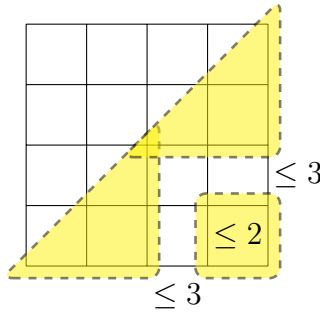

Figure 20: Covering $[5]_L$ by two triangles and a square. Note that both triangles have at most 3 points by the $k = 3$ case above, and the point $(3, 3)$ is in both triangles.

configuration. One then easily checks that the only point of the square which can be in T is $(5, 1)$, and including it yields the second $k = 5$ case in Figure 18.

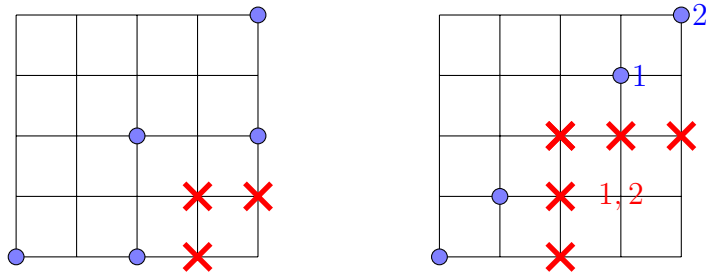

Figure 21: When $t_s < 2$, then there are enough points in T only if both triangles must have the optimal $k = 3$ configuration. When $t_s = 2$, the third row and columns have no points of T . In either case, one of the optimal $k = 5$ configurations is achieved.

Finally, suppose that $t_s = 2$. Any pair of two points of the square being in T forbids the four points adjacent to the square. In particular, this forbids the optimal $k = 3$ configuration in either triangle, and so both have at most 2 points of T . Thus, $|T| \leq 5$ unless both have exactly 2 points of T , neither of which is $(3, 3)$. This implies that the third column has no points in T , which means that $T \cap [2]_L = \{(1, 1), (2, 2)\}$ as previously noted. Analogously, the two points of T in the upper triangle are forced to be $(4, 4)$ and $(5, 5)$. Finally, these two points

form a unimodular triangle with $(4, 2)$, which fixes the pair of points of T in the square, and in particular yields the first $k = 5$ case in Figure 18. \square

This claim for $k = 3$ and $k = 5$, together with its equality cases (Figure 18) deal with the cases when there are points at distance $\sqrt{2}$ on the main diagonal or a second diagonal (see Figures 22 and 23).

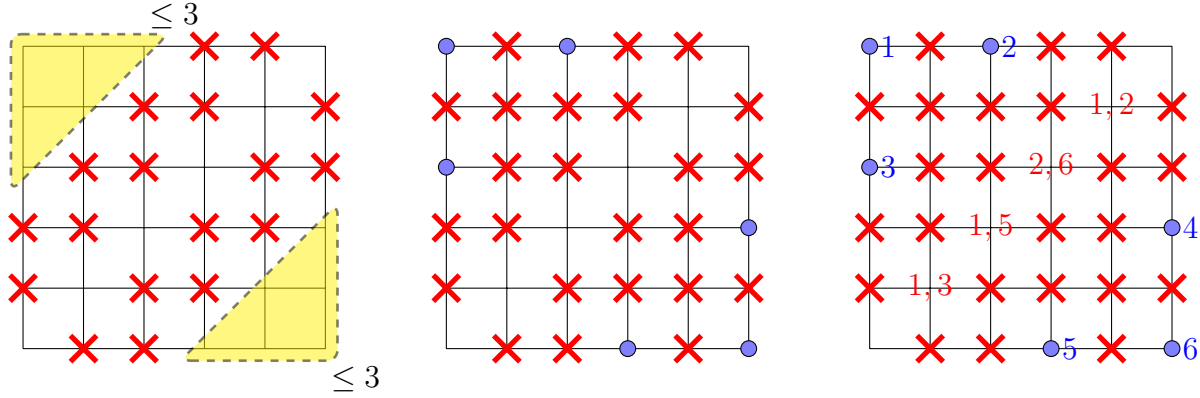

Figure 22: There are two points in T at distance $\sqrt{2}$ on the main diagonal. We apply the equality case for $k = 3$ in Claim B.3 to conclude T has at most 9 points.

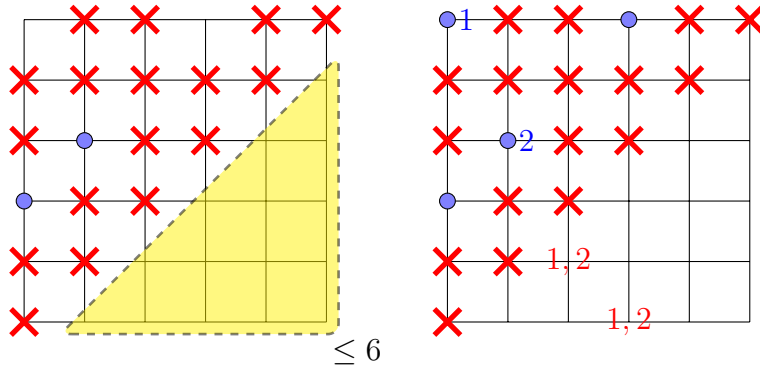

Figure 23: There are two points in T at distance $\sqrt{2}$ on a second diagonal. We apply the equality case for $k = 5$ in Claim B.3 to conclude T has at most 9 points.

Now, we assume there are no points at distance $\sqrt{2}$ either on the main diagonal or a second diagonal. The latter assumption allows us to use of the claim for $k = 4$ when there are points at distance $\sqrt{2}$ on a first diagonal (see Figure 24) or a third diagonal (see Figure 25).

We now make the following observation: the above cases show that T cannot have more than 9 points unless the only points at distance $\sqrt{2}$ are those of either a fourth diagonal or fourth antidiagonal. Without loss of generality, let T contain the two points of the upper fourth diagonal.

Suppose also that T does not contain the two points of the lower fourth diagonal. We partition the grid as in Figure 26 and observe that if $|T| > 9$ then each of the six windows must contain the maximum number of points. But there are only two ways to include 2 points in the ‘left 2×3 window’ avoiding distance 1 or $\sqrt{2}$ on a lower diagonal; neither yields enough points.

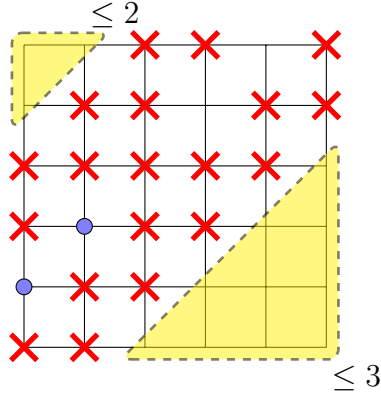

Figure 24: There are two points in T at distance $\sqrt{2}$ on a first diagonal. We apply the $k = 4$ case of Claim B.3 to conclude T has at most 9 points.

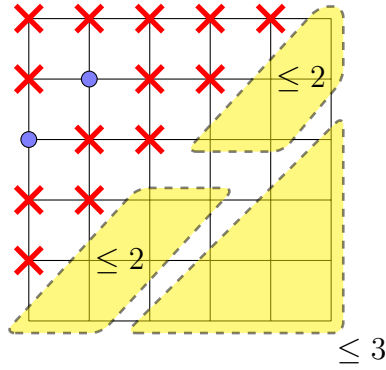

Figure 25: There are two points in T at distance $\sqrt{2}$ on a third diagonal. We make use of skewed 2×3 windows and the $k = 4$ case of Claim B.3 to conclude T has at most 9 points.

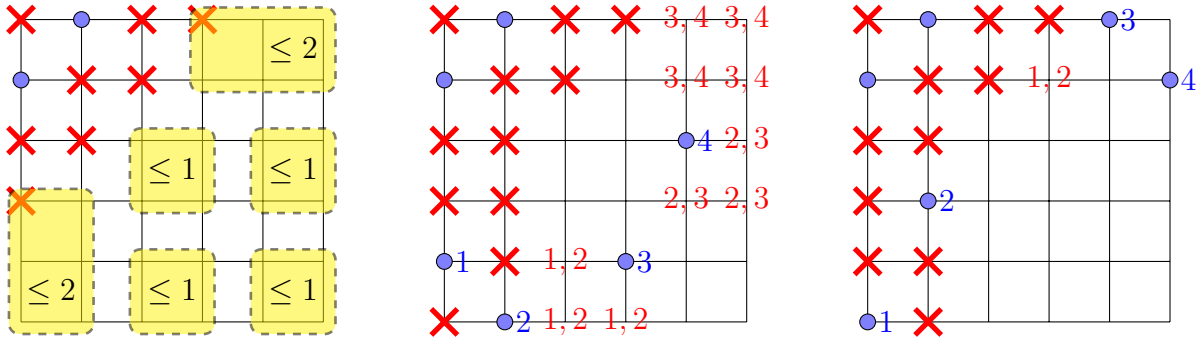

Figure 26: In the first case, we conclude there cannot be 2 points in the top 3×2 window. The second case forces 3 and 4 to be in T and so it is analogous to the first case by symmetry.

Thus, the last remaining case is when T contains both fourth diagonals, in which case $|T| > 9$ can be achieved only if at most one point missing; that is, one of the five remaining windows can have one fewer than its maximum number of points.

Using the notation from Figure 27, at least one of points 1 and 2 are in T ; by symmetry,

we may say that point 1 is in T . Then the top 3×2 window contains at most one point, and $|T| > 9$ only if both 2 and 4 are in T . If 2 is in T , then there is at most one point in both rectangular corner windows. We conclude $|T| \leq 9$.

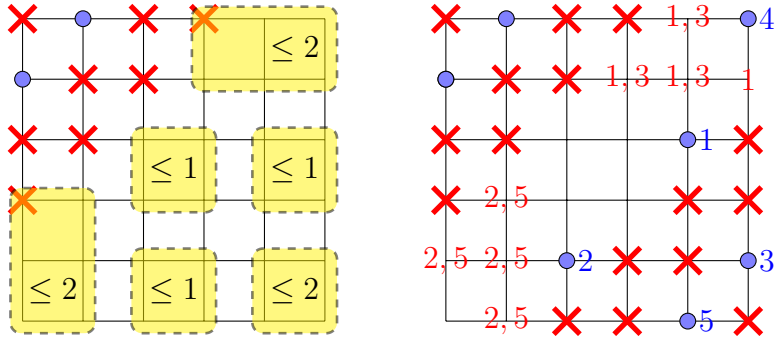

Figure 27: Without loss of generality, point 1 is in T . But then both the points 2 and 4 must also be in T , and $|T| \leq 9$.

We thus conclude that $|T| \leq 9$ if it has any consecutive points in any diagonal of $[6]$, as desired.